

SV9000 AF DRIVES
SVReady™ User Manual

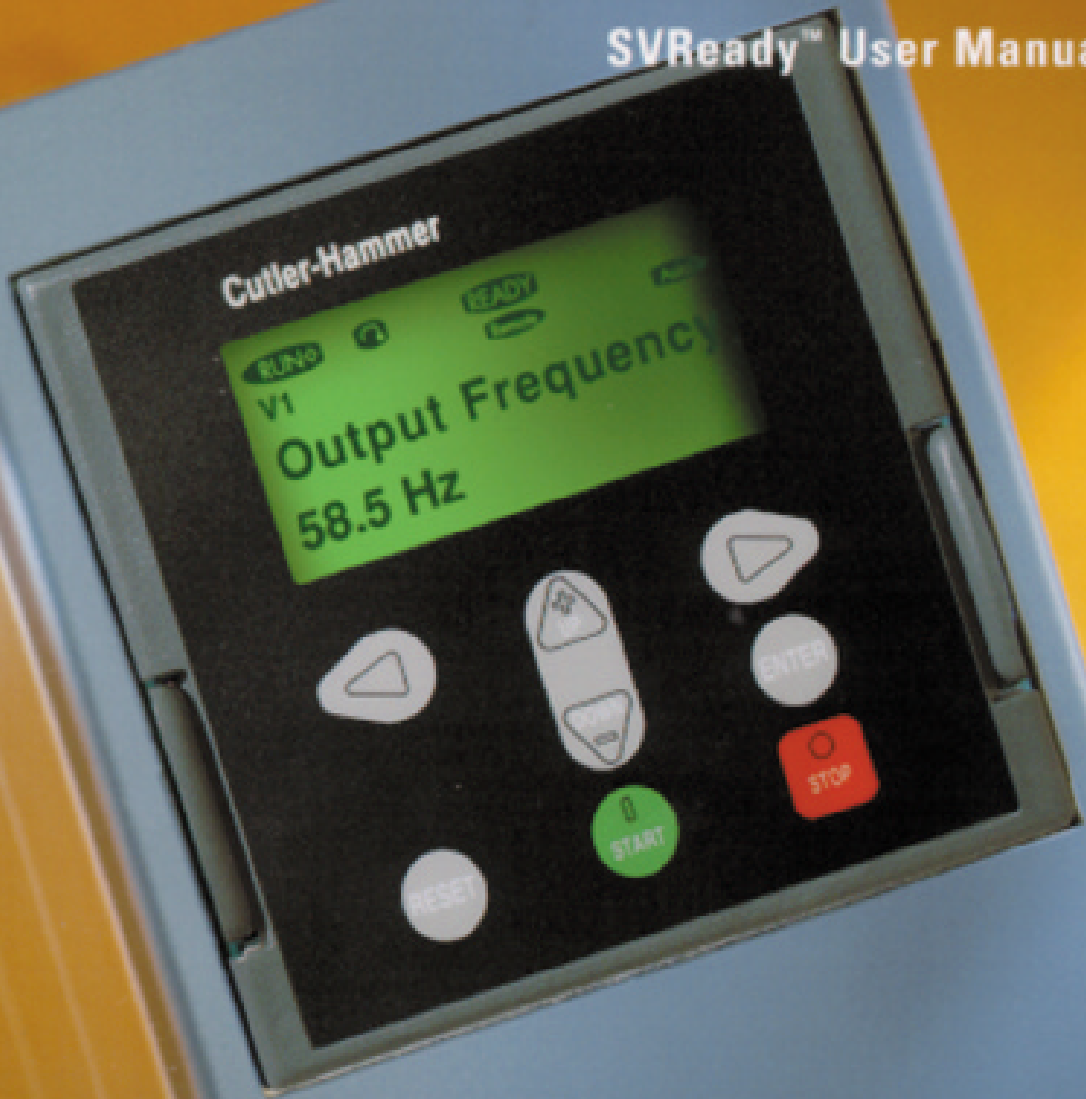

Cutler-Hammer

EAT•N

SV9000 SVReady USER MANUAL

CONTENTS

A General.....0-2

B Application selection0-2

C Restoring default values of application parameters0-2

D Language selection0-2

1 Standard Control Application 1-1

2 Local/Remote Control Application 2-1

3 Multi-step Speed Application 3-1

4 PI-control Application4-1

5 Multi-purpose Application5-1

6 Pump and fan control Application ..6-1

OPEN SV9000 USER MANUAL



A General

This manual provides you with the information needed to apply these applications.

Each application is described in its own chapter. Section B tells how to select the application.

B Application selection

If the Basic Application is in use, first open the application package lock (parameter 1.15 = 0) Group 0 appears. By changing the value of parameter 0.1 a different application can be selected. See table B-1.

To change from one application to another, simply change the value of parameter 0.1 to that of the application desired: see table B-1.

Number	Parameter	Range	Description
0. 1	Application	1 —7	1 = Basic Application 2 = Standard Application 3 = Local / Remote Control Application 4 = Multi-step Speed Application 5 = PI-control Application 6 = Multi-purpose Control Application 7 = Pump and Fan Control Application

Table B-1 Application selection parameters.

Besides the parameter group 1, the applications also have parameter groups 2 — 8 available (see figure B-1).

Parameters of the groups sequentially follow each other and changing from the last parameter of one group to the first parameter of the next group or vice versa is done simply by pushing the arrow up/arrow down buttons.

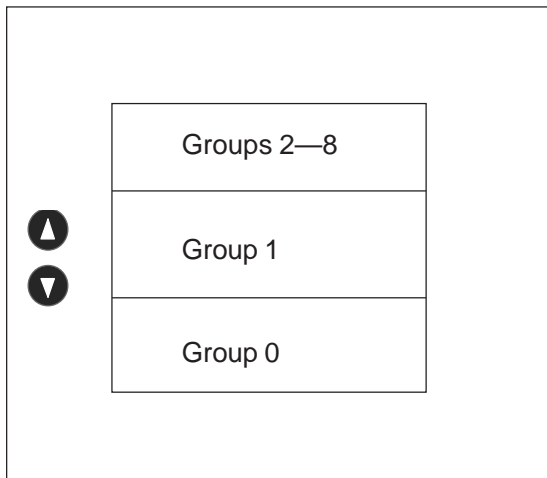

Figure B-1 Parameter Groups.

C Restoring default values of application parameters

Default values of the parameters of the applications 1 to 7 can be restored by selecting the same application again with parameter 0.1 or by setting the value of parameter 0.2 to 1. See User's manual chapter 12.

If parameter group 0 is not visible, make it visible as follows:

1. If parameter lock is set on, open the lock, parameter 1. 16, by setting the value of the parameter to 0.
2. If parameter conceal is set on, open the conceal parameter 1. 15, by setting the value of the parameter to 0. Group 0 becomes visible.

D Language selection

The language of the text shown on the operator's panel can be chosen with parameter 0. 3. See SV9000 User's Manual, chapter 11.



STANDARD CONTROL APPLICATION

(par. 0.1 = 2)

CONTENTS

1 Standard Application	1-1
1.1 General	1-2
1.2 Control I/O	1-2
1.3 Control signal logic	1-3
1.4 Parameters Group 1	1-4
1.4.1 Parameter table	1-4
1.4.2 Description of Group1 par ...	1-5
1.5 Special parameters, Groups 2-8 ..	1-8
1.5.1 Parameter tables	1-8
1.5.2 Description of Groups.	1-12



1

1 STANDARD APPLICATION

1.1 General

The Standard application has the same I/O signals and same Control logic as the Basic application. Digital input DIA3 and all outputs are programmable.

The Standard Application can be selected by

setting the value of parameter 0. 1 to 2. Basic connections of inputs and outputs are shown in the figure 1.2-1. The control signal logic is shown in the figure 1.3-1. Programming of I/O terminals is explained in chapter 1.5.

*** NOTE!** Remember to connect the CMA and CMB inputs.

1.2 Control I/O

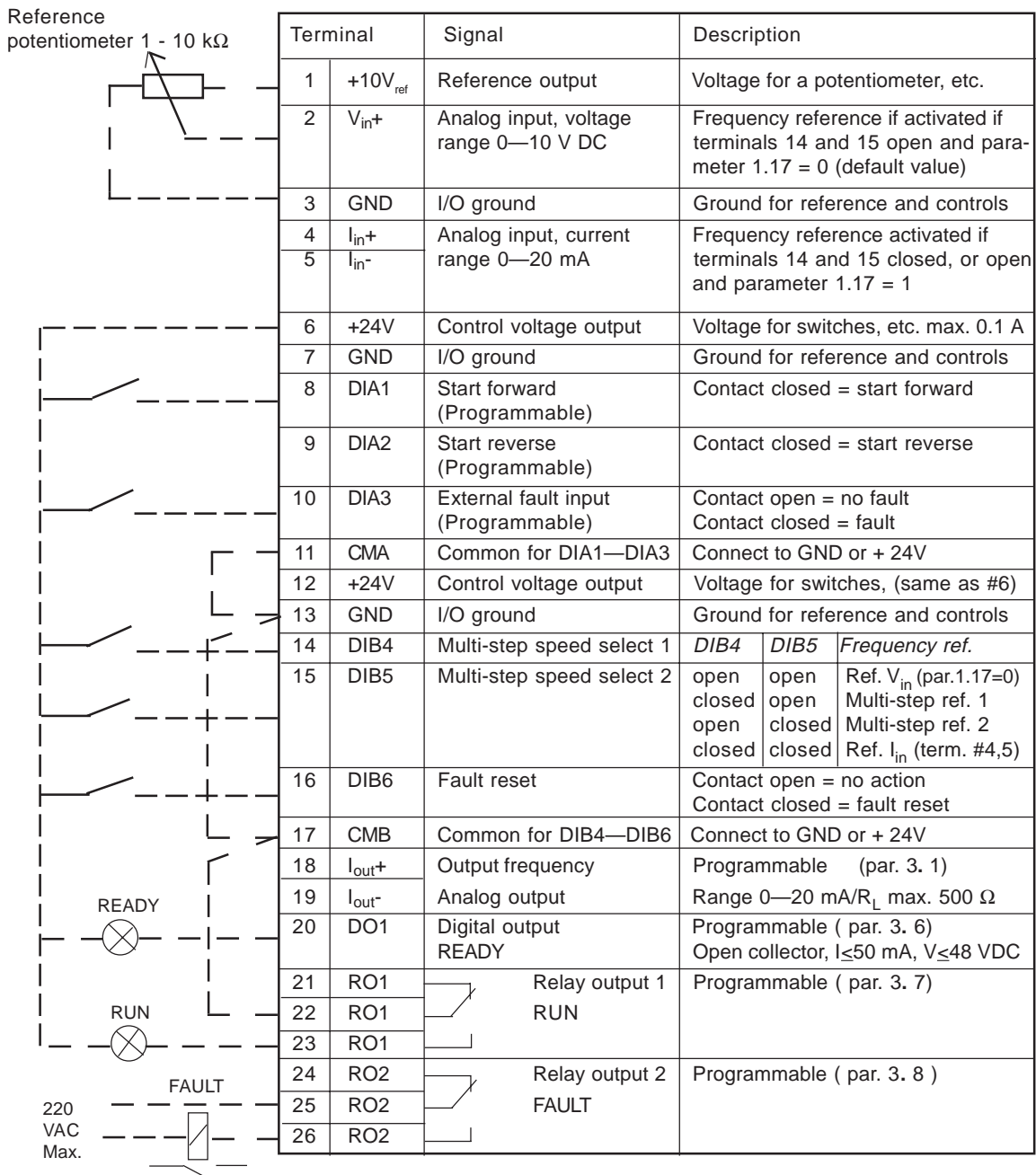

Figure 1.2-1 Default I/O configuration and connection example of the Standard Application.



1.3 Control signal logic

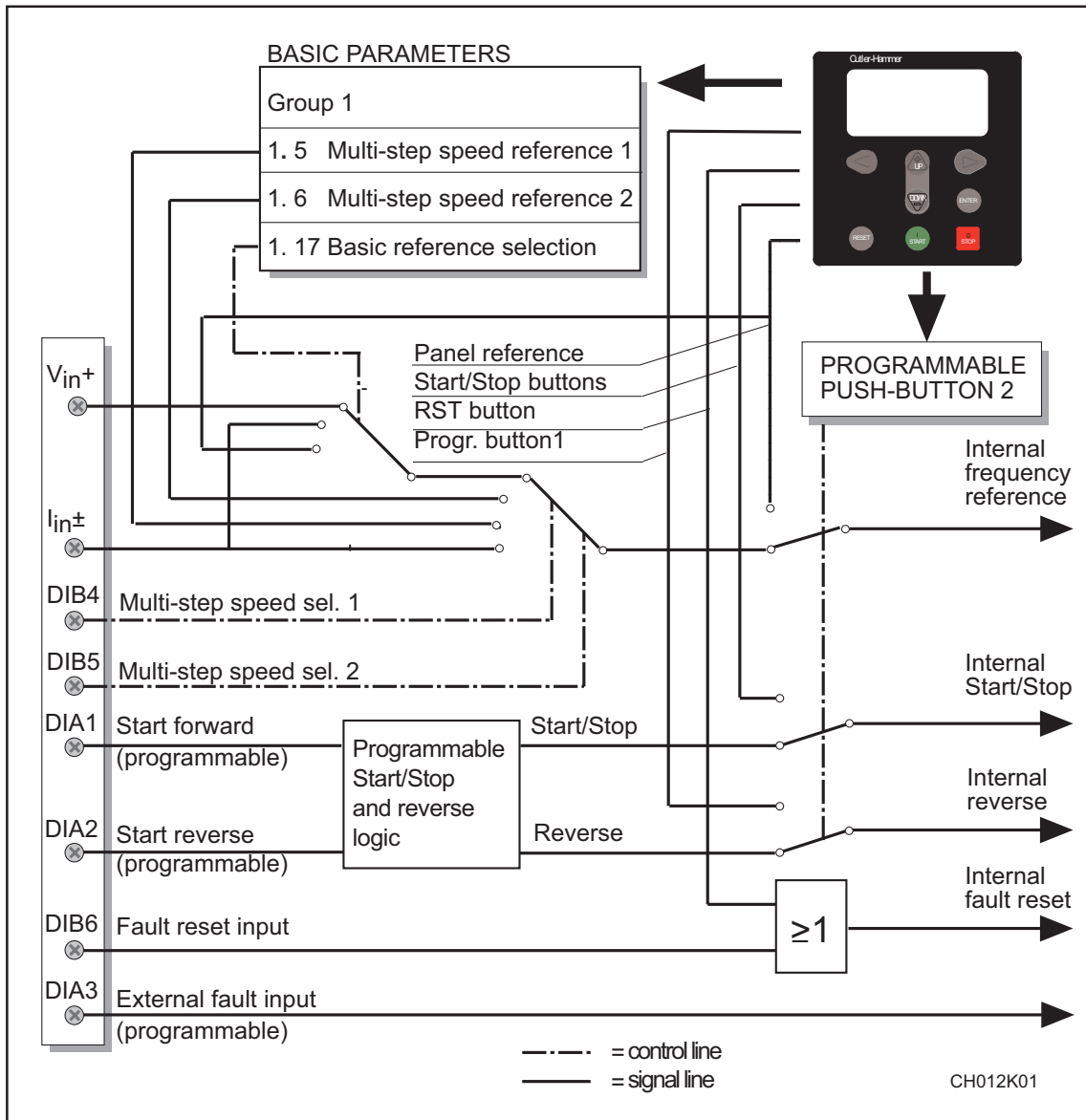

Figure 1.3-1 Control signal logic of the Standard Application.



1

1.4 PARAMETERS, GROUP 1

1.4.1 Parameter table

Code	Parameter	Range	Step	Default	Custom	Description	Page
1.1	Minimum frequency	0— f_{max}	1 Hz	0 Hz			1-5
1.2	Maximum frequency	f_{min} -120/500 Hz	1 Hz	60 Hz		*	1-5
1.3	Acceleration time 1	0.1—3000.0 s	0.1 s	3,0 s		Time from f_{min} (1. 1) to f_{max} (1. 2)	1-5
1.4	Deceleration time 1	0.1—3000.0 s	0.1 s	3.0 s		Time from f_{max} (1. 2) to f_{min} (1. 1)	1-5
1.5	Multi-step speed reference 1	f_{min} — f_{max}	0.1 Hz	10.0 Hz			1-5
1.6	Multi-step speed reference 2	f_{min} — f_{max}	0.1 Hz	60.0 Hz			1-5
1.7	Current limit	0.1—2.5 x I_{nSV9}	0.1 A	1.5 x I_{nSV9}		Output current limit [A] of the unit	1-5
1.8	V/Hz ratio selection	0—2	1	0		0 = Linear 1 = Squared 2 = Programmable V/Hz ratio	1-5
1.9	V/Hz optimization	0—1	1	0		0 = None 1 = Automatic torque boost	1-6
1.10	Nominal voltage of the motor	180—690 V	1 V	230 V 380 V 480 V 575 V		Voltage code 2 Voltage code 4 Voltage code 5 Voltage code 6	1-7
1.11	Nominal frequency of the motor	30—500 Hz	1 Hz	60 Hz		f_n from the nameplate of the motor	1-7
1.12	Nominal speed of the motor	1—20000 rpm	1 rpm	1720 rpm**		n_n from the nameplate of the motor	1-7
1.13	Nominal current of the motor	2.5 x I_{nSV9}	0.1 A	I_{nSV9}		I_n from the nameplate of the motor	1-7
1.14	Supply voltage	208—240 380—440 380—500 525—690		230 V 380 V 480 V 575 V		Voltage code 2 Voltage code 4 Voltage code 5 Voltage code 6	1-7
1.15	Parameter conceal	0—1	1	0		Visibility of the parameters: 0 = all parameter groups visible 1 = only group 1 is visible	1-7
1.16	Parameter value lock	0—1	1	0		Disables parameter changes: 0 = changes enabled 1 = changes disabled	1-7
1.17	Basic frequency reference selection	0—2	1	0		0 = analog input V_n 1 = analog input I_n 2 = reference from the panel	1-7

Table 1.4-1 Group 1 basic parameters.

Note!  = Parameter value can be changed only when the drive is stopped.

* If 1. 2 > motor synchr. speed, check suitability for motor and drive system.
Selecting 120 Hz/500 Hz range see page 1-5.

** Default value for a four pole motor and a nominal size drive.



1.4.2 Description of Group 1 parameters

1. 1, 1. 2 Minimum/maximum frequency

Defines the frequency limits of the drive.

The default maximum value for parameters 1. 1 and 1. 2 is 120 Hz. By setting the value of the parameter 1. 2 to 120 Hz when the drive is stopped (RUN indicator not lit) parameters 1. 1 and 1. 2 are changed to 500 Hz. At the same time the resolution of the display panel is changed from 0.01 Hz to 0.1 Hz.

Changing the max. value from 500 Hz to 120 Hz is done by setting parameter 1. 2 to 119 Hz while the drive is stopped.

1. 3, 1. 4 Acceleration time1, deceleration time 1:

These limits correspond to the time required for the output frequency to accelerate from the set minimum frequency (par. 1. 1) to the set maximum frequency (par. 1. 2).

1. 5, 1. 6 Multi-step speed reference 1, Multi-step speed reference 2:

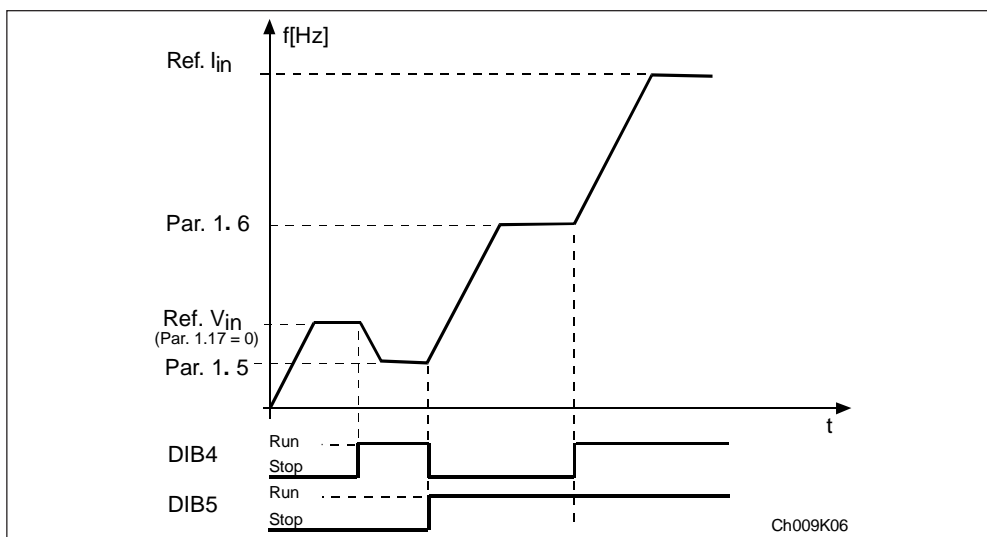

Figure 1.4-1 Example of Multi-step speed references.

Parameter values are automatically limited between minimum and maximum frequency (par 1. 1, 1. 2).

1. 7 Current limit

This parameter determines the maximum motor current that the SV9000 will provide short term.

1. 8 V/Hz ratio selection

Linear: The voltage of the motor changes linearly with the frequency in the constant flux area from 0 Hz to the field weakening point (par. 6. 3) where a constant voltage (nominal value) is supplied to the motor. See figure 1.4-2.

0

A linear V/Hz ratio should be used in constant torque applications.
This default setting should be used if there is no special requirement for another setting.



1

Squared: The voltage of the motor changes following a squared curve form with the frequency in the area from 0 Hz to the field weakening point (par. 6. 3) where the nominal voltage is also supplied to the motor. See figure 1.4-2.

1

The motor runs undermagnetized below the field weakening point and produces less torque and electromechanical noise. A squared V/Hz ratio can be used in applications where the torque demand of the load is proportional to the square of the speed, e.g. in centrifugal fans and pumps.

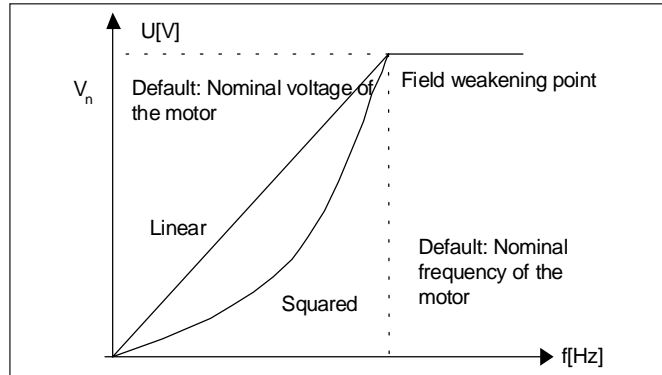
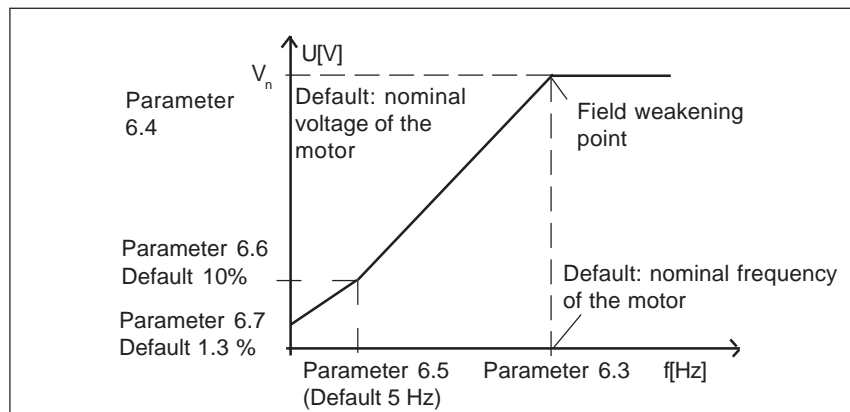

Figure 1.4-2 Linear and squared V/Hz curves.

Programm. The V/Hz curve can be programmed with three different points.
V/Hz curve The parameters for programming are explained in chapter 1.5.2.
A programmable V/Hz curve can be used if the standard settings



2 do not satisfy the needs of the application. See figure 1.4-3.

Figure 1.4-3 Programmable V/Hz curve.

1.9 V/Hz optimization

Automatic torque The voltage to the motor changes automatically which allows the motor to produce enough torque to start and run at low frequencies. The boost voltage increase depends on the motor type and horsepower. Automatic torque boost can be used in applications where starting torque due to starting friction is high, e.g. in conveyors.



NOTE!

In high torque - low speed applications - it is likely that the motor will overheat.

If the motor has to run for a prolonged time under these conditions, special attention must be paid to cooling the motor. Use external cooling for the motor if the operating temperature rise is too high.

1. 10 Nominal voltage of the motor

Find this value from the nameplate of the motor.

This parameter sets the voltage at the field weakening point, parameter 6. 4, to 100% $\times V_{n\text{motor}}$.

Note! If the nominal motor voltage is lower than the supply voltage, check that the insulation level of the motor is adequate.

1. 11 Nominal frequency of the motor

Find the nominal frequency f_n from the nameplate of the motor.

This parameter sets the field weakening point, parameter 6. 3, to the same value.

1. 12 Nominal speed of the motor

Find this value n_n from the nameplate of the motor.

1. 13 Nominal current of the motor

Find the value I_n from the nameplate of the motor.

The internal motor protection function uses this value as a reference value.

1. 14 Supply voltage

Set parameter value according to the nominal voltage of the supply.

Values are predefined for voltage codes 2, 4, 5, and 6. See table 1.4-1.

1. 15 Parameter conceal

Defines which parameter groups are available:

0 = all groups are visible

1 = only group 1 is visible

1. 16 Parameter value lock

Permits access for changing the parameter values:

0 = parameter value changes enabled

1 = parameter value changes disabled

1. 17 Basic frequency reference selection

0 = Analog voltage reference from terminals 2—3, e.g. a potentiometer

1 = Analog current reference from terminals 4—5, e.g. a transducer.

2 = Panel reference is the reference set from the Reference Page (REF), see chapter 7.5.





1

1.5 SPECIAL PARAMETERS, GROUPS 2—8

1.5.1 Parameter tables

Group 2, Input signal parameters

Code	Parameter	Range	Step	Default	Custom	Description	Page										
2.1	Start/Stop logic selection 	0—3	1	0		<table border="1"> <thead> <tr> <th>DIA1</th> <th>DIA2</th> </tr> </thead> <tbody> <tr> <td>0 = Start forward</td> <td>Start reverse</td> </tr> <tr> <td>1 = Start/Stop</td> <td>Reverse</td> </tr> <tr> <td>2 = Start/Stop</td> <td>Run enable</td> </tr> <tr> <td>3 = Start pulse</td> <td>Stop pulse</td> </tr> </tbody> </table>	DIA1	DIA2	0 = Start forward	Start reverse	1 = Start/Stop	Reverse	2 = Start/Stop	Run enable	3 = Start pulse	Stop pulse	1-12
DIA1	DIA2																
0 = Start forward	Start reverse																
1 = Start/Stop	Reverse																
2 = Start/Stop	Run enable																
3 = Start pulse	Stop pulse																
2.2	DIA3 function (terminal 10) 	0—5	1	1		0 = Not used 1 = Ext. fault, closing contact 2 = External fault, opening contact 3 = Run enable 4 = Acc./dec. time selection 5 = Reverse (if par. 2. 1 = 3)	1-13										
2.3	Reference offset for current input	0—1	1	0		0 = 0—20 mA 1 = 4—20 mA	1-13										
2.4	Reference scaling, minimum value	0—par. 2.5	1 Hz	0 Hz		Selects the frequency that corresponds to the minimum reference signal	1-13										
2.5	Reference scaling, maximum value	0— f_{max}	1 Hz	0 Hz		Selects the frequency that corresponds to the maximum reference signal 0 = Scaling off >0 = Maximum frequency value	1-13										
2.6	Reference invert	0—1	1	0		0 = No inversion 1 = Reference inverted	1-14										
2.7	Reference filter time	0.00—10.00s	0.01s	0.10s		0 = No filtering	1-14										



Group 3, Output and supervision parameters

Code	Parameter	Range	Step	Default	Custom	Description	Page																		
3.1	Analog output function 	0—7	1	1		<table border="1"> <thead> <tr> <th>Function</th> <th>Scale</th> </tr> </thead> <tbody> <tr> <td>0 = Not used</td> <td>Scale 100%</td> </tr> <tr> <td>1 = O/P frequency</td> <td>(0—f_{max})</td> </tr> <tr> <td>2 = Motor speed</td> <td>(0—max. speed)</td> </tr> <tr> <td>3 = O/P current</td> <td>(0—$2.0 \times I_{nSV9}$)</td> </tr> <tr> <td>4 = Motor torque</td> <td>(0—$2 \times T_{nMot}$)</td> </tr> <tr> <td>5 = Motor power</td> <td>(0—$2 \times P_{nMot}$)</td> </tr> <tr> <td>6 = Motor voltage</td> <td>(0—$100\% \times V_{nMot}$)</td> </tr> <tr> <td>7 = DC-link volt.</td> <td>(0—1000 V)</td> </tr> </tbody> </table>	Function	Scale	0 = Not used	Scale 100%	1 = O/P frequency	(0— f_{max})	2 = Motor speed	(0—max. speed)	3 = O/P current	(0— $2.0 \times I_{nSV9}$)	4 = Motor torque	(0— $2 \times T_{nMot}$)	5 = Motor power	(0— $2 \times P_{nMot}$)	6 = Motor voltage	(0— $100\% \times V_{nMot}$)	7 = DC-link volt.	(0—1000 V)	1-15
Function	Scale																								
0 = Not used	Scale 100%																								
1 = O/P frequency	(0— f_{max})																								
2 = Motor speed	(0—max. speed)																								
3 = O/P current	(0— $2.0 \times I_{nSV9}$)																								
4 = Motor torque	(0— $2 \times T_{nMot}$)																								
5 = Motor power	(0— $2 \times P_{nMot}$)																								
6 = Motor voltage	(0— $100\% \times V_{nMot}$)																								
7 = DC-link volt.	(0—1000 V)																								
3.2	Analog output filter time	0.00—10.00 s	0.01s	1.00 s		0 = no filtering	1-15																		
3.3	Analog output inversion	0—1	1	0		0 = Not inverted 1 = Inverted	1-15																		
3.4	Analog output minimum	0—1	1	0		0 = 0 mA 1 = 4 mA	1-15																		
3.5	Analog output scale	10—1000%	1%	100%			1-15																		

Note!  = Parameter value can be changed only when the drive is stopped.



Group 3, Output and supervision parameters

Code	Parameter	Range	Step	Default	Custom	Description	Page
3.6	Digital output function 	0—14	1	1		0 = Not used 1 = Ready 2 = Run 3 = Fault 4 = Fault inverted 5 = SV9000 overheat warning 6 = External fault or warning 7 = Reference fault or warning 8 = Warning 9 = Reversed 10 = Multi-step speed selected 11 = At speed 12 = Motor regulator activated 13 = Output frequency limit superv. 14 = Control from I/O-terminal	1-16
3.7	Relay output 1 function 	0—14	1	2		As parameter 3.6	1-16
3.8	Relay output 2 function 	0—14	1	3		As parameter 3.6	1-16
3.9	Output freq. limit supervision function	0—2	1	0		0 = No 1 = Low limit 2 = High limit	1-16
3.10	Output freq. limit supervision value	0.0— f_{max} (par. 1.2)	0.1 Hz	0.0 Hz			1-16
3.11	I/O-expander option board analog output function	0—7	1	3		As parameter 3.1	1-15
3.12	I/O-expander option board analog output scale	10—1000%	1%	100%		As parameter 3.5	1-15

Group 4, Drive control parameters

Code	Parameter	Range	Step	Default	Custom	Description	Page
4.1	Acc./Dec. ramp 1 shape	0.0—10.0 s	0.1 s	0.0 s		0 = Linear >0 = S-curve acc./dec. time	1-17
4.2	Acc./Dec. ramp 2 shape	0.0—10.0 s	0.1 s	0.0 s		0 = Linear >0 = S-curve acc./dec. time	1-17
4.3	Acceleration time 2	0.1—3000.0 s	0.1 s	10.0 s			1-17
4.4	Deceleration time 2	0.1—3000.0 s	0.1 s	10.0 s			1-17
4.5	Brake chopper 	0—2	1	0		0 = Brake chopper not in use 1 = Brake chopper in use 2 = External brake chopper	1-17
4.6	Start function	0—1	1	0		0 = Ramp 1 = Flying start	1-17
4.7	Stop function	0—1	1	0		0 = Coasting 1 = Ramp	1-18
4.8	DC-braking current	0.15—1.5 x I_{nSV9} (A)	0.1 A	0.5 x I_{nSV9}			1-18
4.9	DC-braking time at Stop	0.00—250.00 s	0.01 s	0.00 s		0 = DC-brake is off	1-18







Note!  = Parameter value can be changed only when the drive is stopped.



Group 5, Prohibit frequency parameters

Code	Parameter	Range	Step	Default	Custom	Description	Page
5.1	Prohibit frequency range low limit	f_{\min} — f_{\max} par. 5.2	0.1 Hz	0.0 Hz			1-19
5.2	Prohibit frequency range high limit	f_{\min} — f_{\max} (1.1) (1.2)	0.1 Hz	0.0 Hz		0 = no prohibit frequency range (max limit = par. 1.2)	1-19

Group 6, Motor control parameters

Code	Parameter	Range	Step	Default	Custom	Description	Page
6.1	Motor control mode 	0—1	1	0		0 = Frequency control 1 = Speed control	1-20
6.2	Switching frequency	1.0—16.0 kHz	0.1	10/3.6 kHz		Dependant on Hp rating	1-20
6.3	Field weakening point 	30—500 Hz	1 Hz	Param. 1.11			1-20
6.4	Voltage at field weakening point 	15—200% $\times V_{\text{nmot}}$	1%	100%			1-20
6.5	V/Hz curve mid point frequency 	0.0— f_{\max}	0.1 Hz	0.0 Hz			1-20
6.6	V/Hz curve mid point voltage 	0.00—100.00% $\times V_{\text{nmot}}$	0.01%	0.00%			1-20
6.7	Output voltage at zero frequency 	0.00—100.00% $\times V_{\text{nmot}}$	0.01%	0.00%			1-20
6.8	Overvoltage controller	0—1	1	1		0 = Controller is off 1 = Controller is on	1-20
6.9	Undervoltage controller	0—1	1	1		0 = Controller is off 1 = Controller is on	1-20

Note!  = Parameter value can be changed only when the drive is stopped.

Group 7, Protections

Code	Parameter	Range	Step	Default	Custom	Description	Page
7.1	Response to reference fault	0—3	1	0		0 = No action 1 = Warning 2 = Fault, stop according par. 4.7 3 = Fault, always coasting stop	1-21
7.2	Response to external fault	0—3	1	2		0 = No action 1 = Warning 2 = Fault, stop according par. 4.7 3 = Fault, always coasting stop	1-21
7.3	Phase supervision of the motor	0—2	2	2		0 = No action 2 = Fault	1-21
7.4	Ground fault protection	0—2	2	2		0 = No action 2 = Fault	1-21
7.5	Motor thermal protection	0—2	1	2		0 = No action 1 = Warning 2 = Fault	1-22
7.6	Stall protection	0—2	1	1		0 = No action 1 = Warning 2 = Fault	1-22



Group 8, Autorestart parameters

Code	Parameter	Range	Step	Default	Custom	Description	Page
8.1	Automatic restart: number of tries	0—10	1	0		0 = no action	1-23
8.2	Automatic restart: multi- attempt max. trial time	1—6000 s	1 s	30 s			1-23
8.3	Automatic restart: start function	0—1	1	0		0 = Ramp 1 = Flying start	1-24

Table 1.5-1 Special parameters, Groups 2—8.

1

1.5.2 Description of Group 2—8 parameters

2.1 Start/Stop logic selection

- 0 DIA1: closed contact = start forward
 DIA2: closed contact = start reverse,
 See figure 1.5-1.

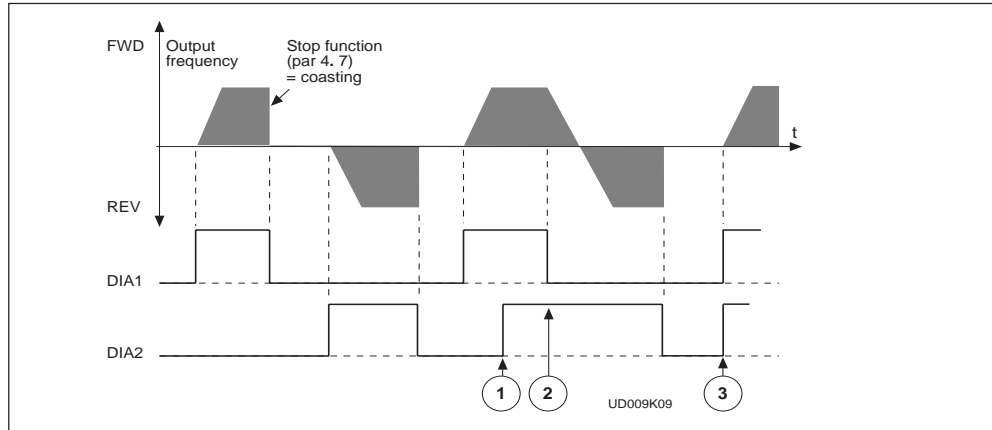

Figure 1.5-1 Start forward/Start reverse.

- ① The first selected direction has the highest priority
 - ② When DIA1 contact opens, the direction of rotation starts to change
 - ③ If Start forward (DIA1) and Start reverse (DIA2) signals are active simultaneously, the Start forward signal (DIA1) has priority.
- 1 DIA1: closed contact = start open contact = stop
 DIA2: closed contact = reverse open contact = forward
 See figure 1.5-2.

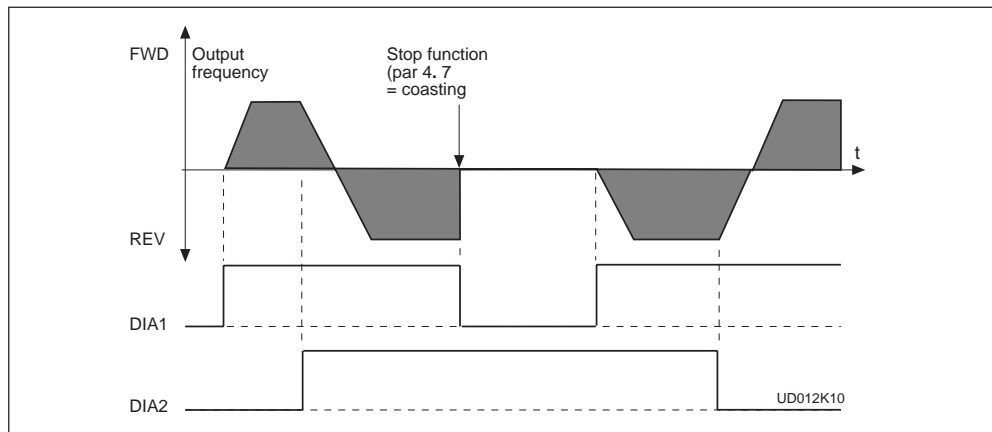

Figure 1.5-2 Start, Stop, reverse.



- 2: DIA1: closed contact = start open contact = stop
 DIA2: closed contact = start enabled open contact = start disabled
- 3: 3-wire connection (pulse control):
 DIA1: closed contact = start pulse
 DIA2: closed contact = stop pulse
 (DIA3 can be programmed for reverse command)
 See figure 1.5-3.

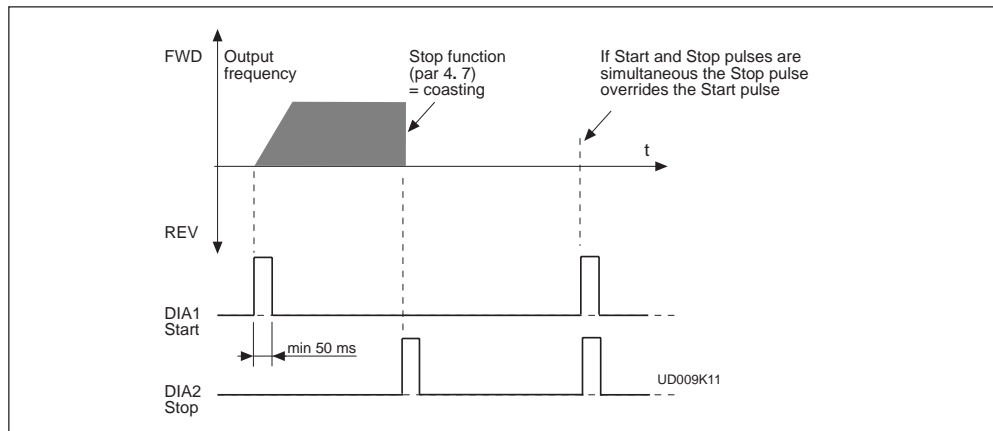

Figure 1.5-3 Start pulse/Stop pulse.

2. 2 DIA3 function

- 1: External fault, closing contact = Fault is shown and drive responds according to parameter 7.2.
- 2: External fault, opening contact = Fault is shown and drive responds according to parameter 7.2.
- 3: Run enable contact open = Start of the motor disabled
 contact closed = Start of the motor enabled
- 4: Acc. / Dec contact open = Acceleration/Deceleration time 1 selected
 time select. contact closed = Acceleration/Deceleration time 2 selected
- 5: Reverse contact open = Forward || Can be used for reversing if
 contact closed = Reverse || parameter 2. 1 has value 3

2.3 Reference offset for current input

- 0: No offset
- 1: Offset 4 mA, provides supervision of zero level signal. The response to reference fault can be programmed with the parameter 7. 1.



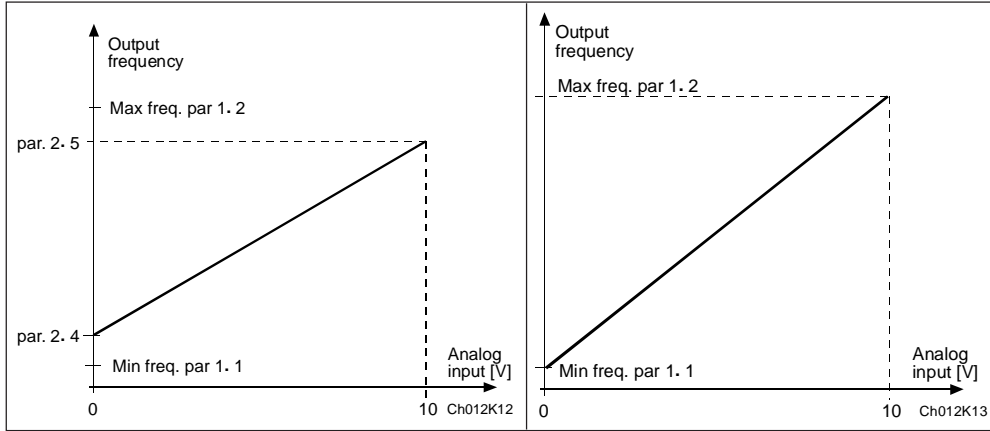

Figure 1.5-4 Reference scaling.

Figure 1.5-5 Reference scaling, parameter 2.5 = 0.

2.4, 2.5 Reference scaling, minimum value/maximum value

Setting value limits: $0 \leq \text{par. 2.4} \leq \text{par. 2.5} \leq \text{par. 1.2}$.
 If parameter 2.5 = 0 scaling is set off. See figures 1.5-4 and 1.5-5.

2.6 Reference invert

Inverts reference signal:
 max. ref. signal = min. set freq.
 min. ref. signal = max. set freq.
 See figure 1.5-6.

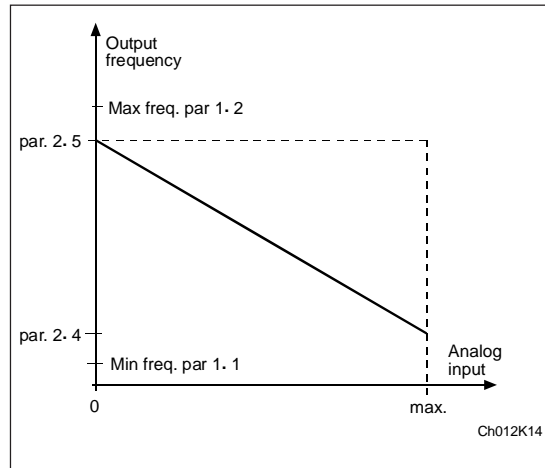

Figure 1.5-6 Reference invert.

2.7 Reference filter time

Filters out disturbances from the incoming reference signal. A long filtering time makes regulation response slower. See figure 1.5-7.

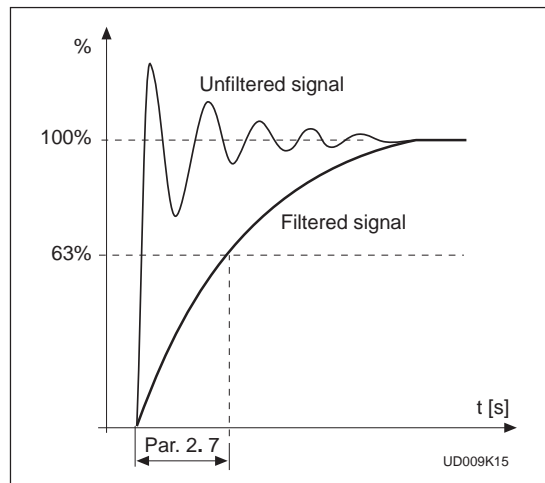

Figure 1.5-7 Reference filtering.



3.1 Analog output function

See table "Group 3, output and supervision parameters" on the page 1-8.

3.2 Analog output filter time

Filters the analog output signal. See figure 1.5-8.

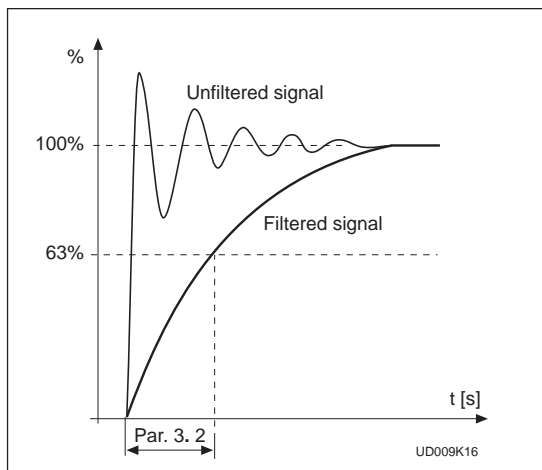

Figure 1.5-8 Analog output filtering.

3.3 Analog output invert

Inverts analog output signal:
 max. output signal = minimum set value
 min. output signal = maximum set value
 See figure 1.5-9

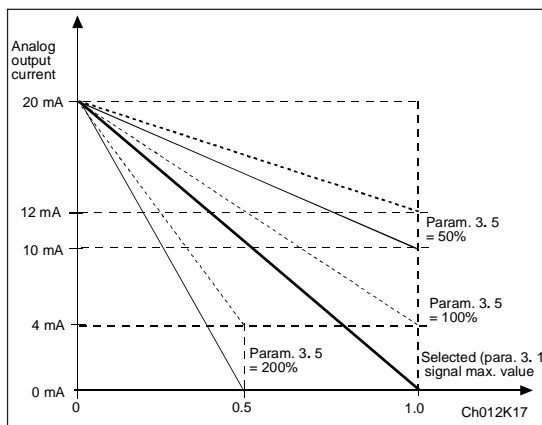

Figure 1.5-9 Analog output invert.

3.4 Analog output minimum

Defines the signal minimum to be either 0 mA or 4 mA. See figure 1.5-10.

3.5 Analog output scale

Scaling factor for analog output. See figure 1.5-10.

Signal	Max. value of the signal
Output frequency	Max. frequency (p. 1. 2)
Motor speed	Max. speed ($n_n \times f_{max} / f_n$)
Output current	$2 \times I_{nSV9}$
Motor torque	$2 \times T_{nMot}$
Motor power	$2 \times P_{nMot}$
Motor voltage	$100\% \times V_{nMot}$
DC-link volt.	1000 V

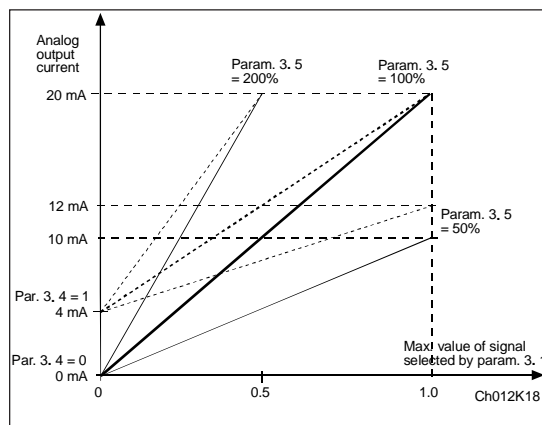

Figure 1.5-10 Analog output scale.



- 3.6 Digital output function
- 3.7 Relay output 1 function
- 3.8 Relay output 2 function

Setting value	Signal content
0 = Not used	Out of operation <u>Digital output DO1 sinks current and programmable relay (RO1, RO2) is activated when:</u>
1 = Ready	The drive is ready to operate
2 = Run	The drive operates
3 = Fault	A fault trip has occurred
4 = Fault inverted	A fault trip <u>has not</u> occurred
5 = SV9000 overheat warning	The heat-sink temperature exceeds +70°C
6 = External fault or warning	Fault or warning depending on parameter 7. 2
7 = Reference fault or warning	Fault or warning depending on parameter 7. 1 - if analog reference is 4—20 mA and signal is <4mA
8 = Warning	Always if a warning exists
9 = Reversed	The reverse command has been selected
10= Multi-step speed selected	A multi-step speed has been selected
11= At speed	The output frequency has reached the set reference
12= Motor regulator activated	Overvoltage or overcurrent regulator was activated
13= Output frequency supervision	The output frequency goes outside of the set supervision low limit/ high limit (par. 3. 9 and 3. 10)
14= Control from I/O terminals	Ext. control mode selected with progr. push-button #2

Table 1.5-2 Output signals via DO1 and output relays RO1 and RO2.

3.9 Output frequency limit supervision function

- 0 = No supervision
- 1 = Low limit supervision
- 2 = High limit supervision

If the output frequency goes under/over the set limit (3. 10) this function generates a warning message via the digital output DO1 and via a relay output RO1 or RO2 depending on the settings of the parameters 3. 6—3. 8.

3.10 Output frequency limit supervision value

The frequency value to be supervised by the parameter 3. 9.
See figure 1.5-11.

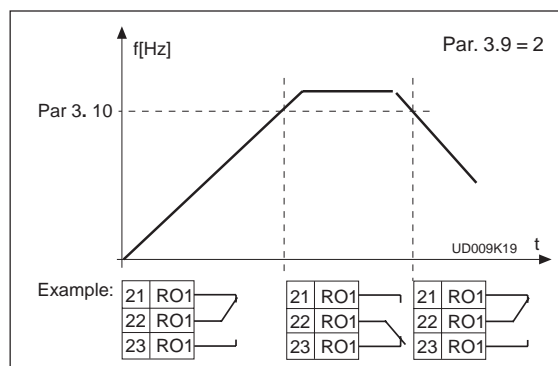

Figure 1.5-11 Output frequency supervision.



4.1 Acc/Dec ramp 1 shape
4.2 Acc/Dec ramp 2 shape

The acceleration and deceleration ramp shape can be programmed with these parameters.

Setting the value = 0 gives you a linear ramp shape. The output frequency immediately follows the input with a ramp time set by parameters 1. 3, 1. 4 (4. 3, 4. 4 for Acc/Dec. time 2).

Setting 0.1—10 seconds for 4. 1 (4. 2) causes an S-shaped ramp. The speed changes are smooth. Parameter 1. 3/ 1. 4 (4. 3/ 4. 4) determines the ramp time of the acceleration/deceleration in the middle of the curve. See figure 1.5-12.

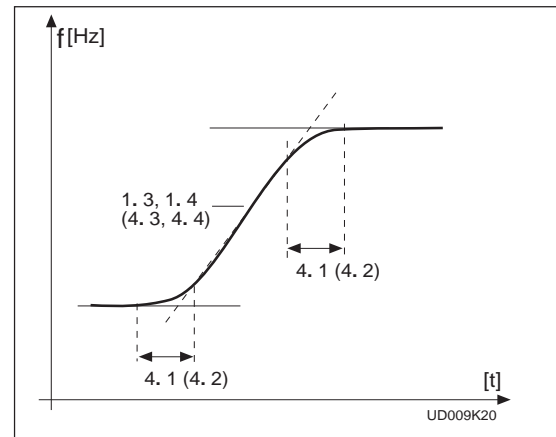

Figure 1.5-12 S-shaped acceleration/
deceleration.

4.3 Acceleration time 2
4.4 Deceleration time 2

These values correspond to the time required for the output frequency to change from the set minimum frequency (par. 1. 1) to the set maximum frequency (par. 1. 2). With this parameter it is possible to set two different acceleration/deceleration times for one application. The active set can be selected with the programmable signal DIA3. See parameter 2. 2.

4.5 Brake chopper

- 0 = No brake chopper
- 1 = Brake chopper and brake resistor installed
- 2 = External brake chopper

When the drive is decelerating the motor, the energy stored in the inertia of the motor and the load is fed into the external brake resistor. If the brake resistor is selected correctly the drive is able to decelerate the load with a torque equal to that of acceleration. See the separate Brake resistor installation manual.

4.6 Start function

Ramp:

- 0** The drive starts from 0 Hz and accelerates to the set reference frequency within the set acceleration time. (Load inertia or starting friction may extend the acceleration times).



Flying start:

- 1 The drive starts into a running motor by first finding the speed the motor is running at. Searching starts from the maximum frequency down until the actual frequency reached. The output frequency then accelerates/decelerates to the set reference value at a rate determined by the acceleration/deceleration ramp parameters.

Use this mode if the motor may be coasting when the start command is given. With the flying start it is possible to ride through short utility voltage interruptions.

4.7 Stop function

Coasting:

- 0 The motor coasts to an uncontrolled stop with the SV9000 off, after the Stop command is issued.

Ramp:

- 1 After the Stop command is issued, the speed of the motor is decelerated based on the deceleration ramp time parameter.
If the regenerated energy is high, it may be necessary to use an external braking resistor for faster deceleration.

4.8 DC braking current

Defines the current injected into the motor during DC braking.

4.9 DC braking time at stop

Determines whether DC braking is ON or OFF. It also determines the braking duration time of the DC-brake when the motor is stopping. The function of the DC-brake depends on the stop function, parameter 4. 7. See figure 1.5-13.

- 0 DC-brake is not used
- >0 DC-brake is in use depending on the setup of the stop function (param. 4. 7). The time is set by the value of parameter 4. 9:

Stop-function = 0 (coasting):

After the stop command, the motor will coast to a stop with the SV9000 off.

With DC-injection, the motor can be electrically stopped in the shortest possible time, without using an optional external braking resistor.

The braking time is scaled according to the frequency when the DC- braking starts. If the frequency is \geq nominal frequency of the motor (par. 1.11), the value of parameter 4.9 determines the braking time. When the frequency is \leq 10% of the nominal, the braking time is 10% of the set value of parameter 4.9. See figure 1.5-13.



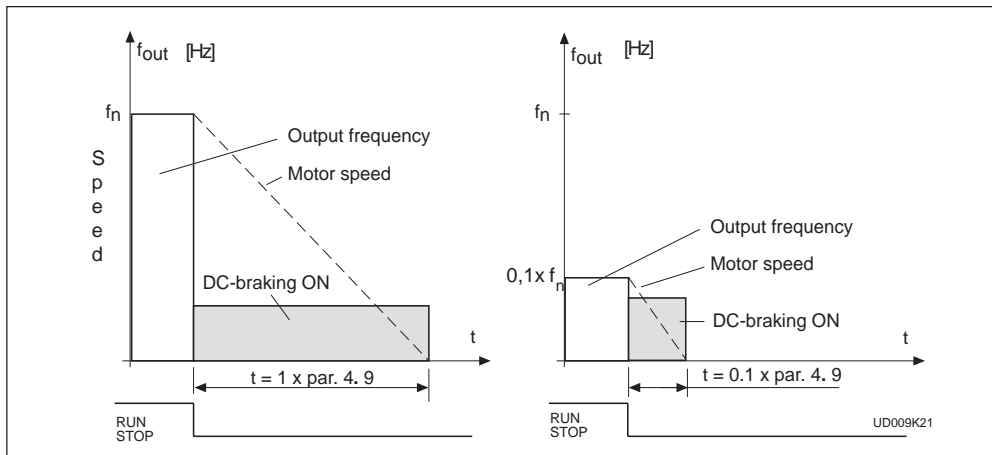

Figure 1.5-13 DC-braking time when stop = coasting.

Stop-function = 1 (ramp):

After a Stop command, the speed of the motor is reduced based on the deceleration ramp parameter. If no regeneration occurs due to load inertia DC-braking starts at 0.5 Hz.

The braking time is defined by par. 4. 9. If the load has a high inertia, use an external braking resistor for faster deceleration.

See figure 1.5-14.

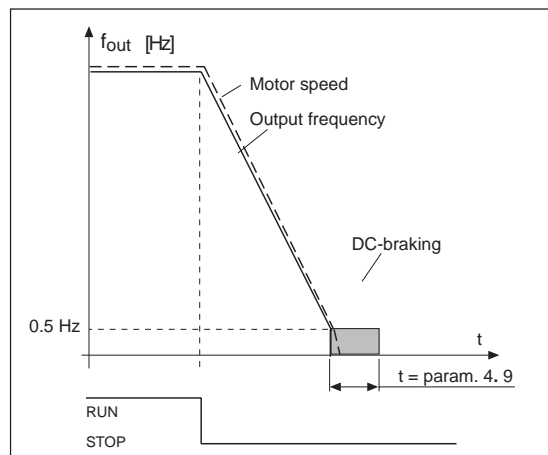

Figure 1.5-14 DC-braking time when stop function = ramp.

5.1 Prohibit frequency area
5.2 Low limit/High limit

In some systems it may be necessary to avoid certain frequencies because of mechanical resonance problems.

With these parameters it is possible to set limits for one "skip frequency" region between 0 Hz and 120 Hz/500 Hz. Accuracy of the setting is 0.1 Hz.

See figure 1.5-15.

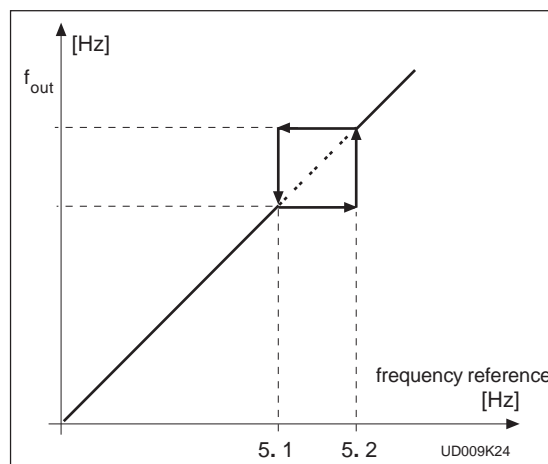

Figure 1.5-15 Example of prohibit frequency area setting.



6.1 Motor control mode

- 0 = Frequency control: The I/O terminal and panel references are frequency references and the drive controls the output frequency (output freq. resolution 0.01 Hz)
- 1 = Speed control: The I/O terminal and panel references are speed references and the drive controls the motor speed (control accuracy $\pm 0.5\%$)
(sensorless vector)

6.2 Switching frequency

Motor noise can be minimized by using a high switching frequency. Increasing the switching frequency reduces the current capacity of the SV9000.

Before changing the frequency from the factory default 10 kHz (3.6 kHz ≥ 40 Hp) check the drive derating in the curves shown in figures 5.2-2 and 5.2-3 in chapter 5.2 of the User's Manual.

6.3 Field weakening point**6.4 Voltage at the field weakening point**

The field weakening point is the output frequency where the output voltage reaches the set maximum value (parameter 6. 4). Above that frequency the output voltage remains constant at the set maximum value. Below that frequency the output voltage depends on the setting of the V/Hz curve parameters 1. 8, 1. 9, 6. 5, 6. 6 and 6. 7. See figure 1.5-16.

When the parameters 1. 10 and 1. 11, nominal voltage and nominal frequency of the motor, are set, parameters 6. 3 and 6. 4 are also set automatically to the same values. If you need different values for the field weakening point and the maximum output voltage, change these parameters after setting parameters 1. 10 and 1. 11.

6.5 V/Hz curve, middle point frequency

If the programmable V/Hz curve has been selected with parameter 1. 8, this parameter defines the middle frequency point of the curve. See figure 1.5-16.

6.6 V/Hz curve, middle point voltage

If the programmable V/Hz curve has been selected with parameter 1. 8, this parameter defines the middle voltage point of the curve. See figure 1.5-16.

6.7 Output voltage at zero frequency

If the programmable V/Hz curve has been selected with parameter 1. 8, this parameter defines the zero frequency voltage of the curve. See figure 1.5-16.

6.8 Overvoltage controller**6.9 Undervoltage controller**

These parameters allow the over/undervoltage controllers to be switched ON or OFF. This may be useful in cases where the utility supply voltage varies more than -15%—+10% and the application requires a constant speed. If the controllers are ON, they will change the motor speed in over/undervoltage cases. Overvoltage = faster, undervoltage = slower.

Over/undervoltage trips may occur when the controllers are not used.



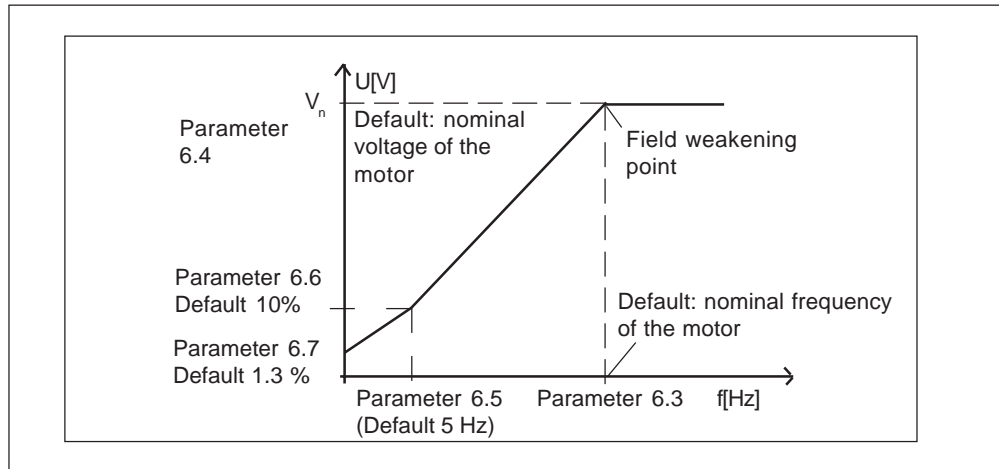

Figure 1.5-16 Programmable V/Hz curve.

7.1 Response to reference faults

- 0 = No response
- 1 = Warning
- 2 = Fault, stop mode after fault detection according to parameter 4.7
- 3 = Fault, always coasting stop mode after fault detection

A warning or a fault action and message is generated if the 4—20 mA reference signal is used and the signal falls below 4 mA.

The information can also be programmed via digital output DO1 and via relay outputs RO1 and RO2.

7.2 Response to external fault

- 0 = No response
- 1 = Warning
- 2 = Fault, stop mode after fault detection according to parameter 4.7
- 3 = Fault, always coasting stop mode after fault detection

A warning or a fault action and message is generated from the external fault signal in the digital input DIA3.

The information can also be programmed into digital output DO1 and into relay outputs RO1 and RO2.

7.3 Phase supervision of the motor

- 0 = No action
- 2 = Fault

Phase supervision of the motor ensures that the motor phases have approximately equal current.

7.4 Ground fault protection

- 0 = No action
- 2 = Fault

Ground fault protection ensures that the sum of motor phase currents is zero. The standard overcurrent protection is always present and protects the drive from ground faults with high current levels.



7.5 Motor thermal protection

Operation:

- 0 = Not in use
- 1 = Warning
- 2 = Trip

The motor thermal protection protects the motor from overheating. In the Standard application the thermal protection has fixed settings. In other applications it is possible to set the thermal protection parameters. A trip or a warning will give an indication on the display. If trip is selected, the drive will stop the motor and generate a fault.

Deactivating the protection by setting the parameter to 0 will reset the internal thermal model to 0% heating.

The SV9000 is capable of providing higher than nominal current to the motor. If the load requires this high current there is a risk that motor will be thermally overloaded. This is true especially at low frequencies. With low frequencies the cooling effect of the motor fan is reduced and the capacity of the motor is reduced. Motor thermal protection is based on a calculated model and it uses the output current of the drive to determine the load on the motor.

The thermal current I_T specifies the load current above which the motor is overloaded. See figure 1.5-17. If the motor current is over the curve the motor temperature is increasing.

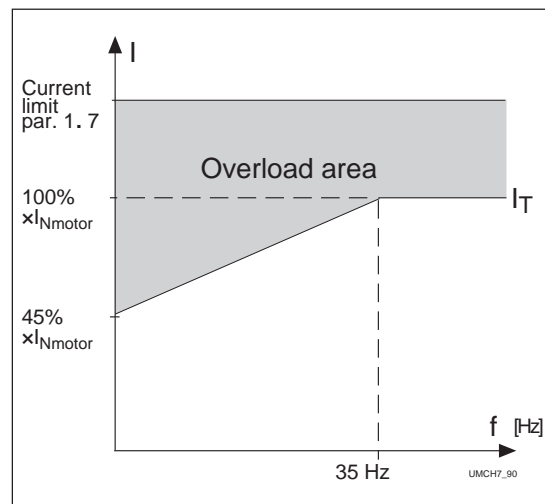

Figure 1.5-17 Motor thermal current I_T curve.



CAUTION! *The calculated model does not protect the motor if the cooling of the motor is reduced either by blocking the airflow or due to dust or dirt.*

7.6 Stall protection

Operation:

- 0 = Not in use
- 1 = Warning
- 2 = Trip function

The Motor Stall protection provides a warning or a fault based on a short time overload of the motor e.g. stalled shaft. The stall protection is faster than the motor thermal protection. The stall state is defined with Stall Current and Stall Frequency. In the Standard application they both have fixed values. See figure 1.5-18. If the current is higher than the set limit and output frequency is lower than the set limit the stall state is true. If the stall lasts longer than 15 s a stall warning is given on the display panel. In the other applications it is possible to set the parameters of the Stall protection function. Tripping and warning will give a display indication. If tripping is set on, the drive will stop and generate a fault.



Deactivating the stall protection by setting the parameter to 0 will reset the stall time counter to zero.

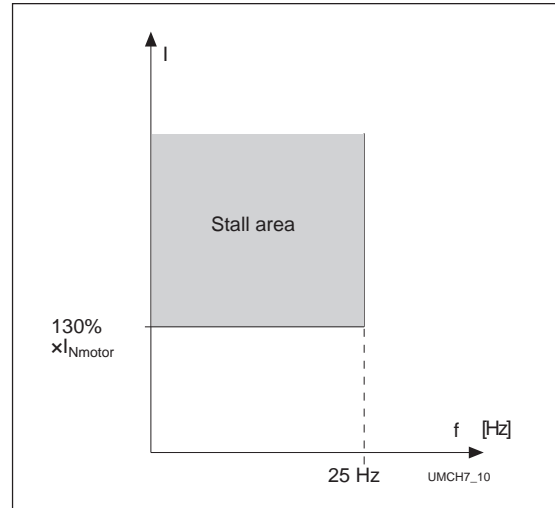

Figure 1.5-18 Stall state.

8.1 Automatic restart: number of tries

8.2 Automatic restart: trial time

The Automatic restart function will restart the drive after the following faults:

- overcurrent
- overvoltage
- undervoltage
- over/under temperature of the drive
- reference fault

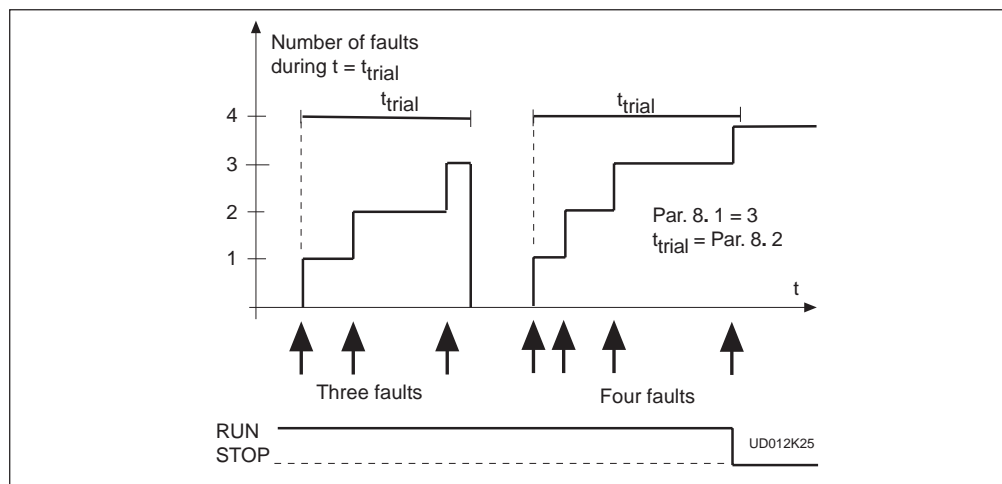

Figure 1.5-19 Automatic restart.

Parameter 8.1 determines how many automatic restarts can be made during the trial time set by the parameter 8.2.

The count time starts from the first autorestart. If the number of restarts does not exceed the value of the parameter 8.1 during the trial time, the count is cleared after the trial time has elapsed. The next fault starts the counting again.



LOCAL/REMOTE CONTROL APPLICATION

(par. 0.1 = 3)

CONTENTS

2 Local/Remote Control Application ..2-1

2.1	General	2-2
2.2	Control I/O	2-2
2.3	Control signal logic	2-3
2.4	Parameters Group 1	2-4
2.4.1	Parameter table	2-4
2.4.2	Description of Group1 par ...	2-5
2.5	Special parameters, Groups 2—8 ..	2-8
2.5.1	Parameter tables	2-8
2.5.2	Description of Group 2 par. .	2-15



2.1 General

By utilizing the Local/Remote Control Application, the use of two different control and frequency reference sources is programmable. The active control source is selected with digital input DIB6.

The Local/Remote Control Application can be activated from the Group 0 by setting the value

of parameter 0. 1 to 3.

Basic connections of inputs and outputs are shown in the figure 2.2-1. The control signal logic is shown in the figure 2.3-1. Programming of I/O terminals is explained in chapter 2.5, Special parameters.

2

2.2 Control I/O

*** NOTE!** Remember to connect the CMA and CMB inputs.

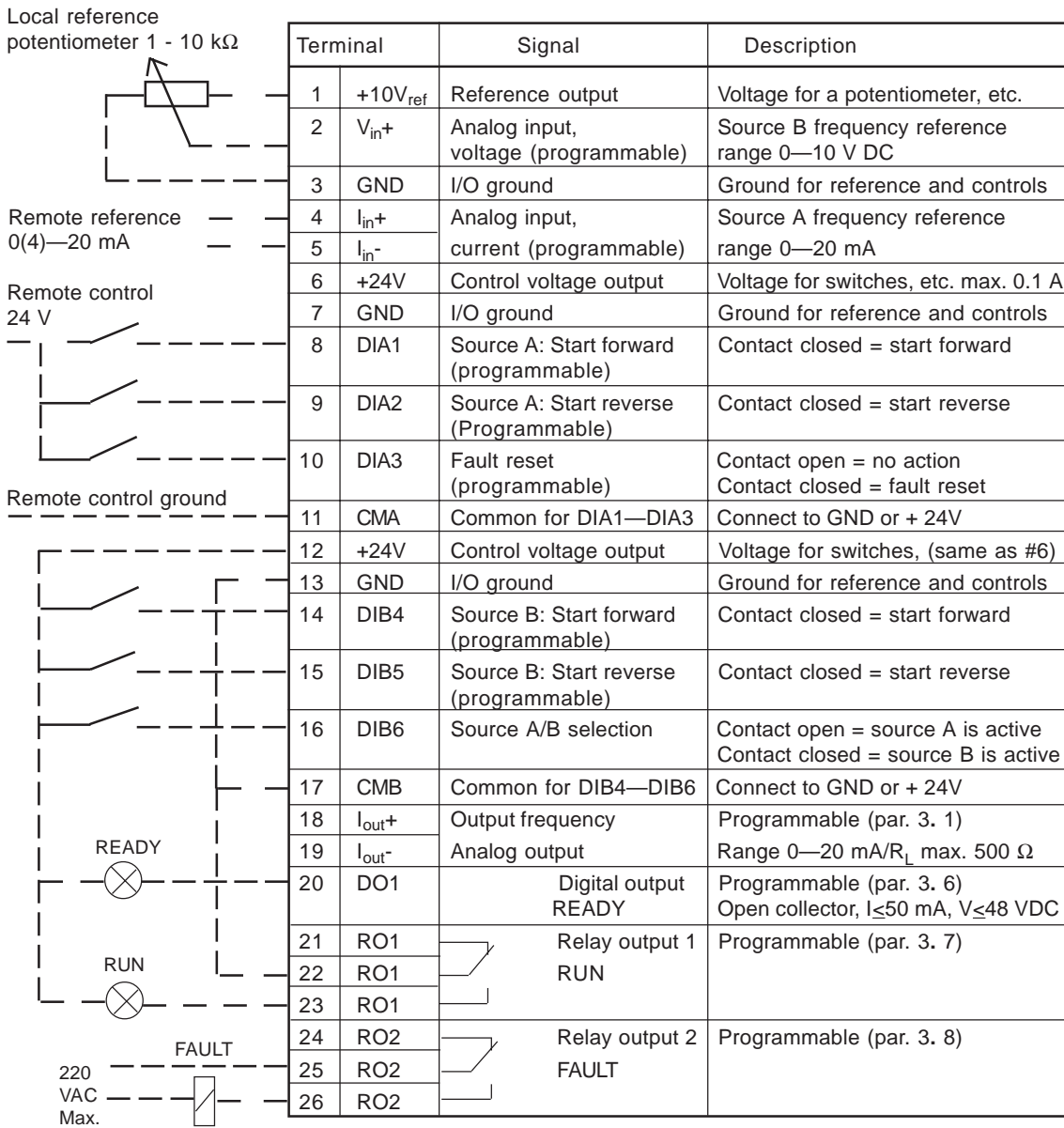

Figure 2.2-1 Default I/O configuration and connection example of the Local/Remote Control Application.



2.3 Control signal logic

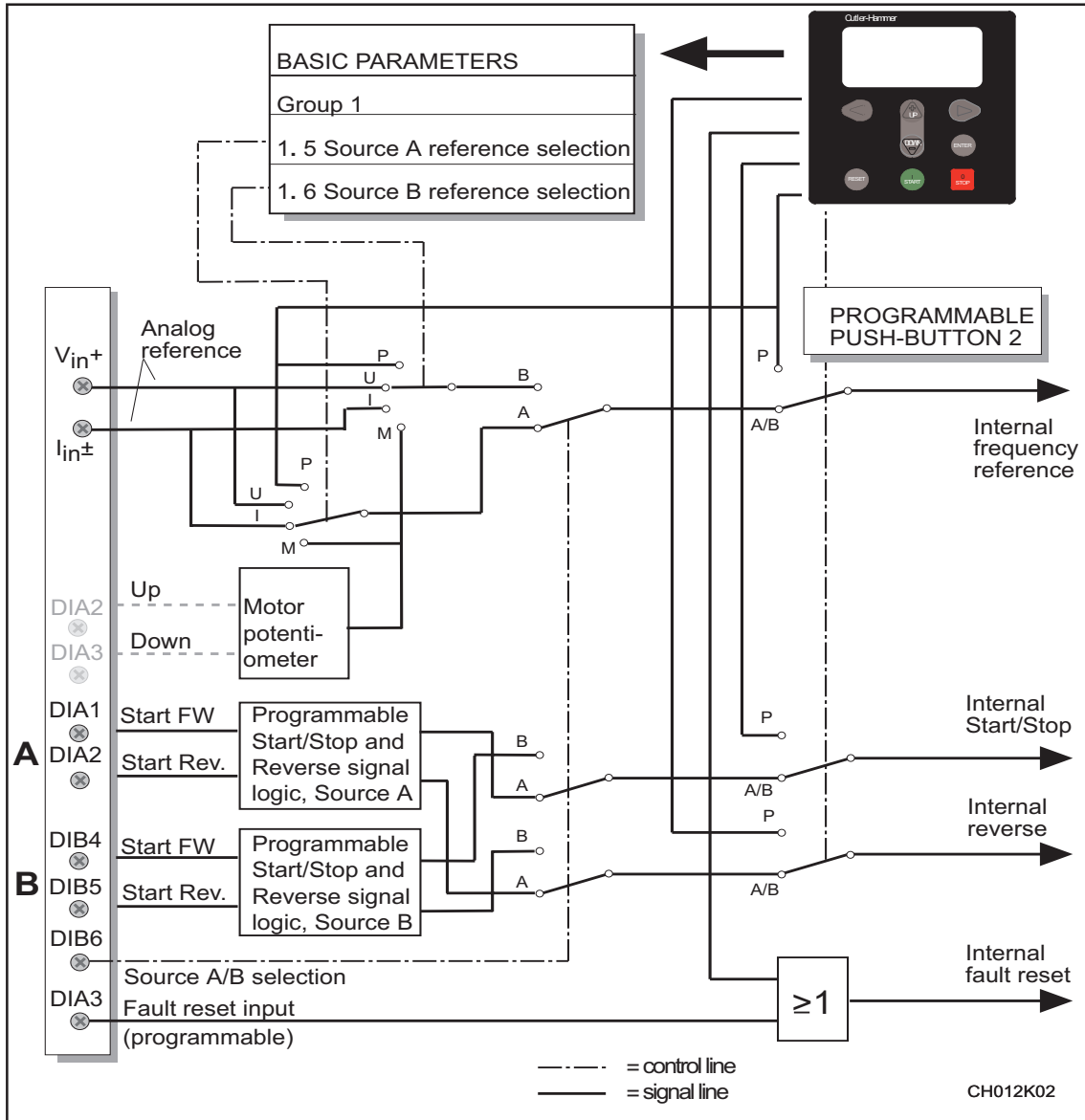

Figure 2.3-1 Control signal logic of the Local/Remote Control Application. Switch positions shown are based on the factory settings.

2



2.4 Basic parameters, Group 1

2.4.1 Parameter table











Code	Parameter	Range	Step	Default	Custom	Description	Page
1.1	Minimum frequency	0— f_{max}	1 Hz	0 Hz			2-5
1.2	Maximum frequency	f_{min} -120/500 Hz	1 Hz	60 Hz		*	2-5
1.3	Acceleration time 1	0.1—3000.0 s	0.1 s	3.0 s		Time from f_{min} (1. 1) to f_{max} (1. 2)	2-5
1.4	Deceleration time 1	0.1—3000.0 s	0.1 s	3.0 s		Time from f_{max} (1. 2) to f_{min} (1. 1)	2-5
1.5	Source A: reference signal 	0—4	1	1		0 = Anal. voltage input (term. 2) 1 = Anal. current input (term. 4) 2 = Set reference from the panel 3 = Signal from internal motor pot. 4 = Signal from internal motor pot. reset if SV9000 is stopped	2-5
1.6	Source B: reference signal 	0—4	1	0		0 = Anal. voltage input (term. 2) 1 = Anal. current input (term. 4) 2 = Set reference from the panel 3 = Signal from internal motor pot. 4 = Signal from internal motor pot. reset if SV9000 unit is stopped	2-5
1.7	Current limit	0.1— $2.5 \times I_{nSV9}$	0.1	$1.5 \times I_{nSV9}$		Output current limit [A] of the unit	2-5
1.8	V/Hz ratio selection 	0—2	1	0		0 = Linear 1 = Squared 2 = Programmable V/Hz ratio	2-5
1.9	V/Hz optimization 	0—1	1	0		0 = None 1 = Automatic torque boost	2-7
1.10	Nominal voltage of the motor 	180—690 V	1 V	230 V 380 V 480 V 575 V		Voltage code 2 Voltage code 4 Voltage code 5 Voltage code 6	2-7
1.11	Nominal frequency of the motor 	30—500 Hz	1 Hz	60 Hz		f_n from the nameplate of the motor	2-7
1.12	Nominal speed of the motor 	1—20000 rpm	1 rpm	1720 rpm **		n_n from the nameplate of the motor	2-7
1.13	Nominal current of the motor 	$2.5 \times I_{nSV9}$	0.1 A	I_{nSV9}		I_n from the nameplate of the motor	2-7
1.14	Supply voltage 	208—240 380—440 380—500 525—690		230 V 400 V 500 V 690 V		Voltage code 2 Voltage code 4 Voltage code 5 Voltage code 6	2-7
1.15	Parameter conceal	0—1	1	0		Visibility of the parameters: 0 = All parameter groups visible 1 = Only group 1 is visible	2-7
1.16	Parameter value lock	0—1	1	0		Disables parameter changes: 0 = Changes enabled 1 = Changes disabled	2-7

Table 2.4-1 Group 1 basic parameters.

* If 1. 2 > motor synchr. speed, check suitability for motor and drive system. Selecting 120 Hz/500 Hz range, see page 2-5.

Note!  = Parameter value can be changed only when the drive is stopped.

** Default value for a four pole motor and a nominal size SV9000.



2.4.2 Description of Group 1 parameters

1. 1, 1. 2 Minimum / maximum frequency

Defines the frequency limits of the drive.

The default maximum value for parameters 1. 1 and 1. 2 is 120 Hz. By setting the value of parameter 1. 2 to 120 Hz when the drive is stopped (RUN indicator not lit) parameters 1. 1 and 1. 2 are changed to 500 Hz. At the same time the resolution of the panel reference is changed from 0.01 Hz to 0.1 Hz.

Changing the max. value from 500 Hz to 120 Hz is done by setting parameter 1. 2 to 119 Hz while the drive is stopped.

1. 3, 1. 4 Acceleration time1, deceleration time 1:

These limits correspond to the time required for the output frequency to accelerate from the set minimum frequency (par. 1. 1) to the set maximum frequency (par. 1. 2). Acceleration/deceleration times can be reduced with a free analog input signal, see parameters 2. 18 and 2. 19.

1. 5 Source A reference signal

- 0** Analog voltage reference from terminals 2—3, e.g. a potentiometer
- 1** Analog current reference from terminals 4—5, e.g. a transducer.
- 2** Panel reference is the reference set from the Reference Page (REF), see chapter 7.5 in the User's Manual.
- 3** The reference value is controlled by digital input signals DIA2 and DIA3.
 - switch in DIA2 closed = frequency reference increases
 - switch in DIA3 closed = frequency reference decreases
 The speed range for the reference change can be set with the parameter 2.3.
- 4** Same as setting 3 but the reference value is set to the minimum frequency (par. 2. 14 or par. 1. 1 if par 2. 15 = 0) each time the drive is stopped. When the value of parameter 1. 5 is set to 3 or 4, parameter 2. 1 is automatically set to 4 and parameter 2. 2 is automatically set to 10.

1. 6 Source B reference signal

See the values of the parameter 1. 5.

1. 7 Current limit

This parameter determines the maximum motor current that the SV9000 will provide short term. Current limit can be set lower with a free analog input signal. See parameters 2. 18 and 2. 19.

1. 8 V/Hz ratio selection

Linear: The voltage of the motor changes linearly with the frequency in the constant flux area from 0 Hz to the field weakening point (par. 6. 3) where a constant voltage (nominal value) is supplied to the motor. See figure 2.4-1.

0

A linear V/Hz ratio should be used in constant torque applications.

This default setting should be used if there is no special requirement for another setting.



2

Squared: The voltage of the motor changes following a squared curve form with the frequency in the area from 0 Hz to the field weakening point (par. 6. 3) where the nominal maximum voltage is supplied to the motor. See figure 2.4-1.

1

The motor runs undermagnetized below the field weakening point and produces less torque and electromechanical noise. A squared V/Hz ratio can be used in applications where the torque demand of the load is proportional to the square of the speed, e.g. in centrifugal fans and pumps.

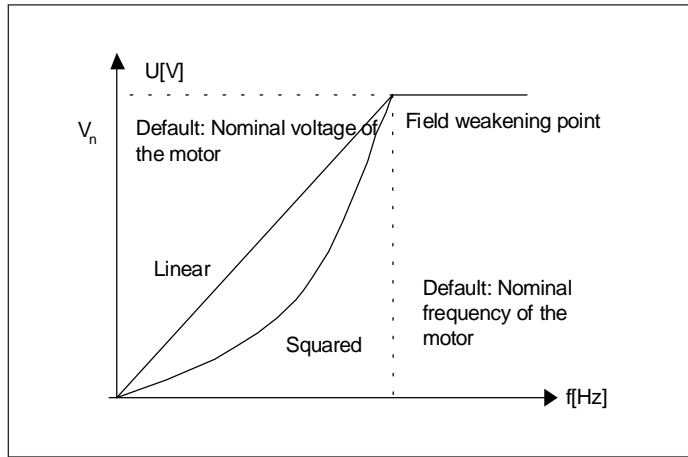

Figure 2.4-1 Linear and squared V/Hz curves.

Programm. The V/Hz curve can be programmed with three different points. V/Hz curve The parameters for programming are explained in chapter 2.5.2

2

Programmable V/Hz curve can be used if the standard settings do not satisfy the needs of the application. See figure 2.4-2.

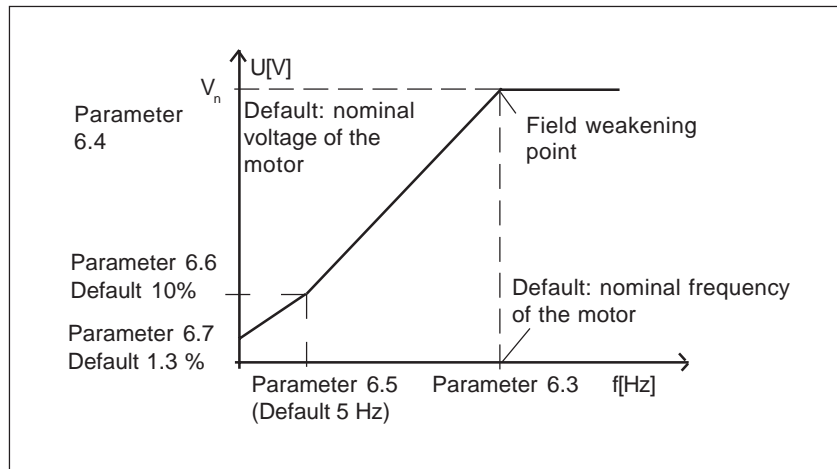

Figure 2.4-2 Programmable V/Hz curve.



1.9 V/Hz optimization

Automatic torque boost The voltage to the motor changes automatically which allows the motor to produce torque enough to start and run at low frequencies. The voltage increase depends on the motor type and horsepower.

Automatic torque boost can be used in applications where starting torque due to starting friction is high, e.g. in conveyors.

NOTE! *In high torque - low speed applications - it is likely the motor will overheat. If the motor has to run for a prolonged time under these conditions, special attention must be paid to cooling of the motor. Use external cooling for the motor if the temperature rise is too high.*

**1.10 Nominal voltage of the motor**

Find this value V_n from the nameplate of the motor.

This parameter sets the voltage at the field weakening point, parameter 6.4, to 100% $\times V_{n\text{motor}}$.

1.11 Nominal frequency of the motor

Find the nominal frequency f_n from the nameplate of the motor.

This parameter sets the field weakening point, parameter 6.3, to the same value.

1.12 Nominal speed of the motor

Find this value n_n from the nameplate of the motor.

1.13 Nominal current of the motor

Find the value I_n from the nameplate of the motor.

The internal motor protection function uses this value as a reference value.

1.14 Supply voltage

Set parameter value according to the nominal voltage of the supply.

Values are pre-defined for voltage codes 2, 4, 5, and 6. See table 2.4-1.

1.15 Parameter conceal

Defines which parameter groups are available:

0 = all groups are visible

1 = only group 1 is visible

1.16 Parameter value lock

Defines access for changing the parameter values:





0 = parameter value changes enabled

1 = parameter value changes disabled

If you have to adjust more of the functions of the Local/Remote Control Application, see chapter 2.5 to set up parameters of Groups 2—8.

2.5 Special parameters, Groups 2—8

2.5.1 Parameter tables, Group 2, Input signal parameters

Code	Parameter	Range	Step	Default	Custom	Description	Page	
2.1	Source A Start/Stop logic selection 	0—4	1	0		DIA1	DIA2	2-15
						0 = Start forward 1 = Start/Stop 2 = Start/Stop 3 = Start pulse 4 = Start forward	Start reverse Reverse Run enable Stop pulse Motor pot. UP	
2.2	DIA3 function (terminal 10) 	0—10	1	7		0 = Not used 1 = Ext. fault, closing contact 2 = External fault, opening contact 3 = Run enable 4 = Acc./dec. time selection 5 = Reverse (if par. 2. 1 = 3) 6 = Jog speed 7 = Fault reset 8 = Acc/dec. operation prohibit 9 = DC-braking command 10 = Motor potentiometer DOWN	2-16	
2.3	V _{in} signal range	0—1	1	0		0 = 0—10 V 1 = Custom setting range	2-17	
2.4	V _{in} custom setting min.	0.00—100.00%	0.01%	0.00%			2-17	
2.5	V _{in} custom setting max.	0.00—100.00%	0.01%	100.00%			2-17	
2.6	V _{in} signal inversion	0—1	1	0		0 = Not inverted 1 = Inverted	2-18	
2.7	V _{in} signal filter time	0.00—10.00s	0.01s	0.10s		0 = No filtering	2-18	
2.8	I _{in} signal range	0—2	1	0		0 = 0—20 mA 1 = 4—20 mA 2 = Custom setting range	2-19	
2.9	I _{in} custom setting minim.	0.00—100.00%	0.01%	0.00%			2-19	
2.10	I _{in} custom setting maxim.	0.00—100.00%	0.01%	100.00%			2-19	
2.11	I _{in} signal inversion	0—1	1	0		0 = Not inverted 1 = Inverted	2-19	
2.12	I _{in} signal filter time	0.01—10.00s	0.01s	0.10s		0 = No filtering	2-19	
2.13	Source B Start/Stop logic selection 	0—3	1	0		DIB4	DIB5	2-20
						0 = Start forward 1 = Start/Stop 2 = Start/Stop 3 = Start pulse	Start reverse Reverse Run enable Stop pulse	
2.14	Source A reference scaling minimum value	0—par. 2. 15	1 Hz	0 Hz		Sets the frequency corresponding to the min. reference signal	2-20	
2.15	Source A reference scaling maximum value	0—f _{max} (1. 2)	1 Hz	0 Hz		Sets the frequency corresponding to the max. reference signal 0 = Scaling off >0 = Scaled maximum value	2-20	
2.16	Source B reference scaling minimum value	0—par. 2. 17	1 Hz	0 Hz		Sets the frequency corresponding to the min. reference signal	2-20	
2.17	Source B reference scaling maximum value 	0—f _{max} (1. 2)	1 Hz	0 Hz		Sets the frequency corresponding to the max. reference signal 0 = Scaling off >0 = Scaled maximum value	2-20	

Note!  = Parameter value can be changed only when the drive is stopped.





Code	Parameter	Range	Step	Default	Custom	Description	Page
2.18	Free analog input, signal selection	0—2	1	0		0 = Not used 1 = V_{in} (analog voltage input) 2 = I_{in} (analog current input)	2-20
2.19	Free analog input, function	0—4	1	0		0 = No function 1 = Reduces current limit (par. 1.7) 2 = Reduces DC-braking current 3 = Reduces acc. and decel. times 4 = Reduces torque superv. limit	2-20
2.20	Motor potentiometer ramp time	0.1—2000.0 Hz/s	0.1 Hz/s	10.0 Hz/s			2-22

Group 3, Output and supervision parameters

Code	Parameter	Range	Step	Default	Custom	Description	Page
3.1	Analog output function	0—7	1	1		0 = Not used Scale 100% 1 = O/P frequency (0— f_{max}) 2 = Motor speed (0—max. speed) 3 = O/P current (0— $2.0 \times I_{nSV9}$) 4 = Motor torque (0— $2 \times T_{nMot}$) 5 = Motor power (0— $2 \times P_{nMot}$) 6 = Motor voltage (0— $100\% \times V_{nMot}$) 7 = DC-link volt. (0—1000 V)	2-22
3.2	Analog output filter time	0.00—10.00 s	0.01 s	100 s			2-22
3.3	Analog output inversion	0—1	1	0		0 = Not inverted 1 = Inverted	2-22
3.4	Analog output minimum	0—1	1	0		0 = 0 mA 1 = 4 mA	2-22
3.5	Analog output scale	10—1000%	1%	100%			2-22
3.6	Digital output function	0—21	1	1		0 = Not used 1 = Ready 2 = Run 3 = Fault 4 = Fault inverted 5 = SV9000 overheat warning 6 = External fault or warning 7 = Reference fault or warning 8 = Warning 9 = Reversed 10 = Jog speed selected 11 = At speed 12 = Motor regulator activated 13 = Output frequency limit superv. 1 14 = Output frequency limit superv. 2 15 = Torque limit supervision 16 = Reference limit supervision 17 = External brake control 18 = Control from I/O terminals 19 = Drive temperature limit supervision 20 = Unrequested rotation direction 21 = External brake control inverted	2-23

Note!  = Parameter value can be changed only when the drive is stopped.



Code	Parameter	Range	Step	Default	Custom	Description	Page
3.7	Relay output 1 function 	0—21	1	2		As parameter 3. 6	2-23
3.8	Relay output 2 function 	0—21	1	3		As parameter 3. 6	2-23
3.9	Output freq. limit 1 supervision function	0—2	1	0		0 = No 1 = Low limit 2 = High limit	2-24
3.10	Output freq. limit 1 supervision value	0.0— f_{max} (par. 1. 2)	0.1 Hz	0.0 Hz			2-24
3.11	Output freq. limit 2 supervision function	0—2	1	0		0 = No 1 = Low limit 2 = High limit	2-24
3.12	Output freq. limit 2 supervision value	0.0— f_{max} (par. 1. 2)	0.1 Hz	0.0 Hz			2-24
3.13	Torque limit supervision function	0—2	1	0		0 = No 1 = Low limit 2 = High limit	2-24
3.14	Torque limit supervision value	0.0—200.0% $\times T_{nSV9}$	0.1%	100.0%			2-24
3.15	Active reference limit supervision	0—2	1	0		0 = No 1 = Low limit 2 = High limit	2-24
3.16	Active reference limit supervision value	0.0— f_{max} (par. 1. 2)	0.1 Hz	0.0 Hz			2-24
3.17	External brake OFF delay	0.0—100.0 s	0.1 s	0.5 s			2-25
3.18	External brake ON delay	0.0—100.0 s	0.1 s	1.5 s			2-25
3.19	Drive temperature limit supervision function	0—2	1	0		0 = No supervision 1 = Low limit 2 = High limit	2-25
3.20	Drive temperature limit	-10—+75°C	1	+40°C			2-25
3.21	I/O-expander board (opt.) analog output function	0—7	1	3		See parameter 3. 1	2-22
3.22	I/O-expander board (opt.) analog output filter time	0.00—10.00 s	0.01 s	1.00 s		See parameter 3. 2	2-22
3.23	I/O-expander board (opt.) analog output inversion	0—1	1	0		See parameter 3. 3	2-22
3.24	I/O-expander board (opt.) analog output minimum	0—1	1	0		See parameter 3. 4	2-22
3.25	I/O-expander board (opt.) analog output scale	10—1000%	1	100%		See parameter 3. 5	2-22

Note!  = Parameter value can be changed only when the drive is stopped.



Group 4, Drive control parameters

Code	Parameter	Range	Step	Default	Custom	Description	Page
4.1	Acc./Dec. ramp 1 shape	0.0—10.0 s	0.1 s	0.0 s		0 = Linear >0 = S-curve acc./dec. time	2-26
4.2	Acc./Dec. ramp 2 shape	0.0—10.0 s	0.1 s	0.0 s		0 = Linear >0 = S-curve acc./dec. time	2-26
4.3	Acceleration time 2	0.1—3000.0 s	0.1 s	10.0 s			2-26
4.4	Deceleration time 2	0.1—3000.0 s	0.1 s	10.0 s			2-26
4.5	Brake chopper 	0—2	1	0		0 = Brake chopper not in use 1 = Brake chopper in use 2 = External brake chopper	2-26
4.6	Start function	0—1	1	0		0 = Ramp 1 = Flying start	2-26
4.7	Stop function	0—1	1	0		0 = Coasting 1 = Ramp	2-27
4.8	DC-braking current	0.15—1.5 I_{nsv9} (A)	0.1	0.5 x I_{nsv9}			2-27
4.9	DC-braking time at Stop	0.00—250.00 s	0.01 s	0.00 s		0 = DC-brake is off at Stop	2-27
4.10	Turn on frequency of DC-brake during ramp Stop	0.1—10.0 Hz	0.1 Hz	1.5 Hz			2-28
4.11	DC-brake time at Start	0.00—25.00 s	0.01 s	0.00 s		0 = DC-brake is off at Start	2-28
4.12	Jog speed reference	f_{min} — f_{max}	0.1 Hz	10.0 Hz			2-29

2







Group 5, Prohibit frequency parameters

Code	Parameter	Range	Step	Default	Custom	Description	Page
5.1	Prohibit frequency range 1 low limit	f_{min} — par. 5.2	0.1 Hz	0.0 Hz			2-29
5.2	Prohibit frequency range 1 high limit	f_{min} — f_{max} (1.1) (1.2)	0.1 Hz	0.0 Hz		0 = Prohibit range 1 is off	2-29
5.3	Prohibit frequency range 2 low limit	f_{min} — par. 5.4	0.1 Hz	0.0 Hz			2-29
5.4	Prohibit frequency range 2 high limit	f_{min} — f_{max} (1.1) (1.2)	0.1 Hz	0.0 Hz		0 = Prohibit range 2 is off	2-29
5.5	Prohibit frequency range 3 low limit	f_{min} — par. 5.6	0.1 Hz	0.0 Hz			2-29
5.6	Prohibit frequency range 3 high limit	f_{min} — f_{max} (1.1) (1.2)	0.1 Hz	0.0 Hz		0 = Prohibit range 3 is off	2-29

Note!  = Parameter value can be changed only when the drive is stopped.



Group 6, Motor control parameters

Code	Parameter	Range	Step	Default	Custom	Description	Page
6.1	Motor control mode 	0—1	1	0		0 = Frequency control 1 = Speed control	2-29
6.2	Switching frequency	1.0—16.0 kHz	0.1 kHz	10/3.6 kHz		Depends on Hp rating	2-29
6.3	Field weakening point 	30—500 Hz	1 Hz	Param. 1.11			2-29
6.4	Voltage at field weakening point 	15—200% $\times V_{nmot}$	1%	100%			2-29
6.5	V/Hz-curve mid point frequency 	0.0— f_{max}	0.1 Hz	0.0 Hz			2-30
6.6	V/Hz-curve mid point voltage 	0.00—100.00 % $\times V_{nmot}$	0.01%	0.00%			2-30
6.7	Output voltage at zero frequency 	0.00—100.00 % $\times V_{nmot}$	0.01%	0.00%			2-30
6.8	Oversvoltage controller	0—1	1	1		0 = Controller is not operating 1 = Controller is operating	2-30
6.9	Undervoltage controller	0—1	1	1		0 = Controller is not operating 1 = Controller is operating	2-30

Note!  = Parameter value can be changed only when the drive is stopped.

2



Group 7, Protections

Code	Parameter	Range	Step	Default	Custom	Description	Page
7.1	Response to reference fault	0—3	1	0		0 = No action 1 = Warning 2 = Fault, stop according to par. 4.7 3 = Fault, always coasting stop	2-30
7.2	Response to external fault	0—3	1	0		0 = No action 1 = Warning 2 = Fault, stop according to par. 4.7 3 = Fault, always coasting stop	2-31
7.3	Phase supervision of the motor	0—2	2	2		0 = No action 2 = Fault	2-31
7.4	Ground fault protection	0—2	2	2		0 = No action 2 = Fault	2-31
7.5	Motor thermal protection	0—2	1	2		0 = No action 1 = Warning 2 = Fault	2-32
7.6	Motor thermal protection break point current	50.0—150.0% $\times I_{nMOTOR}$	1.0%	100.0%			2-32
7.7	Motor thermal protection zero frequency current	5.0—150.0% $\times I_{nMOTOR}$	1.0%	45.0%			2-32
7.8	Motor thermal protection time constant	0.5—300.0 minutes	0.5 min.	17.0 min.		Default value is set according to motor nominal current	2-33
7.9	Motor thermal protection break point frequency	10—500 Hz	1 Hz	35 Hz			2-33
7.10	Stall protection	0—2	1	1		0 = No action 1 = Warning 2 = Fault	2-34
7.11	Stall current limit	5.0—200.0% $\times I_{nMOTOR}$	1.0%	130.0%			2-34
7.12	Stall time	2.0—120.0 s	1.0 s	15.0 s			2-34
7.13	Maximum stall frequency	1— f_{max}	1 Hz	25 Hz			2-34
7.14	Underload protection	0—2	1	0		0 = No action 1 = Warning 2 = Fault	2-35
7.15	Underload prot., field weakening area load	10.0—150.0% $\times T_{nMOTOR}$	1.0%	50.0%			2-35
7.16	Underload protection, zero frequency load	5.0—150.0% $\times T_{nMOTOR}$	1.0%	10.0%			2-35
7.17	Underload time	2.0—600.0 s	1.0 s	20.0s			2-36



Group 8, Autorestart parameters

Code	Parameter	Range	Step	Default	Custom	Description	Page
8.1	Automatic restart: number of tries	0—10	1	0		0 = Not in use	2-36
8.2	Automatic restart: multi attempt maximum trial time	1—6000 s	1 s	30 s			2-36
8.3	Automatic restart: start function	0—1	1	0		0 = Ramp 1 = Flying start	2-37
8.4	Automatic restart of undervoltage	0—1	1	0		0 = No 1 = Yes	2-37
8.5	Automatic restart of overvoltage	0—1	1	0		0 = No 1 = Yes	2-37
8.6	Automatic restart of overcurrent	0—1	1	0		0 = No 1 = Yes	2-37
8.7	Automatic restart of reference fault	0—1	1	0		0 = No 1 = Yes	2-37
8.8	Automatic restart after over/undertemperature fault	0—1	1	0		0 = No 1 = Yes	2-37

Table 2.5-1 Special parameters, Groups 2—8.



2.5.2 Description of Groups 2—8 parameters

2.1 Start/Stop logic selection

- 0: DIA1: closed contact = start forward
 DIA2: closed contact = start reverse,
 See figure 2.5-1.

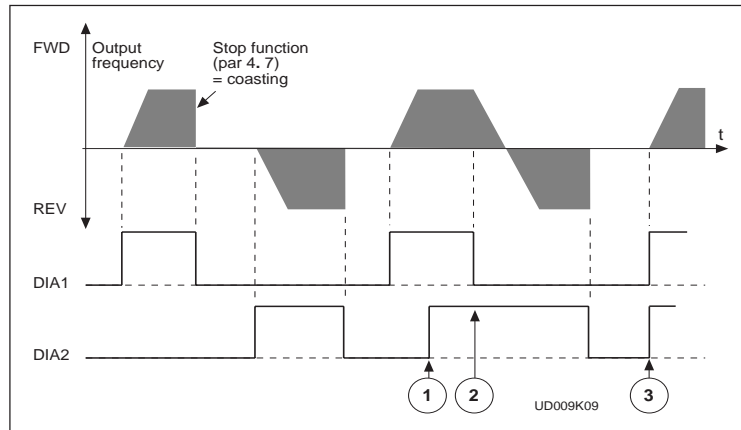

Figure 2.5-1 Start forward/Start reverse.

- ① The first selected direction has the highest priority
 - ② When DIA1 contact opens, the direction of rotation starts to change
 - ③ If Start forward (DIA1) and Start reverse (DIA2) signals are active simultaneously, the Start forward signal (DIA1) has priority.
- 1: DIA1: closed contact = start open contact = stop
 DIA2: closed contact = reverse open contact = forward
 See figure 2.5-2.

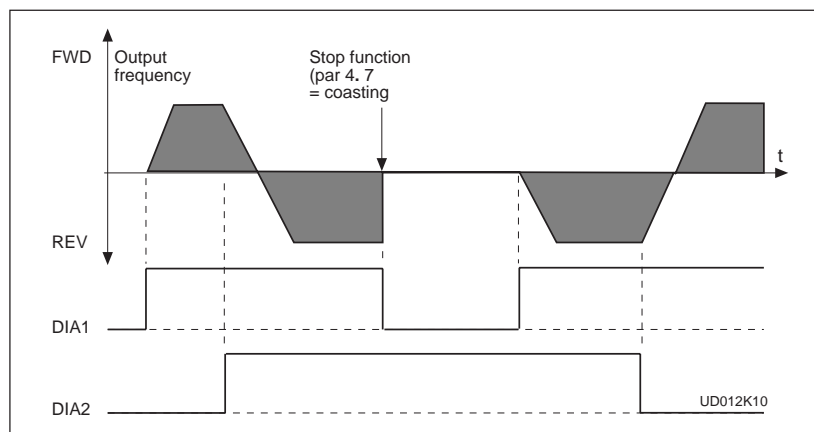

Figure 2.5-2 Start, Stop, reverse.

- 2: DIA1: closed contact = start open contact = stop
 DIA2: closed contact = start enabled open contact = start disabled
- 3: 3-wire connection (pulse control):
 DIA1: closed contact = start pulse
 DIA2: closed contact = stop pulse
 (DIA3 can be programmed for reverse command)
 See figure 2.5-3.
- 4: DIA1: closed contact = start forward
 DIA2: closed contact = reference increases (motor potentiometer reference, par. 2. 1 is automatically set to 4 if par. 1. 5 is set to 3 or 4).

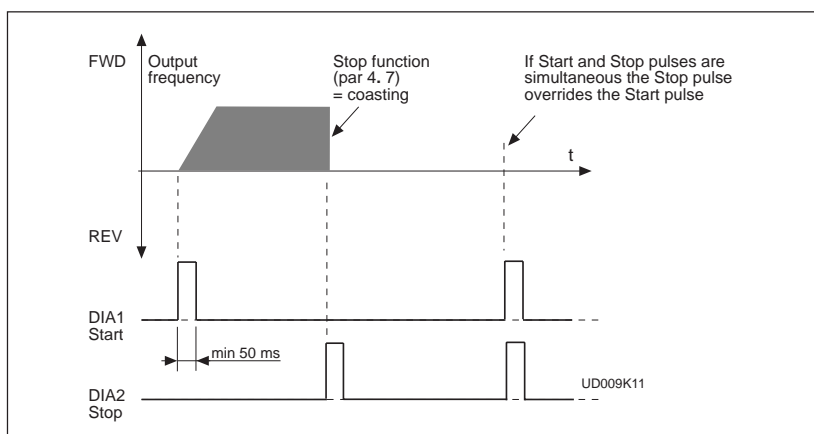

Figure 2.5-3 Start pulse /Stop pulse.

2. 2 DIA3 function

- 1: External fault, closing contact = Fault is shown and drive responds according to parameter 7.2.
 2: External fault, opening contact = Fault is shown and drive responds according to parameter 7.2.
 3: Run enable contact open = Start of the motor disabled
 contact closed = Start of the motor enabled
 4: Acc. / Dec time select. contact open = Acceleration/Deceleration time 1 selected
 contact closed = Acceleration/Deceleration time 2 selected
 5: Reverse contact open = Forward || Can be used for reversing if
 contact closed = Reverse || parameter 2. 1 has value 3
 6: Jog freq. contact closed = Jog frequency selected for freq. refer.
 7: Fault reset contact closed = Resets all faults
 8: Acc./Dec. operation prohibited
 contact closed = Stops acceleration and deceleration until
 the contact is opened
 9: DC-braking command
 contact closed = In the stop mode, the DC-braking operates
 until the contact is opened, see figure 2.5-4.
 Dc-brake current is set with parameter 4. 8.
 10: Motor pot. meter down
 contact closed = Reference decreases until the contact is
 opened



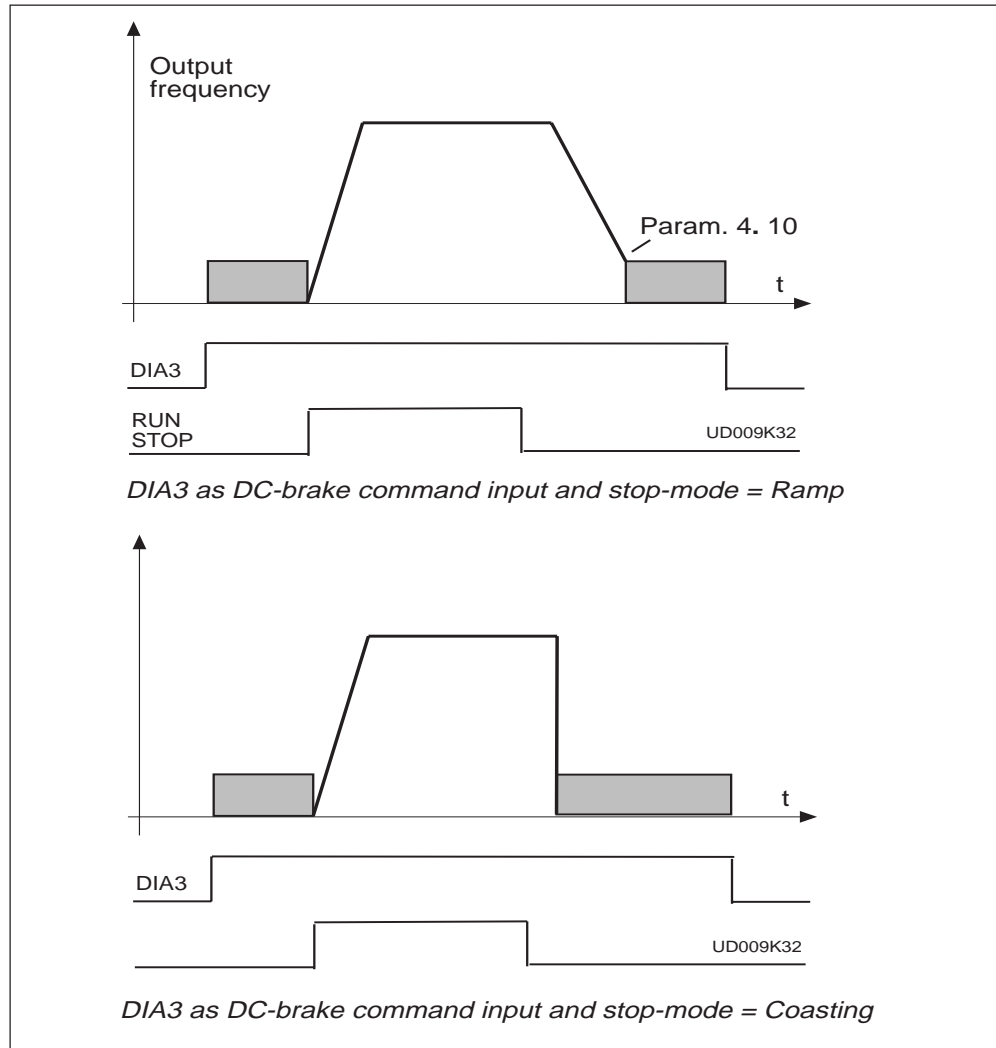

Figure 2.5-4 DIA3 as DC-brake command input: a) Stop-mode = Ramp, b) Stop-mode = Coasting.

2.3 V_{in} signal range

0 = Signal range 0—10 V

1 = Custom setting range from custom minimum (par. 2. 4) to custom maximum (par. 2. 5)

2.4-2.5 V_{in} custom setting minimum/maximum

With these parameters you can set V_{in} for any input signal span within 0—10 V.

Minimum setting: Set the V_{in} signal to its minimum level, select parameter 2. 4, press the Enter button

Maximum setting: Set the V_{in} signal to its maximum level, select parameter 2. 5, press the Enter button

Note! The parameter values can only be set with this procedure (not with arrow up/arrow down buttons).

2

2.6 V_{in} signal inversion

V_{in} is source B frequency reference, par. 1.6 = 1 (default)

Parameter 2.6 = 0, no inversion of analog V_{in} signal.

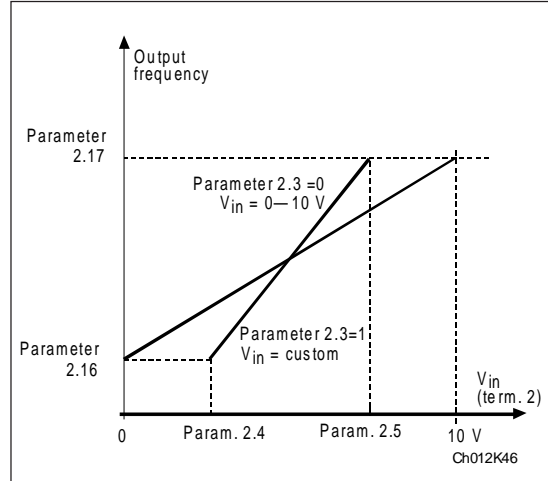

Figure 2.5-5 V_{in} no signal inversion.

Parameter 2.6 = 1, inversion of analog V_{in} signal
 max. V_{in} signal = minimum set speed
 min. V_{in} signal = maximum set speed

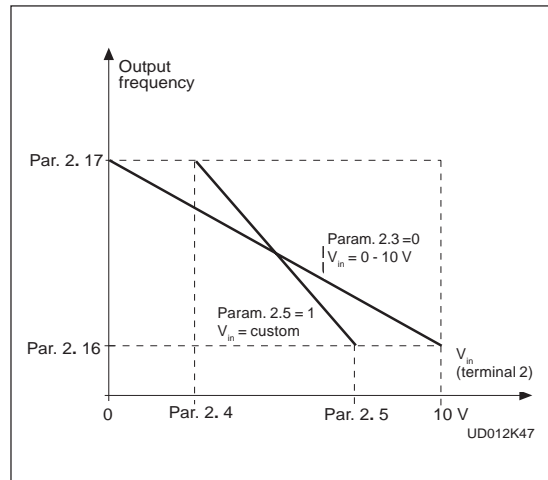

Figure 2.5-6 V_{in} signal inversion.

2.7 V_{in} signal filter time

Filters out disturbances from the incoming analog V_{in} signal. A long filtering time makes drive response slower. See figure 2.5-7.

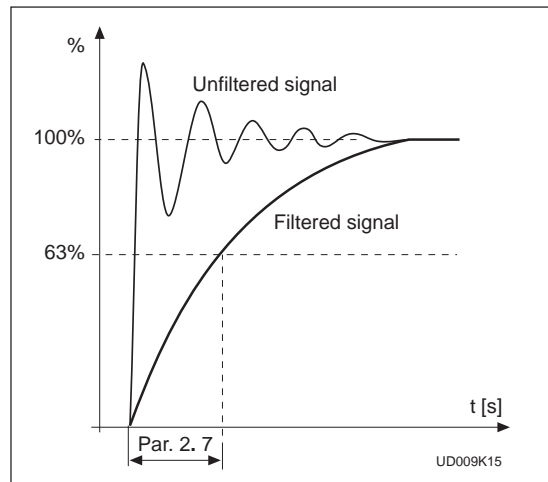

Figure 2.5-7 V_{in} signal filtering



2.8 Analog input I_{in} signal range

- 0 = 0—20 mA
- 1 = 4—20 mA
- 2 = Custom signal span

See figure 2.5-8.

2.9 Analog input I_{in} custom setting minimum/maximum**2.10**

With these parameters you can scale the input current to correspond to a minimum and maximum frequency range. See figure 2.5-8.

Minimum setting:

Set the I_{in} signal to its minimum level, select parameter 2. 9, press the Enter button

Maximum setting:

Set the I_{in} signal to its maximum level, select parameter 2. 10, press the Enter button

Note! The parameter values can only be set with this procedure (not with arrow up/arrow down buttons).

2.11 Analog input I_{in} inversion

I_{in} is source A frequency reference, par. 1. 5 = 0 (default)

Parameter 2. 11 = 0, no inversion of I_{in} input

Parameter 2. 11 = 1, inversion of I_{in} input. See figure 2.5-9.

max. I_{in} signal = minimum set speed

min. I_{in} signal = maximum set speed

2.12 Analog input I_{in} filter time

Filters out disturbances from the incoming analog I_{in} signal. A long filtering time makes drive response slower.

See figure 2.5-10.

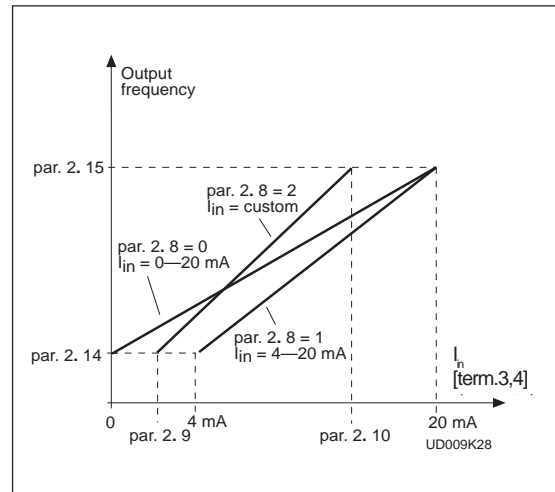

Figure 2.5-8 Analog input I_{in} scaling.

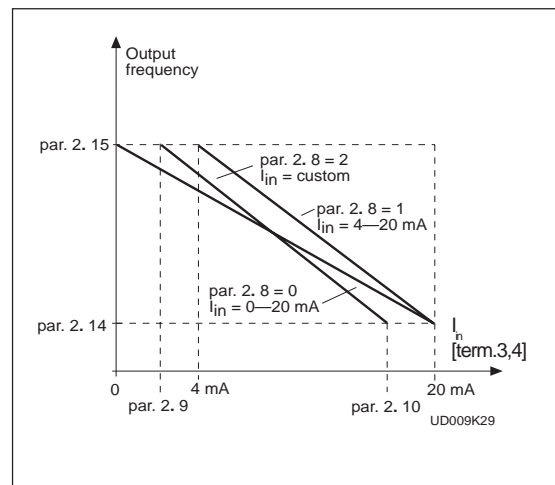

Figure 2.5-9 I_{in} signal inversion.

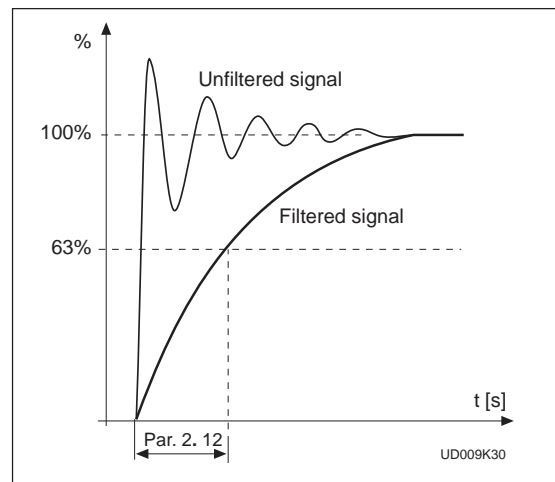

Figure 2.5-10 Analog input I_{in} filter time.

2

2.13 Source B Start/Stop logic selection

See parameter 2.1, settings 0—3.

2.14, 2.15 Source A reference scaling, minimum value/maximum value

Setting limits: $0 < \text{par. 2.14} < \text{par. 2.15} < \text{par. 1.2}$.

If par. 2.15 = 0 scaling is set off. See figures 2.5-11 and 2.5-12.

(In the figures below voltage input V_{in} with signal range 0—10 V selected for source A reference)

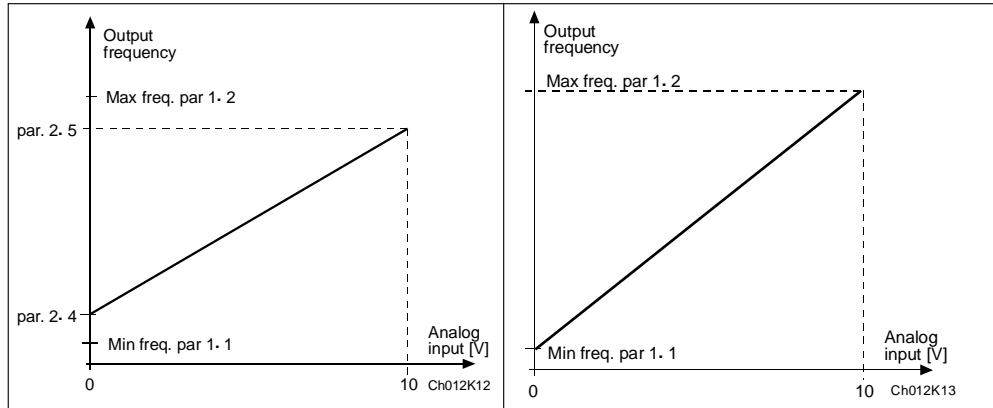

Figure 2.5-11 Reference scaling.

Figure 2.5-12 Reference scaling, par. 2.15 = 0.

2.16, 2.17 Source B reference scaling, minimum value/maximum value

See parameters 2.14 and 2.15.

2.18 Free analog input signal

Selection of input signal of a free analog input (an input not used for reference signal):

- 0 = Not in use
- 1 = Voltage signal V_{in}
- 2 = Current signal I_{in}

2.19 Free analog input signal function

Use this parameter to select a function for a free analog input signal:

- 0 = Function is not used
- 1 = Reducing motor current limit (par. 1.7)

This signal will adjust the maximum motor current between 0 and ,par. 1.7 set max. limit. See figure 2.5-13.

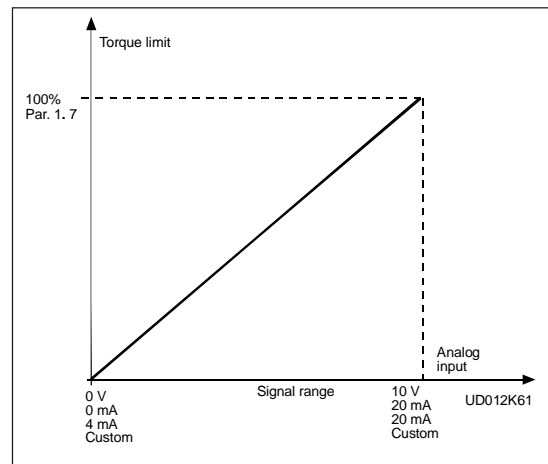

Figure 2.5-13 Scaling of max. motor current.



2 = Reducing DC brake current.

The DC braking current can be reduced with the free analog input signal between current $0.15 \times I_{nSV9}$ and the current set by parameter 4. 8. See figure 2.5-14.

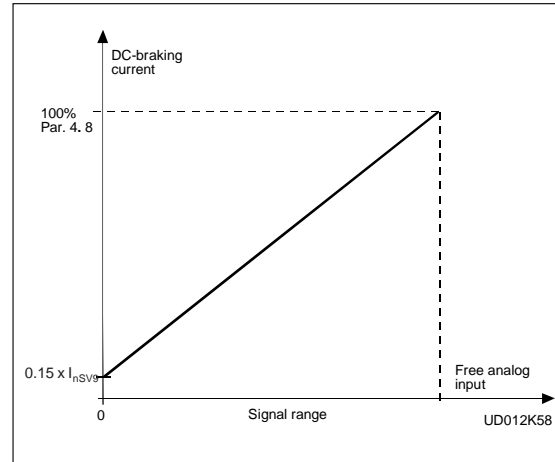

Figure 2.5-14 Reducing DC brake current.

3 = Reducing acceleration and deceleration times.

The acceleration and deceleration times can be reduced with the free analog input signal according to the following formulas:

Reduced time = set acc./deceler.time (par. 1. 3, 1. 4; 4. 3, 4. 4) divided by the factor R from figure 2.5-15.

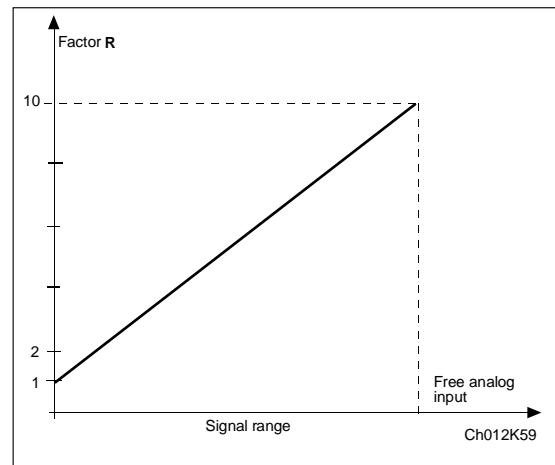

Figure 2.5-15 Reducing acceleration and deceleration times.

4 = Reducing torque supervision limit.

Torque supervision limit can be reduced with a free analog input signal between 0 and the set supervision limit (par. 3. 14). See figure 2.5-16.

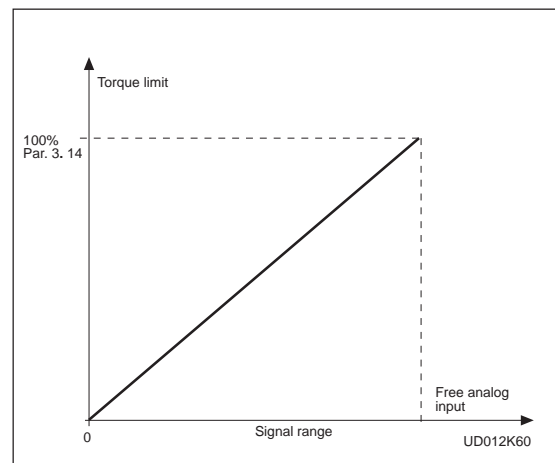

Figure 2.5-16 Reducing torque supervision limit

2

2.20 Motor potentiometer ramp time

Defines how fast the electronic motor potentiometer value changes.

3.1 Analog output Content

See table for parameter 3.1 on page 2-9.

3.2 Analog output filter time

Filters the analog output signal. See figure 2.5-17.

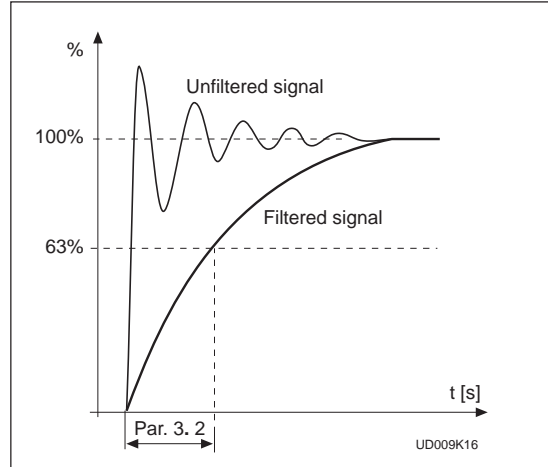

Figure 2.5-17 Analog output filtering.

3.3 Analog output invert

Inverts analog output signal:
 max. output signal = minimum set value
 min. output signal = maximum set value

3.4 Analog output minimum

Defines the signal minimum to be either 0 mA or 4 mA. See figure 2.5-19.

3.5 Analog output scale

Scaling factor for analog output. See figure 2.5-19.

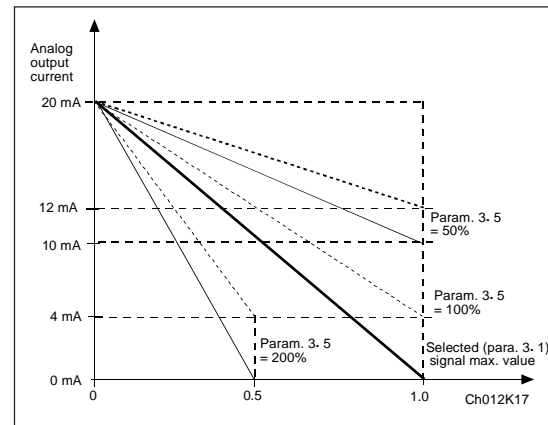

Figure 2.5-18 Analog output invert.

Signal	Max. value of the signal
Output frequency	Max. frequency (p. 1. 2)
Motor speed	Max. speed ($n_n \times f_{max} / f_n$)
Output current	$2 \times I_{nSV9}$
Motor torque	$2 \times T_{nMot}$
Motor power	$2 \times P_{nMot}$
Motor voltage	$100\% \times V_{nMot}$
DC-link volt.	1000 V

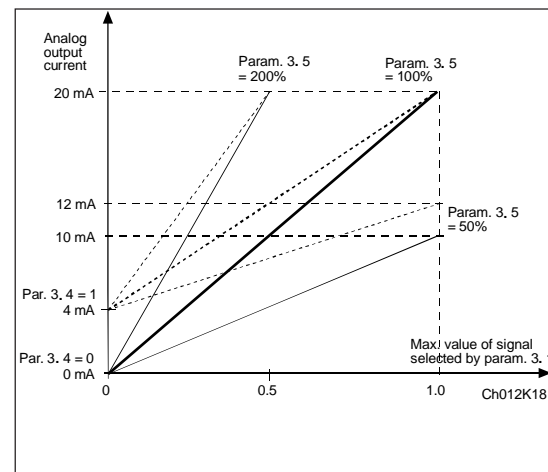

Figure 2.5-19 Analog output scale.



- 3.6 Digital output function
- 3.7 Relay output 1 function
- 3.8 Relay output 2 function

Setting value	Signal content
0 = Not used	Out of operation <u>Digital output DO1 sinks current and programmable relay (RO1, RO2) is activated when:</u>
1 = Ready	The drive is ready to operate
2 = Run	The drive operates (motor is running)
3 = Fault	A fault trip has occurred
4 = Fault inverted	A fault trip <u>has not</u> occurred
5 = SV9000 overheat warning	The heat-sink temperature exceeds +70°C
6 = External fault or warning	Fault or warning depending on parameter 7. 2
7 = Reference fault or warning	Fault or warning depending on parameter 7. 1 - if analog reference is 4—20 mA and signal is <4mA
8 = Warning	Always if a warning exists
9 = Reversed	The reverse command has been selected
10= Jog speed	Jog speed has been selected with digital input
11= At speed	The output frequency has reached the set reference
12= Motor regulator activated	Overvoltage or overcurrent regulator was activated
13= Output frequency supervision 1	The output frequency goes outside of the set supervision Low limit/ High limit (par. 3. 9 and 3. 10)
14 = Output frequency supervision 2	The output frequency goes outside of the set supervision Low limit/ High limit (par. 3. 11 and 3. 12)
15 = Torque limit supervision	The motor torque goes outside of the set supervision Low limit/ High limit (par. 3. 13 and 3. 14)
16 = Active reference limit supervision	Active reference goes outside of the set supervision Low limit/ High limit (par. 3. 15 and 3. 16)
17= External brake control	External brake ON/OFF control with programmable delay (par 3. 17 and 3. 18)
18= Control from I/O terminals	External control mode selected with prog. pushbutton #2
19= Drive temperature limit supervision	Temperature on drive is outside the set supervision limits (par. 3. 19 and 3. 20)
20= Unrequested rotation direction	Rotation direction of the motor shaft is different from the requested one
21= External brake control inverted	External brake ON/OFF control (par. 3.17 and 3.18), output active when brake control is OFF

Table 2.5-2 Output signals via DO1 and output relays RO1 and RO2.



3.9 Output frequency limit 1, supervision function**3.11 Output frequency limit 2, supervision function**

- 0 = No supervision
- 1 = Low limit supervision
- 2 = High limit supervision

If the output frequency goes under/over the set limit (3. 10, 3. 12) this function generates a warning message via the digital output DO1 or via a relay output RO1 or RO2 depending on the settings of the parameters 3. 6—3. 8.

3.10 Output frequency limit 1, supervision value**3.12 Output frequency limit 2, supervision value**

The frequency value to be supervised by the parameter 3. 9 (3. 11). See figure 2.5-20.

3.13 Torque limit , supervision function

- 0 = No supervision
- 1 = Low limit supervision
- 2 = High limit supervision

If the calculated torque value goes under/over the set limit (3.14) this function generates a warning message via the digital output DO1 or via a relay output RO1 or RO2 depending on the settings of the parameters 3. 6—3. 8.

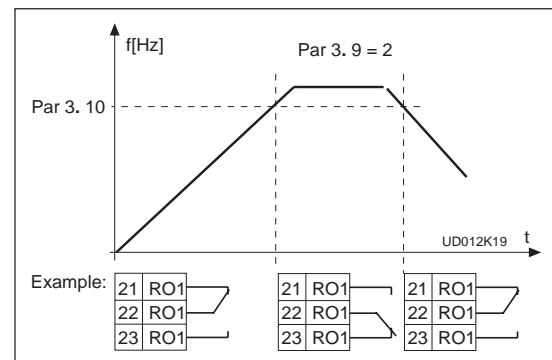

Figure 2.5-20 Output frequency supervision.

3.14 Torque limit , supervision value

The calculated torque value to be supervised by the parameter 3. 13. Torque supervision value can be reduced below the setpoint with a free analog input signal, see parameters 2. 18 and 2. 19.

3.15 Reference limit , supervision function

- 0 = No supervision
- 1 = Low limit supervision
- 2 = High limit supervision

If the reference value goes under/over the set limit (3. 16) this function generates a warning message via the digital output DO1 or via a relay output RO1 or RO2 depending on the settings of the parameters 3. 6—3. 8. The supervised reference is the current active reference. It can be source A or B reference depending on DIB6 input or panel reference if panel is the active control source.

3.16 Reference limit , supervision value

The frequency value to be supervised by the parameter 3. 15.



3. 17 External brake-off delay
 3. 18 External brake-on delay

The function of the external brake can be delayed from the start and stop control signals with these parameters. See figure 2.5-21.

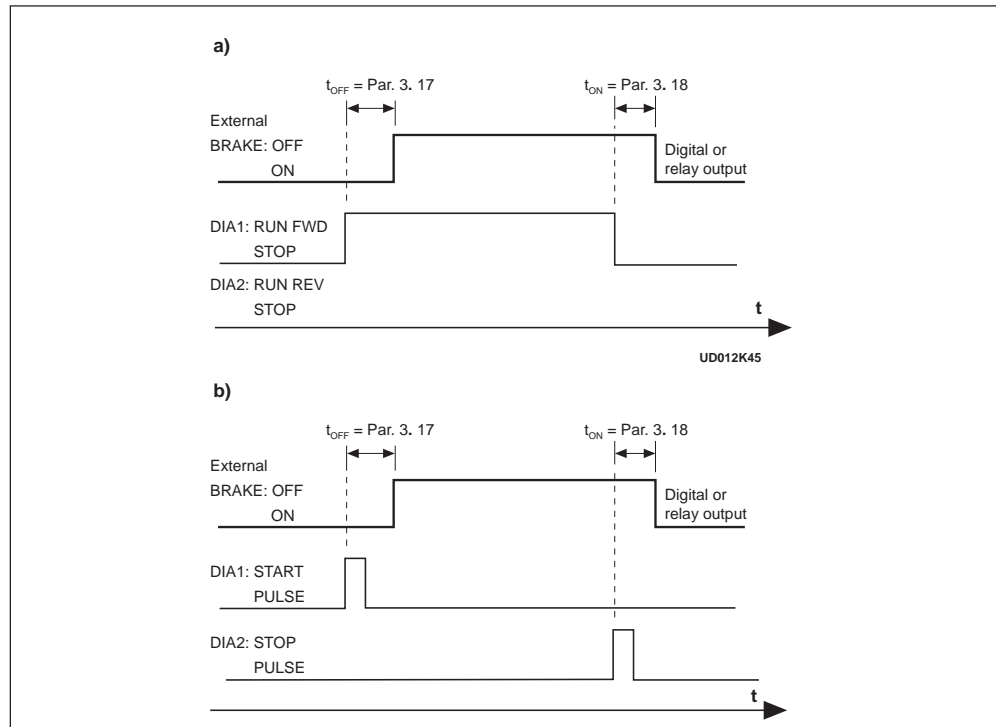

Figure 2.5-21 Ext. brake control: a) Start/Stop logic selection par 2. 1 = 0, 1 or 2
 b) Start/Stop logic selection par 2. 1 = 3.

The brake control signal can be programmed via the digital output DO1 or via one of the relay outputs RO1 and RO2, see parameters 3. 6—3. 8.

3. 19 Drive temperature limit supervision

- 0 = No supervision
- 1 = Low limit supervision
- 2 = High limit supervision

If temperature of the unit goes under/over the set limit (par. 3. 20) this function generates a warning message via the digital output DO1 and via a relay output RO1 or RO2 depending on the settings of the parameters 3. 6—3. 8.

3. 20 Drive temperature supervision limit value

The set temperature value to be supervised with the parameter 3. 19.

4.1 Acc/Dec ramp 1 shape**4.2 Acc/Dec ramp 2 shape**

The acceleration and deceleration ramp shape can be programmed with these parameters.

Setting the value = 0 gives you a linear ramp shape. The output frequency immediately follows the input with a ramp time set by parameters 1. 3, 1. 4 (4. 3, 4. 4 for Acc/Dec time 2).

Setting 0.1—10 seconds for 4. 1 (4. 2) causes an S-shaped ramp. The speed changes are smooth. Parameter 1. 3/ 1. 4 (4. 3/ 4. 4) determines the ramp time of the acceleration/deceleration in the middle of the curve. See figure 2.5-22.

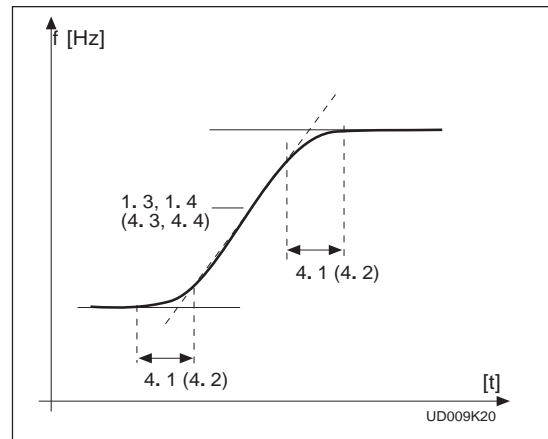

Figure 2.5-22 S-shaped acceleration/deceleration.

4.3 Acceleration time 2**4.4 Deceleration time 2**

These values correspond to the time required for the output frequency to accelerate from the set minimum frequency (par. 1. 1) to the set maximum frequency (par. 1. 2). With this parameter it is possible to set two different acceleration/deceleration times for one application. The active set can be selected with the programmable signal DIA3. See parameter 2. 2. Acceleration/deceleration times can be reduced with a free analog input signal. See parameters 2. 18 and 2. 19.

4.5 Brake chopper

- 0 = No brake chopper
- 1 = Brake chopper and brake resistor installed
- 2 = External brake chopper

When the drive is decelerating the motor, the energy stored in the inertia of the motor and the load is fed into the external brake resistor. If the brake resistor is selected correctly the drive is able to decelerate the load with a torque equal to that of acceleration. See the separate Brake resistor installation manual.

4.6 Start function

Ramp:

- 0** The drive starts from 0 Hz and accelerates to the set reference frequency within the set acceleration time. (Load inertia or starting friction may cause prolonged acceleration times).

Flying start:

- 1** The drive starts into a running motor by first finding the speed the motor is running at. Searching starts from the maximum frequency down until the actual frequency reached. The output frequency then accelerates/decelerates to the set reference value at a rate determined by the acceleration/deceleration ramp parameters.

Use this mode if the motor may be coasting when the start command is given. With the flying start it is possible to ride through short utility voltage interruptions.

4.7 Stop function

Coasting:

- 0** The motor coasts to an uncontrolled stop with the SV9000 off, after the Stop command.

Ramp:

- 1** After the Stop command, the speed of the motor is decelerated based on the deceleration ramp time parameter.

If the regenerated energy is high, it may be necessary to use an external braking resistor for faster deceleration.

4.8 DC braking current

Defines the current injected into the motor during DC braking.

The DC braking current can be reduced from the setpoint with a external free analog input signal, see parameters 2. 18 and 2. 19.

4.9 DC braking time at stop

Determines whether DC braking is ON or OFF. It also determines the braking duration time of the DC-brake when the motor is stopping. The function of the DC-brake depends on the stop function, parameter 4. 7. See figure 2.5-23.

- 0** DC-brake is not used
- >0** DC-brake is in use and its function depends of the stop function, (parameter 4. 7), The time is set by the value of parameter 4. 9:

Stop-function = 0 (coasting):

After the stop command, the motor will coast to a stop with the SV9000 off.

With DC-injection, the motor can be electrically stopped in the shortest possible time, without using an optional external braking resistor.

The braking time is scaled according to the frequency when the DC- braking starts. If the frequency is \geq nominal frequency of the motor (par. 1.11), the value of parameter 4.9 determines the braking time. When the frequency is \leq 10% of the nominal, the braking time is 10% of the set value of parameter 4.9. See figure 2.5-13.

Stop-function = 1 (ramp):

After a Stop command, the speed of the motor is reduced based on the deceleration ramp parameter. If no regeneration occurs due to load inertia DC-braking starts at a speed defined by parameter 4. 10.

2

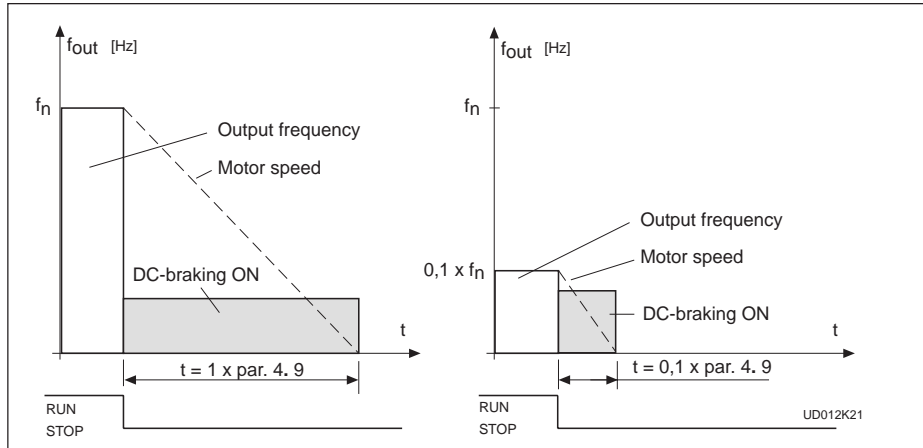

Figure 2.5-23 DC-braking time when par. 4. 7 = 0.

The braking time is defined by par. 4. 9. If the load has a high inertia, use an external braking resistor for faster deceleration. See figure 2.5-24.

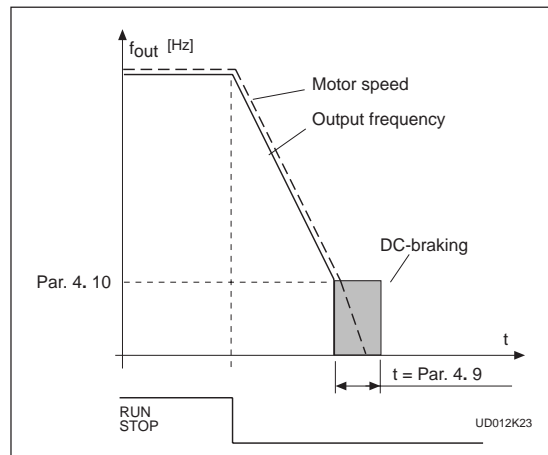

Figure 2.5-24 DC-braking time when par. 4. 7 = 1.

4. 10 Execute frequency of DC-brake during ramp Stop

See figure 2.5-24.

4. 11 DC-brake time at start

- 0 DC-brake is not used
- >0 The DC-brake is activated by the start command given. This parameter defines the time before the brake is released. After the brake is released the output frequency increases according to the set start function parameter 4. 6 and the acceleration parameters (1. 3, 4. 1 or 4. 2, 4. 3). See figure 2.5-25.

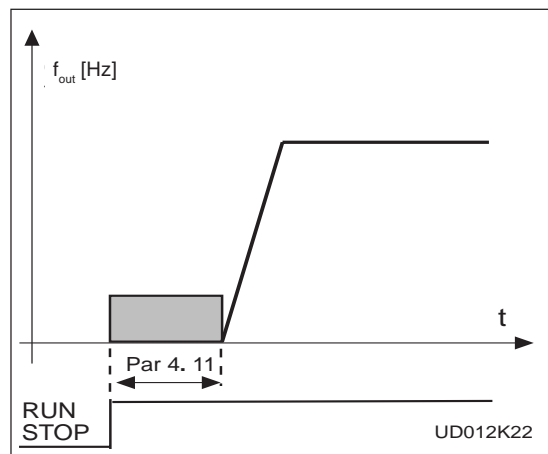

Figure 2.5-25 DC-braking time at start.



4. 12 Jog speed reference

This parameter value defines the jog speed if the DIA3 digital input is programmed for Jog and is selected. See parameter 2. 2.

5. 1- 5.6 Prohibit frequency area Low limit/High limit

In some systems it may be necessary to avoid certain frequencies because of mechanical resonance problems.

With these parameters it is possible to set limits for three "skip frequency" regions between 0 Hz and 500 Hz. The accuracy of the setting is 0.1 Hz. See figure 2.5-26

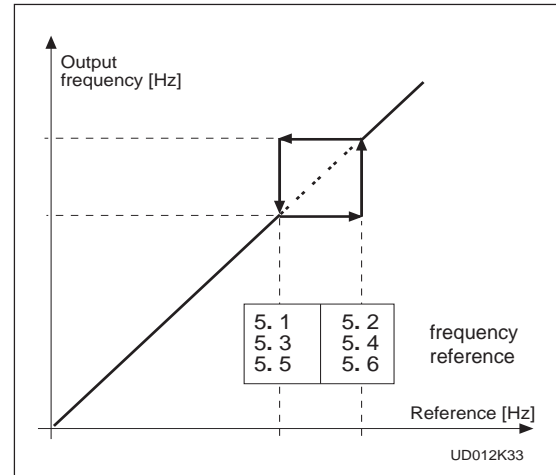

Figure 2.5-26 Example of prohibit frequency area setting.

2

6. 1 Motor control mode

0 = Frequency control: The I/O terminal and panel references are frequency references and the drive controls the output frequency (output freq. resolution 0.01 Hz)

1 = Speed control: (sensorless vector) The I/O terminal and panel references are speed references and the drive controls the motor speed (control accuracy $\pm 0.5\%$).

6. 2 Switching frequency

Motor noise can be minimized by using a high switching frequency. Increasing the switching frequency reduces the current capacity of the SV9000.

Before changing the frequency from the factory default 10 kHz (3.6 kHz >40 Hp) check the drive derating in the curves shown in figures 5.2-2 and 5.2-3 in chapter 5.2 of the User's Manual.

6. 3 Field weakening point

6. 4 Voltage at the field weakening point

The field weakening point is the output frequency where the output voltage reaches the set maximum value (parameter 6. 4). Above that frequency the output voltage remains constant at the set maximum value. Below that frequency the output voltage depends on the setting of the V/Hz curve parameters 1. 8, 1. 9, 6. 5, 6. 6 and 6. 7. See figure 1.5-16.

When the parameters 1. 10 and 1. 11, nominal voltage and nominal frequency of the motor, are set, parameters 6. 3 and 6. 4 are also set automatically to the same values. If you need different values for the field weakening point and the maximum output voltage, change these parameters after setting parameters 1. 10 and 1. 11.



6.5 V/Hz curve, middle point frequency

If the programmable V/Hz curve has been selected with parameter 1.8, this parameter defines the middle frequency point of the curve. See figure 2.5-27.

6.6 V/Hz curve, middle point voltage

If the programmable V/Hz curve has been selected with parameter 1.8, this parameter defines the middle point voltage (% of motor nominal voltage) of the curve. See figure 2.5-27.

6.7 Output voltage at zero frequency

If the programmable V/Hz curve has been selected with parameter 1.8, this parameter defines the zero frequency voltage (% of motor nominal voltage) of the curve. See figure 2.5-27.

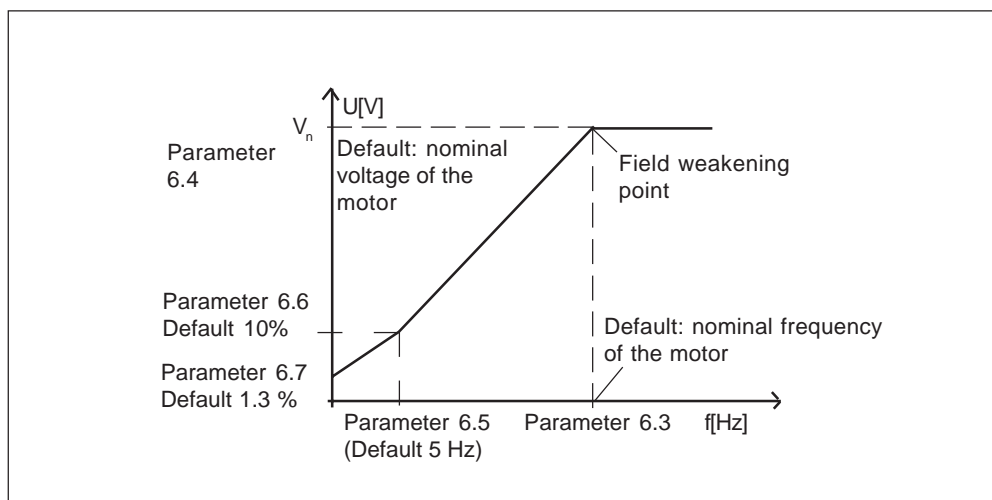

Figure 2.5-27 Programmable V/Hz curve.

6.8 Overvoltage controller**6.9 Undervoltage controller**

These parameters allow the over/undervoltage controllers to be switched ON or OFF. This may be useful in cases where the utility supply voltage varies more than -15%—+10% and the application requires a constant speed. If the controllers are ON, they will change the motor speed in over/undervoltage cases. Overvoltage = faster, undervoltage = slower.

Over/undervoltage trips may occur when controllers are not used.

7.1 Response to the reference fault

- 0 = No response
- 1 = Warning
- 2 = Fault, stop mode after fault according to parameter 4.7
- 3 = Fault, always coasting stop mode after fault detection

A warning or a fault action and message is generated if the 4—20 mA reference signal is used and the signal falls below 4 mA. The information can also be programmed via digital output DO1 and via relay outputs RO1 and RO2.



7.2 Response to external fault

- 0 = No response
- 1 = Warning
- 2 = Fault, stop mode after fault according to parameter 4.7
- 3 = Fault, always coasting stop mode after fault detection

A warning or a fault action and message is generated from the external fault signal on digital input DIA3. The information can also be programmed into digital output DO1 and into relay outputs RO1 and RO2.

7.3 Phase supervision of the motor

- 0 = No action
- 2 = Fault

Phase supervision of the motor ensures that the motor phases have approximately equal current.

7.4 Ground fault protection

- 0 = No action
- 2 = Fault message

Ground fault protection ensures that the sum of the motor phase currents is zero. The standard overcurrent protection is always present and protects the frequency converter from ground faults with high current levels.

Parameters 7.5—7.9 Motor thermal protection

General

Motor thermal protection protects the motor from overheating. The SV9000 drive is capable of supplying higher than nominal current to the motor. If the load requires this high current there is a risk that motor will be thermally overloaded. This is true especially at low frequencies. With low frequencies the cooling effect of the motor fan is reduced and the capacity of the motor is reduced. If the motor is equipped with a separately powered external fan, the load derating at low speed is small.

Motor thermal protection is based on a calculated model and it uses the output current of the drive to determine the load on the motor. When the motor is powered from the drive, the calculated model uses the heatsink temperature to determine the initial thermal state of the motor. The calculated model assumes that the ambient temperature of the motor is 40°C.

Motor thermal protection can be adjusted by setting several parameters. The thermal current I_T specifies the load current above which the motor is overloaded. This current level is a function of the output frequency. The curve for I_T is set with parameters 7.6, 7.7 and 7.9. See figure 2.5-28. The default values of these parameters are set from the motor nameplate data.

With the output current at I_T the thermal state will reach the nominal value (100%). The thermal state changes by the square of the current. With output current at 75% of I_T the thermal state will reach 56% and with output current at 120% of I_T the thermal stage would reach 144%. The function will trip the drive (refer par. 7.5) if the thermal state reaches a value of 105%. The response time of the thermal model is determined by the time constant parameter 7.8. The larger the motor, the longer it takes to reach the final temperature.



The thermal state of the motor can be monitored through the display. Refer to the table for monitoring items. (User's Manual, table 7.3-1).



CAUTION! *The calculated model does not protect the motor if the cooling of the motor is reduced either by blocking the airflow or due to dust or dirt.*

7.5 Motor thermal protection

Operation:

- 0 = Not in use
- 1 = Warning
- 2 = Trip function

Tripping and warning will give a display indication with the same message code. If tripping is selected the drive will stop and activate the fault stage.

Deactivating the protection by setting this parameter to 0, will reset the thermal stage of the motor to 0%.

7.6 Motor thermal protection, break point current

This current can be set between 50.0—150.0% $\times I_{nMotor}$.

This parameter sets the value for thermal current at frequencies above the break point on the thermal current curve. Refer to the figure 2.5-28.

The value is set as a percentage of the motor nameplate nominal current, parameter 1.13, not the drive's nominal output current.

The motor's nominal current is the current which the motor can withstand in direct online use without being overheated.

If parameter 1.13 is adjusted, this parameter is automatically restored to the default value.

Setting this parameter (or parameter 1.13) does not affect the maximum output current of the drive. Parameter 1.7 alone determines the maximum output current of the drive.

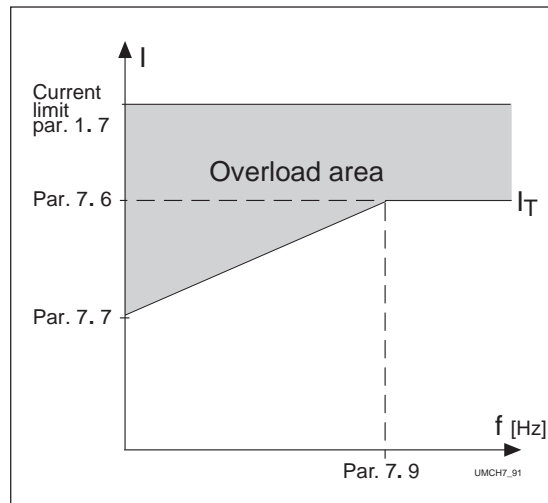

Figure 2.5-28 Motor thermal current, I_T curve.

7.7 Motor thermal protection, zero frequency current

This current can be set between 10.0—150.0% $\times I_{nMotor}$.

This parameter sets the value for thermal current at zero frequency. Refer to the figure 2.5-28.

The default value is set assuming that there is no external fan cooling the motor. If an external fan is used this parameter can be set to 90% (or higher).

The value is set as a percentage of the motor's nominal nameplate current, parameter 1. 13, not the drive's nominal output current. The motor's nominal current is the current which the motor can stand in direct on-line use without being overheated.

If you change parameter 1. 13, this parameter is automatically restored to the default value.

Setting this parameter (or parameter 1. 13) does not affect to the maximum output current of the drive. Parameter 1. 7 alone determines the maximum output current of the drive.

7.8 Motor thermal protection, time constant

This time can be set between 0.5—300 minutes.

This is the thermal time constant of the motor. The larger the motor the greater the time constant. The time constant is defined as the time that it takes the calculated thermal stage to reach 63% of its final value.

The motor thermal time is specific to a motor design and it varies between different motor manufacturers.

The default value for the time constant is calculated based on the motor nameplate data from parameters 1. 12 and 1. 13. If either of these parameters is reset, then this parameter is set to default value.

If the motor's t_6 -time is known (given by the motor manufacturer) the time constant parameter could be set based on t_6 -time. As a rule of thumb, the motor thermal time constant in minutes equals to $2xt_6$ (t_6 in seconds is the time a motor can safely operate at six times the rated current). If the drive is stopped the time constant is internally increased to three times the set parameter value. Cooling in the stop stage is based on convection with an increased time constant

7.9 Motor thermal protection, break point frequency

This frequency can be set between 10—500 Hz.

This is the frequency break point of the thermal current curve. With frequencies above this point the thermal capacity of the motor is assumed to be constant. Refer to the figure 2.5-28.

The default value is based on the motor's nameplate data, parameter 1. 11. It is 35 Hz for a 50 Hz motor and 42 Hz for a 60 Hz motor. More generally it is 70% of the frequency at the field weakening point (parameter 6. 3). Changing either parameter 1. 11 or 6. 3, will restore this parameter to its default value.

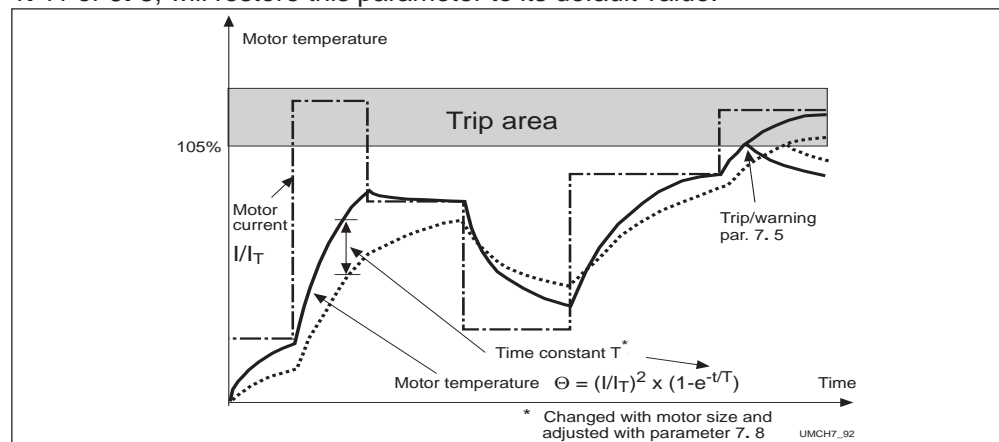

Figure 2.5-29

Calculating motor temperature.

Parameters 7. 10— 7. 13, Stall protection

General

Motor stall protection protects the motor from short time overload situations like a stalled shaft. The reaction time of stall protection can be set shorter than with motor thermal protection. The stall state is defined with two parameters, 7.11, Stall Current and 7.13., Stall Frequency. If the current is higher than the set limit and output frequency is lower than the set limit the stall state is true. There is no true detection of shaft rotation. Stall protection is a type of overcurrent protection.

2

7. 10 Stall protection

Operation:

- 0 = Not in use
- 1 = Warning
- 2 = Trip function

Tripping and warning will give a display indication with the same message code. If tripping is set on, the drive will stop and generate a fault. Deactivating the stall protection by setting the parameter to 0 will reset the stall time counter to zero.

7. 11 Stall current limit

The current can be set between 0.0—200% $\times I_{nMotor}$.

In a stall the current has to be above this limit. See figure 2.5-30. The value is set as a percentage of the motor name-plate nominal current, parameter 1. 13. If parameter 1. 13 is adjusted, this parameter is automatically restored to its default value.

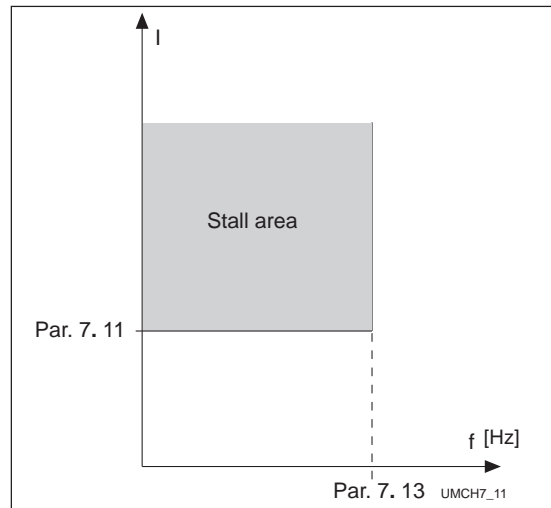

Figure 2.5-30 Setting the stall characteristics.

7. 12 Stall time

The time can be set between 2.0—120 s.

This is the maximum allowed time for a stall. There is an internal up/down counter to count the stall time. See figure 2.5-31. If the stall time counter value goes above this limit, this protection will cause a trip (refer to the parameter 7. 10).

7. 13 Maximum stall frequency

This frequency can be set between 1— f_{max} (param. 1. 2). In the stall state the output frequency has to be smaller than this limit. See figure 2.5-30.

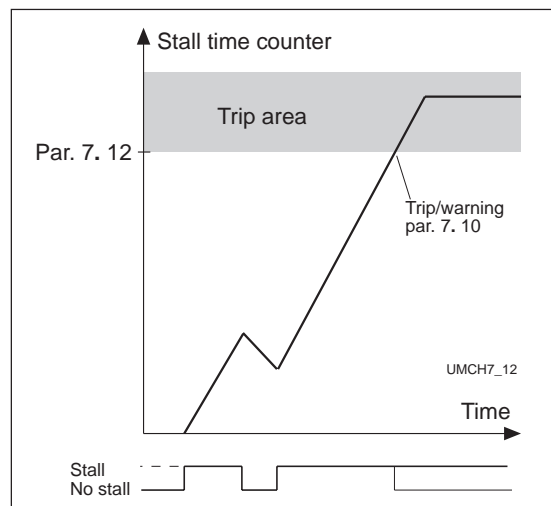

Figure 2.5-31 Counting the stall time.



Parameters 7. 14— 7. 17, Underload protection

General

The purpose of motor underload protection is to ensure there is a load on the motor while the drive is running. If the motor load is reduced, there might be a problem in the process, e.g. broken belt or dry pump.

Motor underload protection can be adjusted by setting the underload curve with parameters 7. 15 and 7. 16. The underload curve is a squared curve set between zero frequency and the field weakening point. The protection is not active below 5Hz (the underload counter value is stopped). See figure 2.5-32.

The torque values for setting the underload curve are set with percentage values which refer to the nominal torque of the motor. The motor's nameplate data, parameter 1.13, the motor's nominal current and the drive's nominal current I_{CT} are used to create the scaling ratio for the internal torque value. If other than a standard motor is used with the drive, the accuracy of the torque calculation is decreased.

2

7. 14 Underload protection

Operation:

- 0 = Not in use
- 1 = Warning message
- 2 = Fault message

Tripping and warning will give a display indication with the same message code. If tripping is set active the drive will stop and activate the fault stage.

Deactivating the protection, by setting this parameter to 0, will reset the underload time counter to zero.

7. 15 Underload protection, field weakening area load

The torque limit can be set between 20.0—150 % x T_{nMotor} .

This parameter is the value for the minimum allowed torque when the output frequency is above the field weakening point. Refer to the figure 2.5-32.

If parameter 1. 13 is adjusted, this parameter is automatically restored to its default value.

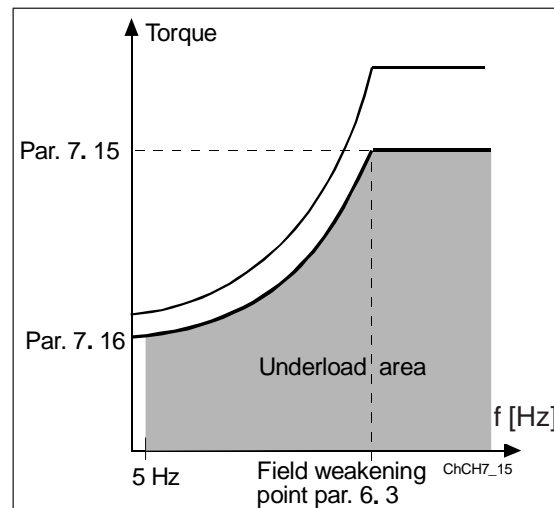

Figure 2.5-32 Setting of minimum load.

7. 16 Underload protection, zero frequency load

The torque limit can be set between 10.0—150 % x T_{nMotor} .

This parameter is the value for the minimum allowed torque with zero frequency. See figure 2.5-32. If parameter 1. 13 is adjusted, this parameter is automatically restored to its default value.



7.17 Underload time

This time can be set between 2.0—600.0 s.

This is the maximum allowed time for an underload state. There is an internal up/down counter to accumulate the underload time. See figure 2.5-33.

If the underload counter value goes above this limit, the underload protection will cause a trip (refer to the parameter 7.14). If the drive is stopped the underload counter is reset to zero.

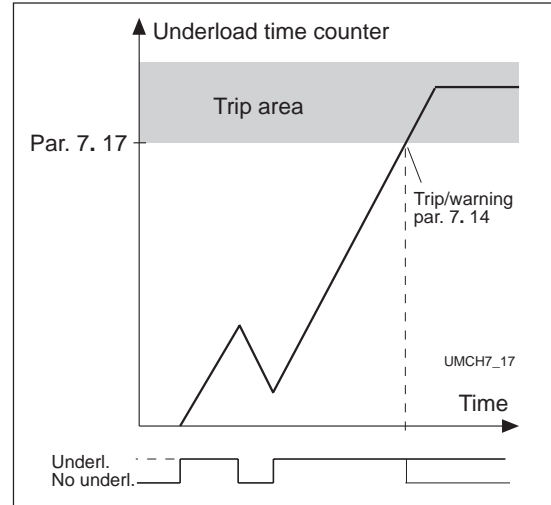

Figure 2.5-33 Counting the underload time.

8.1 Automatic restart: number of tries

8.2 Automatic restart: trial time

The Automatic restart function restarts the drive after the faults selected with parameters 8.4—8.8. The Start type for Automatic restart is selected with parameter 8.3. See figure 2.5-34.

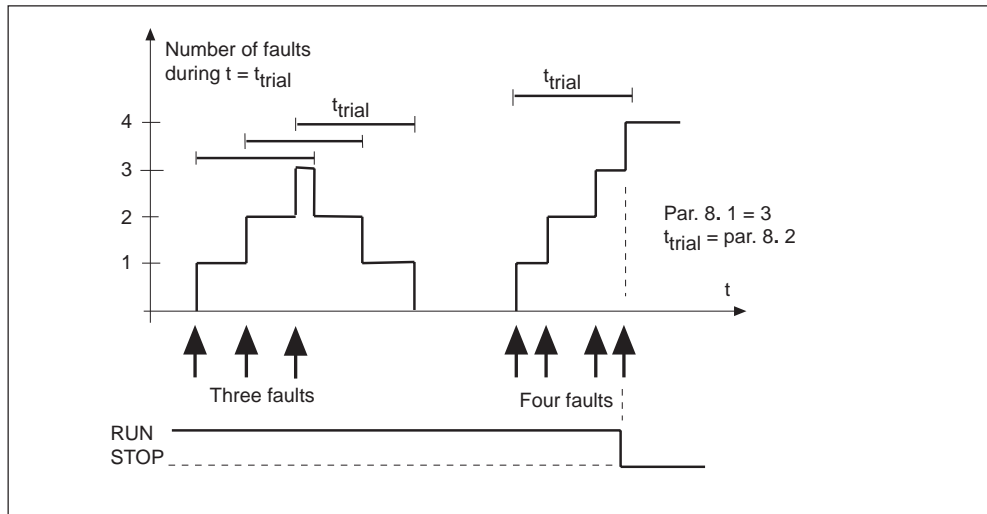

Figure 2.5-34 Automatic restart.

Parameter 8.1 determines how many automatic restarts can be made during the trial time set by the parameter 8.2.

The count time starts from the first autorestart. If the number of restarts does not exceed the value of parameter 8.1 during the trial time, the count is cleared after the trial time has elapsed. The next fault starts the counting again.



8.3 Automatic restart, start function

The parameter defines the start mode:

- 0 = Start with ramp
- 1 = Flying start, see parameter 4. 6.

8.4 Automatic restart after undervoltage

- 0 = No automatic restart after undervoltage fault
- 1 = Automatic restart after undervoltage fault condition returns to normal.
(DC-link voltage returns to the normal level)

8.5 Automatic restart after overvoltage

- 0 = No automatic restart after overvoltage fault
- 1 = Automatic restart after overvoltage fault condition returns to normal
(DC-link voltage returns to the normal level)

8.6 Automatic restart after overcurrent

- 0 = No automatic restart after overcurrent fault
- 1 = Automatic restart after overcurrent faults

8.7 Automatic restart after reference fault

- 0 = No automatic restart after reference fault
- 1 = Automatic restart after analog current reference signal (4—20 mA)
returns to the normal level (≥ 4 mA)

8.8 Automatic restart after over-/undertemperature fault

- 0 = No automatic restart after temperature fault
- 1 = Automatic restart after heatsink temperature has returned to its normal
level between -10°C — $+75^{\circ}\text{C}$.

MULTI-STEP SPEED CONTROL APPLICATION

(par. 0.1 = 4)

CONTENTS

- 3 Multi-step Speed Control Appl. 3-1**
 - 3.1 General 3-2
 - 3.2 Control I/O 3-2
 - 3.3 Control signal logic 3-3
 - 3.4 Parameters Group 1 3-4
 - 3.4.1 Parameter table 3-4
 - 3.4.2 Description of Group1 par ... 3-5
 - 3.5 Special parameters, Groups 2—8 .. 3-8
 - 3.5.1 Parameter tables 3-8
 - 3.5.2 Description of Groups. 3-14



3.1 GENERAL

The Multi-step Speed Control Application can be used in applications where fixed speeds are needed. In total 9 different speeds can be programmed: one basic speed, 7 multi-step speeds and one jog speed. The speed steps are selected with digital signals DIB4, DIB5 and DIB6. If jog speed is used, DIA3 can be

programmed from fault reset to jog speed select.

The basic speed reference can be either a voltage or a current signal via analog input terminals (2/3 or 4/5). The other analog input can be programmed for other purposes

All outputs are freely programmable.

*** NOTE!** Remember to connect the CMA and CMB inputs.

3.2 CONTROL I/O

Reference potentiometer 1 - 10 kΩ

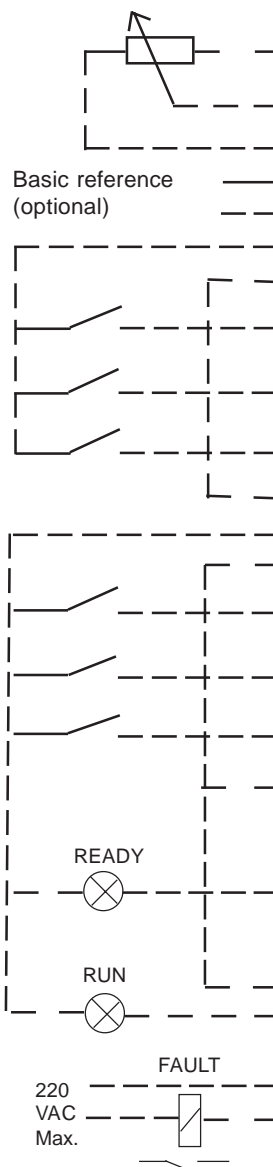

Terminal	Signal	Description
1	+10V _{ref}	Reference output Voltage for a potentiometer, etc.
2	V _{in+}	Input for reference voltage Basic reference (programmable), range 0—10 V DC
3	GND	I/O ground Ground for reference and controls
4	I _{in+}	Input for reference current Basic reference (programmable), range 0—20 mA
5	I _{in-}	
6	+24V	Control voltage output Voltage for switches, etc. max. 0.1 A
7	GND	Control voltage ground Ground for reference and controls
8	DIA1	Start forward (Programmable) Contact closed = start forward
9	DIA2	Start reverse (Programmable) Contact closed = start reverse
10	DIA3	Fault reset (Programmable) Contact open = no action Contact closed = fault reset
11	CMA	Common for DIA1—DIA3 Connect to GND or + 24V
12	+24V	Control voltage output Voltage for switches, (same as #6)
13	GND	I/O ground Ground for reference and controls
14	DIB4	Multi-step speed select 1 sel 1 sel 2 sel 3 0 0 0 basic speed 1 0 0 speed 1 0 1 0 speed 2 --- --- 1 1 1 speed 7
15	DIB5	
16	DIB6	
17	CMB	Common for DIB4—DIB6 Connect to GND or + 24V
18	I _{out+}	Analog output Programmable (par. 3. 1)
19	I _{out-}	Output frequency Range 0—20 mA/R _L max. 500 Ω
20	DO1	Digital output READY Programmable (par. 3. 6) Open collector, I _L ≤50 mA, V _{CE} ≤48 VDC
21	RO1	Relay output 1 RUN
22	RO1	
23	RO1	
24	RO2	Relay output 2 FAULT Programmable (par. 3. 8)
25	RO2	
26	RO2	

Figure 3.2-1 Default I/O configuration and connection example of the Multi-step speed Control Application.

3



3.3 Control signal logic

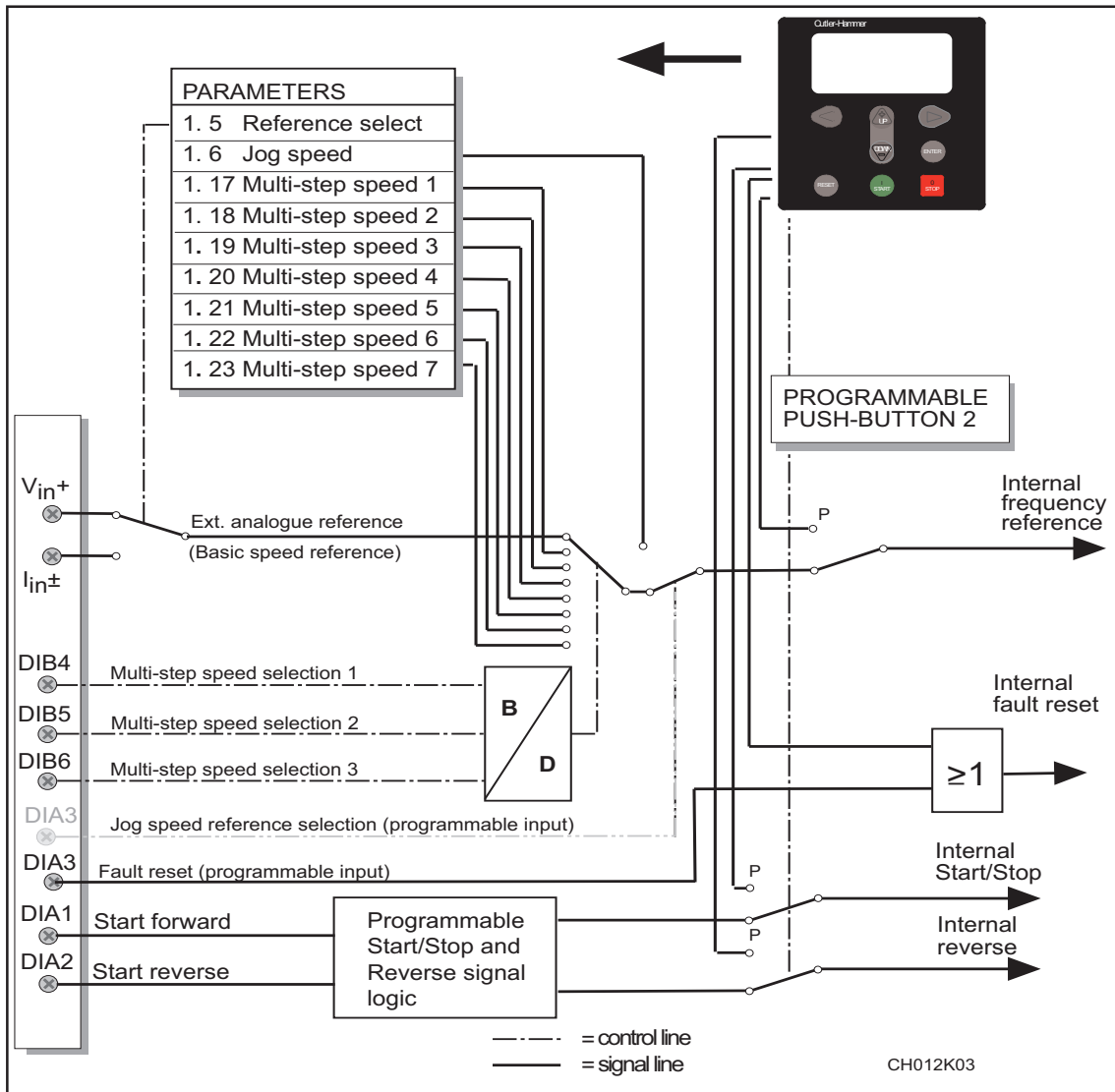









3

Figure 3.3-1 Control signal logic of the Multi-step Speed Control Application. Switch positions shown are based on the factory settings.



3.4 Basic parameters, Group 1

Code	Parameter	Range	Step	Default	Custom	Description	Page
1.1	Minimum frequency	0— f_{max}	1 Hz	0 Hz			3-5
1.2	Maximum frequency	f_{min} -120/500Hz	1 Hz	60 Hz		*	3-5
1.3	Acceleration time 1	0.1—3000.0 s	0.1 s	3.0 s		Time from f_{min} (1.1) to f_{max} (1.2)	3-5
1.4	Deceleration time 1	0.1—3000.0 s	0.1 s	3.0 s		Time from f_{max} (1.2) to f_{min} (1.1)	3-5
1.5	Basic reference selection 	0—1	1	0		0 = Analog voltage input (term.2) 1 = Analog current input (term.4)	3-5
1.6	Jog speed reference	f_{min} — f_{max} (1.1) (1.2)	0.1 Hz	5.0 Hz			3-5
1.7	Current limit	0.1—2.5 x $I_{n SV9}$	0.1 A	1.5 x $I_{n SV9}$		Output current limit [A] of the unit	3-5
1.8	V/Hz ratio selection 	0—2	1	0		0 = Linear 1 = Squared 2 = Programmable V/Hz ratio	3-6
1.9	V/Hz optimisation 	0—1	1	0		0 = None 1 = Automatic torque boost	3-7
1.10	Nominal voltage of the motor 	180—690 V	1 V	230 V 380 V 480 V 575 V		Voltage code 2 Voltage code 4 Voltage code 5 Voltage code 6	3-7
1.11	Nominal frequency of the motor 	30—500 Hz	1 Hz	60 Hz		f_n from the nameplate of the motor	3-7
1.12	Nominal speed of the motor 	1—20000 rpm	1 rpm	1720 rpm **		n_n from the nameplate of the motor	3-7
1.13	Nominal current of the motor 	2.5 x $I_{n SV9}$	0,1 A	$I_{n SV9}$		I_n from the nameplate of the motor	3-7
1.14	Supply voltage 	208—240		230 V		Voltage code 2	3-7
		380—440		380 V		Voltage code 4	
		380—500		480 V		Voltage code 5	
		525—690		575 V		Voltage code 6	
1.15	Parameter conceal	0—1	1	0		Visibility of the parameters: 0 = all parameter groups visible 1 = only group 1 is visible	3-7
1.16	Parameter value lock	0—1	1	0		Disables parameter changes: 0 = changes enabled 1 = changes disabled	3-7

Note!  = Parameter value can be changed only when the frequency converter is stopped.

* If 1.2 > motor synchr. speed, check suitability for motor and drive system
Selecting 120/500 Hz range see page 3-5.

** Default value for a four pole motor and a nominal size SV9000.



Code	Parameter	Range	Step	Default	Custom	Description	Page
1. 17	Multi-step speed reference 1	f_{min} — f_{max} (1. 1) (1. 2)	0.1 Hz	10.0 Hz			3-7
1. 18	Multi-step speed reference 2	f_{min} — f_{max} (1. 1) (1. 2)	0.1 Hz	15.0 Hz			3-7
1. 19	Multi-step speed reference 3	f_{min} — f_{max} (1. 1) (1. 2)	0.1 Hz	20.0 Hz			3-7
1. 20	Multi-step speed reference 4	f_{min} — f_{max} (1. 1) (1. 2)	0.1 Hz	25.0 Hz			3-7
1. 21	Multi-step speed reference 5	f_{min} — f_{max} (1. 1) (1. 2)	0.1 Hz	30.0 Hz			3-7
1. 22	Multi-step speed reference 6	f_{min} — f_{max} (1. 1) (1. 2)	0.1 Hz	40.0 Hz			3-7
1. 23	Multi-step speed reference 7	f_{min} — f_{max} (1. 1) (1. 2)	0.1 Hz	50.0 Hz			3-7

Table 3.4-1 Group 1 basic parameters.

3.4.2 Description of Group 1 parameters

1. 1, 1. 2 Minimum/maximum frequency

Defines the frequency limits of the SV9000.

The default maximum value for parameters 1. 1 and 1. 2 is 120 Hz. By setting 1. 2 = 120 Hz in the when the drive is stopped (RUN indicator not lit) parameters 1. 1 and 1. 2 are changed to 500 Hz. At the same time the resolution of the panel reference is changed from 0.01 Hz to 0.1 Hz.

Changing the max. value from 500 Hz to 120 Hz is done by setting parameter 1. 2 to 119 Hz while the drive is stopped.

1. 3, 1. 4 Acceleration time 1, deceleration time 1:

These limits correspond to the time required for the output frequency to accelerate from the set minimum frequency (par. 1. 1) to the set maximum frequency (par. 1. 2). Acceleration/deceleration times can be reduced with a free analog input signal, see parameters 2. 18 and 2. 19.

1. 5 Basic reference selection

- 0: Analog voltage reference from terminals 2—3, e.g. a potentiometer
- 1: Analog current reference from terminals 4—5, e.g. a transducer

1. 6 Jog speed reference

The value of this parameter defines the jog speed selected with the DIA3 digital input which if it is programmed for Jog speed. See parameter 2. 2.

Parameter value is automatically limited between minimum and maximum frequency (par 1. 1, 1. 2)

1. 7 Current limit

This parameter determines the maximum motor current that the SV9000 will provide short term. Current limit can be set lower with a free analog input signal, see parameters 2. 18 and 2. 19.



1.8 V/Hz ratio selection

Linear: The voltage of the motor changes linearly with the frequency in the constant flux area from 0 Hz to the field weakening point (par. 6. 3) where a constant voltage (nominal vaue) is supplied to the motor. See figure 3.4-1.

0

A linear V/Hz ratio should be used in constant torque applications

This default setting should be used if there is no special requirement for another setting.

Squared: The voltage of the motor changes following a squared curve form with the frequency in the area from 0 Hz to the field weakening point (par. 6. 3), where the nominal voltage is supplied to the motor. See figure 3.4-1.

1

The motor runs undermagnetized below the field weakening point and produces less torque and electromechanical noise. A squared V/Hz ratio can be used in applications where the torque demand of the load is proportional to the square of the speed, e.g. in centrifugal fans and pumps.

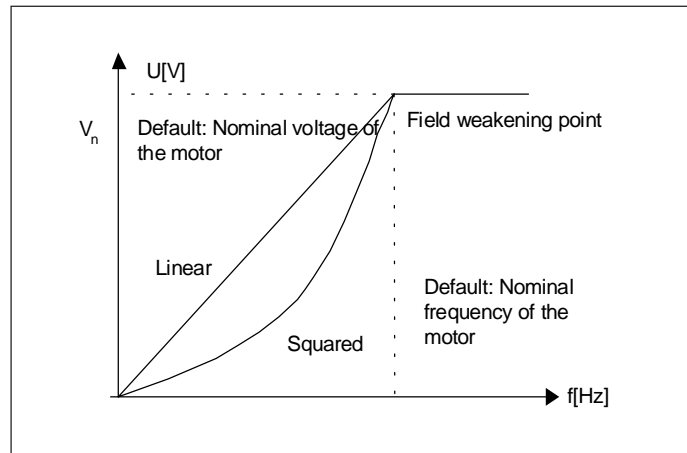

Figure 3.4-1 Linear and squared V/Hz curves.

Programm. The V/Hz curve can be programmed with three different points.

V/Hz curve The parameters for programming are explained in chapter 3.5.2.

2

A programmable V/Hz curve can be used if the standard settings do not satisfy the needs of the application. See figure 3.4-2.

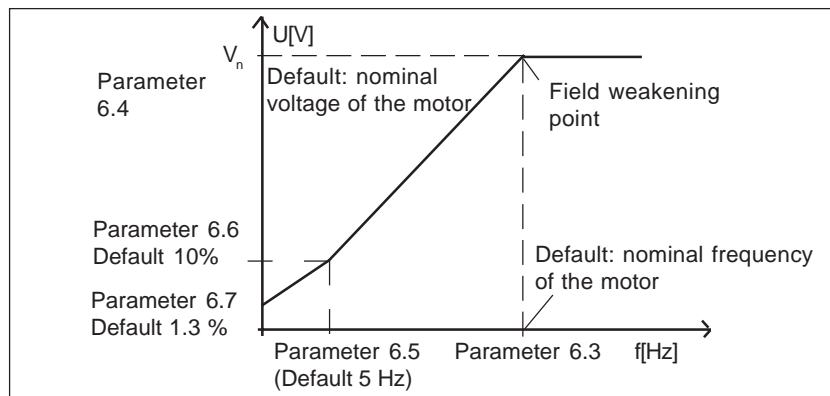

Figure 3.4-2 Programmable V/Hz curve.

1. 9 V/Hz optimization

Automatic torque boost The voltage to the motor changes automatically which allows the motor to produce enough torque to start and run at low frequencies. The voltage increase depends on the motor type and horsepower. Automatic torque boost can be used in applications where starting torque due to starting friction is high, e.g. in conveyors.

NOTE! *In high torque - low speed applications - it is likely the motor will overheat.*



If the motor has to run for a prolonged time under these conditions, special attention must be paid to cooling the motor. Use external cooling for the motor if the temperature rise is too high.

1. 10 Nominal voltage of the motor

Find this value V_n from the nameplate of the motor.
This parameter sets the voltage at the field weakening point, parameter 6. 4, to $100\% \times V_{n\text{motor}}$

1. 11 Nominal frequency of the motor

Find then nominal frequency f_n from the nameplate of the motor.
This parameter sets the field weakening point, parameter 6. 3, to the same value.

1. 12 Nominal speed of the motor

Find this value n_n from the nameplate of the motor.

1. 13 Nominal current of the motor

Find the value I_n from the nameplate of the motor.
The internal motor protection function uses this value as a reference value.

1. 14 Supply voltage

Set parameter value according to the nominal voltage of the supply.
Values are pre-defined for voltage codes 2, 4, 5, and 6. See table 3.4-1.

1. 15 Parameter conceal

Defines which parameter groups are available:

- 0 = all parameter groups are visible
- 1 = only group 1 is visible

1. 16 Parameter value lock

Defines access to the changes of the parameter values:

- 0 = parameter value changes enabled
- 1 = parameter value changes disabled

1. 17 - 1. 23 Multi-step speed reference 1—7

These parameter values define the Multi-step speeds selected with the DIA4, DIB5 and DIB6 digital inputs .

These values are automatically limited between minimum and maximum frequency (par. 1. 1, 1. 2).



Speed reference	Multi-step speed select 1 DIB4	Multi-step speed select 2 DIB5	Multi-step speed select 3 DIB6
Par. 1. 6	0	0	0
Par. 1. 17	1	0	0
Par. 1. 18	0	1	0
Par. 1. 19	1	1	0
Par. 1. 20	0	0	1
Par. 1. 21	1	0	1
Par. 1. 22	0	1	1
Par. 1. 23	1	1	1

Table 3.4-2 Selection of multi-step speed reference 1—7.

3.5 Special parameters, Groups 2—8

3.5.1 Parameter tables





Input signal parameters, Group 2

Code	Parameter	Range	Step	Default	Custom	Description	Page
2.1	Start/Stop logic selection 	0—3	1	0		DIA1	3-15
						DIA2	
						0 = Start forward 1 = Start/Stop 2 = Start/Stop 3 = Start pulse	
						Start reverse Reverse Run enable Stop pulse	
2.2	DIA3 function (terminal 10) 	0—9	1	7		0 = Not used 1 = Ext. fault, closing contact 2 = External fault, opening contact 3 = Run enable 4 = Acc./Dec. time selection 5 = Reverse (if par. 2. 1 = 3) 6 = Jog speed 7 = Fault reset 8 = Acc./Dec. operation prohibit 9 = DC-braking command	3-16
2.3	V _{in} signal range	0—1	1	0		0 = 0 — 10 V 1 = Custom setting range	3-17
2.4	V _{in} custom setting min.	0.00-100.00%	0.01%	0.00%			3-17
2.5	V _{in} custom setting max.	0.00-100.00%	0.01%	100.00%			3-17
2.6	V _{in} signal inversion	0—1	1	0		0 = Not inverted 1 = Inverted	3-18
2.7	V _{in} signal filter time	0.00 — 10.0 s	0.01s	0.10 s		0 = No filtering	3-18
2.8	I _{in} signal range	0—2	1	0		0 = 0—20 mA 1 = 4—20 mA 2 = Custom setting range	3-19
2.9	I _{in} custom setting minim.	0.00-100.00%	0.01%	0.00%			3-19
2.10	I _{in} custom setting maxim.	0.00-100.00%	0.01%	100.00%			3-19
2.11	I _{in} signal inversion	0—1	1	0		0 = Not inverted 1 = Inverted	3-19
2.12	I _{in} signal filter time	0.01 — 10.00s	0.01s	0.10 s		0 = No filtering	3-19
2.13	Reference scaling minimum value	0— par. 2. 14	1 Hz	0 Hz		Selects the frequency that corresponds to the min. reference signal	3-20
2.14	Reference scaling maximum value	0— f _{max} (1. 2)	1 Hz	0 Hz		Selects the frequency that corresponds to the max. reference signal 0 = Scaling off >0 = Scaled maximum value	3-20
2.15	Free analog input, signal selection	0—2	1	0		0 = Not use 1 = V _{in} (analog voltage input) 2 = I _{in} (analog current input)	3-20
2.16	Free analog input, function	0—4	1	0		0 = No function 1 = Reduces current limit (par. 1.7) 2 = Reduces DC-braking current 3 = Reduces acc. and decel. times 4 = Reduces torque supervision limit	3-20

Note!  = Parameter value can be changed only when the drive is stopped.



Group 3, Output and supervision parameters

Code	Parameter	Range	Step	Default	Custom	Description	Page
3.1	Analog output function 	0—7	1	1		0 = Not used Scale 100% 1 = O/P frequency (0— f_{max}) 2 = Motor speed (0—max. speed) 3 = O/P current (0— $2.0 \times I_{nSV9}$) 4 = Motor torque (0— $2 \times T_{nMot}$) 5 = Motor power (0— $2 \times P_{nMot}$) 6 = Motor voltage (0— $100\% \times V_{nMot}$) 7 = DC-link volt. (0—1000 V)	3-22
3.2	Analog output filter time	0.00—10.00 s	0.01 s	1.00 s			3-22
3.3	Analog output inversion	0—1	1	0		0 = Not inverted 1 = Inverted	3-22
3.4	Analog output minimum	0—1	1	0		0 = 0 mA 1 = 4 mA	3-22
3.5	Analog output scale	10—1000%	1%	100%			3-22
3.6	Digital output function 	0—21	1	1		0 = Not used 1 = Ready 2 = Run 3 = Fault 4 = Fault inverted 5 = SV9000 overheat warning 6 = External fault or warning 7 = Reference fault or warning 8 = Warning 9 = Reversed 10 = Jog speed selected 11 = At speed 12 = Motor regulator activated 13 = Output frequency limit superv. 1 14 = Output frequency limit superv. 2 15 = Torque limit supervision 16 = Reference limit supervision 17 = External brake control 18 = Control from I/O-terminals 19 = Drive temperature limit supervision 20 = Unrequested rotation direction 21 = External brake control inverted	3-23
3.7	Relay output 1 function 	0—21	1	2		As parameter 3.6	3-23
3.8	Relay output 2 function 	0—21	1	3		As parameter 3.6	3-23
3.9	Output freq. limit 1 supervision function	0—2	1	0		0 = No 1 = Low limit 2 = High limit	3-23
3.10	Output freq. limit 1 supervision value	0.0— f_{max} (par. 1.2)	0.1 Hz	0.0 Hz			3-23

Note!  = Parameter value can be changed only when the drive is stopped.



Code	Parameter	Range	Step	Default	Custom	Description	Page
3.11	Output freq. limit 2 supervision function	0—2	1	0		0 = No 1 = Low limit 2 = High limit	3-23
3.12	Output freq. limit 2 supervision value	0.0— f_{max} (par. 1.2)	0.1 Hz	0.0 Hz			3-23
3.13	Torque limit supervision function	0—2	1	0		0 = No 1 = Low limit 2 = High limit	3-24
3.14	Torque limit supervision value	0.0—200.0% $\times T_{nsv9}$	0.1%	100.0%			3-24
3.15	Reference limit supervision function	0—2	1	0		0 = No 1 = Low limit 2 = High limit	3-24
3.16	Reference limit supervision value	0.0— f_{max} (par. 1.2)	0.1 Hz	0.0 Hz			3-24
3.17	Extern. brake Off-delay	0.0—100.0 s	0.1 s	0.5 s			3-24
3.18	Extern. brake On-delay	0.0—100.0 s	0.1 s	1.5 s			3-24
3.19	Drive temperature limit supervision	0—2	1	0		0 = No 1 = Low limit 2 = High limit	3-25
3.20	Drive temperature limit value	-10—+75°C	1	40°C			3-25
3.21	I/O-expander board (opt.) analog output function 	0—7	1	3		See parameter 3.1	3-22
3.22	I/O-expander board (opt.) analog output filter time	0.00—10.00 s	0.01 s	1.00 s		See parameter 3.2	3-22
3.23	I/O-expander board (opt.) analog output inversion	0—1	1	0		See parameter 3.3	3-22
3.24	I/O-expander board (opt.) analog output minimum	0—1	1	0		See parameter 3.4	3-22
3.25	I/O-expander board (opt.) analog output scale	10—1000%	1	100%		See parameter 3.5	3-22

Group 4, Drive control parameters

Code	Parameter	Range	Step	Default	Custom	Description	Page
4.1	Acc./Dec. ramp 1 shape	0.0—10.0 s	0.1 s	0.0 s		0 = Linear >0 = S-curve acc./dec. time	3-25
4.2	Acc./Dec. ramp 2 shape	0.0—10.0 s	0.1 s	0.0 s		0 = Linear >0 = S-curve acc./dec. time	3-25
4.3	Acceleration time 2	0.1—3000.0s	0.1 s	10.0 s			3-25
4.4	Deceleration time 2	0.1—3000.0s	0.1 s	10.0 s			3-25
4.5	Brake chopper 	0—2	1	0		0 = Brake chopper not in use 1 = Brake chopper in use 2 = External brake chopper	3-26
4.6	Start function	0—1	1	0		0 = Ramp 1 = Flying start	3-26

Note!  = Parameter value can be changed only when the drive is stopped.









Code	Parameter	Range	Step	Default	Custom	Description	Page
4.7	Stop function	0—1	1	0		0 = Coasting 1 = Ramp	3-26
4.8	DC-braking current	0.15—1.5 x I_{nSV9} (A)	0.1 A	0.5 x I_{nSV9}			3-26
4.9	DC-braking time at Stop	0.00-250.00s	0.01 s	0.00 s		0 = DC-brake is off at Stop	3-26
4.10	Turn on frequency of DC brake during ramp Stop	0.1—10.0 Hz	0.1 Hz	1.5 Hz			3-28
4.11	DC-brake time at Start	0.00—25.00 s	0.01 s	0.00 s		0 = DC-brake is off at Start	3-28

Group 5, Prohibit frequency parameters

Code	Parameter	Range	Step	Default	Custom	Description	Page
5.1	Prohibit frequency range 1 low limit	f_{min} — par. 5.2	0.1 Hz	0.0 Hz			3-28
5.2	Prohibit frequency range 1 high limit	f_{min} — f_{max} (1.1) (1.2)	0.1 Hz	0.0 Hz		0 = Prohibit range 1 is off	3-28
5.3	Prohibit frequency range 2 low limit	f_{min} — par. 5.4	0.1 Hz	0.0 Hz			3-28
5.4	Prohibit frequency range 2 high limit	f_{min} — f_{max} (1.1) (1.2)	0.1 Hz	0.0 Hz		0 = Prohibit range 2 is off	3-28
5.5	Prohibit frequency range 3 low limit	f_{min} — par. 5.6	0.1 Hz	0.0 Hz			3-28
5.6	Prohibit frequency range 3 high limit	f_{min} — f_{max} (1.1) (1.2)	0.1 Hz	0.0 Hz		0 = Prohibit range 3 is of	3-28

Group 6, Motor control parameters

Code	Parameter	Range	Step	Default	Custom	Description	Page
6.1	Motor control mode 	0—1	1	0		0 = Frequency control 1 = Speed control	3-29
6.2	Switching frequency	1.0—16.0 kHz	0.1 kHz	10/3.6 kHz		Dependant on Hp rating	3-29
6.3	Field weakening point 	30—500 Hz	1 Hz	Param. 1.11			3-29
6.4	Voltage at field weakening point 	15—200% x V_{nmot}	1%	100%			3-29
6.5	V/Hz curve, midpoint frequency 	0.0— f_{max}	0.1 Hz	0.0 Hz			3-29
6.6	V/Hz-curve, midpoint voltage 	0.00—100.00% x V_{nmot}	0.01%	0.00%			3-29
6.7	Output voltage at zero frequency 	0.00—100.00% x V_{nmot}	0.01%	0.00%			3-29
6.8	Overvoltage controller	0—1	1	1		0 = Controller is turned off 1 = Controller is operating	3-30
6.9	Undervoltage controller	0—1	1	1		0 = Controller is turned off 1 = Controller is operating	3-30

Note!  = Parameter value can be changed only when the drive is stopped.



Group 7, Protections

Code	Parameter	Range	Step	Default	Custom	Description	Page
7.1	Response to reference fault	0—3	1	0		0 = No action 1 = Warning 2 = Fault, stop according to par. 4.7 3 = Fault, always coasting stop	3-30
7.2	Response to external fault	0—3	1	2		0 = No action 1 = Warning 2 = Fault, stop according to par. 4.7 3 = Fault, always coasting stop	3-30
7.3	Phase supervision of the motor	0—2	2	2		0 = No action 2 = Fault	3-30
7.4	Ground fault protection	0—2	2	2		0 = No action 2 = Fault	3-31
7.5	Motor thermal protection	0—2	1	2		0 = No action 1 = Warning 2 = Fault	3-31
7.6	Motor thermal protection break point current	50.0—150.0 % $\times I_{nMOTOR}$	1.0 %	100.0%			3-32
7.7	Motor thermal protection zero frequency current	5.0—150.0% $\times I_{nMOTOR}$	1.0 %	45.0%			3-32
7.8	Motor thermal protection time constant	0.5—300.0 minutes	0.5 min.	17.0 min.		Default value is set according to motor nominal current	3-33
7.9	Motor thermal protection break point frequency	10—500 Hz	1 Hz	35 Hz			3-33
7.10	Stall protection	0—2	1	1		0 = No action 1 = Warning 2 = Fault	3-34
7.11	Stall current limit	5.0—200.0% $\times I_{nMOTOR}$	1.0%	130.0%			3-34
7.12	Stall time	2.0—120.0 s	1.0 s	15.0 s			3-34
7.13	Maximum stall frequency	1— f_{max}	1 Hz	25 Hz			3-34
7.14	Underload protection	0—2	1	0		0 = No action 1 = Warning 2 = Fault	3-35
7.15	Underload prot., field weakening area load	10.0—150.0 % $\times T_{nMOTOR}$	1.0%	50.0%			3-35
7.16	Underload protection, zero frequency load	5.0—150.0% $\times T_{nMOTOR}$	1.0%	10.0%			3-35
7.17	Underload time	2.0—600.0 s	1.0 s	20.0s			3-36



Group 8, Autorestart parameters

Code	Parameter	Range	Step	Default	Custom	Description	Page
8.1	Automatic restart: number of tries	0—10	1	0		0 = not in use	3-36
8.2	Automatic restart: multi attempt maximum trial time	1—6000 s	1 s	30 s			3-36
8.3	Automatic restart: start function	0—1	1	0		0 = Ramp 1 = Flying start	3-37
8.4	Automatic restart after undervoltage trip	0—1	1	0		0 = No 1 = Yes	3-37
8.5	Automatic restart after overvoltage trip	0—1	1	0		0 = No 1 = Yes	3-37
8.6	Automatic restart after overcurrent trip	0—1	1	0		0 = No 1 = Yes	3-37
8.7	Automatic restart after reference fault trip	0—1	1	0		0 = No 1 = Yes	3-37
8.8	Automatic restart after over/undertemperature fault trip	0—1	1	0		0 = No 1 = Yes	3-37

Table 3.5-1 Special parameters, Groups 2—8.



3.5.2 Description of Groups 2—8 parameters

2.1 Start/Stop logic selection

- 0: DIA1: closed contact = start forward
 DIA2: closed contact = start reverse,
 See figure 3.5-1.

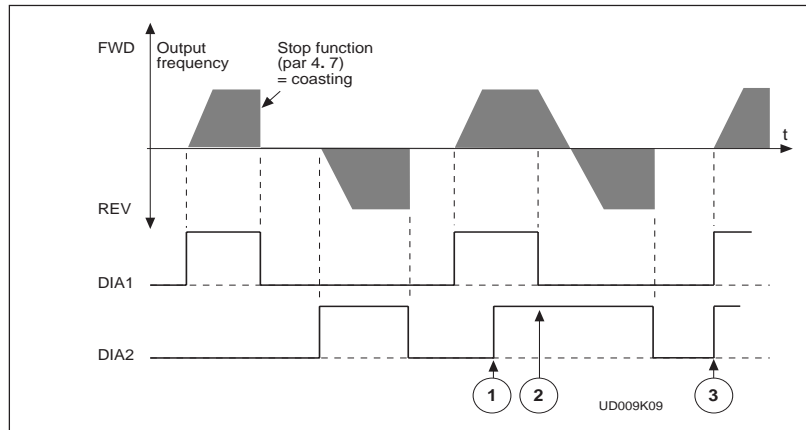

Figure 3.5-1 Start forward/Start reverse.

- ① The first selected direction has the highest priority
 - ② When DIA1 contact opens, the direction of rotation starts to change
 - ③ If Start forward (DIA1) and start reverse (DIA2) signals are active simultaneously, the start forward signal (DIA1) has priority.
- 1: DIA1: closed contact = start open contact = stop
 DIA2: closed contact = reverse open contact = forward
 See figure 3.5-2.

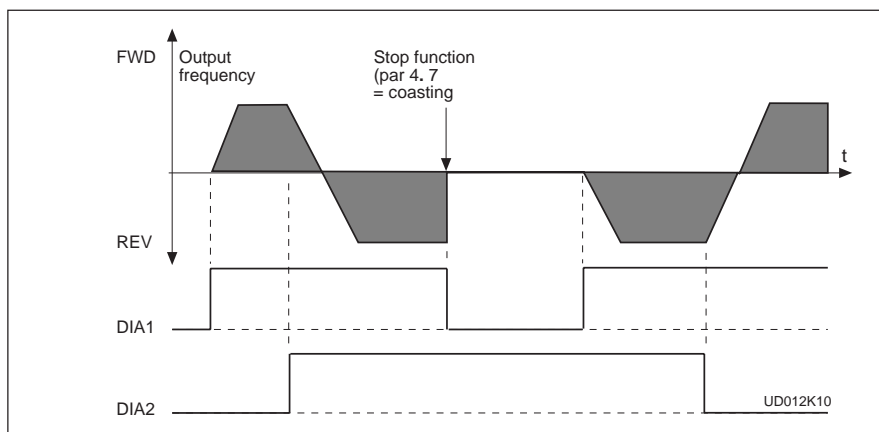

Figure 3.5-2 Start, Stop, reverse.

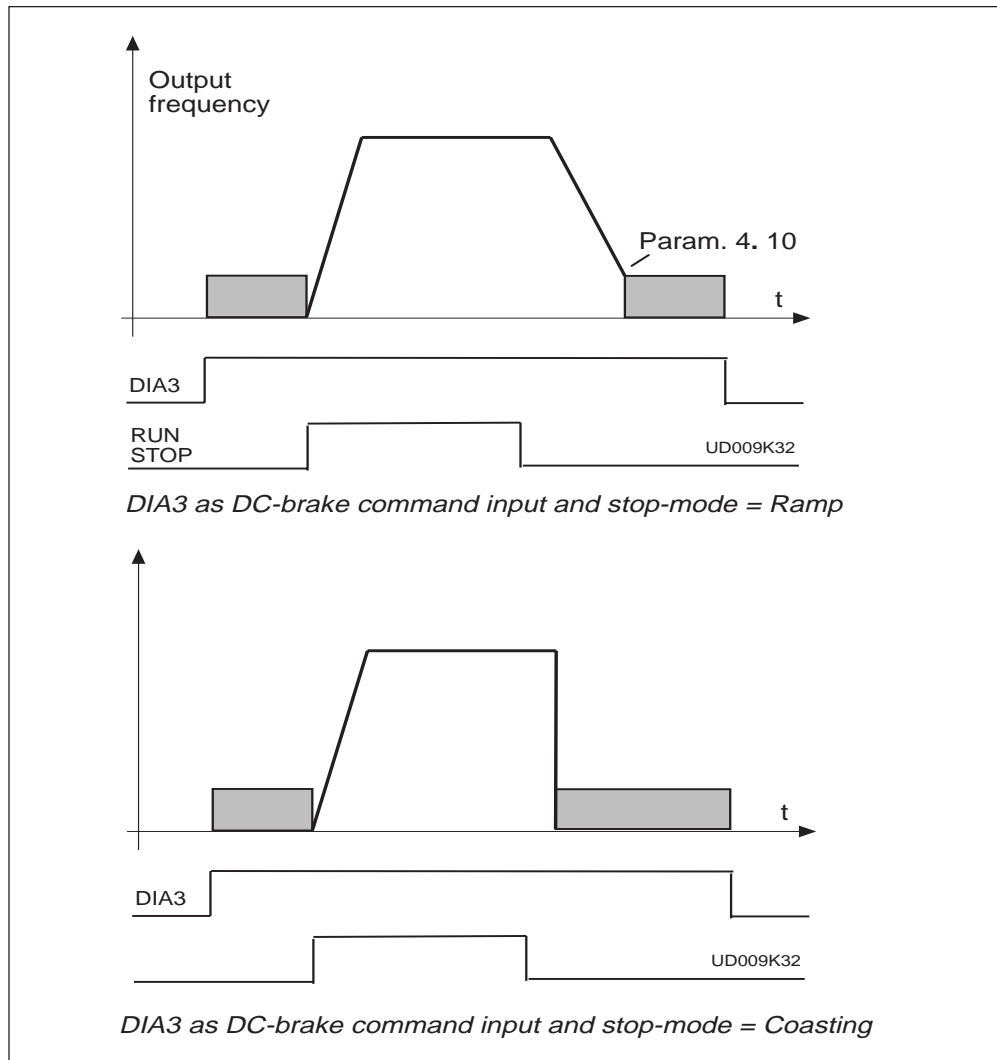

Figure 3.5-4 DIA3 as DC-brake command input: a) Stop mode = Ramp, b) Stop mode = Coasting.

2.3 V_{in} signal range

0 = Signal range 0—10 V

1 = Custom setting range from custom minimum (par. 2. 4) to custom maximum (par. 2. 5)

2.4 V_{in} custom setting minimum/maximum

2.5 These parameters set V_{in} for any input signal span within 0—10 V.

Minimum setting: Set the V_{in} signal to its minimum level, select parameter 2.4, press the Enter button

Maximum setting: Set the V_{in} signal to its maximum level, select parameter 2.5, press the Enter button

Note! The parameter values can only be set with this procedure (not with arrow up/arrow down buttons).

2.6 V_{in} signal inversion

V_{in} is source B frequency reference, par. 1.6 = 1 (default)

Parameter 2.6 = 0, no inversion of analog V_{in} signal

Parameter 2.6 = 1, inversion of analog V_{in} signal
 max. V_{in} signal = minimum set speed
 min. V_{in} signal = maximum set speed

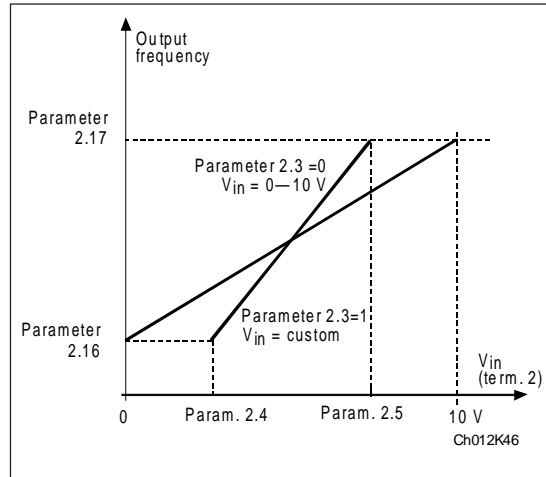

Figure 3.5-5 V_{in} no signal inversion

3

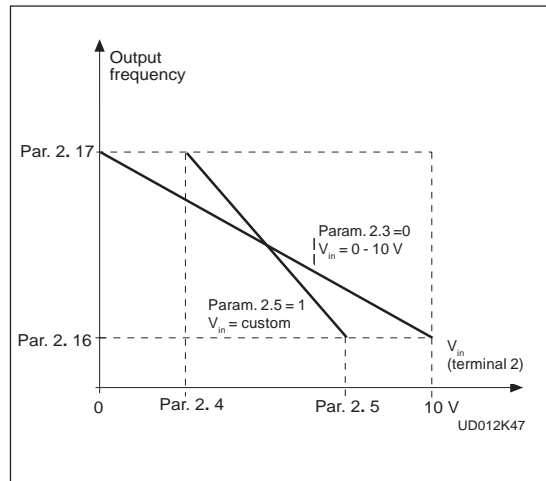

Figure 3.5-6 V_{in} signal inversion.

2.7 V_{in} signal filter time

Filters out disturbances from the incoming analog V_{in} signal. A long filtering time makes drive response slower. See figure 3.5-7.

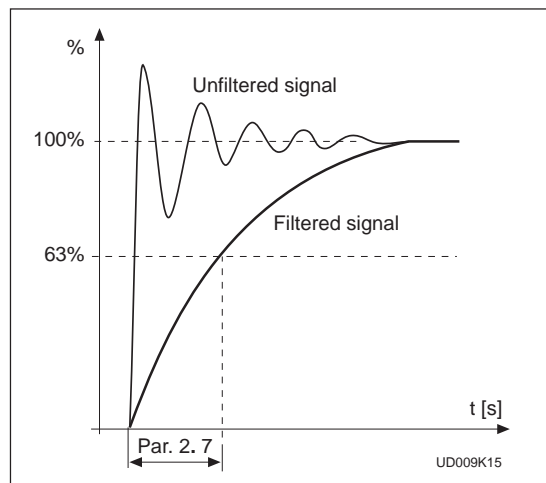

Figure 3.5-7 V_{in} signal filtering.



2.8 Analog input I_{in} signal range

- 0 = 0—20 mA
- 1 = 4—20 mA
- 2 = Custom signal span

See figure 3.5-8.

2.9 Analog input I_{in} custom setting minimum/maximum

2.10

With these parameters you can scale the input current to correspond to a minimum and maximum frequency range. See figure 3.5-8.

Minimum setting: Set the I_{in} signal to its minimum level, select parameter 2.9, press the Enter button

Maximum setting:

Set the I_{in} signal to its maximum level, select parameter 2.10, press the Enter button

Note! The parameter values can only be set with this procedure (not with arrow up/arrow down buttons).

2.11 Analog input I_{in} inversion

I_{in} is source A frequency reference, par. 1.5 = 0 (default)

Parameter 2.11 = 0, no inversion of I_{in} input

Parameter 2.11 = 1, inversion of I_{in} input, see figure 3.5-9.

max. I_{in} signal = minimum set speed

min. I_{in} signal = maximum set speed

2.12 Analog input I_{in} filter time

Filters out disturbances from the incoming analog I_{in} signal. A long filtering time makes drive response slower. See figure 3.5-10.

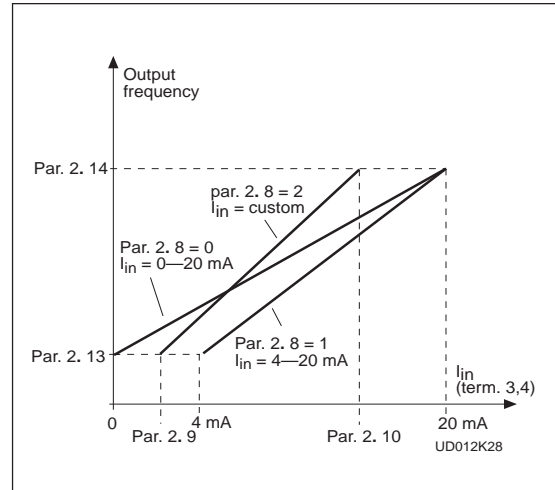

Figure 3.5-8 Analog input I_{in} scaling.

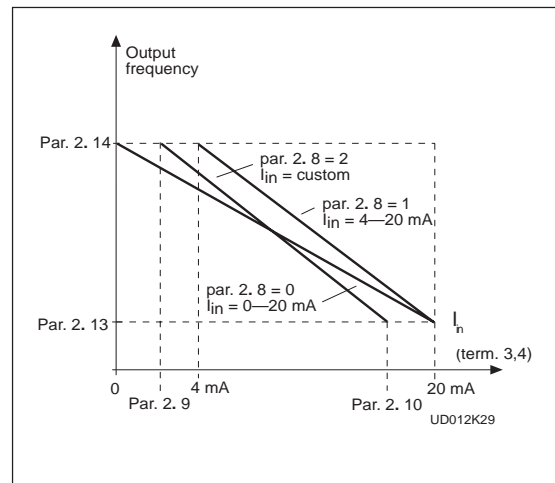

Figure 3.5-9 I_{in} signal inversion.

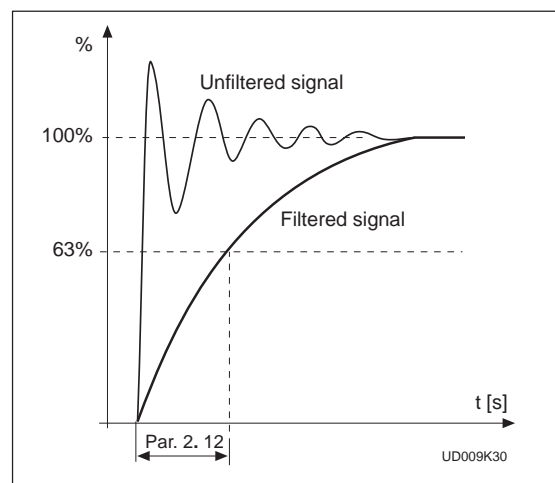

Figure 3.5-10 Analog input I_{in} filter time.

2. 13, 2. 14 Reference scaling, minimum value/maximum value

Scales the basic reference.

Setting limits: par. 1. 1 < par. 2. 13 < par. 2. 14 < par. 1. 2.

If par. 2. 14 = 0 scaling is set off. See figures 3.5-11 and 3.5-12.

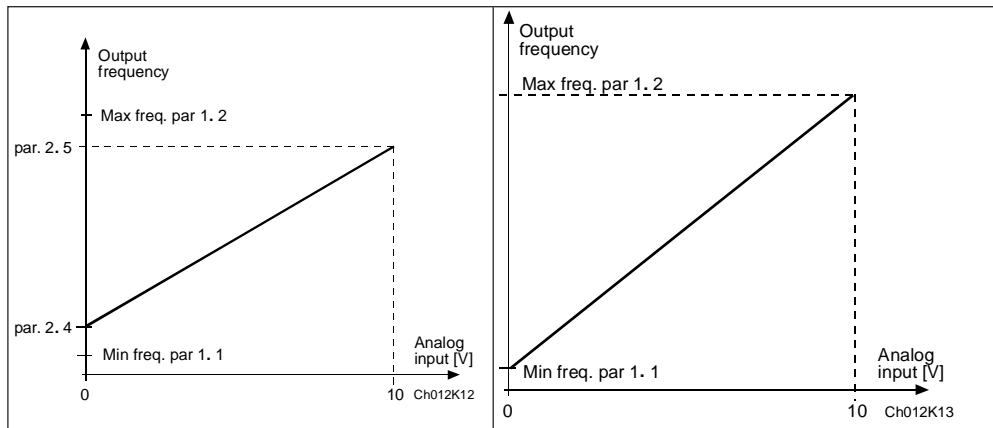

Figure 3.5-11 Reference scaling

Figure 3.5-12 Reference scaling,
par. 2. 14 = 0.

3

2. 18 Free analog input signal

Selection of input signal of free analog input (an input not used for reference signal):

- 0 = Not in use
- 1 = Voltage signal V_{in}
- 2 = Current signal I_{in}

2. 18 Free analog input signal function

Use this parameter to select a function for a free analog input signal:

- 0 = Function is not used
- 1 = Reducing motor current limit (par. 1. 7)

This signal will adjust the maximum motor current between 0 and the maximum set with parameter 1. 7. See figure 3.5-13.

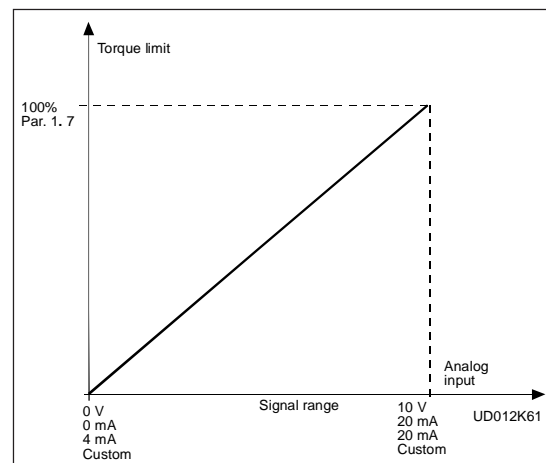

Figure 3.5-13 Reducing max. motor current.



2= Reducing DC brake current.

DC braking current can be reduced with the free analog input signal between current $0.15 \times I_{nSV9}$ and current set by the parameter 4. 8. See figure 3.5-14.

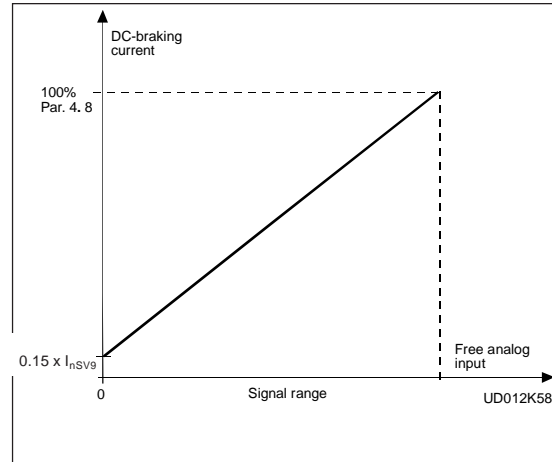

Figure 2.5-14 Reducing DC brake current.

3 = Reducing acceleration and deceleration times.

Acceleration/deceleration times can be reduced with a free analog input signal according to the following formulas:

Reduced time = set acc./deceler. time (par. 1. 3, 1. 4; 4. 3, 4. 4) divided by the factor R from the figure 3.5-15.

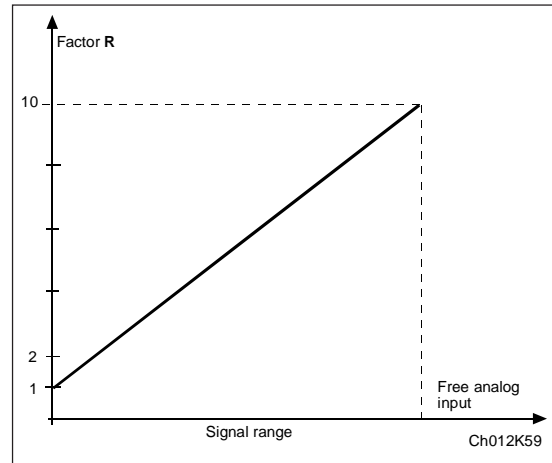

Figure 3.5-15 Reducing acceleration and deceleration times.

4 = Reducing torque supervision limit.

Torque supervision limit can be reduced with a free analog input signal between 0 and set supervision limit (par. 3. 14), see figure 3.5-16.

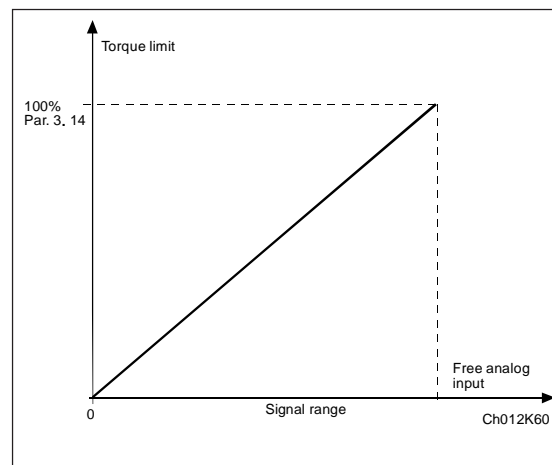

Figure 3.5-16 Reducing torque supervision limit.

3. 1 Analog output function



See table for parameter 3.1 on page 3-9.

3.2 Analog output filter time

Filters the analog output signal. See figure 3.5-17.

3.3 Analog output invert

Inverts analog output signal:
 max. output signal = minimum set value
 min. output signal = maximum set value

3.4 Analog output minimum

Defines the signal minimum to be either 0 mA or 4 mA (living zero). See figure 3.5-19.

3.5 Analog output scale

Scaling factor for analog output. See figure 3.5-19.

Signal Max. value of the signal

Signal	Max. value of the signal
Output frequency	Max. frequency (p. 1. 2)
Output current	$2 \times I_{nSV9}$
Motor speed	Max. speed ($n_n \times f_{n'} / f_n$)
Motor torque	$2 \times T_{nMot}$
Motor power	$2 \times P_{nMot}$
Motor voltage	$100\% \times V_{nMot}$
DC-link volt.	1000 V

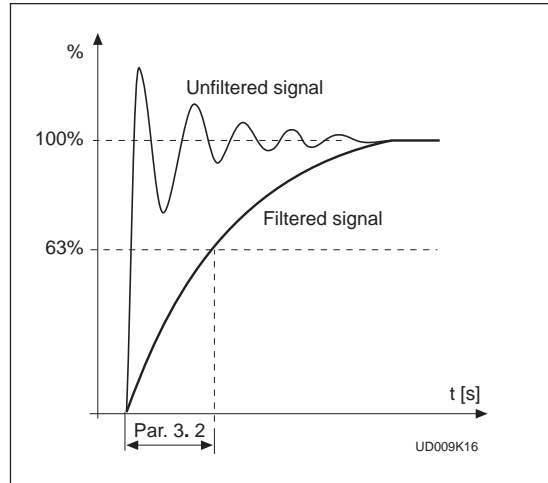

Figure 3.5-17 Analog output filtering.

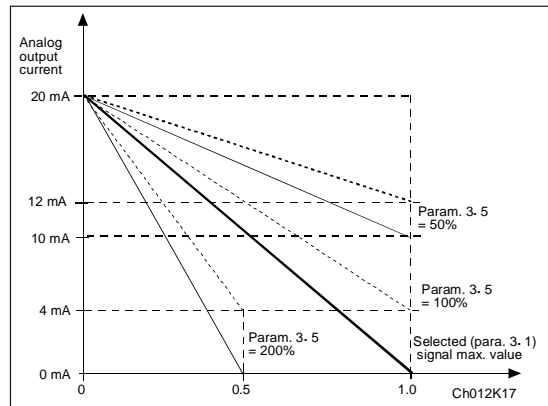

Figure 3.5-18 Analog output invert.

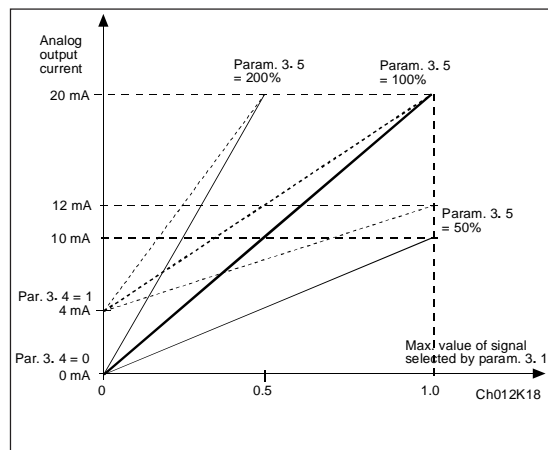

Figure 3.5-19 Analog output scale.



- 3.6 **Digital output function**
- 3.7 **Relay output 1 function**
- 3.8 **Relay output 2 function**

Setting value	Signal content
0 = Not used	Out of operation Digital output DO1 sinks current and programmable relay (RO1, RO2) is activated when:
1 = Ready	The drive is ready to operate
2 = Run	The drive operates (motor is running)
3 = Fault	A fault trip has occurred
4 = Fault inverted	A fault trip <u>has not</u> occurred
5 = SV9000 overheat warning	The heat-sink temperature exceeds +70°C
6 = External fault or warning	Fault or warning depending on parameter 7. 2
7 = Reference fault or warning	Fault or warning depending on parameter 7. 1 - if analog reference is 4—20 mA and signal is <4mA
8 = Warning	Always if a warning exists
9 = Reversed	The reverse command has been selected
10= Jog speed selected	The Jog speed has been selected with digital input
11= At speed	The output frequency has reached the set reference
12= Motor regulator activated	Overvoltage or overcurrent regulator was activated
13= Output frequency supervision 1	The output frequency goes outside of the set supervision Low limit/ High limit (par. 3. 9 and 3. 10)
14= Output frequency supervision 2	The output frequency goes outside of the set supervision Low limit/ High limit (par. 3. 11 and 3. 12)
15= Torque limit supervision	The motor torque goes outside of the set supervision Low limit/ High limit (par. 3. 13 and 3. 14)
16= Active reference	Active reference goes outside of the set supervision limit supervision Low limit/ High limit (par. 3. 15 and 3. 16)
17= External brake control	External brake ON/OFF control with programmable delay (par 3. 17 and 3. 18)
18= Control from I/O terminals	External control mode selected with prog. push-button#2
19= Drive temperature supervision	Temperature on drive goes outside the set supervision limits (par. 3. 19 and 3. 20)
20= Unrequested rotation direction	Rotation direction of the motor shaft is different from the requested one
21= External brake control inverted	External brake ON/OFF control (par 3.17 and 3.18), output active when brake control is OFF

Table 3.5-2 Output signals via DO1 and output relays RO1 and RO2.

- 3.9 **Output frequency limit 1, supervision function**
- 3.11 **Output frequency limit 2, supervision function**

- 0 = No supervision
- 1 = Low limit supervision
- 2 = High limit supervision

If the output frequency goes under/over the set limit (3. 10, 3. 12) this function generates a warning message via the digital output DO1 or via a relay output RO1 or RO2 depending on the settings of the parameters 3. 6—3. 8.

- 3.10 **Output frequency limit 1, supervision value**
- 3.12 **Output frequency limit 2, supervision value**

The frequency value to be supervised by the parameter 3. 9 (3. 11). See figure 3.5-20.



3. 13 Torque limit , supervision function

- 0 = No supervision
- 1 = Low limit supervision
- 2 = High limit supervision

If the calculated torque value goes under/over the set limit (3. 14) this function generates a warning message via the digital output DO1 or via a relay output RO1 or RO2 depending on the settings of the parameters 3. 6—3. 8.

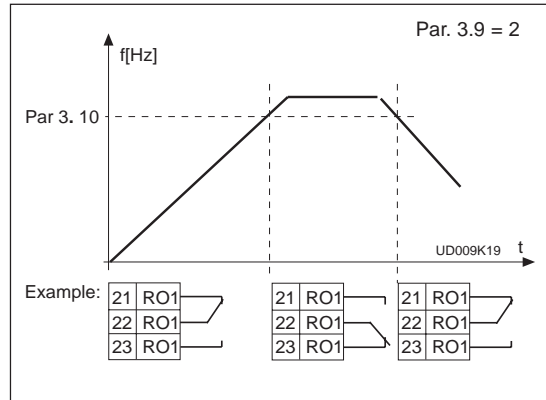

Figure 3.5-20 Output frequency supervision.

3. 14 Torque limit , supervision value

The calculated torque value to be supervised by the parameter 3.13. Torque supervision value can be reduced below the setpoint with a free analog input signal, see parameters 2.18 and 2.19.

3. 15 Reference limit , supervision function

- 0 = No supervision
- 1 = Low limit supervision
- 2 = High limit supervision

If the reference value goes under/over the set limit (3. 16) this function generates a warning message via the digital output DO1 and via a relay output RO1 or RO2 depending on the settings of the parameters 3. 6—3. 8. The supervised reference is the current active reference. It can be the source A or B reference depending on DIB6 input or the panel reference if the panel is the active control source.

3. 16 Reference limit , supervision value

The frequency value to be supervised by the parameter 3. 15.

3. 17 External brake-off delay

3. 18 External brake-on delay

The function of the external brake can be delayed from the start and stop control signals with these parameters. See figure 3.5-21.

The brake control signal can be programmed via the digital output DO1 or via one of the relay outputs RO1 and RO2, see parameters 3. 6—3. 8.

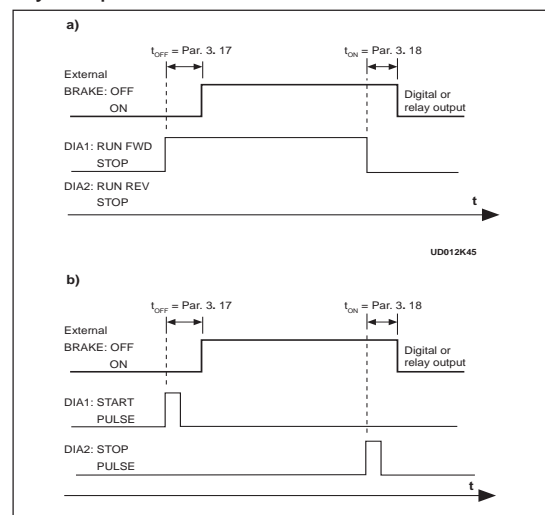

Figure 3.5-21 External brake control:
 a) Start/Stop logic selection par. 2. 1 = 0, 1 or 2
 b) Start/Stop logic selection par. 2. 1 = 3.



3. 19 Drive temperature limit supervision

- 0 = No supervision
- 1 = Low limit supervision
- 2 = High limit supervision

If the temperature of the unit goes under/over the set limit (3. 20) this function generates a warning message via the digital output DO1 or via a relay output RO1 or RO2 depending on the settings of the parameters 3. 6—3. 8.

3. 20 Drive temperature limit value

The temperature value to be supervised by the parameter 3. 19.

4. 1 Acc/Dec ramp 1 shape

4. 2 Acc/Dec ramp 2 shape

The acceleration and deceleration ramp shape can be programmed with these parameters.

Setting the value = 0 gives you a linear ramp shape. The output frequency immediately follows the input with a ramp time set by parameters 1. 3, 1. 4 (4. 3, 4. 4 for Acc/Dec time 2).

Setting 0.1—10 seconds for 4. 1 (4. 2) causes an S-shaped ramp. The speed changes are smooth. Parameter 1. 3/ 1. 4 (4. 3/ 4. 4) determines the ramp time of the acceleration/deceleration in the middle of the curve. See figure 3.5-22.

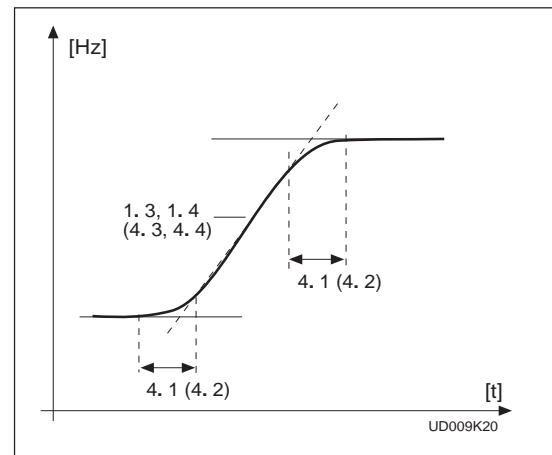

Figure 3.5-22 S-shaped acceleration/deceleration

4. 3 Acceleration time 2

4. 4 Deceleration time 2

These values correspond to the time required for output frequency to accelerate from the set minimum frequency (par. 1. 1) to the set maximum frequency (par. 1. 2). With this parameter it is possible to set two different acceleration/deceleration times for one application. The active set can be selected with the programmable signal DIA3. See parameter 2. 2. Acceleration/deceleration times can be reduced with a free analog input signal. See parameters 2. 18 and 2. 19.

4.5 Brake chopper

- 0 = No brake chopper
- 1 = Brake chopper and brake resistor installed
- 2 = External brake chopper

When the drive is decelerating the motor, the energy stored in the inertia of the motor and the load is fed into the external brake resistor. If the brake resistor is selected correctly the drive is able to decelerate the load with a torque equal to that of acceleration. See the separate Brake resistor installation manual.

4.6 Start function

Ramp:

- 0 The drive starts from 0 Hz and accelerates to the set reference frequency within the set acceleration time. (Load inertia or starting friction may cause prolonged acceleration times).

Flying start:

- 1 The drive starts into a running motor by first finding the speed the motor is running at. Searching starts from the maximum frequency down until the actual frequency reached. The output frequency then accelerates/decelerates to the set reference value at a rate determined by the acceleration/deceleration ramp parameters.

Use this mode if the motor may be coasting when the start command is given. With the flying start it is possible to ride through short utility voltage interruptions.

4.7 Stop function

Coasting:

- 0 The motor coasts to an uncontrolled stop with the SV9000 off, after the Stop command.

Ramp:

- 1 After the Stop command, the speed of the motor is decelerated according to the deceleration ramp time parameter. If the regenerated energy is high it may be necessary to use an external braking resistor for faster deceleration.

4.8 DC braking current

Determines whether DC braking is ON or OFF. It also determines the braking duration time of the DC-brake when the motor is stopping. The function of the DC-brake depends on the stop function, parameter 4. 7. See figure 3.5-23.

- 0 DC-brake is not used
- >0 DC-brake is in use depending on the setup of the stop function (param. 4. 7). The time is set by the value of parameter 4. 9:

Stop-function = 0 (coasting):

After the stop command, the motor will coast to a stop with the SV9000 off.

With DC-injection, the motor can be electrically stopped in the shortest possible time, without using an optional external braking resistor.

The braking time is scaled according to the frequency when the DC-braking starts. If the frequency is \geq nominal frequency of the motor (par. 1.11), the value of parameter 4.9 determines the braking time. When the frequency is $\leq 10\%$ of the nominal, the braking time is 10% of the set value of parameter 4.9.

Stop-function = 1 (ramp):

After a Stop command, the speed of the motor is reduced based on the deceleration ramp parameter. If no regeneration occurs due to load inertia DC-braking starts at a speed defined by parameter 4. 10.

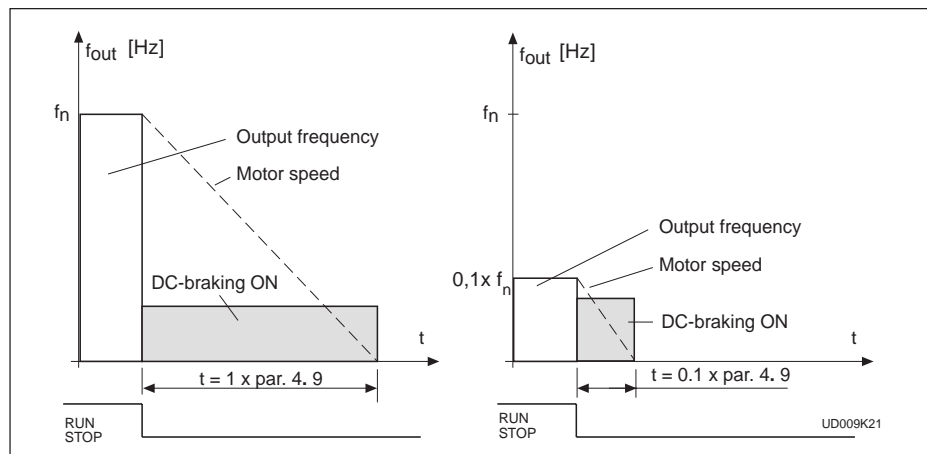

Figure 3.5-23 DC-braking time when stop = coasting.

The braking time is defined with parameter 4.9.

If a high inertia exists it is recommended to use an external braking resistor for faster deceleration. See figure 3.5-24.

4. 10**Execute frequency of DC-brake during ramp Stop**

See figure 3.5-24.

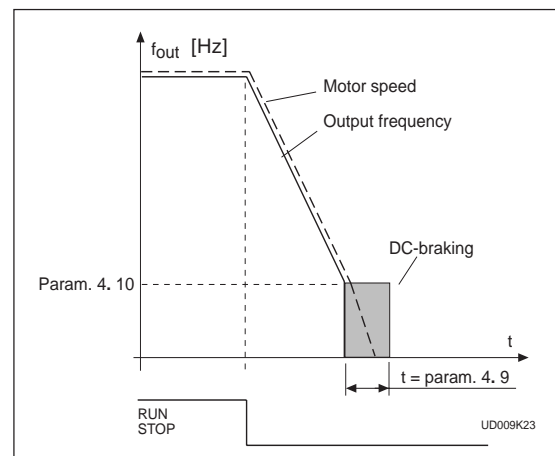

Figure 3.5-24 DC-braking time when stop function = ramp.

4. 11 DC-brake time at start

- 0** DC-brake is not used
- >0** DC-brake is active when the start command is given. This parameter defines the time before the brake is released. After the brake is released, the output frequency increases according to the set start function parameter 4. 6 and the acceleration parameters (1.3, 4.1 or 4.2, 4.3). See figure 3.5-25.

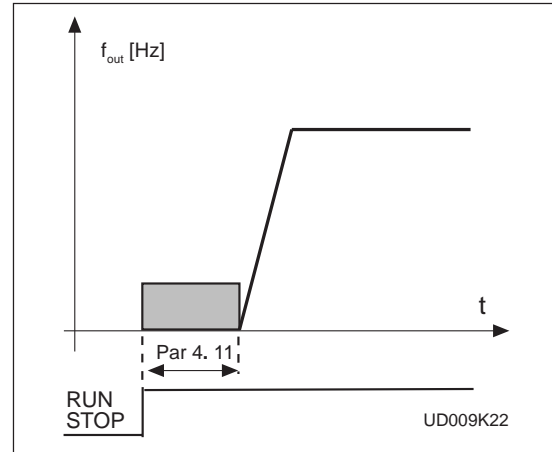

Figure 3.5-25 DC-braking time at start

5. 1- 5.6 Prohibit frequency area Low limit/High limit

In some systems it may be necessary to avoid certain frequencies because of mechanical resonance problems.

With these parameters it is possible to set limits for three "skip frequency" regions between 0 Hz and 500 Hz. The accuracy of the setting is 0.1 Hz. See figure 3.5-26.

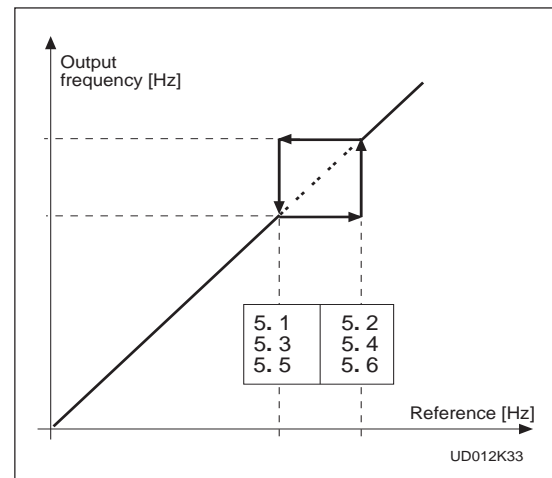

Figure 3.5-26 Example of prohibit frequency area setting.

6.1 Motor control mode

0 = Frequency control: The I/O terminal and panel references are frequency references and the drive controls the output frequency (output freq. resolution 0.01 Hz)
(V/Hz)

1 = Speed control: The I/O terminal and panel references are speed references and the drive controls the motor speed (control accuracy \pm (sensorless vector) 0.5%).

6.2 Switching frequency

Motor noise can be minimized by using a high switching frequency. Increasing the switching frequency reduces the current capacity of the SV9000.

Before changing the frequency from the factory default 10 kHz (3.6 kHz >40 Hp) check the drive derating in the curves shown in figures 5.2-2 and 5.2-3 in chapter 5.2 of the User's Manual.

6.3 Field weakening point**6.4 Voltage at the field weakening point**

The field weakening point is the output frequency where the output voltage reaches the set maximum value. Above that frequency the output voltage remains at the set maximum value.

Below that frequency output voltage depends on the setting of the V/Hz curve parameters 1. 8, 1. 9, 6. 5, 6. 6 and 6. 7. See figure 3.5-27.

When the parameters 1. 10 and 1. 11, nominal voltage and nominal frequency of the motor are set, parameters 6. 3 and 6. 4 are also set automatically to the corresponding values. If you need different values for the field weakening point and the maximum output voltage, change these parameters after setting parameters 1. 10 and 1. 11.

6.5 V/Hz curve, middle point frequency

If the programmable V/Hz curve has been selected with parameter 1. 8, this parameter defines the middle frequency point of the curve. See figure 3.5-27.

6.6 V/Hz curve, middle point voltage

If the programmable V/Hz curve has been selected with parameter 1. 8, this parameter defines the middle point voltage (% of motor nominal voltage) of the curve. See figure 3.5-27.

6.7 Output voltage at zero frequency

If the programmable V/Hz curve has been selected with parameter 1. 8, this parameter defines the zero frequency voltage of the curve. See figure 3.5-27.



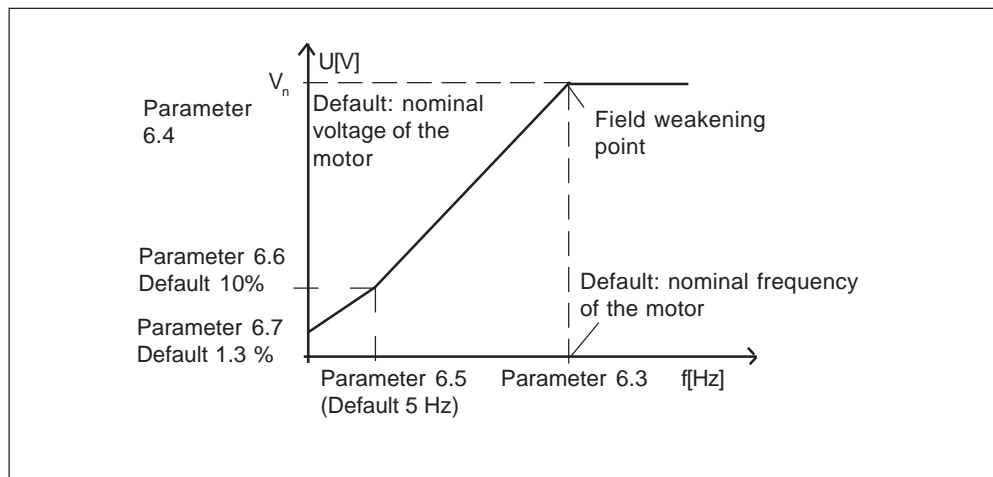

Figure 3.5-27 Programmable V/Hz curve.

6.8 Overvoltage controller

6.9 Undervoltage controller

These parameters allow the over/undervoltage controllers to be switched ON or OFF. This may be useful in cases where the utility supply voltage varies more than -15%—+10% and the application requires a constant speed. If the controllers are ON, they will change the motor speed in over/undervoltage cases. Overvoltage = faster, undervoltage = slower.

Over/undervoltage trips may occur when controllers are not used.

7.1 Response to the reference fault

- 0 = No response
- 1 = Warning
- 2 = Fault, stop mode after fault according to parameter 4.7
- 3 = Fault, always coasting stop mode after fault

A warning or a fault action and message is generated if the 4—20 mA reference signal is used and the signal falls below 4 mA. The information can also be programmed via digital output DO1 and via relay outputs RO1 and RO2.

7.2 Response to external fault

- 0 = No response
- 1 = Warning
- 2 = Fault, stop mode after fault according to parameter 4.7
- 3 = Fault, stop mode after fault always by coasting

A warning or a fault action and message is generated from the external fault signal in the digital input DIA3. The information can also be programmed into digital output DO1 and into relay outputs RO1 and RO2.

7.3 Phase supervision of the motor

- 0 = No action
- 2 = Fault

Phase supervision of the motor ensures that the motor phases have approximately equal current.

7.4 Ground fault protection

- 0 = No action
- 2 = Fault

Ground fault protection ensures that the sum of the motor phase currents is zero. The standard overcurrent protection is always working and protects the frequency converter from ground faults with high current levels.

Parameters 7.5—7.9 Motor thermal protection

General

Motor thermal protection is to protect the motor from overheating. The SV9000 drive is capable of supplying higher than nominal current to the motor. If the load requires this high current there is a risk that motor will be thermally overloaded. This is true especially at low frequencies. With low frequencies the cooling effect of the motor fan is reduced and the capacity of the motor is reduced. If the motor is equipped with a separately powered external fan, the load derating at low speed is small.

Motor thermal protection is based on a calculated model and it uses the output current of the drive to determine the load on the motor. When the motor is powered from the drive, the calculated model uses the heatsink temperature to determine the initial thermal state of the motor. The calculated model assumes that the ambient temperature of the motor is 40°C.

Motor thermal protection can be adjusted by setting several parameters. The thermal current I_T specifies the load current above which the motor is overloaded. This current limit is a function of the output frequency. The curve for I_T is set with parameters 7.6, 7.7 and 7.9, refer to the figure 3.5-28. The default values of these parameters are set from the motor nameplate data.

With the output current at I_T the thermal stage will reach the nominal value (100%). The thermal stage changes with the square of the current. With output current at 75% of I_T the thermal stage will reach 56% and with output current at 120% of I_T the thermal stage would reach 144%. The function will trip the drive (refer par. 7.5) if the thermal state reaches a value of 105%. The response time of the thermal stage is determined by the time constant parameter 7.8. The larger the motor, the longer it takes to reach the final temperature.

The thermal state of the motor can be monitored through the display. Refer to the table for monitoring items. (User's Manual, table 7.3-1).



CAUTION! *The calculated model does not protect the motor if the cooling of the motor is reduced either by blocking the airflow or due to dust or dirt.*

7.5 Motor thermal protection

Operation:

- 0 = Not in use
- 1 = Warning
- 2 = Trip function

Tripping and warning will give a display indication with the same message code. If tripping is selected, the drive will stop and activate the fault stage.



Deactivating the stall protection by setting the parameter to 0 will reset the stall time counter to zero.

7.6 Motor thermal protection, break point current

The current can be set between 50.0—150.0% $\times I_{nMotor}$. This parameter sets the value for thermal current at frequencies above the break point on the thermal current curve. See figure 3.5-28.

The value is set as a percentage of the motor nameplate nominal current, parameter 1.13, not the drive's nominal output current.

The motor's nominal current is the current which the motor can withstand in direct on-line use without being overheated.

If parameter 1.13 is adjusted, this parameter is automatically restored to the default value.

Setting this parameter (or parameter 1.13) does not affect the maximum output current of the drive. Parameter 1.7 alone determines the maximum output current of the drive.

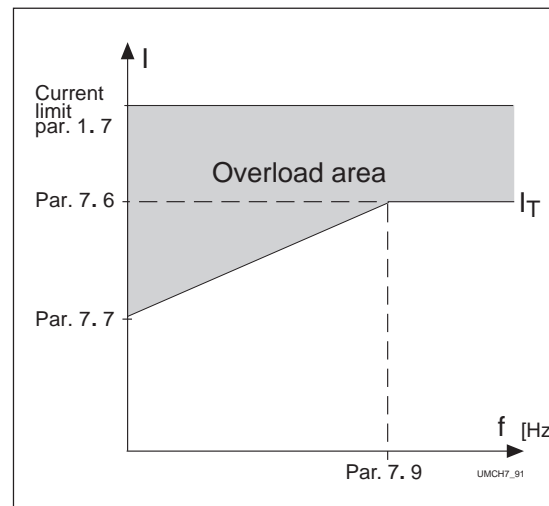

Figure 3.5-28 Motor thermal current I_T curve.

7.7 Motor thermal protection, zero frequency current

The current can be set between 10.0—150.0% $\times I_{nMotor}$.

This parameter sets the value for thermal current at zero frequency. Refer to figure 3.5-28.

The default value is set assuming that there is no external fan cooling the motor. If an external fan is used this parameter can be set to 90% (or higher).

The value is set as a percentage of the motor's nameplate nominal current, parameter 1.13, not the drive's nominal output current. The motor's nominal current is the current which the motor can stand in direct on-line use without being overheated. If you change parameter 1.13, this parameter is automatically restored to the default value.

Setting this parameter (or parameter 1.13) does not affect to the maximum output current of the drive. Parameter 1.7 alone determines the maximum output current of the drive.

7.8 Motor thermal protection, time constant

This time can be set between 0.5—300 minutes. This is the thermal time constant of the motor. The larger the motor the greater the time constant. The time constant is defined as the time that it takes the calculated thermal stage to reach 63% of its final value.

The motor thermal time is specific to a motor design and it varies between different motor manufacturers.

The default value for the time constant is calculated based on the motor nameplate data from parameters 1.12 and 1.13. If either of these parameters is reset, then this parameter is set to default value.

If the motor's t_6 -time is known (given by the motor manufacturer) the time constant parameter could be set based on t_6 -time. As a rule of thumb, the motor thermal time constant in minutes equals to $2xt_6$ (t_6 in seconds is the time a motor can safely operate at six times the rated current). If the drive is stopped the time constant is internally increased to three times the set parameter value. Cooling in the stop stage is based on convection with an increased time constant.

7.9 Motor thermal protection, break point frequency

The frequency can be set between 10—500 Hz. This is the frequency break point of the thermal current curve. With frequencies above this point, the thermal capacity of the motor is assumed to be constant. See figure 3.5-28.

The default value is based on the motor's nameplate data, parameter 1.11. It is 35 Hz for a 50 Hz motor and 42 Hz for a 60 Hz motor. More generally it is 70% of the frequency at the field weakening point (parameter 6.3). Changing either parameter 1.11 or 6.3 will restore this parameter to its default value.

7.10 Stall protection

Operation:

- 0 = Not in use
- 1 = Warning
- 2 = Trip function

Tripping and warning will give a display indication with the same message code. If tripping is set on, the drive will stop and activate the fault stage. Setting the parameter to 0 will deactivate the protection and will reset the stall time counter to zero.

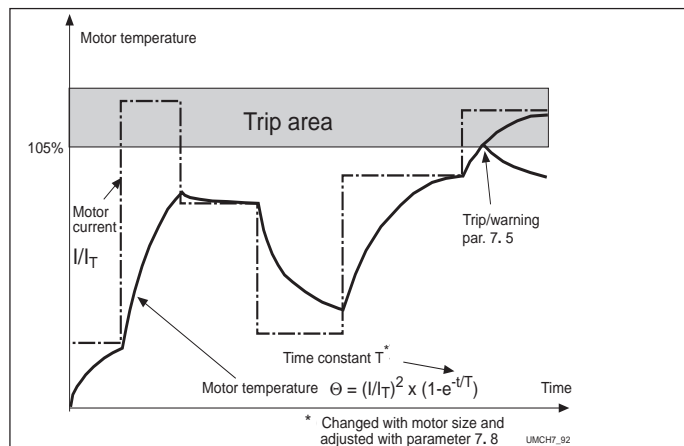

Figure 3.5-29 Calculating motor temperature.

Parameters 7. 10— 7. 13, Stall protection

General

Motor stall protection protects the motor from short time overload situations like a stalled shaft. The reaction time of stall protection can be set shorter than with motor thermal protection. The stall state is defined with two parameters, 7.11. Stall Current and 7.13. Stall Frequency. If the current is higher than the set limit and output frequency is lower than the set limit the stall state is true. There is actually no real indication of the shaft rotation. Stall protection is a type of overcurrent protection.

7. 11 Stall current limit

The current can be set between 0.0—200% $\times I_{nMotor}$.

In a stall the current has to be above this limit. See figure 3.5-30. The value is set as a percentage of the motor's nameplate nominal current, parameter 1. 13. If parameter 1. 13 is adjusted, this parameter is automatically restored to its default value.

7. 12 Stall time

The time can be set between 2.0—120 s. This is the maximum allowed time for a stall. There is an internal up/down counter to count the stall time. See figure 3.5-31. If the stall time counter value goes above this limit the protection will cause a trip (refer to parameter 7. 10).

7. 13 Maximum stall frequency

The frequency can be set between 1— f_{max} (parameter 1. 2).

In a stall, the output frequency has to be smaller than this limit. See figure 3.5-30.

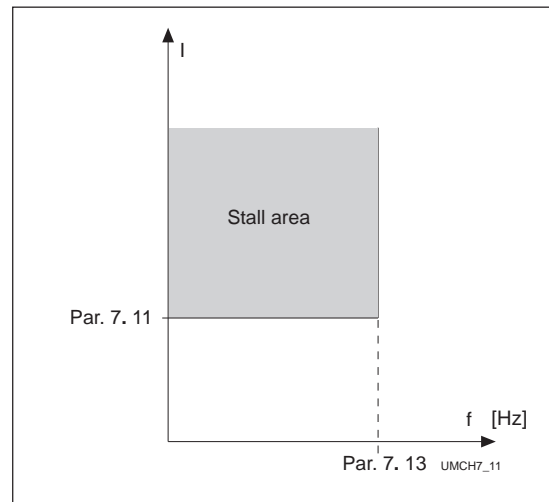

Figure 3.5-30 Setting the stall characteristics.

Parameters 7. 14— 7. 17 Underload protection, General

The purpose of motor underload protection is to ensure that there is load on the motor while the drive is running. If the motor load is reduced, there might be a problem in the process, e.g. broken belt or dry pump.

Motor underload protection can be adjusted by setting the underload curve with parameters 7. 15 and 7. 16. The underload curve is a squared curve set between zero frequency and the

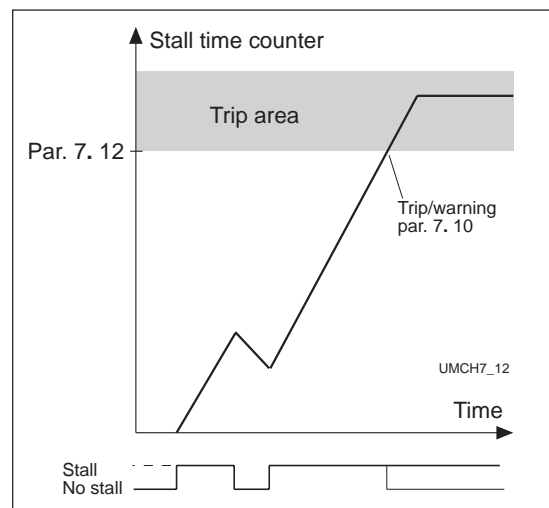

Figure 3.5-31 Counting the stall time.

field weakening point. The protection is not active below 5Hz (the underload counter value is stopped). See figure 3.5-32.

The torque values for setting the underload curve are set with percentage values which refer to the nominal torque of the motor. The motor's nameplate data, parameter 1. 13, the motor's nominal current and drive's nominal current I_{CT} are used to find the scaling ratio for the internal torque value. If other than a standard motor is used with the drive, the accuracy of the torque calculation is decreased.

7. 14 Underload protection

Operation:

- 0 = Not in use
- 1 = Warning
- 2 = Fault

Tripping and warning will give a display indication with the same message code. If tripping is set active the drive will stop and activate the fault stage.

Deactivating the protection, by setting this parameter to 0, will reset the underload time counter to zero.

7. 15 Underload protection, field weakening area load

The torque limit can be set between 20.0—150 % x T_{nMotor} .

This parameter is the value for the minimum allowed torque when the output frequency is above the field weakening point. See figure 3.5-32. If parameter 1. 13 is adjusted, this parameter is automatically restored to its default value.

7. 16 Underload protection, zero frequency load

The torque limit can be set between 10.0—150 % x T_{nMotor} .

This parameter is the value for the minimum allowed torque with zero frequency. Refer to the figure 3.5-32. If parameter 1. 13 is adjusted this parameter is automatically restored to its default value.

7. 17 Underload time

This time can be set between 2.0—600.0 s.

This is the maximum allowed time for an underload state. There is an internal up/down counter to accumulate the underload time. Refer to the figure 3.5-33. If the underload counter value goes above this limit, the protection will cause a trip (refer to the parameter 7. 14). If the drive is stopped, the underload counter is reset to zero.

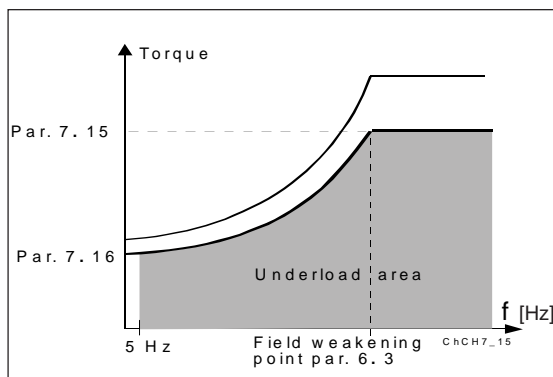

Figure 3.5-32 Setting of minimum load.

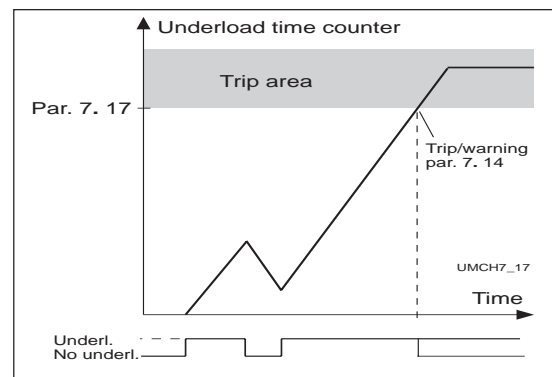

Figure 3.5-33 Counting the underload time.

- 8.1 Automatic restart: number of tries**
8.2 Automatic restart: trial time

The Automatic restart function restarts the drive after the faults selected with parameters 8.4 - 8.8. The Start function for Automatic restart is selected with parameter 8.3. See figure 3.5-34.

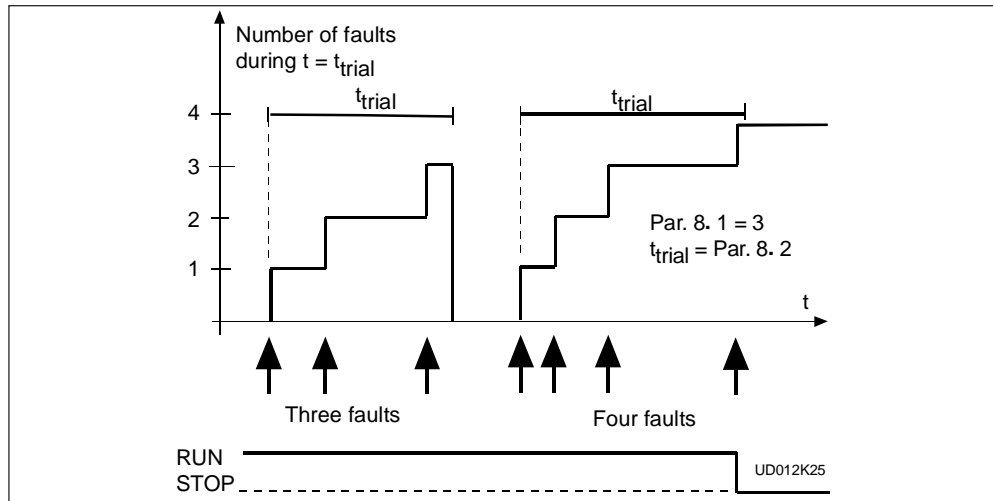

Figure 3.5-34 Automatic restart.

Parameter 8.1 determines how many automatic restarts can be made during the trial time set by the parameter 8.2.

The time counting starts from the first autorestart. If the number of restarts does not exceed the value of the parameter 8.1 during the trial time, the count is cleared after the trial time has elapsed. The next fault starts the counting again.

8.3 Automatic restart, start function

The parameter defines the start mode:

- 0 = Start with ramp
- 1 = Flying start, see parameter 4.6.

8.4 Automatic restart after undervoltage trip

- 0 = No automatic restart after undervoltage fault
- 1 = Automatic restart after undervoltage fault condition returns to the normal condition (DC-link voltage returns to the normal level)

8.5 Automatic restart after overvoltage trip

- 0 = No automatic restart after overvoltage fault
- 1 = Automatic restart after overvoltage fault condition returns to the normal condition (DC-link voltage returns to the normal level)

8.6 Automatic restart after overcurrent trip

- 0 = No automatic restart after overcurrent fault
- 1 = Automatic restart after overcurrent faults

8.7 Automatic restart after reference fault trip

0 = No automatic restart after reference fault

1 = Automatic restart after analog current reference signal (4—20 mA)
returns to the normal level (≥ 4 mA)

8.8 Automatic restart after over-/undertemperature fault trip

0 = No automatic restart after temperature fault

1 = Automatic restart after heatsink temperature has returned to its
normal level between -10°C—+75°C.

Notes:

[A series of horizontal lines for taking notes, spanning most of the page width.]



PI-CONTROL APPLICATION

(par. 0.1 = 5)

CONTENTS

4 PI-control Application	4-1
4.1 General	4-2
4.2 Control I/O	4-2
4.3 Control signal logic	4-3
4.4 Parameters Group 1	4-4
4.4.1 Parameter table	4-4
4.4.2 Description of Group1 par ...	4-5
4.5 Special parameters, Groups 2—8 ..	4-8
4.5.1 Parameter tables	4-8
4.5.2 Description of Groups.	4-15
4.6 Panel reference	4-36
4.7 Monitoring data.	4-36



4.1 General

In PI-control application there are two I/O-terminal control sources. Source A is the PI-controller and source B is the direct frequency reference. The control source is selected with DIB6 input.

The PI-controller reference can be selected from an analog input, motorized (digital) potentiometer or panel reference. The actual

value can be selected from the analog inputs or from mathematical functions of the analog inputs.

The direct frequency reference can be used for control without the PI-controller. The frequency reference can be selected from analog inputs or panel reference.

*** NOTE!** Remember to connect CMA and CMB inputs.

4.2 Control I/O

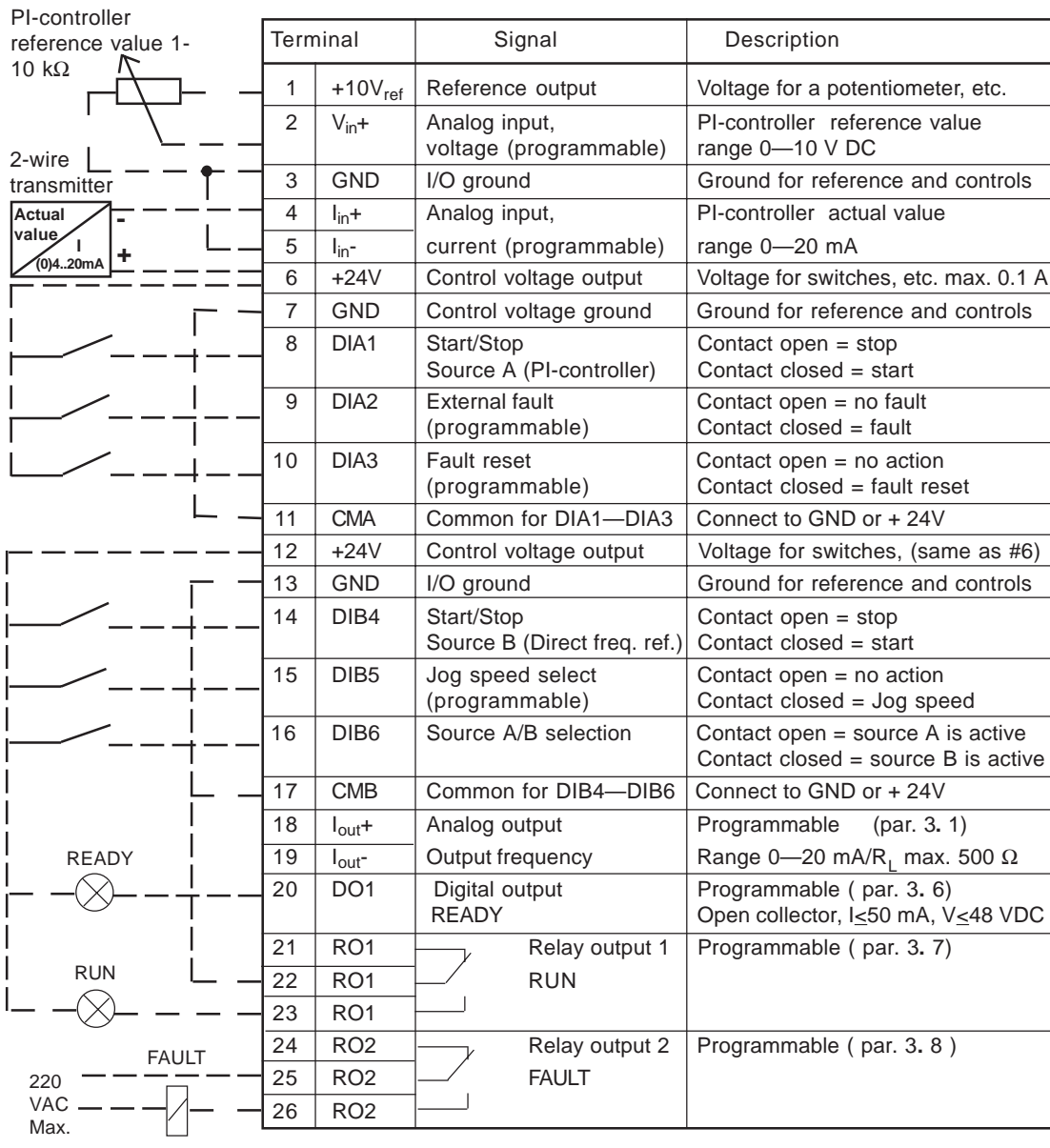

Figure 4.2-1 Default I/O configuration and connection example of the PI-Control Application with 2-wire transmitter.



4.3 Control signal logic

The logic flow of the I/O-control signals and pushbutton signals from the panel is shown in figure 4.3-1.

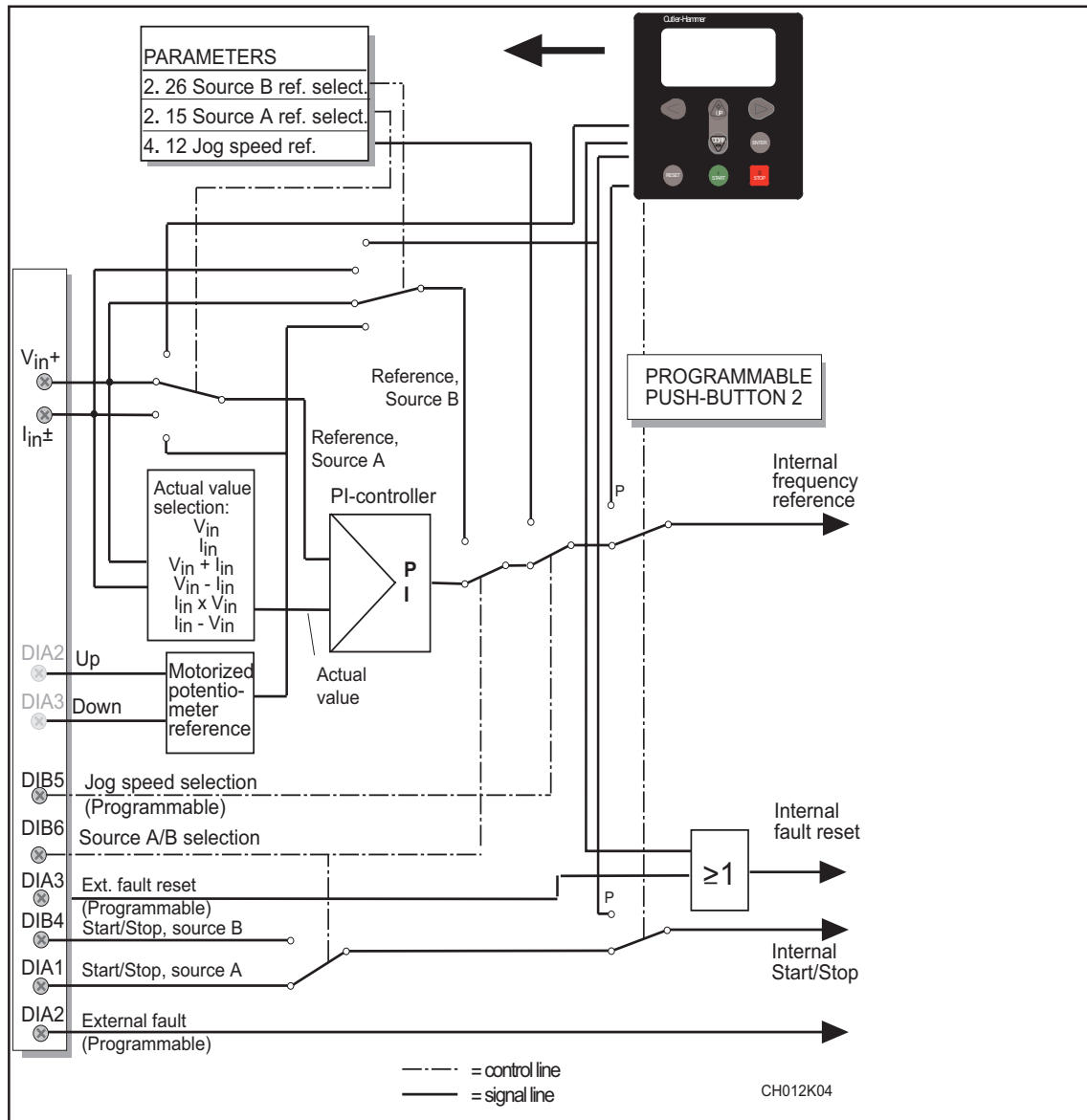

Figure 4.3-1 Control signal logic of the PI- Control Application. Switch positions shown are based on the factory settings.



4.4 Basic parameters, Group 1

4.4.1 Parameter table, Group 1

Code	Parameter	Range	Step	Default	Custom	Description	Page
1.1	Minimum frequency	0— f_{\max}	1 Hz	0 Hz			4-5
1.2	Maximum frequency	f_{\min} -120/500 Hz	1 Hz	60 Hz		*	4-5
1.3	Acceleration time 1	0.1—3000.0 s	0.1 s	1.0 s		Time from f_{\min} (1.1) to f_{\max} (1.2)	4-5
1.4	Deceleration time 1	0.1—3000.0 s	0.1 s	1.0 s		Time from f_{\max} (1.2) to f_{\min} (1.1)	4-5
1.5	PI-controller gain	1—1000%	1 %	100%			4-5
1.6	PI-controller I-time	0.00—320.00 s	0.01s	10.00 s		0 = no Integral time in use	4-5
1.7	Current limit	0.1—2.5 x I_{nSV9}	0.1 A	1.5 x I_{nSV9}		Output current limit [A] of the unit	4-5
1.8	V/Hz ratio selection	0—2	1	0		0 = Linear 1 = Squared 2 = Programmable V/Hz ratio	4-5
1.9	V/Hz optimization	0—1	1	0		0 = None 1 = Automatic torque boost	4-6
1.10	Nominal voltage of the motor	180—690 V	1 V	230 V 380 V 480 V 575 V		Voltage code 2 Voltage code 4 Voltage code 5 Voltage code 6	4-7
1.11	Nominal frequency of the motor	30—500 Hz	1 Hz	60 Hz		f_n from the nameplate of the motor	4-7
1.12	Nominal speed of the motor	1—20000 rpm	1 rpm	1720 rpm **		n_n from the nameplate of the motor	4-7
1.13	Nominal current of the motor	2.5 x I_{nSV9}	0.1 A	I_{nSV9}		I_n from the nameplate of the motor	4-7
1.14	Supply voltage	208—240 380—400 380—500 525—690		230 V 380 V 480 V 575 V		Voltage code 2 Voltage code 4 Voltage code 5 Voltage code 6	4-7
1.15	Parameter conceal	0—1	1	0		Visibility of the parameters: 0 = All parameter groups visible 1 = Only group 1 is visible	4-7
1.16	Parameter value lock	0—1	1	0		Disables parameter changes: 0 = Changes enabled 1 = Changes disabled	4-7

Table 4.4-1 Group 1 basic parameters.

Note!  = Parameter value can be changed only when the drive is stopped.

* If 1.2 > motor synchr. speed, check suitability for motor and drive system.
Selecting 120 Hz/500 Hz range see page 4-5.

** Default value for a four pole motor and a nominal size SV9000.



4.4.2 Description of Group 1 parameters

1. 1, 1. 2 Minimum / maximum frequency

Defines frequency limits of the SV9000.

The default maximum value for parameters 1. 1 and 1. 2 is 120 Hz. By setting 1. 2 = 120 Hz when the drive is stopped (RUN indicator not lit) parameters 1. 1 and 1. 2 are changed to 500 Hz. At the same time the resolution of the panel is changed from 0.01 Hz to 0.1 Hz.

Changing the max. value from 500 Hz to 120 Hz is done by setting parameter 1.2 = 119 Hz while the drive is stopped.

1. 3, 1. 4 Acceleration time 1, deceleration time 1:

These limits correspond to the time required for the output frequency to accelerate from the set minimum frequency (par. 1. 1) to the set maximum frequency (par. 1. 2).

1. 5 PI-controller gain

This parameter defines the gain of the PI-controller.

If this parameter is set to 100%, a 10% change in error value causes the controller output to change by 1.0 Hz.

If the parameter value is set to 0, the PI-controller operates as an I-controller.

1. 6 PI-controller I-time

Defines the integration time of the PI-controller

1. 7 Current limit

This parameter determines the maximum motor current that the SV9000 will provide short term.

1. 8 V/Hz ratio selection

Linear: The voltage of the motor changes linearly with the frequency in the constant flux area from 0 Hz to the field weakening point (par. 6. 3) where a constant voltage (nominal value) is supplied to the motor. See figure 4.4-2.

A linear V/Hz ratio should be used in constant torque applications.

This default setting should be used if there is no special requirement for another setting.

Squared: The voltage of the motor changes following a squared curve form with the frequency in the area from 0 Hz to the field weakening point (par. 6. 3) where the nominal voltage is supplied to the motor. See figure 4.4-2.

The motor runs undermagnetized below the field weakening point and produces less torque and electromechanical noise. A squared V/Hz ratio can be used in applications where the torque demand of the load is proportional to the square of the speed, e.g. in centrifugal fans and pumps.

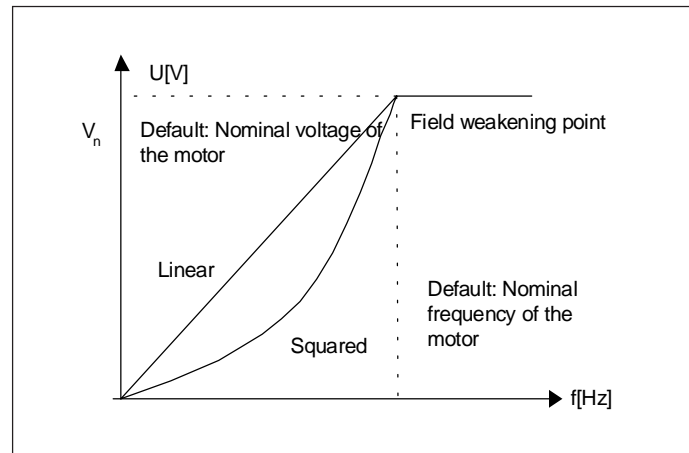

Figure 4.4-2 Linear and squared V/Hz curves

Programm. The V/Hz curve can be programmed with three different points.
 V/Hz curve The parameters for programming are explained in chapter 4.5.2.
 2 A programmable V/Hz curve can be used if the standard settings do not satisfy the needs of the application. See figure 4.4-3.

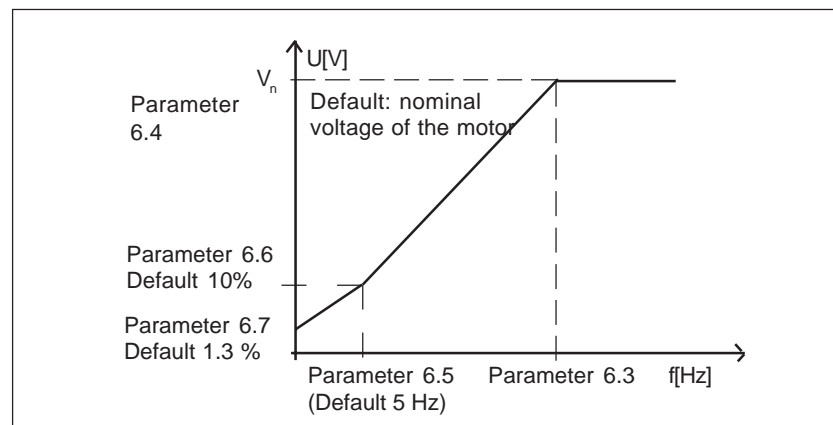

Figure 4.4-3 Programmable V/Hz curve.

1.9 V/Hz optimization

Automatic torque boost The voltage to the motor changes automatically which makes the motor produce enough torque to start and run at low frequencies. The voltage increase depends on the motor type and horsepower.

Automatic torque boost can be used in applications where starting torque due to starting friction is high, e.g. in conveyors.

NOTE! *In high torque - low speed applications - it is likely the motor will overheat. If the motor has to run for a prolonged time under these conditions, special attention must be paid to cooling the motor. Use external cooling for the motor if the temperature rise is too high.*



1. 10 Nominal voltage of the motor

Find this value V_n from the nameplate of the motor.
This parameter sets the voltage at the field weakening point, parameter 6. 4, to $100\% \times V_{n\text{motor}}$.

1. 11 Nominal frequency of the motor

Find the nominal frequency f_n from the nameplate of the motor.
This parameter sets the frequency of the field weakening point, parameter 6. 3, to the same value.

1. 12 Nominal speed of the motor

Find this value n_n from the nameplate of the motor.

1. 13 Nominal current of the motor

Find the value I_n from the nameplate of the motor. The internal motor protection function uses this value as a reference value.

1. 14 Supply voltage

Set parameter value according to the nominal voltage of the supply.
Values are pre-defined for voltage codes 2, 4, 5 and 6. See table 4.4-1.

1. 15 Parameter conceal

Defines which parameter groups are available:

- 0 = all parameter groups are visible
- 1 = only group 1 is visible

1. 16 Parameter value lock

Defines access to the changes of the parameter values:



- 0 = parameter value changes enabled
- 1 = parameter value changes disabled

To adjust more of the functions of the PI-Control application, see chapter 4.5 to modify the parameters of Groups 2—8.

4.5 Special parameters, Groups 2—8





4.5.1 Parameter tables

Group 2, Input signal parameters

Code	Parameter	Range	Step	Default	Custom	Description	Page
2.1	DIA2 function (terminal 9) 	0—10	1	1		0 = Not used 1 = Ext. fault, closing contact 2 = External fault, opening contact 3 = Run enable 4 = Acceler./deceler. time selection 5 = Reverse 6 = Jog speed 7 = Fault reset 8 = Acc./dec. operation prohibit 9 = DC-braking command 10 = Motor (digital) pot. UP	4-15
2.2	DIA3 function (terminal 10) 	0—10	1	7		0 = Not used 1 = Ext. fault, closing contact 2 = External fault, opening contact 3 = Run enable 4 = Acc./dec. time selection 5 = Reverse 6 = Jog speed 7 = Fault reset 8 = Acc./dec. operation prohibit 9 = DC-braking command 10 = Motor (digital) pot. DOWN	4-16
2.3	V _{in} signal range	0—1	1	0		0 = 0—10 V 1 = Custom setting range	4-16
2.4	V _{in} custom setting min.	0.00-100.00%	0.01%	0.00%			4-16
2.5	V _{in} custom setting max.	0.00-100.00%	0.01%	100.00%			4-16
2.6	V _{in} signal inversion	0—1	1	0		0 = Not inverted 1 = Inverted	4-16
2.7	V _{in} signal filter time	0.00—10.00 s	0.01 s	0.10 s		0 = No filtering	4-17
2.8	I _{in} signal range	0—2	1	0		0 = 0—20 mA 1 = 4—20 mA 2 = Custom setting range	4-17
2.9	I _{in} custom setting min.	0.00-100.00%	0.01%	0.00%			4-17
2.10	I _{in} custom setting max.	0.00-100.00%	0.01%	100.00%			4-17
2.11	I _{in} signal inversion	0—1	1	0		0 = Not inverted 1 = Inverted	4-17
2.12	I _{in} signal filter time	0.01—10.00 s	0.01s	0.10 s		0 = No filtering	4-18
2.13	DIB5 function (terminal 15) 	0—9	1	6		0 = Not used 1 = Ext. fault, closing contact 2 = External fault, opening contact 3 = Run enable 4 = Acc./dec. time selection 5 = Reverse 6 = Jog speed 7 = Fault reset 8 = Acc./dec. operation prohibit 9 = DC-braking command	4-18

Note!  = Parameter value can be changed only when the drive is stopped







Code	Parameter	Range	Step	Default	Custom	Description	Page
2.14	Motor (digital) potentiometer ramp time	0.1—2000.0 Hz/s	0.1 Hz/s	10.0 Hz/s			4-18
2.15	PI-controller reference signal (source A) 	0—4	1	0		0 = Analog voltage input (term. 2) 1 = Analog current input (term. 4) 2 = Set reference from the panel (reference r2) 3 = Signal from internal motor pot. 4 = Signal from internal motor pot. reset if SV9000 is stopped	4-19
2.16	PI-controller actual value selection 	0—3	1	0		0 = Actual value 1 1 = Actual 1 + Actual 2 2 = Actual 1 - Actual 2 3 = Actual 1 * Actual 2	4-19
2.17	Actual value 1 input 	0—2	1	2		0 = No 1 = Voltage input 2 = Current input	4-19
2.18	Actual value 2 input 	0—2	1	0		0 = No 1 = Voltage input 2 = Current input	4-19
2.19	Actual value 1 min scale	-320.00%—+320.00%	0.01%	0.00%		0 % = No minimum scaling	4-19
2.20	Actual value 1 max scale	-320.00%—+320.00%	0.01%	100.0%		100 % = No maximum scaling	4-19
2.21	Actual value 2 min scale	-320.00%—+320.00%	0.01%	0.00%		0 % = No minimum scaling	4-19
2.22	Actual value 2 max scale	-320.00%—+320.00%	0.01%	100.0%		100 % = No maximum scaling	4-19
2.23	Error value inversion	0—1	1	0		0 = No 1 = Yes	4-19
2.24	PI-controller min. limit	f_{\min} — f_{\max} (1.1) (1.2)	0.1 Hz	0.0 Hz			4-20
2.25	PI-controller max. limit	f_{\min} — f_{\max} (1.1) (1.2)	0.1 Hz	50.0 Hz			4-20
2.26	Direct frequency reference, source B 	0—4	1	0		0 = Analog voltage input (term. 2) 1 = Analog current input (term. 4) 2 = Set reference from the panel (reference r1) 3 = Signal from internal motor pot. 4 = Signal from internal motor pot. reset if SV9000 stopped	4-20
2.27	Source B reference scaling minimum value	0— par. 2.28	1 Hz	0 Hz		Selects the frequency that corresponds to the min. reference signal	4-20
2.28	Source B reference scaling maximum value	0— f_{\max} (1.2)	1 Hz	0 Hz		Selects the frequency that corresponds to the max. reference signal 0 = Scaling off >0 = Scaled maximum value	4-20

Note!  = Parameter value can be changed only when the drive is stopped.



Group 3, Output and supervision parameters

Code	Parameter	Range	Step	Default	Custom	Description	Page
3.1	Analog output function 	0—7	1	1		0 = Not used 1 = O/P frequency (0— f_{max}) 2 = Motor speed (0—max. speed) 3 = O/P current (0— $2.0 \times I_{nSV9}$) 4 = Motor torque (0— $2 \times T_{nMot}$) 5 = Motor power (0— $2 \times P_{nMot}$) 6 = Motor voltage (0—100% $\times V_{nMot}$) 7 = DC-link volt. (0—1000 V) Scale 100%	4-21
3.2	Analog output filter time	0.00—10.00 s	0.01s	1.00s			4-21
3.3	Analog output inversion	0—1	1	0		0 = Not inverted 1 = Inverted	4-21
3.4	Analog output minimum	0—1	1	0		0 = 0 mA 1 = 4 mA	4-21
3.5	Analog output scale	10—1000%	1%	100%			4-21
3.6	Digital output function 	0—21	1	1		0 = Not used 1 = Ready 2 = Run 3 = Fault 4 = Fault inverted 5 = SV9000 overheat warning 6 = External fault or warning 7 = Reference fault or warning 8 = Warning 9 = Reversed 10 = Jog speed selected 11 = At speed 12 = Motor regulator activated 13 = Output freq. limit superv. 1 14 = Output freq. limit superv. 2 15 = Torque limit supervision 16 = Reference limit supervision 17 = External brake control 18 = Control from I/O terminals 19 = Drive temperature limit supervision 20 = Unrequested rotation direction 21 = External brake control inverted	4-22
3.7	Relay output 1 function 	0—21	1	2		As parameter 3. 6	4-22
3.8	Relay output 2 function 	0—21	1	3		As parameter 3. 6	4-22
3.9	Output freq. limit 1 supervision function	0—2	1	0		0 = No 1 = Low limit 2 = High limit	4-22
3.10	Output freq. limit 1 supervision value	0.0— f_{max} (par. 1. 2)	0.1 Hz	0.0 Hz			4-22

Note!  = Parameter value can be changed only when the drive is stopped.



Code	Parameter	Range	Step	Default	Custom	Description	Page
3.11	Output freq. limit 2 supervision function	0—2	1	0		0 = No 1 = Low limit 2 = High limit	4-22
3.12	Output freq. limit 2 supervision value	0.0— f_{max} (par. 1.2)	0.1 Hz	0.0 Hz			4-22
3.13	Torque limit supervision function	0—2	1	0		0 = No 1 = Low limit 2 = High limit	4-23
3.14	Torque limit supervision value	0.0—200.0% $\times T_{nSV9}$	0.1%	100.0%			4-23
3.15	Active reference limit supervision function	0—2	1	0		0 = No 1 = Low limit 2 = High limit	4-23
3.16	Active reference limit supervision value	0.0— f_{max} (par. 1.2)	0.1 Hz	0.0 Hz			4-23
3.17	External brake off-delay	0.0—100.0 s	1	0.5 s			4-23
3.18	External brake on-delay	0.0—100.0 s	1	1.5 s			4-23
3.19	Drive temperature limit supervision	0—2	1	0		0 = No 1 = Low limit 2 = High limit	4-23
3.20	Drive temperature limit	-10—+75°C	1	+40°C			4-23
3.21	I/O-expander board (opt.) analog output function	0—7	1	3		See parameter 3.1	4-21
3.22	I/O-expander board (opt.) analog output filter time	0.00—10.00 s	0.01s	1.00s		See parameter 3.2	4-21
3.23	I/O-expander board (opt.) analog output inversion	0—1	1	0		See parameter 3.3	4-21
3.24	I/O-expander board (opt.) analog output minimum	0—1	1	0		See parameter 3.4	4-21
3.25	I/O-expander board (opt.) analog output scale	10—1000%	1	100%		See parameter 3.5	4-21

Group 4, Drive control parameters

Code	Parameter	Range	Step	Default	Custom	Description	Page
4.1	Acc./Dec. ramp 1 shape	0.0—10.0 s	0.1 s	0.0 s		0 = Linear >0 = S-curve acc./dec. time	4-24
4.2	Acc./Dec. ramp 2 shape	0.0—10.0 s	0.1 s	0.0 s		0 = Linear >0 = S-curve acc./dec. time	4-24
4.3	Acceleration time 2	0.1—3000.0 s	0.1 s	10.0 s			4-24
4.4	Deceleration time 2	0.1—3000.0 s	0.1 s	10.0 s			4-24
4.5	Brake chopper 	0—2	1	0		0 = Brake chopper not in use 1 = Brake chopper in use 2 = External brake chopper	4-25
4.6	Start function	0—1	1	0		0 = Ramp 1 = Flying start	4-25

Note!  = Parameter value can be changed only when the drive is stopped.









Code	Parameter	Range	Step	Default	Custom	Description	Page
4.7	Stop function	0—1	1	0		0 = Coasting 1 = Ramp	4-25
4.8	DC-braking current	0.15—1.5 x I_{nsv0} (A)	0.1 A	0.5 x I_{nsv0}			4-25
4.9	DC-braking time at Stop	0.00-250.00s	0.01 s	0.00 s		0 = DC-brake is off at Stop	4-25
4.10	Turn on frequency of DC-brake at ramp Stop	0.1-10.0 Hz	0.1 Hz	1.5 Hz			4-26
4.11	DC-brake time at Start	0.00—25.00s	0.01 s	0.00 s		0 = DC-brake is off at Start	4-27
4.12	Jog speed reference	f_{min} — f_{max} (1.1) (1.2)	0.1 Hz	10.0 Hz			4-27

Group 5, Prohibit frequency parameters

Code	Parameter	Range	Step	Default	Custom	Description	Page
5.1	Prohibit frequency range 1 low limit	f_{min} — par. 5.2	0.1 Hz	0.0 Hz			4-27
5.2	Prohibit frequency range 2 high limit	f_{min} — f_{max} (1.1) (1.2)	0.1 Hz	0.0 Hz		0 = no prohibit frequency range	4-27
5.3	Prohibit frequency range 2 low limit	f_{min} — par. 5.4	0.1 Hz	0.0 Hz			4-27
5.4	Prohibit frequency range 2 high limit	f_{min} — f_{max} (1.1) (1.2)	0.1 Hz	0.0 Hz		0 = no prohibit frequency range	4-27
5.5	Prohibit frequency range 3 low limit	f_{min} — par. 5.6	0.1 Hz	0.0 Hz			4-27
5.6	Prohibit frequency range 3 high limit	f_{min} — f_{max} (1.1) (1.2)	0.1 Hz	0.0 Hz		0 = no prohibit frequency range	4-27

4

Group 6, Motor control parameters

Code	Parameter	Range	Step	Default	Custom	Description	Page
6.1	Motor control mode 	0—1	1	0		0 = Frequency control 1 = Speed control	4-27
6.2	Switching frequency	1.0-16.0 kHz	0.1 kHz	10/3.6kHz		Depends on Hp rating	4-27
6.3	Field weakening point 	30—500 Hz	1 Hz	Param. 1.11			4-28
6.4	Voltage at field weakening point 	15—200% x V_{nmot}	1%	100%			4-28
6.5	V/Hz-curve mid point frequency 	0.0— f_{max}	0.1 Hz	0.0 Hz			4-28
6.6	V/Hz-curve mid point voltage 	0.00-100.00% x V_{nmot}	0.01%	0.00%			4-28
6.7	Output voltage at zero frequency 	0.00-100.00% x V_{nmot}	0.01%	0.00%			4-28
6.8	Overvoltage controller	0—1	1	1		0 = Controller is not operating 1 = Controller is in operation	4-28
6.9	Undervoltage controller	0—1	1	1		0 = Controller is not operating 1 = Controller is in operation	4-28

Note!  = Parameter value can be changed only when the drive is stopped.



Group 7, Protections

Code	Parameter	Range	Step	Default	Custom	Description	Page
7.1	Response to reference fault	0—3	1	0		0 = No action 1 = Warning 2 = Fault, stop according to par. 4.7 3 = Fault, always coasting stop	4-29
7.2	Response to external fault	0—3	1	2		0 = No action 1 = Warning 2 = Fault, stop according to par. 4.7 3 = Fault, always coasting stop	4-29
7.3	Phase supervision of the motor	0—2	2	2		0 = No action 2 = Fault	4-29
7.4	Ground fault protection	0—2	2	2		0 = No action 2 = Fault	4-29
7.5	Motor thermal protection	0—2	1	2		0 = No action 1 = Warning 2 = Fault	4-30
7.6	Motor thermal protection break point current	50.0—150.0 % $\times I_{nMOTOR}$	1.0 %	100.0%			4-30
7.7	Motor thermal protection zero frequency current	5.0—150.0 % $\times I_{nMOTOR}$	1.0 %	45.0%			4-30
7.8	Motor thermal protection time constant	0.5—300.0 minutes	0.5 min.	17.0 min.		Default value is set according to motor nominal current	4-31
7.9	Motor thermal protection break point frequency	10—500 Hz	1 Hz	35 Hz			4-31
7.10	Stall protection	0—2	1	1		0 = No action 1 = Warning 2 = Fault	4-32
7.11	Stall current limit	5.0—200.0 % $\times I_{nMOTOR}$	1.0%	130.0%			4-32
7.12	Stall time	2.0—120.0 s	1.0 s	15.0 s			4-33
7.13	Maximum stall frequency	1— f_{max}	1 Hz	25 Hz			4-33
7.14	Underload protection	0—2	1	0		0 = No action 1 = Warning 2 = Fault	4-33
7.15	Underload prot., field weakening area load	10.0—150.0 % $\times T_{nMOTOR}$	1.0%	50.0%			4-34
7.16	Underload protection, zero frequency load	5.0—150.0 % $\times T_{nMOTOR}$	1.0%	10.0%			4-34
7.17	Underload time	2.0—600.0 s	1.0 s	20.0s			4-34



Group 8, Autorestart parameters

Code	Parameter	Range	Step	Default	Custom	Description	Page
8.1	Automatic restart: number of tries	0—10	1	0		0 = not in use	4-34
8.2	Automatic restart: multi attempt maximum trial time	1—6000 s	1 s	30 s			4-34
8.3	Automatic restart: start function	0—1	1	0		0 = Ramp 1 = Flying start	4-35
8.4	Automatic restart after undervoltage trip	0—1	1	0		0 = No 1 = Yes	4-35
8.5	Automatic restart after overvoltage trip	0—1	1	0		0 = No 1 = Yes	4-35
8.6	Automatic restart after overcurrent trip	0—1	1	0		0 = No 1 = Yes	4-35
8.7	Automatic restart after reference fault trip	0—1	1	0		0 = No 1 = Yes	4-35
8.8	Automatic restart after over/undertemperature fault trip	0—1	1	0		0 = No 1 = Yes	4-35

Table 4.5-1 Special parameters, Groups 2—8.



4.5.2 Description of Groups 2—8 parameters

2.1 DIA2 function

1: External fault,	closing contact	= Fault is shown and drive responds according to parameter 7.2.
2: External fault,	opening contact	= Fault is shown and drive responds according to parameter 7.2.
3: Run enable	contact open	= Start of the motor disabled
	contact closed	= Start of the motor enabled
4: Acc. / Dec time select.	contact open	= Acceleration/Deceleration time 1 selected
	contact closed	= Acceleration/Deceleration time 2 selected
5: Reverse	contact open	= Forward
	contact closed	= Reverse
		If two or more inputs are programmed to reverse, only one of them is required to reverse
6: Jog speed	contact closed	= Jog speed selected for frequency reference.
7: Fault reset	contact closed	= Resets all faults
8: Acc./Dec. operation prohibited	contact closed	= Stops acceleration and deceleration until the contact is opened
9: DC-braking command	contact closed	= In the stop mode, the DC-braking operates until the contact is opened, see figure 4.5-1. DC-brake current is set with parameter 4.8.
10: Motor(digital) pot. UP	contact closed	= Reference increases until the contact is opened

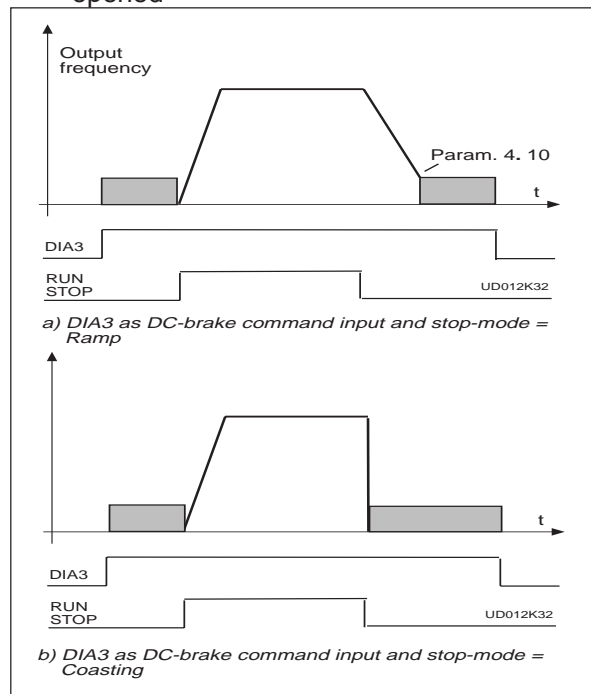

Figure 4.5-1 DIA3 as DC-brake command input:
 a) Stop-mode = ramp,
 b) Stop-mode = coasting



2. 2 DIA3 function

Selections are same as in 2.1 except :

10: Motor(digital) contact closed = Reference decreases until the contact is
pot. DOWN opened

2. 3 V_{in} signal range

0 = Signal range 0—10 V

1 = Custom setting range from custom minimum (par. 2. 4) to custom maximum (par. 2. 5)

2. 4, 2. 5 V_{in} custom setting minimum/maximum

These parameters set V_{in} for any input signal span within 0—10 V.

Minimum setting: Set the V_{in} signal to its minimum level, select parameter 2. 4, press the Enter button

Maximum setting: Set the V_{in} signal to its maximum level, select parameter 2. 5, press the Enter button

Note! The parameter values can only be set with this procedure (not with arrow up/arrow down buttons)

2. 6 V_{in} signal inversion

Parameter 2. 6 = 0, no inversion of analog V_{in} signal.

Parameter 2. 6 = 1, inversion of analog V_{in} signal.

2.7 V_{in} signal filter time

Filters out disturbances from the incoming analog V_{in} signal. A long filtering time makes drive response slower. See figure 4.5-2.

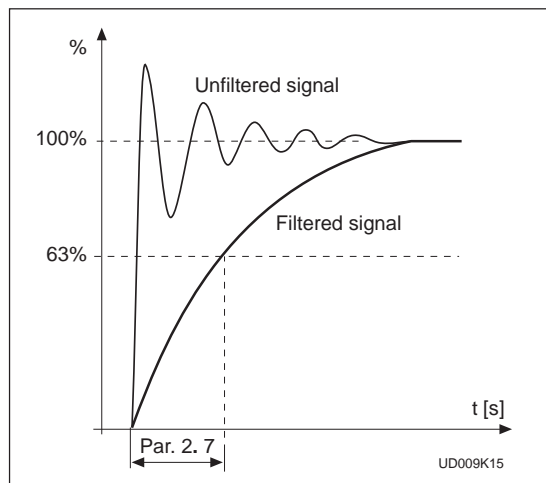

Figure 4.5-2 V_{in} signal filtering.

2.8 Analog input I_{in} signal range

- 0 = 0—20 mA
- 1 = 4—20 mA
- 2 = Custom signal span

2.9 Analog input I_{in} custom setting minimum/maximum

2.10

With these parameters you can scale the input current signal (I_{in}) signal range between 0—20 mA.

Minimum setting: Set the I_{in} signal to its minimum level, select parameter 2.9, press the Enter button

Maximum setting: Set the I_{in} signal to its maximum level, select parameter 2.10, press the Enter button

Note! The parameter values can only be set with this procedure (not with arrow up/arrow down buttons)

2.11 Analog input I_{in} inversion

Parameter 2.11 = 0, no inversion of I_{in} input.

Parameter 2.11 = 1, inversion of I_{in} input.

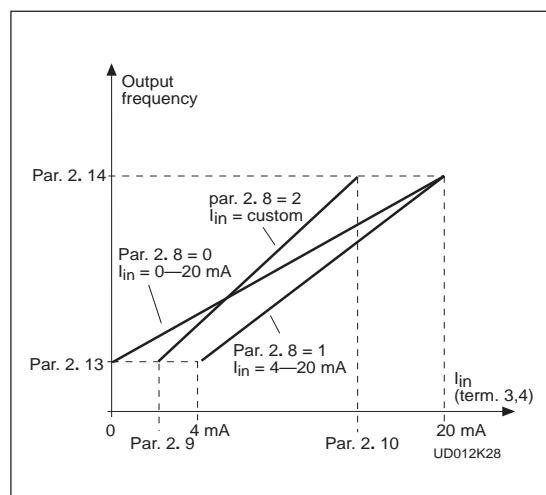

Figure 4.5-3 Analog input I_{in} scaling.

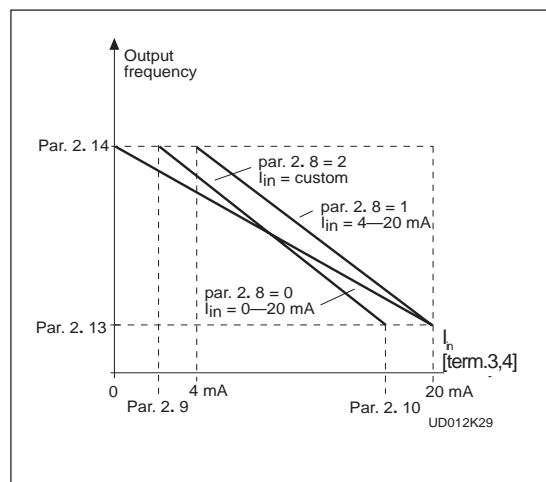

Figure 4.5-4 I_{in} signal inversion.



2.12 Analog input I_{in} filter time

Filters out disturbances from the incoming analog I_{in} signal. A long filtering time makes drive response slower. See figure 4.5-3.

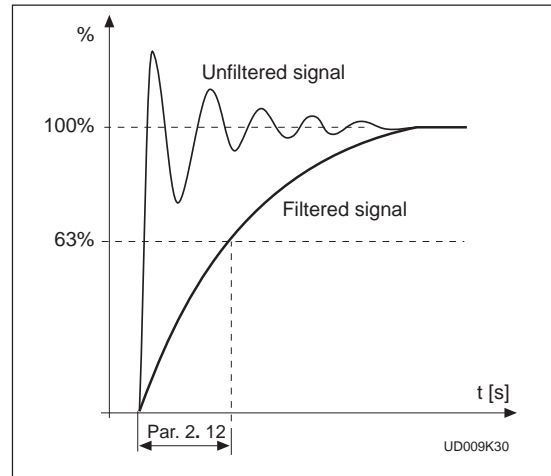

Figure 4.5-5 Analog input I_{in} filter time.

2.13 DIA5 function

- | | |
|--|---|
| 1: External fault, closing contact | = Fault is shown and motor is stopped when the input is active |
| 2: External fault, opening contact | = Fault is shown and motor is stopped when the input is not active |
| 3: Run enable contact open | = Start of the motor disabled |
| contact closed | = Start of the motor enabled |
| 4: Acc. / Dec time select. contact open | = Acceleration/Deceleration time 1 selected |
| contact closed | = Acceleration/Deceleration time 2 selected |
| 5: Reverse contact open | = Forward |
| contact closed | = Reverse |
| | If two or more inputs are programmed to reverse, only one of them is required to reverse |
| 6: Jog speed contact closed | = Jog speed selected for frequency reference |
| 7: Fault reset contact closed | = Resets all faults |
| 8: Acc./Dec. operation prohibited contact closed | = Stops acceleration and deceleration until the contact is opened |
| 9: DC-braking command contact closed | = In the stop mode, the DC-braking operates until the contact is opened, see figure 4.5-1. DC-brake current is set with parameter 4. 8. |

2.14 Motor potentiometer ramp time

Defines how fast the electronic motor (digital) potentiometer value changes.

2. 15 PI-controller reference signal

- 0** Analog voltage reference from terminals 2—3, e.g. a potentiometer
- 1** Analog current reference from terminals 4—5, e.g. a transducer.
- 2** Panel reference is the reference set from the Reference Page (REF).
Reference r2 is the PI-controller reference, see chapter 4.7.
- 3** Reference value is changed with digital input signals DIA2 and DIA3.
- switch in DIA2 closed = frequency reference increases
- switch in DIA3 closed = frequency reference decreases
Speed of the reference change can be set with the parameter 2. 3.
- 4** Same as setting 3 but the reference value is set to the minimum frequency (par. 1. 1) each time the drive is stopped. When the value of parameter 1. 5 is set to 3 or 4, the value of parameter 2. 1 is automatically set to 4 and value of the parameter 2. 2 is automatically set to 10.

2. 16 PI-controller actual value selection**2. 17 Actual value 1****2. 18 Actual value 2**

These parameters select the PI-controller actual value.

2. 19 Actual value 1 minimum scale

Sets the minimum scaling point for Actual value 1. See figure 4.5-6.

2. 20 Actual value 1 maximum scale

Sets the maximum scaling point for Actual value 1. See figure 4.5-6.

2. 21 Actual value 2 minimum scale

Sets the minimum scaling point for Actual value 2. See figure 4.5-6.

2. 22 Actual value 2 maximum scale

Sets the maximum scaling point for Actual value 2. See figure 4.5-6.

2. 23 Error value inversion

This parameter allows you to invert the error value of the PI-controller (and thus the the operation of the PI-controller).

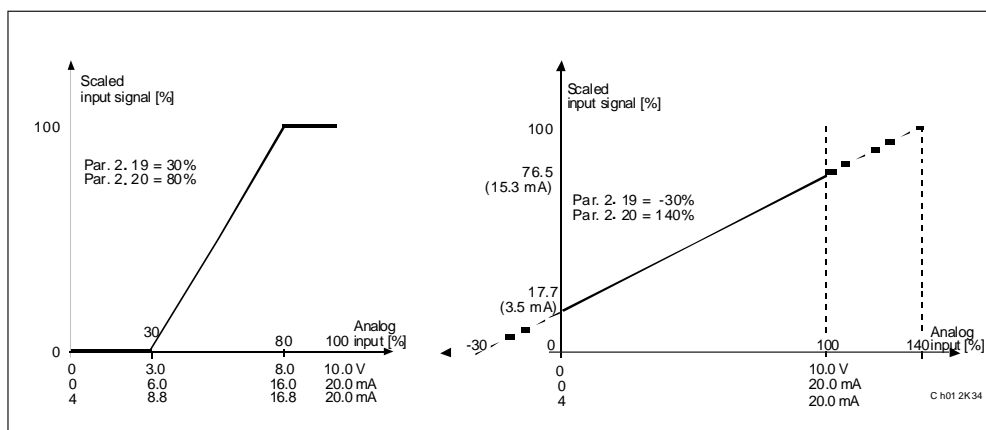

Figure 4.5-6 Examples of actual value scaling of PI-regulator.

2. 24 PI-controller minimum limit**2. 25 PI-controller maximum limit**

These parameter set the minimum and maximum values of the PI-controller output.
Parameter value limits: par 1.1 < par. 2. 24 < par. 2. 2 5.

2. 26 Direct frequency reference. Place B

- 0** Analog voltage reference from terminals 2—3, e.g. a potentiometer
- 1** Analog current reference from terminals 4—5, e.g. a transducer.
- 2** Panel reference is the reference set from the Reference Page (REF), Reference r1 is the Place B reference, see chapter 6.
- 3** Reference value is changed with digital input signals DIA2 and DIA3
 - switch in DIA2 closed = frequency reference increases
 - switch in DIA3 closed = frequency reference decreases
 Speed of the reference change can be set with the parameter 2. 3.
- 4** Same as setting 3, but the reference value is set to the minimum frequency (par. 1. 1) each time the drive is stopped. When the value of the parameter 1.5 is set to 3 or 4, value of the parameter 2. 1 is automatically set to 4 and value of the parameter 2. 2 is automatically set to 10.

2. 27 Source B reference scaling, minimum value/maximum value

Setting limits: 0 < par. 2. 27 < par. 2. 28 < par. 1. 2.

If par. 2. 28 = 0 scaling is set off.

See figures 4.5-7 and 4.5-8.

(In the figures below the voltage input V_{in} with signal range 0—10 V is selected for source B reference)

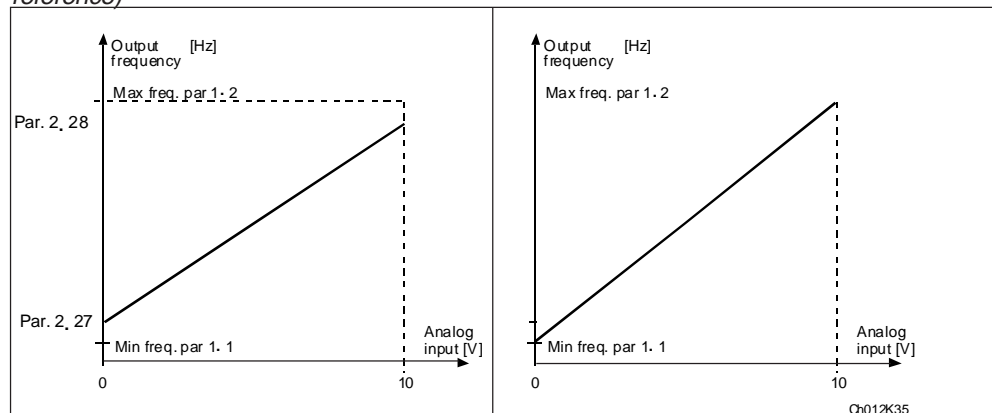

Figure 4.5-7 Reference scaling.

Figure 4.5-8 Reference scaling, par. 2. 28 = 0

3.1 Analog output Content

See table on page 4-10.

3.2 Analog output filter time

Filters the analog output signal.
See figure 4.5-9.

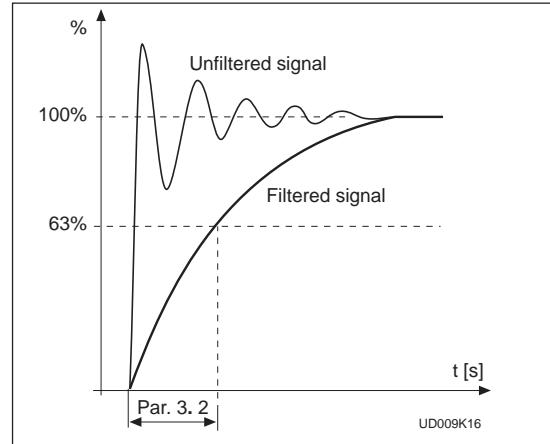

Figure 4.5-9 Analog output filtering

3.3 Analog output invert

Inverts analog output signal:
max output signal = minimum set value
min output signal = maximum set value

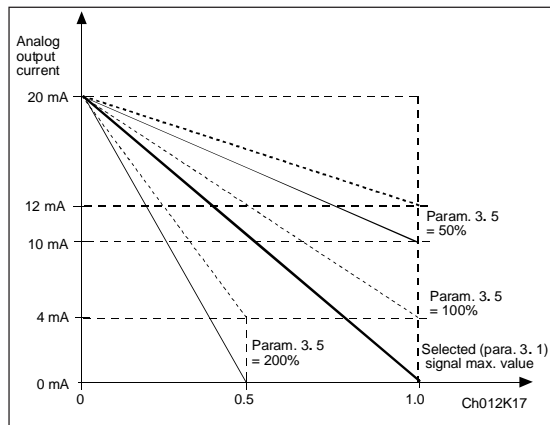

Figure 4.5-10 Analog output invert.

3.4 Analog output minimum

Defines the signal minimum to be either 0 mA or 4 mA. See figure 4.5-9.

3.5 Analog output scale

Scaling factor for analog output.
See figure 4.5-11.

Signal	Max. value of the signal
Output frequency	Max. frequency (p. 1. 2)
Motor speed	Max. speed ($n_n \times f_{max} / f_n$)
Output current	$2 \times I_{nSV9}$
Motor torque	$2 \times T_{nMot}$
Motor power	$2 \times P_{nMot}$
Motor voltage	$100\% \times V_{nMot}$
DC-link volt.	1000 V

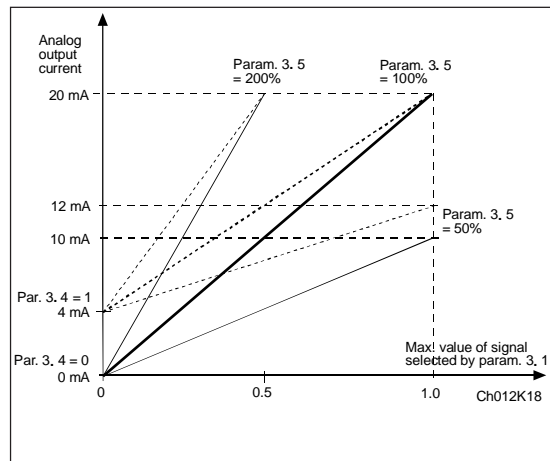

Figure 4.5-11 Analog output scale.



- 3.6 **Digital output function**
- 3.7 **Relay output 1 function**
- 3.8 **Relay output 2 function**

Setting value	Signal content
0 = Not used	Out of operation <u>Digital output DO1 sinks current and programmable relay (RO1, RO2) is activated when:</u>
1 = Ready	The drive is ready to operate
2 = Run	The drive operates (motor is running)
3 = Fault	A fault trip has occurred
4 = Fault inverted	a fault trip <u>has not</u> occurred
5 = SV9000 overheat warning	The heat-sink temperature exceeds +70°C
6 = External fault or warning	Fault or warning depending on parameter 7. 2
7 = Reference fault or warning	Fault or warning depending on parameter 7. 1 - if analog reference is 4—20 mA and signal is <4mA
8 = Warning	Always if a warning exists (see Table 7.10-1 in Users' manual)
9 = Reversed	The reverse command has been selected
10= Jog speed	Jog speed has been selected with digital input
11= At speed	The output frequency has reached the set reference
12= Motor regulator activated	Overvoltage or overcurrent regulator was activated
13= Output frequency supervision 1	The output frequency goes outside of the set supervision Low limit/ High limit (par. 3. 9 and 3. 10)
14= Output frequency supervision 2	The output frequency goes outside of the set supervision Low limit/ High limit (par. 3. 11 and 3. 12)
15= Torque limit supervision	The motor torque goes outside of the set supervision Low limit/ High limit (par. 3. 13 and 3. 14)
16= Active reference limit supervision	Active reference goes outside of the set supervision Low limit/ High limit (par. 3. 15 and 3. 16)
17= External brake control	External brake ON/OFF control with programmable delay (par 3. 17 and 3. 18)
18= Control from I/O terminals	External control mode selected with progr. push-button #2
19= Drive temperature limit supervision	Temperature on drive goes outside the set supervision limits (par. 3. 19 and 3. 20)
20= Unrequested rotation direction	Rotation direction of the motor shaft is different from the requested one
21 = External brake control inverted	External brake ON/OFF control (par. 3.18 and 3.18) output active when brake control is OFF

Table 4.5-2 Output signals via DO1 and output relays RO1 and RO2.

- 3.9 **Output frequency limit 1, supervision function**
- 3.11 **Output frequency limit 2, supervision function**

- 0 = No supervision
- 1 = Low limit supervision
- 2 = High limit supervision

If the output frequency goes under/over the set limit (3. 10, 3. 12) this function generates a warning message via the digital output DO1 or via a relay output RO1 or RO2 depending on the settings of the parameters 3. 6—3. 8.

- 3.10 **Output frequency limit 1, supervision value**
- 3.12 **Output frequency limit 2, supervision value**

The frequency value to be supervised by the parameter 3. 9 (3. 11).

See figure 4.5-12.



3. 13 Torque limit , supervision function

- 0 = No supervision
- 1 = Low limit supervision
- 2 = High limit supervision

If the calculated torque value goes under/over the set limit (3. 14) this function generates a warning message via the digital output DO1 or via a relay output RO1 or RO2 depending on the settings of the parameters 3. 6—3. 8.

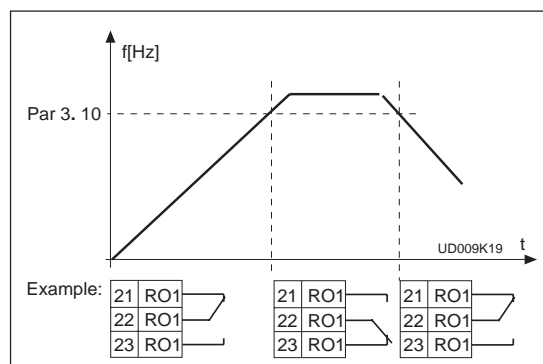

Par. 3.9 = 2

Figure 4.5-12 Output frequency supervision.

3. 14 Torque limit , supervision value

The calculated torque value to be supervised by the parameter 3. 13.

3. 15 Reference limit , supervision function

- 0 = No supervision
- 1 = Low limit supervision
- 2 = High limit supervision

If the reference value goes under/over the set limit (3. 16) this function generates a warning message via the digital output DO1 or via a relay output RO1 or RO2 depending on the settings of the parameters 3. 6—3. 8. The supervised reference is the current active reference. It can be source A or B reference depending on DIB6 input or panel reference if panel is the active control place.

3. 16 Reference limit , supervision value

The frequency value to be supervised by the parameter 3. 15.

3. 17 External brake-off delay

3. 18 External brake-on delay

The function of the external brake can be delayed from the start and stop control signals with these parameters. See figure 4.5-13.

The brake control signal can be programmed via the digital output DO1 or via one of the relay outputs RO1 and RO2, see parameters 3. 6—3. 8.

3. 19 Drive temperature limit supervision

- 0 = No supervision
- 1 = Low limit supervision
- 2 = High limit supervision

If the temperature of the drive goes under/over the set limit (3. 20) this function generates a warning message via the digital output DO1 or via a relay output RO1 or RO2 depending on the settings of the parameters 3. 6—3. 8.

3. 20 Drive temperature limit value

The temperature value to be supervised by parameter 3. 19.

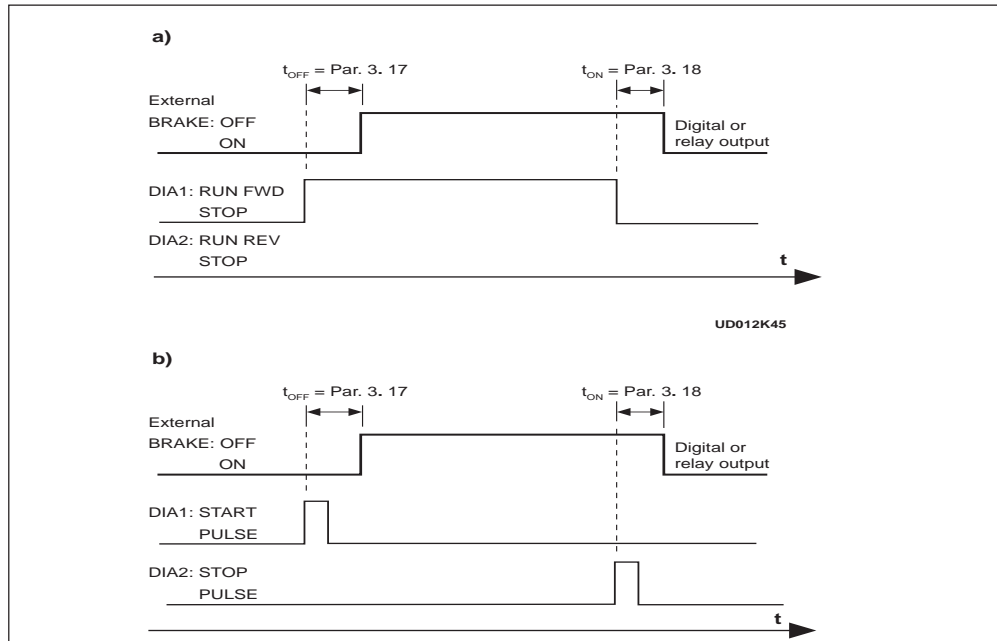

Figure 4.5-13 External brake control: a) Start/Stop logic selection par. 2. 1 = 0, 1 or 2 b) Start/Stop logic selection par. 2. 1 = 3.

- 4.1 Acc/Dec ramp 1 shape
- 4.2 Acc/Dec ramp 2 shape

The acceleration and deceleration ramp shape can be programmed with these parameters.

Setting the value = 0 gives you a linear ramp shape. The output frequency immediately follows the input with a ramp time set by parameters 1. 3, 1. 4 (4. 3, 4. 4 for Acc/Dec time 2).

Setting 0.1—10 seconds for 4. 1 (4. 2) causes an S-shaped ramp. The speed changes are smooth. Parameter 1. 3/ 1. 4 (4. 3/ 4. 4) determines the ramp time of the acceleration/deceleration in the middle of the curve. See figure 4.5-14.

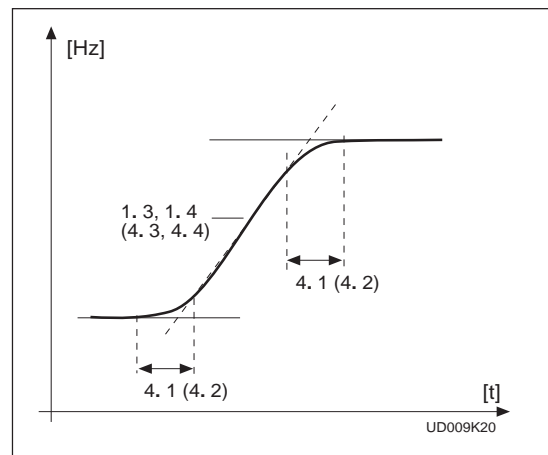

Figure 4.5-14 S-shaped acceleration/ deceleration.

- 4.3 Acceleration time 2
- 4.4 Deceleration time 2

These values correspond to the time required for the output frequency to accelerate from the set minimum frequency (par. 1. 1) to the set maximum frequency (par. 1. 2). With this parameter it is possible to set two different acceleration/ deceleration times for one application. The active set can be selected with the programmable signal DIA3 of this application, see parameter 2. 2.



4.5 Brake chopper

- 0 = No brake chopper
- 1 = Brake chopper and brake resistor installed
- 2 = External brake chopper

When the drive is decelerating the motor, the energy stored in the inertia of the motor and the load is fed into the external brake resistor. If the brake resistor is selected correctly the drive is able to decelerate the load with a torque equal to that of acceleration. See the separate Brake resistor installation manual.

4.6 Start function

Ramp:

- 0 The drive starts from 0 Hz and accelerates to the set reference frequency within the set acceleration time. (Load inertia or starting friction may extend the acceleration times).

Flying start:

- 1 The drive starts into a running motor by first finding the speed the motor is running at. Searching starts from the maximum frequency down until the actual frequency reached. The output frequency then accelerates/ decelerates to the set reference value at a rate determined by the acceleration/deceleration ramp parameters.

Use this mode if the motor may be coasting when the start command is given. With the flying start it is possible to ride through short utility voltage interruptions.

4.7 Stop function

Coasting:

- 0 The motor coasts to an uncontrolled stop with the SV9000 off, after the Stop command.

Ramp:

- 1 After the Stop command, the speed of the motor is decelerated according to the deceleration ramp time parameter. If the regenerated energy is high it may be necessary to use an external braking resistor for faster deceleration.

4.8 DC braking current

Defines the current injected into the motor during the DC braking.

4.9 DC braking time at stop

Defines if braking is ON or OFF and the braking time of the DC-brake when the motor is stopping. The function of the DC-brake depends on the stop function, parameter 4. 7. See figure 4.5-15.

- 0 DC-brake is not used
- >0 DC-brake is in use and its function depends on the Stop function, (param. 4. 7), and the time depends on the value of parameter 4. 9:



Stop-function = 0 (coasting):

After the stop command, the motor will coast to a stop with the SV9000 off.

With DC-injection, the motor can be electrically stopped in the shortest possible time, without using an optional external braking resistor.

The braking time is scaled according to the frequency when the DC-braking starts. If the frequency is \geq nominal frequency of the motor (par. 1.11), setting value of parameter 4.9 determines the braking time. When the frequency is $\leq 10\%$ of the nominal, the braking time is 10% of the set value of parameter 4.9.

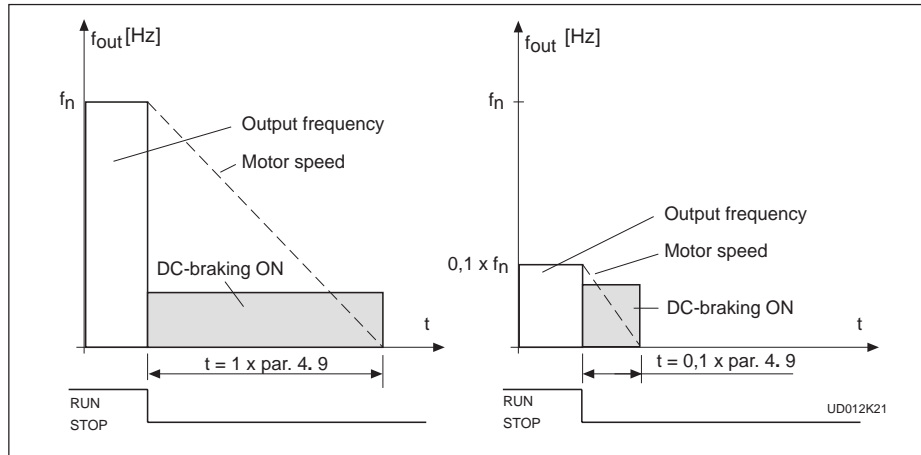

Figure 4.5-15 DC-braking time when par. 4. 7 = 0.

Stop-function = 1 (ramp):

After the stop command, the speed of the motor is reduced based on the deceleration ramp parameter, if no regeneration occurs due to load inertia, to a speed defined with parameter 4. 10 where the DC-braking starts.

The braking time is defined with parameter 4. 9.

If high inertia exists it is recommended to use an external braking resistor for faster deceleration. See figure 4.5-16.

4

4. 10 Execute frequency of DC-brake during ramp Stop

See figure 4.5-16.

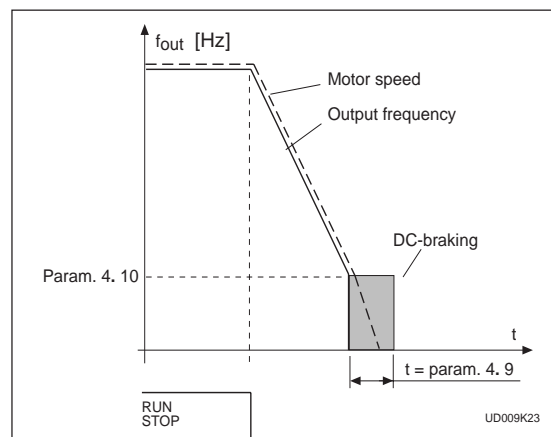

Figure 4.5-16 DC-braking time when par. 4. 7 = 1.



4. 11 DC-brake time at start

- 0 DC-brake is not used
- >0 DC-brake is active when the start command is given. This parameter defines the time before the brake is released. After the brake is released the output frequency increases according to the set start function parameter 4. 6 and the acceleration parameters (1. 3, 4. 1 or 4. 2, 4. 3). See figure 4.5-17.

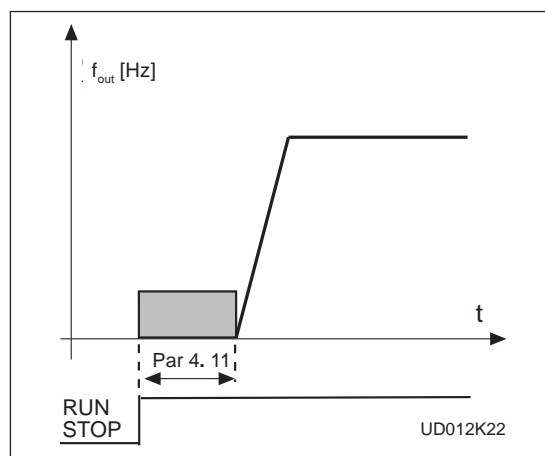

Figure 4.5-17 DC-braking time at start

4. 12 Jog speed reference

Parameter value defines the Jog speed selected with the digital input.

5. 1- 5.6 Prohibit frequency area, Low limit/High limit

In some systems it may be necessary to avoid certain frequencies because of mechanical resonance problems.

With these parameters it is possible to set limits for three "skip frequency" regions. The accuracy of the setting is 0.1 Hz.

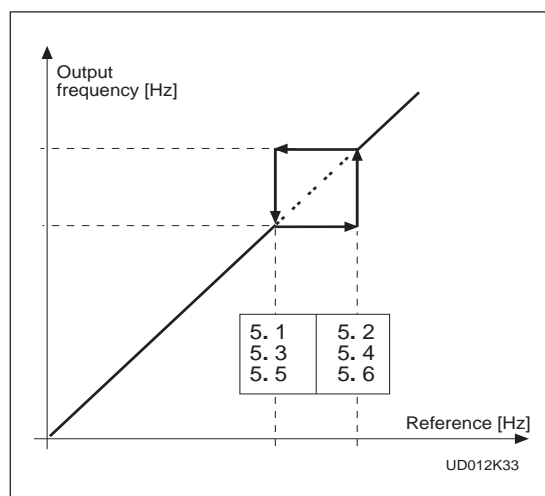

Figure 4.5-18 Example of prohibit frequency area setting

6. 1 Motor control mode

0 = Frequency control:
(V/Hz)

The I/O terminal and panel references are frequency references and the drive controls the output frequency (output freq. resolution 0.01 Hz)

1 = Speed control:
(sensorless vector)

The I/O terminal and panel references are speed references and the drive controls the motor speed (control accuracy $\pm 0.5\%$).

6. 2 Switching frequency

Motor noise can be minimized using a high switching frequency. Increasing the frequency reduces the capacity of the SV9000.

Before changing the frequency from the factory default 10 kHz (3.6 kHz >40 Hp) check the drive derating in the curves shown in figures 5.2-2 and 5.2-3 in chapter 5.2 of the User's Manual.

6.3 Field weakening point

6.4 Voltage at the field weakening point

The field weakening point is the output frequency where the output voltage reaches the set maximum value (par. 6. 4). Above that frequency the output voltage remains at the set maximum value. Below that frequency output voltage depends on the setting of the V/Hz curve parameters 1. 8, 1. 9, 6. 5, 6. 6 and 6. 7. See figure 4.5-19.

When parameters 1. 10 and 1. 11, nominal voltage and nominal frequency of the motor are set, parameters 6. 3 and 6. 4 are also set automatically to the corresponding values. If you need different values for the field weakening point and the maximum output voltage, change these parameters after setting parameters 1. 10 and 1. 11.

6.5 V/Hz curve, middle point frequency

If the programmable V/Hz curve has been selected with parameter 1. 8, this parameter defines the middle point frequency of the curve. See figure 4.5-19.

6.6 VHz curve, middle point voltage

If the programmable V/Hz curve has been selected with parameter 1. 8, this parameter defines the middle point voltage (% of motor nominal voltage) of the curve. See figure 4.5-19.

6.7 Output voltage at zero frequency

If the programmable V/Hz curve has been selected with parameter 1. 8 this parameter defines the zero frequency voltage of the curve. See figure 4.5-19..

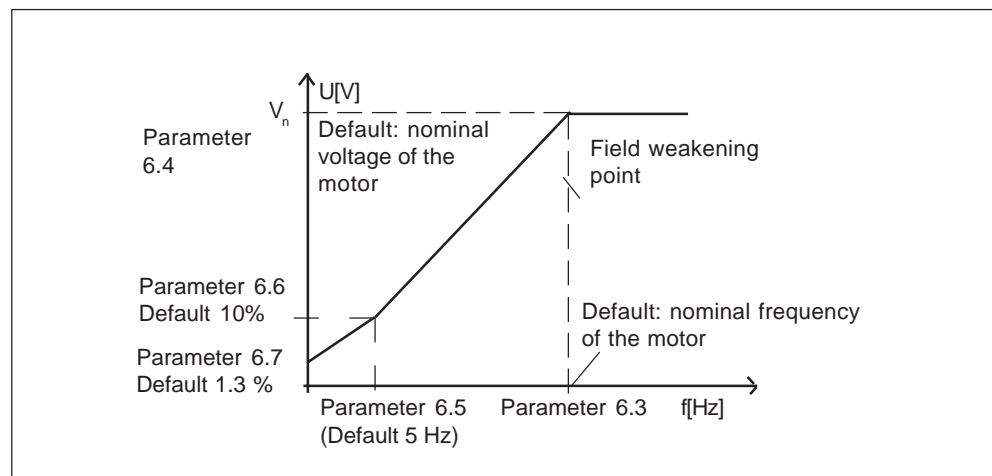

Figure 4.5-19 Programmable V/Hz curve

6.8 Overvoltage controller

6.9 Undervoltage controller

These parameters allow the over/undervoltage controllers to be switched ON or OFF. This may be useful in cases where the utility supply voltage varies more than -15%—+10% and the application requires a constant speed. If the controllers are ON, they will change the motor speed in over/undervoltage cases. Overvoltage = faster, undervoltage = slower.

Over/undervoltage trips may occur when the controllers are not used.

7.1 Response to the reference fault

- 0 = No response
- 1 = Warning
- 2 = Fault, stop mode after fault according to parameter 4.7
- 3 = Fault, always coasting stop mode after fault

A warning or a fault action and message is generated if the 4—20 mA reference signal is used and the signal falls below 4 mA. The information can also be programmed via digital output DO1 and via relay outputs RO1 and RO2.

7.2 Response to external fault

- 0 = No response
- 1 = Warning
- 2 = Fault, stop mode after fault according to parameter 4.7
- 3 = Fault, always coasting stop mode after fault

A warning or a fault action and message is generated from the external fault signal in the digital input DIA3. The information can also be programmed into digital output DO1 and into relay outputs RO1 and RO2.

7.3 Phase supervision of the motor

- 0 = No action
- 2 = Fault

Phase supervision of the motor ensures that the motor phases have approximately equal current.

7.4 Ground fault protection

- 0 = No action
- 2 = Fault

Ground fault protection ensures that the sum of the motor phase currents is zero. The ground protection is always working and protects the frequency converter from ground faults with high current levels.

Parameters 7.5—7.9 Motor thermal protection

General

Motor thermal protection is to protect the motor from overheating. The SV9000 drive is capable of supplying higher than nominal current to the motor. If the load requires this high current there is a risk that the motor will be thermally overloaded. This is true especially at low frequencies. With low frequencies the cooling effect of the motor fan is reduced and the capacity of the motor is reduced. If the motor is equipped with an external fan, the load derating on low speed is small.

Motor thermal protection is based on a calculated model and it uses the output current of the drive to determine the load on the motor. When the power is turned on to the drive, the calculated model uses the heatsink temperature to determine the initial thermal state of the motor. The calculated model assumes that the ambient temperature of the motor is 40°C.

Motor thermal protection can be adjusted by setting several parameters. The thermal current I_T specifies the load current above which the motor is overloaded.



This current limit is a function of the output frequency. The curve for I_T is set with parameters 7. 6, 7. 7 and 7. 9, refer to the figure 4.5-20. The default values of these parameters are set from the motor nameplate data.

With the output current at I_T the thermal state will reach the nominal value (100%). The thermal state changes with the square of the current. With output current at 75% of I_T the thermal state will reach 56% and with output current at 120% of I_T the thermal stage would reach 144%. The function will trip the drive (refer par. 7. 5) if the thermal model reaches a value of 105%. The response time of the thermal model is determined by the time constant parameter 7. 8. The larger the motor, the longer it takes to reach the final temperature.

The thermal state of the motor can be monitored through the display. Refer to the table for monitoring items. (User's Manual, table 7.3-1).

7. 5 Motor thermal protection



CAUTION! *The calculated model does not protect the motor if the cooling of the motor is reduced either by blocking the airflow or due to dust or dirt.*

Operation:

- 0 = Not in use
- 1 = Warning
- 2 = Trip function

Tripping and warning will give a display indication with the same message code. If tripping is selected, the drive will stop and activate the fault stage.

Deactivating the protection by setting this parameter to 0, will reset the thermal stage of the motor to 0%.

7. 6 Motor thermal protection, break point current

The current can be set between 50.0—150.0% $\times I_{nMotor}$.

This parameter sets the value for thermal current at frequencies above the break point on the thermal current curve. See figure 4.5-20.

The value is set as a percentage of the motor nameplate nominal current, parameter 1. 13, not the drive's nominal output current.

The motor's nominal current is the current which the motor can withstand in direct on-line use without being overheated.

If parameter 1. 13 is adjusted, this parameter is automatically restored to the default value.

Setting this parameter (or parameter 1. 13) does not affect the maximum output current of the drive. Parameter 1. 7 alone determines the maximum output current of the drive.

7. 7 Motor thermal protection, zero frequency current

The current can be set between 10.0—150.0% $\times I_{nMotor}$. This parameter sets the value for thermal current at zero frequency. See figure 4.5-20.

The default value is set assuming that there is no external fan cooling the motor. If an external fan is used this parameter can be set to 90% (or higher).

The value is set as a percentage value of the motor's nameplate nominal current, parameter 1. 13, not the drive's nominal output current. The motor's nominal current is the current which the motor can stand in direct on-line use without being overheated.

If you change the parameter 1. 13 this parameter is automatically restored to the default value.

Setting this parameter (or parameter 1. 13) does not affect to the maximum output current of the drive. Parameter 1. 7 alone determines the maximum output current of the drive.

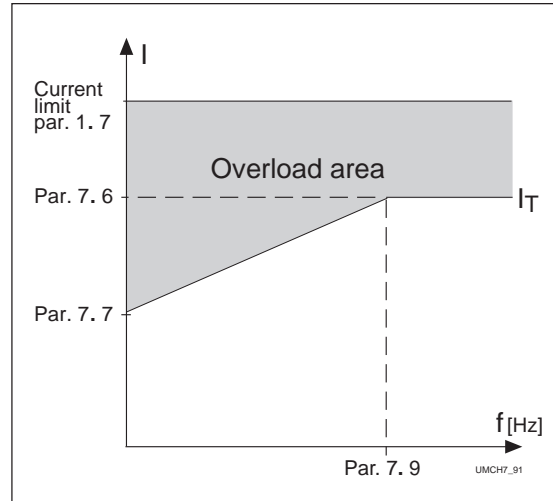

Figure 4.5-20 Motor thermal current I_T curve

7.8 Motor thermal protection, time constant

This time can be set between 0.5—300 minutes. This is the thermal time constant of the motor. The larger the motor the greater the time constant. The time constant is defined as the time that it takes the calculated thermal state to reach 63% of its final value.

The motor thermal time is specific to a motor design and it varies between different motor manufacturers.

The default value for the time constant is calculated based on the motor nameplate data from parameters 1. 12 and 1. 13. If either of these parameters is reset, then this parameter is set to default value.

If the motor's t_6 -time is known (given by the motor manufacturer) the time constant parameter could be set based on t_6 -time. As a rule of thumb, the motor thermal time constant in minutes equals to $2xt_6$ (t_6 in seconds is the time a motor can safely operate at six times the rated current). If the drive is stopped the time constant is internally increased to three times the set parameter value. The cooling in the stop stage is based on convection with an increased time constant.

7.9 Motor thermal protection, break point frequency

This frequency can be set between 10—500 Hz.

This is the frequency break point of the thermal current curve. With frequencies above this point, the thermal capacity of the motor is assumed to be constant. See figure 4.5-20.

The default value is based on the motor's nameplate data, parameter 1. 11. It is 35 Hz for a 50 Hz motor and 42 Hz for a 60 Hz motor. More generally it is 70% of the frequency at the field weakening point (parameter 6. 3). Changing either parameter 1. 11 or 6. 3 will restore this parameter to its default value.

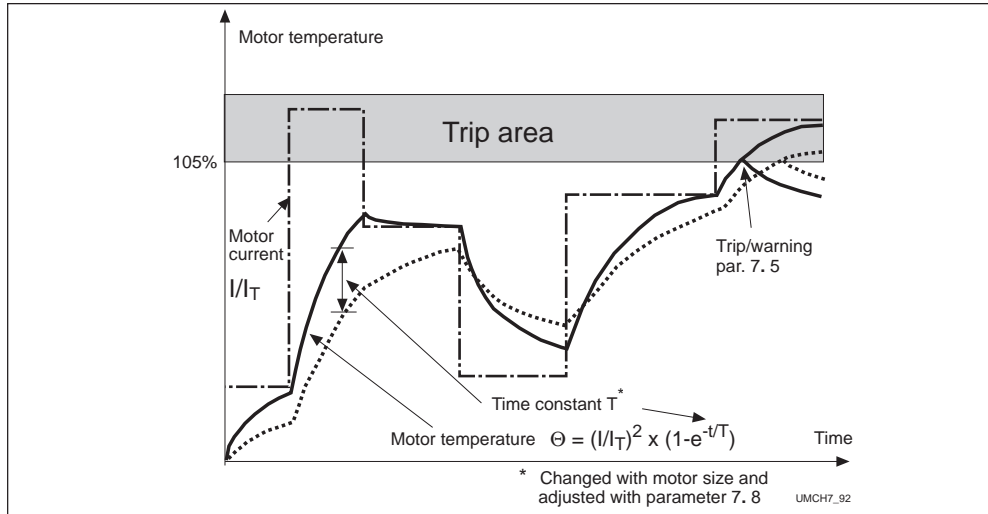

Figure 4.5-21 Calculating motor temperature.

Parameters 7. 10— 7. 13, Stall protection
General

Motor stall protection protects the motor from short time overload situations like a stalled shaft. The reaction time of stall protection can be set shorter than with motor thermal protection. The stall state is defined with two parameters, 7.11. Stall Current and 7.13. Stall Frequency. If the current is higher than the set limit and output frequency is lower than the set limit the stall state is true. There is no true detection of shaft rotation. Stall protection is a type of overcurrent protection.

7. 10 Stall protection

Operation:

- 0 = Not in use
- 1 = Warning
- 2 = Trip function

Tripping and warning will give a display indication with the same message code. If tripping is set on, the drive will stop and activate the fault stage. Setting the parameter to 0 will deactivate the protection and will reset the stall time counter to zero.

7. 11 Stall current limit

The current can be set between 0.0—200% x I_{nMotor} .

In the stall stage the current has to be above this limit. See figure 4.5-22. The value is set as a percentage of the motor's nameplate nominal current, parameter 1.13, motor's nominal current. If parameter 1.13 is adjusted, this parameter is automatically restored to its default value.

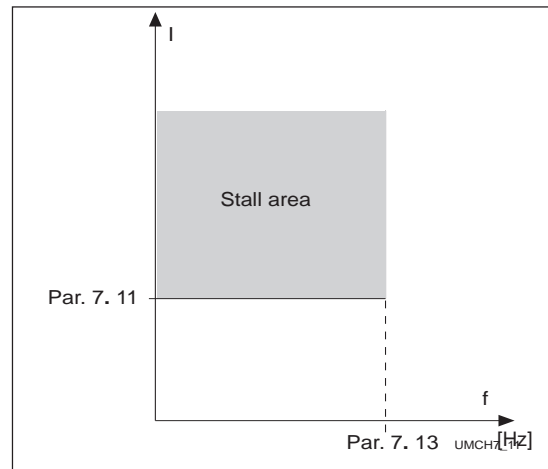

Figure 4.5-22 Setting the stall characteristics.



7.12 Stall time

The time can be set between 2.0—120 s.

This is the maximum allowed time for a stall. There is an internal up/down counter to count the stall time. See figure 4.5-23. If the stall time counter value goes above this limit the protection will cause a trip (refer to parameter 7.10).

7.13 Maximum stall frequency

The frequency can be set between $1-f_{max}$ (par. 1.2).

In the stall state, the output frequency has to be smaller than this limit. Refer to figure 4.5-22.

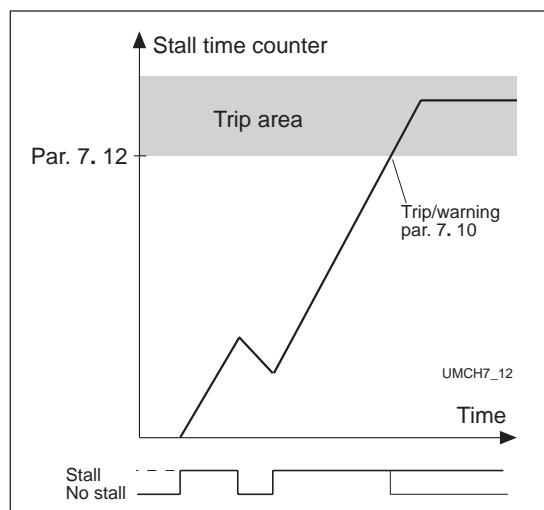

Figure 4.5-23 Counting the stall time.

Parameters 7.14—7.17, Underload protection

General

The purpose of motor underload protection is to ensure that there is load on the motor while the drive is running. If the motor load is reduced, there might be a problem in the process, e.g. broken belt or dry pump.

Motor underload protection can be adjusted by setting the underload curve with parameters 7.15 and 7.16. The underload curve is a squared curve set between zero frequency and the field weakening point. The protection is not active below 5 Hz (the underload counter value is stopped). See figure 4.5-24.

The torque values for setting the underload curve are set with percentage values which refer to the nominal torque of the motor. The motor's nameplate data, parameter 1.13, the motor's nominal current and the drive's nominal current I_{CT} are used to find the scaling ratio for the internal torque value. If other than a standard motor is used with the drive, the accuracy of the torque calculation is decreased.

7.14 Underload protection

Operation:

- 0 = Not in use
- 1 = Warning
- 2 = Fault

Tripping and warning will give a display indication with the same message code. If tripping is set active the drive will stop and activate the fault stage.

Deactivating the protection, by setting this parameter to 0, will reset the underload time counter to zero.

7. 15 Underload protection, field weakening area load

Torque limit can be set between 20.0—150 % $\times T_{nMotor}$.

This parameter is the value for the minimum allowed torque when the output frequency is above the field weakening point. See figure 4.5-24.

If parameter 1. 13 is adjusted, this parameter is automatically restored to its default value.

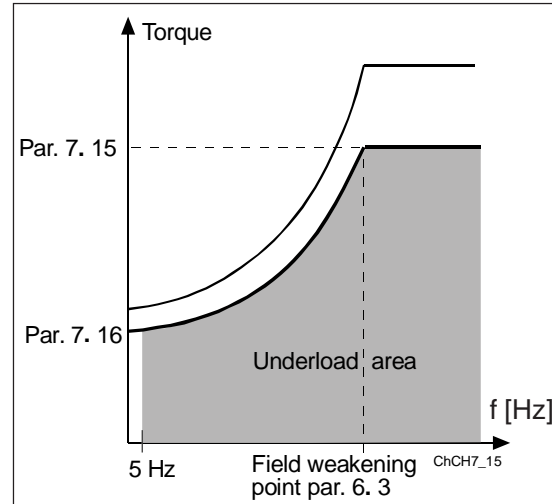

Figure 4.5-24 Setting of minimum load.

7. 16 Underload protection, zero frequency load

Torque limit can be set between 10.0—150 % $\times T_{nMotor}$.

This parameter is the value for the minimum allowed torque with zero frequency. See figure 4.5-24. If parameter 1. 13 is adjusted this parameter is automatically restored to its default value.

7. 17 Underload time

This time can be set between 2.0—600.0 s.

This is the maximum allowed time for an underload state. There is an internal up/down counter to accumulate the underload time. See figure 4.5-25.

If the underload counter value goes above this limit, the protection will cause a trip (refer to the parameter 7. 14). If the drive is stopped, the underload counter is reset to zero.

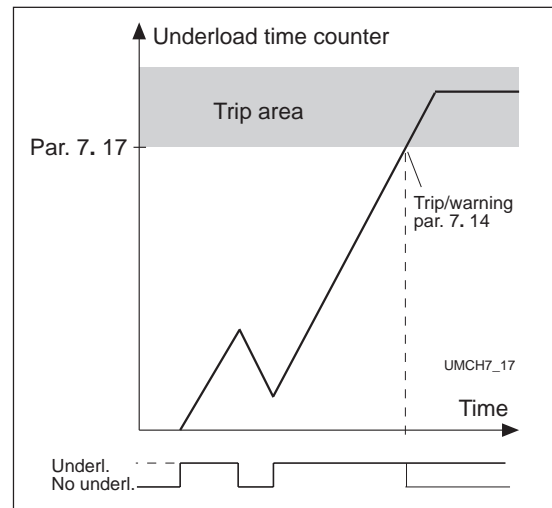

Figure 4.5-25 Counting the underload time.

8. 1 Automatic restart: number of tries

8. 2 Automatic restart: trial time

The Automatic restart function restarts the drive after the faults selected with parameters 8. 4—8. 8. The Start function for Automatic restart is selected with parameter 8. 3. See figure 4.5-26.

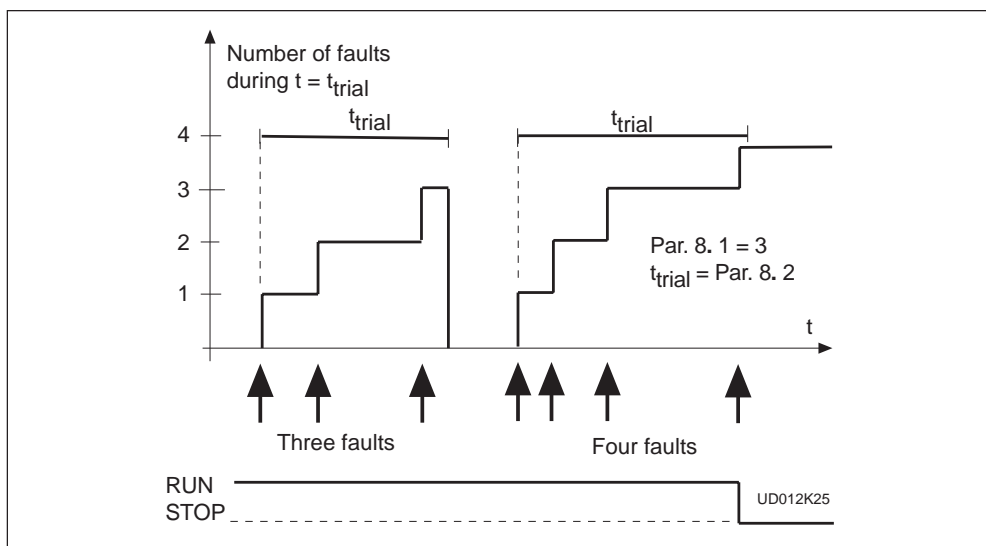

Figure 4.5-26 Automatic restart.

Parameter 8. 1 determines how many automatic restarts can be made during the trial time set by the parameter 8. 2.

The time counting starts from the first autorestart. If the number of restarts does not exceed the value of the parameter 8. 1 during the trial time, the counting is cleared after the trial time has elapsed. The next fault starts the counting again.

8. 3 Automatic restart, start function

The parameter defines the start mode:

- 0 = Start with ramp
- 1 = Flying start, see parameter 4. 6.

8. 4 Automatic restart after undervoltage trip

- 0 = No automatic restart after undervoltage trip
- 1 = Automatic restart after undervoltage fault condition returns to normal (DC-link voltage returns to the normal level)

8. 5 Automatic restart after overvoltage trip

- 0 = No automatic restart after overvoltage trip
- 1 = Automatic restart after overvoltage fault condition returns to normal (DC-link voltage returns to the normal level)

8. 6 Automatic restart after overcurrent trip

- 0 = No automatic restart after overcurrent trip
- 1 = Automatic restart after overcurrent faults

8. 7 Automatic restart after reference fault trip

- 0 = No automatic restart after reference fault trip
- 1 = Automatic restart after analog current reference signal (4—20 mA) returns to the normal level (≥ 4 mA)

8. 8 Automatic restart after over-/undertemperature fault trip

- 0 = No automatic restart after temperature fault trip
- 1 = Automatic restart after the heatsink temperature has returned to its normal level between -10°C — $+75^{\circ}\text{C}$.

4.6 Panel reference

The PI-control application has an extra reference (r2) for the PI-controller on the panel's reference page. See table 4.6-1.

Reference number	Reference name	Range	Step	Function
r 1	Frequency reference	$f_{\min} - f_{\max}$	0.01 Hz	Reference for panel control and I/O terminal Source B reference.
r 2	PI-controller reference	0—100%	0.1%	Reference for PI-controller

4.7 Monitoring data

The PI-control application has additional items for monitoring. See table 4.7-1

Number	Data name	Unit	Description
n 1	Output frequency	Hz	Frequency to the motor
n 2	Motor speed	rpm	Calculated motor speed
n 3	Motor current	A	Measured motor current
n 4	Motor torque	%	Calculated actual torque/nominal torque of the unit
n 5	Motor power	%	Calculated actual power/nominal power of the unit
n 6	Motor voltage	V	Calculated motor voltage
n 7	DC-link voltage	V	Measured DC-link voltage
n 8	Temperature	°C	Temperature of the heat sink
n 9	Operating day counter	DD.dd	Operating days ¹ , not resettable
n 10	Operating hours, "trip counter"	HH.hh	Operating hours ² , can be reset with programmable button #3
n 11	MW-hours	MWh	Total MW-hours, not resettable
n 12	MW-hours, "trip counter"	MWh	MW-hours, can be reset with programmable button #4
n 13	Voltage/analog input	V	Voltage at the terminal V_{in+} (term. #2)
n 14	Current/analog input	mA	Current at terminals I_{in+} and I_{in-} (term. #4, #5)
n 15	Digital input status, gr. A		
n 16	Digital input status, gr. B		
n 17	Digital and relay output status		
n 18	Control program		Version number of the control software
n 19	Unit nominal power	Hp	Shows the horsepower size of the unit
n 20	PI-controller reference	%	Percent of the maximum reference
n 21	PI-controller actual value	%	Percent of the maximum actual value
n 22	PI-controller error value	%	Percent of the maximum error value
n 23	PI-controller output	Hz	
n 24	Motor temperature rise	%	100%= temperature of motor has risen to nominal

¹ DD = full days, dd = decimal part of a day

² HH = full hours, hh = decimal part of an hour

Table 4.7-1 Monitored items.



This page intentionally left blank

4



MULTI-PURPOSE CONTROL APPLICATION

(par. 0.1 = 6)

CONTENTS

5 Multi-purpose Control Application	5-1
5.1 General	5-2
5.2 Control I/O	5-2
5.3 Control signal logic	5-3
5.4 Parameters Group 1	5-4
5.4.1 Parameter table	5-4
5.4.2 Description of Group1 par.	5-5
5.5 Special parameters, Groups 2-8	5-9
5.5.1 Parameter tables	5-9
5.5.2 Description of Group 2 par....	5-16



5 Multi-purpose Control Application

5.1 General

In the Multi-purpose control application the frequency reference can be selected from the analog inputs, the joystick control, the motorized (digital) potentiometer and a mathematical function of the analog inputs. Multi-step speeds and jog speed can also be selected if digital inputs are programmed for

these functions.

Digital inputs DIA1 and DIA2 are reserved for Start/stop logic. Digital inputs DIA3—DIB6 are programmable for multi-step speed select, jog speed select, motorized (digital potentiometer, external fault, ramp time select, ramp prohibit, fault reset and DC-brake command function. All outputs are freely programmable.

*** NOTE!** Remember to connect the CMA and CMB inputs.

5.2 Control I/O

Reference potentiometer 1 - 10 kΩ

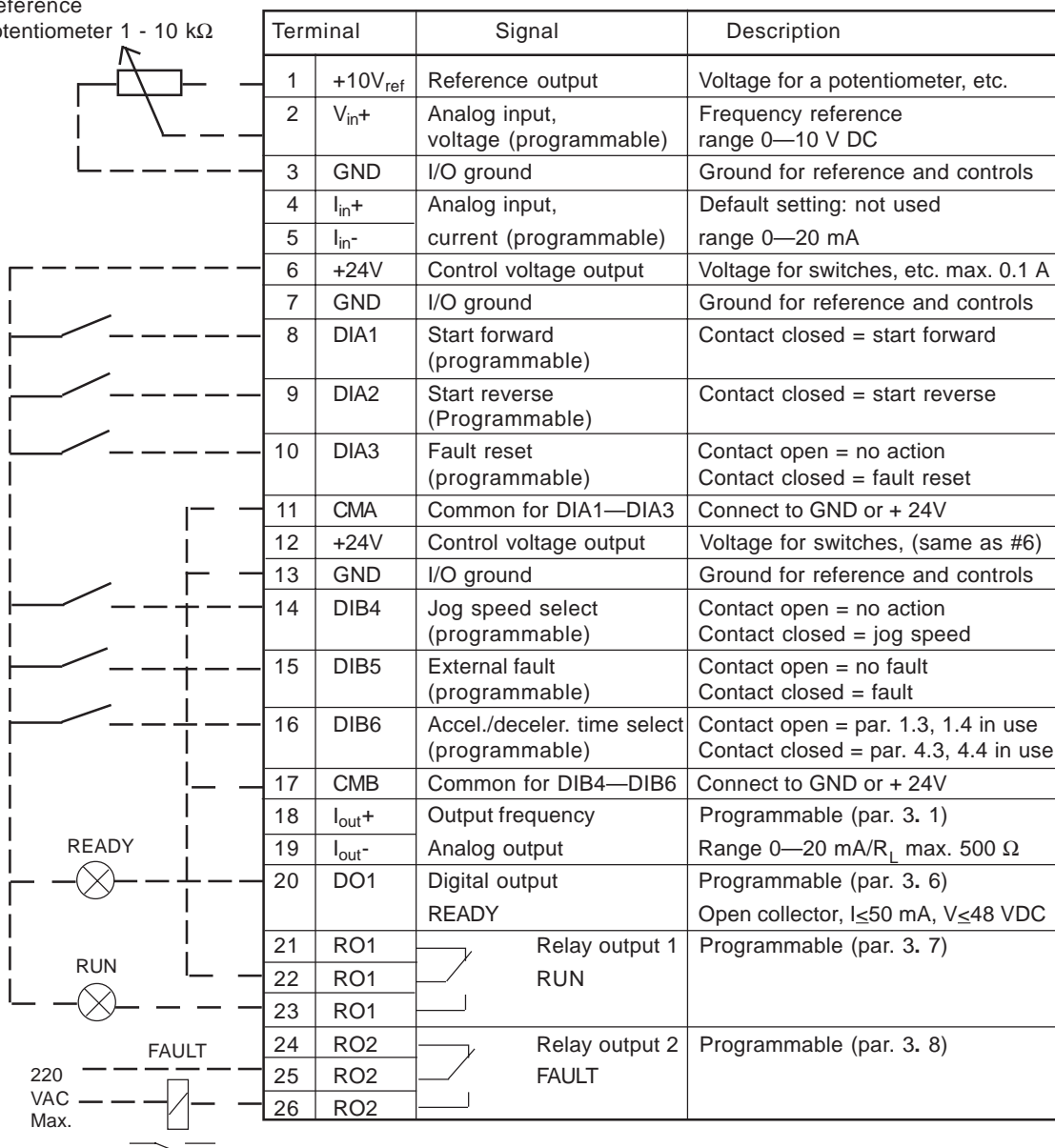

Figure 5.2-1 Default I/O configuration and connection example of the Multi-purpose Control Application.



5.3 Control signal logic

The logic flow of the I/O-control signals and pushbutton signals from the panel is shown in figure 5.3-1.

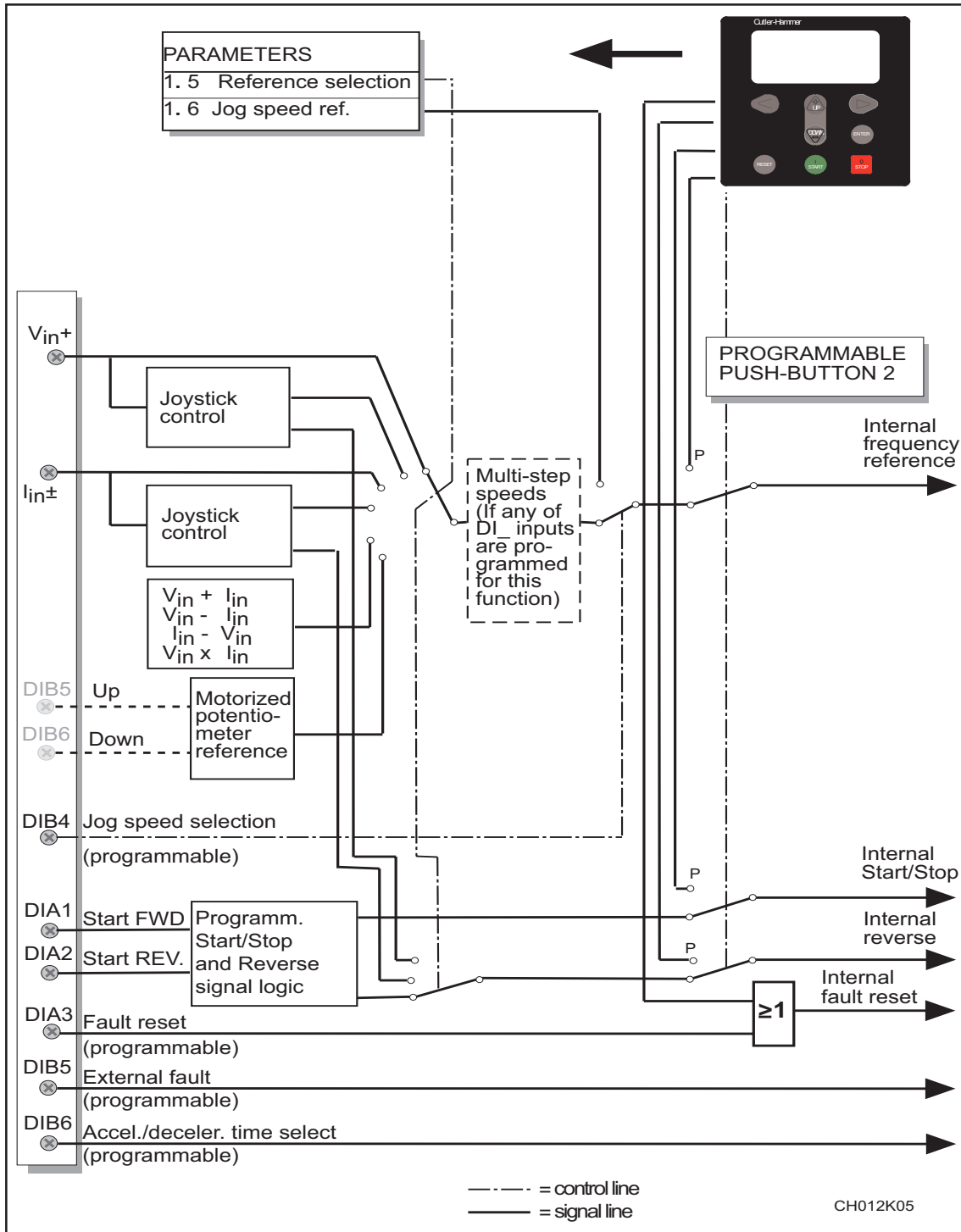



Figure 5.3-1 Control signal logic of the Multipurpose Control Application. Switch positions shown are based on the factory settings.



5.4 Basic parameters, Group 1

5.4.1 Parameter table

Code	Parameter	Range	Step	Default	Custom	Description	Page
1.1	Minimum frequency	0— f_{max}	1 Hz	0 Hz			5-5
1.2	Maximum frequency	f_{min} -120/500Hz	1 Hz	60 Hz	*		5-5
1.3	Acceleration time 1	0.1—3000.0 s	0.1 s	3.0 s		Time from f_{min} (1.1) to f_{max} (1.2)	5-5
1.4	Deceleration time 1	0.1—3000.0 s	0.1 s	3.0 s		Time from f_{max} (1.2) to f_{min} (1.1)	5-5
1.5	Reference selection	0—9	1	0		0 = V_{in} 3 = $V_{in} - I_{in}$ 1 = I_{in} 4 = $I_{in} - V_{in}$ 2 = $V_{in} + I_{in}$ 5 = $V_{in} * I_{in}$ 6 = V_{in} joystick control 7 = I_{in} joystick control 8 = Signal from internal motor pot. 9 = Signal from internal motor pot. reset if SV9000 is stopped	5-5
1.6	Jog speed reference	f_{min} — f_{max} (1.1) (1.2)	0.1 Hz	5.0 Hz			5-6
1.7	Current limit	0.1—2.5 x I_{nSV9}	0.1 A	1.5 x I_{nSV9}		Output current limit [A] of the unit	5-6
1.8	V/Hz ratio selection	0—2	1	0		0 = Linear 1 = Squared 2 = Programmable V/Hz ratio	5-6
1.9	V/Hz optimization	0—1	1	0		0 = None 1 = Automatic torque boost	5-8
1.10	Nominal voltage of the motor	180—690 V	1 V	230 V 380 V 480 V 575 V		Voltage code 2 Voltage code 4 Voltage code 5 Voltage code 6	5-8
1.11	Nominal frequency of the motor	30—500 Hz	1 Hz	60 Hz		f_n from the nameplate of the motor	5-8
1.12	Nominal speed of the motor	1—20000 rpm	1 rpm	1720 rpm **		n_n from the nameplate of the motor	5-8
1.13	Nominal current of the motor	2.5 x I_{nSV9}	0.1 A	I_{nSV9}		I_n from the nameplate of the motor	5-8
1.14	Supply voltage	208—240 380—440 380—500 525—690		230 V 380 V 480 V 575 V		Voltage code 2 Voltage code 4 Voltage code 5 Voltage code 6	5-8
1.15	Parameter conceal	0—1	1	0		Visibility of the parameters: 0 = All parameter groups visible 1 = Only group 1 is visible	5-8
1.16	Parameter value lock	0—1	1	0		Disables parameter changes: 0 = Changes enabled 1 = Changes disabled	5-8

Note!  = Parameter value can be changed only when the drive is stopped.

* If 1.2 > motor synchr. speed, check suitability for motor and drive system.
Selecting 120/500 Hz range see page 5-5.

** Default value for a four pole motor and a nominal size drive.



5.4.2 Description of Group 1 parameters

1. 1, 1. 2 Minimum / maximum frequency

Defines frequency limits of the drive.

The default maximum value for parameters 1. 1 and 1. 2 is 120 Hz. By setting 1. 2 = 120 Hz when the drive is stopped (RUN indicator not lit) parameters 1. 1 and 1. 2 are changed to 500 Hz. At the same time the panel reference resolution is changed from 0.01 Hz to 0.1 Hz.

Changing the max. value from 500 Hz to 120 Hz is done by setting parameter 1. 2 = 119 Hz when the drive is stopped.

1. 3, 1. 4 Acceleration time 1, deceleration time 1:

These limits correspond to the time required for the output frequency to accelerate from the set minimum frequency (par. 1. 1) to the set maximum frequency (par. 1. 2).

1. 5 Reference selection

- 0 Analog voltage reference from terminals 2—3, e.g. a potentiometer
- 1 Analog current reference from terminals 4—5, e.g. a transducer.
- 2 Reference is formed by adding the values of the analog inputs
- 3 Reference is formed by subtracting the voltage input (V_{in}) value from the current input (I_{in}) value.
- 4 Reference is formed by subtracting the current input (I_{in}) value from the voltage input (V_{in}) value.
- 5 Reference is formed by multiplying the values of the analog inputs
- 6 Joystick control from the voltage input (V_{in}).

Signal range	Max reverse speed	Direction change	Max forward speed
0—10 V	0 V	5 V	+10 V
Custom	Par. 2. 7 x 10V	In the middle of custom range	Par. 2. 8 x 10 V
-10 V—+10 V	-10 V	0 V	+10 V

Warning! Use only -10V—+10 V signal range. If a custom or 0—10 V signal range is used, the drive will run at the max. reverse speed if the reference signal is lost



7 Joystick control from the current input (I_{in}).

Signal range	Max reverse speed	Direction change	Max forward speed
0—20 mA	0 mA	10 mA	20 mA
Custom	Par. 2. 13 x 20 mA	In the middle of custom range	Par. 2. 14 x 20 mA
4—20 mA	4 mA	12 mA	20 mA

Warning! Use only 4—20 mA signal range. If a custom or 0—20 mA signal range is used, the drive will run at the max. reverse speed if the control signal is lost. Set the reference fault (par. 7. 2) active when the 4—20 mA range is used, then the drive will stop with a reference fault if the reference signal is lost.



Note! When joystick control is used, the direction control is generated from the joystick reference signal. See figure 5.4-1.

Analog input scaling, parameters 2. 16—2. 19 are not used when joystick control is used.

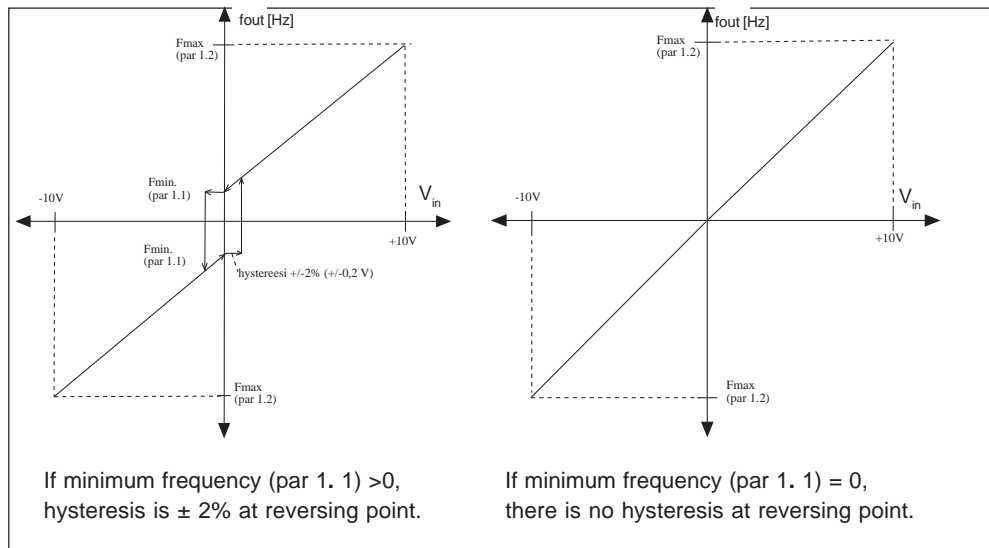

Fig. 5.4-1 Joystick control V_{in} signal -10 V—+10 V.

- 8 Reference value is changed with digital input signals DIA4 and DIA5.
 - switch in DIA3 closed = frequency reference increases
 - switch in DIA4 closed = frequency reference decreases
 Speed of the reference change can be set with the parameter 2. 20.
- 9 Same as setting 8 but the reference value is set to the minimum frequency (par. 1. 1) each time the SV9000 is stopped. When the value of parameter 1. 5 is set to 8 or 9, the value of parameters 2. 4 and 2. 5 are automatically set to 11.

1. 6 Jog speed reference

Parameter value defines the jog speed selected with the digital input

1. 7 Current limit

This parameter determines the maximum motor current that the SV9000 will provide short term.

1. 8 V/Hz ratio selection

Linear: The voltage of the motor changes linearly with the frequency in the constant flux area from 0 Hz to the field weakening point (par. 6. 3) where a constant voltage (nominal value) is also supplied to the motor. See figure 5.4.-2. A linear V/Hz ratio should be used in constant torque applications.

This default setting should be used if there is no special requirement for another setting.

Squared: 1 The voltage of the motor changes following a squared curve form with the frequency in the area from 0 Hz to the field weakening point (par. 6. 3) where the nominal voltage is also supplied to the motor. See figure 5.4.-2.

The motor runs undermagnetized below the field weakening point and produces less torque and electromechanical noise. A squared V/Hz ratio can be used in applications where the torque demand of the load is proportional to the square of the speed, e.g. in centrifugal fans and pumps.

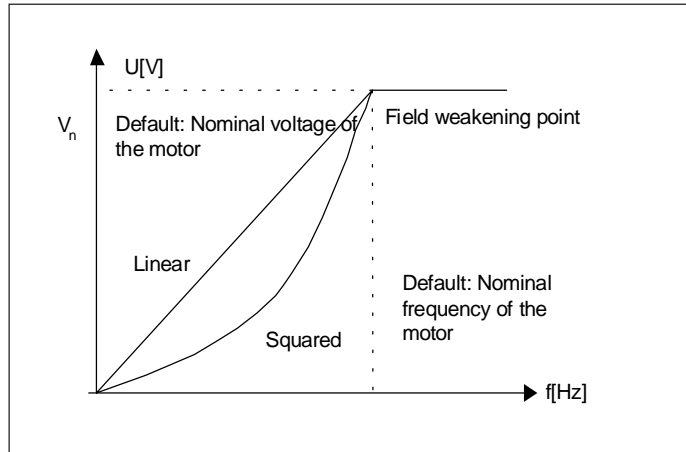

Figure 5.4.-2 Linear and squared V/Hz curves.

Programm. V/Hz curve 2 The V/Hz curve can be programmed with three different points. The parameters for programming are explained in chapter 1.5.2. A programmable V/Hz curve can be used if the standard settings do not satisfy the needs of the application. See figure 5.4.-3.

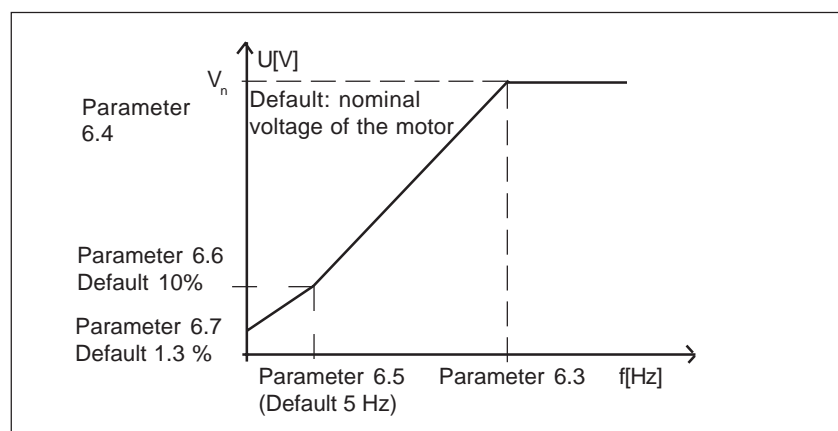

Figure 5.4-3 Programmable V/Hz curve.

1.9 V/Hz optimization

Automatic torque boost The voltage to the motor changes automatically which makes the motor produce sufficient torque to start and run at low frequencies. The voltage increase depends on the motor type and horsepower.

Automatic torque boost can be used in applications where starting torque due to starting friction is high, e.g. in conveyors.

NOTE! *In high torque - low speed applications - it is likely the motor will overheat. If the motor has to run prolonged time under these conditions, special attention must be paid to cooling the motor. Use external cooling for the motor if the temperature rise is too high.*

**1.10 Nominal voltage of the motor**

Find this value V_n from the nameplate of the motor.

This parameter sets the voltage at the field weakening point, parameter 6. 4, to $100\% \times V_{n\text{motor}}$

1.11 Nominal frequency of the motor

Find the nominal frequency f_n from the nameplate of the motor.

This parameter sets the frequency of the field weakening point, parameter 6. 3, to the same value.

1.12 Nominal speed of the motor

Find this value n_n from the nameplate of the motor.

1.13 Nominal current of the motor

Find the value I_n from the nameplate of the motor. The internal motor protection function uses this value as a reference value.

1.14 Supply voltage

Set parameter value according to the nominal voltage of the supply. Values are pre-defined for voltage codes 2, 4, 5 and 6. See table 5.4-1.

1.15 Parameter conceal

Defines which parameter groups are available:

0 = all parameter groups are visible

1 = only group 1 is visible

1.16 Parameter value lock

Defines access to the changes of the parameter values:

0 = parameter value changes enabled





1 = parameter value changes disabled

To adjust more of the functions of the Multi-purpose application, see chapter 5.5 to modify the parameters of Groups 2—8.

5.5 Special parameters, Groups 2—8

5.5.1 Parameter tables

Group 2, Input signal parameters

Code	Parameter	Range	Step	Default	Custom	Description	Page
2.1	Start/Stop logic selection 	0—3	1	0		DIA1	5-16
						DIA2	
						0 = Start forward 1 = Start/Stop 2 = Start/Stop 3 = Start pulse	
						Start reverse Reverse Run enable Stop pulse	
2.2	DIA3 function (terminal 10) 	0—9	1	7		0 = Not used 1 = Ext. fault, closing contact 2 = External fault, opening contact 3 = Run enable 4 = Acc./dec. time selection 5 = Reverse 6 = Jog speed 7 = Fault reset 8 = Acc./dec. operation prohibit 9 = DC-braking command	5-17
2.3	DIB4 function (terminal 14) 	0—10	1	6		0 = Not used 1 = Ext. fault, closing contact 2 = External fault, opening contact 3 = Run enable 4 = Acc./dec. time selection 5 = Reverse 6 = Jog speed 7 = Fault reset 8 = Acc./dec. operation prohibit 9 = DC-braking command 10 = Multi-Step speed select 1	5-18
2.4	DIB5 function (terminal 15) 	0—11	1	1		0 = Not used 1 = Ext. fault, closing contact 2 = External fault, opening contact 3 = Run enable 4 = Acc./dec. time selection 5 = Reverse 6 = Jog speed 7 = Fault reset 8 = Acc./dec. operation prohibit 9 = DC-braking command 10 = Multi-Step speed select 2 11 = Motorized pot. speed up	5-18
2.5	DIB6 function (terminal 16) 	0—11	1	4		0 = Not used 1 = Ext. fault, closing contact 2 = External fault, opening contact 3 = Run enable 4 = Acc./dec. time selection 5 = Reverse 6 = Jog speed 7 = Fault reset 8 = Acc./dec. operation prohibit 9 = DC-braking command 10 = Multi-Step speed select 3 11 = Motorized pot. speed down	5-18
2.6	V _{in} signal range	0—2	1	0		0 = 0—10 V 1 = Custom setting range 2 = -10—+10 V (can be used only with Joystick control)	5-19

Note!  = Parameter value can be changed only when the drive is stopped.





Code	Parameter	Range	Step	Default	Custom	Description	Page
2.7	V _{in} custom setting min.	0.00-100.00%	0.01%	0.00%			5-19
2.8	V _{in} custom setting max.	0.00-100.00%	0.01%	100.00%			5-19
2.9	V _{in} signal inversion	0—1	1	0		0 = Not inverted 1 = Inverted	5-19
2.10	V _{in} signal filter time	0.00—10.00 s	0.01 s	0.10 s		0 = No filtering	5-19
2.11	I _{in} signal range	0—2	1	0		0 = 0—20 mA 1 = 4—20 mA 2 = Custom setting range	5-19
2.12	I _{in} custom setting minim.	0.00-100.00%	0.01%	0.00%			5-20
2.13	I _{in} custom setting maxim.	0.00-100.00%	0.01%	100.00%			5-20
2.14	I _{in} signal inversion	0—1	1	0		0 = Not inverted 1 = Inverted	5-20
2.15	I _{in} signal filter time	0.01—10.00 s	0.01 s	0.10 s		0 = No filtering	5-20
2.16	V _{in} minimum scaling	-320.00%— +320.00 %	0.01	0.00%		0% = no minimum scaling	5-20
2.17	V _{in} maximum scaling	-320.00%— +320.00 %	0.01	100.00%		100% = no maximum scaling	5-20
2.18	I _{in} minimum scaling	-320.00%— +320.00%	0.01	0.00%		0% = no minimum scaling	5-20
2.19	I _{in} maximum scaling	-320.00%— +320.00 %	0.01	100.00%		100% = no maximum scaling	5-20
2.20	Free analog input, signal selection	0—2	1	0		0 = Not use 1 = V _{in} (analog voltage input) 2 = I _{in} (analog current input)	5-21
2.21	Free analog input, function	0—4	1	0		0 = No function 1 = Reduces current limit (par. 1.7) 2 = Reduces DC-braking current 3 = Reduces acc. and decel. times 4 = Reduces torque supervis. limit	5-21
2.22	Motorized digital potentiometer ramp time	0.1—2000.0 Hz/s	0.1 Hz/s	10.0 Hz/s			5-22

Group 3, Output and supervision parameters

Code	Parameter	Range	Step	Default	Custom	Description	Page
3.1	Analog output function 	0—7	1	1		0 = Not used Scale 100% 1 = O/P frequency (0—f _{max}) 2 = Motor speed (0—max. speed) 3 = O/P current (0—2.0 x I _{nSV9}) 4 = Motor torque (0—2 x T _{nMot}) 5 = Motor power (0—2 x P _{nMot}) 6 = Motor voltage (0—100% x V _{nMot}) 7 = DC-link volt. (0—1000 V)	5-23
3.2	Analog output filter time	0.00-10.00s	0.01 s	1.00 s			5-23
3.3	Analog output inversion	0—1	1	0		0 = Not inverted 1 = Inverted	5-23
3.4	Analog output minimum	0—1	1	0		0 = 0 mA 1 = 4 mA	5-23
3.5	Analog output scale	10—1000%	1%	100%			5-23

Note!  = Parameter value can be changed only when the drive is stopped.



Code	Parameter	Range	Step	Default	Custom	Description	Page
3.6	Digital output function 	0—21	1	1		0 = Not used 1 = Ready 2 = Run 3 = Fault 4 = Fault inverted 5 = SV9000 overheat warning 6 = External fault or warning 7 = Reference fault or warning 8 = Warning 9 = Reversed 10 = Jog speed selected 11 = At speed 12 = Motor regulator activated 13 = Output freq. limit superv. 1 14 = Output freq. limit superv. 2 15 = Torque limit supervision 16 = Reference limit supervision 17 = External brake control 18 = Control from I/O terminals 19 = Drive temperature limit supervision 20 = Unrequested rotation direction 21 = External brake control inverted	5-24
3.7	Relay output 1 function 	0—21	1	2		As parameter 3.6	5-24
3.8	Relay output 2 function 	0—21	1	3		As parameter 3.6	5-24
3.9	Output freq. limit 1 supervision function	0—2	1	0		0 = No 1 = Low limit 2 = High limit	5-24
3.10	Output freq. limit 1 supervision value	0.0— f_{max} (par. 1.2)	0.1 Hz	0.0 Hz			5-24
3.11	Output freq. limit 2 supervision function	0—2	1	0		0 = No 1 = Low limit 2 = High limit	5-24
3.12	Output freq. limit 2 supervision value	0.0— f_{max} (par. 1.2)	0.1 Hz	0.0 Hz			5-24
3.13	Torque limit supervision function	0—2	1	0		0 = No 1 = Low limit 2 = High limit	5-25
3.14	Torque limit supervision value	-200.0—200.0% $\times T_{nSV9}$	0.1%	100.0%			5-25
3.15	Reference limit supervision function	0—2	1	0		0 = No 1 = Low limit 2 = High limit	5-25
3.16	Reference limit supervision value	0.0— f_{max} (par. 1.2)	0.1 Hz	0.0 Hz			5-25
3.17	Extern. brake Off-delay	0.0—100.0 s	0.1 s	0.5 s			5-25
3.18	Extern. brake On-delay	0.0—100.0 s	0.1 s	1.5 s			5-25
3.19	Drive temperature limit supervision function	0—2	1	0		0 = No 1 = Low limit 2 = High limit	5-25
3.20	Drive temperature limit value	-10—+75°C	1°C	+40°C			5-25

Note!  = Parameter value can be changed only when the drive is stopped.



Code	Parameter	Range	Step	Default	Custom	Description	Page
3.21	I/O-expander board (opt.) analog output content	0—7	1	3		See parameter 3.1	5-23
3.22	I/O-expander board (opt.) analog output filter time	0.00—10.00 s	0.01	1.00 s		See parameter 3.2	5-23
3.23	I/O-expander board (opt.) analog output inversion	0—1	1	0		See parameter 3.3	5-23
3.24	I/O-expander board (opt.) analog output minimum	0—1	1	0		See parameter 3.4	5-23
3.25	I/O-expander board (opt.) analog output scale	10—1000%	1	100%		See parameter 3.5	5-23

Group 4, Drive control parameters

Code	Parameter	Range	Step	Default	Custom	Description	Page
4.1	Acc./Dec. ramp 1 shape	0.0—10.0 s	0.1 s	0.0 s		0 = Linear >0 = S-curve acc./dec. time	5-26
4.2	Acc./Dec. ramp 2 shape	0.0—10.0 s	0.1 s	0.0 s		0 = Linear >0 = S-curve acc./dec. time	5-26
4.3	Acceleration time 2	0.1—3000.0 s	0.1 s	10.0 s			5-27
4.4	Deceleration time 2	0.1—3000.0 s	0.1 s	10.0 s			5-27
4.5	Brake chopper 	0—2	1	0		0 = Brake chopper not in use 1 = Brake chopper in use 2 = External brake chopper	5-27
4.6	Start function	0—1	1	0		0 = Ramp 1 = Flying start	5-27
4.7	Stop function	0—1	1	0		0 = Coasting 1 = Ramp	5-27
4.8	DC-braking current	0.15—1.5 $\times I_{nSV9}$ (A)	0.1 A	$0.5 \times I_{nSV9}$			5-27
4.9	DC-braking time at Stop	0.00-250.00s	0.01 s	0.00 s		0 = DC-brake is off at Stop	5-28
4.10	Execute frequency of DC-brake during ramp Stop	0.1—10.0 Hz	0.1 Hz	1.5 Hz			5-29
4.11	DC-brake time at Start	0.00-25.00 s	0.01 s	0.00 s		0 = DC-brake is off at Start	5-29
4.12	Multi-step speed reference 1	f_{min} — f_{max} (1.1) (1.2)	0.1 Hz	10.0 Hz			5-29
4.13	Multi-step speed reference 2	f_{min} — f_{max} (1.1) (1.2)	0.1 Hz	15.0 Hz			5-29
4.14	Multi-step speed reference 3	f_{min} — f_{max} (1.1) (1.2)	0.1 Hz	20.0 Hz			5-29
4.15	Multi-step speed reference 4	f_{min} — f_{max} (1.1) (1.2)	0.1 Hz	25.0 Hz			5-29
4.16	Multi-step speed reference 5	f_{min} — f_{max} (1.1) (1.2)	0.1 Hz	30.0 Hz			5-29
4.17	Multi-step speed reference 6	f_{min} — f_{max} (1.1) (1.2)	0.1 Hz	40.0 Hz			5-29
4.18	Multi-step speed reference 7	f_{min} — f_{max} (1.1) (1.2)	0.1 Hz	50.0 Hz			5-29







Note!  = Parameter value can be changed only when the drive is stopped.



Group 5, Prohibit frequency parameters

Code	Parameter	Range	Step	Default	Custom	Description	Page
5.1	Prohibit frequency range 1 low limit	f_{\min} — par. 5.2	0.1 Hz	0.0 Hz			5-29
5.2	Prohibit frequency range 1 high limit	f_{\min} — f_{\max} (1.1) (1.2)	0.1 Hz	0.0 Hz		0 = Prohibit range 1 is off	5-29
5.3	Prohibit frequency range 2 low limit	f_{\min} — par. 5.4	0.1 Hz	0.0 Hz			5-29
5.4	Prohibit frequency range 2 high limit	f_{\min} — f_{\max} (1.1) (1.2)	0.1 Hz	0.0 Hz		0 = Prohibit range 2 is off	5-29
5.5	Prohibit frequency range 3 low limit	f_{\min} — par. 5.6	0.1 Hz	0.0 Hz			5-29
5.6	Prohibit frequency range 3 high limit	f_{\min} — f_{\max} (1.1) (1.2)	0.1 Hz	0.0 Hz		0 = Prohibit range 3 is off	5-29

Group 6, Motor control parameters

Code	Parameter	Range	Step	Default	Custom	Description	Page
6.1	Motor control mode 	0—1	1	0		0 = Frequency control 1 = Speed control	5-29
6.2	Switching frequency	1.0—16.0 kHz	0.1 kHz	10/3.6 kHz		Depends on Hp rating	5-30
6.3	Field weakening point 	30—500 Hz	1 Hz	Param. 1.11			5-30
6.4	Voltage at field weakening point 	15—200% $\times V_{\text{nmot}}$	1%	100%			5-30
6.5	V/Hz curve mid point frequency 	0.0— f_{\max}	0.1 Hz	0.0 Hz			5-30
6.6	V/Hz curve mid point voltage 	0.00—100.00% $\times V_{\text{nmot}}$	0.01%	0.00 %			5-30
6.7	Output voltage at zero frequency 	0.00—100.00% $\times V_{\text{nmot}}$	0.01%	0.00 %			5-30
6.8	Overvoltage controller	0—1	1	1		0 = Controller is not operating 1 = Controller is operating	5-31
6.9	Undervoltage controller	0—1	1	1		0 = Controller is not operating 1 = Controller is operating	5-31

Note!  = Parameter value can be changed only when the drive is stopped.



Group 7, Protections

Code	Parameter	Range	Step	Default	Custom	Description	Page
7.1	Response to reference fault	0—2	1	0		0 = No action 1 = Warning 2 = Fault, stop according to par 4.7 3 = Fault, always coasting stop	5-31
7.2	Response to external fault	0—2	1	2		0 = No action 1 = Warning 2 = Fault, stop according to par 4.7 3 = Fault, always coasting stop	5-31
7.3	Phase supervision of the motor	0—2	2	2		0 = No action 2 = Fault	5-31
7.4	Ground fault protection	0—2	2	2		0 = No action 2 = Fault	5-31
7.5	Motor thermal protection	0—2	1	2		0 = No action 1 = Warning 2 = Fault	5-32
7.6	Motor thermal protection break point current	50.0—150.0% $\times I_{nMOTOR}$	1.0 %	100.0%			5-32
7.7	Motor thermal protection zero frequency current	5.0—150.0% $\times I_{nMOTOR}$	1.0 %	45.0%			5-33
7.8	Motor thermal protection time constant	0.5—300.0 minutes	0.5 min.	17.0 min.		Default value is set according to motor nominal current	5-33
7.9	Motor thermal protection break point frequency	10—500 Hz	1 Hz	35 Hz			5-34
7.10	Stall protection	0—2	1	1		0 = No action 1 = Warning 2 = Fault	5-34
7.11	Stall current limit	5.0—200.0% $\times I_{nMOTOR}$	1.0%	130.0%			5-35
7.12	Stall time	2.0—120.0 s	1.0 s	15.0 s			5-35
7.13	Maximum stall frequency	1— f_{max}	1 Hz	25 Hz			5-35
7.14	Underload protection	0—2	1	0		0 = No action 1 = Warning 2 = Fault	5-36
7.15	Underload prot., field weakening area load	10.0—150.0% $\times T_{nMOTOR}$	1.0%	50.0%			5-36
7.16	Underload protection, zero frequency load	5.0—150.0% $\times T_{nMOTOR}$	1.0%	10.0%			5-36
7.17	Underload time	2.0—600.0 s	1.0 s	20.0s			5-36



Group 8, Autorestart parameters

Code	Parameter	Range	Step	Default	Custom	Description	Page
8.1	Automatic restart: number of tries	0—10	1	0		0 = not in use	5-37
8.2	Automatic restart:multi attempt maximum trial time	1—6000 s	1 s	30 s			5-37
8.3	Automatic restart: start function	0—1	1	0		0 = Ramp 1 = Flying start	5-38
8.4	Automatic restart of undervoltage	0—1	1	0		0 = No 1 = Yes	5-38
8.5	Automatic restart of overvoltage	0—1	1	0		0 = No 1 = Yes	5-38
8.6	Automatic restart of overcurrent	0—1	1	0		0 = No 1 = Yes	5-38
8.7	Automatic restart of reference fault	0—1	1	0		0 = No 1 = Yes	5-38
8.8	Automatic restart after over/undertemperature fault	0—1	1	0		0 = No 1 = Yes	5-38

Table 5.5-1 Special parameters, Groups 2—8.



5.5.2 Description of Groups 2—8 parameters

2.1 Start/Stop logic selection

- 0: DIA1: closed contact = start forward
 DIA2: closed contact = start reverse,
 See figure 5.5-1.

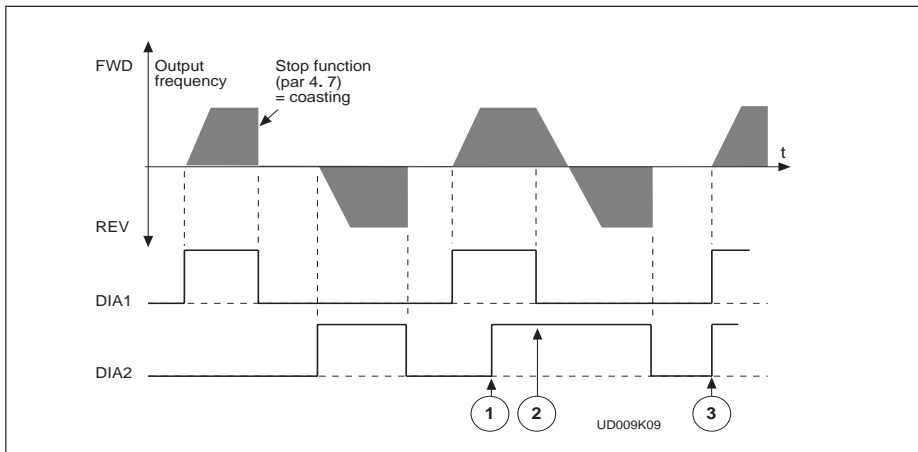

Figure 5.5-1 Start forward/Start reverse.

- ① The first selected direction has the highest priority
- ② When DIA1 contact opens, the direction of rotation starts to change
- ③ If Start forward (DIA1) and Start reverse (DIA2) signals are active simultaneously, the Start forward signal (DIA1) has priority.

- 1: DIA1: closed contact = start open contact = stop
 DIA2: closed contact = reverse open contact = forward
 See figure 5.5-2.

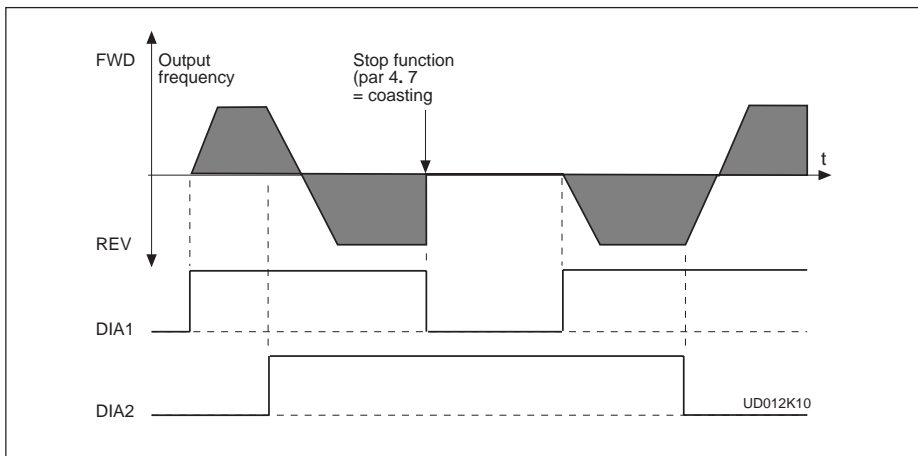

Figure 5.5-2 Start, Stop, reverse.



- 2: DIA1: closed contact = start open contact = stop
 DIA2: closed contact = start enabled open contact = start disabled
- 3: 3-wire connection (pulse control):
 DIA1: closed contact = start pulse
 DIA2: closed contact = stop pulse
 (DIA3 can be programmed for reverse command)
 See figure 5.5-3.

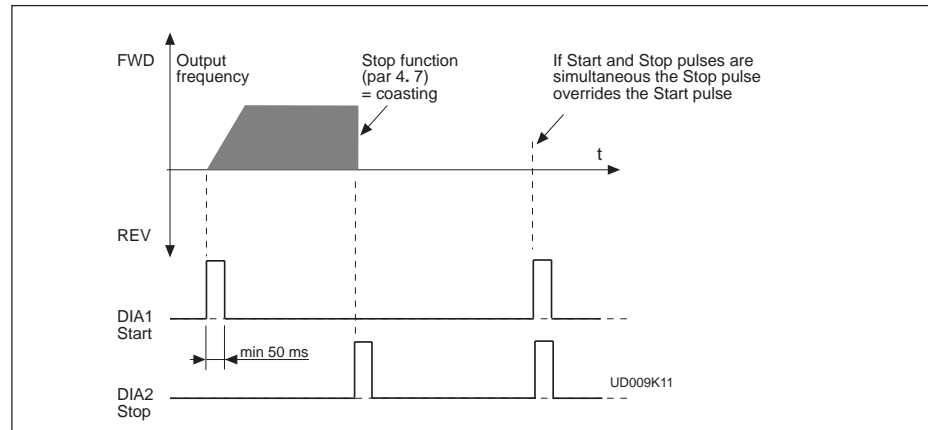

Figure 5.5-3 Start pulse /Stop pulse.

2. 2 DIA3 function

- 1: External fault, closing contact = Fault is shown and drive responds according to parameter 7.2.
- 2: External fault, opening contact = Fault is shown and drive responds according to parameter 7.2.
- 3: Run enable contact open = Start of the motor disabled
 contact closed = Start of the motor enabled
- 4: Acc. / Dec time select. contact open = Acceleration/Deceleration time 1 selected
 contact closed = Acceleration/Deceleration time 2 selected
- 5: Reverse contact open = Forward || Can be used for reversing if
 contact closed = Reverse || parameter 2. 1 has value 3
- 6: Jog speed. contact closed = Jog speed selected for freq. reference
- 7: Fault reset contact closed = Resets all faults
- 8: Acc./Dec. operation prohibited contact closed = Stops acceleration or deceleration until the contact is opened
- 9: DC-braking command contact closed = In Stop mode, the DC-braking operates until the contact is opened, see figure 5.5-4. DC-brake current is set with parameter 4. 8.

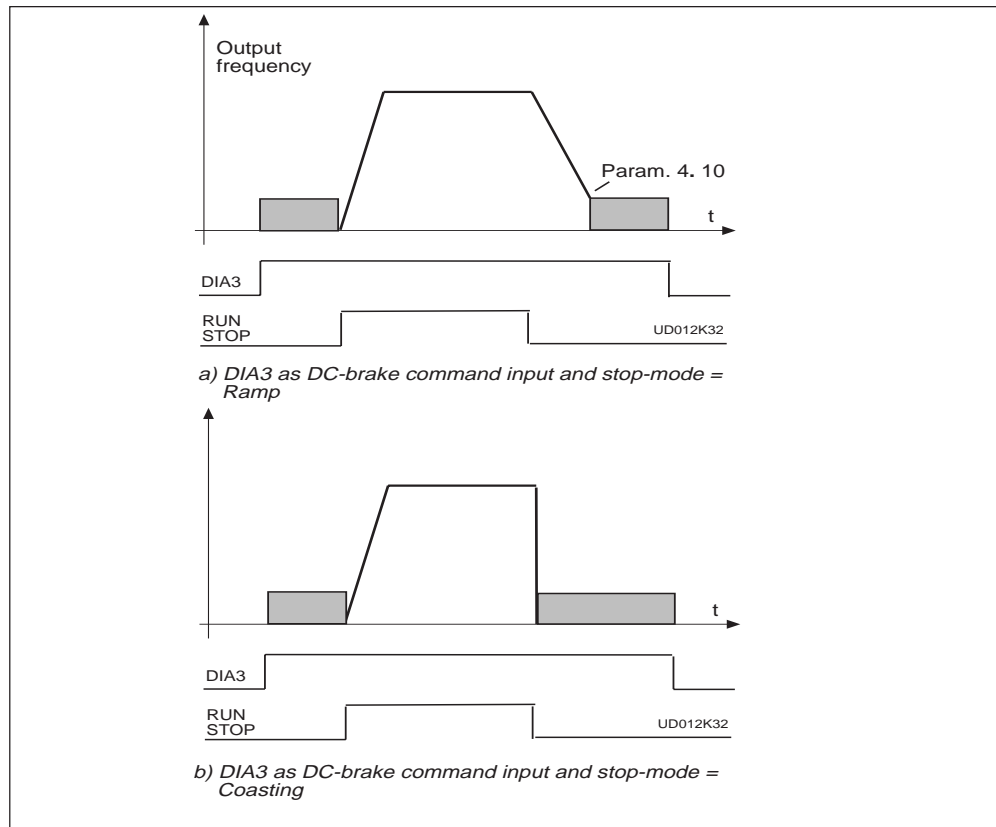

Figure 5.5-4 DIA3 as DC-brake command input: a) Stop-mode = Ramp, b) Stop-mode = Coasting.

2. 3 DIB4 function

Selections are same as in 2. 2 except :

10: Multi-Step contact closed = Selection 1 active
speed select 1

2. 4 DIB5 function

Selections are same as in 2. 2 except :

10: Multi-Step contact closed = Selection 2 active
speed select 2

11: Motor pot. contact closed= Reference decreases until the contact is
UP opened

2. 5 DIB6 function

Selections are same as in 2. 2 except :

10: Multi-Step contact closed= Selection 3 active
speed select 3

11: Motor pot. contact closed= Reference decreases until the contact is
DOWN opened

2.6 V_{in} signal range

0 = Signal range 0—+10 V

1 = Custom setting range from custom minimum (par. 2. 7) to custom maximum (par. 2. 8)

2 = Signal range -10—+10 V , can be used only with Joystick control

2.7 V_{in} custom setting minimum/maximum**2.8** With these parameters, V_{in} can be set for any input signal span within 0—10 V.

Minimum setting: Set the V_{in} signal to its minimum level, select parameter 2. 7, press the Enter button

Maximum setting: Set the V_{in} signal to its maximum level, select parameter 2. 8, press the Enter button

Note! These parameters can only be set with this procedure (not with arrow up/arrow down buttons)

2.9 V_{in} signal inversion

Parameter 2. 9 = 0, no inversion of analog V_{in} signal.

Parameter 2. 9 = 1, inversion of analog V_{in} signal.

2.10 V_{in} signal filter time

Filters out disturbances from the incoming analog V_{in} signal. A long filtering time makes drive response slower. See figure 5.5-5.

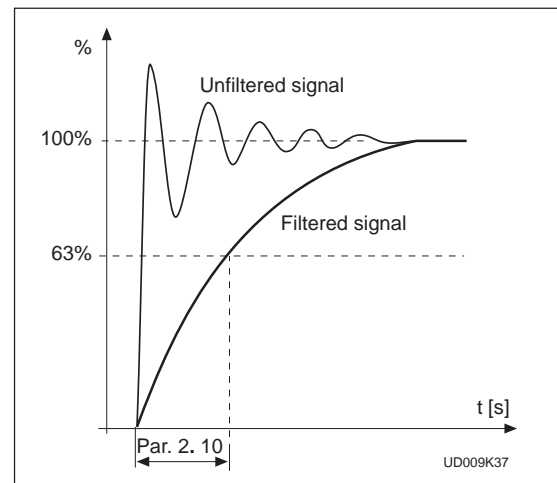

Figure 5.5-5 V_{in} signal filtering.

2. 11 Analog input I_{in} signal range

- 0 = 0—20 mA
- 1 = 4—20 mA
- 2 = Custom signal span

2. 12 Analog input I_{in} setting minimum/maximum **custom**

With these parameters, the scaling of the input current signal (I_{in}) range can be set between 0—20 mA.

Minimum setting: Set the I_{in} signal to its minimum level, select parameter 2. 12, press the Enter button

Maximum setting: Set the I_{in} signal to its maximum level, select parameter 2. 13, press the Enter button

Note! These parameters can only be set with this procedure (not with arrow up/arrow down buttons)

2. 14 Analog input I_{in} inversion

Parameter 2. 14 = 0, no inversion of I_{in} input
 Parameter 2. 14 = 1, inversion of I_{in} input.

2. 15 Analog input I_{in} filter time

Filters out disturbances from the incoming analog I_{in} signal. A long filtering time makes drive response slower. See figure 5.5-6.

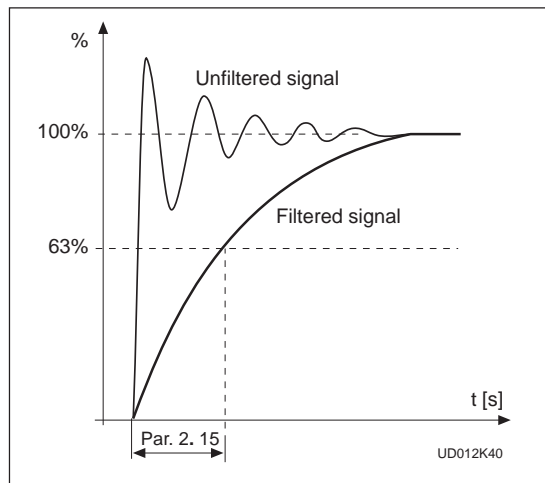

Figure 5.5-6 Analog input I_{in} filter time.

2. 16 V_{in} signal minimum scaling

Sets the minimum scaling point for V_{in} signal. See figure 5.5-7.

2. 17 V_{in} signal maximum scaling

Sets the maximum scaling point for V_{in} signal. See figure 5.5-7.

2. 18 I_{in} signal minimum scaling

Sets the minimum scaling point for I_{in} signal. See figure 5.5-7.

2. 19 I_{in} signal maximum scaling

Sets the maximum scaling point for I_{in} signal. See figure 5.5-7.



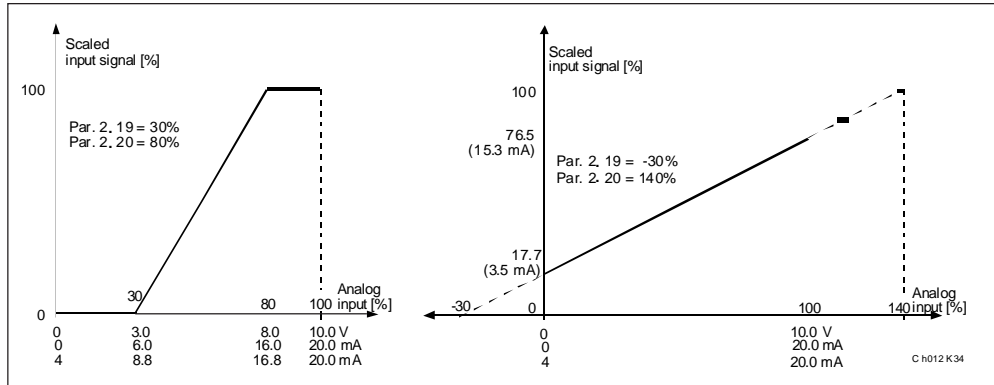

Figure 5.5-7 Examples of the scaling of V_{in} and I_{in} inputs .

2. 20 Free analog input signal

Selection of input signal of free analog input (an input not used for reference signal):

- 0 = Not in use
- 1 = Voltage signal V_{in}
- 2 = Current signal I_{in}

2. 21 Free analog input signal function

This parameter sets the function of the free analog input:

- 0 = Function is not used
- 1 = Reducing motor current limit (par. 1.7)

This signal will adjust the maximum motor current between 0 and parameter 1.7 set max. limit. See figure 5.5-8.

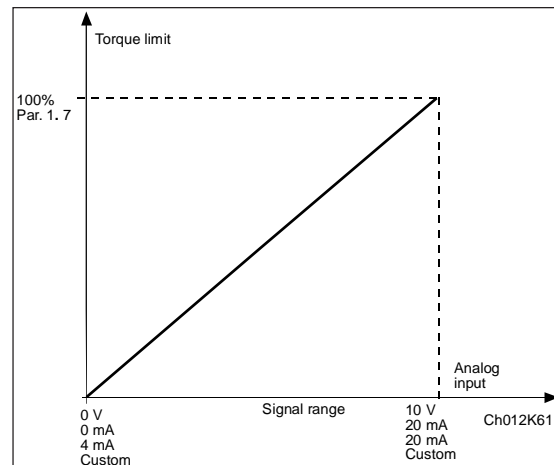

Figure 5.5-8 Reducing the max. motor current.

- 2 = Reducing DC brake current.

The DC braking current can be reduced, with the free analog input signal, between $0.15 \times I_{nSV9}$ and current set by parameter 4.8.

See figure 5.5-9.

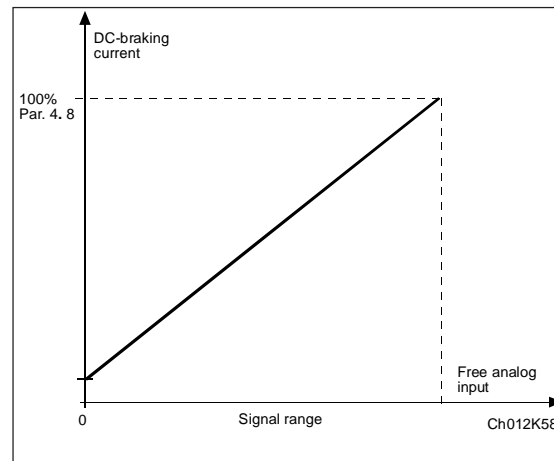

Figure 5.5-9 Reducing the DC brake current.



3 Reducing acceleration and deceleration times.

The acceleration and deceleration times can be reduced with the free analog input signal, according to the following formula:

Reduced time = set acc./decel time (par. 1. 3, 1. 4; 4. 3, 4. 4) divided by the factor R from figure 5.5-10.

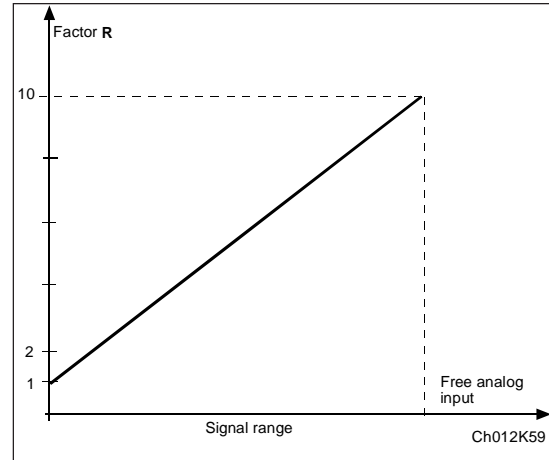

Figure 5.5-10 Reducing acceleration and deceleration times.

4 Reducing torque supervision limit.

The set torque supervision limit can be reduced with the free analog input signal between 0 and set supervision limit (par. 3. 14), see figure 5.5-11.

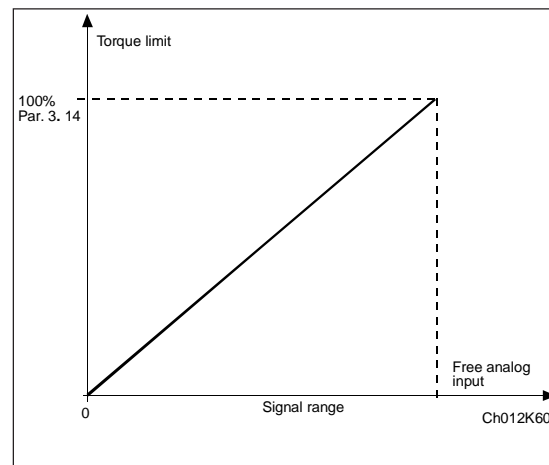

Figure 5.5-11 Reducing torque supervision limit.

2. 22 Motor potentiometer ramp time

Defines how fast the electronic motor (digital) potentiometer value changes.

3.1 Analog output function

See table on page 5-10.

3.2 Analog output filter time

Filters the analog output signal.
See figure 5.5-12.

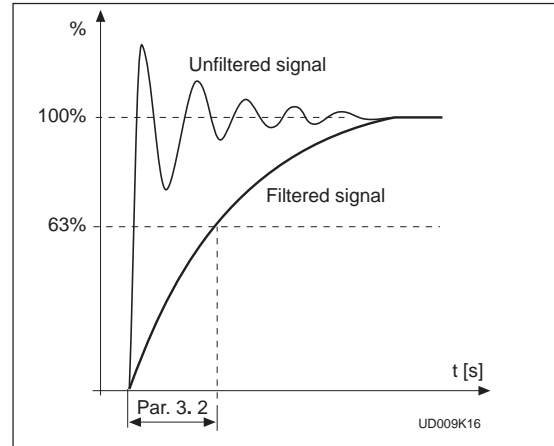

Figure 5.5-12 Analog output filtering.

3.3 Analog output invert

Inverts analog output signal:
max output signal = minimum set value
min output signal = maximum set value

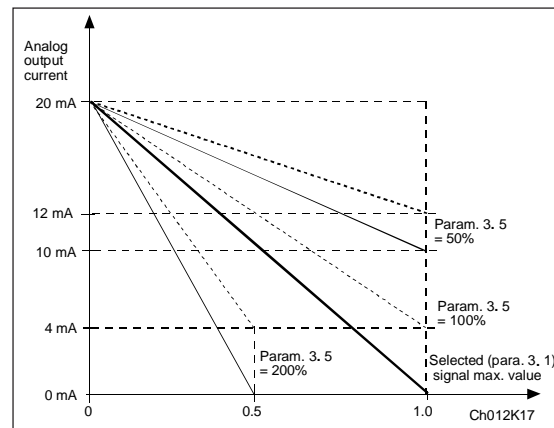

Figure 5.5-13 Analog output invert.

3.4 Analog output minimum

Defines the signal minimum to be either 0 mA or 4 mA. See figure 5.5-14.

3.5 Analog output scale

Scaling factor for analog output.
See figure 5.5-14.

Signal	Max. value of the signal
Output frequency	Max. frequency (p. 1. 2)
Motor speed	Max. speed ($n_n \times f_{max} / f_n$)
Output current	$2 \times I_{nSV9}$
Motor torque	$2 \times T_{nMot}$
Motor power	$2 \times P_{nMot}$
Motor voltage	$100\% \times V_{nMot}$
DC-link volt.	1000 V

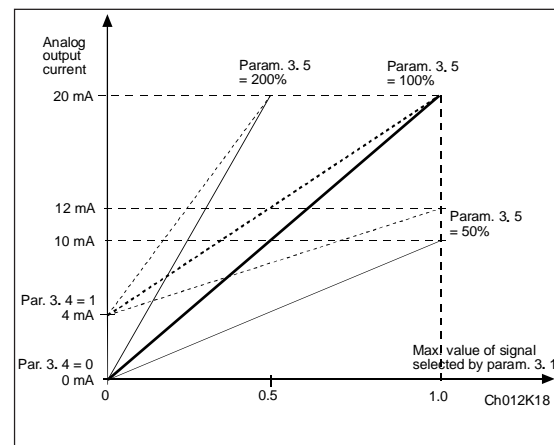

Figure 5.5-14 Analog output scale.



- 3.6 Digital output function**
- 3.7 Relay output 1 function**
- 3.8 Relay output 2 function**

Setting value	Signal content
0 = Not used	Out of operation <u>Digital output DO1 sinks current and programmable relay (RO1, RO2) is activated when:</u>
1 = Ready	The drive is ready to operate
2 = Run	The drive operates (motor is running)
3 = Fault	A fault trip has occurred
4 = Fault inverted	A fault trip <u>has not</u> occurred
5 = SV9000 overheat warning	The heat-sink temperature exceeds +70°C
6 = External fault or warning	Fault or warning depending on parameter 7. 2
7 = Reference fault or warning	Fault or warning depending on parameter 7. 1 - if analog reference is 4—20 mA and signal is <4mA
8 = Warning	If a warning exists. See Table 7.10-1 in the Users' Manual
9 = Reversed	The reverse command has been selected
10= Jog speed	Jog speed has been selected with digital input
11= At speed	The output frequency has reached the set reference
12= Motor regulator activated	Overvoltage or overcurrent regulator was activated
13= Output frequency supervision 1	The output frequency goes outside of the set supervision Low limit/ High limit (par. 3. 9 and 3. 10)
14= Output frequency supervision 2	The output frequency goes outside of the set supervision Low limit/ High limit (par. 3. 11 and 3. 12)
15= Torque limit supervision	The motor torque goes outside of the set supervision Low limit/ High limit (par. 3. 13 and 3. 14)
16= Reference limit supervision	Reference goes outside of the set supervision Low limit/ High limit (par. 3. 15 and 3. 16)
17= External brake control	External brake ON/OFF control with programmable delay (par 3. 17 and 3. 18)
18= Control from I/O terminals	External control mode selected with prog. pushbutton #2
19= Drive	Temperature on drive goes outside the set temperature supervision limits (par. 3. 19 and 3. 20)
20= Unrequested rotation direction	Rotation direction of the motor shaft is different from the requested one
21 = External brake control inverted	External brake ON/OFF control (par. 3.17 and 3.18), output active when brake control is OFF

Table 5.5-2 Output signals via DO1 and output relays RO1 and RO2.

5

- 3.9 Output frequency limit 1, supervision function**
- 3.11 Output frequency limit 2, supervision function**

- 0 = No supervision
- 1 = Low limit supervision
- 2 = High limit supervision

If the output frequency goes under/over the set limit (3. 10, 3. 12) this function generates a warning message via the digital output DO1 or via a relay output RO1 or RO2 depending on the settings of the parameters 3. 6—3. 8.

- 3.10 Output frequency limit 1, supervision value**
- 3.12 Output frequency limit 2, supervision value**

The frequency value to be supervised by the parameter 3. 9 (3. 11). See figure 5.5-15.



3. 13 Torque limit , supervision function

- 0 = No supervision
- 1 = Low limit supervision
- 2 = High limit supervision

If the calculated torque value goes under/over the set limit (3. 14) this function generates a warning message via the digital output DO1, via a relay output RO1 or RO2 depending on the settings of parameters 3. 6—3. 8.

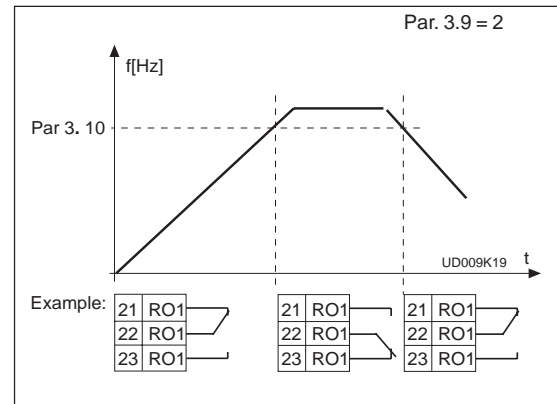

Figure 5.5-15 Output frequency supervision.

3. 14 Torque limit , supervision value

The calculated torque value to be supervised by the parameter 3. 13.

3. 15 Reference limit , supervision function

- 0 = No supervision
- 1 = Low limit supervision
- 2 = High limit supervision

If the reference value goes under/over the set limit (3. 16) this function generates a warning message via the digital output DO1 or via a relay output RO1 or RO2 depending on the settings of the parameters 3. 6—3. 8. The supervised reference is the current active reference. It can be source A or B reference depending on DIB6 input or the panel reference if panel is the active control source.

3. 16 Reference limit , supervision value

The frequency value to be supervised by the parameter 3. 15.

3. 17 External brake-off delay

3. 18 External brake-on delay

The function of the external brake can be delayed from the start and stop control signals with these parameters. See figure 5.5-16.

The brake control signal can be programmed via the digital output DO1 or via one of relay outputs RO1 and RO2, see parameters 3. 6—3. 8.

3. 19 Drive temperature limit supervision function

- 0 = No supervision
- 1 = Low limit supervision
- 2 = High limit supervision

If the temperature of the drive goes under/over the set limit (3. 20) this function generates a warning message via the digital output DO1 or via a relay output RO1 or RO2 depending on the settings of the parameters 3. 6—3. 8.

3. 20 Drive temperature limit value

The temperature value to be supervised by the parameter 3. 19.

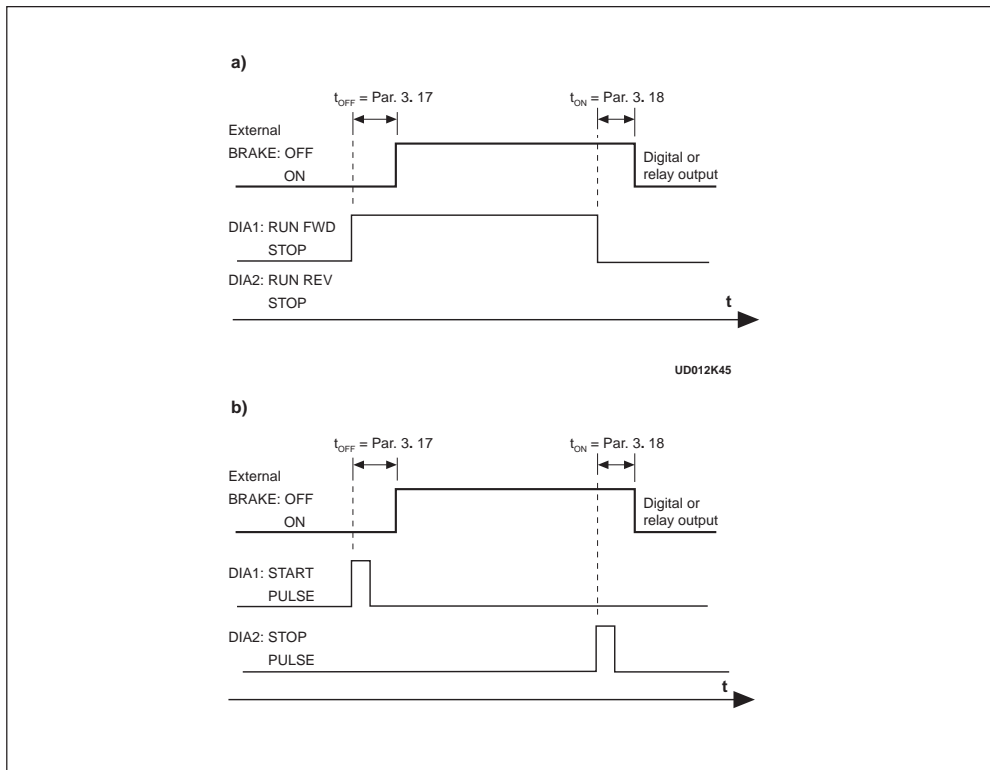

Figure 5.5-16 External brake control: a) Start/Stop logic selection par. 2. 1 = 0, 1 or 2
b) Start/Stop logic selection par. 2. 1 = 3.

4. 1 Acc/Dec ramp 1 shape
4. 2 Acc/Dec ramp 2 shape

The acceleration and deceleration ramp shape can be programmed with these parameters.

Setting the value = 0 gives you a linear ramp shape. The output frequency immediately follows the input with a ramp time set by parameters 1. 3, 1. 4 (4. 3, 4. 4 for Acc/Dec time 2).

Setting 0.1—10 seconds for 4. 1 (4. 2) causes an S-shaped ramp. The speed changes are smooth. Parameter 1. 3/ 1. 4 (4. 3/ 4. 4) determines the ramp time of the acceleration/ deceleration in the middle of the curve.

See figure 5.5-17.

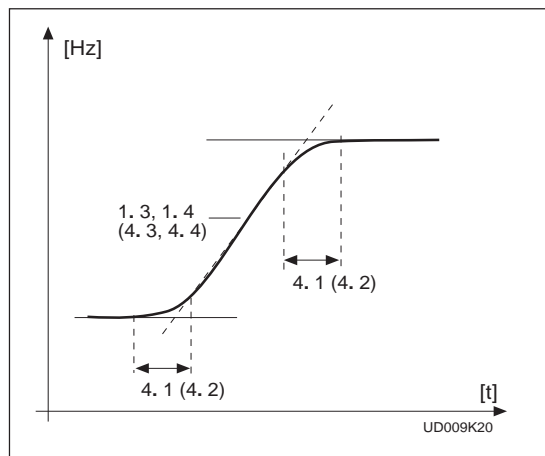

Figure 5.5-17 S-shaped acceleration/ deceleration.



4.3 Acceleration time 2**4.4 Deceleration time 2**

These values correspond to the time required for the output frequency to accelerate from the set minimum frequency (par. 1. 1) to the set maximum frequency (par. 1. 2). With this parameter it is possible to set two different acceleration/deceleration times for one application. The active set can be selected with the programmable signal DIA3 of this application, see parameter 2. 2. Acceleration/deceleration times can be reduced with an external free analog input signal, see parameters 2. 18 and 2. 19.

4.5 Brake chopper

- 0 = No brake chopper
- 1 = Brake chopper and brake resistor installed
- 2 = External brake chopper

When the drive is decelerating the motor, the energy stored in the inertia of the motor and the load is fed into the external brake resistor. If the brake resistor is selected correctly the drive is able to decelerate the load with a torque equal to that of acceleration. See the separate Brake resistor installation manual.

4.6 Start function

Ramp:

- 0** The drive starts from 0 Hz and accelerates to the set reference frequency within the set acceleration time. (Load inertia or starting friction may cause prolonged acceleration times).

Flying start:

- 1** The drive starts into a running motor by first finding the speed the motor is running at. Searching starts from the maximum frequency down until the actual frequency reached. The output frequency then accelerates/decelerates to the set reference value at a rate determined by the acceleration/deceleration ramp parameters.

Use this mode if the motor may be coasting when the start command is given. With the flying start it is possible to ride through short utility voltage interruptions.

4.7 Stop function

Coasting:

- 0** The motor coasts to an uncontrolled stop with the SV9000 off, after the Stop command.

Ramp:

- 1** After the Stop command, the speed of the motor is decelerated according to the deceleration ramp time parameter. If the regenerated energy is high it may be necessary to use an external braking resistor for faster deceleration.

4.8 DC braking current

Defines the current injected into the motor during DC braking.



4.9 DC braking time at stop

Defines if braking is ON or OFF and braking time of the DC-brake when the motor is stopping. The function of the DC-brake depends on the stop function, parameter 4. 7. See figure 5.5-18.

- 0** DC-brake is not used
- >0** DC-brake is in use and its function depends on the Stop function, (param. 4. 7), and the time depends on the value of parameter 4. 9:

Stop-function = 0 (coasting):

After the stop command, the motor will coast to a stop with the SV9000 off.

With DC-injection, the motor can be electrically stopped in the shortest possible time, without using an optional external braking resistor.

The braking time is scaled according to the frequency when the DC-braking starts. If the frequency is \geq nominal frequency of the motor (par. 1.11), setting value of parameter 4.9 determines the braking time. When the frequency is \leq 10% of the nominal, the braking time is 10% of the set value of parameter 4.9.

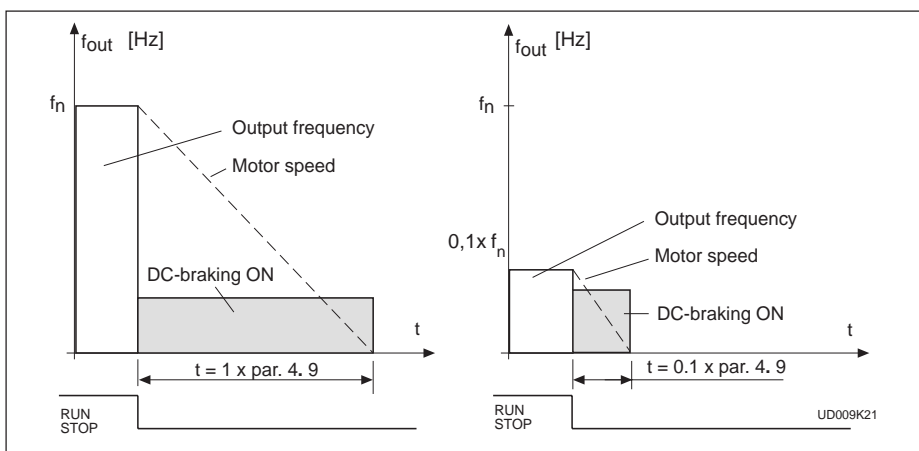

Figure 5.5-18 DC-braking time when stop = coasting.

Stop-function = 1 (ramp):

After the Stop command, the speed of the motor is reduced based on the deceleration parameter ramp parameter, if no regeneration occurs due to load inertia, to a speed defined with parameter 4. 10, where the DC-braking starts.

The braking time is defined with parameter 4. 9.

If high inertia exists, it is recommended to use an external braking resistor for faster deceleration. See figure 5.5-19.

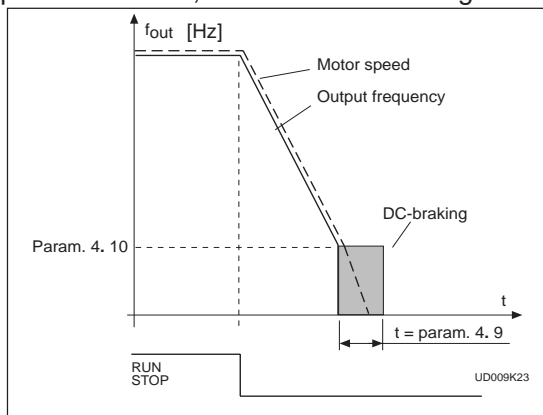

Figure 5.5-19 DC-braking time when stop function = ramp



4. 10 Execute frequency of DC-brake during ramp Stop

See figure 5.5-19.

4. 11 DC-brake time at start

- 0** DC-brake is not used
- >0** DC-brake is active when the start command is given. This parameter defines the time before the brake is released. After the brake is released the output frequency increases according to the set start function parameter 4. 6 and the acceleration parameters (1. 3, 4. 1 or 4. 2, 4. 3). See figure 5.5-20.

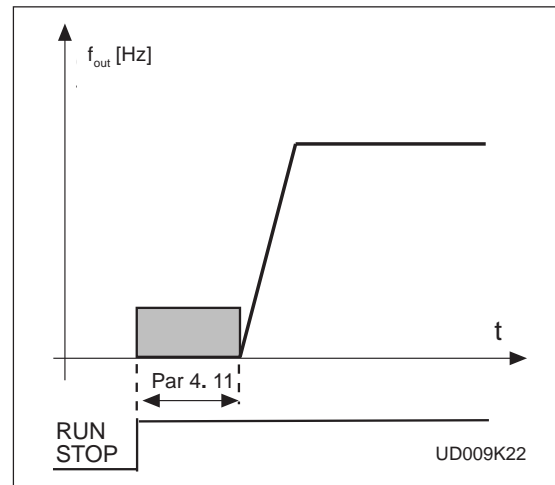

Figure 5.5-20 DC-braking at start.

4. 12 - 4. 18 Multi-Step speeds 1-7

These parameter values define the Multi-step speeds selected with the DIA4, DIB5 and DIB6 digital inputs. The selection of Multi-step speeds will occur similarly as described in the table 3.4-2 page 3-8.

5. 1- 5.6 Prohibit frequency area Low limit/High limit

In some systems it may be necessary to avoid certain frequencies because of mechanical resonance problems.

With these parameters it is possible to set limits for three "skip frequency" regions. The accuracy of the setting is 0.1 Hz.

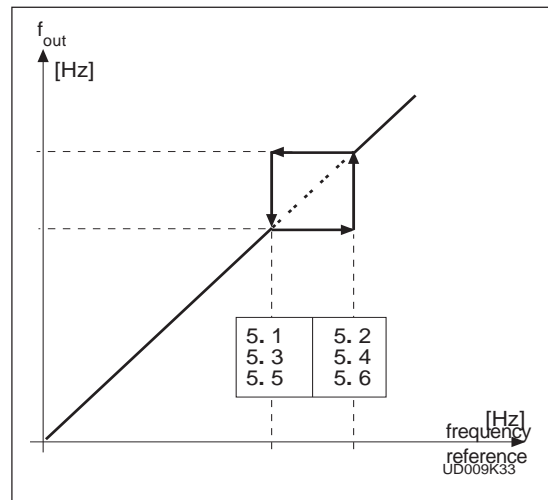

Figure 5.5-21 Example of prohibit frequency area setting

6. 1 Motor control mode

0 = Frequency control:
(V/Hz)

The I/O terminal and panel references are frequency references and the drive controls the output frequency (output frequency resolution = 0.01 Hz)

1 = Speed control:
(sensorless vector)

The I/O terminal and panel references are speed references and the drive controls the motor speed (regulation accuracy $\pm 0.5\%$).

6.2 Switching frequency

Motor noise can be minimized using a high switching frequency. Increasing the switching frequency reduces the capacity of the SV9000.

Before changing the frequency from the factory default 10 kHz ($3.6 \text{ kHz} \geq 40 \text{ Hp}$), check the drive derating from the curves in figures 5.2-2 and 5.2-3 in the User's Manual.

6.3 Field weakening point

6.4 Voltage at the field weakening point

The field weakening point is the output frequency at which the output voltage reaches the set maximum value (par. 6. 4). Above this frequency the output voltage remains at the set maximum value.

Below that frequency the output voltage depends on the setting of the V/Hz curve parameters 1. 8, 1. 9, 6. 5, 6. 6 and 6. 7. See figure 5.5-22.

When the parameters 1. 10 and 1. 11, nominal voltage and nominal frequency of the motor are set, parameters 6. 3 and 6. 4 are also set automatically to the corresponding values. If you need different values for the field weakening point and the maximum output voltage, change these parameters after setting parameters 1. 10 and 1. 11.

6.5 V/Hz curve, middle point frequency

If the programmable V/Hz curve has been selected with parameter 1. 8, this parameter defines the middle point frequency of the curve. See figure 5.5-22.

6.6 V/Hz curve, middle point voltage

If the programmable V/Hz curve has been selected with parameter 1. 8 this parameter defines the middle point voltage of the curve. See figure 5.5-22.

6.7 Output voltage at zero frequency

If the programmable V/Hz curve has been selected with parameter 1. 8 this parameter defines the zero frequency voltage of the curve. See figure 5.5-22.

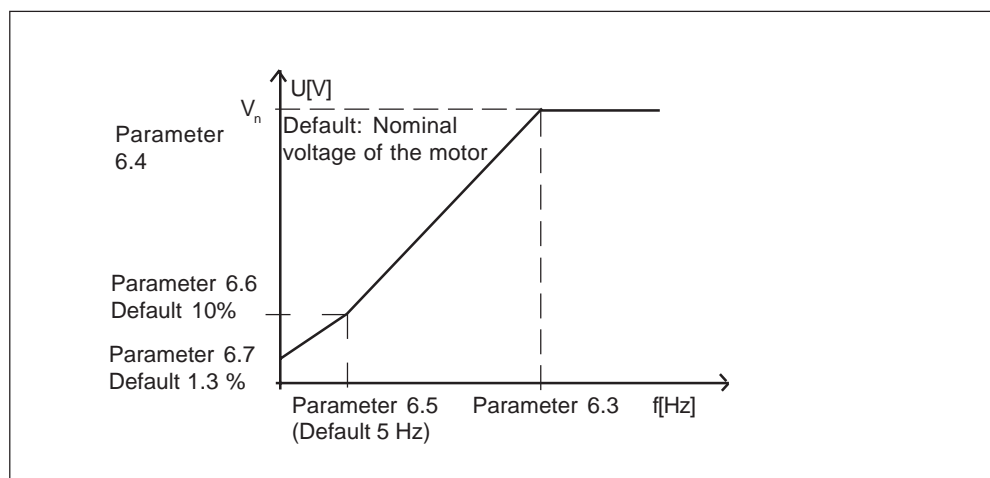

Figure 5.5-22 Programmable V/Hz curve.

6.8 Overvoltage controller
6.9 Undervoltage controller

These parameters allow the over/undervoltage controllers to be switched ON or OFF. This may be useful in cases where the utility supply voltage varies more than -15%—+10% and the application requires a constant speed. If the controllers are ON, they will change the motor speed in over/undervoltage cases. Overvoltage = faster, undervoltage = slower.

Over/undervoltage trips may occur when controllers are not used

7.1 Response to the reference fault

- 0 = No response
- 1 = Warning
- 2 = Fault, stop mode after fault according to parameter 4.7
- 3 = Fault, always coasting stop mode after fault

A warning or a fault action and message is generated if 4—20 mA reference signal is used and the signal falls below 4 mA. The information can also be programmed via digital output DO1 and via relay outputs RO1 and RO2.

7.2 Response to external fault

- 0 = No response
- 1 = Warning
- 2 = Fault, stop mode after fault according to parameter 4.7
- 3 = Fault, always coasting stop mode after fault

A warning or a fault action and message is generated from the external fault signal in the digital input DIA3. The information can also be programmed into digital output DO1 and into relay outputs RO1 and RO2.

7.3 Phase supervision of the motor

- 0 = No action
- 2 = Fault

Phase supervision of the motor ensures that the motor phases have approximately equal current.

7.4 Ground fault protection

- 0 = No action
- 2 = Fault

Ground fault protection ensures that the sum of the motor phase currents is zero. The standard overcurrent protection is always working and protects the frequency converter from ground faults with high current levels.

Parameters 7.5—7.9 Motor thermal protection

General

Motor thermal protection is to protect the motor from overheating. The SV9000 drive is capable of supplying higher than nominal current to the motor. If the load requires this high current there is a risk that motor will be thermally overloaded. This is true especially at low frequencies. With low frequencies the cooling effect of the motor fan is reduced and the capacity of the motor is reduced. If the motor is equipped with an external fan the load reduction on low speed is small.



Motor thermal protection is based on a calculated model and it uses the output current of the drive to determine the load on the motor. When the power is turned on to the drive, the calculated model uses the heatsink temperature to determine the initial thermal state for the motor. The calculated model assumes that the ambient temperature of the motor is 40°C.

Motor thermal protection can be adjusted by setting several parameters. The thermal current I_T specifies the load current above which the motor is overloaded. This current limit is a function of the output frequency. The curve for I_T is set with parameters 7. 6, 7. 7 and 7. 9, refer to the figure 5.5-23. The default values of these parameters are set from the motor nameplate data.

With the output current at I_T the thermal state will reach the nominal value (100%). The thermal state changes with the square of the current. With output current at 75% of I_T the thermal stage will reach 56% and with output current at 120% of I_T the thermal stage would reach 144%. The function will trip the device (refer par. 7. 5) if the thermal model reaches a value of 105%. The response time of the thermal model is determined by the time constant parameter 7. 8. The larger the motor the longer it takes to reach the final temperature.

The thermal state of the motor can be monitored through the display. Refer to the table for monitoring items. (User's Manual, table 7.3-1).



CAUTION! *The calculated model does not protect the motor if the cooling of the motor is reduced either by blocking the airflow or due to dust or dirt.*

7. 5 Motor thermal protection

Operation:

- 0 = Not in use
- 1 = Warning
- 2 = Trip function

Tripping and warning will give a display indication with the same message code. If tripping is selected the drive will stop and activate the fault stage.

Deactivating the protection by setting this parameter to 0, will reset the thermal stage of the motor to 0%.

7. 6 Motor thermal protection, break point current

The current can be set between 50.0—150.0% $\times I_{nMotor}$.

This parameter sets the value for thermal current at frequencies above the break point on the thermal current curve. See figure 5.5-23.

The value is set in percentage of the motor nameplate data of the motor, parameter 1. 13, not the drive's nominal output current.

The motor's nominal current is the current which the motor can withstand in direct on-line use without being overheated.

If parameter 1. 13 is adjusted, this parameter is automatically restored to the default value.

Setting this parameter (or parameter 1. 13) does not affect the maximum output current of the drive. Parameter 1. 7 alone determines the maximum output current of the drive.

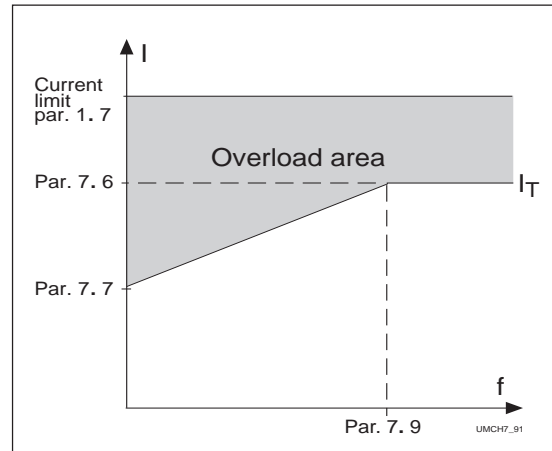

Figure 5.5-23 Motor thermal current I_T curve.

7.7 Motor thermal protection, zero frequency current

The current can be set between 10.0—150.0% $\times I_{nMotor}$. This parameter sets the value for thermal current at zero frequency. Refer to the figure 5.5-23.

The default value is set assuming that there is no external fan cooling the motor. If an external fan is used this parameter can be set to 90% (or higher).

The value is set as a percentage of the motor's nameplate nominal current, parameter 1. 13, not the drive's nominal output current. The motor's nominal current is the current which the motor can stand in direct on-line use without being overheated.

If you change the parameter 1. 13 this parameter is automatically restored to the default value.

Setting this parameter (or parameter 1. 13) does not affect the maximum output current of the drive. Parameter 1. 7 alone determines the maximum output current of the drive.

7.8 Motor thermal protection, time constant

This time can be set between 0.5—300 minutes.

This is the thermal time constant of the motor. The larger the motor the greater the time constant. The time constant is defined as the time that it takes the calculated thermal stage to reach 63% of its final value.

The motor thermal time is specific to a motor design and it varies between different motor manufacturers.

The default value for the time constant is calculated based on the motor name plate data from parameters 1. 12 and 1. 13. If either of these parameters is reset, then this parameter is set to its default value.

If the motor's t_6 -time is known (given by the motor manufacturer) the time constant parameter could be set based on t_6 -time. As a rule of thumb, the motor thermal time constant in minutes equals to $2 \times t_6$ (t_6 in seconds is the time a motor can safely operate at six times the rated current). If the drive is in the stop stage the time constant is internally increased to three times the set parameter value. The cooling in the stop stage is based on convection with an increased time constant.

7.9 Motor thermal protection, break point frequency

This frequency can be set between 10—500 Hz.

This is the frequency break point of thermal current curve. With frequencies above this point the thermal capacity of the motor is assumed to be constant. See figure 5.5-23.

The default value is based on motor's nameplate data, parameter 1. 11. It is 35 Hz for a 50 Hz motor and 42 Hz for a 60 Hz motor. More generally it is 70% of the frequency at the field weakening point (parameter 6. 3). Changing either parameter 1. 11 or 6. 3 will restore this parameter to its default value.

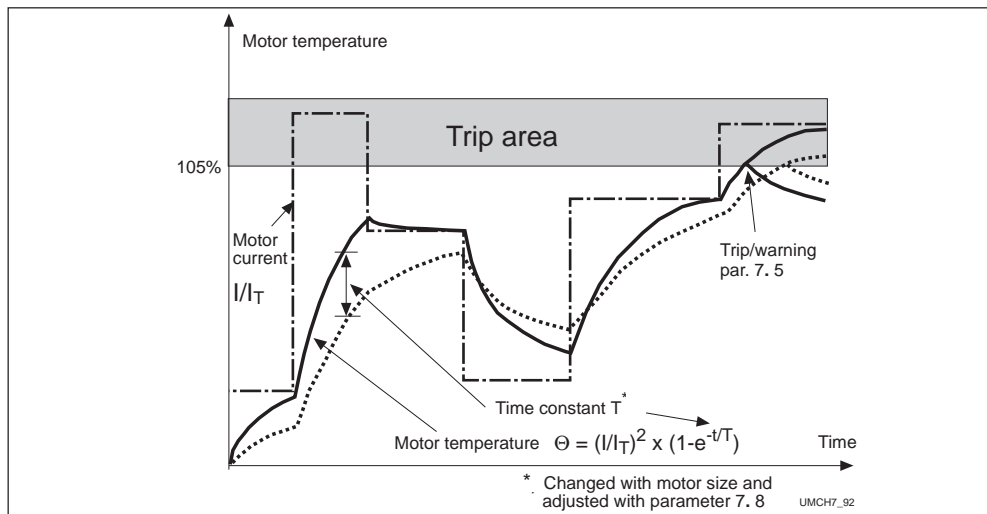

Figure 5.5-24 Calculating motor temperature.

Parameters 7. 10— 7. 13, Stall protection

General

Motor stall protection protects the motor from short time overload situations like a stalled shaft. The reaction time of stall protection can be set shorter than with motor thermal protection. The stall state is defined with two parameters, 7.11. Stall Current and 7.13. Stall Frequency. If the current is higher than the set limit and output frequency is lower than the set limit the stall state is true. There is no true detection of shaft rotation. Stall protection is a type of overcurrent protection.

5

7. 10 Stall protection

Operation:

- 0 = Not in use
- 1 = Warning
- 2 = Trip function

Tripping and warning will give a display indication with the same message code. If tripping is set on, the drive will stop and activate the fault stage.

Setting this parameter to 0 will deactivate the protection and will reset the stall time counter to zero.



7.11 Stall current limit

The current can be set between 0.0—200% $\times I_{nMotor}$.

In a stall the current has to be above this limit. See figure 5.5-25. The value is set as a percentage of the motor's nameplate nominal current, parameter 1.13, motor's nominal current. If parameter 1.13 is adjusted, this parameter is automatically restored to its default value.

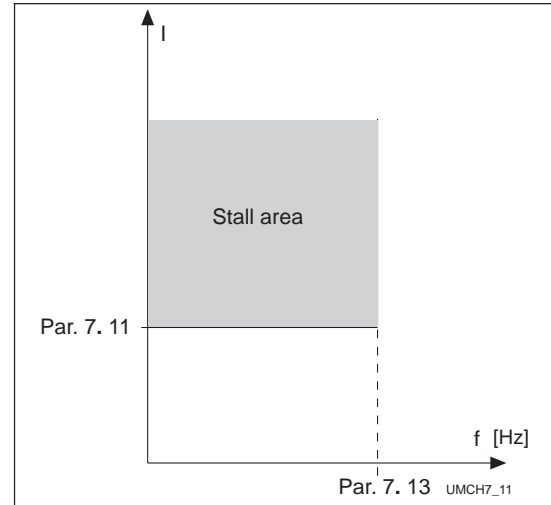

Figure 5.5-25 Setting the stall characteristics.

7.12 Stall time

The time can be set between 2.0—120 s.

This is the maximum allowed time for a stall. There is an internal up/down counter to count the stall time. See figure 5.5-26. If the stall time counter value goes above this limit the protection will cause a trip (refer to the parameter 7.10).

7.13 Maximum stall frequency

The frequency can be set between 1— f_{max} (par. 1.2).

In the stall state, the output frequency has to be smaller than this limit. See figure 5.5-25.

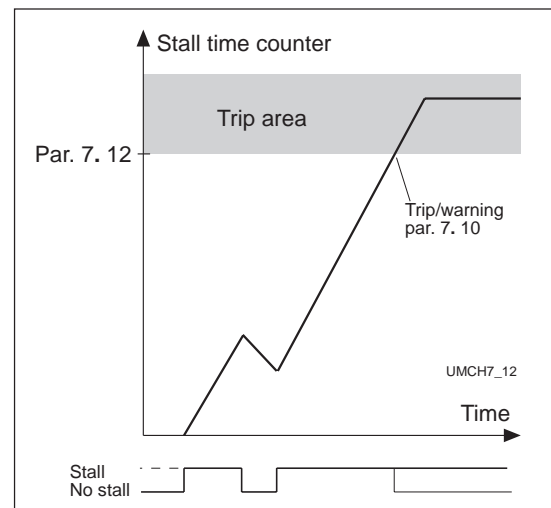

Figure 5.5-26 Counting the stall time.

Parameters 7.14—7.17, Underload protection

General

The purpose of motor underload protection is to ensure that there is load on the motor while the drive is running. If the motor load is reduced, there might be a problem in the process, e.g. broken belt or dry pump.

Motor underload protection can be adjusted by setting the underload curve with parameters 7.15 and 7.16. The underload curve is a squared curve set between zero frequency and the field weakening point. The protection is not active below 5Hz (the underload counter value is stopped). See figure 5.5-27.

The torque values for setting the underload curve are set with percentage values which refer to the nominal torque of the motor. The motor's nameplate data, parameter 1. 13, the motor's nominal current and the drive's nominal current I_{CT} are used to find the scaling ratio for the internal torque value. If other than a standard motor is used with the drive, the accuracy of the torque calculation is decreased.

7. 14 Underload protection

Operation:

- 0 = Not in use
- 1 = Warning
- 2 = Fault

Tripping and warning will give a display indication with the same message code. If tripping is set active the drive will stop and activate the fault stage.

Deactivating the protection, by setting this parameter to 0, will reset the underload time counter to zero.

7. 15 Underload protection, field weakening area load

The torque limit can be set between 20.0—150 % x T_{nMotor} .

This parameter is the value for the minimum allowed torque when the output frequency is above the field weakening point. See figure 4.5-22. If parameter 1. 13 is adjusted, this parameter is automatically restored to its default value

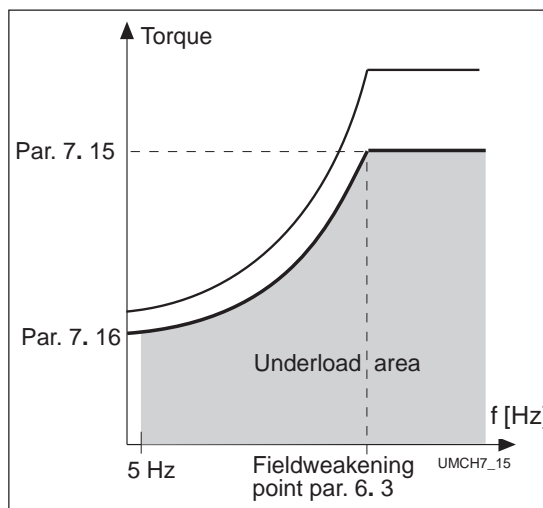

Figure 5.5-27 Setting of minimum load.

7. 16 Underload protection, zero frequency load

Torque limit can be set between 10.0—150 % x T_{nMotor} .

This parameter is the value for the minimum allowed torque with zero frequency. See figure 5.5-27. If parameter 1. 13 is adjusted, this parameter is automatically restored to its default value.

7. 17 Underload time

This time can be set between 2.0—600.0 s.

This is the maximum allowed time for an underload state. There is an internal up/down counter to accumulate the underload time. See figure 5.5-28. If the underload counter value goes above this limit, the protection will cause a trip (refer to the parameter 7. 14). If the drive is stopped the underload counter is reset to zero.

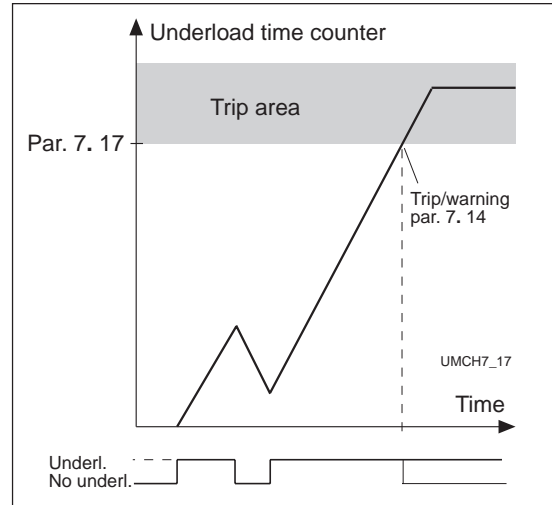

Figure 5.5-28 Counting the underload time.

- 8. 1 Automatic restart: number of tries
- 8. 2 Automatic restart: trial time

The Automatic restart function restarts the drive after the faults selected with parameters 8. 4—8. 8. The Start function for Automatic restart is selected with parameter 8. 3.

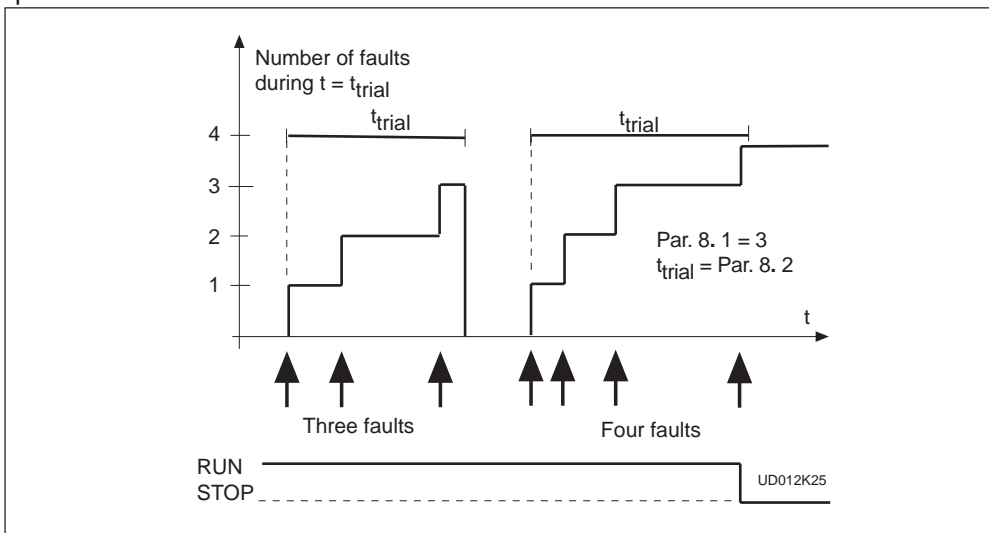

Figure 5.5-29 Automatic restart

Parameter 8. 1 determines how many automatic restarts can be made during the trial time set by the parameter 8. 2.

The time counting starts from the first autorestart. If the number of restarts does not exceed the value of the parameter 8. 1 during the trial time, the counting is cleared after the trial time has elapsed. The next fault starts the counting again.



8.3 Automatic restart, start function

The parameter defines the start mode:

- 0 = Start with ramp
- 1 = Flying start, see parameter 4. 6.

8.4 Automatic restart after undervoltage trip

- 0 = No automatic restart after undervoltage fault trip
- 1 = Automatic restart after undervoltage fault condition returns to the normal condition (DC-link voltage returns to the normal level)

8.5 Automatic restart after overvoltage trip

- 0 = No automatic restart after overvoltage fault trip
- 1 = Automatic restart after overvoltage fault condition returns to the normal condition (DC-link voltage returns to the normal level)

8.6 Automatic restart after overcurrent trip

- 0 = No automatic restart after overcurrent fault trip
- 1 = Automatic restart after overcurrent faults

8.7 Automatic restart after reference fault trip

- 0 = No automatic restart after reference fault trip
- 1 = Automatic restart after analog current reference signal (4—20 mA) returns to the normal level (≥ 4 mA)

8.8 Automatic restart after over-/undertemperature fault trip

- 0 = No automatic restart after temperature fault trip
- 1 = Automatic restart after heatsink temperature has returned to its normal level between -10°C — $+75^{\circ}\text{C}$.

This page intentionally left blank



PUMP AND FAN CONTROL APPLICATION

(par. 0.1 = 7)

CONTENTS

6	Pump and fan control Application	6-1
6.1	General	6-2
6.2	Control I/O	6-2
6.3	Control signal logic	6-3
6.4	Basic parameters, Group 1	6-4
	6.4.1 Parameter table, Group 1	6-4
	6.4.2 Description of Group1 parameters	6-5
6.5	Special parameters, Groups 2—9	6-8
	6.5.1 Parameter tables, Groups 2—9	6-8
	6.5.2 Description of Groups 2—9 param.	6-16
6.6	Monitoring data	6-40
6.7	Panel reference	6-41



6.1 General

The pump and fan control application can be selected by setting the value of parameter 0.1 to 7.

The application can be used to control one variable speed drive and 0-3 auxiliary drives. The PI-controller of the SV9000 controls the drive speed and provides control signals to Start and Stop one to three auxiliary drives to

control the total flow.

The application has two control sources on the I/O terminals. Source A is Pump and fan control and source B is direct frequency reference. The control source is selected with DIB6 input.

*** NOTE!** Remember to connect the CMA and CMB inputs.

6.2 Control I/O

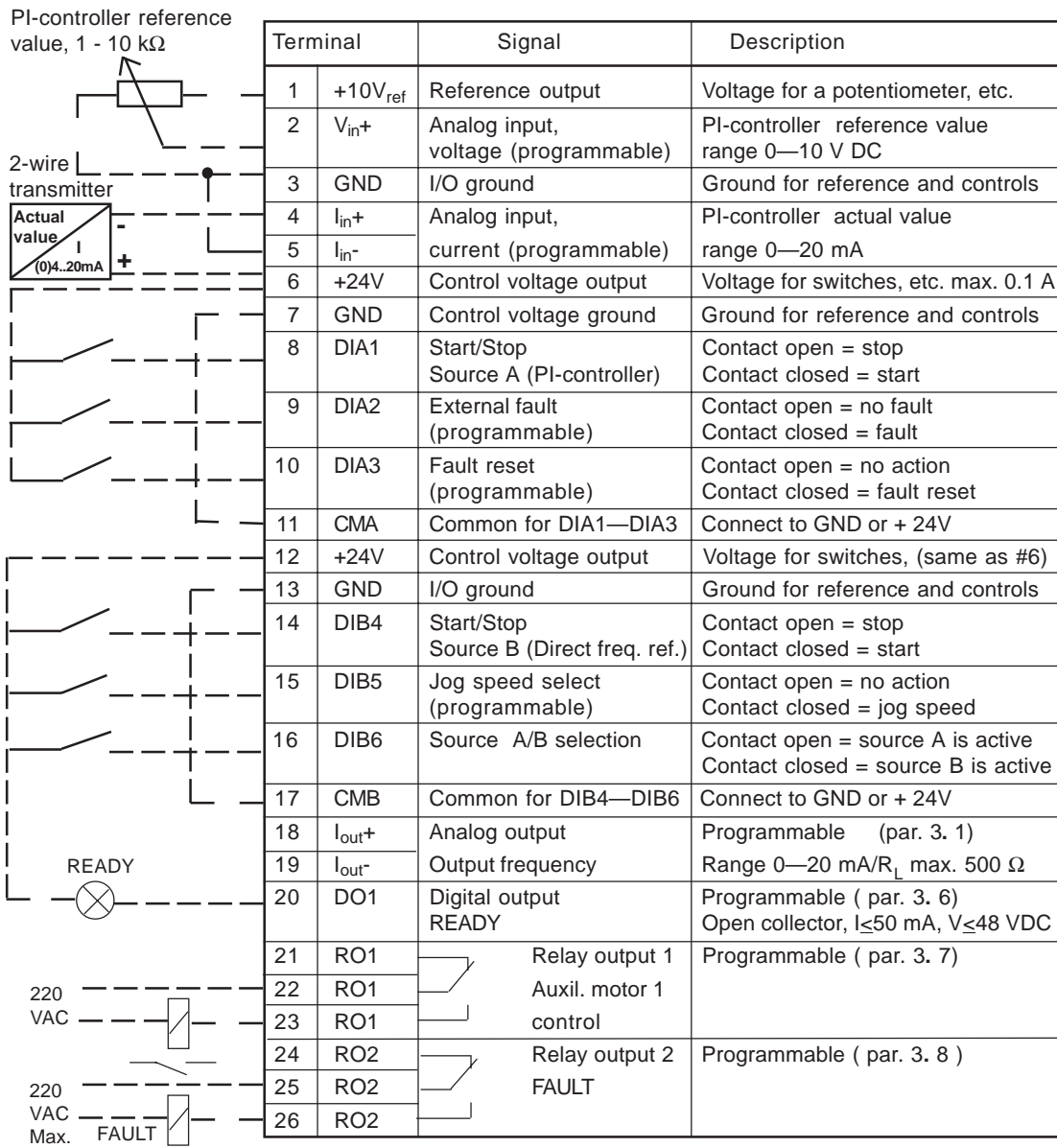

Figure 6.2-1 Default I/O configuration and connection example of the Pump and Fan Control Application with 2-wire transmitter.



6.3 Control signal logic

The logic flow of the I/O-control signals and pushbutton signals from the panel is shown in figure 6.3-1.

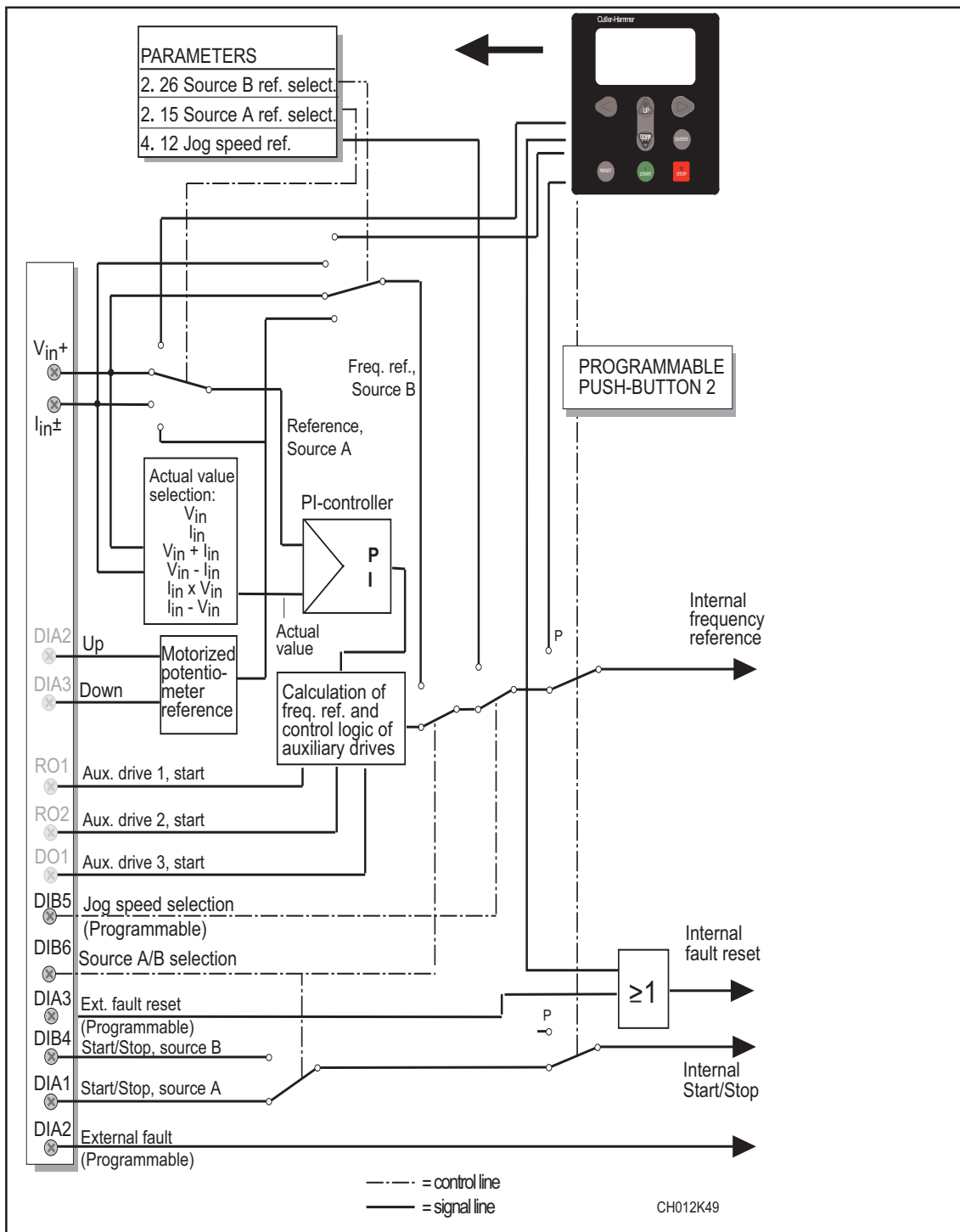

Figure 6.3-1 Control signal logic of the Pump and Fan control Application. Switch positions shown are based on the factory settings.



6.4 Basic parameters, Group 1

6.4.1 Parameter table, Group 1

Code	Parameter	Range	Step	Default	Custom	Description	Page
1.1	Minimum frequency	0— f_{max}	1 Hz	0 Hz			6-5
1.2	Maximum frequency	f_{min} -120/500 Hz	1 Hz	60 Hz		*	6-5
1.3	Acceleration time 1	0.1—3000.0 s	0.1 s	1.0 s		Time from f_{min} (1.1) to f_{max} (1.2)	6-5
1.4	Deceleration time 1	0.1—3000.0 s	0.1 s	1.0 s		Time from f_{max} (1.2) to f_{min} (1.1)	6-5
1.5	PI-controller gain	1—1000%	1 %	100%			6-5
1.6	PI-controller I-time	0.00—320.00 s	0.01s	10.00s		0= No Integral time in use	6-5
1.7	Current limit	0.1—2.5 x I_{nSV9}	0.1 A	1.5 x I_{nSV9}		Output current limit [A] of the unit	6-5
1.8	V/Hz ratio selection	0—2	1	0		0 = Linear 1 = Squared 2 = Programmable V/Hz ratio	6-5
1.9	V/hz optimization	0—1	1	0		0 = None 1 = Automatic torque boost	6-6
1.10	Nominal voltage of the motor	180—690 V	1 V	230 V 380 V 480 V 575 V		Voltage code 2 Voltage code 4 Voltage code 5 Voltage code 6	6-7
1.11	Nominal frequency of the motor	30—500 Hz	1 Hz	60 Hz		f_n from the rating plate of the motor	6-7
1.12	Nominal speed of the motor	1—20000 rpm	1 rpm	1720 rpm **		n_n from the rating plate of the motor	6-7
1.13	Nominal current of the motor (I_{nMot})	2.5 x I_{nSV9}	0.1 A	I_{nSV9}		I_n from the rating plate of the motor	6-7
1.14	Supply voltage	208—240 380—440 380—500 525—690		230 V 380 V 480 V 575 V		Voltage code 2 Voltage code 4 Voltage code 5 Voltage code 6	6-7
1.15	Parameter conceal	0—1	1	0		Visibility of the parameters: 0 = All parameter groups visible 1 = Only group 1 is visible	6-7
1.16	Parameter value lock	0—1	1	0		Disables parameter changes: 0 = Changes enabled 1 = Changes disabled	6-7

Table 6.4-1 Group 1 basic parameters.

Note!  = Parameter value can be changed only when the drive is stopped.

* If 1.2 > motor synchr. speed, check suitability for motor and drive system
Selecting 120 Hz/500 Hz range see page 6-5.

** Default value for a four pole motor and a nominal size SV9000.



6.4.2 Description of Group 1 parameters

1. 1, 1. 2 Minimum / maximum frequency

Defines frequency limits of the SV9000.

The default maximum value for parameters 1. 1 and 1. 2 is 120 Hz. By setting 1. 2 = 120 Hz when the drive is stopped (RUN indicator not lit) parameters 1. 1 and 1. 2 are changed to 500 Hz. At the same time the resolution of the panel reference is changed from 0.01 Hz to 0.1 Hz.

Changing the max. value from 500 Hz to 120 Hz is done by setting parameter 1. 2 = 119 Hz when the drive is stopped.

1. 3, 1. 4 Acceleration time 1, deceleration time 1:

These limits correspond to the time required for the output frequency to accelerate from the set minimum frequency (par. 1. 1) to the set maximum frequency (par. 1. 2).

1. 5 PI-controller gain

This parameter defines the gain of the PI-controller.

If this parameter is set to 100%, a 10% change in error value causes the controller output to change by 1.0 Hz.

If the parameter value is set to 0 the PI-controller operates as I-controller.

1. 6 PI-controller I-time

Defines the integration time of the PI-controller.

1. 7 Current limit

This parameter determines the maximum motor current what the SV9000 will supply short term.

1. 8 V/Hz ratio selection

Linear: The voltage of the motor changes linearly with the frequency in the constant flux area from 0 Hz to the field weakening point (par. 6. 3) where a constant voltage (nominal value) is supplied to the motor. See figure 6.4-1.

Linear V/Hz ratio should be used in constant torque applications.

This default setting should be used if there is no special requirement for another setting.

Squared: The voltage of the motor changes following a squared curve form with the frequency in the area from 0 Hz to the field weakening point (par. 6. 3) where the nominal voltage is also supplied to the motor. See figure 6.4-1.

The motor runs undermagnetized below the field weakening point and produces less torque and electromechanical noise. A squared V/Hz ratio can be used in applications where the torque demand of the load is proportional to the square of the speed, e.g. in centrifugal fans and pumps.



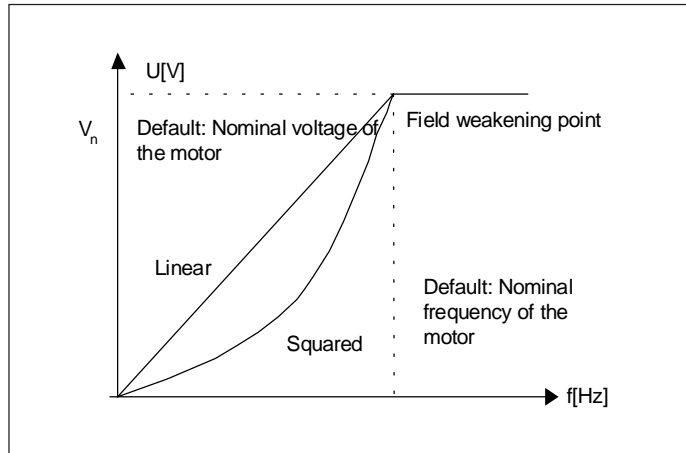

Figure 6.4-1 Linear and squared V/Hz curves.

Programm. The V/Hz curve can be programmed with three different points.
 V/Hz curve The parameters for programming are explained in chapter 6.5.2.
 2 A programmable V/Hz curve can be used if the standard settings do not satisfy the needs of the application. See figure 6.4-2.

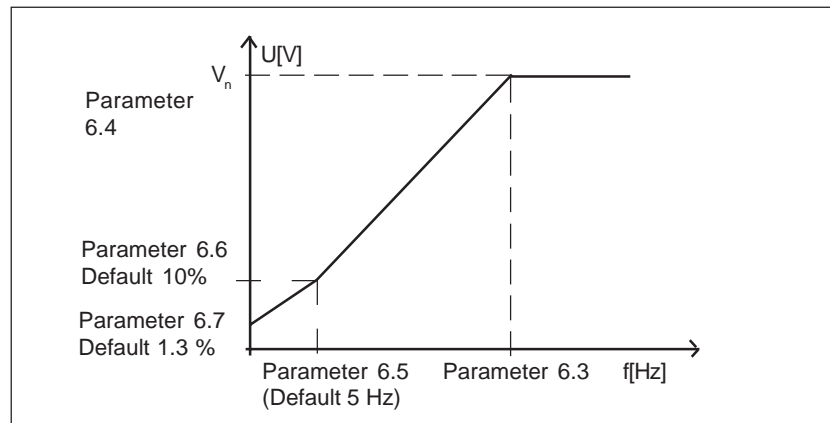

Figure 6.4-2 Programmable V/Hz curve.

1.9 V/Hz optimization

Automatic torque boost The voltage to the motor changes automatically which makes the motor to produce torque enough to start and run at low frequencies. The voltage increase depends on the motor type and horsepower.

Automatic torque boost can be used in applications where starting torque due to starting friction is high, e.g. in conveyors.

NOTE! *In high torque - low speed applications - it is likely the motor will overheat. If the motor has to run for a prolonged time under these conditions, special attention must be paid to cooling the motor. Use external cooling for the motor if the temperature tends to rise too high.*



1. 10 Nominal voltage of the motor

Find this value V_n from the nameplate of the motor.

This parameter sets the voltage at the field weakening point, parameter 6. 4, to $100\% \times V_{n_{motor}}$.

1. 11 Nominal frequency of the motor

Find the nominal frequency f_n from the nameplate of the motor.

This parameter sets the frequency at the field weakening point, parameter 6. 3, to the same value.

1. 12 Nominal speed of the motor

Find this value n_n from the nameplate of the motor.

1. 13 Nominal current of the motor

Find the value I_n from the nameplate of the motor. The internal motor protection function uses this value as a reference value.

1. 14 Supply voltage

Set parameter value according to the nominal voltage of the supply.

Values are pre-defined for voltage codes 2, 4, 5 and 6. See table 6.4-1.

1. 15 Parameter conceal

Defines which parameter groups are available:

0 = All parameter groups are visible

1 = Only group 1 is visible

1. 16 Parameter value lock

Defines access to the changes of the parameter values:

0 = Parameter value changes enabled



1 = Parameter value changes disabled



6.5 Special parameters, Groups 2—9





6.5.1 Parameter tables

Group 2, Input signal parameters

Code	Parameter	Range	Step	Default	Custom	Description	Page
2.1	DIA2 function (terminal 9) 	0—10	1	1		0 = Not used 1 = Ext. fault, closing contact 2 = External fault, opening contact 3 = Run enable 4 = Acceler./deceler. time selection 5 = Reverse 6 = Jog frequency 7 = Fault reset 8 = Acc./dec. operation prohibit 9 = DC-braking command 10 = Motor (digital) potent. UP	6-16
2.2	DIA3 function (terminal 10) 	0—10	1	7		0 = Not used 1 = Ext. fault, closing contact 2 = External fault, opening contact 3 = Run enable 4 = Acceler./deceler. time selection 5 = Reverse 6 = Jog frequency 7 = Fault reset 8 = Acc./dec. operation prohibit 9 = DC-braking command 10 = Motor (digital) potent. DOWN	6-17
2.3	V _{in} signal range	0—1	1	0		0 = 0—10 V 1 = Custom setting range	6-17
2.4	V _{in} custom setting min.	0.00-100.00%	0.01%	0.00%			6-17
2.5	V _{in} custom setting max.	0.00-100.00%	0.01%	100.00%			6-17
2.6	V _{in} signal inversion	0—1	1	0		0 = Not inverted 1 = Inverted	6-17
2.7	V _{in} signal filter time	0.00—10.00 s	0.01s	1.00s		0 = No filtering	6-17
2.8	I _{in} signal range	0—2	1	0		0 = 0—20 mA 1 = 4—20 mA 2 = Custom setting range	6-17
2.9	I _{in} custom setting minim.	0.00-100.00%	0.01%	0.00%			6-18
2.10	I _{in} custom setting maxim.	0.00-100.00%	0.01%	100.00%			6-18
2.11	I _{in} signal inversion	0—1	1	0		0 = Not inverted 1 = Inverted	6-18
2.12	I _{in} signal filter time	0.01—10.00s	0.01s	1.00 s		0 = No filtering	6-18
2.13	DIB5 function (terminal 15) 	0—9	1	6		0 = Not used 1 = Ext. fault, closing contact 2 = External fault, opening contact 3 = Run enable 4 = Acc./dec. time selection 5 = Reverse 6 = Jog speed 7 = Fault reset 8 = Acc./dec. operation prohibit 9 = DC-braking command	6-18

Note!  = Parameter value can be changed only when the drive is stopped



Code	Parameter	Range	Step	Default	Custom	Description	Page
2.14	Motor(digital) potentiometer ramp time	0.1—2000.0 Hz/s	0.1 Hz/s	10.0 Hz/s			6-19
2.15	PI-controller reference signal (source A) 	0—4	1	0		0 = Analog voltage input (term. 2) 1 = Analog current input (term. 4) 2 = Set reference from the panel (reference r2) 3 = Signal from internal motor pot. 4 = Signal from internal motor pot. reset if SV9000 unit is stopped	619
2.16	PI-controller actual value selection 	0—3	1	0		0 = Actual value1 1 = Actual 1 + Actual 2 2 = Actual 1 - Actual 2 3 = Actual 1 * Actual 2	6-19
2.17	Actual value 1 input 	0—2	1	2		0 = No 1 = Voltage input 2 = Current input	6-19
2.18	Actual value 2 input 	0—2	1	0		0 = No 1 = Voltage input 2 = Current input	6-19
2.19	Actual value 1 min scale	-320.00%—+320.00%	0.01%	0.00%		0% = no minimum scaling	6-19
2.20	Actual value 1 max scale	-320.00%—+320.00%	0.01%	100.00%		100% = no maximum scaling	6-19
2.21	Actual value 2 min scale	-320.00%—+320.00%	0.01%	0.00%		0% = no minimum scaling	6-19
2.22	Actual value 2 max scale	-320.00%—+320.00%	0.01%	100.00%		100% = no maximum scaling	6-19
2.23	Error value inversion	0—1	1	0		0 = No 1 = Yes	6-20
2.24	PI-controller reference value rise time	0.0—100.0 s	0.1 s	60.0 s		Time for reference value change from 0 % to 100 %	6-20
2.25	PI-controller reference value fall time	0.0—100.0 s	0.1 s	60.0 s		Time for reference value change from 100 % to 0 %	6-20
2.26	Direct frequency reference, source B 	0—4	1	0		0 = Analog voltage input (term. 2) 1 = Analog current input (term. 4) 2 = Set reference from the panel (reference r1) 3 = Signal from internal motor pot. 4 = Signal from internal motor pot. reset if SV9000 unit is stopped	6-20
2.27	Source B reference scaling minimum value	0—par.2.28	1 Hz	0 Hz		Selects the frequency that corresponds to the min. reference signal	6-20
2.28	Source B reference scaling maximum value	0— f_{max}	1 Hz	0 Hz		Selects the frequency that corresponds to the max. reference signal 0 = Scaling off >0 = Scaled maximum value	6-20

Note!  = Parameter value can be changed only when the drive is stopped



Group 3, Output and supervision parameters

Code	Parameter	Range	Step	Default	Custom	Description	Page
3.1	Analog output function	0—15	1	1		0 = Not used Scale 100% 1 = O/P frequency (0— f_{max}) 2 = Motor speed (0—max. speed) 3 = O/P current (0— $2.0 \times I_{nSV9}$) 4 = Motor torque (0— $2 \times T_{nMot}$) 5 = Motor power (0— $2 \times P_{nMot}$) 6 = Motor voltage (0— $100\% \times V_{nMot}$) 7 = DC-link volt. (0—1000 V) 8—10 = Not in use 11 = PI-controller reference value 12 = PI-controller actual value 1 13 = PI-controller actual value 2 14 = PI-controller error value 15 = PI-controller output	6-21
3.2	Analog output filter time	0.00—10.00 s	0.01s	1.00s			6-21
3.3	Analog output inversion	0—1	1	0		0 = Not inverted 1 = Inverted	6-21
3.4	Analog output minimum	0—1	1	0		0 = 0 mA 1 = 4 mA	6-21
3.5	Analog output scale	10—1000%	1%	100%			6-21
3.6	Digital output function	0—30	1	1		0 = Not used 1 = Ready 2 = Run 3 = Fault 4 = Fault inverted 5 = SV9000 overheat warning 6 = External fault or warning 7 = Reference fault or warning 8 = Warning 9 = Reversed 10 = Jog speed selected 11 = At speed 12 = Motor regulator activated 13 = Output freq. limit superv. 1 14 = Output freq. limit superv. 2 15 = Torque limit supervision 16 = Reference limit supervision 17 = External brake control 18 = Control from I/O terminals 19 = Drive temperature limit supervision 20 = Unrequested rotation direction 21 = External brake control inverted 22—27 = Not in use 28 = Auxiliary drive 1 start 29 = Auxiliary drive 2 start 30 = Auxiliary drive 3 start	6-22
3.7	Relay output 1 function	0—30	1	28		As parameter 3.6	6-22
3.8	Relay output 2 function	0—30	1	3		As parameter 3.6	6-22
3.9	Output freq. limit 1 supervision function	0—2	1	0		0 = No 1 = Low limit 2 = High limit	6-22
3.10	Output freq. limit 1 supervision value	0.0— f_{max} (par. 1. 2)	0.1 Hz	0.0 Hz			6-22

Note!  = Parameter value can be changed only when the drive is stopped.



Code	Parameter	Range	Step	Default	Custom	Description	Page
3.11	Output freq. limit 2 supervision function	0—2	1	0		0 = No 1 = Low limit 2 = High limit	6-22
3.12	Output freq. limit 2 supervision value	0.0— f_{max} (par. 1. 2)	0.1 Hz	0.0 Hz			6-22
3.13	Torque limit supervision function	0—2	1	0		0 = No 1 = Low limit 2 = High limit	6-23
3.14	Torque limit supervision value	0.0—200.0% $\times T_{nSV9}$	0.1%	100.0%			6-23
3.15	Active reference limit supervision function	0—2	1	0		0 = No 1 = Low limit 2 = High limit	6-23
3.16	Active reference limit supervision value	0.0— f_{max} (par. 1. 2)	0.1 Hz	0.0 Hz			6-23
3.17	External brake off-delay	0.0—100.0 s	1	0.5 s			6-23
3.18	External brake on-delay	0.0—100.0 s	1	1.5 s			6-23
3.19	Drive temperature limit supervision function	0—2	1	0		0 = No 1 = Low limit 2 = High limit	6-23
3.20	Drive temperature limit	-10—+75°C	1	+40°C			6-23
3.21	I/O-expander board (opt.) analog output content	0—7	1	3		See parameter 3. 1	6-21
3.22	I/O-expander board (opt.) analog output filter time	0.00—10.00 s	0.01	1.00 s		See parameter 3. 2	6-21
3.23	I/O-expander board (opt.) analog output inversion	0—1	1	0		See parameter 3. 3	6-21
3.24	I/O-expander board (opt.) analog output minimum	0—1	1	0		See parameter 3. 4	6-21
3.25	I/O-expander board (opt.) analog output scale	10—1000%	1	100%		See parameter 3. 5	6-21

Group 4, Drive control parameters

Code	Parameter	Range	Step	Default	Custom	Description	Page
4.1	Acc./dec. ramp 1 shape	0.0—10.0 s	0.1 s	0.0 s		0 = Linear >0 = S-curve acc./dec. time	6-24
4.2	Acc./dec. ramp 2 shape	0.0—10.0 s	0.1 s	0.0 s		0 = Linear >0 = S-curve acc./dec. time	6-24
4.3	Acceleration time 2	0.1—3000.0 s	0.1 s	10.0 s			6-25
4.4	Deceleration time 2	0.1—3000.0 s	0.1 s	10.0 s			6-25
4.5	Brake chopper 	0—2	1	0		0 = Brake chopper not in use 1 = Brake chopper in use 2 = External brake chopper	6-25
4.6	Start function	0—1	1	0		0 = Ramp 1 = Flying start	6-25
4.7	Stop function	0—1	1	0		0 = Coasting 1 = Ramp	6-25

Note!  = Parameter value can be changed only when the drive is stopped.









Code	Parameter	Range	Step	Default	Custom	Description	Page
4.8	DC-braking current	0.15—1.5 x I_{nsv9} (A)	0.1 A	0.5 x I_{nsv9}			6-25
4.9	DC-braking time at Stop	0.00-250.00 s	0.01 s	0.00 s		0 = DC-brake is off at Stop	6-25
4.10	Turn on frequency of DC brake during ramp Stop	0.1-10.0 Hz	0.1 Hz	1.5 Hz			6-27
4.11	DC-brake time at Start	0.00-25.00 s	0.01 s	0.00 s		0 = DC-brake is off at Start	6-27
4.12	Jog speed reference	f_{min} — f_{max} (1. 1) (1. 2)	0.1 Hz	10.0 Hz			6-27

Group 5, Prohibit frequency parameters

Code	Parameter	Range	Step	Default	Custom	Description	Page
5.1	Prohibit frequency range 1 low limit	f_{min} — par. 5. 2	0.1 Hz	0.0 Hz			6-27
5.2	Prohibit frequency range 2 high limit	f_{min} — f_{max} (1. 1) (1. 2)	0.1 Hz	0.0 Hz		0 = No prohibit frequency range	6-27
5.3	Prohibit frequency range 2 low limit	f_{min} — par. 5. 4	0.1 Hz	0.0 Hz			6-27
5.4	Prohibit frequency range 2 high limit	f_{min} — f_{max} (1. 1) (1. 2)	0.1 Hz	0.0 Hz		0 = No prohibit frequency range	6-27
5.5	Prohibit frequency range 3 low limit	f_{min} — par. 5. 6	0.1 Hz	0.0 Hz			6-27
5.6	Prohibit frequency range 3 high limit	f_{min} — f_{max} (1. 1) (1. 2)	0.1 Hz	0.0 Hz		0 = No prohibit frequency range	6-27

Group 6, Motor control parameters

Code	Parameter	Range	Step	Default	Custom	Description	Page
6.1	Motor control mode 	0—1	1	0		0 = Frequency control 1 = Speed control	6-27
6.2	Switching frequency	1.0—16.0 kHz	0.1 kHz	10/3.6kHz		Depends on Hp rating	6-28
6.3	Field weakening point 	30—500 Hz	1 Hz	Param. 1. 11			6-28
6.4	Voltage at field weakening point 	15—200% x V_{nmot}	1%	100%			6-28
6.5	V/Hz curve mid point frequency 	0.0— f_{max}	0.1 Hz	0.0 Hz			6-28
6.6	V/Hz curve mid point voltage 	0.00—100.00% x V_{nmot}	0.01%	0.00%			6-28
6.7	Output voltage at zero frequency 	0.00—100.00% x V_{nmot}	0.01%	0.00%			6-28
6.8	Overvoltage controller	0—1	1	1		0 = Controller is not operating 1 = Controller is in operation	6-29
6.9	Undervoltage controller	0—1	1	1		0 = Controller is not operating 1 = Controller is in operation	6-29

6

Note!  = Parameter value can be changed only when the drive is stopped.



Group 7, Protections

Code	Parameter	Range	Step	Default	Custom	Description	Page
7.1	Response to reference fault	0—3	1	0		0 = No action 1 = Warning 2 = Fault, stop according to par 4.7 3 = Fault, always coasting stop	6-29
7.2	Response to external fault	0—3	1	2		0 = No action 1 = Warning 2 = Fault, stop according to par 4.7 3 = Fault, always coasting stop	6-29
7.3	Phase supervision of the motor	0—2	2	2		0 = No action 2 = Fault	6-29
7.4	Ground protection	0—2	2	2		0 = No action 2 = Fault	6-29
7.5	Motor thermal protection	0—2	1	2		0 = No action 1 = Warning 2 = Fault	6-30
7.6	Motor thermal protection break point current	50.0—150.0 % $\times I_{nMOTOR}$	1.0 %	100.0%			6-30
7.7	Motor thermal protection zero frequency current	5.0—150.0% $\times I_{nMOTOR}$	1.0 %	45.0%			6-31
7.8	Motor thermal protection time constant	0.5—300.0 minutes	0.5 min.	17.0 min.		Default value is set according to motor nominal current	6-31
7.9	Motor thermal protection break point frequency	10—500 Hz	1 Hz	35 Hz			6-32
7.10	Stall protection	0—2	1	1		0 = No action 1 = Warning 2 = Fault	6-32
7.11	Stall current limit	5.0—200.0% $\times I_{nMOTOR}$	1.0%	130.0%			6-33
7.12	Stall time	2.0—120.0 s	1.0 s	15.0 s			6-33
7.13	Maximum stall frequency	1— f_{max}	1 Hz	25 Hz			6-33
7.14	Underload protection	0—2	1	0		0 = No action 1 = Warning 2 = Fault	6-34
7.15	Underload prot., field weakening area load	10.0—150.0 % $\times T_{nMOTOR}$	1.0%	50.0%			6-34
7.16	Underload protection, zero frequency load	5.0—150.0% $\times T_{nMOTOR}$	1.0%	10.0%			6-34
7.17	Underload time	2.0—600.0 s	1.0 s	20.0 s			6-34



Group 8, Autorestart parameters

Code	Parameter	Range	Step	Default	Custom	Description	Page
8.1	Automatic restart: number of tries	0—10	1	0		0 = Not in use	6-35
8.2	Automatic restart:multi attempt maximum trial time	1—6000 s	1 s	30 s			6-35
8.3	Automatic restart: start function	0—1	1	0		0 = Ramp 1 = Flying start	6-36
8.4	Automatic restart after undervoltage trip	0—1	1	0		0 = No 1 = Yes	6-36
8.5	Automatic restart after overvoltage trip	0—1	1	0		0 = No 1 = Yes	6-36
8.6	Automatic restart after overcurrent trip	0—1	1	0		0 = No 1 = Yes	6-36
8.7	Automatic restart after reference fault trip	0—1	1	0		0 = No 1 = Yes	6-36
8.8	Automatic restart after over/undertemperature fault trip	0—1	1	0		0 = No 1 = Yes	6-36



Group 9, Pump and fan control special parameters

Code	Parameter	Range	Step	Default	Custom	Description	Page
9.1	Number of aux. drives	0—3	1	1			6-37
9.2	Start frequency of auxiliary drive 1	f_{min} — f_{max}	0.1 Hz	51.0 Hz			6-37
9.3	Stop frequency of auxiliary drive 1	f_{min} — f_{max}	0.1 Hz	25.0 Hz			6-37
9.4	Start frequency of auxiliary drive 2	f_{min} — f_{max}	0.1 Hz	51.0 Hz			6-37
9.5	Stop frequency of auxiliary drive 2	f_{min} — f_{max}	0.1 Hz	25.0 Hz			6-37
9.6	Start frequency of auxiliary drive 3	f_{min} — f_{max}	0.1 Hz	51.0 Hz			6-37
9.7	Stop frequency of auxiliary drive 3	f_{min} — f_{max}	0.1 Hz	25.0 Hz			6-37
9.8							
9.9							
9.10	Start delay of the auxiliary drives	0.0—300.0 s	0.1 s	4.0 s			6-37
9.11	Stop delay of the auxiliary drives	0.0—300.0 s	0.1 s	2.0 s			6-37
9.12	Reference step after start of the 1 aux. drive	0.0—100.0 %	0.1 %	0.0 %		In % of actual value	6-38
9.13	Reference step after start of the 2 aux. drive	0.0—100.0 %	0.1 %	0.0 %		In % of actual value	6-38
9.14	Reference step after start of the 3 aux. drive	0.0—100.0 %	0.1 %	0.0 %		In % of actual value	6-38
9.15	(Reserved)						
9.16	Sleep level	0.0—120/500 Hz	0.1 Hz	0.0 Hz		Frequency below which the freq. of the speed controlled motor has go before starting the sleep delay counting (0.0 = not in use)	6-38
9.17	Sleep delay	0.0—3000.0 s	0.1 s	30.0 s		Time that freq. has to be below par. 9.16 before stopping the SV9000	6-38
9.18	Wake up level	0.0—100.0 %	0.1 %	0.0 %		Level of the actual value for restarting the SV9000	6-38
9.19	Wake up function	0—1	1	0		0 =Wake up when falling below the wake up level 1 = Wake up when exceeding the wake up level	6-38
9.20	PI-regulator bypass	0—1	1	0		1 = PI-regulator bypassed	6-39

Table 6.5-1 Special parameters, Groups 2—9.



6.5.2 Description of Groups 2—9 parameters

2.1 DIA2 function

1: External fault,	closing contact	= Fault is shown and drive responds according to parameter 7.2.
2: External fault,	opening contact	= Fault is shown and drive responds according to parameter 7.2.
3: Run enable	contact open	= Start of the motor disabled
	contact closed	= Start of the motor enabled
4: Acc. / Dec time select.	contact open	= Acceleration/Deceleration time 1 selected
	contact closed	= Acceleration/Deceleration time 2 selected
5: Reverse	contact open	= Forward
	contact closed	= Reverse
		If two or more inputs are programmed to reverse only one of them is required for reverse
6: Jog freq.	contact closed	= Jog frequency selected for freq. refer.
7: Fault reset	contact closed	= Resets all faults
8: Acc./Dec. operation prohibited	contact closed	= Stops acceleration and deceleration until the contact is opened
9: DC-braking command	contact closed	= In the stop mode, the DC-braking operates until the contact is opened, see figure 6.5-1. DC-brake current is set with parameter 4. 8.
10: Motor (digital) pot. UP	contact closed	= Reference increases until the contact is opened

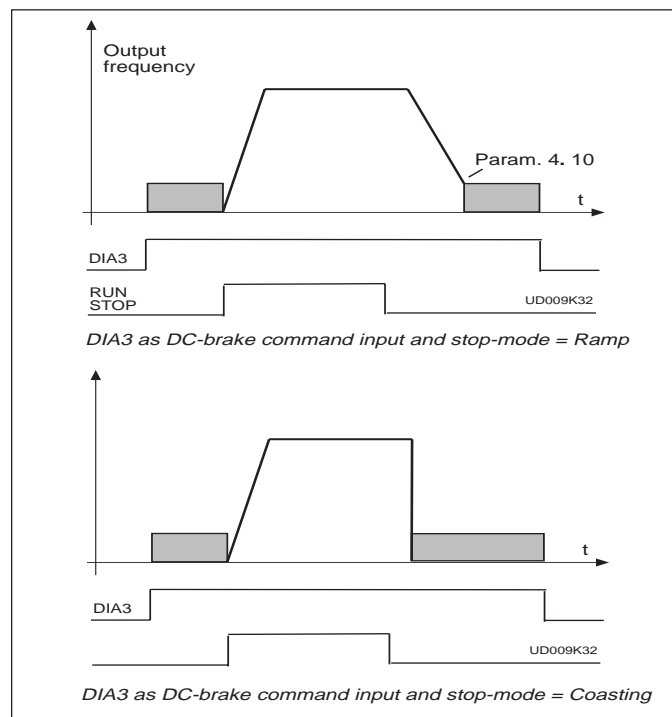

Figure 6.5-1 DIA3 as DC-brake command input:
a) Stop-mode = ramp,
b) Stop-mode = coasting

2. 2 DIA3 function

Selections are same as in 2. 1 except :

10: Motor (digital) contact closed = Reference decreases until the contact is
pot. DOWN opened

2. 3 V_{in} signal range

0 = Signal range 0—10 V

1 = Custom setting range from custom minimum (par. 2. 4) to custom maximum (par. 2. 5)

2. 4-2. 5 V_{in} custom setting minimum/maximum

These parameters set V_{in} for any input signal span within 0—10 V.

Minimum setting: Set the V_{in} signal to its minimum level, select parameter 2. 4, press the Enter button

Maximum setting: Set the V_{in} signal to its maximum level, select parameter 2. 5, press the Enter button

Note! The parameter values can only be set with this procedure (not with arrow up/arrow down buttons)

2. 6 V_{in} signal inversion

0 = no inversion of analog V_{in} signal

1 = inversion of analog V_{in} signal.

2. 7 V_{in} signal filter time

Filters out disturbances from the incoming analog V_{in} signal. A long filtering time makes the drive response slower. See figure 6.5-2.

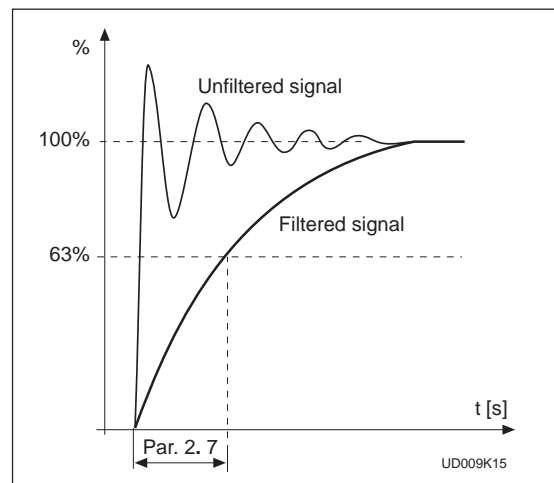

Figure 6.5-2 V_{in} signal filtering

2. 8 Analog input I_{in} signal range

- 0 = 0—20 mA
- 1 = 4—20 mA
- 2 = Custom signal span

2. 9 Analog input I_{in} custom setting**2. 10 minimum/maximum**

With these parameters you can scale the input current signal (I_{in}) signal range between 0—20 mA.

Minimum setting: Set the I_{in} signal to its minimum level, select parameter 2. 9, press the Enter button

Maximum setting: Set the I_{in} signal to its maximum level, select parameter 2. 10, press the Enter button

Note! The parameter values can only be set with this procedure (not with the arrow up/arrow down buttons)

2. 11 Analog input I_{in} inversion

- 0 = no inversion of I_{in} input.
- 1 = inversion of I_{in} input.

2. 12 Analog input I_{in} filter time

Filters out disturbances from the incoming analog I_{in} signal. A long filtering time makes the drive response slower. See figure 6.5-3.

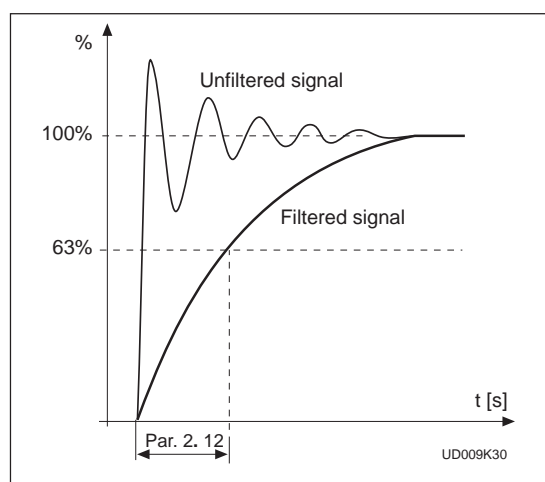

Figure 6.5-3 Analog input I_{in} filter time

2. 13 DIA5 function

- | | |
|--|---|
| 1: External fault, closing contact | = Fault is shown and motor is stopped when the input is active |
| 2: External fault, opening contact | = Fault is shown and motor is stopped when the input is not active |
| 3: Run enable contact open | = Start of the motor disabled |
| contact closed | = Start of the motor enabled |
| 4: Acc. / Dec time select. contact open | = Acceleration/Deceleration time 1 selected |
| contact closed | = Acceleration/Deceleration time 2 selected |
| 5: Reverse contact open | = Forward |
| contact closed | = Reverse |
| If two or more inputs are programmed to reverse only one of them is required for reverse | |
| 6: Jog freq. contact closed | = Jog frequency selected for freq. refer. |
| 7: Fault reset contact closed | = Resets all faults |
| 8: Acc./Dec. operation prohibited contact closed | = Stops acceleration and deceleration until the contact is opened |
| 9: DC-braking command contact closed | = In the stop mode, the DC-braking operates until the contact is opened, see figure 6.5-1. DC-brake current is set with parameter 4. 8. |

2. 14 Motor potentiometer ramp time

Defines how fast the electronic motor (digital) potentiometer value changes.

2. 15 PI-controller reference signal

- 0** Analog voltage reference from terminals 2—3, e.g. a potentiometer
- 1** Analog current reference from terminals 4—5, e.g. a transducer.
- 2** Panel reference is the reference set from the Reference Page (REF).
Reference r2 is the PI-controller reference, see chapter 6.
- 3** Reference value is changed with digital input signals DIA2 and DIA3.
- switch in DIA2 closed = frequency reference increases
- switch in DIA3 closed = frequency reference decreases
Speed of the reference change can be set with the parameter 2. 3.
- 4** Same as setting 3 but the reference value is set to the minimum frequency (par. 1. 1) each time the drive is stopped. When the value of parameter 1. 5 is set to 3 or 4, the value of parameter 2.1 is automatically set to 4 and the value of parameter 2. 2 is automatically set to 10.

2. 16 PI-controller actual value selection**2. 17 Actual value 1****2. 18 Actual value 2**

These parameters select the PI-controller actual value.

2. 19 Actual value 1 minimum scale

Sets the minimum scaling point for Actual value 1. See figure 6.5-4.

2. 20 Actual value 1 maximum scale

Sets the maximum scaling point for Actual value 1. See figure 6.5-4.

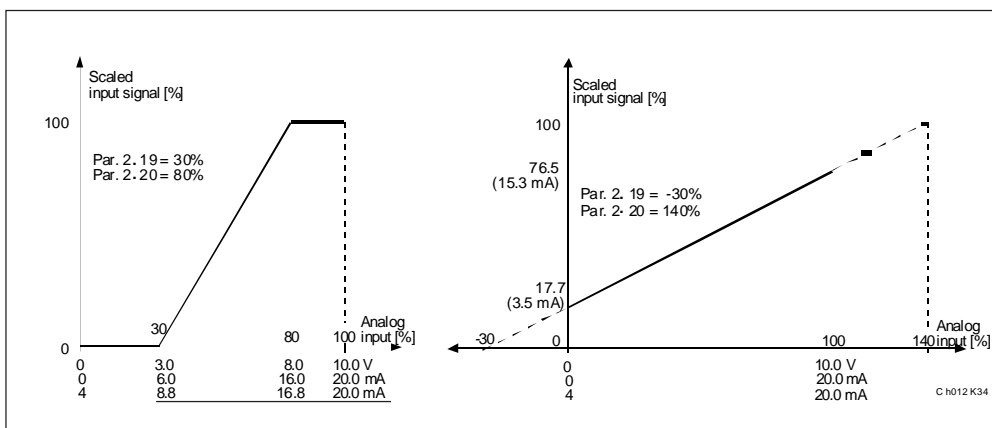

Figure 6.5-4 Examples about the scaling of actual value signal.

2. 21 Actual value 2 minimum scale

Sets the minimum scaling point for Actual value 2.

2. 22 Actual value 2 maximum scale

Sets the maximum scaling point for Actual value 2.

2. 23 Error value inversion

This parameter allows you to invert the error value of the PI-controller (and thus the the operation of the PI-controller).

2. 24 PI-controller minimum limit**2. 25 PI-controller maximum limit**

These parameters set the minimum and maximum values of the PI-controller output.

Parameter value limits: par 1.1 < par. 2. 24 < par. 2. 25.

2. 26 Direct frequency reference, Place B

- 0** Analog voltage reference from terminals 2—3, e.g. a potentiometer
- 1** Analog current reference from terminals 4—5, e.g. a transducer.
- 2** Panel reference is the reference set from the Reference Page (REF), Reference r1 is the Place B reference, see chapter 6.
- 3** Reference value is changed with digital input signals DIA2 and DIA3.
 - switch in DIA2 closed = frequency reference increases
 - switch in DIA3 closed = frequency reference decreases
 Speed of the reference change can be set with the parameter 2. 3.
- 4** Same as setting 3 but the reference value is set to the minimum frequency (par. 1. 1) each time the drive is stopped.

When the value of parameter 1. 5 is set to 3 or 4, the value of parameter 2.1 is automatically set to 4 and the value of parameter 2. 2 is automatically set to 10.

2. 27 2. 28 Place B reference scaling, minimum value/maximum value

Setting limits: $0 < \text{par. 2. 27} < \text{par. 2. 28} < \text{par. 1. 2}$. If par. 2. 28 = 0 scaling is set off. See figures 6.5-5 and 6.5-6.

(In the figures below the voltage input V_{in} with signal range 0—10 V is selected for source B reference)

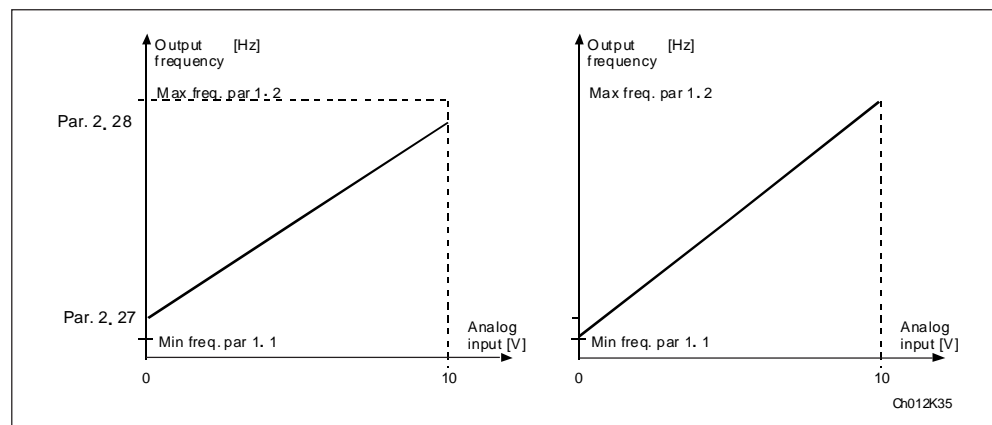

Figure 6.5-5 Reference scaling.

Figure 6.5-6 Reference scaling, par. 2. 15 = 0

3.1 Analog output function

See table on page 6-10.

3.2 Analog output filter time

Filters the analog output signal.
See figure 6.5-7.

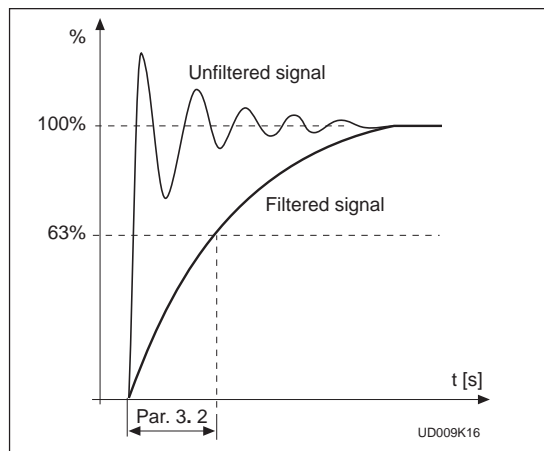

Figure 6.5-7 Analog output filtering.

3.3 Analog output invert

Inverts analog output signal:
max output signal = minimum set value
min output signal = maximum set value

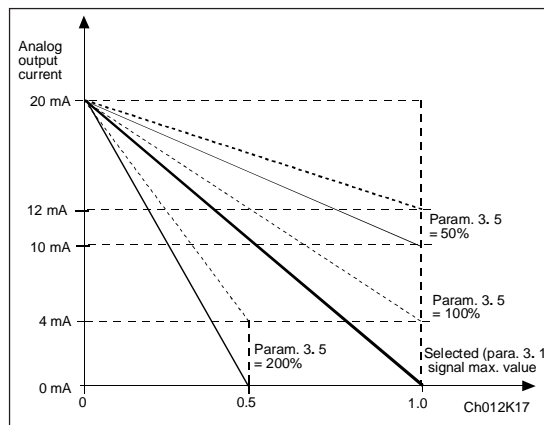

Figure 6.5-8 Analog output invert

3.4 Analog output minimum

Defines the signal minimum to be either 0 mA or 4 mA. See figure 6.5-9.

3.5 Analog output scale

Scaling factor for analog output.
See figure 6.5-9.

Signal	Max. value of the signal
Output freq.	Max. frequency (p. 1. 2)
Motor speed	Max. speed ($n_n \times f_{max} / f_n$)
Output current	$2 \times I_{nSV9}$
Motor torque	$2 \times T_{nMot}$
Motor power	$2 \times P_{nMot}$
Motor voltage	$100\% \times V_{nMot}$
DC-link volt.	1000 V
PI-ref. value	100% x ref. value max.
PI-act. value1	100% x act. value max.
PI-act. value2	100% x act. value max.
PI-error value	100% x error value max.
PI-output	100% x output max.

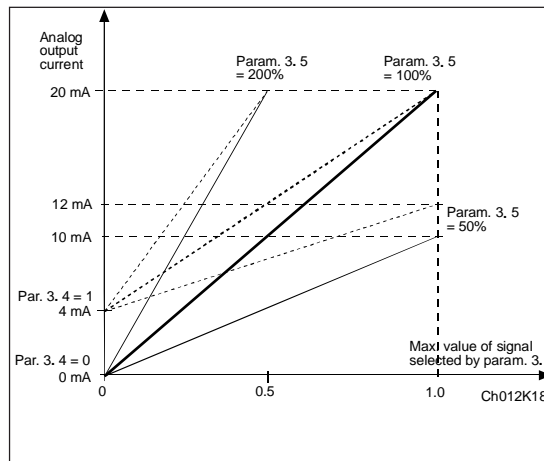

Figure 6.5-9 Analog output scale.



- 3.6 **Digital output function**
 3.7 **Relay output 1 function**
 3.8 **Relay output 2 function**

Setting value	Signal content
0 = Not used	Out of operation <u>Digital output DO1 sinks current and programmable relay (RO1, RO2) is activated when:</u>
1 = Ready	The drive is ready to operate
2 = Run	The drive operates (motor is running)
3 = Fault	A fault trip has occurred
4 = Fault inverted	A fault trip <u>has not</u> occurred
5 = SV9000 overheat warning	The heat-sink temperature exceeds +70°C
6 = External fault or warning	Fault or warning depending on parameter 7. 2
7 = Reference fault or warning	Fault or warning depending on parameter 7. 1 - if analog reference is 4—20 mA and signal is <4mA
8 = Warning	If a warning exists. See Table 7.10-1 in User's Manual
9 = Reversed	The reverse command has been selected
10= Multi-step or jog speed	Multi-step or jog speed has been selected by digital inp.
11 = At speed	The output frequency has reached the set reference
12= Motor regulator activated	Overvoltage or overcurrent regulator was activated
13= Output frequency supervision 1	The output frequency goes outside of the set supervision Low limit/ High limit (par. 3. 9 and par. 3. 10)
14= Output frequency supervision 2	The output frequency goes outside of the set supervision Low limit/ High limit (par. 3. 11 and par. 3. 12)
15= Torque limit supervision	The motor torque goes outside of the set supervision Low limit/ High limit (par. 3. 13 and par. 3. 14)
16= Active reference limit supervision	Active reference goes outside of the set supervision Low limit/ High limit (par. 3. 15 and par. 3. 16)
17= External brake control	External brake ON/OFF control with programmable delay (par 3. 17 and 3. 18)
18= Control from I/O terminals	External control mode selected with progr. pushbutton#2
19= Drive temperature limit supervision	Temperature on drive goes outside the set supervision limits (par. 3. 19 and 3. 20)
20= Unrequested rotation direction	Rotation direction of the motor shaft is different from the requested one
21 = External brake control inverted	External brake ON/OFF control (par. 3.17 and 3.18). Output active when brake control is ON
22—27 = Not in use	
28 = Auxiliary drive 1 start	Starts and stops auxiliary drive 1
29 = Auxiliary drive 2start	Starts and stops auxiliary drive 2
30 = Auxiliary drive 3 start	Starts and stops auxiliary drive 3

Table 6.5-2 Output signals via DO1 and output relays RO1 and RO2.

- 3.9 **Output frequency limit 1, supervision function**
 3.11 **Output frequency limit 2, supervision function**

- 0 = No supervision
 1 = Low limit supervision
 2 = High limit supervision

If the output frequency goes under/over the set limit (3. 10, 3. 12) this function generates a warning message via the digital output DO1 or via a relay output RO1 or RO2 depending on the settings of the parameters 3. 6—3. 8.

- 3.10 **Output frequency limit 1, supervision value**
 3.12 **Output frequency limit 2, supervision value**

The frequency value to be supervised by the parameter 3. 9 (3. 11). See figure 6.5-10.



3. 13 Torque limit , supervision function

- 0 = No supervision
- 1 = Low limit supervision
- 2 = High limit supervision

If the calculated torque value goes under/over the set limit (3. 14) this function generates a warning message via the digital output DO1 or via a relay output RO1 or RO2 depending on the settings of parameters 3. 6—3. 8.

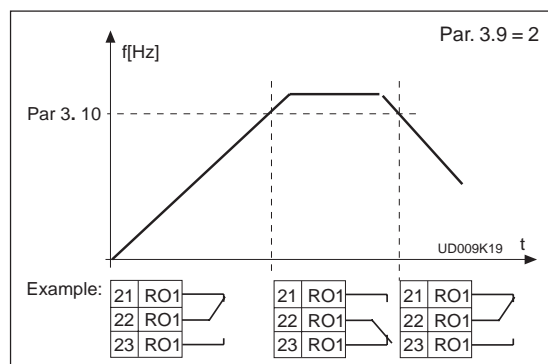

Figure 6.5-10 Output frequency supervision.

3. 14 Torque limit , supervision value

The calculated torque value to be supervised by parameter 3. 13.

3. 15 Active reference limit, supervision function

- 0 = No supervision
- 1 = Low limit supervision
- 2 = High limit supervision

If the reference value goes under/over the set limit (3. 16) this function generates a warning message via the digital output DO1 or via a relay output RO1 or RO2 depending on the settings of parameters 3. 6—3. 8. The supervised reference is the current active reference. It can be source A or B reference depending on DIB6 input or panel reference if the panel is the active control source.

3. 16 Active reference limit , supervision value

The frequency value to be supervised by the parameter 3. 15.

3. 17 External brake-off delay

3. 18 External brake-on delay

The function of the external brake can be delayed from the start and stop control signals with these parameters. See figure 6.5-11.

The brake control signal can be programmed via the digital output DO1 or via one of relay outputs RO1 and RO2, see parameters 3. 6—3. 8.

3. 19 Drive temperature limit supervision function

- 0 = No supervision
- 1 = Low limit supervision
- 2 = High limit supervision

If the temperature of the drive goes under/over the set limit (3. 20) this function generates a warning message via the digital output DO1 or via a relay output RO1 or RO2 depending on the settings of parameters 3. 6—3. 8.

3. 20 Drive temperature limit value

The temperature value to be supervised by parameter 3. 19.

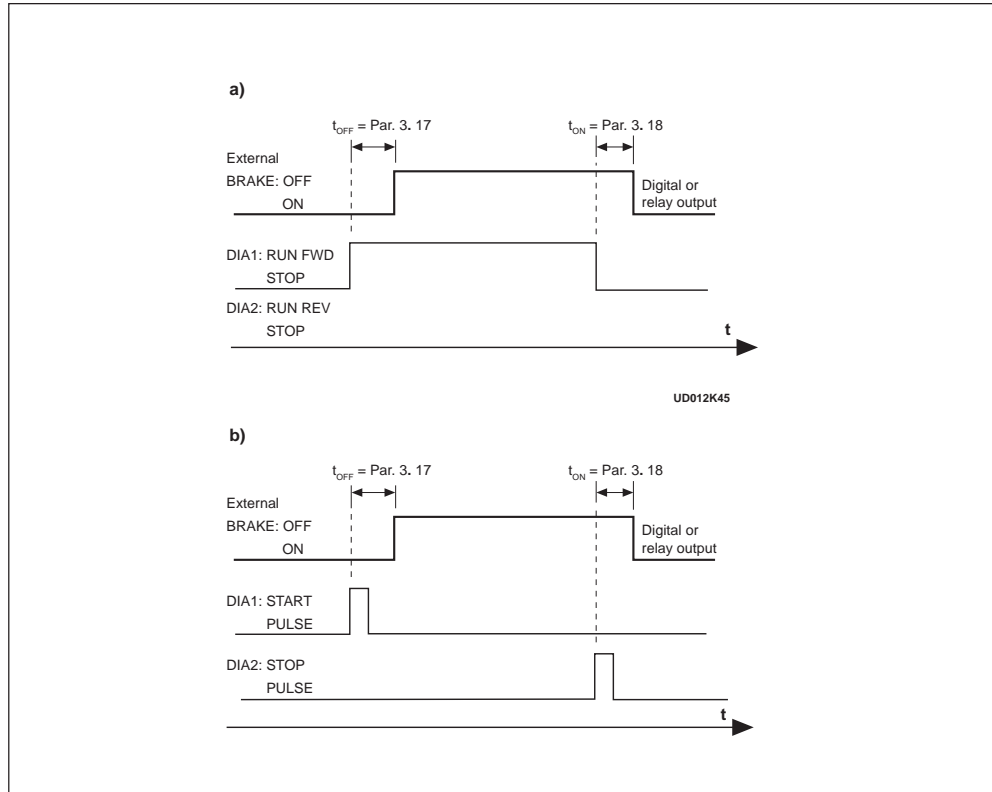

Figure 6.5-11 External brake control: a) Start/Stop logic selection par. 2. 1 = 0, 1 or 2
 b) Start/Stop logic selection par. 2. 1 = 3.

4. 1 Acc/Dec ramp 1 shape
 4. 2 Acc/Dec ramp 2 shape

The acceleration and deceleration ramp shape can be programmed with these parameters.

Setting the value = 0 gives you a linear ramp shape. The output frequency immediately follows the input with a ramp time set by parameters 1. 3, 1. 4 (4. 3, 4. 4 for Acc/Dec time 2).

Setting 0.1—10 seconds for 4. 1 (4. 2) causes an S-shaped ramp. The speed changes are smooth. Parameter 1. 3/ 1. 4 (4. 3/ 4. 4) determines the ramp time of the acceleration/deceleration in the middle of the curve. See figure 6.5-12.

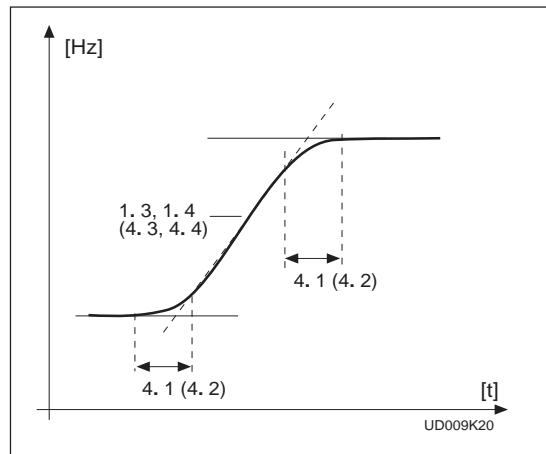

Figure 6.5-12 S-shaped acceleration/ deceleration.



4.3 Acceleration time 2**4.4 Deceleration time 2**

These values correspond to the time required for the output frequency to accelerate from the set minimum frequency (par. 1. 1) to the set maximum frequency (par. 1. 2). With this parameter it is possible to set two different acceleration/deceleration times for one application. The active set can be selected with programmable signal DIA3 of this application. See parameter 2. 2. Acceleration/deceleration times can be reduced with an external free analog input signal. See parameters 2. 18 and 2. 19.

4.5 Brake chopper

- 0 = No brake chopper
- 1 = Brake chopper and brake resistor installed
- 2 = External brake chopper

When the drive is decelerating the motor, the energy stored in the inertia of the motor and the load is fed into the external brake resistor. If the brake resistor is selected correctly the drive is able to decelerate the load with a torque equal to that of acceleration. See the separate Brake resistor installation manual.

4.6 Start function

Ramp:

- 0** The drive starts from 0 Hz and accelerates to the set reference frequency within the set acceleration time. (Load inertia or starting friction may cause prolonged acceleration times).

Flying start:

- 1** The drive starts into a running motor by first finding the speed the motor is running at. Searching starts from the maximum frequency down until the actual frequency is reached. The output frequency then accelerates/decelerates to the set reference value at a rate determined by the acceleration/deceleration ramp parameters.

Use this mode if the motor may be coasting when the start command is given. With the flying start it is possible to ride through short utility voltage interruptions.

4.7 Stop function

Coasting:

- 0** The motor coasts to an uncontrolled stop with the SV9000 off, after the Stop command.

Ramp:

- 1** After the Stop command, the speed of the motor is decelerated according to the deceleration ramp time parameter. If the regenerated energy is high it may be necessary to use an external braking resistor for faster deceleration.

4.8 DC braking current

Defines the current injected into the motor during the DC braking.

4.9 DC braking time at stop**4.9 DC braking time at stop**

Determines whether DC braking is ON or OFF. It also determines the braking duration time of the DC-brake when the motor is stopping. The function of the DC-brake depends on the stop function, parameter 4. 7. See figure 6.5-13.



- 0 DC-brake is not used
- >0 DC-brake is in use depending on the setup of the stop function (param. 4. 7). The time is set by the value of parameter 4. 9:

Stop-function = 0 (coasting):

After the stop command, the motor will coast to a stop with the SV9000 off.

With DC-injection, the motor can be electrically stopped in the shortest possible time, without using an optional external braking resistor.

The braking time is scaled according to the frequency when the DC- braking starts. If the frequency is \geq nominal frequency of the motor (par. 1.11), the value of parameter 4.9 determines the braking time. When the frequency is $\leq 10\%$ of the nominal, the braking time is 10% of the set value of parameter 4.9.

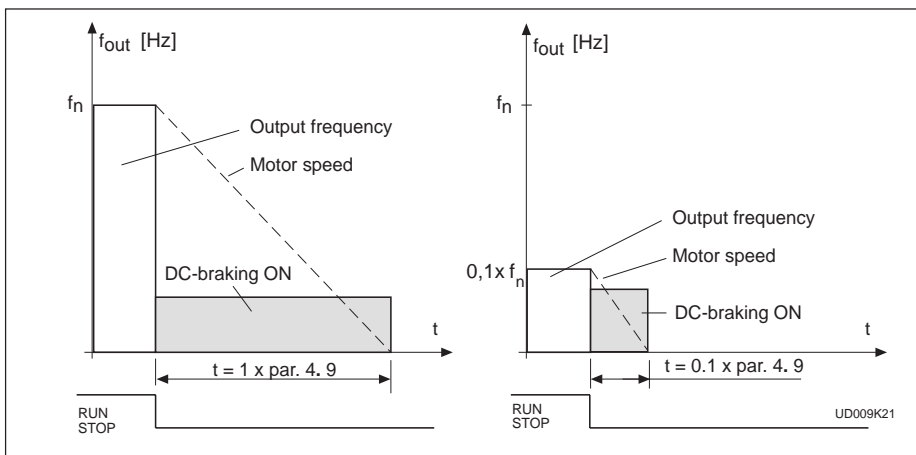

Figure 6.5-13 DC-braking time when par. 4. 7 = 0.

Stop-function = 1 (ramp):

After the Stop command, the speed of the motor is reduced based on the deceleration ramp parameter, if no regeneration occurs due to load inertia, to a speed defined with by parameter 4. 10, where the DC-braking starts.

The braking time is defined with parameter 4. 9.

If high inertia exists, it is recommended to use an external braking resistor for faster deceleration. See figure 6.5-14.

4. 10 Execute frequency of DC-brake during ramp Stop

See figure 6.5-14.

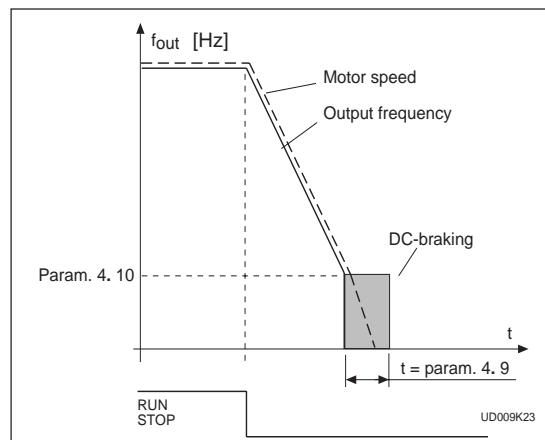

Figure 6.5-14 DC-braking time when par. 4. 7 = 1.



- 4. 11 DC-brake time at start**
- 0** DC-brake is not used
- >0** DC-brake is active when the start command is given. This parameter defines the time before the brake is released. After the brake is released the output frequency increases according to the set start function parameter 4. 6 and acceleration parameters (1. 3, 4. 1 or 4. 2, 4. 3), see figure 6.5-15.

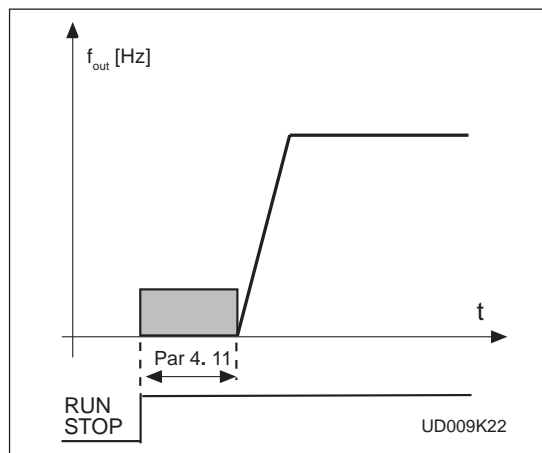

Figure 6.5-15 DC-braking time at start

4. 12 Jog speed reference

Parameter value defines the jog speed selected with the digital input.

5. 1-5.6 Prohibit frequency area, Low limit/High limit

In some systems it may be necessary to avoid certain frequencies because of mechanical resonance problems.

With these parameters it is possible to set limits for three "skip frequency" regions. The accuracy of the setting is 0.1 Hz.

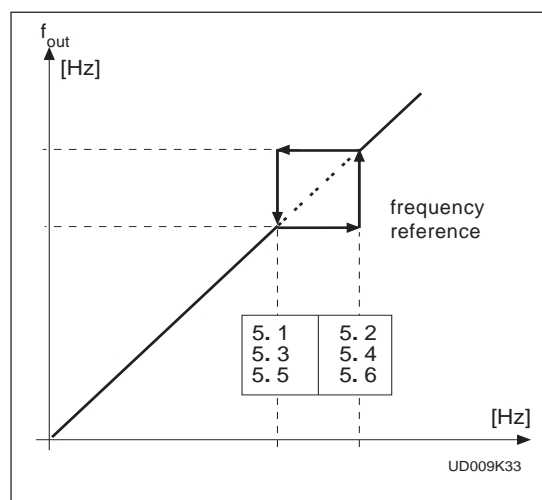

Figure 6.5-16 Example of prohibit frequency area setting.

6. 1 Motor control mode

0 = Frequency control: The I/O terminal and panel references are frequency references and the drive controls the output frequency (output freq. resolution 0.01 Hz)

1 = Speed control: The I/O terminal and panel references are speed references (sensorless vector) and the drive controls the motor speed (control accuracy $\pm 0.5\%$).

6. 2 Switching frequency

Motor noise can be minimized by using a high switching frequency. Increasing the frequency reduces the capacity of the SV9000. Before changing the frequency from the factory default 10 kHz ($3.6 \text{ kHz} \geq 40\text{Hp}$), check the drive derating from the curves in figure 5.2-2 and 5.2-3 of the User's Manual.

6.3 Field weakening point
6.4 Voltage at the field weakening point

The field weakening point is the output frequency where the output voltage reaches the set maximum value (par. 6.4). Above that frequency the output voltage remains at the set maximum value. Below that frequency output voltage depends on the setting of the V/Hz curve parameters 1.8, 1.9, 6.5, 6.6 and 6.7. See figure 6.5-17.

When parameters 1.10 and 1.11, nominal voltage and nominal frequency of the motor are set, parameters 6.3 and 6.4 are also set automatically to the corresponding values. If different values for the field weakening point and the maximum output voltage are required, change these parameters after setting the parameters 1.10 and 1.11.

6.5 V/Hz curve, middle point frequency

If the programmable V/Hz curve has been selected with 2.28 parameter 1.8 this parameter defines the middle point frequency of the curve. See figure 6.5-17.

6.6 V/Hz curve, middle point voltage

If the programmable V/Hz curve has been selected with parameter 1.8 this parameter defines the middle point voltage (% of motor nominal voltage) of the curve. See figure 6.5-17.

6.7 Output voltage at zero frequency

If the programmable V/Hz curve has been selected with parameter 1.8 this parameter defines the zero frequency voltage of the curve. See figure 6.5-17.

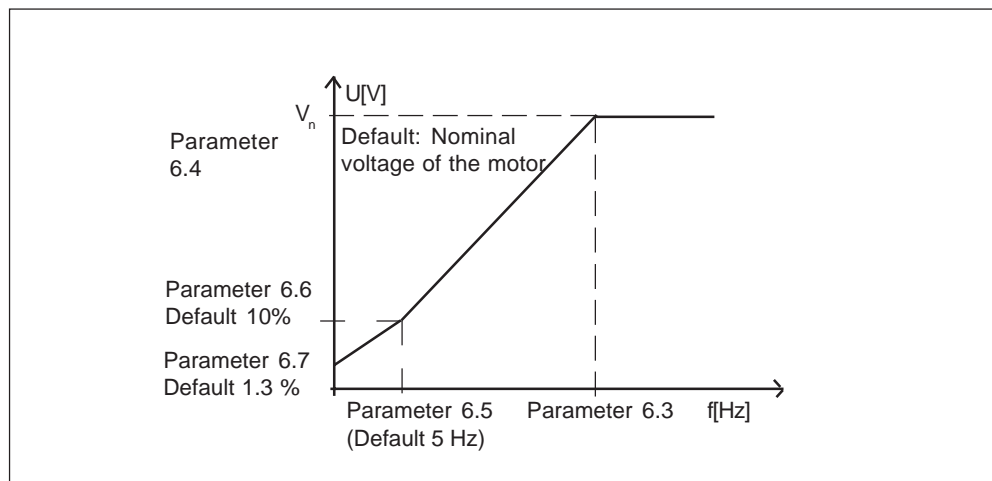

Figure 6.5-17 Programmable V/Hz curve

6.8 Overvoltage controller
6.9 Undervoltage controller

These parameters allow the over/undervoltage controllers to be switched ON or OFF. This may be useful in cases where the utility supply voltage varies more than -15%—+10% and the application requires a constant speed. If the controllers are ON, they will change the motor speed in over/undervoltage cases. Overvoltage = faster, undervoltage = slower.

Over/undervoltage trips may occur when controllers are not used.

7.1 Response to the reference fault

- 0 = No response
- 1 = Warning
- 2 = Fault, stop mode after fault according to parameter 4.7
- 3 = Fault, always coasting stop mode after fault

A warning or a fault action and message is generated if 4—20 mA reference signal is used and the signal falls below 4 mA. The information can also be programmed via digital output DO1 and via relay outputs RO1 and RO2.

7.2 Response to external fault

- 0 = No response
- 1 = Warning
- 2 = Fault, stop mode after fault according to parameter 4.7
- 3 = Fault, always coasting stop mode after fault

A warning or a fault action and message is generated from the external fault signal in the digital input DIA3. The information can also be programmed into digital output DO1 and into relay outputs RO1 and RO2.

7.3 Phase supervision of the motor

- 0 = No action
- 2 = Fault

Phase supervision of the motor ensures that the motor phases have approximately equal current.

7.4 Ground fault protection

- 0 = No action
- 2 = Fault message

Ground fault protection ensures that the sum of the motor phase currents is zero. The overcurrent protection is always working and protects the drive from ground faults with high current levels.

Parameters 7.5—7.9 Motor thermal protection

General

Motor thermal protection is to protect the motor from overheating. The SV9000 drive is capable of supplying higher than nominal current to the motor. If the load requires this high current, there is a risk that motor will be thermally overloaded. This is true especially at low frequencies. With low frequencies the cooling effect of the motor fan is reduced and the capacity of the motor is reduced. If the motor is equipped with an external fan, the load reduction on low speed is small.

Motor thermal protection is based on a calculated model and it uses the output current of the drive to determine the load on the motor. When the power is turned on to the drive, the calculated model uses the heatsink temperature to determine the initial thermal state of the motor. The calculated model assumes that the ambient temperature of the motor is 40°C.

Motor thermal protection can be adjusted by setting several parameters. The thermal current I_T specifies the load current above which the motor is overloaded. This current limit is a function of the output frequency. The curve for I_T is set with parameters 7.6, 7.7 and 7.9. See figure 6.5-18. The default values of these parameters are set from the motor nameplate data.



With the output current at I_T the thermal state will reach the nominal value (100%). The thermal state changes with the square of the current. With output current at 75% of I_T the thermal state will reach 56% and with output current at 120% of I_T the thermal state would reach 144%. The function will trip the drive (refer par. 7. 5) if the thermal model reaches a value of 105%. The response time of the thermal model is determined by the time constant, parameter 7. 8. The larger the motor the longer it takes to reach the final temperature.

The thermal state of the motor can be monitored through the display. Refer to the table for monitoring items. (User's Manual, table 7.3-1).



CAUTION! *The calculated model does not protect the motor if the cooling of the motor is reduced either by blocking the airflow or due to dust or dirt.*

7.5 Motor thermal protection

Operation:

- 0 = Not in use
- 1 = Warning
- 2 = Trip function

Tripping and warning will give a display indication with the same message code. If tripping is selected, the drive will stop and activate the fault stage.

Deactivating the protection by setting this parameter to 0, will reset the thermal stage of the motor to 0%.

7.6 Motor thermal protection, break point current

The current can be set between 50.0—150.0% $\times I_{nMotor}$. This parameter sets the value for thermal current at frequencies above the break point on the thermal current curve. See figure 6.5-18.

The value is set as a percentage of the motor nameplate nominal current, parameter 1. 13, nominal current of the motor, not the drive's nominal output current.

The motor's nominal current is the current which the motor can withstand in direct on-line use without being overheated.

If parameter 1. 13 is adjusted, this parameter is automatically restored to its default value.

Setting this parameter (or parameter 1. 13) does not affect the maximum output current of the drive. Parameter 1. 7 alone determines the maximum output current of the drive.

7.7 Motor thermal protection, zero frequency current

The current can be set between 10.0—150.0% $\times I_{nMotor}$. This parameter sets the value for thermal current at zero frequency. See figure 6.5-18.

The default value is set assuming that there is no external fan cooling the motor. If an external fan is used this parameter can be set to 90% (or higher).

The value is set as a percentage of the motor's nameplate nominal current, parameter 1. 13, not the drive's nominal output current. The motor's nominal

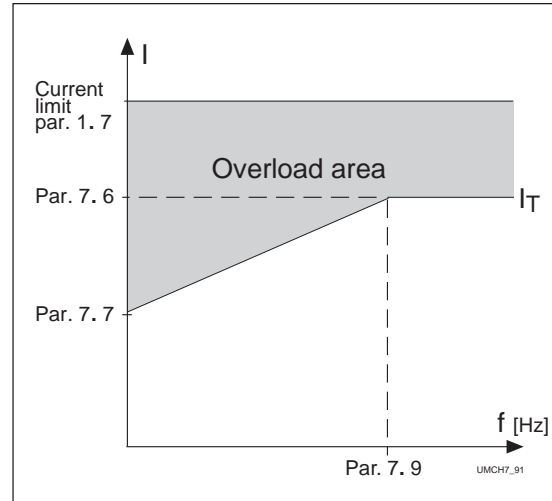

Figure 6.5-18 Motor thermal current I_T curve.

current is the current which the motor can stand in direct on-line use without being overheated.

If you change parameter 1. 13, this parameter is automatically restored to the default value.

Setting this parameter (or parameter 1. 13) does not affect to the maximum output current of the drive. Parameter 1. 7 alone determines the maximum output current of the drive.

7.8 Motor thermal protection, time constant

The time can be set between 0.5—300 minutes. This is the thermal time constant of the motor. The larger the motor the greater the time constant. The time constant is defined as the time it takes the calculated thermal stage to reach 63% of its final value.

The motor thermal time is specific to a motor design and it varies between different motor manufacturers.

The default value for the time constant is calculated based on the motor nameplate data from parameters 1. 12 and 1. 13. If either of these parameters is reset, then this parameter is set to its default value.

If the motor's t_6 -time is known (given by the motor manufacturer) the time constant parameter could be set based on t_6 -time. As a rule of thumb, the motor thermal time constant in minutes equals to $2xt_6$ (t_6 in seconds is the time a motor can safely operate at six times the rated current). If the drive is in stopped, the time constant is internally increased to three times the set parameter value. The cooling in the stop stage is based on convection with an increased time constant.

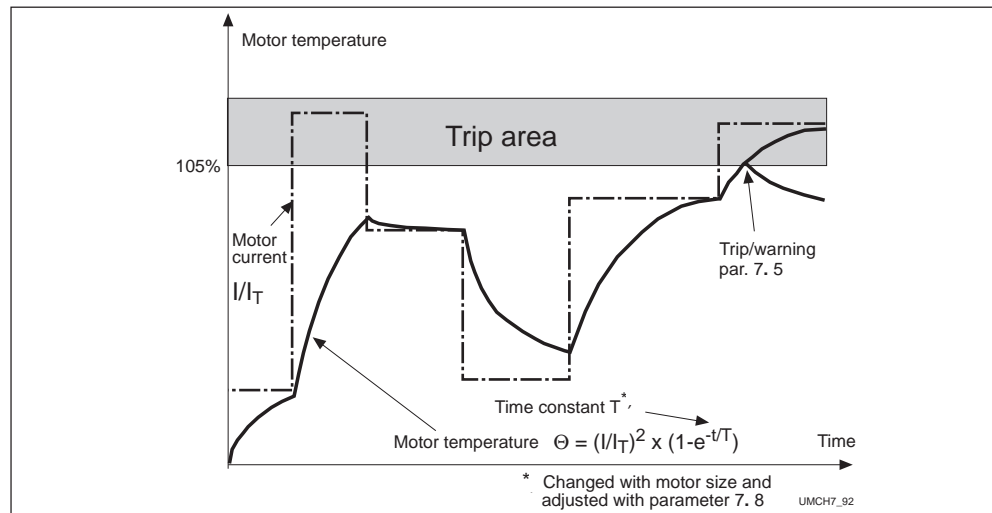

Figure 6.5-19 Calculating motor temperature

7.9 Motor thermal protection, break point frequency

The frequency can be set between 10—500 Hz. This is the frequency break point of thermal current curve. With frequencies above this point the thermal capacity of the motor is assumed to be constant. See figure 6.5-18.

The default value is based on motor's nameplate data, parameter 1. 11. It is 35 Hz for a 50 Hz motor and 42 Hz for a 60 Hz motor. More generally it is 70% of the frequency at the field weakening point (parameter 6. 3). Changing either parameter 1. 11 or 6. 3 will restore this parameter to its default value.

Parameters 7. 10— 7. 13, Stall protection

General

Motor stall protection protects the motor from short time overload situations like a stalled shaft. The reaction time of stall protection can be set shorter than with motor thermal protection. The stall state is defined with two parameters, 7.11. Stall Current and 7.13. Stall Frequency. If the current is higher than the set limit and output frequency is lower than the set limit, the stall state is true. There is actually no real indication of the shaft rotation. Stall protection is a type of overcurrent protection.

7. 10 Stall protection

Operation:

- 0 = Not in use
- 1 = Warning
- 2 = Trip function

Tripping and warning will give a display indication with the same message code. If tripping is set on, the drive will stop and activate the fault stage.

Setting this parameter to 0 will deactivate the protection and will reset the stall time counter to zero.

7. 11 Stall current limit

The current can be set between 0.0—200% $\times I_{nMotor}$.

In a stall the current has to be above this limit. See figure 6.5-20. The value is set as a percentage of the motor's nameplate nominal current, parameter 1.13. If parameter 1.13 is adjusted, this parameter is automatically restored to its default value.

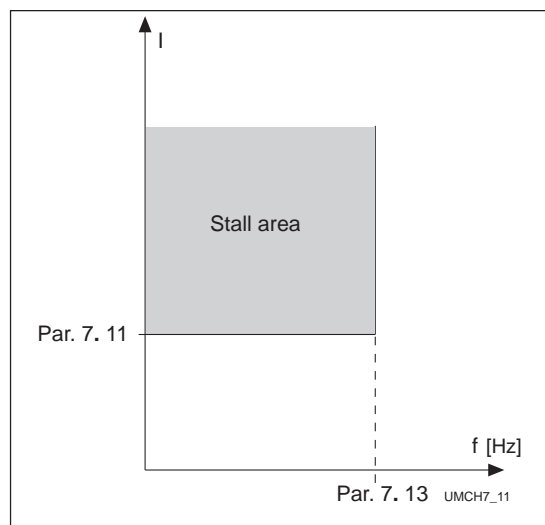

Figure 6.5-20 Setting the stall characteristics.

7. 12 Stall time

The time can be set between 2.0—120 s.

This is the maximum allowed time for a stall. There is an internal up/down counter to count the stall time. See figure 6.5-21. If the stall time counter value goes above this limit the protection will cause a trip (refer to the parameter 7. 10).

7. 13 Maximum stall frequency

The frequency can be set between 1— f_{max} (par. 1. 2).

In the stall state, the output frequency has to be smaller than this limit. See figure 6.5-20.

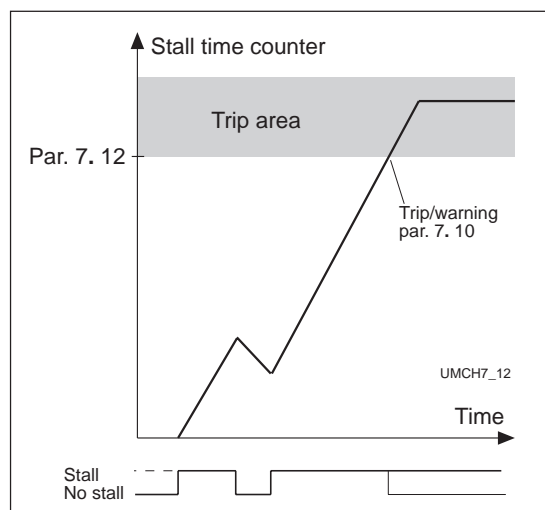

Figure 6.5-21 Counting the stall time.

Parameters 7. 14— 7. 17, Underload protection

General

The purpose of motor underload protection is to ensure that there is load on the motor while the drive is running. If the motor load is reduced, there might be a problem in the process, e.g. broken belt or dry pump.

Motor underload protection can be adjusted by setting the underload curve with parameters 7. 15 and 7. 16. The underload curve is a squared curve set between zero frequency and the field weakening point. The protection is not active below 5Hz (the underload counter value is stopped). See figure 6.5-22.

The torque values for setting the underload curve are set with percentage values which refer to the nominal torque of the motor. The motor's nameplate data, parameter 1. 13, the motor's nominal current and the drive's nominal current I_{CT} are used to find the scaling ratio for the internal torque value. If other than standard motor is used with the drive, the accuracy of the torque calculation is decreased.

7. 14 Underload protection

Operation:

- 0 = Not in use
- 1 = Warning
- 2 = Fault

Tripping and warning will give a display indication with the same message code. If tripping is set active the drive will stop and activate the fault stage.

Deactivating the protection, by setting this parameter to 0, will reset the underload time counter to zero.

7. 15 Underload protection, field weakening area load

The torque limit can be set between 20.0—150 % x T_{nMotor} .

This parameter is the value for the minimum allowed torque when the output frequency is above the field weakening point. See the figure 6.5-22. If parameter 1. 13 is adjusted, this parameter is automatically restored to its default value.

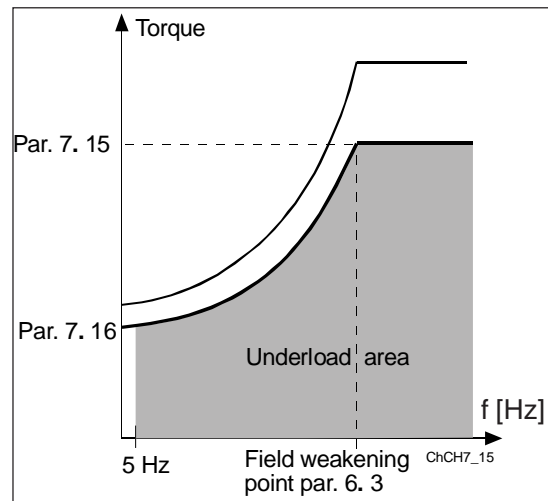

Figure 6.5-22 Setting of minimum load.

7. 16 Underload protection, zero frequency load

Torque limit can be set between 10.0—150 % x T_{nMotor} .

This parameter is the value for the minimum allowed torque with zero frequency. See figure 6.5-22. If parameter 1. 13 is adjusted, this parameter is automatically restored to its default value.

7. 17 Underload time

This time can be set between 2.0—600.0 s.

This is the maximum allowed time for an underload state. There is an internal up/down counter to accumulate the underload time. See figure 6.5-23. If the underload counter value goes above this limit, the protection will cause a trip (refer to the parameter 7. 14). If the drive is stopped the underload counter is reset to zero.

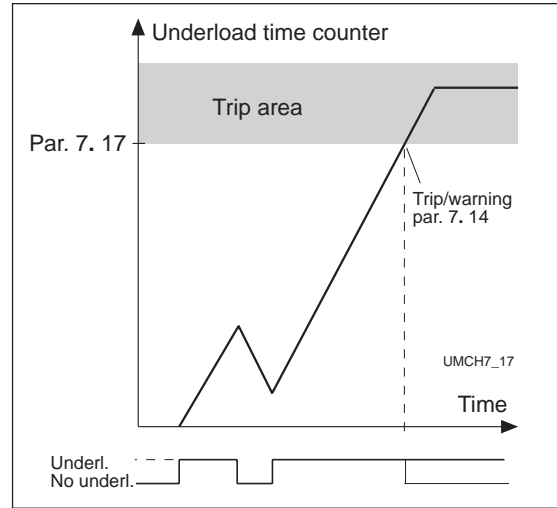

Figure 6.5-23 Counting the underload time.

- 8. 1 Automatic restart: number of tries
- 8. 2 Automatic restart: trial time

The Automatic restart function restarts the drive after the faults selected with parameters 8. 4—8. 8. The Start function for Automatic restart is selected with parameter 8. 3.

Parameter 8. 1 determines how many automatic restarts can be made during the trial time set by the parameter 8. 2.

The time counting starts from the first autorestart. If the number of restarts does not exceed the value of parameter 8.1 during the trial time, the counting is cleared after the trial time has elapsed. The next fault starts the counting again. See figure 6.5-2.

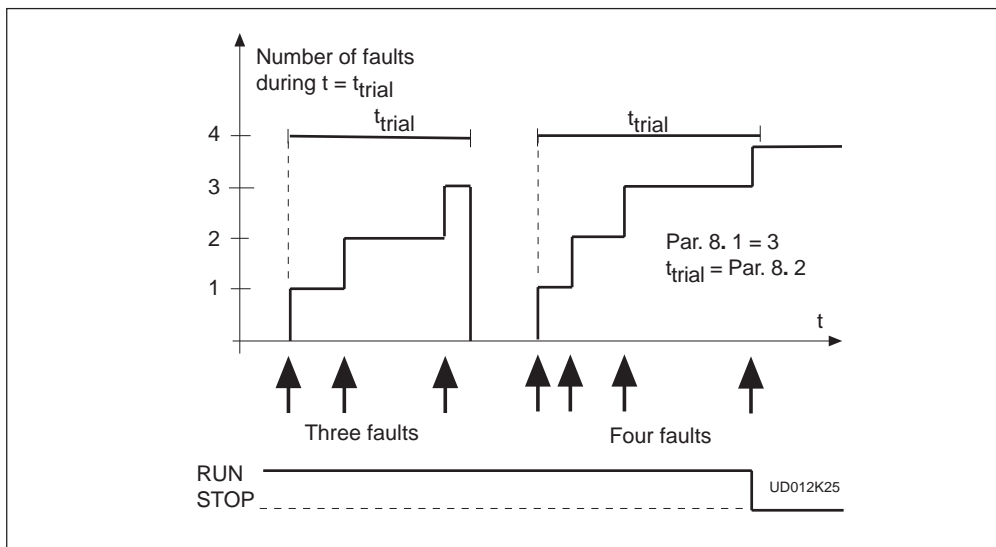

Figure 6.5-24 Automatic restart.



8.3 Automatic restart, start function

The parameter defines the start mode:

- 0 = Start with ramp
- 1 = Flying start, see parameter 4. 6.

8.4 Automatic restart after undervoltage trip

- 0 = No automatic restart after undervoltage trip
- 1 = Automatic restart after undervoltage fault condition returns to the normal condition (DC-link voltage returns to the normal level)

8.5 Automatic restart after overvoltage trip

- 0 = No automatic restart after overvoltage trip
- 1 = Automatic restart after overvoltage fault condition returns to the normal condition (DC-link voltage returns to the normal level)

8.6 Automatic restart after overcurrent trip

- 0 = No automatic restart after overcurrent trip
- 1 = Automatic restart after overcurrent faults

8.7 Automatic restart after reference fault trip

- 0 = No automatic restart after reference fault trip
- 1 = Automatic restart after analog current reference signal (4—20 mA) returns to the normal level (≥ 4 mA)

8.8 Automatic restart after over/undertemperature fault trip

- 0 = No automatic restart after temperature fault trip
- 1 = Automatic restart after heatsink temperature has returned to its normal level between -10°C — $+75^{\circ}\text{C}$.

9.1 Number of auxiliary drives

With this parameter the number of auxiliary drives in use is defined. The signals to control the auxiliary drives on and off can be programmed to the relay outputs or to the digital output with parameters 3. 6 - 3. 8. The default setting is one auxiliary drive in use, pre-programmed to relay output RO1.

9.2 Start frequency of auxiliary drive 1

9.4 Start frequency of auxiliary drive 2

9.6 Start frequency of auxiliary drive 3

The frequency of the SV9000 must exceed by 1 Hz the limit defined with these parameters before the auxiliary drive is started. The 1 Hz provides hysteresis to avoid unnecessary starts and stops. See figure 6.5-25.

9.3 Stop frequency of auxiliary drive 1

9.5 Stop frequency of auxiliary drive 2

9.7 Stop frequency of auxiliary drive 3

The frequency of the SV9000 must fall 1Hz below the limit defined with these parameters before the auxiliary drive is stopped. The stop frequency limit also defines the frequency the drive drops to after starting the auxiliary drive. See figure 6.5-25.

9.10 Start delay of auxiliary drives

Starting of the auxiliary drives is delayed based on the time setting of parameter 9. 10. This prevents unnecessary starts which could be caused by a flow reference request which is momentarily above the previous reference level. See figure 6.5-25.

9.11 Stop delay of auxiliary drives

Stopping of the auxiliary drives is delayed based on the time setting of parameter 9. 10. This prevents unnecessary stops which could be caused by a flow reference request which is momentarily below the previous reference level. See figure 6.5-25.

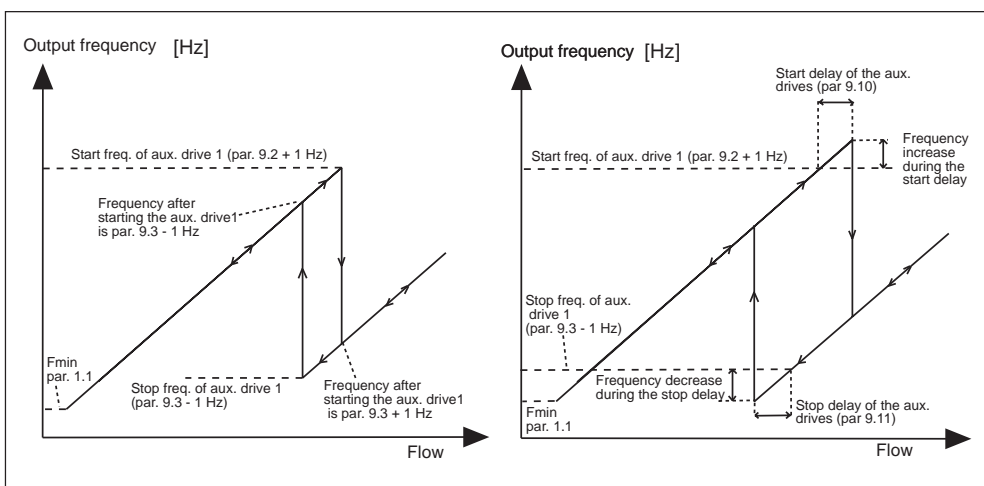

Figure 6.5-25 Example of the effect of parameters in variable speed and one auxiliary drive system.

- 9.12 Reference step after start of the auxiliary drive 1
- 9.13 Reference step after start of the auxiliary drive 2
- 9.14 Reference step after start of the auxiliary drive 3

A reference step will automatically be added to the reference value when the corresponding auxiliary drive is started. This allows compensation for the pressure loss in the piping caused by the increased flow. See figure 6.5-26.

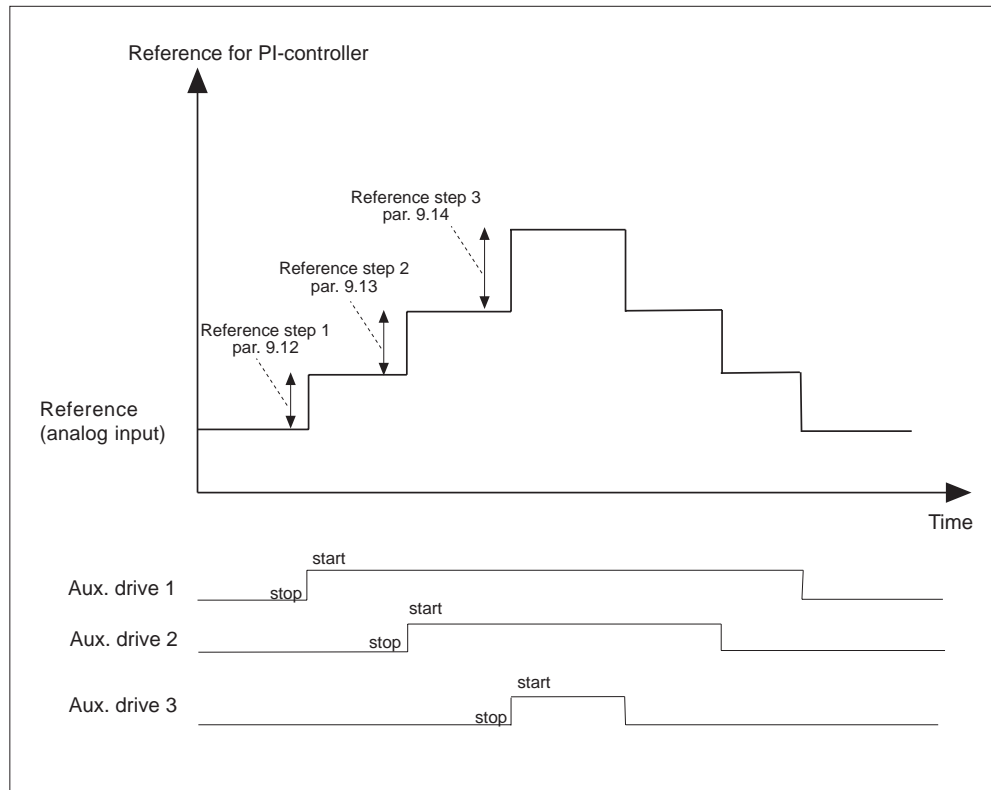

Figure 6.5-26 Reference steps after starting and stopping the auxiliary drives.

- 9.16 Sleep level
- 9.17 Sleep delay

Changing this parameter from a value of 0.0 Hz activates the sleep function where the drive is stopped automatically when the frequency is below the sleep level (par. 9.16) continuously over the sleep delay (9.17) time. During the stop state the Pump and fan control logic is operating and will switch the drive to the Run state when the wake up level defined with parameters 9.18 and 9.19 is reached. See figure 6.5-27.

- 9.18 Wake up level

The wake up level defines the percentage level below which the actual frequency must fall or which has to be exceeded before starting the drive from the sleep function. See figure 6.5-27.

- 9.19 Wake up function

This parameter defines if the wake up occurs when the frequency either falls below or exceeds the wake up level (par. 9.18).

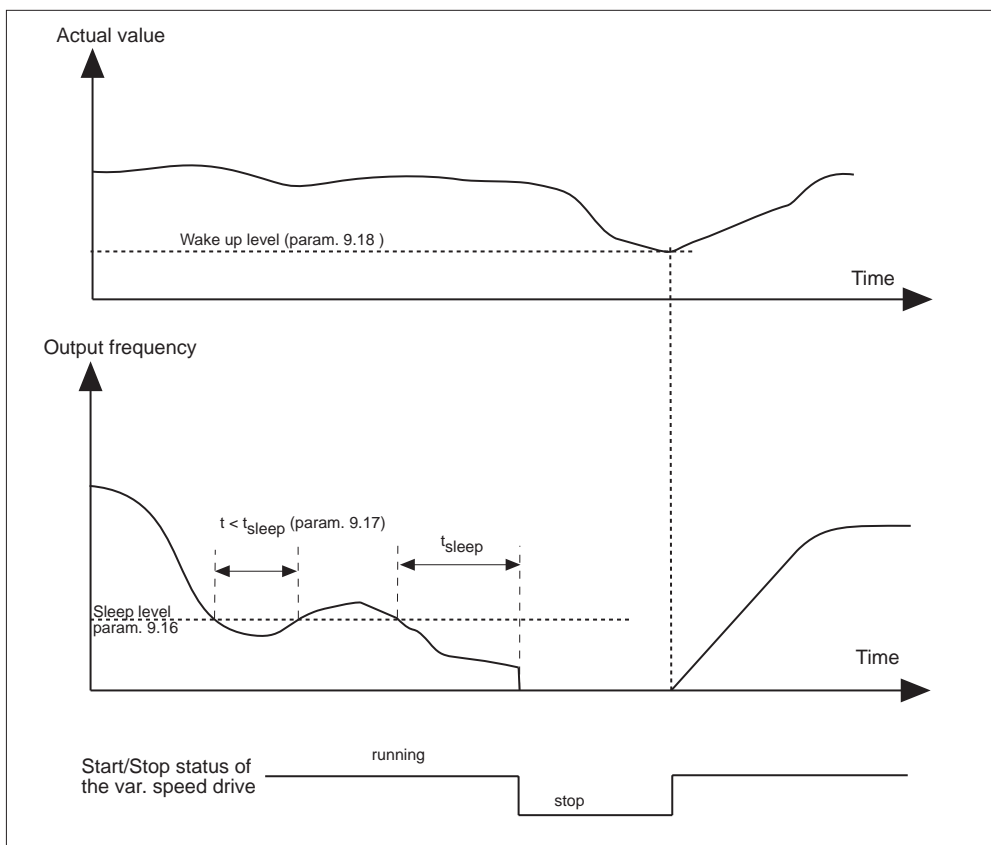

Figure 6.5-27 Example of the sleep function.

9. 20 PI-regulator bypass

With this parameter the PI-regulator can be programmed to be bypassed. Then the frequency of the drive is controlled by the frequency reference and the starting points of the auxiliary drives are also defined by this reference.

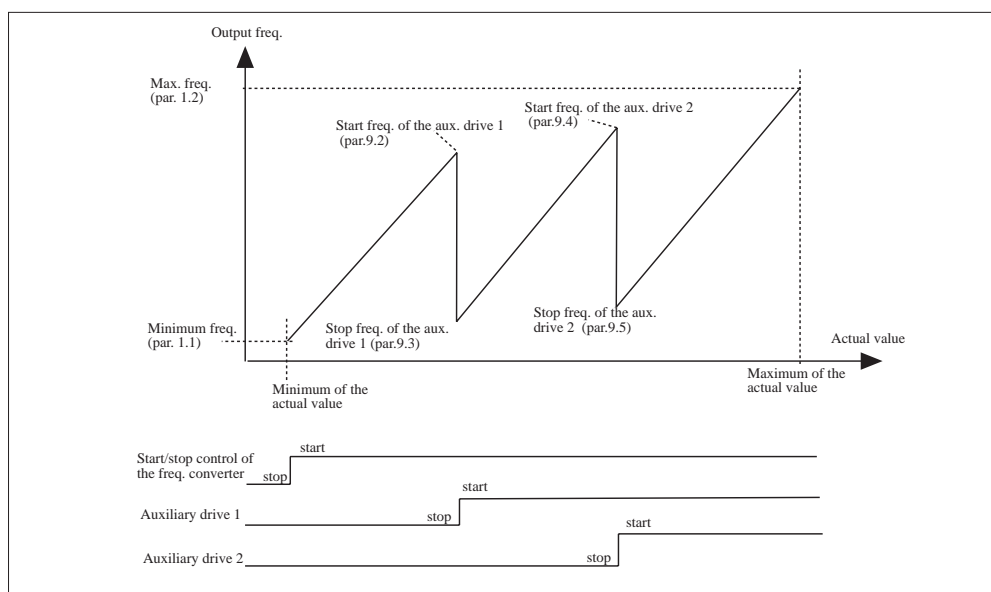

Figure 6.5-28 Example of the function of variable speed drive and two auxiliary drives when PI-regulator is bypassed with parameter 9. 20.



6.6 MONITORING DATA

The PI-control application has additional items for monitoring (n20 - n25). See table 6.6-1

Data number	Data name	Unit	Description
n 1	Output frequency	Hz	Frequency to the motor
n 2	Motor speed	rpm	Calculated motor speed
n 3	Motor current	A	Measured motor current
n 4	Motor torque	%	Calculated actual torque/nominal torque of the unit
n 5	Motor power	%	Calculated actual power/nominal power of the unit
n 6	Motor voltage	V	Calculated motor voltage
n 7	DC-link voltage	V	Measured DC-link voltage
n 8	Temperature	°C	Temperature of the heat sink
n 9	Operating day counter	DD.dd	Operating days ¹ , not resettable
n 10	Operating hours, "trip counter"	HH.hh	Operating hours ² , can be reset with programmable button #3
n 11	MW-hours	MWh	Total MW-hours, not resettable
n 12	MW-hours, "trip counter"	MWh	MW-hours, can be reset with programmable button #4
n 13	Voltage/analog input	V	Voltage of the terminal V_{in+} (term. #2)
n 14	Current/analog input	mA	Current of terminals I_{in+} and I_{in-} (term. #4, #5)
n 15	Digital input status, gr. A		
n 16	Digital input status, gr. B		
n 17	Digital and relay output status		
n 18	Control program		Version number of the control software
n 19	Unit nominal power	Hp	Shows the horsepower size of the unit
n 20	PI-controller reference	%	Percent of the maximum reference
n 21	PI-controller actual value	%	Percent of the maximum actual value
n 22	PI-controller error value	%	Percent of the maximum error value
n 23	PI-controller output	Hz	
n 24	Number of running auxiliary drives		
n 25	Motor temperature rise	%	100%= temperature of motor has risen to nominal

Table 6.6-1 Monitored items.

¹ DD = full days, dd = decimal part of a day

² HH = full hours, hh = decimal part of an hour



6.7 Panel reference

The Pump and fan control application has an extra reference (r2) for PI-controller on the panel's reference page. See table 6.7-1.

Reference number	Reference name	Range	Step	Function
r1	Frequency reference	$f_{\min}—f_{\max}$	0.01 Hz	Reference for panel control and I/O terminal Source B reference.
r2	PI-controller reference	0—100%	0.1%	Reference for PI-controller

Table 6.7-1 Panel reference.



