

# SV9000 AF DRIVES

## User Manual



# SV9000



Cutler-Hammer

EAT•N

## HOW TO USE THIS MANUAL

This manual provides you with the information necessary to install, start-up and operate a Cutler-Hammer SV9000 drive. We recommend that you read this manual carefully.

At minimum the following 10 steps of the

### Quick Start Guide

1. Check the equipment received compared to what you have ordered, see chapter 3.
2. Before doing any start-up actions carefully read the safety instructions in chapter 1.
3. Before mechanical installation, check the minimum clearances around the unit and verify that ambient conditions will meet the requirements of chapter 5.2. and table 4.3-1a.
4. Check the size of the motor cable, the utility cable and the fuses. Verify the tightness of the cable connections. Review chapters 6.1.1, 6.1.2 and 6.1.2.
5. Follow the installation instructions, see chapter 6.1.4.
6. Control cable sizes and grounding system are explained in chapter 6.2. The signal configuration for the Basic application is in chapter 10.2.  
  
Remember to connect the common terminals CMA and CMB of the digital input groups (See figure 10.2.1).
7. For instructions on how to use the SVMulti-line™ panel see chapter 7.
8. The basic application has only 10 parameters in addition to the motor rating plate data, the parameter and application package lock. All of these have default values. To ensure proper operation verify the nameplate data of both the motor and SV9000:
  - nominal voltage of the motor
  - nominal frequency of the motor
  - nominal speed of the motor
  - nominal current of the motor
  - supply voltageParameters are explained in chapter 10.4.
9. Follow the start-up instructions, see chapter 8.
10. Your Cutler-Hammer SV9000 is now ready for use.

*Quick Start Guide* must be done during installation and startup.

If any problem occurs, please call the telephone number listed on the back of this manual for assistance.

If a different I/O configuration or different operational functions from the basic configuration are required, see chapter 12, SVReady application package for a more suitable configuration. For a more detailed description, see the separate SVReady - application manual.

Cutler-Hammer is not responsible for the use of the SV9000 differently than noted in these instructions.



## SV9000 USER MANUAL

### CONTENTS

1	Safety .....	2
2	EU-directive .....	4
3	Receiving .....	5
4	Technical data .....	7
5	Installation .....	17
6	Wiring .....	23
7	SVMulti-line™ .....	49
8	Startup .....	61
9	Fault tracing .....	64
10	Basic application .....	66
11	System parameter group 0 .....	73
12	SVReady™ application package .....	75
13	Options .....	77

**OPEN SV9000 SVReady USER MANUAL**





## CUTLER-HAMMER SV9000 USERS MANUAL CONTENTS

<b>1 Safety</b>	<b>2</b>	7.5 Reference menu .....	54
1.1 Warnings .....	2	7.6 Programmable push-button menu	55
1.2 Safety instructions .....	2	7.7 Active faults menu .....	56
1.3 Grounding and ground fault protection .....	3	7.8 Fault history menu .....	58
1.4 Running the motor .....	3	7.9 Contrast menu .....	58
<b>2 EU-directive</b> .....	<b>4</b>	7.10 Active warning display .....	59
2.1 CE-label .....	4	7.11 Controlling motor from the panel	60
2.2 EMC-directive .....	4	7.11.1 Control source change from I/O - terminals to the panel ..	60
2.2.1 General .....	4	7.11.2 Control source change from panel to I/O .....	60
2.2.2 Technical criteria .....	4	<b>8 Start-up</b> .....	<b>61</b>
2.2.3 SV9000 EMC-levels .....	4	8.1 Safety precautions .....	61
2.2.4 Manufacturer's Declaration of Conformity .....	4	8.2 Sequence of operation .....	61
<b>3 Receiving</b> .....	<b>5</b>	<b>9 Fault tracing</b> .....	<b>64</b>
3.1 Catalog number .....	5	<b>10 Basic application</b> .....	<b>66</b>
3.2 Storing .....	6	10.1 General .....	66
3.3 Warranty .....	6	10.2 Control connections .....	66
<b>4 Technical data</b> .....	<b>7</b>	10.3 Control signal logic .....	67
4.1 General .....	7	10.4 Parameters, group 1 .....	68
4.2 Power ratings .....	8	10.4.1 Descriptions .....	69
4.3 Specifications .....	15	10.5 Motor protection functions in the Basic Application .....	72
<b>5 Installation</b> .....	<b>17</b>	10.5.1 Motor thermal protection .....	72
5.1 Ambient conditions .....	17	10.5.2 Motor stall warning .....	72
5.2 Cooling .....	17	<b>11 System parameter group 0</b> .....	<b>73</b>
5.3 Mounting .....	19	11.1 Parameter table .....	73
<b>6 Wiring</b> .....	<b>23</b>	11.2 Description .....	73
6.1 Power connections .....	26	<b>12 "SVReady™"- application package</b> <b>75</b>	
6.1.1 Utility cable .....	26	12.1 Application selection .....	75
6.1.2 Motor cable .....	26	12.2 Standard Application .....	75
6.1.3 Control cable .....	26	12.3 Local/Remote Application .....	75
6.1.4 Installation instructions .....	29	12.4 Multi-step Speed Application .....	75
6.1.4.1 Cable selection and installation for UL listing ....	31	12.5 PI-control Application .....	76
6.1.5 Cable and motor insulation checks .....	46	12.6 Multi-purpose Control App. ....	76
6.2 Control connections .....	46	12.7 Pump and Fan Control App. ....	76
6.2.1 Control cables .....	46	<b>13 Options</b> .....	<b>77</b>
6.2.2 Galvanic isolation barriers .....	46	13.1 Filters .....	77
6.2.3 Digital input function inversion.	48	13.2 Dynamic braking .....	77
<b>7 SVMulti-line™ panel</b> .....	<b>49</b>	13.3 I/O-expander board .....	77
7.1 Introduction .....	49	13.4 Communications .....	77
7.2 Panel operation .....	50	13.5 SVGraphic™ control panel .....	77
7.3 Monitoring menu .....	51	13.6 SVDive™ .....	77
7.4 Parameter group menu .....	53	13.7 Control panel door mount kit .....	77
		13.8 Protected chassis cable cover for 75-125 Hp open chassis units .....	77



## 1

## 1 SAFETY



**ONLY A QUALIFIED ELECTRICIAN SHOULD  
PERFORM THE ELECTRICAL INSTALLATION**



## 1.1 Warnings

	<p><b>1</b> Internal components and circuit boards (except the isolated I/O terminals) are at utility potential when the SV9000 is connected to the line. This voltage is extremely dangerous and may cause death or severe injury if you come in contact with it.</p>
	<p><b>2</b> When the SV9000 is connected to the utility, the motor connections U(T1), V(T2), W(T3) and DC-link / brake resistor connections -,+ are live even if the motor is not running.</p>
	<p><b>3</b> The control I/O terminals are isolated from the line potential but the relay outputs and other I/O's (if jumper X4 is in OFF position see figure 6.2.2-1) may have dangerous external voltages connected even if the power is disconnected from the SV9000.</p>
	<p><b>4</b> The SV9000 has a large capacitive leakage current.</p>
	<p><b>5</b> An upstream disconnect/protection device is to be used as noted in the National Electric Code (NEC).</p>
	<p><b>6</b> Only spare parts obtained from a Cutler-Hammer authorized distributor can be used.</p>

## 1.2 Safety instructions

	<p><b>1</b> The SV9000 is meant only for fixed installation. Do not make any connections or measurements when the SV9000 is connected to the utility.</p>
	<p><b>2</b> After disconnecting the utility, wait until the unit cooling fan stops and the indicators on the control panel are extinguished (if no keypad is present, check the indicators in the cover). Wait 5 more minutes before doing any work on the SV9000 connections. Do not open the cover before this time has run out.</p>
	<p><b>3</b> Do not make any voltage withstand or megger tests on any part of the SV9000.</p>
	<p><b>4</b> Disconnect the motor cables from the SV9000 before meggering the motor cables.</p>
	<p><b>5</b> Do not touch the IC-circuits on the circuit boards. Static voltage discharge may destroy the components.</p>
	<p><b>6</b> Before connecting to the utility make sure that the cover of the SV9000 is closed</p>
	<p><b>7</b> Make sure that nothing but a three-phase motor is connected to the motor terminal, with the exception of factory recommended filters.</p>



### 1.3 Grounding and ground fault protection

The SV9000 must always be grounded with a grounding conductor connected to the grounding terminal. 

The SV9000's ground fault protection protects only the SV9000 if a ground fault occurs in the motor or in the motor cable.

Due to the high leakage current fault current protective devices do not necessarily operate correctly with drives. When using this type of device its function should be tested in the actual installation.

### Warning Symbols

For your own safety, please pay special attention to the instructions marked with these warning symbols:



= **Dangerous voltage**



= **General warning**

### 1.4 Running the motor

	<b>1</b>	Before running the motor, make sure that the motor is mounted properly.
	<b>2</b>	Maximum motor speed (frequency) should never be set to exceed the motor's and driven machine's capability.
	<b>3</b>	Before reversing the rotation of the motor shaft, make sure that this can be done safely.

## 2 EU-DIRECTIVE

### 2.1 CE-label

The CE-label on the product guarantees the free movement of the product in the EU-area. According to the EU-rules this guarantees that the product is manufactured in accordance with different directives relating to the product.

Cutler-Hammer SV9000s are equipped with the CE-label in accordance with the Low Voltage Directive (LVD) and the EMC directive.

### 2.2 EMC-directive

#### 2.2.1 General

The EMC directive (Electro Magnetic Compatibility) states that the electrical equipment must not disturb the environment and must be immune to other Electro Magnetic Disturbances in the environment.

A Technical Construction File (TCF) exists which demonstrates that the SV9000 drives fulfill the requirements of the EMC directive. A Technical Construction File has been used as a statement of conformity with the EMC directive as it is not possible to test all combinations of installation.

#### 2.2.2 Technical criteria

The design intent was to develop a family of drives, which is user friendly and cost effective, while fulfilling the customer needs. EMC compliance was a major consideration from the outset of the design.

The SV9000 series is targeted at the world market. To ensure maximum flexibility, yet meet the EMC needs of different regions, all drives meet the highest immunity levels, while emission levels are left to the user's choice.

The SV9000 does not include the required EMC filter, which is available as an option. For use within the EU the end user takes personal responsibility for EMC compliance.

#### 2.2.3 EMC-levels

The SV9000-series does not fulfil any EMC emission requirements without an optional RFI-filter, either built-in or separate. With an RFI-filter, the drive fulfils the EMC emission requirements in the heavy industrial environment (standards EN50081-2, EN61800-3).

All products fulfil all EMC immunity requirements (standards EN50082-1,-2, EN61800-3).

#### 2.2.4 Manufacturer's Declaration of Conformity

Manufacturer's Declaration of Conformity are available upon request.



### 3 RECEIVING

This Cutler-Hammer SV9000 drive has been subjected to demanding factory tests before shipment. After unpacking, check that the device does not show any signs of damage and that the SV9000 is as ordered (refer to the model designation code in figure 3-1).

In the event of damage, please contact and file a claim with the carrier involved immediately.

If the received equipment is not the same as ordered, please contact your distributor immediately.

**Note!** Do not destroy the packing. The template printed on the protective cardboard can be used for marking the mounting points of the SV9000 on the wall.



#### 3.1 Catalog Number

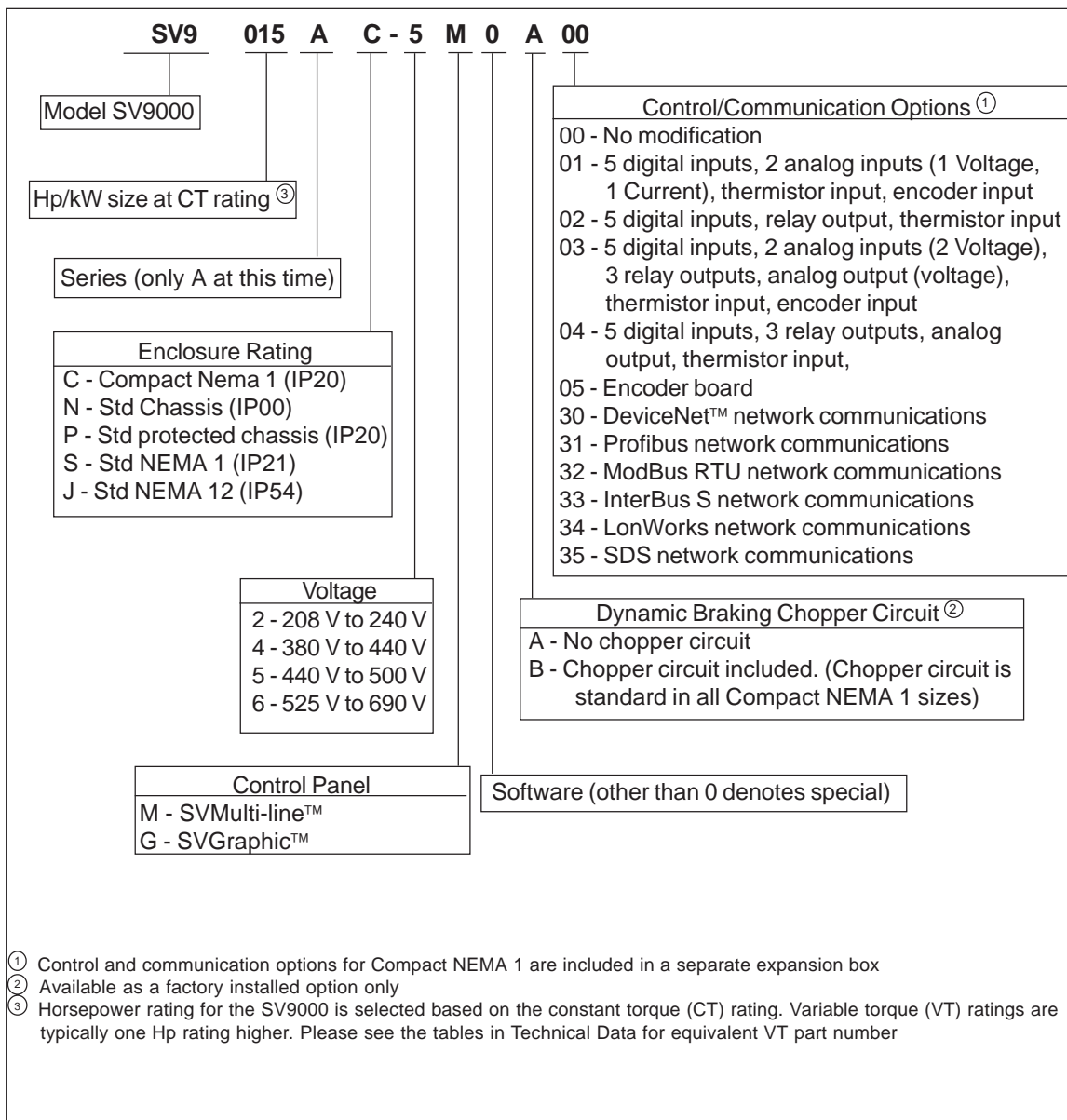

Figure 3-1 Catalog number system.





### 3.2 Storing

If the SV9000 must be stored before installation and startup, check that the ambient conditions in the storage area are acceptable (temperature -40°C - +60°C; (-40°F - + 140°F), relative humidity <95%, no condensation allowed).

## 3

### 3.3 Warranty

This equipment is covered by the Cutler-Hammer standard drive warranty policy.

Cutler-Hammer distributors may have a different warranty period, which is specified in their sales terms and conditions and warranty terms.

If any questions arise concerning the warranty, please contact your distributor.



## 4 TECHNICAL DATA

### 4.1 General

Figure 4-1 shows a block diagram of the SV9000 drive.

The three phase *AC-Choke* with the DC-link capacitor forms an LC filter which together with the *Diode Bridge* produce the DC voltage for the IGBT *Inverter Bridge* block. The AC-Choke smooths the HF-disturbances from the utility to the drive and HF-disturbances caused by the drive to the utility. It also improves the waveform of the input current to the drive.

The IGBT bridge produces a symmetrical three phase pulse width modulated AC voltage to the motor. The power drawn from the supply is almost entirely active power.

The *Motor and Application Control* block is based on microprocessor software. The microprocessor controls the motor according to measured signals, parameter value settings and commands from the *Control I/O* block and the *Control Panel*. The Motor and Application Control block gives commands to the *Motor Control ASIC* which calculates the IGBT switching positions. *Gate Drivers* amplify these signals for driving the IGBT inverter bridge.

The *Control Panel* is a link between the user and the drive. With the panel the user can set parameter values, read status data and give control commands. The panel is removable

and can be mounted externally and connected via a cable to the drive.

The *Control I/O* block is isolated from line potential and is connected to ground via a 1 M $\Omega$  resistor and 4.7 nF capacitor. If needed, the *Control I/O* block can be grounded without a resistor by changing the position of the jumper X4 (GND ON/OFF) on the control board.

The basic *Control* interface and parameters (Basic application) make the inverter easy to operate. If a more versatile interface or parameter settings are needed, an optional application can be selected with one parameter from a "SVReady™" application package. The application package manual describes these in more detail.

An optional *Brake Chopper* can be mounted in the unit at the factory. Optional I/O-expander boards are also available.

Input and Output EMC-filters are not required for the functionality of the drive, they are only required for compliance with the EU EMC-directive.

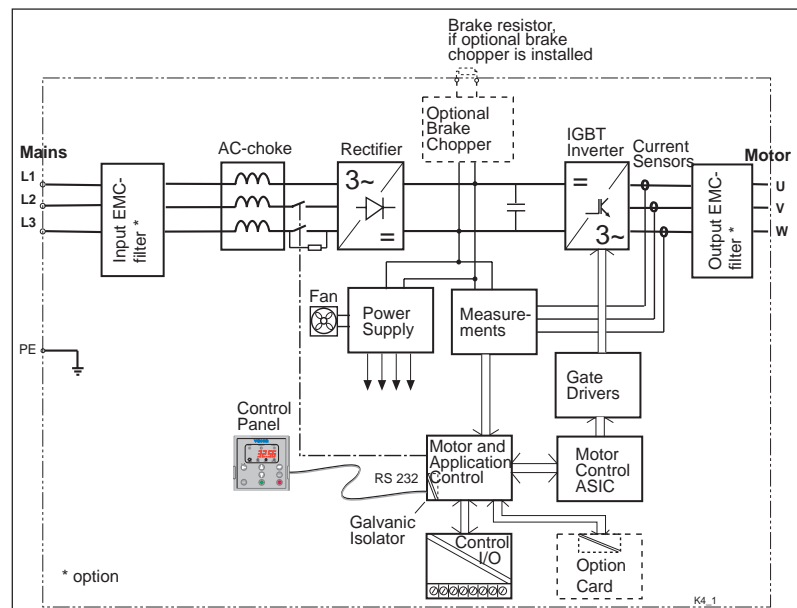

Figure 4-1 SV9000 block diagram.

## 4.2 Power ratings

**200-240 Vac, +10% / -15%, 50/60 Hz, 3 ~ Input COMPACT NEMA 1 (IP20)**

Catalog Number	Rated Horsepower and output current				Frame Size / Enclosure Style	Dimensions W x H x D ( inches )	Weight ( lbs )
	Constant Torque		Variable Torque				
	Hp	Ict *	Hp	Ivt **			
SV9F07AC-2~	0.75	3.6	1	4.7	M3 / Compact NEMA 1	4.7 x 12.0 x 5.9	9.9
SV9F10AC-2~	1	4.7	1.5	5.6			
SV9F15AC-2~	1.5	5.6	2	7			
SV9F20AC-2~	2	7	3	10			
SV9F30AC-2~	3	10	-	-	M4B / Compact NEMA 1	5.3 x 15.4 x 8.1	15.4
SV9F40AC-2~	-	-	5	16			
SV9F50AC-2~	5	16	7.5	22			
SV9F75AC-2~	7.5	22	10	30			
SV9010AC-2~	10	30	15	43	M5B / Compact NEMA 1	7.3 x 22.8 x 8.5	33.1
SV9015AC-2~	15	43	20	57			
SV9020AC-2~	20	57	25	70			

**380 - 440Vac, +10% / -15%, 50/60 Hz, 3 ~ Input COMPACT NEMA 1 (IP20)**

Catalog Number	Rated Kilowatts and output current				Frame Size / Enclosure Style	Dimensions W x H x D ( inches )	Weight ( lbs )
	Constant Torque		Variable Torque				
	kW	Ict *	kW	Ivt **			
SV9F07AC-4~	0.75	2.5	1.1	3.5	M3 / Compact NEMA 1	4.7 x 12.0 x 5.9	9.9
SV9F11AC-4~	1.1	3.5	1.5	4.5			
SV9F15AC-4~	1.5	4.5	2.2	6.5			
SV9F22AC-4~	2.2	6.5	3	8			
SV9F30AC-4~	3	8	4	10	M4B / Compact NEMA 1	5.3 x 15.4 x 8.1	15.4
SV9F40AC-4~	4	10	5.5	13			
SV9F55AC-4~	5.5	13	7.5	18			
SV9F75AC-4~	7.5	18	11	24			
SV9011AC-4~	11	24	15	32	M5B / Compact NEMA 1	7.3 x 22.8 x 8.5	33.1
SV9015AC-4~	15	32	18.5	42			
SV9018AC-4~	18.5	42	22	48			
SV9022AC-4~	22	48	30	60			

**440 - 500Vac, +10% / -15%, 50/60 Hz, 3 ~ Input COMPACT NEMA 1 (IP20)**

Catalog Number	Rated Horsepower and output current				Frame Size / Enclosure Style	Dimensions W x H x D ( inches )	Weight ( lbs )
	Constant Torque		Variable Torque				
	Hp	Ict *	Hp	Ivt **			
SV9F10AC-5~	1	2.5	1.5	3	M3 / Compact NEMA 1	4.7 x 12.0 x 5.9	9.9
SV9F15AC-5~	1.5	3	2	3.5			
SV9F20AC-5~	2	3.5	3	5			
SV9F30AC-5~	3	5	-	-			
SV9F40AC-5~	-	-	5	8	M4B / Compact NEMA 1	5.3 x 15.4 x 8.1	15.4
SV9F50AC-5~	5	8	7.5	11			
SV9F75AC-5~	7.5	11	10	15			
SV9010AC-5~	10	15	15	21			
SV9015AC-5~	15	21	20	27	M5B / Compact NEMA 1	7.3 x 22.8 x 8.5	33.1
SV9020AC-5~	20	27	25	34			
SV9025AC-5~	25	34	30	40			
SV9030AC-5~	30	40	40	52			

\* Ict = continuous rated input and output current ( constant torque load, max 50C ambient )

\*\* Ivt = continuous rated input and output current ( variable torque load, max 40C ambient )



<b>200-240 Vac, +10% / -15%. 50/60 Hz. 3 ~ Input Protected Chassis/ Chassis (IP20/IP00)</b>							
Catalog Number	Rated Horsepower and output current				Frame Size / Enclosure Style	Dimensions W x H x D ( inches )	Weight ( lbs )
	Constant Torque		Variable Torque				
	Hp	lct *	Hp	lvt **			
SV9F20AP-2~	2	7	3	10	M4 / Protected	4.7 x 11.4 x 8.5	15.4
SV9F30AP-2~	3	10	-	-			
SV9F40AP-2~	-	-	5	16	M5 / Protected	6.2 x 15.9 x 9.4	33.1
SV9F50AP-2~	5	16	7.5	22			
SV9F75AP-2~	7.5	22	10	30			
SV9010AP-2~	10	30	15	43			
SV9015AP-2~	15	43	20	57			
SV9020AP-2~	20	57	25	70	M6 / Protected	8.7 x 20.7 x 11.4	77.2
SV9025AP-2~	25	70	30	83			
SV9030AP-2~	30	83	40	113			
SV9040AN-2~	40	113	50	139	M7 / Chassis***	9.8 x 31.5 x 12.4	135
SV9050AN-2~	50	139	60	165			
SV9060AN-2~	60	165	75	200			
SV9075AN-2~	75	200	100	264			
					M8 / Chassis***	19.5 x 35 x 13.9	300

<b>200-240 Vac, +10% / -15%, 50/60 Hz, 3 ~ Input NEMA 1 (IP21)</b>							
Catalog Number	Rated Horsepower and output current				Frame Size / Enclosure Style	Dimensions W x H x D ( inches )	Weight ( lbs )
	Constant Torque		Variable Torque				
	Hp	lct *	Hp	lvt **			
SV9F20AS-2~	2	7	3	10	M4 / NEMA 1	4.7 x 15.4 x 8.5	17.6
SV9F30AS-2~	3	10	-	-			
SV9F40AS-2~	-	-	5	16	M5 / NEMA 1	6.2 x 20.3 x 9.4	35.3
SV9F50AS-2~	5	16	7.5	22			
SV9F75AS-2~	7.5	22	10	30			
SV9010AS-2~	10	30	15	43			
SV9015AS-2~	15	43	20	57			
SV9020AS-2~	20	57	25	70	M6 / NEMA 1	8.7 x 25.6 x 11.4	84
SV9025AS-2~	25	70	30	83			
SV9030AS-2~	30	83	40	113			
SV9040AS-2~	40	113	50	139			
SV9050AS-2~	50	139	60	165	M7 / NEMA 1	14.7 x 39.4 x 13	180
SV9060AS-2~	60	165	75	200			
SV9075AS-2~	75	200	100	264			
					M8 / NEMA 1	19.5 x 50.8 x 14	337

<b>200-240 Vac, +10% / -15%, 50/60 Hz, 3 ~ Input NEMA 12 (IP54)</b>							
Catalog Number	Rated Horsepower and output current				Frame Size / Enclosure Style	Dimensions W x H x D ( inches )	Weight ( lbs )
	Constant Torque		Variable Torque				
	Hp	lct *	Hp	lvt **			
SV9F20AJ-2~	2	7	3	10	M4 / NEMA 12	4.7 x 15.4 x 8.5	17.6
SV9F30AJ-2~	3	10	-	-			
SV9F40AJ-2~	-	-	5	16	M5 / NEMA 12	6.2 x 20.3 x 9.4	35.3
SV9F50AJ-2~	5	16	7.5	22			
SV9F75AJ-2~	7.5	22	10	30			
SV9010AJ-2~	10	30	15	43			
SV9015AJ-2~	15	43	20	57			
SV9020AJ-2~	20	57	25	70	M6 / NEMA 12	8.7 x 25.6 x 11.4	84
SV9025AJ-2~	25	70	30	83			
SV9030AJ-2~	30	83	40	113			
SV9040AJ-2~	40	113	50	139	M7 / NEMA 12	14.7 x 39.4 x 13	180
SV9050AJ-2~	50	139	60	165			
SV9060AJ-2~	60	165	75	200			
SV9075AJ-2~	75	200	100	264			
					M8 / NEMA 12	19.5 x 50.8 x 14	337

\* lct = continuous rated input and output current ( constant torque load. max 50C ambient )  
\*\* lvt = continuous rated input and output current ( variable torque load. max 40C ambient )  
\*\*\* Protected Enclosure with Option



<b>380 - 440Vac, +10% / -15%, 50/60 Hz, 3 ~ Input Protected Chassis/Chassis (IP20/IP00)</b>							
Catalog Number	Rated Kilowatts and output current				Frame Size / Enclosure Style	Dimensions W x H x D ( inches )	Weight ( lbs )
	Constant Torque		Variable Torque				
	kW	I <sub>ct</sub> *	kW	I <sub>vt</sub> **			
SV9F22AP-4~	2.2	6.5	3	8	M4 / Protected	4.7 x 11.4 x 8.5	15.4
SV9F30AP-4~	3	8	4	10			
SV9F40AP-4~	4	10	5.5	13			
SV9F55AP-4~	5.5	13	7.5	18			
SV9F75AP-4~	7.5	18	11	24	M5 / Protected	6.2 x 15.9 x 9.4	33.1
SV9011AP-4~	11	24	15	32			
SV9015AP-4~	15	32	18.5	42			
SV9018AP-4~	18.5	42	22	48	M6 / Protected	8.7 x 20.7 x 11.4	77.2
SV9022AP-4~	22	48	30	60			
SV9030AP-4~	30	60	37	75			
SV9037AP-4~	37	75	45	90			
SV9045AP-4~	45	90	55	110			
SV9055AN-4~	55	110	75	150			
SV9075AN-4~	75	150	90	180	M7 / Chassis ***	9.8 x 31.5 x 12.4	133
SV9090AN-4~	90	180	110	210			
SV9110AN-4~	110	210	132	270			
SV9132AN-4~	132	270	160	325	M8 / Chassis ***	19.5 x 35.0 x 13.9	309
SV9160AN-4~	160	325	200	410			
SV9200AN-4~	200	410	250	510	M9 / Chassis ***	27.6 x 39.4 x 15.4	485
SV9250AN-4~	250	510	315	580			
SV9315AN-4~	315	600	400	750	M10 / Chassis	38.9 x 39.4 x 15.4	684
SV9400AN-4~	400	750	500	840	M11 / Chassis	55.1 x 39.4 x 15.4	948
SV9500AN-4~	500	840	630	1050			
SV9630AN-4~	630	1050	710	1160			
SV9710AN-4~	710	1270	800	1330			
SV9800AN-4~	800	1330	900	1480			
SV9900AN-4~	900	1480	-	-			
SV9H10AN-4~	1000	1600	-	-	M12 / Chassis	77.9 x 39.4 x 15.4	1212

\* I<sub>ct</sub> = continuous rated input and output current ( constant torque load, max 50C ambient )  
\*\* I<sub>vt</sub> = continuous rated input and output current ( variable torque load, max 40C ambient )  
\*\*\* Protected Enclosure with Option

4





<b>380 - 440Vac, +10% / -15%, 50/60 Hz, 3 ~ Input NEMA 1 (IP21)</b>							
Catalog Number	Rated Kilowatts and output current				Frame Size / Enclosure Style	Dimensions W x H x D ( inches )	Weight ( lbs )
	Constant Torque		Variable Torque				
	kW	Ict *	kW	Ivt **			
SV9F22AS-4~	2.2	6.5	3	8	M4 / NEMA 1	4.7 x 15.4 x 8.5	17.6
SV9F30AS-4~	3	8	4	10			
SV9F40AS-4~	4	10	5.5	13			
SV9F55AS-4~	5.5	13	7.5	18			
SV9F75AS-4~	7.5	18	11	24	M5 / NEMA 1	6.2 x 20.3 x 9.4	35.3
SV9011AS-4~	11	24	15	32			
SV9015AS-4~	15	32	18.5	42			
SV9018AS-4~	18.5	42	22	48			
SV9022AS-4~	22	48	30	60	M6 / NEMA 1	8.7 x 25.6 x 11.4	84
SV9030AS-4~	30	60	37	75			
SV9037AS-4~	37	75	45	90			
SV9045AS-4~	45	90	55	110			
SV9055AS-4~	55	110	75	150	M7 / NEMA 1	14.7 x 39.4 x 13.0	221
SV9075AS-4~	75	150	90	180			
SV9090AS-4~	90	180	110	210			
SV9110AS-4~	110	210	132	270			
SV9132AS-4~	132	270	160	325	M8 / NEMA 1	19.5 x 47.6 x 13.9	309
SV9160AS-4~	160	325	200	410			
SV9200AS-4~	200	410	250	510			
SV9250AS-4~	250	510	315	580			
SV9315AS-4~	315	600	400	750	M9 / NEMA 1	27.6 x 56.1 x 15.4	574
SV9400AS-4~	400	750	500	840			
Contact Factory							

<b>380 - 440Vac, +10% / -15%, 50/60 Hz, 3 ~ Input NEMA 12 (IP54)</b>							
Catalog Number	Rated Kilowatts and output current				Frame Size / Enclosure Style	Dimensions W x H x D ( inches )	Weight ( lbs )
	Constant Torque		Variable Torque				
	kW	Ict *	kW	Ivt **			
SV9F22AJ-4~	2.2	6.5	3	8	M4 / NEMA 12	4.7 x 15.4 x 8.5	17.6
SV9F30AJ-4~	3	8	4	10			
SV9F40AJ-4~	4	10	5.5	13			
SV9F55AJ-4~	5.5	13	7.5	18			
SV9F75AJ-4~	7.5	18	11	24	M5 / NEMA 12	6.2 x 20.3 x 9.4	35.3
SV9011AJ-4~	11	24	15	32			
SV9015AJ-4~	15	32	18.5	42			
SV9018AJ-4~	18.5	42	22	48			
SV9022AJ-4~	22	48	30	60	M6 / NEMA 12	8.7 x 25.6 x 11.4	84
SV9030AJ-4~	30	60	37	75			
SV9037AJ-4~	37	75	45	90			
SV9045AJ-4~	45	90	55	110			
SV9055AJ-4~	55	110	75	150	M7 / NEMA 12	14.7 x 39.4 x 13.0	221
SV9075AJ-4~	75	150	90	180			
SV9090AJ-4~	90	180	110	210			
SV9110AJ-4~	110	210	132	270			
SV9132AJ-4~	132	270	160	325	M8 / NEMA 12	19.5 x 47.6 x 13.9	309
SV9160AJ-4~	160	325	200	410			
SV9200AJ-4~	200	410	250	510			
SV9250AJ-4~	250	510	315	580			
SV9315AJ-4~	315	600	400	750	M9 / NEMA 12	27.6 x 56.1 x 15.4	574
SV9400AJ-4~	400	750	500	840			
Contact Factory							
* Ict = continuous rated input and output current ( constant torque load, max 50C ambient )							
** Ivt = continuous rated input and output current ( variable torque load, max 40C ambient )							



<b>440 - 500Vac, +10% / -15%, 50/60 Hz, 3 ~ Input Protected Chassis/Chassis (IP20/IP00)</b>							
Catalog Number	Rated Horsepower and output current				Frame Size / Enclosure Style	Dimensions W x H x D ( inches )	Weight ( lbs )
	Constant Torque		Variable Torque				
	Hp	Ict *	Hp	Ivt **			
SV9F30AP-5~	3	5	-	-	M4 / Protected	4.7 x 11.4 x 8.5	15.4
SV9F40AP-5~	-	-	5	8			
SV9F50AP-5~	5	8	7.5	11			
SV9F75AP-5~	7.5	11	10	15			
SV9010AP-5~	10	15	15	21	M5 / Protected	6.2 x 15.9 x 9.4	33.1
SV9015AP-5~	15	21	20	27			
SV9020AP-5~	20	27	25	32			
SV9025AP-5~	25	34	30	40			
SV9030AP-5~	30	40	40	52	M6 / Protected	8.7 x 20.7 x 11.4	77.2
SV9040AP-5~	40	52	50	65			
SV9050AP-5~	50	65	60	77			
SV9060AP-5~	60	77	75	96			
SV9075AN-5~	75	96	100	125			
SV9100AN-5~	100	125	125	160			
SV9125AN-5~	125	160	150	180	M7 / Chassis ***	9.8 x 31.5 x 12.4	133
SV9150AN-5~	150	180	-	-			
SV9175AN-5~	-	-	200	260	M8 / Chassis ***	19.5 x 35.0 x 13.9	309
SV9200AN-5~	200	260	250	320			
SV9250AN-5~	250	320	300	400	M9 / Chassis ***	27.6 x 39.4 x 15.4	485
SV9300AN-5~	300	400	400	460			
SV9400AN-5~	400	480	500	600	M10 / Chassis	38.9 x 39.4 x 15.4	684
SV9500AN-5~	500	600	600	672			
SV9600AN-5~	600	700	700	880	M11 / Chassis	55.1 x 39.4 x 15.4	948
SV9700AN-5~	700	880	800	1020			
SV9800AN-5~	800	1020	900	1070	M12 / Chassis	77.9 x 39.4 x 15.4	1212
SV9900AN-5~	900	1070	1000	1200			
SV9H10AN-5~	1000	1200	-	-			
SV9H11AN-5~	1100	1300	-	-			

\* Ict = rated input and output current ( constant torque load, max 50C ambient )  
\*\* Ivt = rated input and output current ( variable torque load, max 40C ambient )  
\*\*\* Protected Enclosure with Optional Cover



<b>440 - 500Vac, +10% / -15%, 50/60 Hz, 3 ~ Input NEMA 1 (IP21)</b>							
Catalog Number	Rated Horsepower and output current				Frame Size / Enclosure Style	Dimensions W x H x D ( inches )	Weight ( lbs )
	Constant Torque		Variable Torque				
	Hp	Ict *	Hp	Ivt **			
SV9F30AS-5~	3	5	-	-	M4 / NEMA 1	4.7 x 15.4 x 8.5	17.6
SV9F40AS-5~	-	-	5	8			
SV9F50AS-5~	5	8	7.5	11			
SV9F75AS-5~	7.5	11	10	15			
SV9010AS-5~	10	15	15	21	M5 / NEMA 1	6.2 x 20.3 x 9.4	35.3
SV9015AS-5~	15	21	20	27			
SV9020AS-5~	20	27	25	32			
SV9025AS-5~	25	34	30	40	M6 / NEMA 1	8.7 x 25.6 x 11.4	83.8
SV9030AS-5~	30	40	40	52			
SV9040AS-5~	40	52	50	65			
SV9050AS-5~	50	65	60	77			
SV9060AS-5~	60	77	75	96			
SV9075AS-5~	75	96	100	125	M7 / NEMA 1	14.7 x 39.4 x 13.0	221
SV9100AS-5~	100	125	125	160			
SV9125AS-5~	125	160	150	180			
SV9150AS-5~	150	180	-	-	M8 / NEMA 1	19.5 x 47.6 x 13.9	309
SV9175AS-5~	-	-	200	260			
SV9200AS-5~	200	260	250	320			
SV9250AS-5~	250	320	300	400	M9 / NEMA 1	27.6 x 56.1 x 15.4	574
SV9300AS-5~	300	400	400	460			
SV9400AS-5~	400	480	500	600			
SV9500AS-5~	500	600	600	672	Contact Factory		

<b>440 - 500Vac, +10% / -15%, 50/60 Hz, 3 ~ Input NEMA 12 (IP54)</b>							
Catalog Number	Rated Horsepower and output current				Frame Size / Enclosure Style	Dimensions W x H x D ( inches )	Weight ( lbs )
	Constant Torque		Variable Torque				
	Hp	Ict *	Hp	Ivt **			
SV9F30AJ-5~	3	5	-	-	M4 / NEMA 12	4.7 x 15.4 x 8.5	17.6
SV9F40AJ-5~	-	-	5	8			
SV9F50AJ-5~	5	8	7.5	11			
SV9F75AJ-5~	7.5	11	10	15			
SV9010AJ-5~	10	15	15	21	M5 / NEMA 12	6.2 x 20.3 x 9.4	35.3
SV9015AJ-5~	15	21	20	27			
SV9020AJ-5~	20	27	25	32			
SV9025AJ-5~	25	34	30	40	M6 / NEMA 12	8.7 x 25.6 x 11.4	83.8
SV9030AJ-5~	30	40	40	52			
SV9040AJ-5~	40	52	50	65			
SV9050AJ-5~	50	65	60	77			
SV9060AJ-5~	60	77	75	96			
SV9075AJ-5~	75	96	100	125	M7 / NEMA 12	14.7 x 39.4 x 13.0	221
SV9100AJ-5~	100	125	125	160			
SV9125AJ-5~	125	160	150	180			
SV9150AJ-5~	150	180	-	-	M8 / NEMA 12	19.5 x 47.6 x 13.9	309
SV9175AJ-5~	-	-	200	260			
SV9200AJ-5~	200	260	250	320			
SV9250AJ-5~	250	320	300	400	M9 / NEMA 12	27.6 x 56.1 x 15.4	574
SV9300AJ-5~	300	400	400	460			
SV9400AJ-5~	400	480	500	600			
SV9500AJ-5~	500	600	600	672	Contact Factory		

\* Ict = continuous rated input and output current ( constant torque load, max 50C ambient )  
\*\* Ivt = continuous rated input and output current ( variable torque load, max 40C ambient )



<b>525 - 600Vac, +10% / -15%, 50/60 Hz, 3 ~ Input Nema 1/ Protected Chassis (IP20/IP20)</b>							
Catalog Number	Rated Horsepower and output current				Frame Size / Enclosure Style	Dimensions W x H x D ( inches )	Weight ( lbs )
	Constant Torque		Variable Torque				
	Hp	Ict *	Hp	Ivt **			
SV9F20AP-6~	2	3.5	3	4.5	M5 / Nema 1	6.2 x 17.3 x 10.4	33.1
SV9F30AP-6~	3	4.5	-	-			
SV9F40AP-6~	-	-	5	7.5			
SV9F50AP-6~	5	7.5	7.5	10			
SV9F75AP-6~	7.5	10	10	14			
SV9010AP-6~	10	14	15	19			
SV9015AP-6~	15	19	20	23			
SV9020AP-6~	20	23	25	26			
SV9025AP-6~	25	26	30	35			
SV9030AP-6~	30	35	40	42			
SV9040AP-6~	40	42	50	52			
SV9050AP-6~	50	52	60	62			
SV9060AP-6~	60	62	75	85			
SV9075AP-6~	75	85	100	100			
SV9100AN-6~	100	100	125	122	M8 / Chassis ***	19.5 x 35.0 x 13.9	300
SV9125AN-6~	125	122	150	145			
SV9150AN-6~	150	145	-	-			
SV9175AN-6~	-	-	200	222			
SV9200AN-6~	200	222	250	287	M10 / Chassis	38.9 x 39.4 x 15.4	602
SV9250AN-6~	250	287	300	325			
SV9300AN-6~	300	325	400	390			
SV9400AN-6~	400	400	500	490	M12 / Chassis	77.9 x 39.4 x 15.4	1213
SV9500AN-6~	500	490	600	620			
SV9600AN-6~	600	620	700	700			
SV9700AN-6~	700	700	-	-			
SV9800AN-6~	800	780	-	-			

\* Ict = rated input and output current ( constant torque load, max 50C ambient )  
 \*\* Ivt = rated input and output current ( variable torque load, max 40C ambient )  
 \*\*\* Protected Enclosure with Option



## 4.3 Specifications

<b>Utility connection</b>	Input voltage $V_{in}$	200-240V, 380—440V, 440—500V, 525—690V; -15%—+10%	
	Input frequency	45—66 Hz	
<b>Motor Connection</b>	Output voltage	0 — $V_{in}$	
	Continuous output current	$I_{CT}$ : ambient max +50°C, overload 1.5 x $I_{CT}$ (1min/10 min) $I_{VT}$ : ambient max +40°C, 1.1 x $I_{VT}$ (1min/10 min)	
	Starting torque	200%	
	Starting current	2.5 x $I_{CT}$ : 2 s every 20 s if output frequency <30 Hz and if the heatsink temperature <+60°C	
	Output frequency	0—500 Hz	
	Frequency resolution	0.01 Hz	
	<b>Control characteristics</b>	Control method	Frequency Control (V/Hz) Open Loop Sensorless Vector Control Closed Loop Vector Control
Switching frequency		1—16 kHz (depending on horsepower rating)	
Frequency reference		Analog I/P	Resolution 12 bit, accuracy $\pm 1\%$
		Panel refer.	Resolution 0.01 Hz
Field weakening point		30—500 Hz	
Acceleration time		0.1—3000 s	
Deceleration time		0.1—3000 s	
Braking torque		DC brake: 30%* $T_N$ (without brake option)	
<b>Environmental limits</b>	Ambient operating temperature	-10 (no frost)—+50°C at $I_{CT}$ , (1.5 x $I_{CT}$ max 1min/10min) -10 (no frost)—+40°C at $I_{VT}$ , (1.1 x $I_{CT}$ max 1min/10 min)	
	Storage temperature	-40°C—+60°C	
	Relative humidity	<95%, no condensation allowed	
	Air quality		
	- chemical vapors	IEC 721-3-3, unit in operation, class 3C2	
	- mechanical particles	IEC 721-3-3, unit in operation, class 3S2	
	Altitude	1000m (3300 ft) maximum without derating.	
	Vibration (IEC 721-3-3)	Operation: max displacement amplitude 3 mm at 2—9 Hz, Max acceleration amplitude 0.5 G at 9—200 Hz	
	Shock (IEC 68-2-27)	Operation: max 8 G, 11 ms Storage and shipping: max 15 G, 11 ms (in the package)	
	Enclosure	Protected Chassis (IP20) and Chassis (IP20) Compact NEMA 1 (IP20) NEMA 1 (IP21) NEMA 12 (IP54)	

Table 4.3-1 Specifications





<b>EMC</b>	Noise immunity	Fulfils EN50082-1,-2 , EN61800-3
	Emissions	Equipped with an optional external RFI-Filter fulfils EN50081-2 , EN61800-3
<b>Safety</b>		Fulfils EN50178, EN60204 -1,CE, UL, C-UL, FI, GOST R (check from the unit nameplate specified approvals for each unit)
<b>Control connections</b>	Analog voltage	0—+10 V, $R_i = 200 \text{ k}\Omega$ , single ended (-10—+10V , joystick control), resolution 12 bit, accur. $\pm 1\%$
	Analog current	0 (4) — 20 mA, $R_i = 250 \text{ }\Omega$ , differential
	Digital inputs (6)	Positive or negative logic
	Aux. voltage	+24 V $\pm 20\%$ , max 100 mA
	Pot. meter reference	+10 V -0% — +3%, max 10 mA
	Analog output	0 (4) — 20 mA, $R_L < 500 \text{ }\Omega$ , resolution 10 bit, accur. $\pm 3\%$
	Digital output	Open collector output, 50 mA/48 V
	Relay outputs	Max switching voltage: 300 V DC, 250 V AC Max switching load: 8A / 24 V 0.4 A / 250 V DC 2 kVA / 250 V AC Max continuous load: 2 A rms
<b>Protective functions</b>	Overcurrent protection	Trip limit $4 \times I_{CT}$
	Overvoltage protection	Utility voltage: 220 V, 230 V, 240 V, 380 V, 400 V Trip limit: $1.47 \times V_n$ , $1.41 \times V_n$ , $1.35 \times V_n$ , $1.47 \times V_n$ , $1.40 \times V_n$
		Utility voltage: 415 V, 440 V, 460 V, 480 V, 500 V Trip limit: $1.35 \times V_n$ , $1.27 \times V_n$ , $1.47 \times V_n$ , $1.41 \times V_n$ , $1.35 \times V_n$
		Utility voltage: 525 V, 575 V, 600 V, 660 V, 690 V Trip limit: $1.77 \times V_n$ , $1.62 \times V_n$ , $1.55 \times V_n$ , $1.41 \times V_n$ , $1.35 \times V_n$
	Undervoltage protection	Trip limit $0.65 \times V_n$
	Ground-fault protection	Protects the inverter from an ground-fault in the output (motor or motor cable)
	Utility supervision	Trip if any of the input phases is missing
	Motor phase supervision	Trip if any of the output phases is missing
	Unit over temperature protection	Yes
	Motor overload protection	Yes
Stall protection	Yes	
Motor underload protection	Yes	
Short-circuit protection of +24V and +10V reference voltages	Yes	

Table 4.3-1 Specifications.



## 5 INSTALLATION

### 5.1 Ambient conditions

The environmental limits mentioned in table 4.3-1 must not be exceeded.

### 5.2 Cooling

The specified space around the drive ensures proper cooling air circulation. See table 5.2-1 for dimensions. If multiple units are to be installed above each other, the dimensions must be b+c and air from the outlet of the lower unit must be directed away from the inlet of the upper unit.

With high switching frequencies and high ambient temperatures the maximum continuous output current has to be derated according to Table 5.2-3 and Figures 5.2-3 a-d.

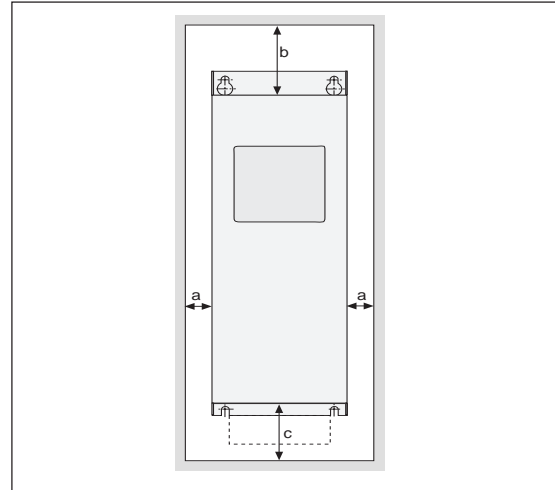

Figure 5.2-1 Installation space.

Frame Size / Enclosure Style	Dimensions ( in )			
	a	a2	b	c
M3 / Compact NEMA 1	1	0.5	4	2
M4 / Protected & NEMA 12				
M4 / NEMA 1	1	1	4	2
M4B / M5B Compact NEMA 1	1	0.5	5	2.5
M5 / Protected & NEMA 12				
M5 / NEMA 1	1	1	5	2.5
M6 / Protected & NEMA 12	1.5	4	6.5	3.5
M6 / NEMA 1	1.5	1.5	6.5	3.5
M7 / Chassis* & NEMA 12	3 ( 1.5 )**	3 ( 2.5 )**	12	4
M7 / NEMA 1				
M8 / Chassis* & NEMA 12	10*** ( 3 )**	3	12	
M8 / NEMA 1				
M9 / Chassis* & NEMA 12	8*** ( 3 )**	3	12	
M9 / NEMA 1				
M10 / Chassis & NEMA 12	8*** ( 3 )**	3	12	
M10 / NEMA 1				
M11 / Chassis & NEMA 12	Contact Factory			
M11 / NEMA 1				
M12 / Chassis & NEMA 12				
M12 / NEMA 1				
a2 - Distance from inverter to inverter in multiple inverter installations				
* - Protected enclosure with optional cover.				
** - Minimum allowable space - No space available for fan change.				
*** - Space for fan change on sides of inverter.				

Table 5.2 -1 Installation space dimensions.

Hp ( KW )	Voltage / Enclosure	Required Airflow ( CFM )
0.75 - 2	230 / Compact NEMA 1	42
2 - 3	230 / Protected & NEMA 1 / 12	
( 0.75 - 5.5 )	380 / Compact NEMA 1	
( 2.2 - 7.5 )	380 / Protected & NEMA 1/12	
1 - 7.5	480 / Compact NEMA 1	
3 - 10	480 / Protected & NEMA 1/12	
2 - 15	600 / Protected	100
3 - 15	230 / Compact NEMA 1	
5 - 10	230 / Protected & NEMA 1 / 12	
( 7.5 - 18.5 )	380 / Compact NEMA 1	
( 11 - 30 )	380 / Protected & NEMA 1/12	
10 - 25	480 / Compact NEMA 1	
15 - 40	480 / Protected & NEMA 1/12	218
20 - 60	600 / Protected	
20	230 / Compact NEMA 1	
15 - 30	230 / Protected & NEMA 1 / 12	
( 22 )	380 / Compact NEMA 1	
30	480 / Compact NEMA 1	
( 37 - 45 )	380 / Protected & NEMA 1/12	383
50 - 60	480 / Protected & NEMA 1/12	
75	600 / Protected	
40 - 75	230 / Chassis* & NEMA 1 / 12	
( 55 - 90 )	380 / Chassis* & NEMA 1/12	
75 - 125	480 / Chassis* & NEMA 1/12	
( 110 - 160 )	380 / Chassis* & NEMA 1/12	765
150 - 200	480 / Chassis* & NEMA 1/12	
100 - 150	600 / Chassis*	
( 200 - 250 )	380 / Chassis* & NEMA 1/12	
250 - 300	480 / Chassis* & NEMA 1/12	
175 - 200	600 / Chassis*	
( 315 - 400 )	380 / Chassis & NEMA 1/12	1148
400 - 500	480 / Chassis & NEMA 1/12	
250 - 300	600 / Chassis*	
( 500 )	380 / Chassis	
600	480 / Chassis	
400	600 / Chassis	
( 630 - 1000 )	380 / Chassis	1736
700 - 1100	480 / Chassis	
500 - 800	600 / Chassis	
( 500 )	380 / Chassis	
600	480 / Chassis	
400	600 / Chassis	
( 630 - 1000 )	380 / Chassis	2296
700 - 1100	480 / Chassis	
500 - 800	600 / Chassis	
( 500 )	380 / Chassis	
600	480 / Chassis	
400	600 / Chassis	
( 630 - 1000 )	380 / Chassis	3473
700 - 1100	480 / Chassis	
500 - 800	600 / Chassis	
( 500 )	380 / Chassis	
600	480 / Chassis	
400	600 / Chassis	
* Protected enclosure with optional cover.		

Table 5.2-2 Required cooling air.



5

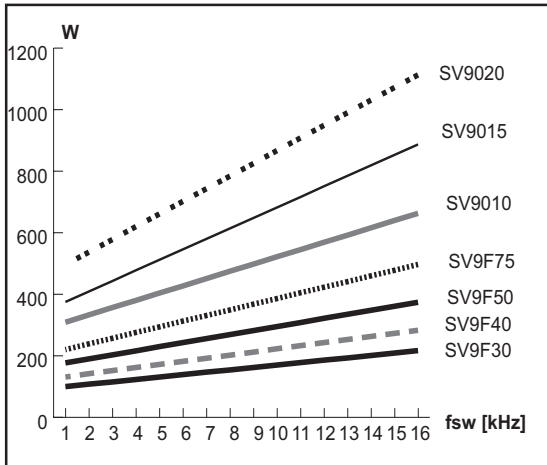

Figure 5.2-2a 3 - 20 hp

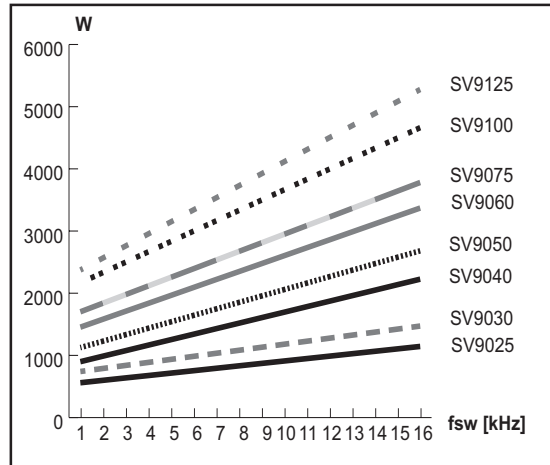

Figure 5.2-2b 25-125 HP

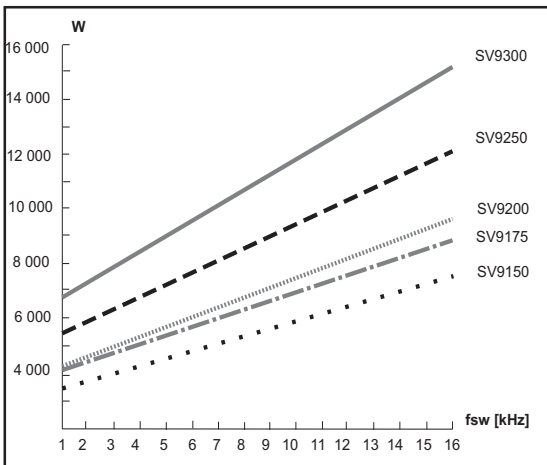

Figure 5.2-2c 150 - 300 HP

Figures 5.2-2a—c Power dissipation as a function of the switching frequency for 400V and 500V ( $I_{VT}$  variable torque) for standard enclosures

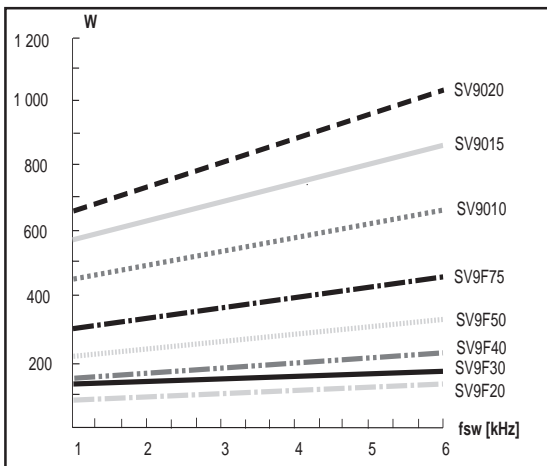

Figure 5.2-2d 2 - 20 HP

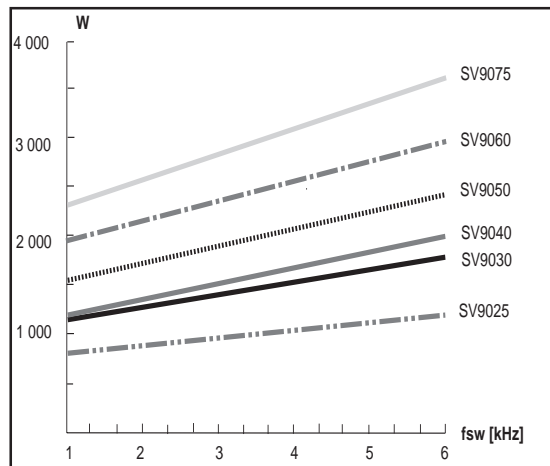

Figure 5.2-2e 25 - 75 HP

Figures 5.2-2d—e: Power dissipation as a function of the switching frequency for 230 V ( $I_{VT}$  variable torque) for standard enclosures.



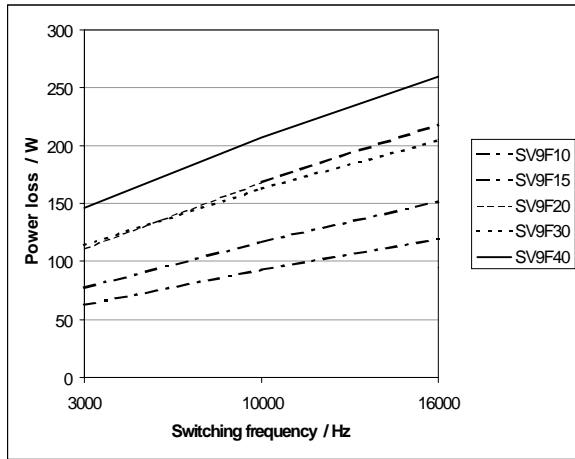

Figure 5.2-2f

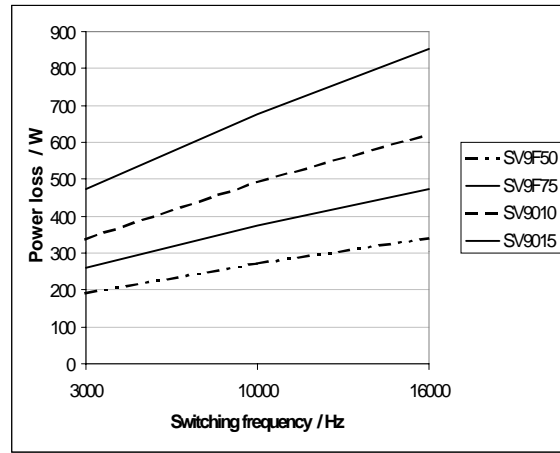

Figure 5.2-2g

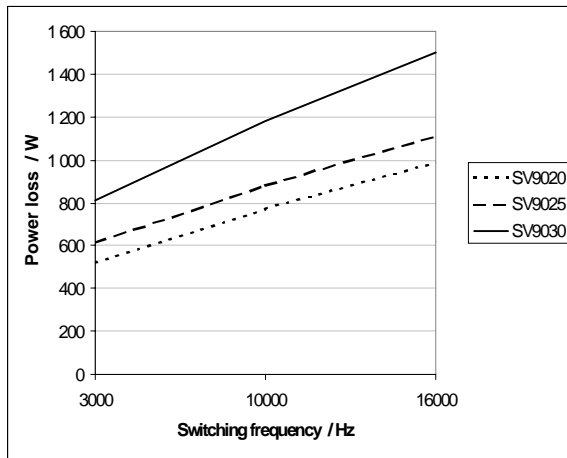

Figure 5.2-2h

Figures 5.2-2 f—h: Power dissipation as a function of the switching frequency for 400V and 500V ( $I_{VT}$  variable torque), Compact Nema 1.



5

Type (HP)	Curve		
	3.6kHz	10kHz	16kHz
1-5	no derating	no derating	no derating
7.5	no derating	1	2
10	no derating	no derating	no derating
15	no derating	no derating	no derating
20	no derating	no derating	3
25	no derating	no derating	no derating
30	no derating	no derating	4
40	no derating	5	not allowed
50	no derating	6	not allowed
60	7	8	not allowed
75	no derating	9	not allowed
100	no derating	10	not allowed
125	11	12	not allowed
150	no derating	13	not allowed
175	no derating	14	not allowed
200	15	16	not allowed
250	no derating	17	not allowed
300	18	19	not allowed
400	*	*	*
500	*	*	*
600	*	*	*
700	*	*	*
800	*	*	*
900	*	*	*
1000	*	*	*
1100	*	*	*

Table 5.2-3 Constant output current derating curves for 400—500 V ( $I_{VT}$ , variable torque).

\* = Ask the details from the factory

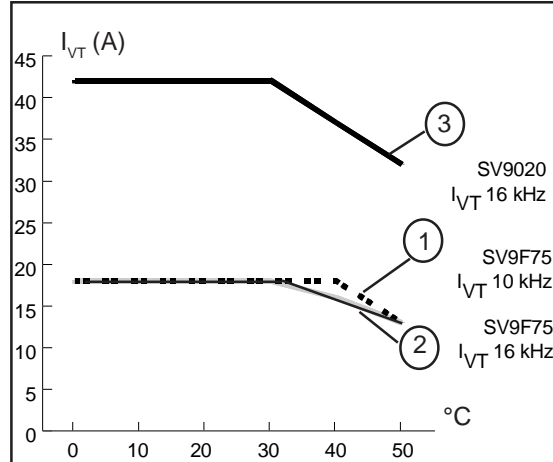

Figure 5.2.3 a

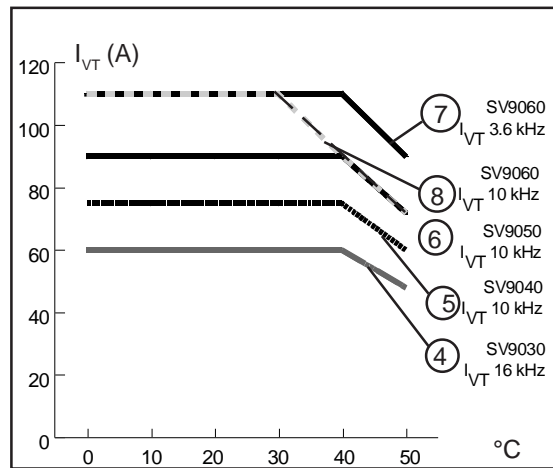

Figure 5.2.3 b

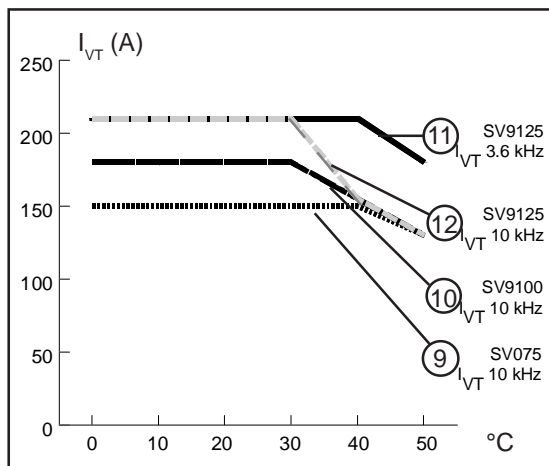

Figure 5.2.3 c

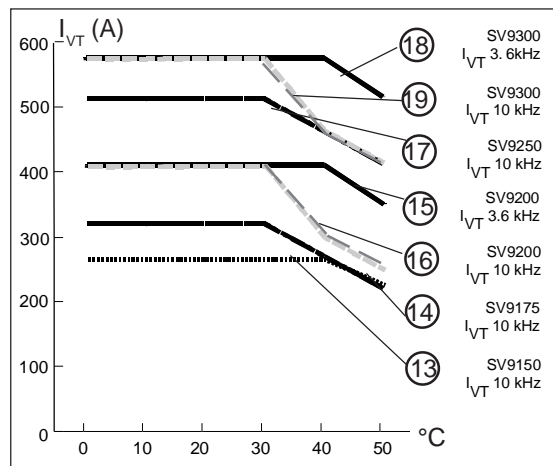

Figure 5.2.3 d

Figure 5.2-3a—d: Constant output current ( $I_{VT}$ ) derating curves as a function of ambient temperature and switching frequency.





**5.3 Mounting**

The SV9000 should be mounted in a vertical position on the wall or on the back plane of a cubicle. Follow the requirement for cooling, see table 5.2-1 and figure 5.2-1 for dimensions.

To ensure a safe installation, make sure that the mounting surface is relatively flat. Mounting holes can be marked on the wall using the template on the cover of the cardboard shipping package.

Mounting is done with four screws or bolts depending on the size of the unit, see tables 5.3-1 and 5.3-2, and figure 5.3-1 for dimensions. Units, from 25 Hp to 500 Hp, have special lifting "eyes" which must be used, see figures 5.3-2 and 5.3-3.

The mounting instructions for units over 500 Hp are given in a separate manual. If further information is needed contact your Cutler-Hammer distributor.

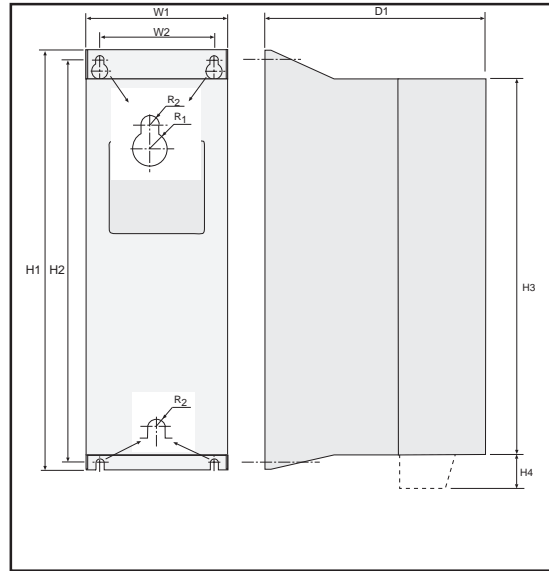

Figure 5.3-1 Mounting dimensions.



Frame	Enclosure	Voltage	Dimensions (inches)								
			W1	W2	H1	H2	H3	H4	D1	R1	R2
M3	Compact NEMA 1	230 / 380 / 480	4.7	3.7	13.5	13.1	12	X	5.9	0.28	0.14
M4B		230 / 380 / 480	5.3	3.7	17	16.5	15.4		8.1	0.28	0.14
M5B		230 / 380 / 480	7.3	5.5	23.4	22.8	21.7		8.5	0.35	0.18
M4	NEMA 1 / 12	230 / 380 / 480	4.7	3.7	16.7	16.2	15.4	X	8.5	0.28	0.14
M5		230 / 380 / 480	6.2	5	22.1	21.5	20.3		9.4	0.35	0.18
M6		230 / 380 / 480	8.7	7.1	27.6	26.9	25.6		11.4	0.35	0.18
M7		230 / 380 / 480	14.7	13.6	41.3	40.6	39.4		13	0.35	0.18
M8		230 / 380 / 480	19.5	18	53.1	36.5	50.8		13.9	0.45	0.24
M9		380 / 480	27.6	26	57.9	40.2	56.1		15.4	0.45	0.24
M10		380 / 480	CONTACT FACTORY								
M4	Chassis / Protected	230 / 380 / 480	4.7	3.7	12.7	12.3	11.4	1.6	8.5	0.28	0.14
M5		230 / 380 / 480	6.2	5	17.8	17.1	15.9	1.8	9.4	0.35	0.18
M5		600	6.2	5	19.1	18.5	17.3	1.8	10.4	0.35	0.18
M6		230 / 380 / 480	8.7	7.1	22.6	22	20.7	3.9	11.4	0.35	0.18
M6		600	8.7	7.1	26.3	25.6	24.3	3.9	11.4	0.35	0.18
M7		230 / 380 / 480	9.8	8.7	33.6	32.9	31.5	X	12.4	0.35	0.18
M8		230 / 380 / 480 / 600	19.5	18	37.4	36.5	35		13.9	0.45	0.24
M9		380 / 480 / 600	27.6	26	41.1	40.2	39.4		15.4	0.45	0.24
M10		380 / 480 / 600	38.9	37.3	41.1	40.2	39.4		15.4	0.45	0.24
M11		380 / 480 / 600	CONTACT FACTORY								
M12		380 / 480 / 600	CONTACT FACTORY								

Table 5.3-1 Dimensions for open panel units.



5

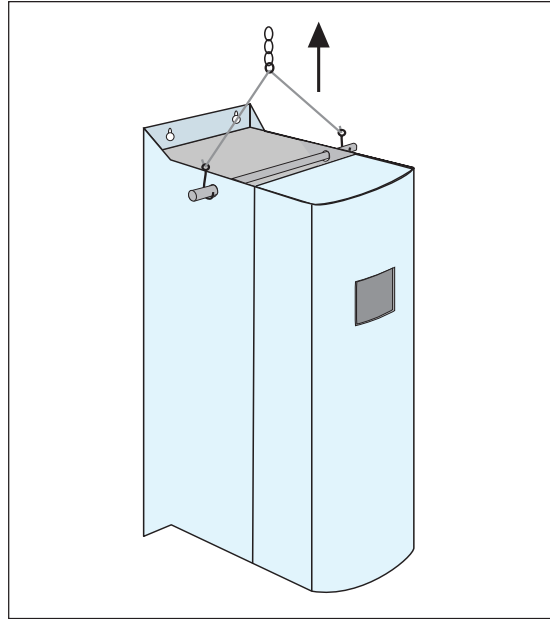

Figure 5.3-2 Lifting of 25—125 Hp units.

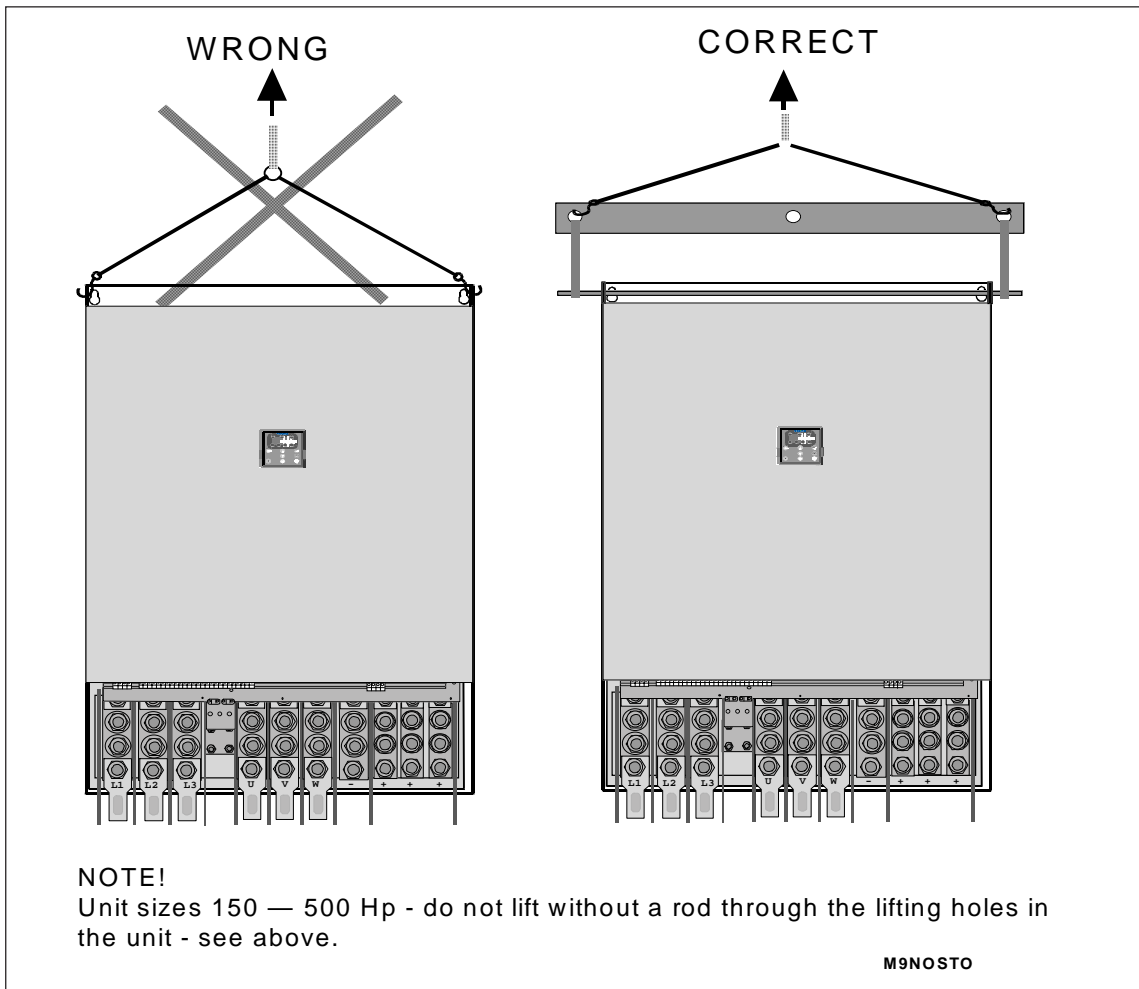

Figure 5.3-3 Lifting of 150—500 Hp units.



6 WIRING

General wiring diagrams are shown in figures 6-1—6-3. The following chapters have more detailed instructions about wiring and cable connections.

The general wiring diagrams for M11 and M12 frame sizes are provided in a separate manual. If further information is required, contact your Cutler-Hammer distributor.

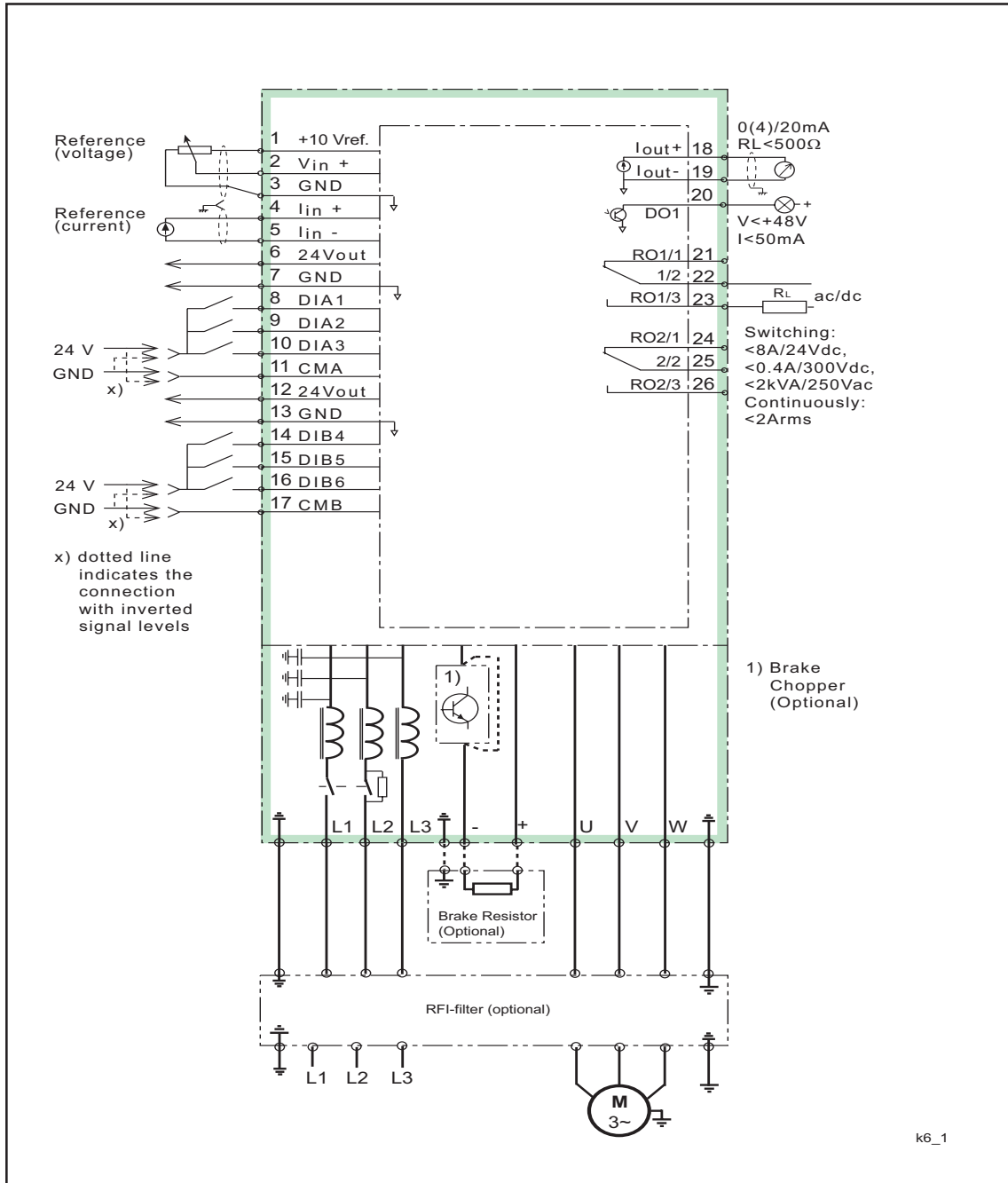

Figure 6-1: General wiring diagram, open/protected chassis units frame sizes M4—M6.



6

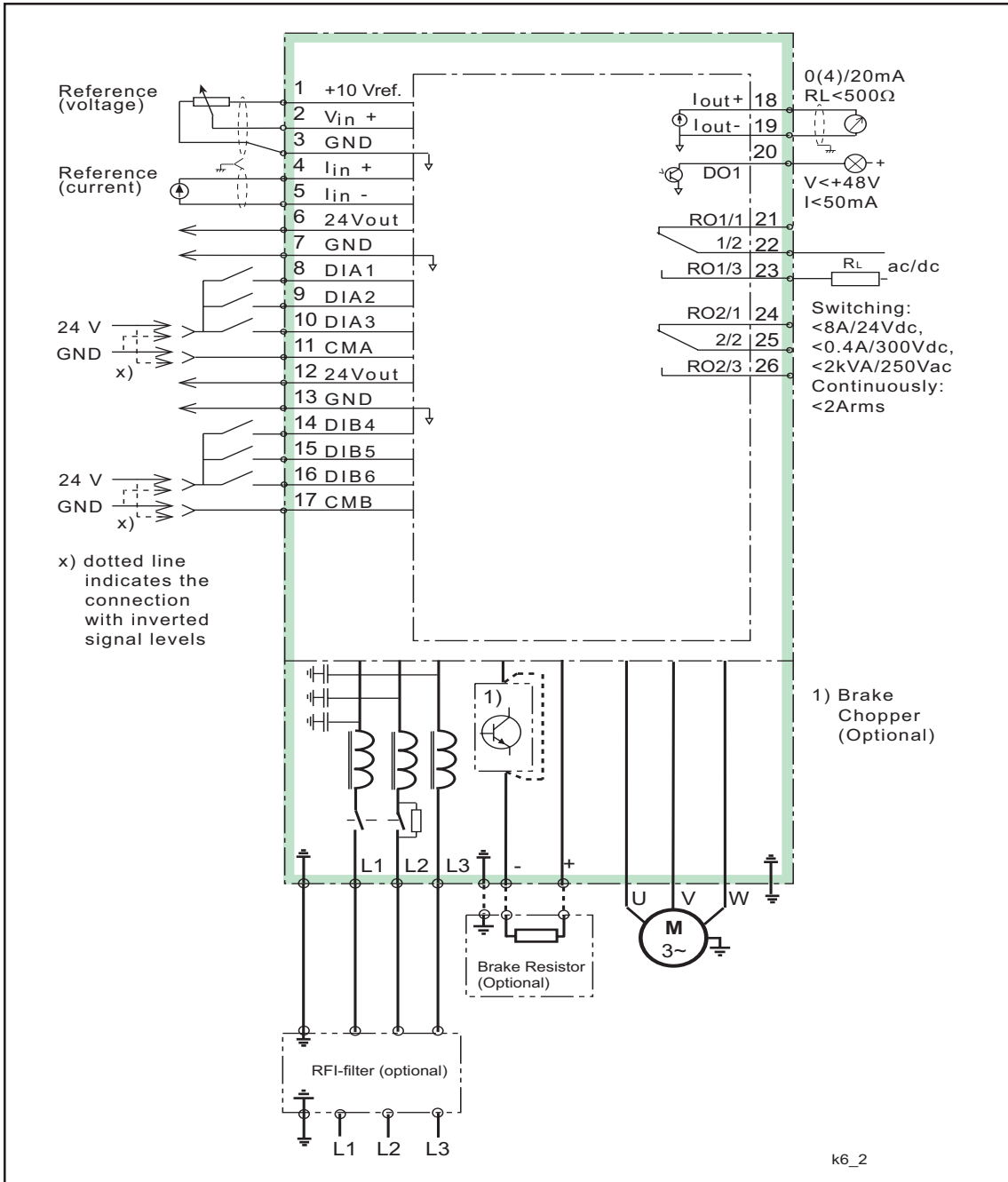
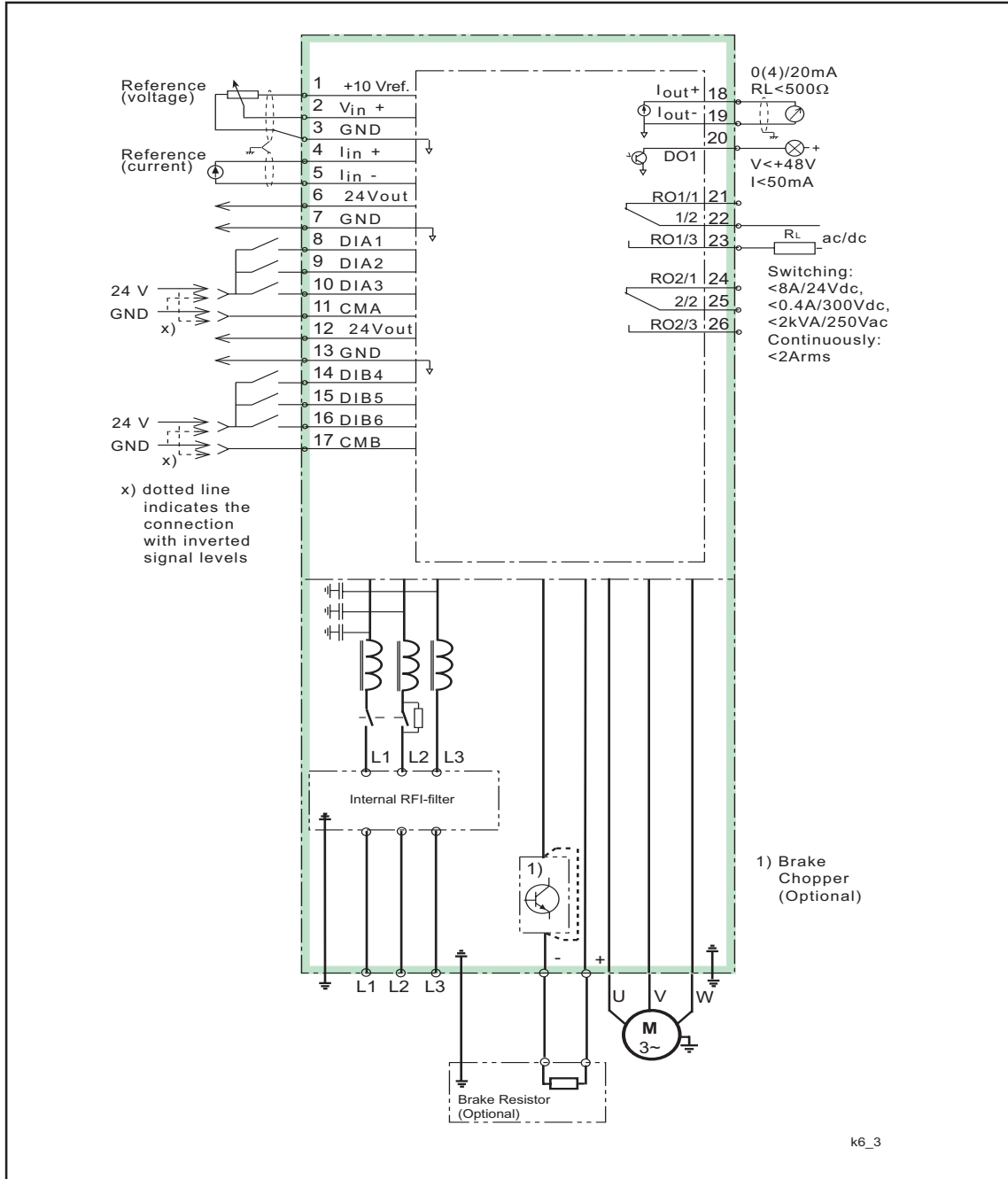

Figure 6-2 General wiring diagram, open/protected chassis frame size > M7 and NEMA 1/12 units frame size > M8.





6

Figure 6-3 General wiring diagram, NEMA 1/12 units frame sizes M4 to M7 and Compact NEMA 1 units.





## 6.1 Power connections

Use heat-resistant cables, +60°C or higher. The cable (and the fuses) must be sized in accordance with the rated output current of the unit. Installation of the cable consistent with the UL-instructions is explained in chapter 6.1.4.1.

The minimum dimensions for the Cu-cables and corresponding fuses are given in the tables 6.1-2 — 6.1-5. The fuses have been selected so that they will also function as overload protection for the cables.

Consistent with UL requirements, for maximum protection of the SV9000, UL recognized fuses type RK should be used.

If the motor temperature protection ( $I^2t$ ) is used as overload protection the cables may be selected according to that. If 3 or more cables are used in parallel, on the larger units, every cable must have it's own overload protection.

These instructions cover the case where one motor is connected with one cable to the drive.

Always pay attention to the local authority regulations and installation conditions.

### 6.1.1 Utility cable

Utility cables for the different EU EMC levels are defined in table 6.1-1.

### 6.1.2 Motor cable

Motor cables for the different EU EMC levels are defined in table 6.1-1.

### 6.1.3 Control cable

Control cables are specified in chapter 6.2.1.

# 6

Cable	level N	level I
Utility cable	1	1
Motor cable	2	2
Control cable	3	3

Table 6.1-1 Cable types for the different EMC levels.

1 = The power cable suitable for the installation, ampacity and voltage.  
Shielded cable is not required.

2 = The power cable contains a concentric protection wire, and is suitable for the ampacity and voltage.  
For maximum EMC protection, use of shielded cable is required.

3 = The control cable has a compact low-impedance shield.



480V Hp	I <sub>CT</sub>	Fuse	Cu-cable UTILITY & MOTOR (Ground)	I <sub>MT</sub>	Fuse	Cu-cable UTILITY & MOTOR (Ground)	
1	2.5	10	16 ( 16 )	3	10	16 ( 16 )	
1.5	3			3.5			
2	3.5			5			
3	5			8			
5	8			11			15
7.5	11	15	14 ( 14 )	15	20	12 ( 12 )	
10	15	20	12 ( 12 )	21	25	10 ( 10 )	
15	21	25	10 ( 10 )	27	35	8 ( 8 )	
20	27	35	8 ( 8 )	32	50	8 ( 8 )	
25	34	50		40	50		
30	40	50	6 ( 6 )	52	60	6 ( 6 )	
40	52	60		65	80	4 ( 6 )	
50	65	80	4 ( 6 )	77	100	2 ( 6 )	
60	77	100	2 ( 6 )	96	125	0 ( 4 )	
75	96	125	0 ( 4 )	125	150	00 ( 2 )	
100	125	150	00 ( 2 )	160	200	000 ( 0 )	
125	160	200	000 ( 0 )	180	200	350MCM ( 000 )	
150	180	200	350MCM ( 000 )	260	300		
200	260	300		350MCM ( 000 )	320	400	2x [250MCM ( 00 ) ]
250	320	400	2x [250MCM ( 00 ) ]	400	500	2x [350MCM ( 000 ) ]	
300	400	500	2x [350MCM ( 000 ) ]	460	600	2x [ 550MCM (250MCM ) ]	
400	480	CONTACT FACTORY					600
500 - 1100							

Table 6.1-2 Utility, motor cables and fuse recommendations according to output currents  $I_{CT}$  and  $I_{VT}$ , 500V range.

380V kW	I <sub>CT</sub>	Fuse	Cu-cable UTILITY & MOTOR (Ground)	I <sub>MT</sub>	Fuse	Cu-cable UTILITY & MOTOR (Ground)
0.75	2.5	10	16 ( 16 )	3.5	10	16 ( 16 )
1.1	3.5			4.5		
1.5	4.5			6.5		
2.2	6.5			8		
3	8			10		
4	10			13		
5.5	13	15	14 ( 14 )	18	20	12 ( 12 )
7.5	18	20	12 ( 12 )	24	25	10 ( 10 )
11	24	25	10 ( 10 )	32	35	8 ( 8 )
15	32	35	8 ( 8 )	42	50	
18.5	42	50	6 ( 6 )	48	60	6 ( 6 )
22	48	60		60		60
30	60	60	6 ( 6 )	75	80	4 ( 6 )
37	75	80	4 ( 6 )	90	100	2 ( 6 )
45	90	100	2 ( 6 )	110	125	0 ( 4 )
55	110	125	0 ( 4 )	150	150	00 ( 2 )
75	150	150	00 ( 2 )	180	200	000 ( 0 )
90	180	200	000 ( 0 )	210	250	300MCM ( 00 )
110	210	250	300MCM ( 00 )	270	300	350MCM ( 000 )
132	270	300	350MCM ( 000 )	325	400	2x [250MCM ( 00 ) ]
160	325	400	2x [250MCM ( 00 ) ]	410	500	2x [350MCM ( 000 ) ]
200	410	500	2x [350MCM ( 000 ) ]	510	600	2x [500MCM (250 MCM ) ]
250	510	600	2x [500MCM (250 MCM ) ]	580	600	2x [500MCM (250 MCM ) ]
315 - 1000	CONTACT FACTORY					

Table 6.1-3 Utility, motor cables and fuse recommendations according to output currents  $I_{CT}$  and  $I_{VT}$ , 400V range



600V HP	lct	Fuse	Cu-cable UTILITY & MOTOR (Ground)	lvt	Fuse	Cu-cable UTILITY & MOTOR (Ground)
7.5	10	10	16 ( 16 )	14	15	14 ( 14 )
10	14	15	14 ( 14 )	19	20	12 ( 12 )
15	19	20	12 ( 12 )	23	25	10 ( 10 )
20	23	25	10 ( 10 )	26	35	8 ( 8 )
25	26	35	8 ( 8 )	35	35	
30	35	35		42	50	
40	42	50		52	60	6 ( 6 )
50	52	60	6 ( 6 )	62	60	
60	62	60		85	100	2 ( 6 )
75	85	100	2 ( 6 )	100	100	
100	100	100		122	125	0 ( 4 )
125	122	125	0 ( 4 )	145	100	00 ( 2 )
150	145	150	00 ( 2 )			
175				222	250	300MCM ( 00 )
200	222	250	300MCM ( 00 )	287	300	350MCM ( 000 )
250 - 800	CONTACT FACTORY					

Table 6.1-4 Utility, motor cables and fuse recommendations according to output currents  $I_{CT}$  and  $I_{VT}$ , 600V range.

230V HP	lct	Fuse	Cu-cable UTILITY & MOTOR (Ground)	lvt	Fuse	Cu-cable UTILITY & MOTOR (Ground)
0.75	3.6	10	16 ( 16 )	4.7	10	16 ( 16 )
1	4.7			5.6		
1.5	5.6			7		
2	7			10		
3	10			13	15	14 ( 14 )
		15	14 ( 14 )	16		
5	16			22	25	10 ( 10 )
7.5	22	25	10 ( 10 )	30	35	8 ( 8 )
10	30	35	8 ( 8 )	43	50	
15	43	50		57	60	6 ( 6 )
20	57	60	6 ( 6 )	70	80	4 ( 6 )
25	70	80	4 ( 6 )	83	100	2 ( 6 )
30	83	100	2 ( 6 )	113	125	0 ( 4 )
40	113	125	0 ( 4 )	139	150	00 ( 2 )
50	139	150	00 ( 2 )	165	200	000 ( 0 )
60	165	200	000 ( 0 )	200	200	
75	200	200		264	300	350MCM ( 000 )

Table 6.1-5 Utility, motor cables and fuse recommendations according to output currents  $I_{CT}$  and  $I_{VT}$ , 230V range.

6

Frame	Hp ( KW )	Voltage	CABLE ( AWG / MCM )	
			Main	Ground
M3	All	230 / 380 / 480	14	14
M4	All	230 / 380 / 480	10	10
M4B	All	230 / 380 / 480	6	6
M5	All	230 / 380 / 480 / 600		
M5B	10 - 20	230	2	00
	( 15 - 22 )	380		
	20 - 30	480		
M6	15 - 30	230	0 Cu, 00 Al	00
	( 18.5 - 22 )	380		
	25 - 30	480		
	30 - 50	600		
	( 30 - 45 )	380		
	40 - 60	480		
60 - 75	600			
M7	40 - 75	230	350 MCM	000
	( 55 - 90 )	380		
	100 - 150	480		
M8	( 110 - 160 )	380	2x350 MCM Cu 2x500 MCM Al	2x500 MCM
	150 - 200	480		
	100 - 150	600		
M9	( 200 - 250 )	380	2x600 MCM	2x500 MCM
	250 - 300	480		
	200	600		
M10	( 315 - 400 )	380	4x500 MCM *	2x500 MCM
	400 - 500	480		
	250 - 300	600		
M11	( 500 )	380	CONTACT FACTORY	
	600	480		
	400	600		
M12	( 630 - 1000 )	380		
	700 - 1100	480		
	500 - 800	600		

\* NEMA 1/12 maximum 3 parallel connected cables can be used

Table 6.1-6 Maximum cable sizes of the power terminals



### 6.1.4 Installation instructions

1

If a SV9000 open chassis unit is to be installed outside a control cabinet or a separate cubicle a protective IP20 cover should be installed to cover the cable connections, see figure 6.1.4-3. The protective cover may not be needed if the unit is mounted inside a control cabinet or a separate cubicle.

All open chassis SV9000 units should always be mounted inside a control cabinet, or a separate cubicle.

2

Locate the motor cable away from the other cables:

- Avoid long parallel runs with other cables.
- If the motor cable runs in parallel with the other cables, the minimum distances given in table 6.1.4-1 between the motor cable and control cables should be followed.
- These minimum distances apply also between the motor cable and signal cable of other systems.
- **The maximum length of a motor cable can be 600ft (180 m) (except for ratings 1.5 Hp and below max. length is 160 ft (50 m) and 2 Hp max. length 330 ft (100 m)).** The power cables should cross other cables at an angle of 90° degrees. An output dv/dt filter option is required for motor cable lengths exceeding 33ft (10m) for drive 2 Hp and below and 100ft (33m) for drives 3Hp and larger.

Distance between cables ft (m)	Motor cable length ft (m)
1 (0.3)	≤165 (50)
3.3 (1)	≤600 (180)

Table 6.1.4-1 Minimum cable distances.

3

See chapter 6.1.5 for cable insulation checks.

4

Connecting cables:

- Motor and utility cables should be stripped according to figure 6.1.4-2 and table 6.1.4-2.
- Open the cover of the SV9000 according to figure 6.1.4-3.
- Remove sufficient plugs from the cable cover (open chassis) or from the bottom of the NEMA 1/12 units.
- Pass cables through the holes in the cable cover.
- Connect the utility, motor and control cables to the correct terminals. See figures 6.1.4-3—16. SV9000 + external RFI-filter: (See RFI-filter option manual). The installation instructions for M11 and M12 frames are explained in the separate manual for M11/M12 units. Contact your Cutler-Hammer distributor for more information. Cable installation consistent with UL-instructions is explained in chapter 6.1.4.1.
- Check that control cable wires do not make contact with electrical components in the device.
- Connect optional brake resistor cable (if required).
- Ensure the ground cable is connected to the  $\oplus$ -terminal of the frequency converter and motor.
- For open chassis units, 150—500 Hp, connect the isolator plates of the protective cover and terminals according to figure 6.1.4-11.

6



## 5

- If a shielded power cable is used, connect its shield to the ground terminals of the drive, motor and supply panel.
- Mount the cable cover (open chassis units) and the unit cover.
- Ensure the control cables and internal wiring are not trapped between the cover and the body of the unit.

**NOTE:**

The connection of the transformer inside the unit in frame sizes M7—M12 has to be changed if other than the default supply voltage of the drive is used. Contact your Cutler-Hammer distributor if more information is needed.

Voltage Code (VC)	Default Supply Voltage
2	230V
4	380V
5	480V
6	600V

## 6



### 6.1.4.1 Cable selection and installation for the UL listing

For Installation and cable connections the following must be noted. Use only with copper wire temperature rating of at least 60/75°C.

In addition to the connecting information the tightening torque of the terminals are defined in the table 6.1.4.1-2.

Units are suitable for use on a circuit capable of delivering not more than the fault RMS symmetrical amperes mentioned in the table 6.1.4.1-1, 480V maximum.

FRAME	Voltage	Maximum RMS symmetrical amperes on supply circuit
M3	All	35,000
M4 - M12	All	100,000

Table 6.1.4.1-1 Maximum symmetrical supply current.

6

FRAME	Hp ( KW )	Voltage	Tightening torque ( in-lbs )
M3	All	All	7
M4B	All	All	7
M5B	All	All	20
M4	All	All	7
M5	All	All	20
M6	15 - 20	220	35
M6	25 - 30	220	44
M6	( 18.5 - 22 )	380	35
M6	( 30 - 45 )	380	44
M6	25 - 30	480	35
M6	40 - 60	480	44
M6	30-40	575	35
M6	40 - 75	575	44
M7	All	All	44
M8	All	All	610*
M9	All	All	610*

\* The isolated standoff of the busbar does not withstand the listed tightening torque. Use a wrench to apply counter torque when tightening.

Table 6.1.4.1-2 Tightening torque.



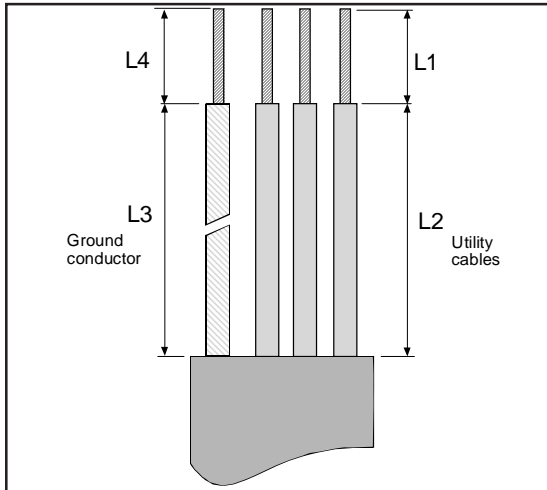

Figure 6.1.4-1 Stripping motor and utility cables.

Frame	Hp ( KW )	Voltage	Stripping Lengths ( in )			
			s1	s2	s3	s4
M3	All	230 / 380 / 480	0.47	2.2	2.2	0.47
M4	All	230 / 380 / 480	0.24	1.4	2.4	0.6
M4B	All	230 / 380 / 480				
M5	All	230 / 380 / 480 / 600	0.35	1.6	4	0.6
M5B	10 - 20	230	0.6	1.6	4	0.6
	( 15 - 22 )	380				
	20 - 30	480				
M6	15 - 30	230	1	1.6	4	0.6
	( 18.5 - 22 )	380				
	25 - 30	480				
	30 - 50	600				
	( 30 - 45 )	380				
	40 - 60	480				
60 - 75	600					
M7	40 - 75	230	2			1
	( 55 - 90 )	380				
	100 - 150	480				
M8	( 110 - 160 )	380				
	150 - 200	480				
	100 - 150	600				
M9	( 200 - 250 )	380				
	250 - 300	480				
	200	600				
M10	( 315 - 400 )	380				
	400 - 500	480				
	250 - 300	600				
M11	( 500 )	380				
	600	480				
	400	600				
M12	( 630 - 1000 )	380				
	700 - 1100	480				
	500 - 800	600				

\* NEMA 1 / 12 maximum 3 parallel connected cables can be used

Table 6.1.4-2 Stripping lengths of the cables (in).

6

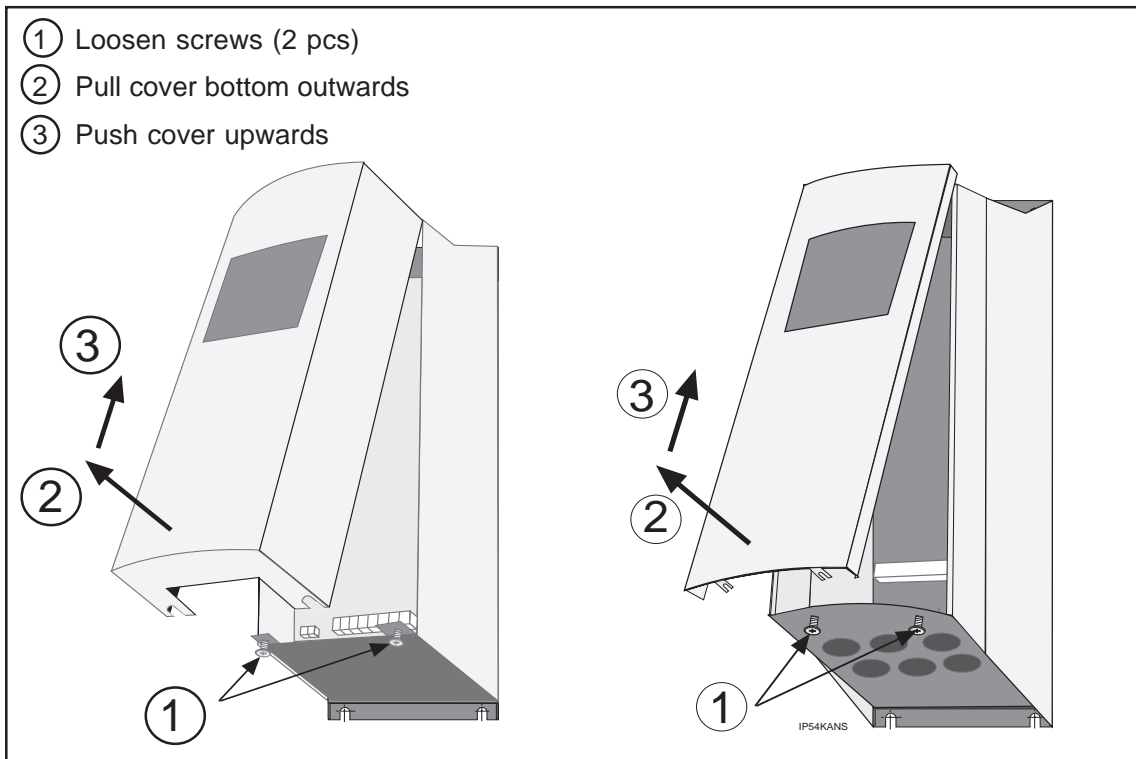
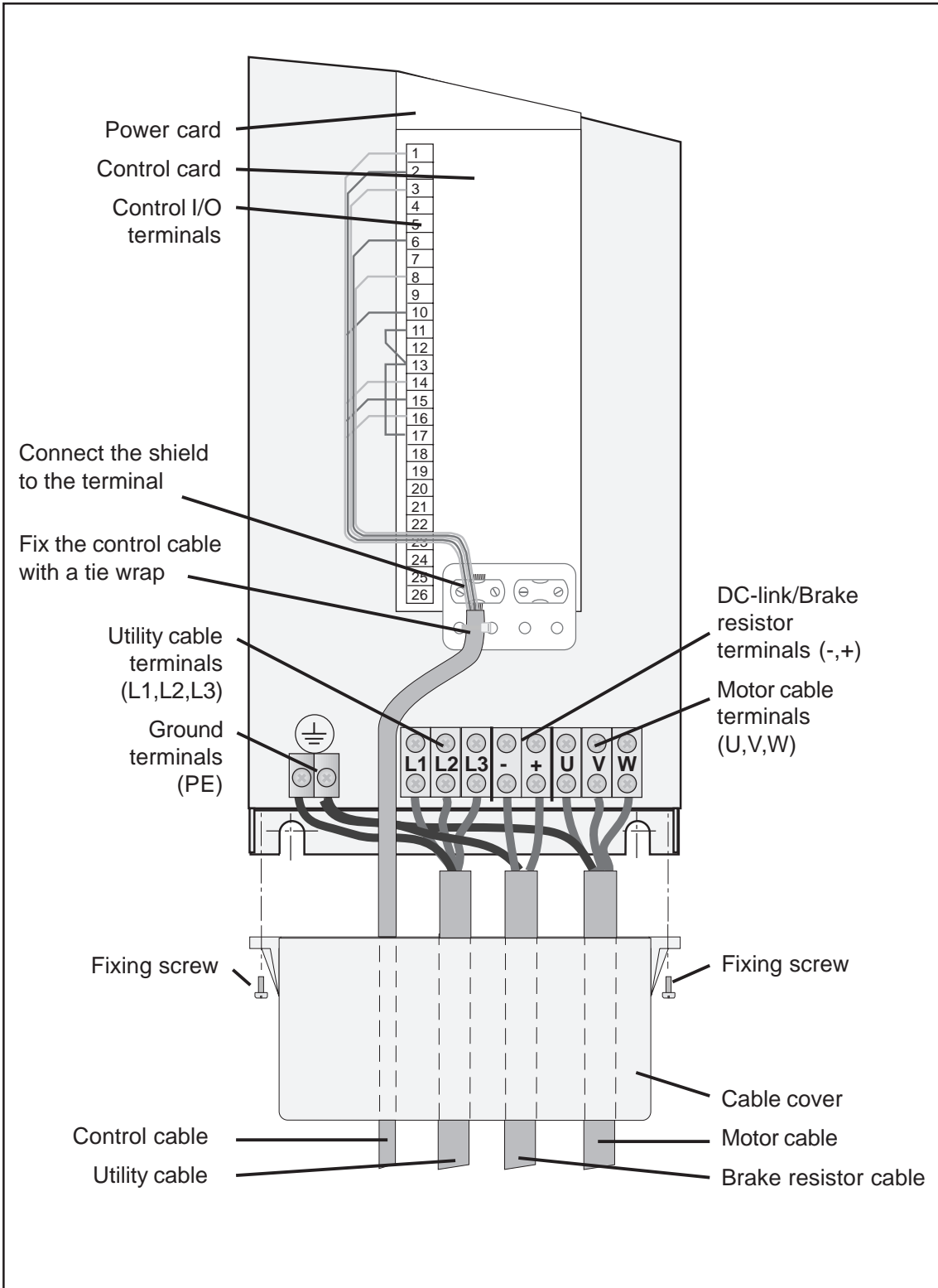

Figure 6.1.4-2 Opening the cover of the SV9000.







6

Figure 6.1.4-3 Cable assembly for open chassis: 3 - 20 Hp voltage code 4 and 5, and 2 - 10 Hp code 2.



6

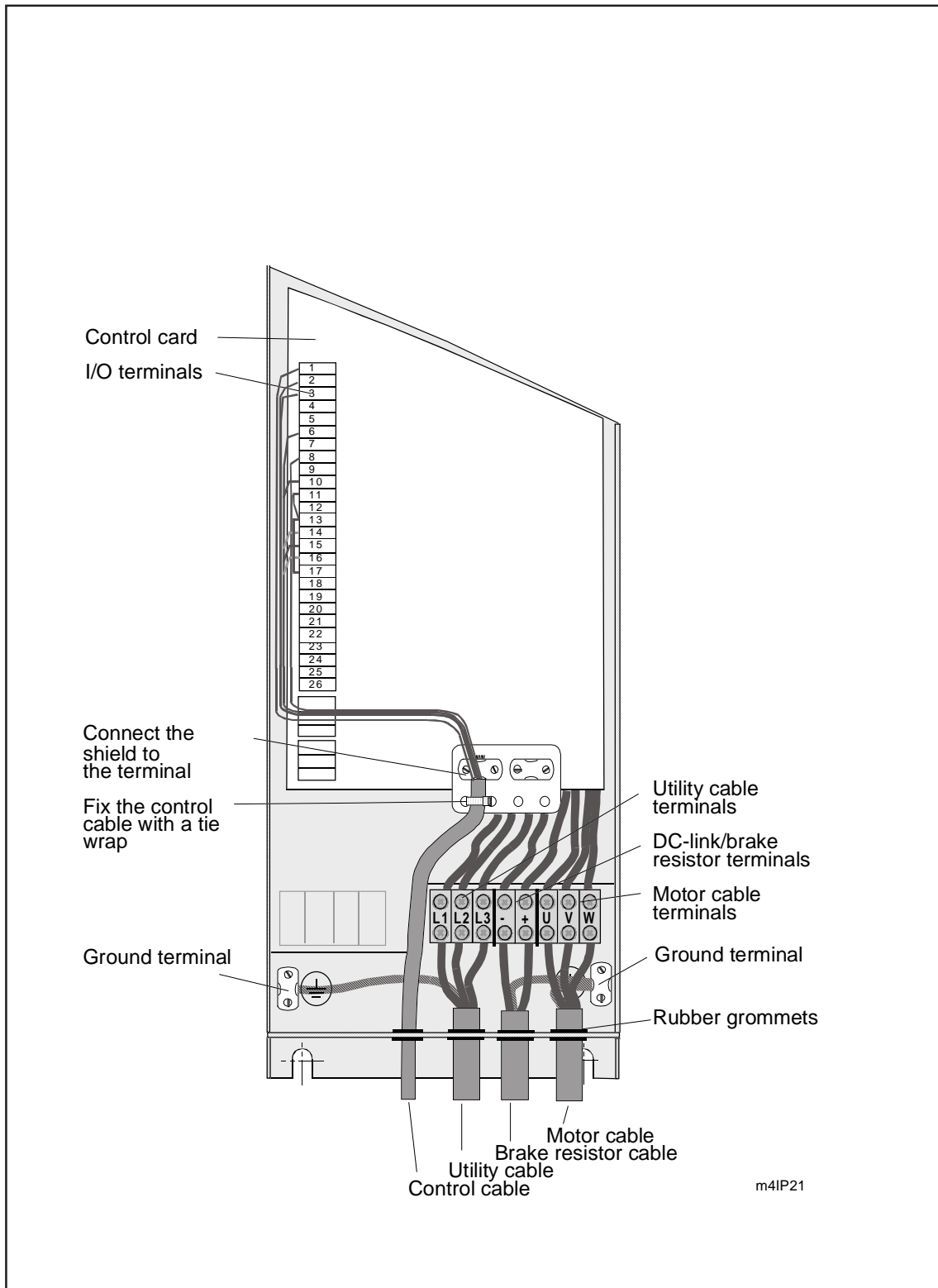
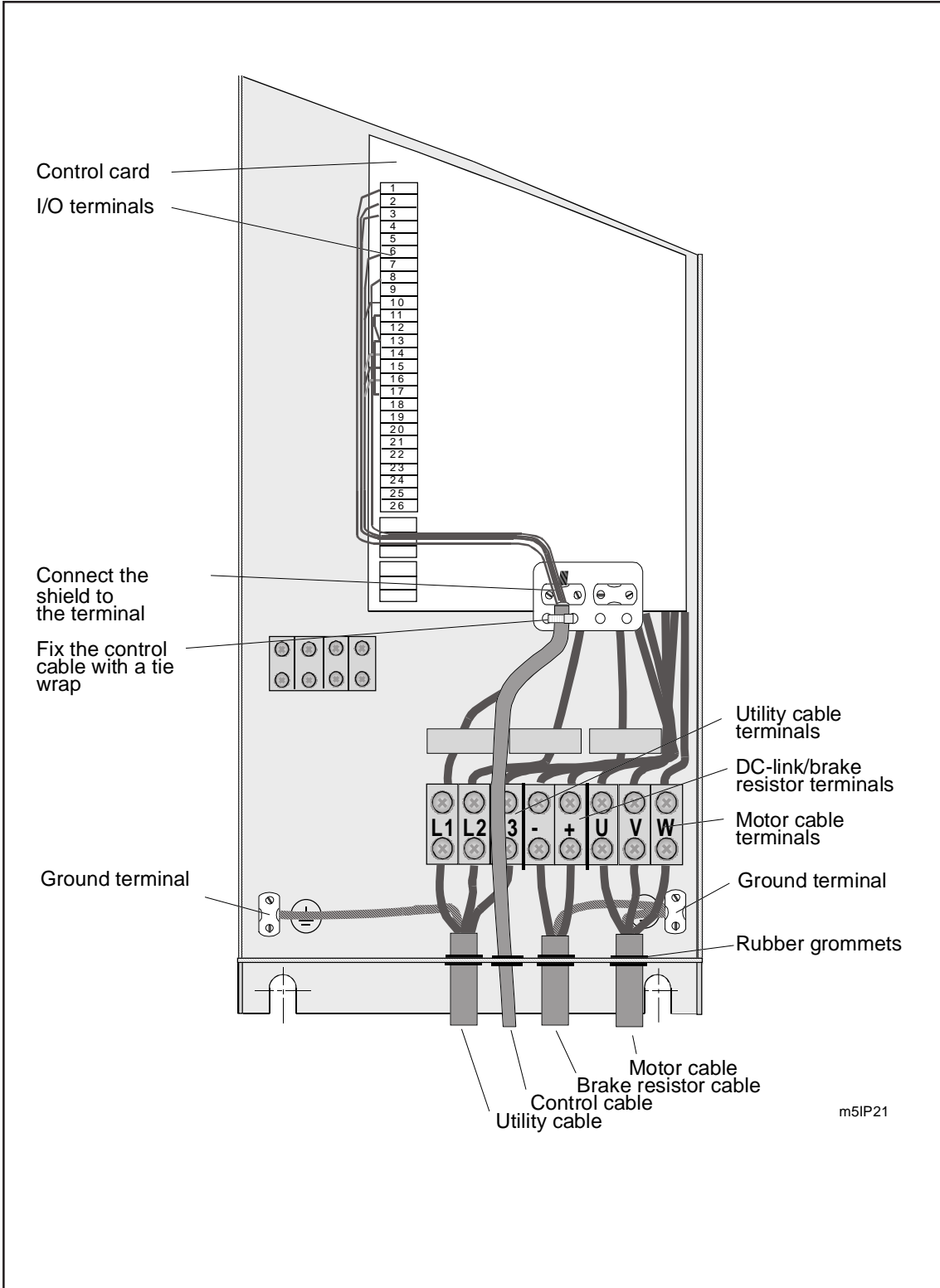

Figure 6.1.4-4 Cable assembly for Standard NEMA 1: 3 - 7.5 Hp voltage code 4 and 5, and 2 - 3 Hp code 2





6

Figure 6.1.4-5 Cable assembly for Standard NEMA 1: 10 - 20 Hp voltage code 4 and 5, and 5 - 10 Hp code 2.



6

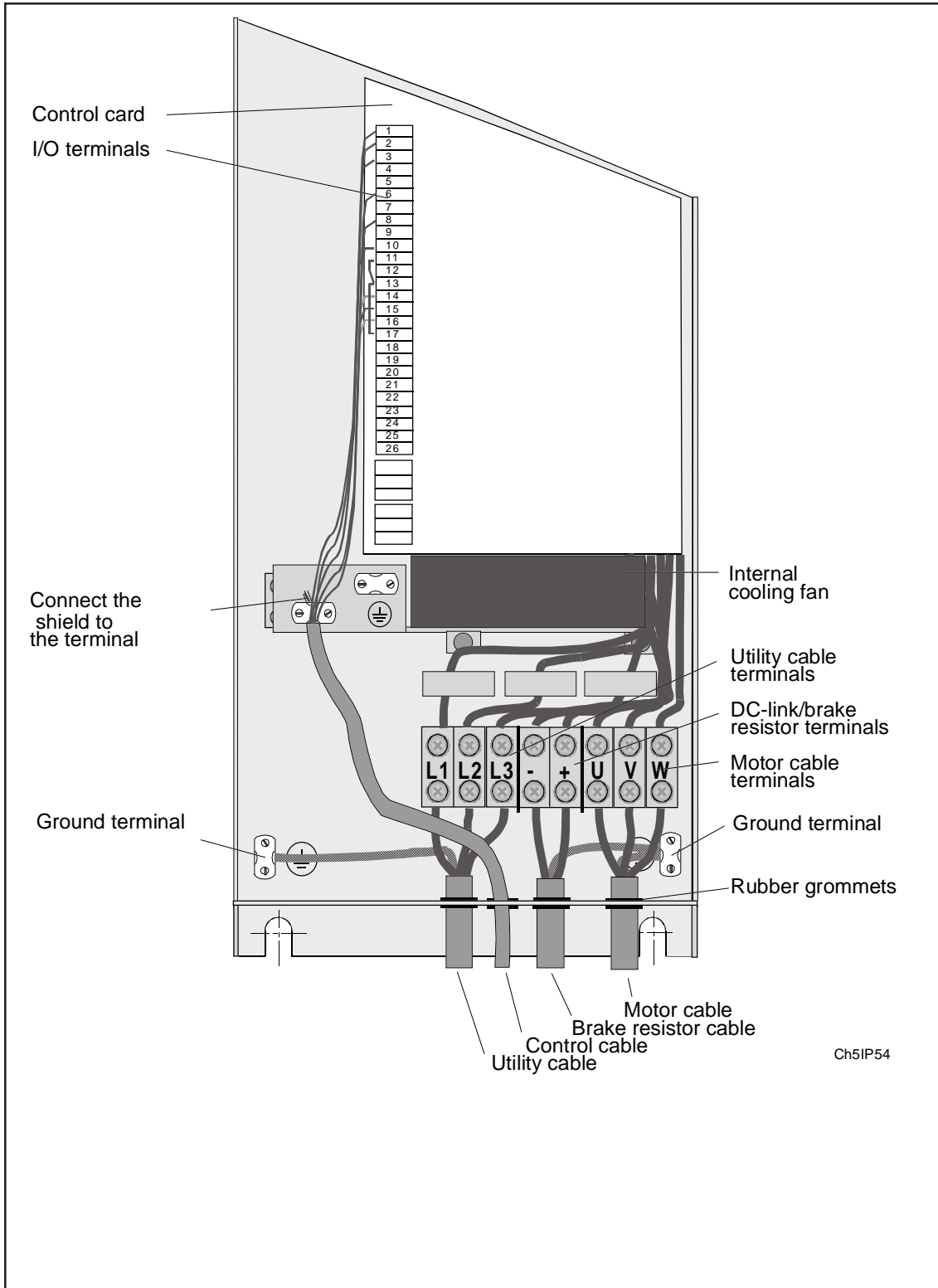
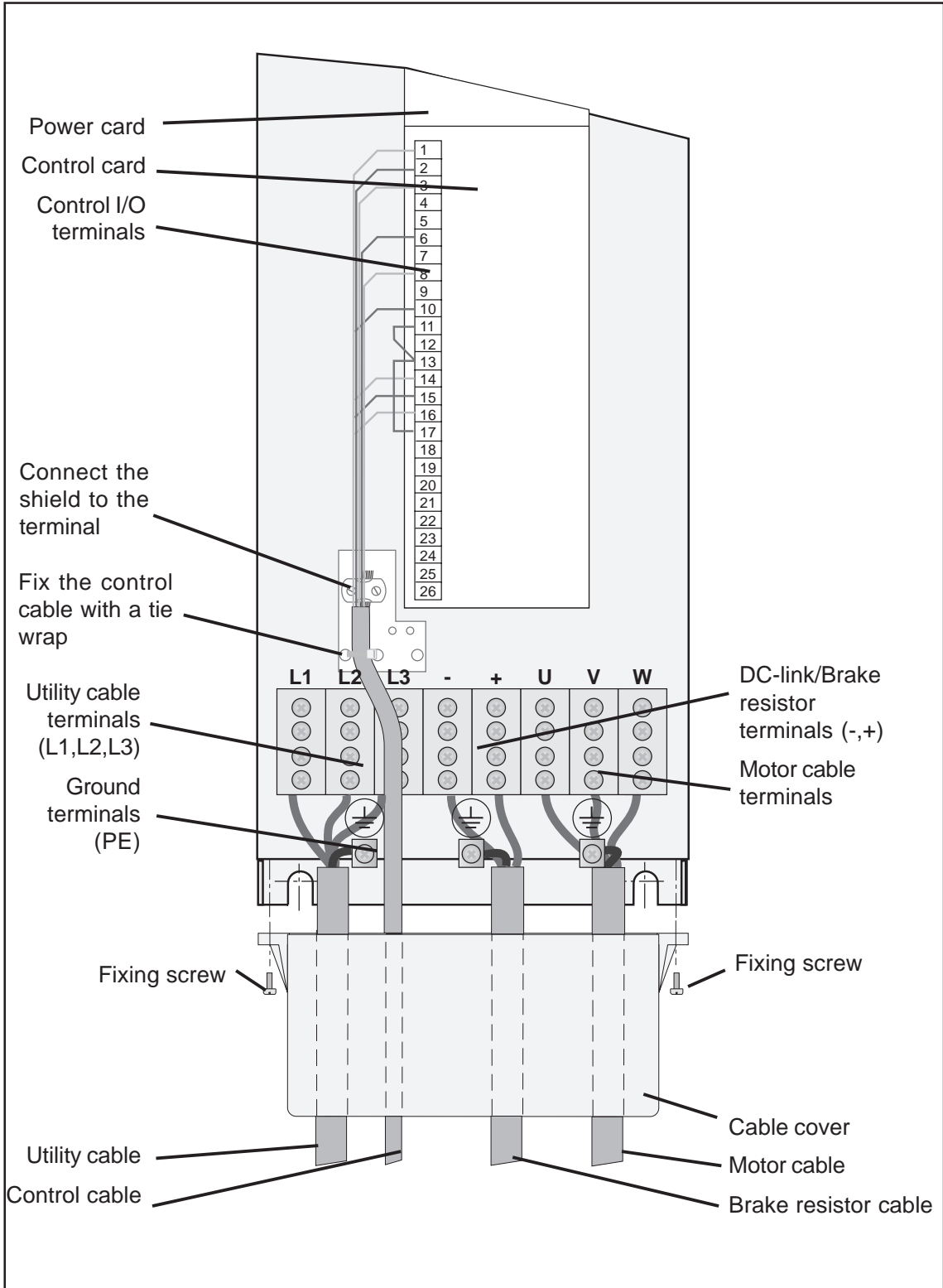

Figure 6.1.4-6 Cable assembly for Standard NEMA 12: 10 - 20 Hp voltage code 4 and 5, and 5 - 10 Hp code 2





6

Figure 6.1.4-7 Cable assembly for open chassis: 25 - 60 Hp voltage code 4 and 5, and 15 - 30 Hp code 2



6

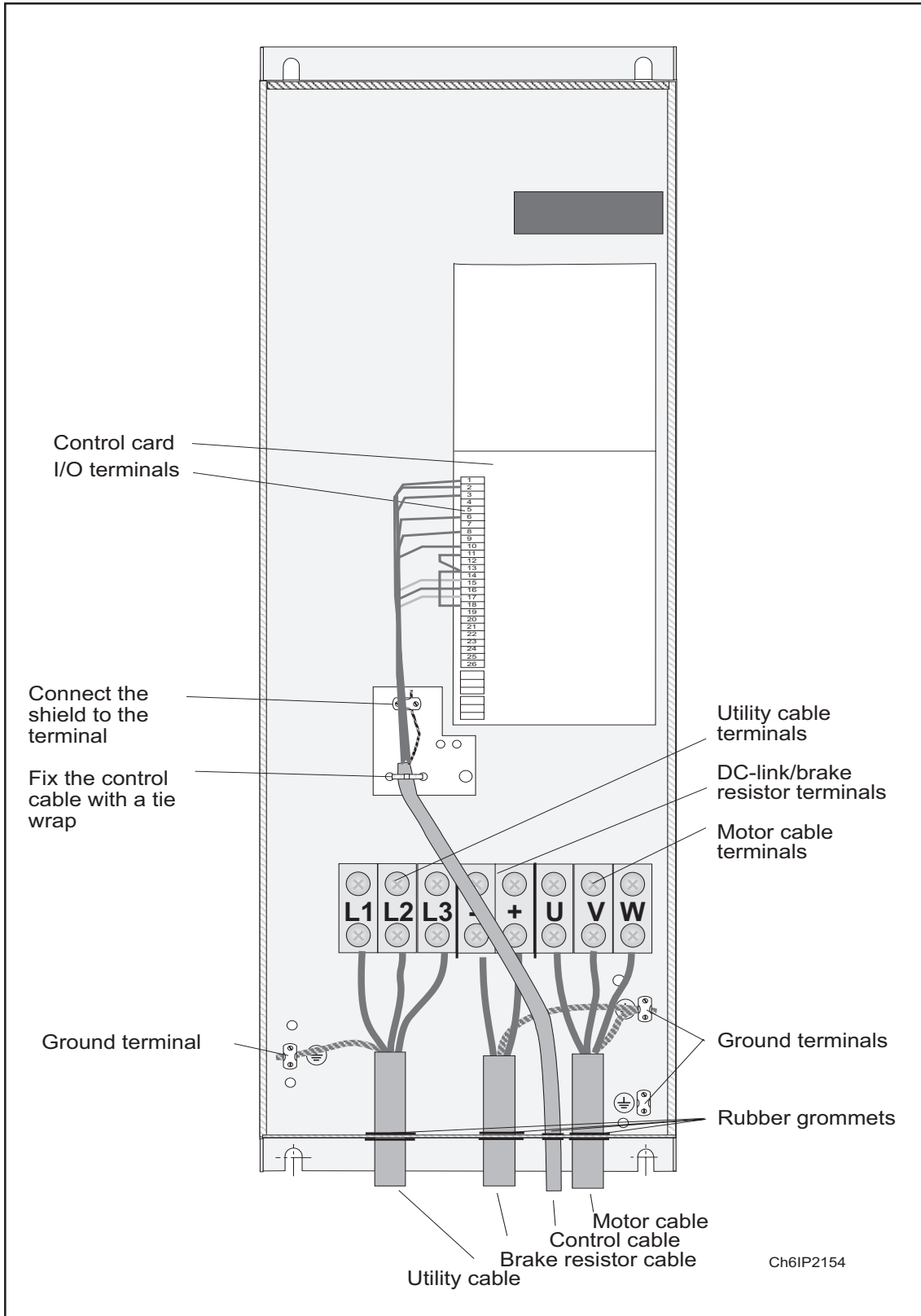
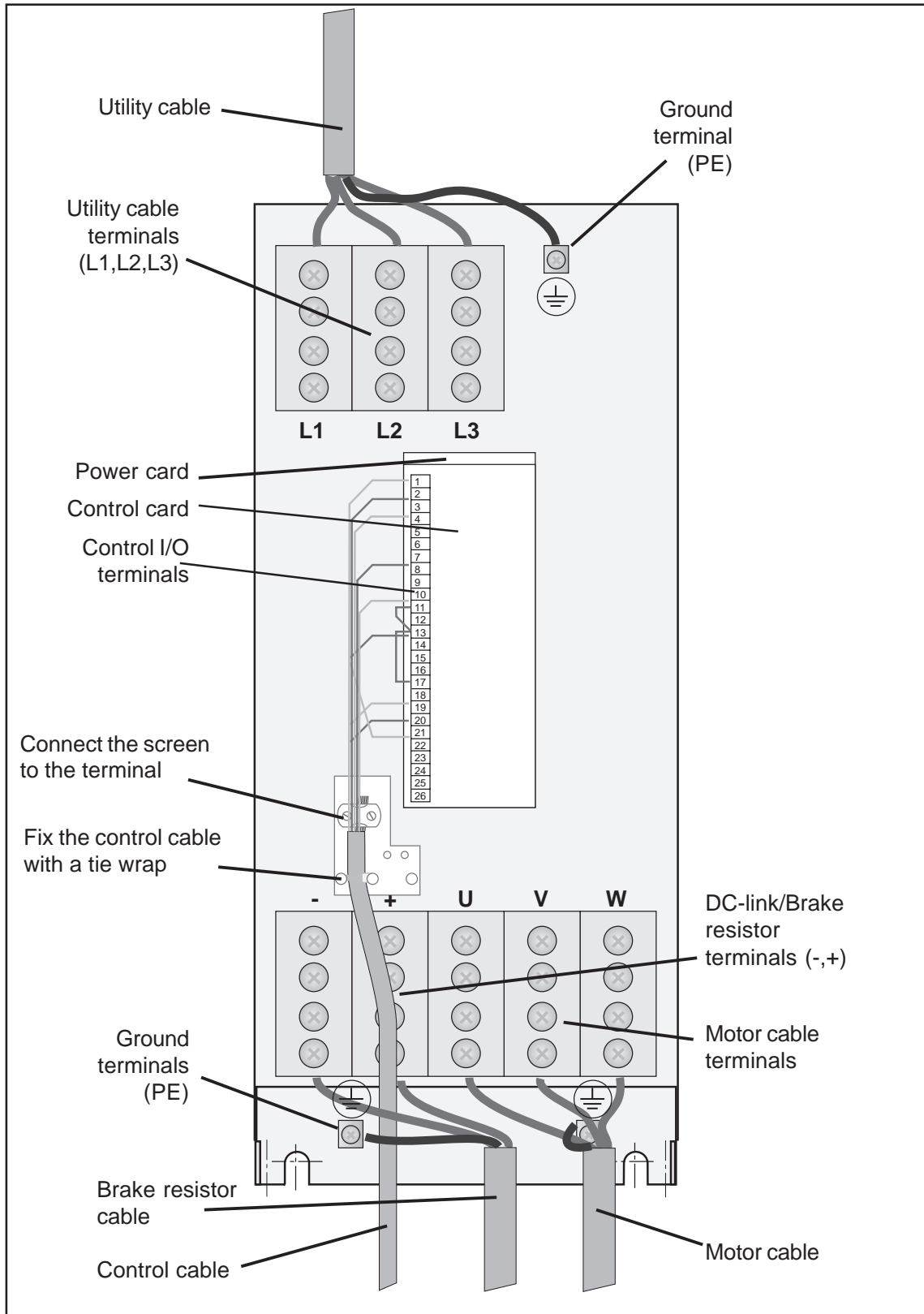

Figure 6.1.4-8 Cable assembly for Standard NEMA 1 25 - 60 Hp voltage code 4 and 5, and 15 - 30 Hp code 2





6

Figure 6.1.4-9 Cable assembly for open chassis: 75 - 125 Hp voltage code 4 and 5, 40 - 60 Hp code 2





6

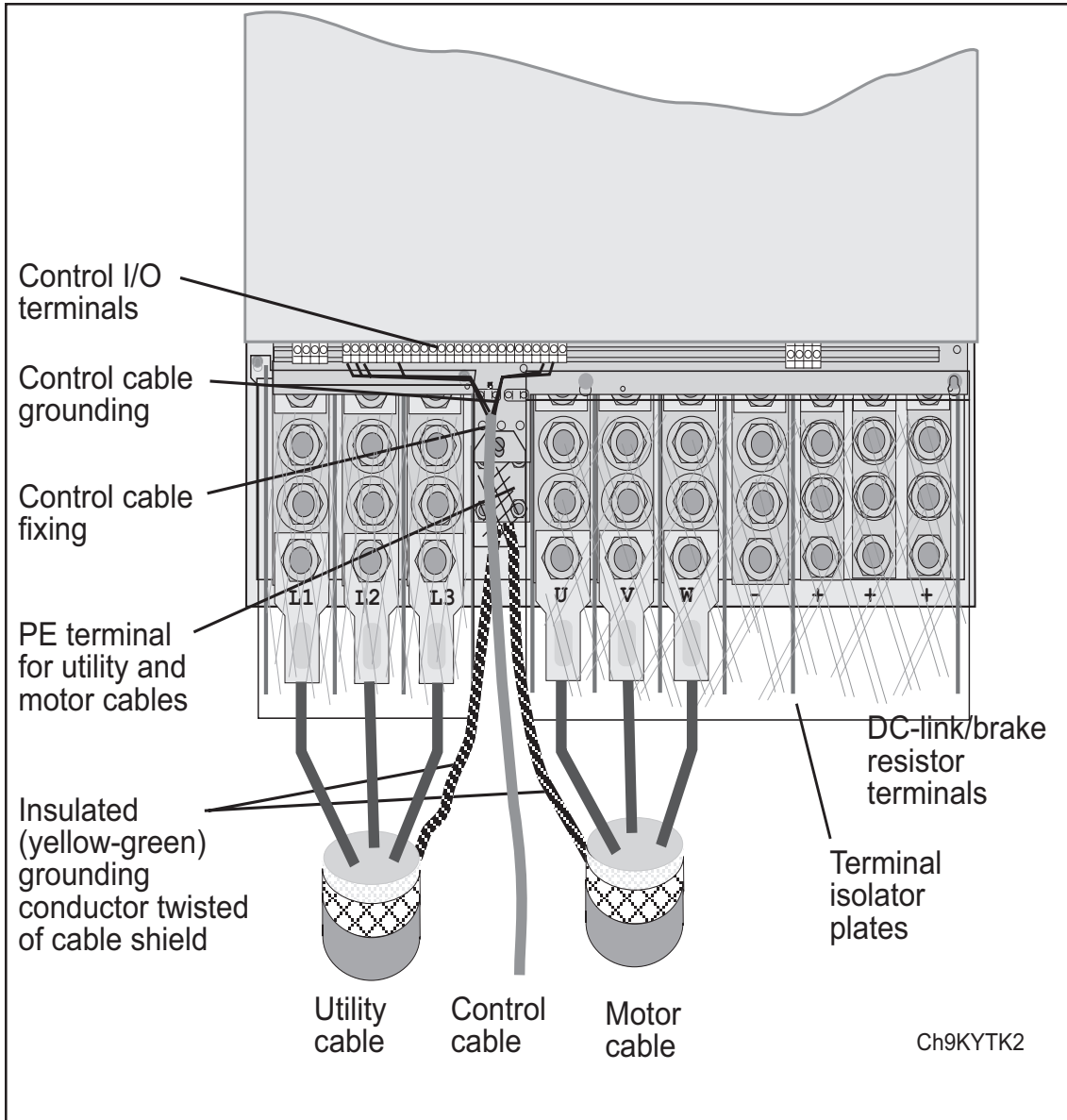
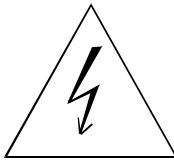
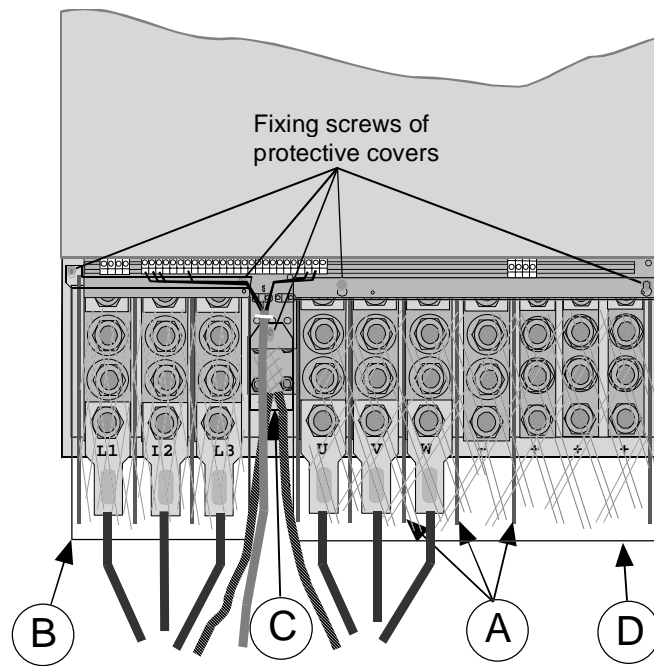

Figure 6.1.4-10 Cable assembly for open chassis 150 - 500 Hp voltage code 4 and 5, and 125 - 400 Hp code 6 and 75 Hp code 2; for NEMA 1 150 - 500 Hp code 4 and 5 and NEMA 1 75 Hp code 2.





**After cable connections before switching on the utility supply, ensure:**

1. Insert all 10 terminal isolator plates (A) in the slots between the terminals, see figure below
2. Insert and fix three plastic protective covers (B, C, and D) over the terminals

Securing the terminal isolation plates

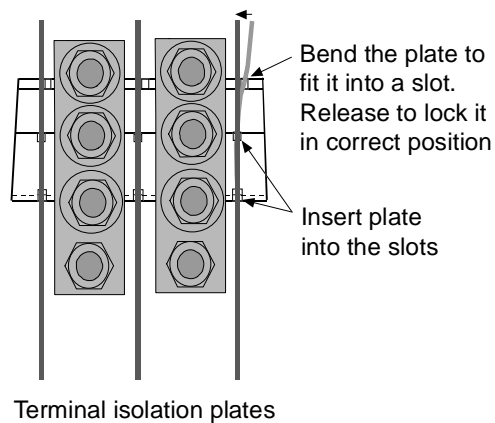

Ch9SUOJAT

Figure 6.1.4-11 Cable cover and terminal assembly for open chassis 150 - 500 Hp voltage code 4 and 5, 125 - 400 Hp code 6, and 75 Hp code 2; and NEMA 1 150 - 500 Hp code 4 and 5 and 75 Hp code 2



6

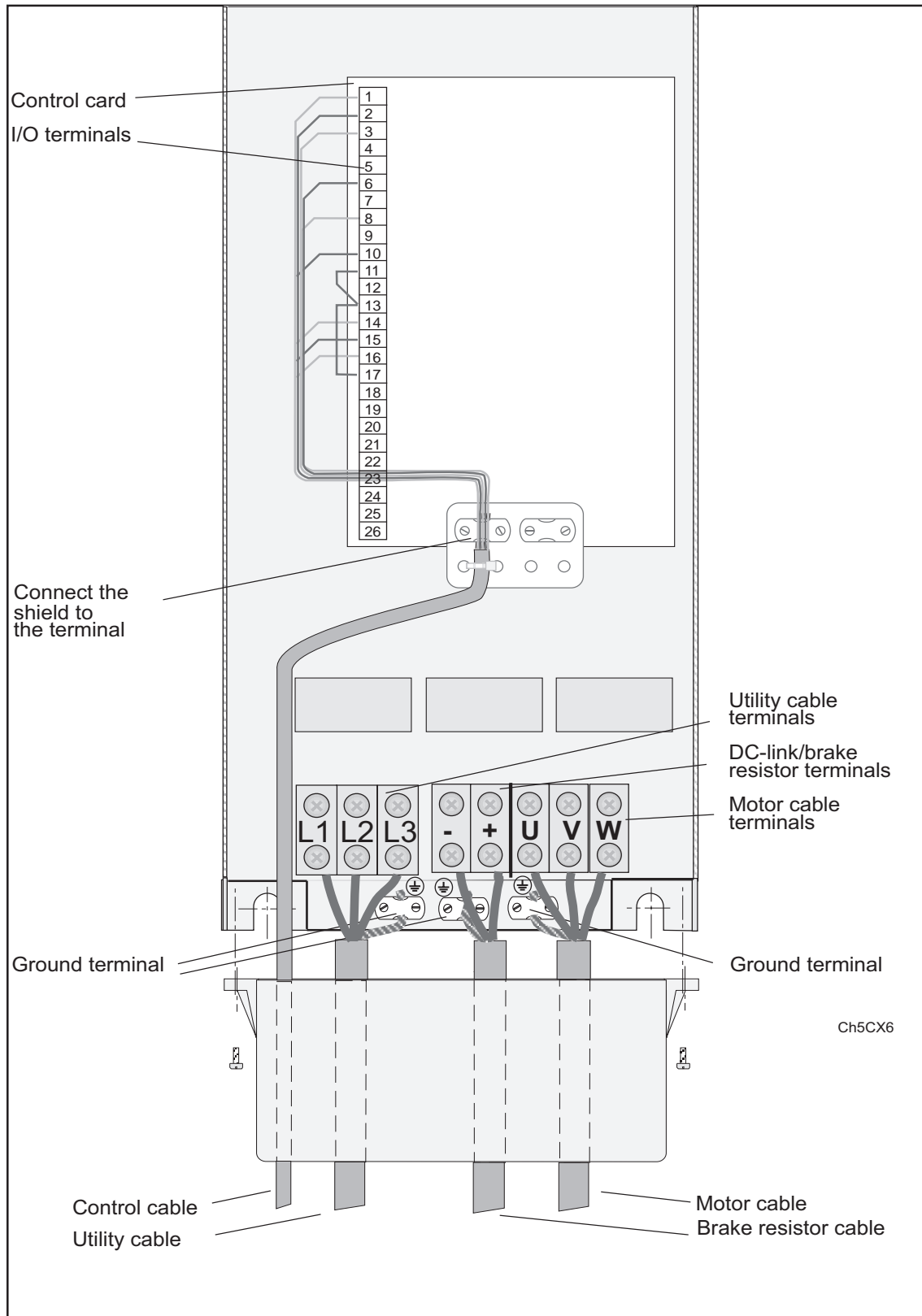
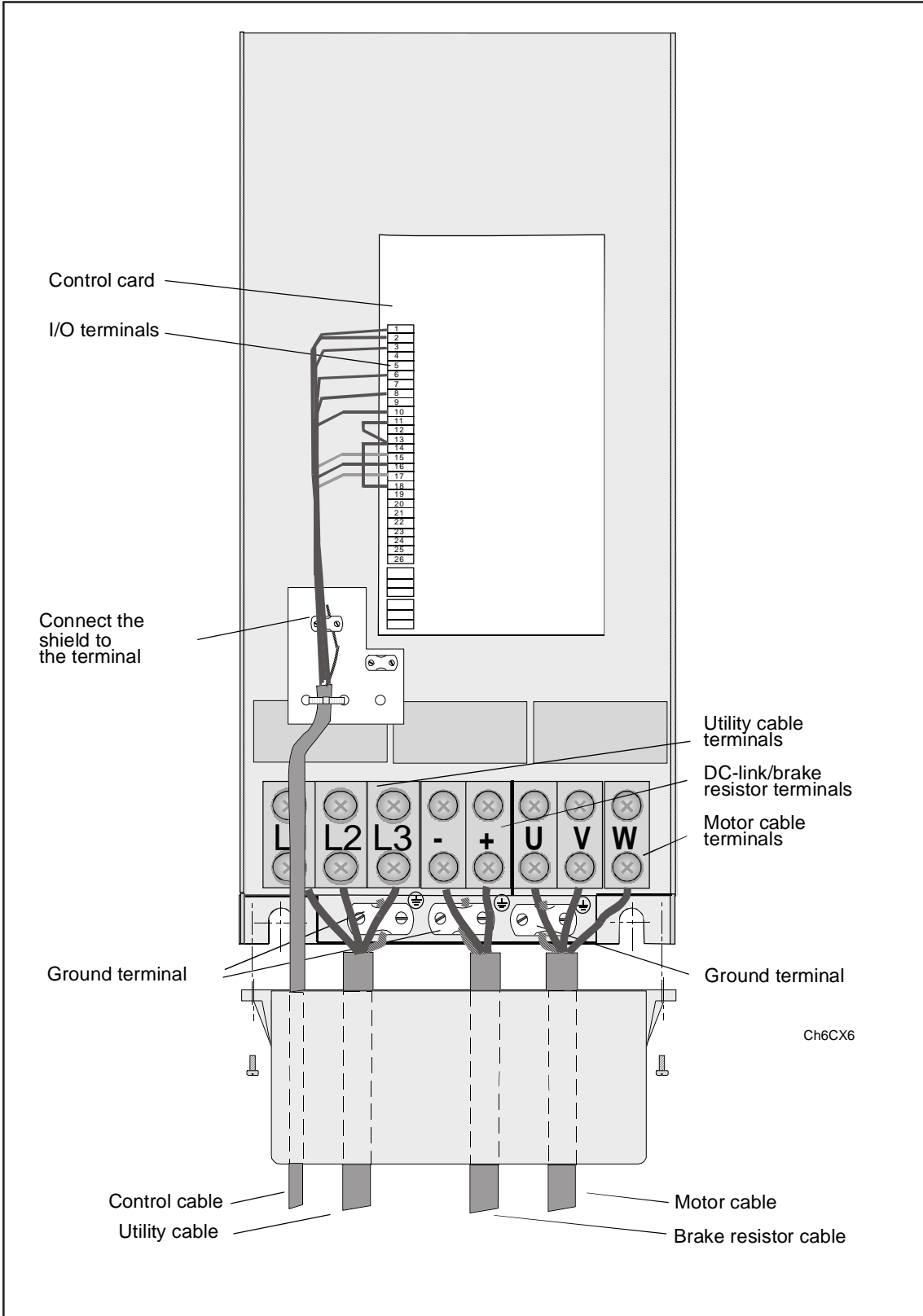

Figure 6.1.4-12 Cable assembly for open chassis 10 - 30 Hp voltage code 6





6

Figure 6.1.4-13 Cable assembly for open chassis 40 - 100 Hp voltage code 6



6

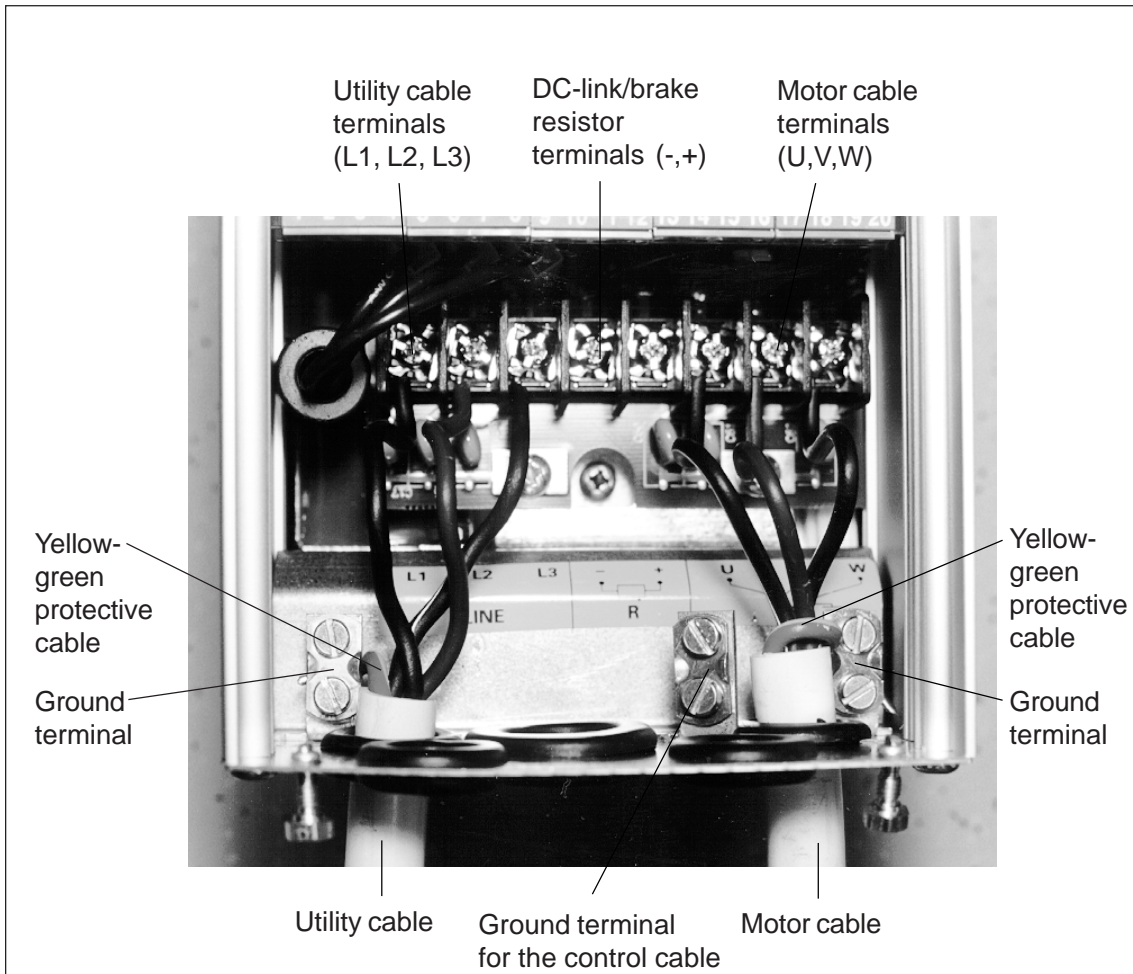
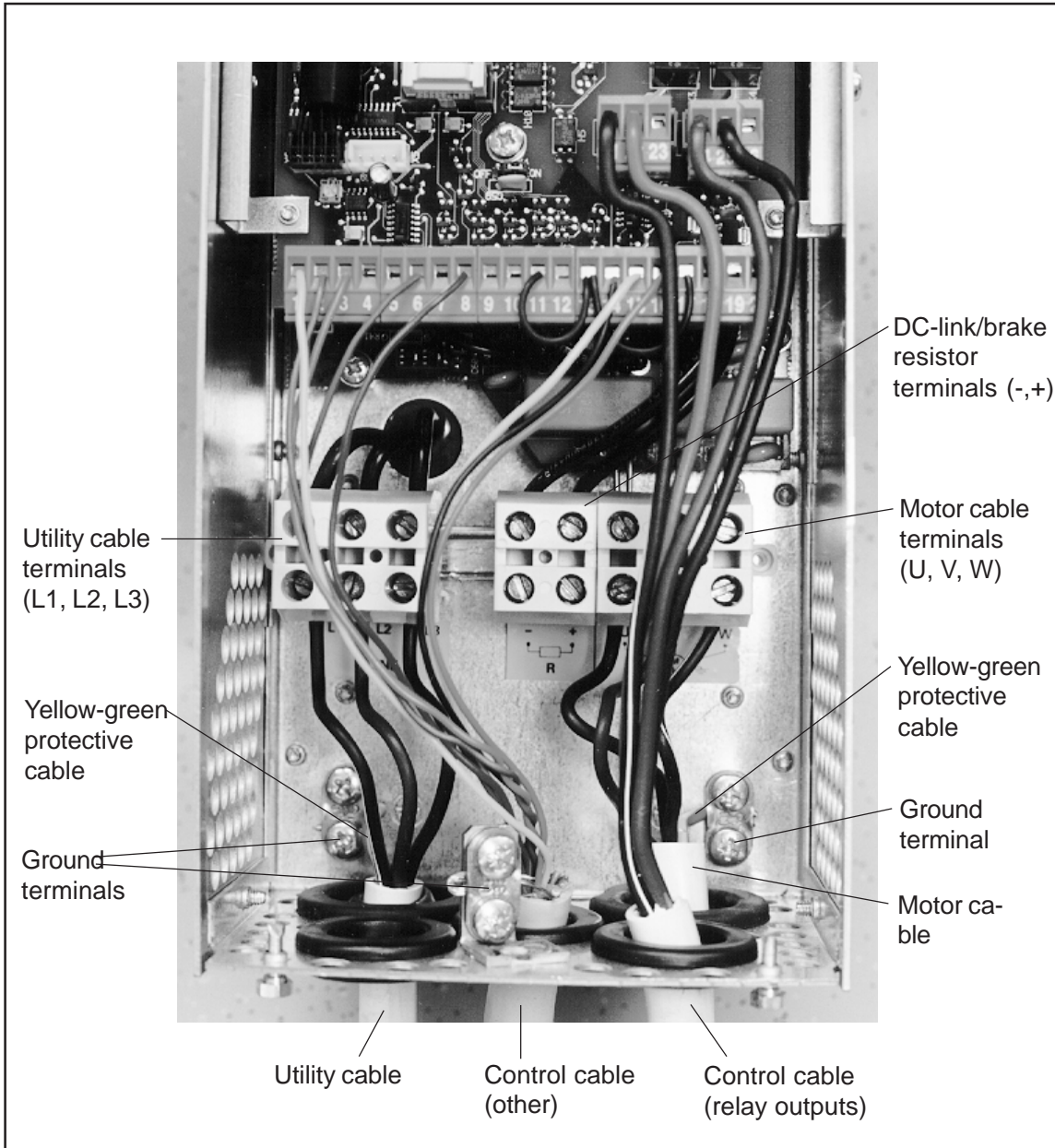

Figure 6.1.4-14 Cable assembly Compact NEMA 1 0.75 - 2 Hp, voltage code 2, 1-3 Hp voltage code 5





6

Figure 6.1.4-15 Cable assembly for Compact NEMA1 3 - 7.5 voltage code 2 and 5 - 15 Hp voltage code 5



### 6.1.5 Cable and motor insulation checks

#### 1 Motor cable insulation checks

Disconnect the motor cable from the terminals U, V and W of the SV9000 unit and from the motor.

Measure the insulation resistance of the motor cable between each phase conductor. Also measure the insulation resistance between each phase conductor and the protective ground conductor.

The insulation resistance must be  $>1\text{M}\Omega$ .

#### 2 Utility cable insulation checks

Disconnect the utility cable from terminals L1, L2 and L3 of the SV9000 unit and from the utility.

Measure the insulation resistance of the utility cable between each phase conductor. Also measure the insulation resistance between each phase conductor and the protective ground conductor. The insulation resistance must be  $>1\text{M}\Omega$ .

#### 3 Motor insulation checks

Disconnect the motor cable from the motor and open any bridging connections in the motor connection box.

Measure insulation resistance of each motor winding. The measurement voltage has to be at least equal to the utility voltage but not exceed 1000V.

The insulation resistance must be  $>1\text{M}\Omega$ .

### 6.2 Control connections

Basic connection diagram is shown in the figure 6.2-1.

The functionality of the terminals for the Basic application is explained in chapter 10.2. If one of the SVReady applications is selected, check the application manual for the functionality of the terminals for that application.

#### 6.2.1 Control cables

The control cables should be minimum of #20 gauge shielded multicore cables, see table 6.1-1. The maximum wire size rating of the terminals is #14.

#### 6.2.2 Galvanic isolation barriers

The control connections are isolated from the utility potential and the I/O ground is connected to the frame of the SV9000 via a  $1\text{M}\Omega$  resistor and 4.7 nF capacitor. The control I/O ground can also be connected directly to the frame, by changing the position of the jumper X4 to ON-position, see figure 6.2.2-1.

Digital inputs and relay outputs are isolated from the I/O ground.







Terminal		Function	Specification	
1	+10V <sub>ref</sub>	Reference voltage output	Burden max 10 mA *	
2	V <sub>in+</sub>	Analog signal input	Signal range -10 V— +10 V DC	
3	GND	I/O ground		
4	I <sub>in+</sub>	Analog signal (+input)	Signal range 0(4)—20 mA	
5	I <sub>in-</sub>	Analog signal (-input)		
6	24V out	24V supply voltage	±20%, load max. 100 mA	
7	GND	I/O ground		
8	DIA1	Digital input 1	R <sub>i</sub> = min. 5 kΩ	
9	DIA2	Digital input 2		
10	DIA3	Digital input 3		
11	CMA	Common for DIA1—DIA3	Must be connected to GND or 24V of I/O- terminal or to external 24V or GND	
12	24V out	24V supply voltage	Same as terminal # 6	
13	GND	I/O ground	Same as terminal # 7	
14	DIB4	Digital input 4	R <sub>i</sub> = min. 5 kΩ	
15	DIB5	Digital input 5		
16	DIB6	Digital input 6		
17	CMB	Common for DIB4 — DIB6	Must be connected to GND or 24V of I/O- terminal or to external 24V or GND	
18	I <sub>out+</sub>	Analog signal (+output)	Signal range 0(4)—20 mA,	
19	I <sub>out-</sub>	Analog ground (-output)	R <sub>L</sub> max. 500 Ω	
20	DO1	Open collector output	Transistor output, max. V <sub>in</sub> = 48 VDC max. current 50 mA	
21	RO1/1		Relay output 1	Max. switch. voltage 250 VAC, 300 VDC Max switch. current 8 A / 24 VDC, 0.4 A / 250 VDC Max. switch. power <2 kVA / 250 VAC Max. cont. current <2 A rms
22	RO1/2			
23	RO1/3			
24	RO2/1		Relay output 2	
25	RO2/2			
26	RO2/3			

Figure 6.2-1 Control I/O-terminal signals.

\* If the potentiometer reference is used, potentiometer R = 1—10 kΩ

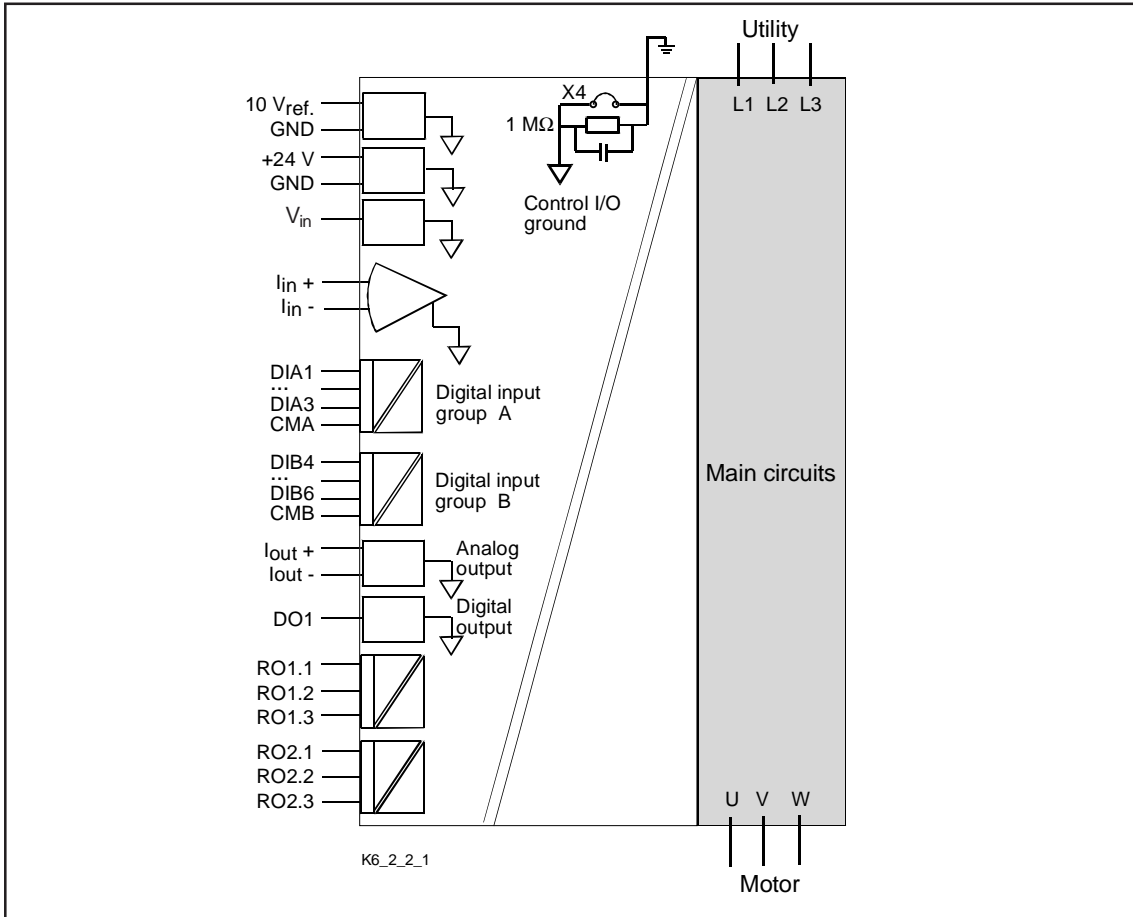

Figure 6.2.2-1 Isolation barriers.

### 6.2.3 Digital input function inversion

The active signal level of the digital input logic depends on how the common input (CMA, CMB) of the input group is connected. The connection can be either to +24 V or to ground. See figure 6.2.3-1.

The +24V or ground for the digital inputs and common terminals (CMA, CMB) can be either external or internal (terminals 6 and 12 of the drive).

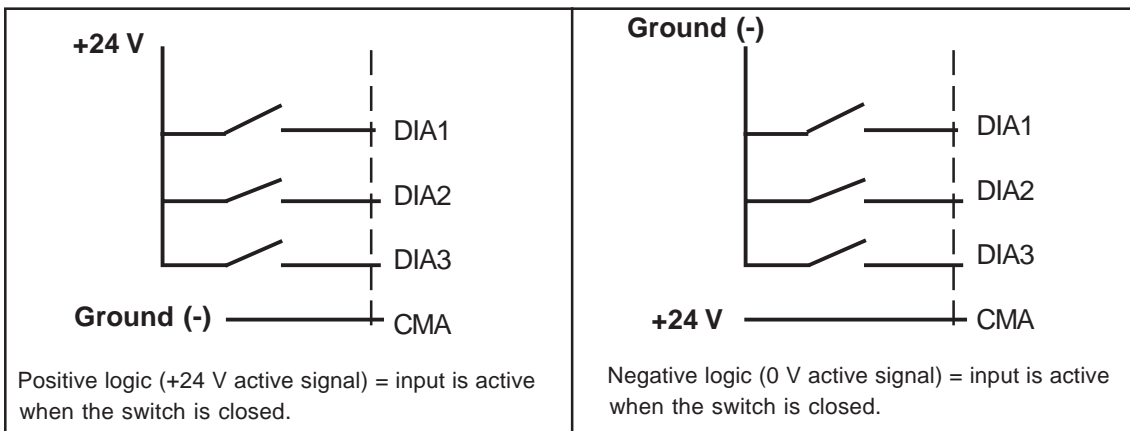



Figure 6.2.3-1 Positive/negative logic.



## 7. CONTROL PANEL

### 7.1 Introduction

The control panel of SV9000 drive features an alphanumeric Multiline Display with five indicators for the Run status (RUN, READY, FAULT,  , STOP) and two indicators for the control source. The panel embodies three indicator lines for the menu/submenu descriptions and the value/amount of the submenus. The eight push buttons on the panel are used for panel programming and monitoring.

The panel is detachable and isolated from the input line potential.

The display examples in this chapter present the text and numeric lines of the Multiline Display only. The drive status indicators are not included in the examples.

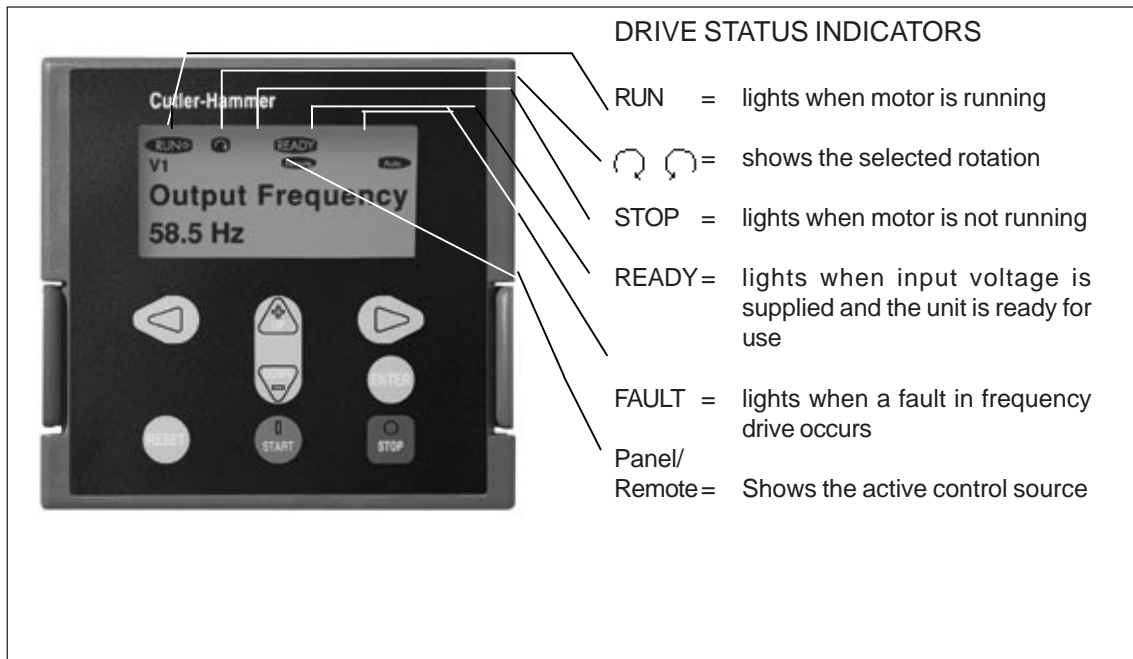









Figure 7.1-1 Control panel with LED display.

-  = *Menu button (left)*  
Move forward in the menu
-  = *Menu button (right)*  
Move backward in the menu
-  = *Browser button (up)*  
Move in the main menu and between pages inside the same submenu. Change value.
-  = *Browser button (down)*  
Move in the main menu and between pages inside the same submenu. Change value.
-  = *Enter button*  
Acknowledgement of changed value. Fault history reset. Function as programmable button.
-  = *Reset button*  
Fault resetting
-  = *Start button*  
Starts the motor if the panel is the active control source
-  = *Stop button*  
Stops the motor if the panel is the active control source



### 7.2 Panel operation

The panel is arranged in menus and submenus. The menus are used for measurement and control signals, parameter settings, reference values, fault displays, contrast and the programmable buttons.

The desired submenu can also be entered from the main menu by using the menu buttons when the letter M and the number of the menu in question are visible on the first line of the display. See the SV9000 User's Manual and the SVReady Application Manual for the specific parameters available for the SV9000 setup needed.

The desired submenu can also be entered from the main menu by using the menu buttons when the letter M and the number of the menu

7

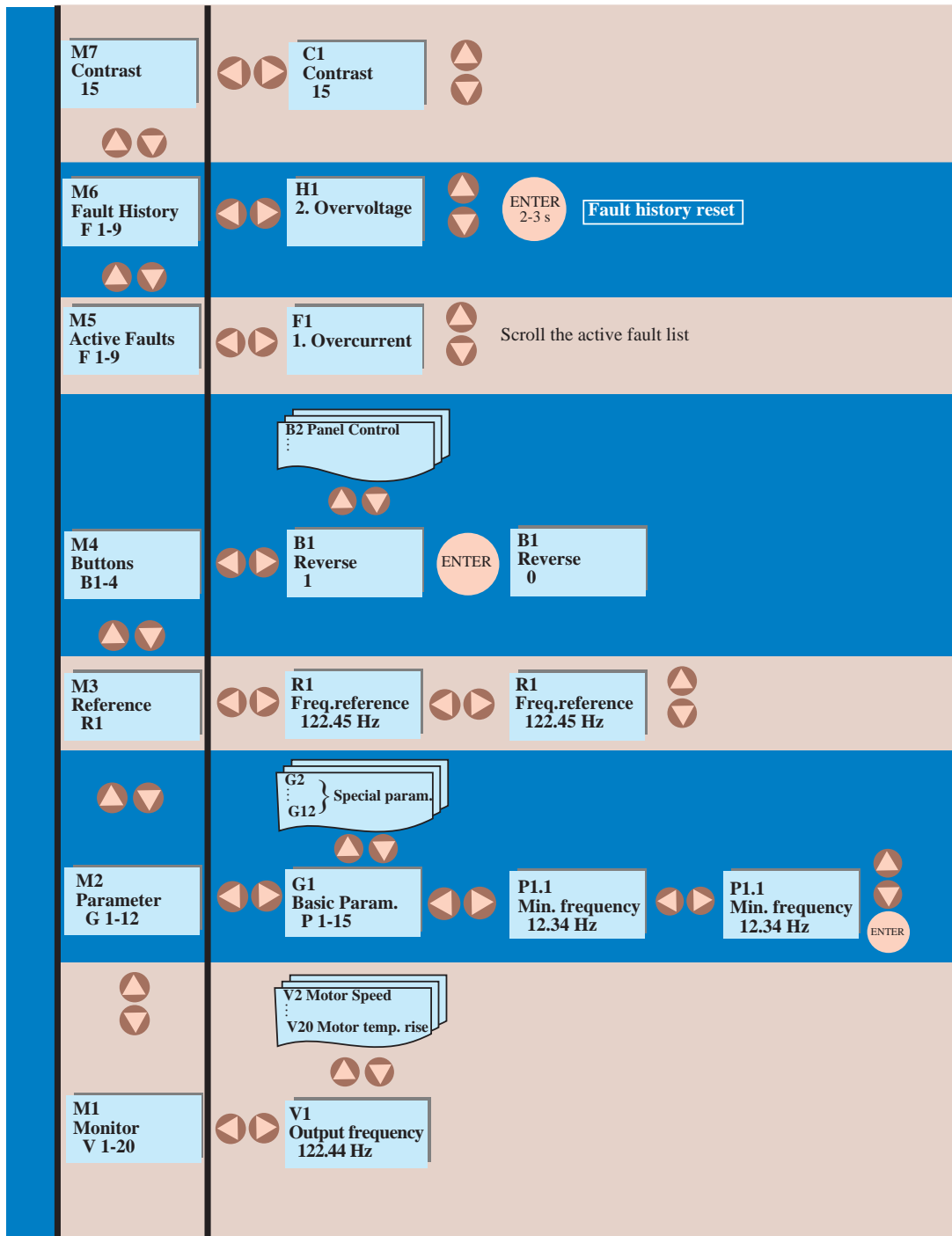

Figure 7.2-1 Panel operation



### 7.3 Monitoring menu

The monitoring menu can be entered from the main menu when the symbol **M1** is visible on the first line of the Multiline display. How to browse through the monitored values is presented in Figure 7.3-1. All monitored

signals are listed in Table 7.3-1. The values are updated once every 0.5 seconds. This menu is meant only for signal checking. The values cannot be altered here. See 7.4 Parameter group menu.

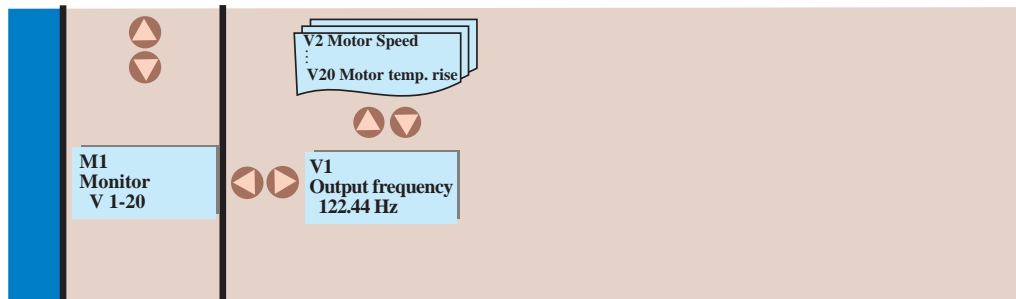

Figure 7.3-1 Monitoring menu

Number	Signal name	Unit	Description
V1	Output frequency	Hz	Frequency to the motor
V2	Motor speed	rpm	Calculated motor speed
V3	Motor current	A	Measured motor current
V4	Motor torque	%	Calculated actual torque/nominal torque of the unit
V5	Motor power	%	Calculated actual power/nominal power of the unit
V6	Motor voltage	V	Calculated motor voltage
V7	DC-link voltage	V	Measured DC-link voltage
V8	Temperature	°C	Heat sink temperature
V9	Operating day counter	DD.dd	Operating days <sup>1</sup> , not resettable
V10	Operating hours, "trip counter"	HH.hh	Operating hours <sup>2</sup> , can be reset with programmable button #3
V11	MW hours counter	MWh	Total MWh, not resettable
V12	MW hours, "trip counter"	MWh	Resettable with programmable button B4, section 7.6
V13	Voltage/analog input	V	Voltage of terminal $V_{in+}$ (term. #2)
V14	Current/analog input	mA	Current of terminals $I_{in+}$ and $I_{in-}$ (term. #4, #5)
V15	Digital input status, gr. A		See Figure 7.3-2
V16	Digital input status, gr. B		See Figure 7.3-3
V17	Digital and relay output status		See Figure 7.3-4
V18	Control program		Version number of the control software
V19	Unit nominal power	HP	Unit power size of the unit
V20	Motor temperature rise	%	100% = nominal motor temperature has been reached

<sup>1</sup> DD = full days, dd = decimal part of day

<sup>2</sup> HH = full hours, hh = decimal part of hour

Table 7.3-1 Monitored signals



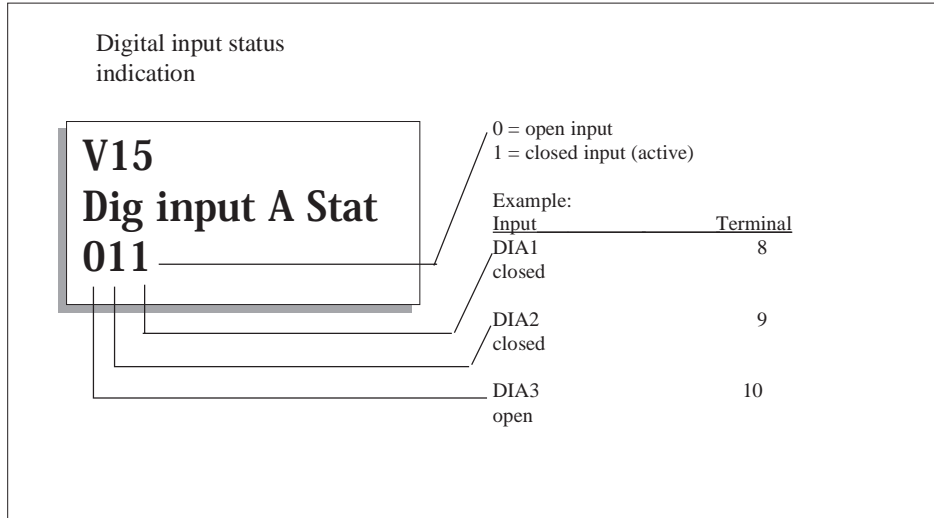

Figure 7.3-2 Digital inputs, Group A status.

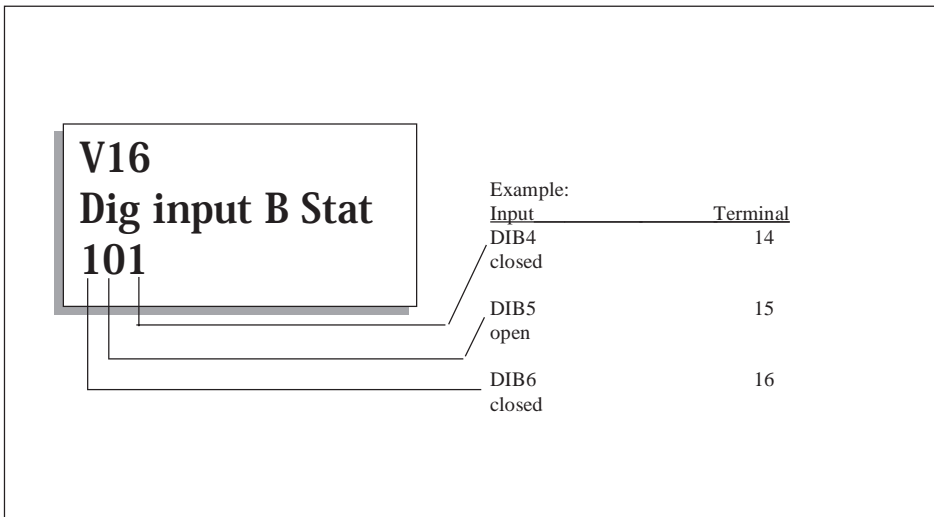

Figure 7.3-3 Digital inputs, Group B status.

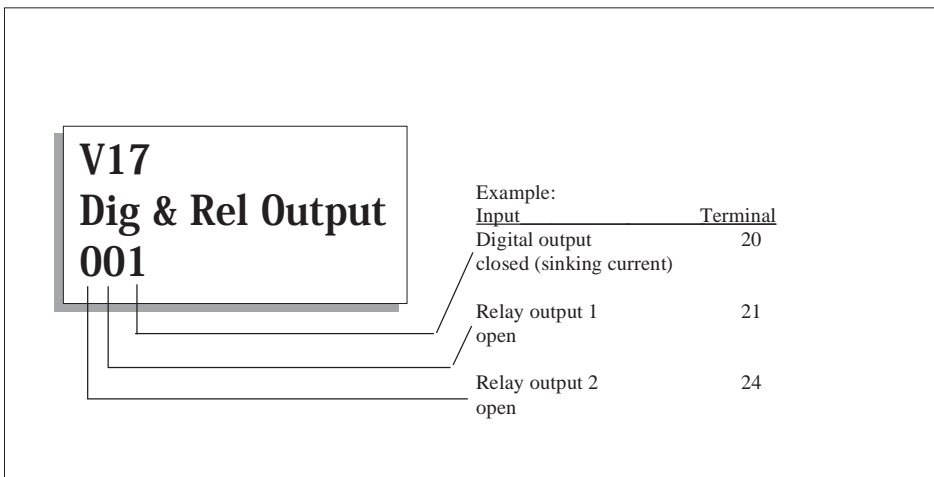

Figure 7.3-4 Output signal status.

7



## 7.4 Parameter group menu

The parameter group menu can be entered from the main menu when the symbol **M2** is visible on the first line of the Multiline display. Parameter values are changed in the parameter menu as shown in Figure 7.4-1:

Push the menu button (right) once to move into the parameter group menu (G) and twice to enter the desired parameter menu. Locate the parameter you want to change by using the browser buttons. Push the menu button (right) once again to enter the edit menu. Once you are in the edit menu, the symbol of the parameter starts to blink. Set the desired new value with the browser buttons and confirm the change by pushing the Enter button. Consequently, the blinking stops and the new value is visible in the value field. The value will not change unless the Enter button is pushed.

Several parameters are locked, i.e. uneditable, when the drive is in RUN status.

If you try to change the value of such a parameter, the text *\*locked\** will appear on the display.

You can return to the main menu anytime by pressing the Menu button (left) for 2-3 seconds.

The basic application embodies only those parameters necessary for operating the device. The parameter group 0 is accessible only by opening the Application package lock. See Chapter 11 of the SV9000 User's Manual.

Other applications include more parameter groups.

Once in the last parameter of a parameter group, you can move directly to the first parameter of that group by pressing the browser button (up).

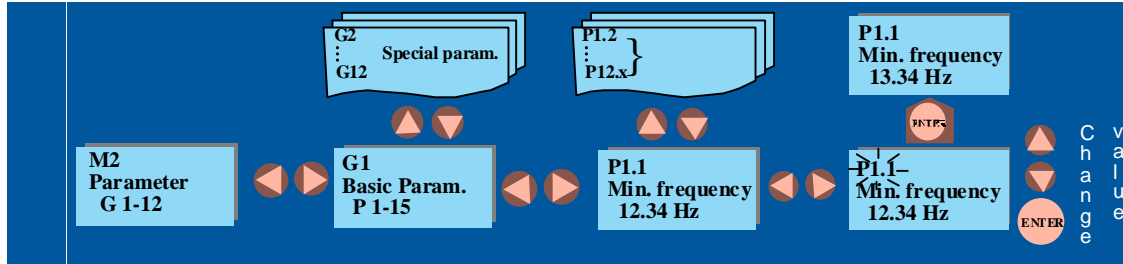

Figure 7.4-1 Parameter value change procedure

### 7.5 Reference menu

The reference menu can be entered from the main menu when the symbol **M3** is visible on the first line of the Multiline panel.

If the control panel is the active control source, the frequency reference can be changed by changing the value on the display with the browser buttons (for the selection of the active control source, see Chapter 7.6 Programmable push-button menu). See *Figure 7.5-1*.

Move deeper in the menu with the menu button (right) until the symbol **R1** starts to blink. Now you are able to alter the frequency reference value with the browser buttons. Pressing the Enter button is not necessary. Motor speed changes as soon as the frequency reference changes or the load inertia allows the motor to accelerate or decelerate.

In some applications, there might be several references.



Figure 7.5-1 Reference setting on the control panel



### 7.6 Programmable push-button menu

The programmable push-button menu can be entered from the main menu when the symbol **M4** is visible on the first line of the Multiline display. In this menu, there are four functions for the Enter button. The functions are available in this menu only. In other menus, the button is used for its original purpose. The status of the controlled function is shown through a feedback signal.

To change the button value, push the Enter button after which the new feedback value appears and the button sign **B** is replaced with a black square blinking together with the button number. After releasing the Enter button, the black square reverts to **B**. The new value stops blinking when the new value (e.g. reverse direction) has been received and put into operation. See Figure 7.6-1.

Enter the edit menu with the menu button (right). Then, the symbol **B1** starts to blink.

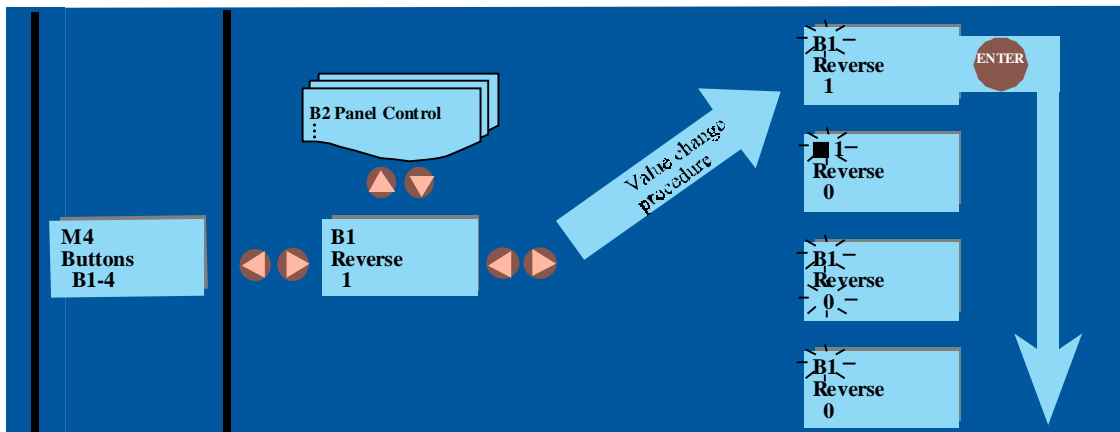

Figure 7.6-1 Programmable push-button

Button number	Button description	Function	Feedback information		
			0	1	Note
B1	Reverse	Changes the rotation direction of the motor. Available only when the control panel is the active control source	Forward	Reverse	Feedback information flashes as long as the command is carried out.
B2	Active control	Selection between I/O terminals and control panel	Control via I/O terminals	Control from the panel	
B3	Operating hours, trip counter reset	Resets the operating hours trip counter when pushed	No resetting	Resets the operating hours trip counter	
B4	MWh counter reset	Resets the MWh trip counter when pushed	No resetting	Resets the MWh trip counter	

Table 7.6-1 Programmable push-button descriptions



## 7.7 Active faults menu

The active faults menu can be entered from the main menu when the symbol **M5** is visible on the first line of the Multiline display as shown in Figure 7.7-1.

When a fault brings the frequency converter to a stop, the fault code (F#) and the description of the fault are displayed. If there are several faults at the same time, the list of active faults can be browsed with the browser buttons.

The display can be cleared with the Reset button and the read-out will return to the same display it had before the fault trip.

The fault remains active until it is cleared with Reset button or with a reset signal from the I/O terminal.

**Note! Remove any external Start signal before resetting the fault to prevent an unintentional restart.**



Figure 7.7-1 Active faults menu

Fault codes	Fault	Possible cause	Checking
F1	Overcurrent	SV9000 frequency converter has measured too high a current (>4*I <sub>n</sub> ) in the motor output: - sudden heavy load increase - short circuit in the motor cables - unsuitable motor	Check loading Check motor size Check cables
F2	Overvoltage	The voltage of the internal DC-link of the SV9000 frequency converter has exceeded the nominal voltage by 35% - deceleration time is too fast - high overvoltage spikes at utility	Adjust the deceleration time
F3	Ground fault	Current measurement detected that the sum of the motor phase current is not zero - insulation failure in the motor or the cables	Check the motor cables
F4	Inverter fault	SV9000 frequency converter has detected faulty operation in the gate drivers or IGBT bridge - interference fault - component failure	Reset the fault and restart again. If the fault occurs again contact your Cutler-Hammer distributor.
F5	Charging switch	Charging switch open when START command active - interference fault - component failure	Reset the fault and restart again. If the fault occurs again contact your Cutler-Hammer distributor.
F9	Undervoltage	DC-bus voltage has gone below 65% of the nominal voltage - most common reason is failure of the utility supply - internal failure of the SV9000 frequency converter can also cause an undervoltage trip	In case of temporary supply voltage break, reset the fault and start again. Check utility input. If utility supply is correct an internal failure has occurred. Contact your Cutler-Hammer distributor.
F10	Input line supervision	Input line phase is missing	Check the utility connection
F11	Output phase supervision	Current measurement has detected that there is no current in one motor phase	Check motor cables
F12	Brake chopper supervision	- brake resistor not installed - brake resistor broken - brake chopper broken	Check brake resistor If resistor is OK the chopper is broken. Contact your Cutler-Hammer distributor
F13	SV9000 undertemperature	Temperature of heat sink below -10°C	

Table 7.7-1 Fault codes



Fault codes	Fault	Possible cause	Checking
F14	SV9000 overtemperature	Temperature of heat sink over 75°C For Compact Nema 1 over 80 °C	Check the cooling air flow Check that the heat sink is not dirty Check ambient temperature Check that the switching frequency is not too high compared with ambient temperature and motor load
F15	Motor stalled	The motor stall protection has tripped	Check the motor
F16	Motor overtemperature	The SV9000 frequency drive motor temperature model has detected motor overheat - motor is overloaded	Decrease motor load. Check the temperature model parameters if the motor was not overheated
F17	Motor underload	The motor underload protection has tripped	Check the motor and possible belts etc
F18	Analog input hardware fault	Component failure on control board	Contact your Cutler-Hammer distributor.
F19	Option board identification	Reading of the option board has failed	Check the installation - If installation is correct, contact your Cutler-Hammer distributor
F20	10 V voltage reference	+10 V reference shorted on control board or option board	Check the cabling from +10 V reference voltage
F21	24 V supply	+24 V supply shorted on control board or option board	Check the cabling from +24 V reference voltage
F22 F23	EEPROM checksum fault	Parameter restoring error - interference fault - component failure	On resetting this fault the drive will automatically load the parameter default settings. Check all parameter settings after reset. If the fault occurs again contact your Cutler-Hammer distributor
F25	Microprocessor watchdog	- interference fault - component failure	Reset the fault and restart. If the fault occurs again contact your Cutler-Hammer distributor
F26	Panel communication error	The connection between panel and the SV9000 frequency drive is not working	Check the panel cable
F29	Thermistor protection	Thermistor input of the I/O expander board has detected increase of the motor temperature	Check motor cooling and loading Check the thermistor connection If there are no thermistors, make sure the inputs are short-circuited
F36	Analog input $I_m < 4\text{mA}$ (signal range selected 4-20 mA)	The analog input current $I_m$ is below 4 mA - signal source has failed - control cable is broken	Check the current loop circuitry
F41	External fault	An external fault has been detected at the digital input	Check the external fault source

Table 7.7-1 Fault codes (cont.)



### 7.8 Fault history menu

The fault history menu can be entered from the main menu when the symbol **M6** is displayed on the first line of the Multiline panel.

The memory of the drive can store the up to the 9 latest faults in the order of appearance. The most recent fault has the number 1, the second latest number 2 etc. If there are 9

uncleared faults in the memory, the next fault will erase the oldest from the memory.

Pressing the Enter button for about 2...3 seconds will reset the whole fault history. Then the symbol F# will change to 0.

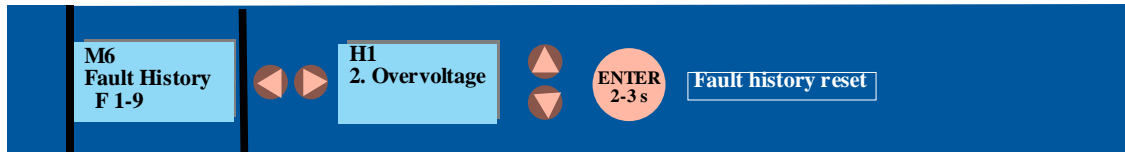

Figure 7.8-1. Fault history menu

### 7.9 Contrast menu

The contrast menu can be entered from the main menu when the symbol **M7** is visible on the first line of the Multiline display.

Use the menu button (right) to enter the edit

menu. You are in the edit menu when the symbol **C** starts to blink. Then change the contrast using the browser buttons. The changes take effect immediately.

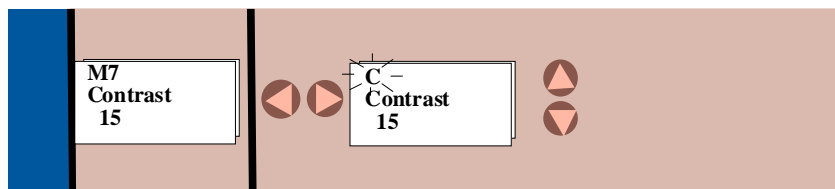

Figure 7.9-1. Contrast setting

### 7.10 Active warning display

When a warning occurs, a text with a symbol **A#** appears on the display. Warning codes are explained in Table 7.10-1.

The warning on the display does not disable the normal functions of the push buttons.

The display does not have to be cleared in any special way.

Code	Warning	Checking
<b>A15</b>	Motor stalled (Motor stall protection)	Check motor
<b>A16</b>	Motor overtemperature (Motor thermal protection)	Decrease motor loading
<b>A17</b>	Motor underload (Warning can be activated in SVReady applications)	Check motor loading
<b>A24</b>	The values in the Fault History, MWh counters or operating day/hour counters might have been changed in the previous mains interruption	Does not need any actions. Take a critical attitude to these values.
<b>A28</b>	The change of application has failed.	Choose the application again and push the Enter button.
<b>A30</b>	Unbalance current fault; the load of the segments is not equal.	Contact your Cutler-Hammer distributor.
<b>A45</b>	SV9000 frequency converter overtemperature warning; Temperature >70°C	Check the cooling air flow and the ambient temperature.
<b>A46</b>	Reference warning; the current of input $I_{in+}$ <4 mA (Warning can be activated in SVReady applications)	Check the current loop circuitry.
<b>A47</b>	External warning; (Warning can be activated in SVReady applications)	Check the external fault circuit or device.

Table 7.10-1 Warning codes

## 7.11 Controlling the motor from the panel

The SV9000 can be controlled from either the I/O terminals or the control panel. The active control source can be changed with the programmable push button b2 (see chapter 7.6). The motor can be started, stopped and the direction of rotation can be changed from the active control source.

### 7.11.1 Control source change from I/O terminals to the panel

After changing the control source the motor is stopped. The direction of rotation remains the same as with I/O control.

If the Start button is pushed at the same time as the programmable pushbutton B2, the Run state, direction of rotation and reference value are copied from the I/O terminals to the panel.

### 7.11.2 Control source change from panel to I/O

After changing the control source, the I/O terminals determine the run state, direction of rotation and reference value.

If the motor potentiometer is used in the application, the panel reference value can be copied as the motor potentiometer reference by pushing the start button at the same time as the programmable push button B2. The motor potentiometer function mode must be "resetting at stop state" (Local/Remote Application: param. 1. 5 =4, Multi-purpose Application : param. 1. 5 = 9).

## 8 STARTUP

### 8.1 Safety precautions

*Before startup, observe the following warnings and instructions:*



**1** Internal components and circuit boards (except the isolated I/O terminals) are at line potential when the SV9000 drive is connected to the utility. This voltage is extremely dangerous and may cause death or severe injury if you come in contact with it.

**2** When the SV9000 drive is connected to the utility, the motor connections U, V, W and DC-link / brake resistor connections -, + are live even if the motor is not running.

**3** Do not make any connections when the SV9000 drive is connected to the utility line.

**4** After disconnecting the utility, wait until the cooling fan on the unit stops and the indicators in the panel are turned off (if no panel check the indicators on the cover). Wait at least 5 minutes before doing any work on the SV9000 drive connections. Do not open cover before this time has run out.



**5** The control I/O terminals are isolated from the utility potential but the relay outputs and other I/O's (if jumper X4 is in the OFF position, see fig. 6.2.2-1) may have dangerous external voltages connected even if the power is off from the SV9000 drive.

**6** Before connecting the utility make sure that the cover of the SV9000 drive is closed.

**8**

### 8.2 Sequence of operation

**1** Read and follow the safety precautions

**2** After installation ensure that the:

- Drive and motor are connected to ground.
- Utility and motor cables are in accordance with the installation and connection instructions (chapter 6.1).
- Control cables are located as far as possible from the power cables (table 6.1.3-1), shields of the control cables are connected to the protective ground and wires do not have contact with any electrical components in the SV9000.
- The common input of digital input groups is connected to +24 V or ground of the I/O-terminal or external supply (See 6.2.3)



- 3 Check the quantity and quality of the cooling air (chapters 5.1 and 5.2).
- 4 Check that moisture has not condensed inside the SV9000 drive.
- 5 Check that all Start/Stop switches connected to the I/O terminals are in the **Stop** state.
- 6 Connect the SV9000 to the utility and switch the power ON.
- 7 Ensure that the parameters of the Group 1 match the application.

Set the following parameters to match the motor nameplate:

- nominal voltage of the motor
- nominal frequency of the motor
- nominal speed of the motor
- nominal current of the motor
- supply voltage

Look up the values from the nameplate of the motor.

## 8 Start-up test without motor

Perform either test A or B:

### **A** Control from the I/O terminals:

- turn Start/Stop switch to ON position
- change the frequency reference
- check from the Monitoring page of the control panel that the output frequency follows the frequency reference
- turn Start/Stop switch to OFF position

### **B** Control from the Control Panel:

- change control from the I/O terminals to the control panel with the programmable button B2, see chapter 7.6.
- push the Start button 
- go to the Reference Page and change the frequency reference



with the buttons , see chapter 7.5

- go to the Monitoring Page and check that the output frequency follows the reference, see chapter 7.3.
- push the Stop button 



- 9** If possible, make a start-up test with a motor which is not connected to the process. If the inverter has to be tested on a motor connected to the process, ensure it is safe to be powered up. Inform all possible co-workers about the tests.
- switch the utility power OFF and wait until the SV9000 has powered down according to chapter 8.1/ point 4
  - connect the motor cable to the motor and the power terminals of the SV9000
  - check that all start/stop switches connected to the I/O terminals are in the OFF state
  - switch the utility power ON
  - repeat test **A** or **B** of the test #8.
- 10** Connect the motor to the process (if the previous tests were done without the process)
- ensure it is safe to power up
  - inform all possible co-workers about the tests.
  - repeat test **A** or **B** of the test #8.



## 9 FAULT TRACING

When a fault trip occurs, the fault indicator is illuminated and the fault code and its description are displayed. The fault can be cleared with the Reset button or via an I/O terminal. The faults are stored to the fault history from where they can be viewed (see chapter 7.8). The fault codes are explained in table 9-1.

Fault codes	Fault	Possible cause	Checking
F1	Overcurrent	SV9000 frequency converter has measured too high a current ( $>4 \cdot I_n$ ) in the motor output: - sudden heavy load increase - short circuit in the motor cables unsuitable motor	Check load Check motor size Check cables
F2	Overvoltage	The voltage of the internal DC-link of the SV9000 frequency converter has exceeded the nominal voltage by 35% - deceleration time is too fast - high overvoltage spikes at utility	Adjust the deceleration time
F3	Ground fault	Current measurement detected that the sum of the motor phase current is not zero - insulation failure in the motor or the cables	Check the motor cables
F4	Inverter fault	SV9000 frequency converter has detected faulty operation in the gate drivers or IGBT bridge - interference fault - component failure	Reset the fault and restart again. If the fault occurs again contact your Cutler-Hammer distributor.
F5	Charging switch	Charging switch open when START command active - interference fault - component failure	Reset the fault and restart again. If the fault occurs again contact your Cutler-Hammer distributor.
F9	Undervoltage	DC-bus voltage has gone below 65% of the nominal voltage - most common reason is failure of the utility supply - internal failure of the SV9000 frequency converter can also cause an undervoltage trip	In case of temporary supply voltage break, reset the fault and start again. Check utility input. If utility supply is correct an internal failure has occurred. Contact your Cutler-Hammer distributor.
F10	Input line supervision	Input line phase is missing	Check the utility connection
F11	Output phase supervision	Current measurement has detected that there is no current in one motor phase	Check motor cables
F12	Brake chopper supervision	- brake resistor not installed - brake resistor broken - brake chopper broken	Check brake resistor If resistor is OK the chopper is broken. Contact your Cutler-Hammer distributor
F13	SV9000 under-temperature	Temperature of heat sink below $-10^\circ\text{C}$	



Fault codes	Fault	Possible cause	Checking
F14	SV9000 overtemperature	Temperature of heatsink over 75° C For Compact NEMA 1 over 80° C	Check the cooling air flow Check that the heat sink is clean Check the ambient temperature Check that the switching frequency is not too high for the ambient temperature and load.
F15	Motor stalled	The motor stall protection has tripped	Check the motor
F16	Motor overtemperature	The SV9000 motor temperature calculating model has calculated a motor overtemperature	Decrease motor load Check the temperature model parameters if the motor wasn't too hot.
F17	Motor underload	The motor underload protection has tripped	Check motor and possible belts etc.
F18	Analog input hardware fault	Component failure on the control card	Contact your Cutler-Hammer distributor
F19	Option board identification	Reading of the option board has failed	Check the installation of the board. If the installation is OK, contact your Cutler-Hammer distributor.
F20	10 V voltage reference	+ 10 V reference shorted on the control card or on an option board	Check the wiring connected to the + 10 V reference
F21	24 V supply	+ 24 V supply shorted on the control card or on an option board	Check the wiring connected to the + 24 V reference
F22 F23	EEPROM checksum failure	Parameter restoring error – interference – component failure	On resetting this fault, the drive will automatically load the parameter default settings. Check all parameters before restarting the drive. If the fault occurs again, contact your Cutler-Hammer distributor
F25	Microprocessor watchdog	– interference – component failure	Reset the fault and restart. If the fault occurs again, contact your Cutler-Hammer distributor
F26	Panel communication error	The connection between the drive and the panel doesn't work	Check the panel cable and connectors. If the fault occurs again, contact your Cutler-Hammer distributor
F29	Thermistor protection	The thermistor input on the I/O boards has detected a motor temperature increase.	Check the motor load and cooling. Check the thermistor connection. If there are no thermistors, make sure the inputs are short-circuited.
F36	Analog input $I_m < 4 \text{ mA}$ (signal range 4-20 mA selected)	The analog input current is below 4 mA – signal source failed – control cable broken.	Check the current loop circuitry
F41	External fault	An external fault has been detected at the digital input	Check the external fault source.



10 BASIC APPLICATION

10.1 General

The Basic Application is the default setting as delivered from the factory. Control I/O signals of the Basic application are fixed (not programmable) and it only has parameter Group 1.

Parameters are explained in chapter 10.4. The function of motor thermal and stall protection in the Basic Application is explained in chapter 10.5.

**\* NOTE!** Remember to connect the CMA and CMB inputs.

10.2 Control Connections

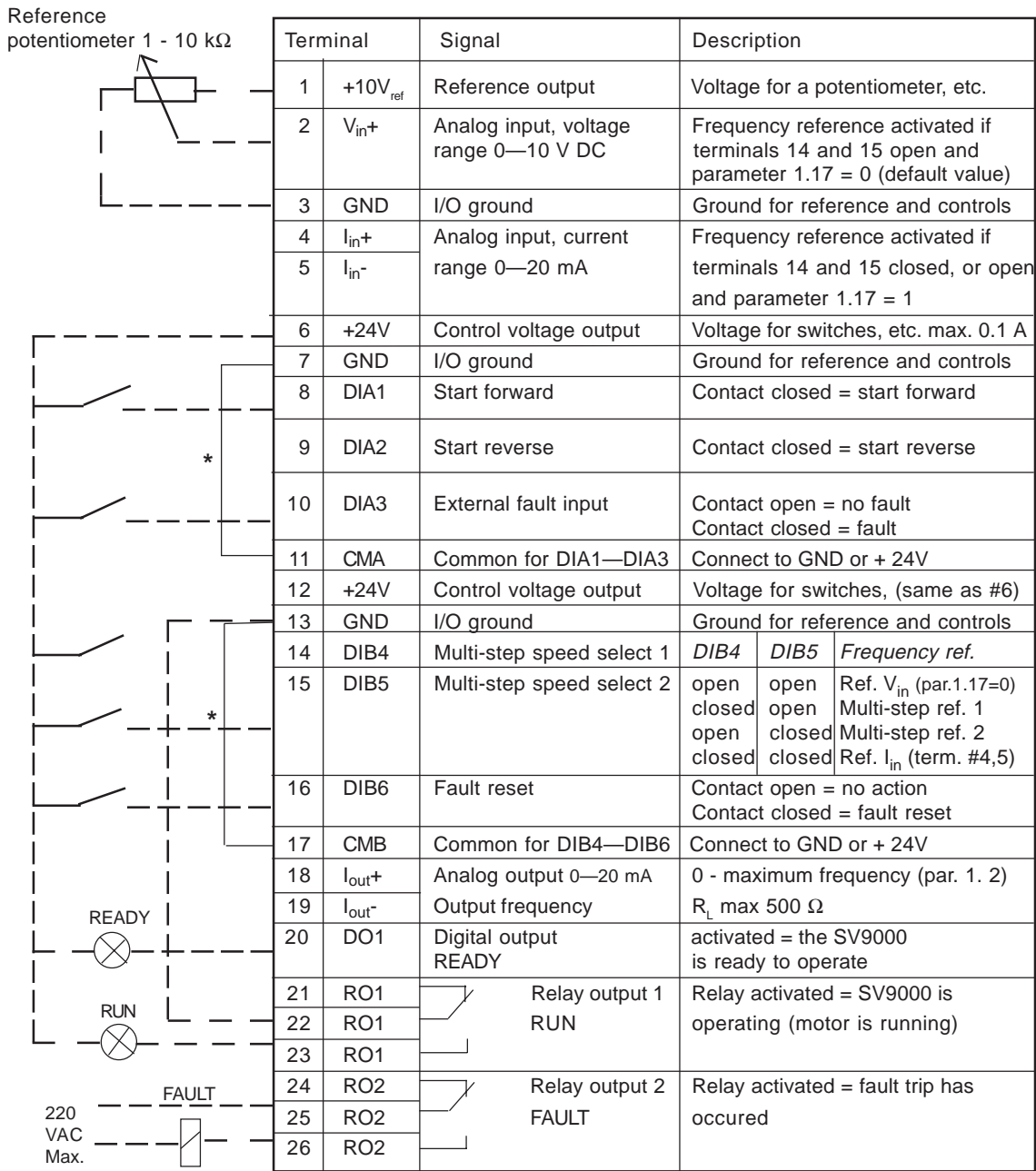

Figure 1.2-1 Control connection example.



### 10.3 Control Signal Logic

Figure 10.3.-1 shows the logic of the I/O control signals and push buttons.

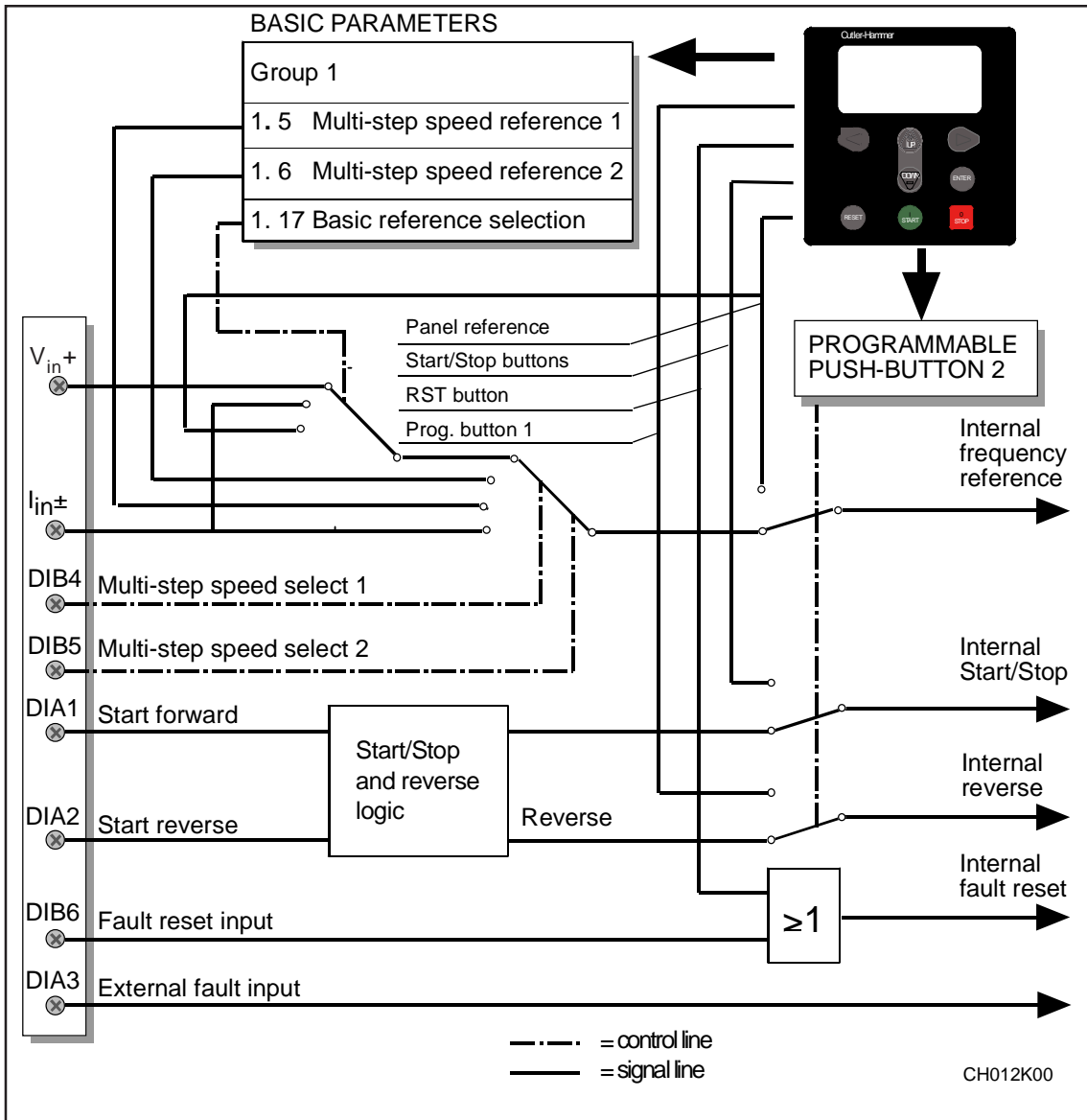

Figure 10.3-1 Control signal logic

If Start forward and Start reverse are both activated when the utility line is connected to the SV9000 then Start forward will be selected for the direction.

If Start forward and Start reverse are both activated when the control source is changed from the panel to the I/O-terminals then Start forward will be selected for the direction.

If both directions are selected the first selected direction has higher priority than the second selected.



## 10.4 Parameters, Group 1









Num.	Parameter	Range	Step	Default	Customer	Description	Page
1.1	Minimum frequency	0— $f_{max}$	1 Hz	0 Hz			69
1.2	Maximum frequency	$f_{min}$ -120/500 Hz	1 Hz	60 Hz		*	69
1.3	Acceleration time	0.1—3000.0 s	0.1 s	3.0 s		Time from $f_{min}$ (1.1) to $f_{max}$ (1.2)	69
1.4	Deceleration time	0.1—3000.0 s	0.1 s	3.0 s		Time from $f_{max}$ (1.2) to $f_{min}$ (1.1)	69
1.5	Multi-step speed reference 1	$f_{min}$ — $f_{max}$ (1.1) (1.2)	0.1 Hz	10 Hz			69
1.6	Multi-step speed reference 2	$f_{min}$ — $f_{max}$ (1.1) (1.2)	0.1 Hz	60 Hz			69
1.7	Current limit	0.1—2.5 x $I_{n SV9}$	0.1 A	1.5 x $I_{n SV9}$		Output current limit [A] of the unit	69
1.8	V/Hz ratio selection	 0—1	1	0		0 = Linear 1 = Squared	69
1.9	V/Hz optimization	 0—1	1	0		0 = None 1 = Automatic torque boost	70
1.10	Nominal voltage of the motor	 180—690 V	1 V	230 V 380 V 480 V 600 V		Voltage code 2 Voltage code 4 Voltage code 5 Voltage code 6	70
1.11	Nominal frequency of the motor	 30—500 Hz	1 Hz	60 Hz		$f_n$ from the nameplate of the motor	70
1.12	Nominal speed of the motor	 1—20000 rpm	1 rpm	1710 rpm **		$n_n$ from the nameplate of the motor	70
1.13	Nominal current of the motor ( $I_{n Mot}$ )	 2.5 x $I_{n SV9}$	0.1 A	$I_{n SV9}$		$I_n$ from the nameplate of the motor	71
1.14	Supply voltage	 208—240		230 V		Voltage code 2	71
		380—440		380 V		Voltage code 4	
		380—500		480 V		Voltage code 5	
		525—690		600 V		Voltage code 6	
1.15	Application package lock	0—1	1	1		0 = package lock open Application is selected by parameter 0.1	71
1.16	Parameter value lock	0—1	1	0		Disables parameter changes: 0 = changes enabled 1 = changes disabled	71
1.17	Basic frequency reference selection	 0—2	1	0		0 = analog input $V_{in}$ 1 = analog input $I_{in}$ 2 = reference from the panel	71
1.18	Analog input $I_{in}$ range	0—1	1	0		0 = 0—20 mA 1 = 4—20 mA	71

Table 10.4-1 Group 1 basic parameters

**Note!**  = Parameter value can be changed only when the SV9000 is stopped.

\* If 1.2 > motor synchr. speed, check suitability of motor and drive system.

\*\* Default value for a four pole motor and a nominal size SV9000.



### 10.4.1 Descriptions

#### 1. 1, 1. 2 Minimum/maximum frequency

Defines the frequency limits of the SV9000.

Default maximum value for parameters 1. 1 and 1. 2 is 120 Hz. By setting 1. 2 = 120 Hz in Stop state (RUN indicator not lit) and pressing the Enter key the maximum value of parameters 1. 1 and 1. 2 is changed to 500 Hz. At the same time the panel reference display resolution is changed from 0.01 Hz to 0.1 Hz. The max. value is changed from 500 Hz to 120 Hz when parameter 1. 2 is set to 119 Hz in Stop state and the Enter key is pressed.

#### 1. 3, 1. 4 Acceleration time, deceleration time :

These limits correspond to the time required for the output frequency to accelerate from the set minimum frequency (par. 1. 1) to the set maximum frequency (par. 1. 2).

#### 1. 5, 1. 6 Multi-step speed reference 1, Multi-step speed reference 2:

Parameter values are limited between minimum and maximum frequency.

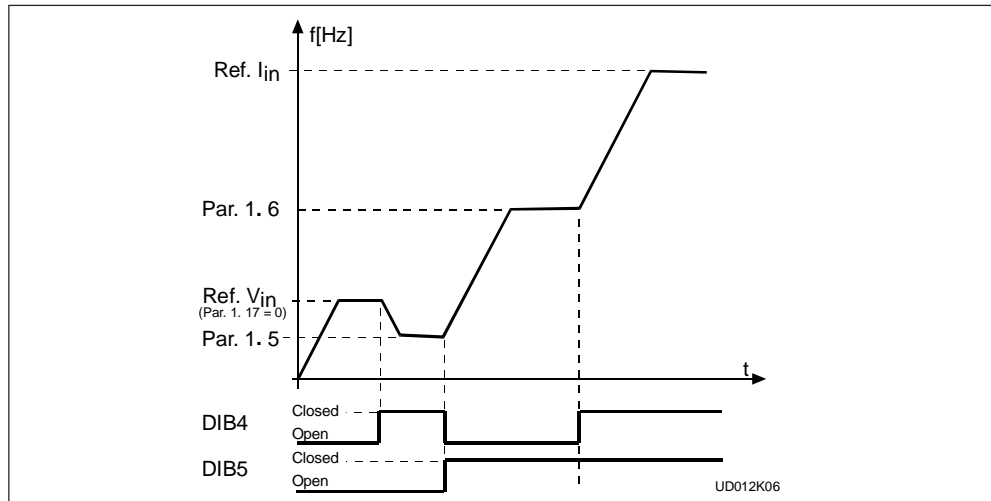

Figure 10.4.1-1 Example of Multi-step speed references.

#### 1. 7 Current limit

This parameter determines the maximum motor current that the SV9000 will provide short term.

#### 1. 8 V/Hz ratio selection

Linear: The voltage of the motor changes linearly with the frequency from 0 Hz to the nominal frequency of the motor. The nominal voltage of the motor is supplied at this frequency. See figure 10.4.1-2.

Linear V/Hz ratio should be used in constant torque applications.

**This default setting should be used if there is no special requirement for another setting.**

**Squared:** The voltage of the motor changes following a squared curve from 0 Hz to the nominal frequency of the motor. The Nominal voltage of the motor is supplied at this frequency. See figure 10.4.1-2.

1

The motor runs undermagnetized below the nominal frequency and it produces less torque and electromechanical noise.

A squared V/Hz ratio can be used in applications where the torque demand from the load is proportional to the square of the speed, e.g. in centrifugal fans and pumps.

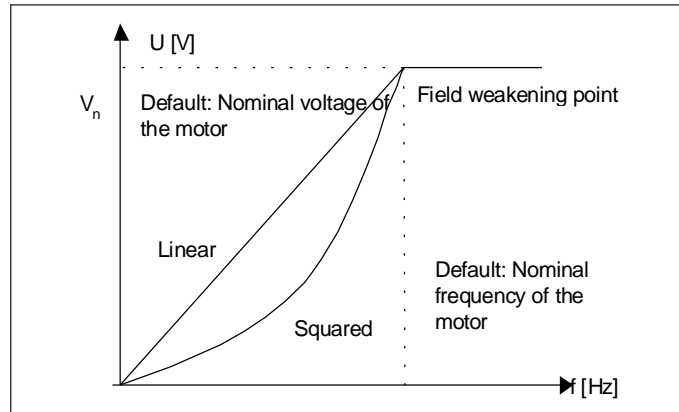

Figure 10.4.1-2 Linear and squared V/Hz curves.

## 1.9 V/Hz optimization

**Automatic torque boost** The voltage to the motor changes automatically which allows the motor to produce sufficient torque to start and run at low frequencies. The voltage increase depends on the motor type and horsepower. Automatic torque boost can be used in applications where starting torque due to starting friction is high, e.g. in conveyors.

**NOTE!**



*In high torque - low speed applications - it is likely the motor will overheat. If the motor has to run for a prolonged time under these conditions, special attention must be paid to cooling the motor. Use external cooling for the motor if the operating temperature rise is too high.*

10

### 1.10 Nominal voltage of the motor

Find the rated voltage  $V_n$  from the nameplate of the motor.

**Note!** If the nominal motor voltage is lower than the supply voltage, check that the insulation level of the motor is adequate.

### 1.11 Nominal frequency of the motor

Find the value  $f_n$  from the nameplate of the motor.

### 1.12 Nominal speed of the motor

Find the value  $n_n$  from the nameplate of the motor.

### 1.13 Nominal current of the motor

Find the value  $I_n$  from the nameplate of the motor. The internal motor protection function uses this value as a reference value.





**1. 14 Supply voltage**

Set parameter value according to the nominal voltage of the supply. Values are predefined for voltage codes 2, 4, 5 and 6 see table 10.4-1.

**1. 15 Application package lock**

The application package lock can be opened by setting the the value of the parameter 1.15 to 0. It will then be possible to enter the parameter group 0 from parameter 1.1 by pressing arrow down button (see figure 11-1). The number of the Application can be selected from the table 11-1 and it is selected by the value of parameter 0.1. After this, the new Application is in use and its parameters will be found in the SVReady Application manual.

**1. 16 Parameter value lock**

Defines access to the changes of the parameter values:

- 0 = parameter value changes enabled
- 1 = parameter value changes disabled

**1. 17 Basic frequency reference selection**

- 0 Analog voltage reference from terminals 2—3, e.g. a potentiometer
- 1 Analog current reference from terminals 4—5, e.g. a transducer.
- 2 Panel reference is the reference set from the Reference Page (REF), see chapter 7.5.

**1. 18 Analog input  $I_{in}$  range**

Defines the minimum value of the Analog input  $I_{in}$  signal (terminals 4,5).



**10.5 Motor protection functions in the Basic Application**

**10.5.1 Motor thermal protection**

Motor thermal protection protects the motor from overheating. In the Basic application, Motor thermal protection uses constant settings and always causes a fault trip if the motor is overheated. To switch off the protection or to change the settings, see SVReady application manual.

Your SV9000 is capable of supplying higher than nominal current to the motor. If the load requires this high current there is a risk that motor will be thermally overloaded. This is true especially at low frequencies, as the cooling effect and thermal capacity of the motor are reduced. The motor thermal protection is based on a calculated model which uses the output current of the drive to determine the load on the motor.

The thermal current  $I_T$  specifies the load current above which the motor is overloaded. See figure 10.5.1-1. If the motor current is above the curve, the motor temperature is increasing.

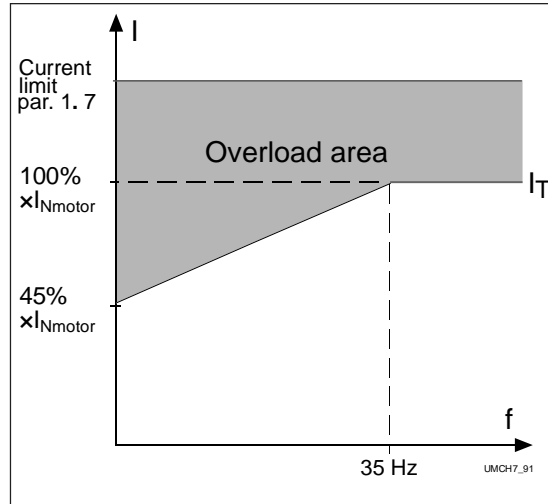



Figure 10.5.1-1 Motor thermal current  $I_T$  curve.

	<p><b>CAUTION!</b> <i>The calculated model does not protect the motor if the airflow to the motor is reduced by an air intake grill that is blocked</i></p>
---	---

**10.5.2 Motor Stall warning**

In the Basic application, motor stall protection gives a warning of a short time overload of the motor e.g. a stalled shaft. The reaction time of this stall protection is shorter than the motor thermal protection time. The stall state is defined by Stall Current and Stall Frequency.

Both parameters have constant values. See figure 10.5.2-1. If the current is higher than the set limit and the output is lower than the set limit the stall state is true. If the stall state lasts longer than 15 s the stall warning is given on the display. To change the stall warning to a fault trip or to change the protection settings, see the SVReady application manual

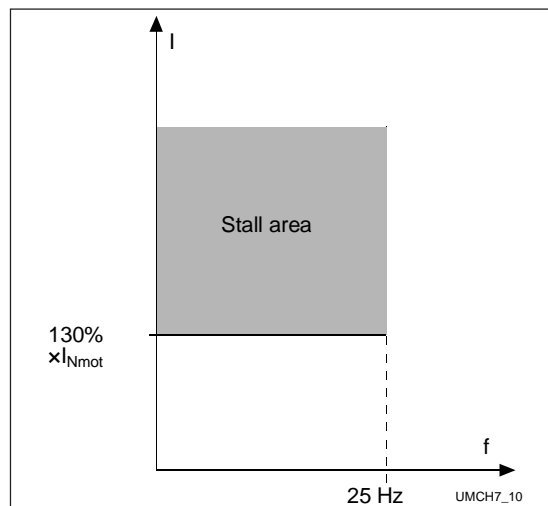

Figure 10.5.2-1 Stall state.



## 11 System parameter group 0

When the application package lock is open (par. 1.15 = 0) the system parameter group 0 can be accessed. Parameter group 0 can be entered from parameter 1.1 by the pressing arrow down button. The parameters of group 0 are shown in table 11-1.

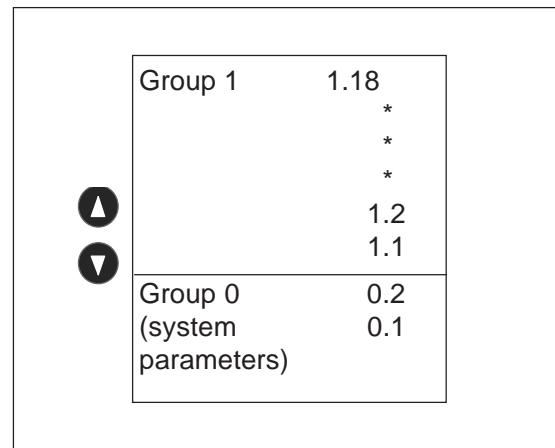

Figure 11-1 Group 0.

### 11.1 Parameter table

Number	Parameter	Range	Description	Page
0.1	Application selection	1—7	1 = Basic Application 2 = Standard Application 3 = Local / Remote Control Application 4 = Multi-step Speed Application 5 = PI-control Application 6 = Multi-purpose Control Application 7 = Pump and fan control Application	74
0.2	Parameter loading	0—5	0 = Loading ready / Select loading 1 = Load default settings 2 = Read up parameters to user's set 3 = Load down user's set parameters 4 = Read parameters up to the panel (possible only with the graphic panel) 5 = Load down parameters from the panel (possible only with graphic panel)	75
0.3	Language selection	0—5	0 = English 1 = German 2 = Swedish 3 = Finnish 4 = Italian 5 = French	75

Table 11-1 System parameters, Group 0.

### 11.2 Parameter descriptions

#### 0.1 Application selection

With this parameter the Application type can be selected. The default setting is the Basic Application. Applications are described in chapter 12.

## 0.2 Parameter loading

With this parameter it is possible to do several types of parameter load operations. After the operation is completed this parameter value changes automatically to 0 (loading ready).

### 0 Loading ready / Select loading

Loading operation has been completed and the drive is ready to operate.

### 1 Load default settings

By setting the value of parameter 0.2 to 1 and then pressing the Enter-button the parameter default values for the application selected with parameter 0.1 are loaded. Use this when you want to restore the default set.

### 2 Read up parameters to User's set

Set the value of parameter 0.2 to 2 and press the Enter-button to store the active parameter values, set A, in back-up memory as the User's parameter value set B. The parameter values can later be reloaded as the active set by setting parameter 0.2 to 3 and pressing the Enter button. See Figure 11-2.

### 3 Load down user's set parameters

Set the value of parameter 0.2 to 3 and press the Enter-button to reload the users' set B as the active set A. The User's set is intended to function as a backup in the case you have a good set of parameters that for some reason is lost or changed. See Figure 11-2.

### 4 Read parameters up to the panel (possible only with the graphic panel).

Copies the active parameter set A to the memory in the graphical panel

### 5 Load down parameters from the panel (possible only with the graphic panel).

Copies the parameter set in the graphical panel as the active parameter set A

**NOTE! The panel read and load operations work only on drives of the same power and voltage rating.**

## 0.3 Language selection

This parameter selects the language of the text displayed on the panel.

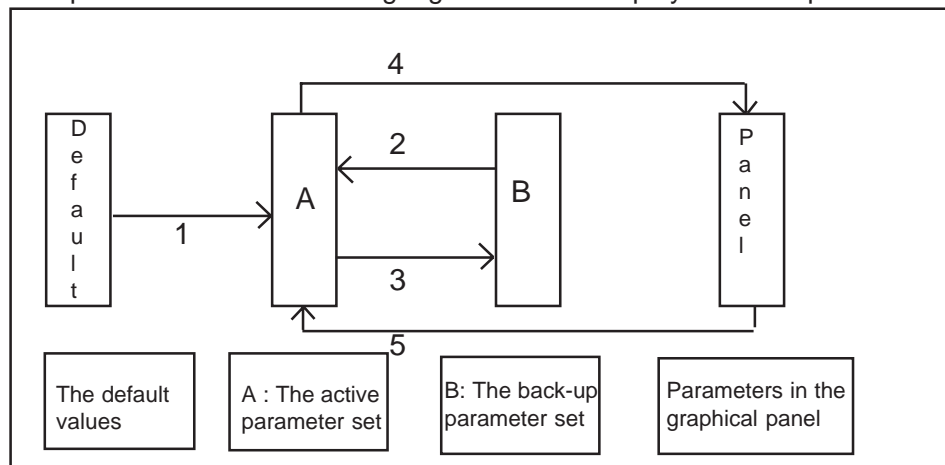

Figure 11-2 Relation of the various parameter sets

## 12 SVReady™ application package

### 12.1 Application Selection

To use one of the SVReady applications, first open the Application package lock (parameter 1.15). Group 0 then comes visible (see figure 11-1). Changing the value of parameter 0.1 changes the active application. See table 11-1.

Applications are presented in sections 12.2 - 12.7 and in more detail in the following, separate SVReady application manual.

### 12.2 Standard Application

The Standard Application has the same I/O signals and same Control logic as the Basic application.

Digital input DIA3 and all outputs are freely programmable.

Other additional functions:

- Programmable Start/Stop and Reverse signal logic
- Reference scaling
- One frequency limit supervision
- Second set of ramps and choice of linear or S curve
- Programmable start and stop functions
- DC-braking at stop
- One prohibit frequency lockout range
- Programmable V/Hz curve and switching frequency
- Autorestart function
- Motor Thermal and Stall protection off / warning / fault programming

### 12.3 Local/Remote Application

Utilizing the Local/Remote Control Application the use of two different control and frequency reference sources is programmable. The active control source is selected with digital input DIB6. All outputs are freely programmable.

Other additional functions:

- Programmable Start/stop and Reverse signal logic
- Analog input signal range selection
- Two frequency in band limit indications
- Torque in band limit indication
- Reference in band limit indication
- Second set of ramps and choice of linear or S curve
- DC-braking at start and stop
- Three prohibit frequency lockout ranges

- Programmable V/Hz curve and switching frequency
- Autorestart function
- Motor Thermal and Stall protection fully programmable
- Motor Underload protection
- Unused analog input functions

### 12.4 Multi-step Speed Application

The Multi-step Speed Control Application can be used where fixed speed references are required. 9 different speeds can be programmed: one basic speed, 7 multi-step speeds and one jogging speed. The speed steps are selected with digital signals DIB4, DIB5 and DIB6. If the jogging speed is used DIA3 can be programmed for jogging speed select

The basic speed reference can be either voltage or current signal via analog input terminals (2/3 or 4/5). All outputs are freely programmable.

Other additional functions:

- Programmable Start/stop and Reverse signal logic
- Analog input signal range selection
- Two frequency in band limit indications
- Torque in band limit indication
- Reference in band limit indication
- Second set of ramps and choice of linear or S curve
- DC-braking at start and stop
- Three prohibit frequency lockout ranges
- Programmable V/Hz curve and switching frequency
- Autorestart function
- Motor Thermal and Stall protection fully programmable
- Motor Underload protection
- Unused analog input functions



## 12.5 PI-control Application

In the PI-control Application, there are two I/O-terminal control sources. Source A is a PI-controller and source B is a direct frequency reference. The control source is selected with the DIB6 input.

The PI-controller reference can be selected from the analog inputs, motor potentiometer, or panel reference. The actual value can be selected from the analog inputs or from a mathematical function acting on the analog inputs. The direct frequency reference can be used for control without the PI-controller. The frequency reference can be selected from the analog inputs or the panel reference.

All outputs are freely programmable.

Other additional functions:

- Programmable Start/stop and Reverse signal logic
- Analog input signal range selection
- Two frequency in band limit indications
- Torque in band limit indication
- Reference in band limit indication
- Second set of ramps and choice of linear or S curve
- DC-braking at start and stop
- Three prohibit frequency lockout ranges
- Programmable V/Hz curve and switching frequency
- Autorestart function
- Motor Thermal and Stall protection fully programmable
- Motor Underload protection

## 12.6 Multi-purpose Control Application

In the Multi-purpose Control Application, the frequency reference can be selected from the analog inputs, joystick control, motor potentiometer, or a mathematical function of the analog inputs. Multi-step speeds and jog speed can also be selected if the digital inputs are programmed for these functions

Digital inputs DIA1 and DIA2 are reserved for Start/stop logic. Digital inputs DIA3 - DIB6 are programmable for multi-step speed select, jog speed select, motor potentiometer, external fault, ramp time select, ramp prohibit, fault reset and DC-brake command function. All outputs are freely programmable.

Other additional functions:

- Programmable Start/stop and Reverse signal logic
- Analog input signal range selection
- Two frequency in band limit indications
- Torque in band limit indication
- Reference in band limit indication
- Second set of ramps and choice of linear or S-curve
- DC-braking at start and stop
- Three prohibit frequency lockout ranges
- Programmable V/Hz curve and switching frequency
- Autorestart function
- Motor Thermal and Stall protection fully programmable
- Motor Underload protection
- Free analog input functions

## 12.7 Pump and Fan Control Application

The Pump and Fan Control Application can be used to control one variable speed drive and 0-3 auxiliary drives. The PI-controller of the frequency converter controls the speed of the variable speed drive and gives control signals to Start and Stop auxiliary drives to control the total flow.

The application has two control sources on I/O terminal. Source A is Pump and fan control and source B is direct frequency reference. The control source is selected with DIB6 input.

All outputs are freely programmable.

Other additional functions:

- Programmable Start/stop and reverse signal logic
- Analog input signal range selection
- Two frequency in band limit indications
- Torque in band limit indication
- Reference in band limit indication
- Second set of ramps and choice of linear or S curve
- DC-braking at start and stop
- Three prohibit frequency lockout ranges
- Programmable V/Hz curve and switching frequency
- Autorestart function
- Motor Thermal and Stall protection fully programmable
- Motor Underload protection



## 13 Options

### 13.1 External filters

Information of SV9000 external input and output filters (RFI, dV/dT, and Sinusoidal-filters) can be found in their separate manuals.

### 13.2 Dynamic braking

Effective motor braking and short deceleration times are possible by using an external or internal braking chopper with an external brake resistor.

The internal braking chopper is assembled in the factory (available in certain models). It has the same continuous current specification as the unit itself.

Select the correct brake resistor to get the desired braking effect. More information can be found in the separate brake manual.

### 13.3 I/O- expander board

The available I/O can be increased by using the I/O- expander boards. I/O-expander boards can be installed in the option board position inside the open, protected, NEMA 1 and NEMA 12 SV9000 models. For the Compact NEMA 1 model the board needs to be installed in a separate I/O-expander box.

More information can be found in the I/O-expander board manuals.

### 13.4 Communication

SV9000 frequency converters can be connected to DeviceNet, Modbus RTU, Interbus-S, Profibus-DP and Lonworks systems by using the fieldbus option board.

The fieldbus board can be installed in the option board position inside the open, protected, NEMA 1 and NEMA 12 SV9000 models. For the compact NEMA 1 model the board needs to be installed in a separate I/O-expander box.

More information can be found in the separate communication manuals.

### 13.6 SVGraphic™ control panel

The SVGraphic control panel can be used in place of the standard 3 line LCD panel. It provides:

- parameters, monitored items etc. in text format
- 3 monitored items at the same time in display
- one monitored item can be shown in increased text size with a graph bar
- The selected parameter value is shown on a graph bar
- 3 monitored items can be shown on the graphical trend display
- the parameters of the frequency converter can be uploaded to the panel and then downloaded to another inverter.

More information can be found in the SVGraphic™ Panel manual.

### 13.7 SVDRIVE™

SVDrive is the PC based tool for control and monitoring of the SV9000. With SVDrive:

- parameters can be loaded from the SV9000, changed, saved to a file or loaded back to the SV9000 - parameters can be printed to paper or to a file
- references can be set
- the motor can be started and stopped
- signals can be examined in graphical form
- actual values can be displayed

The SV9000 can be connected to a PC with a special RS232-cable, catalog number SVDRIVECABLE. The same cable can be used for downloading specialized applications to the SV9000.

### 13.8 Operator panel door installation kit

An adapter kit is available to mount the operator display panel on an enclosure door.

### 13.9 Protected chassis cable cover for 75 - 125 HP open panel units

This optional cable cover provides a protected chassis capability equivalent to IP20.



