



SIEMENS

MICROMASTER 420/430/440

Getting Started Guide 入门指南



English	<p>Warnings, Cautions and Notes The following Warnings, Cautions and Notes are provided for your safety and as a means of preventing damage to the product or components in the machines connected.</p> <p>Specific Warnings, Cautions and Notes that apply to particular activities are listed at the beginning of the relevant sections. Please read the information carefully, since it is provided for your personal safety and will also help prolong the service life of your inverter and the equipment you connect to it.</p>
Deutsch	<p>Warnungen, Vorsichtshinweise und Hinweise Die nachstehenden Warnungen, Vorsichtshinweise und Hinweise sind für die Sicherheit des Benutzers vorgesehen sowie als Hilfsmittel, um Schaden an dem Erzeugnis oder an Teilen der angeschlossenen Maschine zu verhindern.</p> <p>Spezifische Warnungen, Vorsichtshinweise und Hinweise, die für bestimmte Tätigkeiten gelten, sind am Anfang der jeweiligen Abschnitte zusammengestellt. Bitte diese Informationen sorgfältig lesen, da sie für Ihre persönliche Sicherheit bestimmt sind und auch eine längere Lebensdauer des Umrichters und der daran angeschlossenen Geräte unterstützen.</p>
Français	<p>Avertissements et remarques Les avertissements et remarques figurant dans la suite sont donnés pour assurer la sécurité de l'utilisateur ainsi que pour prévenir des dommages sur le produit ou sur des éléments de la machine raccordée.</p> <p>Les avertissements et remarques spécifiques, applicables à certaines activités, sont regroupés au début du chapitre correspondant. Prière de lire attentivement ces informations car elles sont importantes pour votre sécurité personnelle ainsi que pour assurer une longue durée de vie du variateur ainsi que des appareils raccordés.</p>
Español	<p>Advertencias, precauciones y notas Las presentes advertencias, precauciones y notas están pensadas para su seguridad y como medio para prevenir daños en el producto o en componentes situados en las máquinas conectadas.</p> <p>Advertencias, precauciones y notas específicas aplicables en actividades particulares figuran al comienzo de los capítulos o apartados correspondientes. Rogamos leer cuidadosamente la información ya que se entrega para su seguridad personal y le ayudará a prolongar la vida útil de su convertidor y el equipo que conecte al mismo.</p>
Italiano	<p>Avvertenze tecniche di sicurezza La presente guida operativa contiene avvertenze tecniche relative alla sicurezza delle persone ed alla prevenzione dei danni materiali che vanno assolutamente osservate.</p> <p>Le avvertenze, contrassegnate da un triangolo, a seconda del grado di pericolo, sono chiamate Pericolo, Attenzione, Avvertenze e sono di solito riportate all'inizio dei vari capitoli. Si raccomanda di leggere con attenzione le informazioni fornite, in quanto sono state stilate per garantire l'incolumità personale e per contribuire a prolungare la durata di funzionamento sia dell'Inverter sia delle apparecchiature ad esso collegate.</p>

English	Deutsch	Français
<p> Warnings</p> <ul style="list-style-type: none"> ➤ This equipment contains dangerous voltages and controls potentially dangerous rotating mechanical parts. Non-compliance with Warnings or failure to follow the instructions contained in this manual can result in loss of life, severe personal injury or serious damage to property. ➤ Only suitably qualified personnel should work on this equipment, and only after becoming familiar with all safety notices, installation, operation and maintenance procedures contained in this manual. The successful and safe operation of this equipment is dependent upon its proper handling, installation, operation and maintenance. ➤ The DC link of all MICROMASTER modules remains at a hazardous voltage level for 5 minutes after all voltages have been disconnected. Therefore always wait for 5 minutes after disconnecting the inverter from the power supply before carrying out work on any MICROMASTER modules. ➤ This equipment is capable of providing internal motor overload protection in accordance with UL508C section 42. Refer to P0610 (level 3) and P0335. Motor overload protection can also be provided using an external PTC via a digital input. ➤ This equipment is suitable for use in a circuit capable of delivering not more than 10,000 (Frame Sizes A to C) or 42,000 (Frame Sizes D to GX) symmetrical amperes (rms), for a maximum voltage of: <ul style="list-style-type: none"> - MM420 = 230 V / 460 V - MM430 = 460 V - MM440 = 230 V / 460 V / 575 V ➤ when protected by an H, J or K type fuse, a circuit breaker or self-protected combination motor controller (for more details see Operating Instructions Appendix F). ➤ Class 1 60/75 °C copper wire only. 	<p> Warnungen</p> <ul style="list-style-type: none"> ➤ Das vorliegende Gerät führt gefährliche Spannungen und steuert umlaufende mechanische Teile, die gegebenenfalls gefährlich sind. Die Missachtung der Warnungen oder das Nichtbefolgen der in dieser Anleitung enthaltenen Anweisungen kann Lebensgefahr, schwere Körperverletzung oder schwerwiegenden Sachschaden bewirken. ➤ An diesen Geräten darf nur geeignetes, qualifiziertes Personal arbeiten, und nur, nachdem es sich mit allen Sicherheitshinweisen, Installations-, Betriebs- und Wartungsanweisungen, die in dieser Anleitung vorhanden sind, vertraut gemacht hat. Der erfolgreiche und gefahrlose Betrieb des Gerätes hängt von seiner ordnungsgemäßen Handhabung, Installation, Bedienung und Wartung ab. ➤ Der Zwischenkreis aller MICROMASTER-Geräte behält nach dem Abtrennen sämtlicher Spannungen 5 Minuten lang eine gefährliche Spannung bei. Deshalb vor dem Durchführen von Arbeiten an einer der MICROMASTER-Baugruppen nach dem Abtrennen des Umrichters von der Stromversorgung 5 Minuten abwarten. ➤ Dieses Gerät kann inneren Motorüberlastungsschutz gemäß UL508C, Abschnitt 42, herstellen. Siehe P0610 (Stufe 3) und P0335. Motorüberlastungsschutz kann auch durch Verwendung eines externen PTC (Kaltleiters) über einen Digitaleingang hergestellt werden. ➤ Dieses Gerät kann in Netzen eingesetzt werden, die einen symmetrischen Strom von höchstens 10 kA (eff) (Bauformen A bis C) bzw. 42 kA (eff) (Bauformen D bis GX) bei einer maximalen Spannung von: <ul style="list-style-type: none"> - MM420 = 230 V / 460 V - MM430 = 460 V - MM440 = 230 V / 460 V / 575 V ➤ wenn es durch eine Sicherung vom Typ H, J oder K, einen Leitungsschutzschalter oder durch einen abgesicherten Motorzweig geschützt ist (weitere Details siehe Betriebsanleitung Anhang F). ➤ Klasse 1 60/75 °C, nur Kupferdraht. 	<p> Attention</p> <ul style="list-style-type: none"> ➤ Le présent appareil est le siège de tensions dangereuses et pilote des pièces mécaniques rotatives qui peuvent présenter une source de danger. Le non-respect des avertissements ainsi que des consignes de sécurité figurant dans cette notice peuvent entraîner la mort, des blessures graves ou des dommages matériels importants. ➤ Seules des personnes qualifiées sont habilitées à intervenir sur cet appareil, et cela uniquement après qu'elles se soient familiarisées avec toutes les consignes de sécurité, les instructions d'installation, d'exploitation et de maintenance mentionnées dans cette notice. ➤ Le fonctionnement correct et sûr de cet appareil présuppose une manipulation, une installation, utilisation et une maintenance conformes aux règles de l'art. Sur tous les MICROMASTER, il subsiste une tension élevée dans le circuit intermédiaire pendant les 5 minutes qui suivent la mise hors tension. Après coupure du variateur, il faudra par conséquent attendre le temps nécessaire avant d'intervenir sur les modules du MICROMASTER. ➤ Cet appareil est capable d'offrir une protection interne de la surcharge thermique du moteur conforme à UL 508C section 42. Se reporter à P0610 (Niveau 3) et P0335. La protection de surcharge thermique du moteur peut également être assurée par une sonde CTP montée sur le moteur. ➤ Cet appareil peut être utilisé dans des réseaux qui fournissent un courant symétrique de 10 kA (eff) (Formes de construction (tailles) A à C) ou 42 kA (Formes de construction (tailles) D à GX) maximum avec une tension maximale de : <ul style="list-style-type: none"> - MM420 = 230 V / 460 V - MM430 = 460 V - MM440 = 230 V / 460 V / 575 V ➤ lorsqu'il est protégé par un fusible de type H, J ou K, un disjoncteur de protection ou une dérivation de moteur protégée par fusible (pour plus de détails, voir Instructions de service annexe F). ➤ Seulement câble de cuivre Classe 1 60/75 °C
<p>Note Before carrying out any installation and commissioning procedures, you must read all safety instructions and warnings, including all warning labels attached to the equipment. Make sure that the warning labels are kept in a legible condition and ensure missing or damaged labels are replaced.</p>	<p>Hinweise Vor der Durchführung von Installations- und Inbetriebnahmearbeiten unbedingt alle Sicherheitshinweisungen und Warnungen bitte sorgfältig lesen, ebenso alle am Gerät angebrachten Warnschilder. Darauf achten, dass Warnschilder in lesbarerem Zustand gehalten werden und dafür sorgen, dass fehlende oder beschädigte Schilder gegebenenfalls ausgetauscht werden.</p>	<p>Remarques Avant de procéder à l'installation et à la mise en service, il faut lire attentivement les consignes de sécurité et les avertissements ainsi que toutes les marques d'avertissement apposées sur l'appareil. Veillez à maintenir la lisibilité des marques d'avertissement et à remplacer celles qui manquent ou qui ont été dégradées.</p>

Español

Advertencias

- Este equipo incluye piezas bajo tensión peligrosa y controla órganos mecánicos en rotación potencialmente peligrosos. El no respeto de las Advertencias o la no observación de las instrucciones contenidas en esta Guía pueden provocar la muerte, lesiones graves o daños materiales considerables.
- En este equipo sólo deberá trabajar personal adecuadamente cualificado y sólo una vez familiarizado con todas las consignas de seguridad, procedimientos de instalación, operación y mantenimiento contenidos en este Manual. El funcionamiento exitoso y seguro de este equipo depende de si ha sido manipulado, instalado, operado y mantenido adecuadamente.
- En el circuito intermedio de todos los módulos MICROMASTER permanece un nivel de tensión peligroso durante 5 minutos tras que hayan sido desconectadas todas las tensiones. Por ello, una vez desconectado el convertidor de la fuente de alimentación, esperar 5 minutos antes de efectuar trabajos en cualquier módulo MICROMASTER.
- Este equipo suministra internamente la protección contra sobrecarga del motor de acuerdo a la UL508C sección 42. Referirse al P0610 (nivel 3) y P0335. Puede conseguirse también protección contra sobrecargas del motor utilizando una PTC externa a través de una entrada digital.
- Questa apparecchiatura è adatta per l'impiego in circuiti capaci di fornire al max. 10 kA (Grandezza costruttiva A ... C) o 42 kA (Grandezza costruttiva D ... GX) simmetrici (rms) con una tensione massima di:
 - MM420 = 230 V / 460 V
 - MM430 = 460 V
 - MM440 = 230 V / 460 V / 575 Vse protetto con fusibili del tipo H, J o K, un interruttore di potenza oppure una derivazione motore autoprotetta (Per ulteriori dettagli vedi Manuale operativo Appendice F).
- Sólo cableado de cobre Clase 1 60/75 °C.

Notas

Antes de efectuar cualquier tipo de trabajo de instalación y puesta en servicio **es necesario** leer todas las instrucciones y advertencias de seguridad, incluyendo los rótulos de advertencia fijados al equipo. Asegurarse de que dichos rótulos y advertencias sean siempre legibles y tomar las medidas necesarias para sustituir inmediatamente los rótulos perdidos o dañados.

Italiano

Pericolo

- La presente apparecchiatura contiene tensioni pericolose e controlla parti meccaniche rotanti potenzialmente pericolose. L'ignoranza delle relative misure di sicurezza può causare la morte, gravi lesioni alle persone e ingenti danni materiali.
- Sulla presente apparecchiatura dovrà operare esclusivamente personale appositamente qualificato e solamente dopo che abbia acquisito piena dimestichezza con tutte le informazioni di sicurezza ed alle procedure di installazione, uso e manutenzione riportate in questa guida. Il corretto e sicuro funzionamento della presente apparecchiatura dipende dall'idoneità degli interventi di installazione, uso e manutenzione.
- Il circuito intermedio di tutti i moduli MICROMASTER rimane caricato a livelli pericolosi di tensione per 5 minuti dopo aver disattivato tutte le alimentazioni elettriche. Di conseguenza, prima di effettuare qualsiasi intervento sui moduli MICROMASTER, si raccomanda di attendere almeno 5 minuti dopo aver disattivato l'inverter.
- Questo apparecchio è in grado di provvedere internamente alla protezione per sovraccarico del motore in accordo con UL508C parte 42. Riferimento a P0610 (livello 3) e P0335. La protezione per sovraccarico del motore può essere realizzata anche usando una PTC esterna tramite ingresso digitale.
- Este equipo es apto para utilizarlo en un circuito capaz de entregar no más de 10 kA (Tamaño constructivo A hasta C) o 42 kA (Tamaño constructivo D hasta GX) simétricos (valor eficaz) y una tensión máxima de:
 - MM420 = 230 V / 460 V
 - MM430 = 460 V
 - MM440 = 230 V / 460 V / 575 Vsi está protegido con un fusible del tipo H, J o K, un interruptor protector de línea o la línea al motor está protegida por fusible (Para más detalles, ver Instrucciones de uso appendice F).
- Classe 1 60/75 °C solo filo di rame.

Avvertenza

Prima di procedere all'installazione ed alla messa in esercizio, è **necessario** leggere attentamente le istruzioni di sicurezza e le avvertenze, incluse tutte le targhette di avvertimento applicate alle apparecchiature. Accertarsi che le targhette di avvertimento siano conservate in condizioni leggibili e si abbia cura di sostituire le targhette mancanti o danneggiate.

Environmental conditions



Keep free from dust and dirt! (Degree of protection = IP20)

Von Staub und Schmutz fernhalten! (Schutzart IP20)

Tenir libre de poussière et saleté (Degrée de protection = IP20)

Mantener libre de polvo y suciedad! (Grado de Protección IP20)

Tenere a distanza di polvere ed ambiente sporco (grado di protezione IP20)!

本设备应在无灰尘和其他污物的环境中(防护等级 = IP20)。



Keep away from water, solvents and chemicals!

Von Wasser, Lösungsmitteln und Chemikalien fernhalten!

Éviter de l'eau, solvants et des produits chimiques !

Evitar agua, disolventes y productos químicos!

Utilizzo a distanza di acqua, materiali chimici!

本设备必须远离水、溶剂和化学物质！

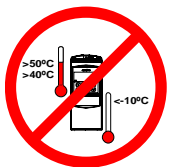

Keep within max./min. operating temperatures! (See manual!)

Nur im zulässigen Temperaturbereich betreiben! (Siehe Anleitung!)

Usage seulement dans la portée de températures autorisée ! (Cfr. Manuel !)

Operar a temperaturas de servicio autorizadas! (Ver manual de operación!)

Utilizzo solo nelle temperature di servizio specificate (vedi istruzioni d'operazione)

本设备的运行温度必须限定在其最大 / 最小允许范围以内 (请参看相关手册)!



Ensure correct ventilation/air flow

Ausreichende Entlüftung der Geräte im Schaltschrank sicherstellen

Assurez une ventilation suffisante de l'appareil.

Garantizar ventilación suficiente de los equipos

Garantire una ventilazione sufficiente degli apparecchi

本设备运行时必须保证足够的通风 / 冷却空气流量。

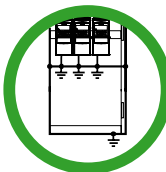

Ensure good earthing/grounding practices for each inverter and the cabinet

Stellen Sie eine gute Erdung untereinander und im Schrank sicher

Assurez une bonne mise à la terre entre les appareils et dans l'armoire.

Garantice una buena puesta a tierra entre equipos y armarios

Mettere bene a terra gli apparecchi sia entrambi sia nel quadro elettrico

确保设备箱体内的所有设备接地点都能得到良好的接地。

Contact Local Technical Support:

Please get in touch with the local contact partners for Technical Support in your local Region for questions and advice concerning any of the installation environment and conditions as shown in the drawings above.

Europe / Africa

Tel: +49 (0) 180 5050 222

Fax: +49 (0) 180 5050 223

E-Mail: adsupport@siemens.com

Lokale Technische Unterstützung

Bitte fragen Sie ihre lokalen Partner nach technischem Support in ihrer Region, insbesondere wenn es um die Einhaltung und Sicherstellung der oben dargestellten und erforderlichen Betriebsbedingungen geht

America

Tel: +1 423 262 2522

Fax: +1 423 262 2289

E-Mail:

simatic.hotline@sea.siemens.com

Contacter le Support Technique

Veuillez demander votre partner local vers support technique dans votre région, surtout pour des questions et conseils concernant les conditions fonctionnelles décrit sur cette page.

Asia / Pacific Rim

Tel: +86 1064 75 75 75

Fax: +86 1064 74 74 74

E-Mail adsupport.asia@siemens.com

Servicio Técnico en España

Consulte al soporte técnico local en su zona, especialmente cuando se trate de asegurar el cumplimiento de las condiciones de servicio enunciadas arriba.

Supporto tecnico in Italia

Per supporto tecnico da mettersi in contatto con gli indirizzi indicati, soprattutto per domande riguardante l'utilizzo sicuro nelle condizioni sopracitate.

中国地区用户，请按以下方式同我们联系：

www.ad.siemens.com.cn

www.ad.siemens.com.cn/service

Phone: +86-(0)-10-6471-9990

Fax: +86-(0)-10-6471-9991

Email: adsc.china@siemens.com

Dimension Drawings
Maßbilder
Encombremes
Dibujos acotados
Disegni quotati

Frame Size A

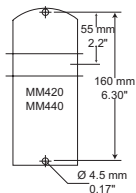

Frame Size B

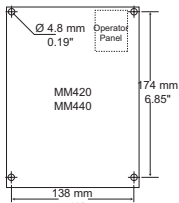

Frame Size C

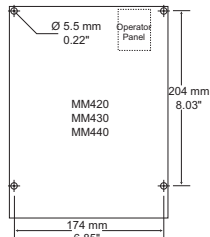

Frame Size D

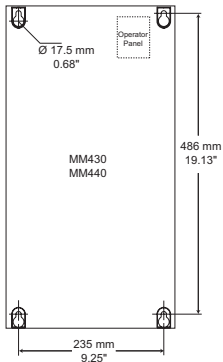

Frame Size E

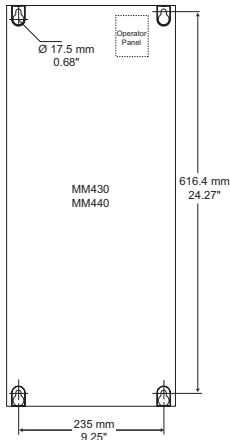

Frame Size F

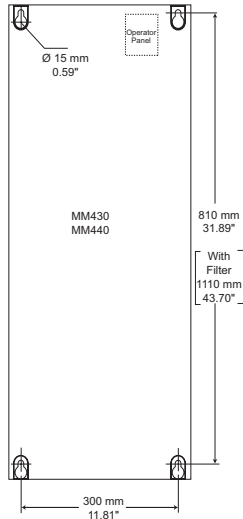

Frame Size FX

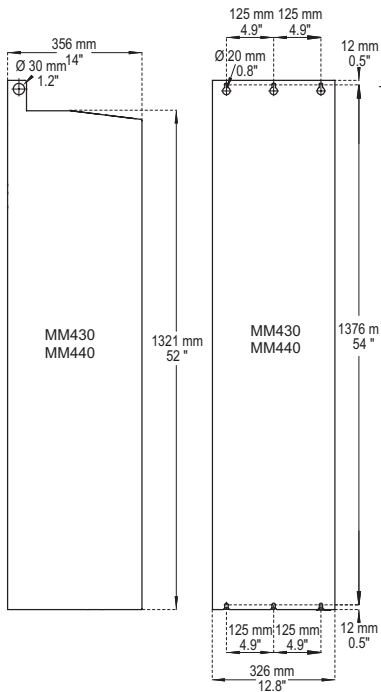

Frame Size GX

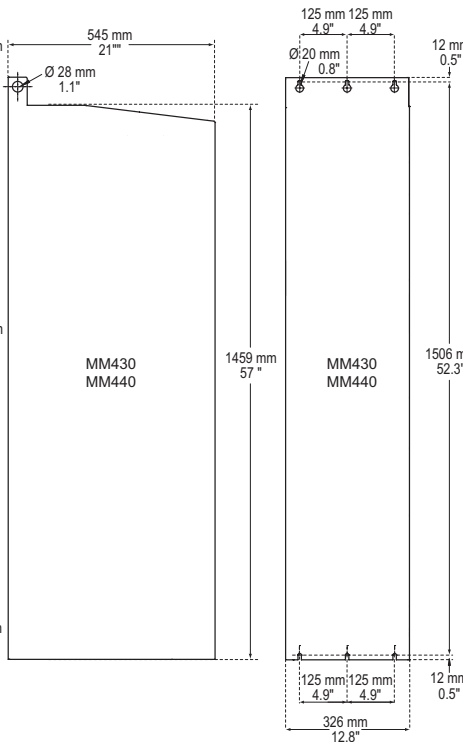

Connecting Power Terminals

Leistungsanschlüsse
Connexions de puissance
Conectores de carga
Connessioni

Frame Size A

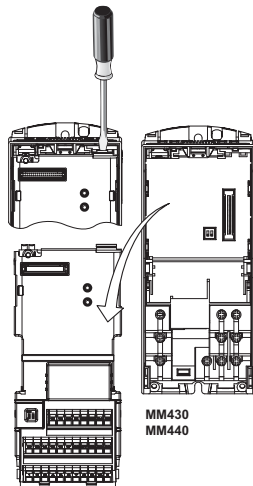

Frame Size B, C

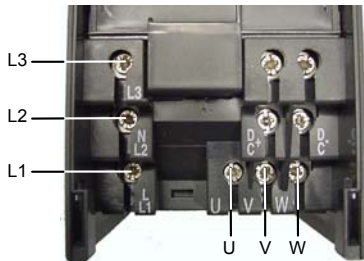
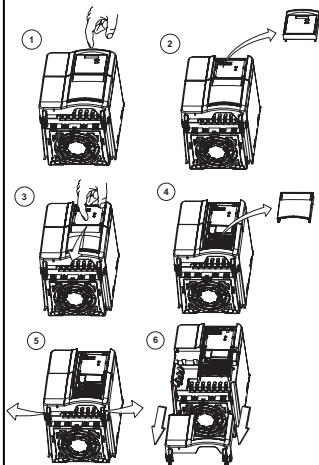

Frame Sizes D, E

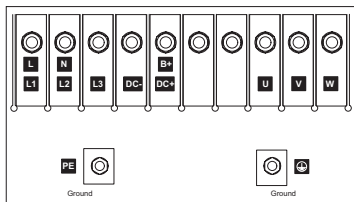
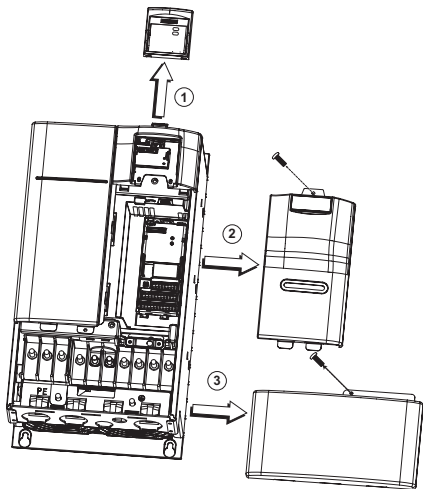

Frame Size F

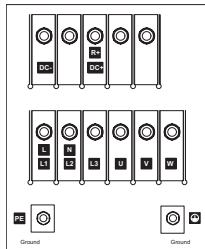
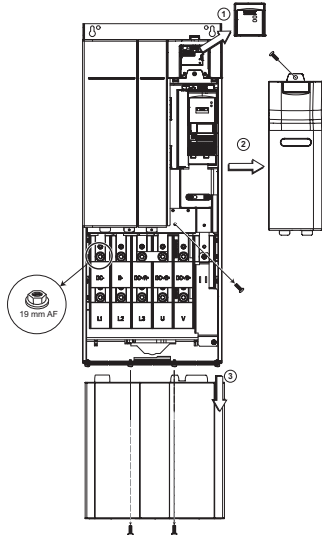

Frame Size FX, GX

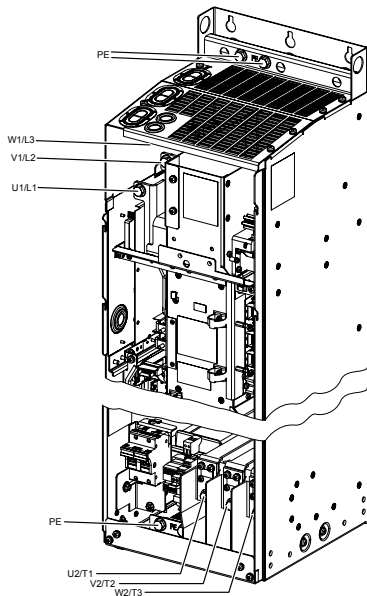

Motor
 Motor
 Moteur
 Motor
 Motore

PE = Ground

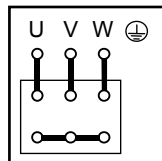
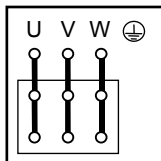

Connecting Control Terminals
 Anschließen der Steuerklemmen
 Connexions de commande
 Conectores para líneas de control
 Connessioni die morsetti di comando

MM420

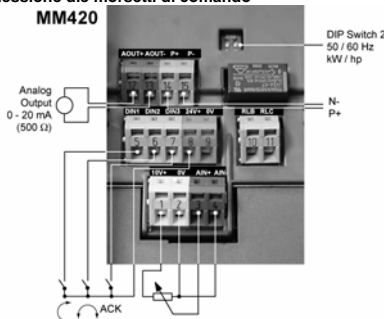

Motor Frequency
 Motorfrequenz
 Fréquence moteur
 Frecuencia del motor
 Frequenza motore

Remove SDP and I/O Board

MM430 MM440



MM430 MM440

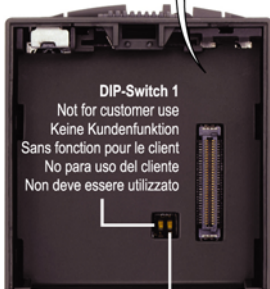
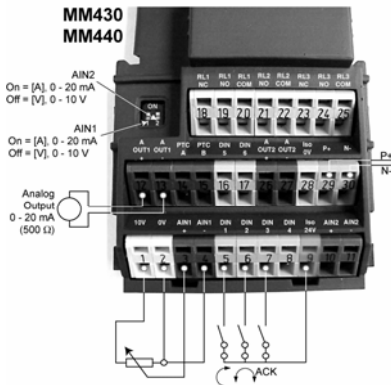

DIP-Switch 2

OFF f = 50 Hz; ON f = 60 Hz
 Default Setting = OFF
 Werkseinstellung = OFF
 Reglage usine = OFF
 Ajuste de fabrica = OFF
 Default = OFF

MM420 Specifications

Frame Size	Dimensions	Tightening torque for power connections			
A	W x H x D	mm	73 x 173 x 149	Nm	11
		inch	2.87 x 6.81 x 5.87	lbf.in	10
B	W x H x D	mm	149 x 202 x 172	Nm	1.5
		inch	5.87 x 7.95 x 6.77	lbf.in	13.3
C	W x H x D	mm	185 x 245 x 195	Nm	2.25
		inch	7.28 x 9.65 x 7.68	lbf.in	20

In order to have a UL compliant installation fuses from the SITOR range with the appropriate current rating must be used. *UL listed fuses such as Class NON from Bussmann are required for use in America

Input voltage range 1 AC 200 V – 240 V, $\pm 10\%$ (with built in Class A Filter)

Order No.	6SE6420-	2AB11-2AA1	2AB12-5AA1	2AB13-7AA1	2AB15-5AA1	2AB17-5AA1	2AB21-1BA1	2AB21-5BA1	2AB22-2BA1	2AB23-0CA1
Fuse	[A]	10	10	10	10	16	20	20	32	40
Recommended For UL specified	3NA	3B03	3B03	3B03	3B03	3B05	3B07	3B07	3B12	3B17
Input Cable, min.	[mm ²] [awg]	1.0 18	1.0 18	1.0 18	1.0 18	1.0 18	2.5 16	2.5 16	4.0 12	6.0 10
Input Cable, max.	[mm ²] [awg]	2.5 14	2.5 14	2.5 14	2.5 14	2.5 14	6.0 10	6.0 10	6.0 10	10.0 8
Output Cable, min.	[mm ²] [awg]	1.0 18	1.0 18	1.0 18	1.0 18	1.0 18	1.0 18	1.0 18	1.0 18	1.5 16
Output Cable, max.	[mm ²] [awg]	2.5 14	2.5 14	2.5 14	2.5 14	2.5 14	6.0 10	6.0 10	6.0 10	10.0 8

Input voltage range 1 AC 200 V – 240 V, $\pm 10\%$ (unfiltered)

Order No.	6SE6420-	2UC11-2AA1	2UC12-5AA1	2UC13-7AA1	2UC15-5AA1	2UC17-5AA1	2UC21-1BA1	2UC21-5BA1	2UC22-2BA1	2UC23-0CA1
Recommended For UL specified	3NA	3B03	3B03	3B03	3B03	3B05	3B07	3B07	3B12	3B17
Input Cable, min.	[mm ²] [awg]	1.0 18	1.0 18	1.0 18	1.0 18	1.0 18	1.0 18	1.0 18	1.0 18	2.5 14
Input Cable, max.	[mm ²] [awg]	2.5 14	2.5 14	2.5 14	2.5 14	2.5 14	6.0 10	6.0 10	6.0 10	10.0 8
Output Cable, min.	[mm ²] [awg]	1.0 18	1.0 18	1.0 18	1.0 18	1.0 18	1.0 18	1.0 18	1.0 18	1.5 16
Output Cable, max.	[mm ²] [awg]	2.5 14	2.5 14	2.5 14	2.5 14	2.5 14	6.0 10	6.0 10	6.0 10	10.0 8

Input voltage range 3 AC 200 V – 240 V, $\pm 10\%$ (with built in Class A Filter)

Order No.	6SE6420-	2AC23-0CA1	2AC24-0CA1	2AC25-5CA1
Recommended For UL specified	3NA	3B10	3B12	3B14
Input Cable, min.	[mm ²] [awg]	2.5 14	2.5 14	4.0 12
Input Cable, max.	[mm ²] [awg]	10.0 8	10.0 8	10.0 8
Output Cable, min.	[mm ²] [awg]	1.5 16	2.5 14	4.0 12
Output Cable, max.	[mm ²] [awg]	10.0 8	10.0 8	10.0 8

Input voltage range 3 AC 200 V – 240 V, ± 10 % (Unfiltered)

Order No.	6SE6420-	2UC11-2AA1	2UC12-5AA1	2UC13-7AA1	2UC15-5AA1	2UC17-5AA1	2UC21-1BA1	2UC21-5BA1	2UC22-2BA1
Fuse	[A]	10	10	10	10	10	16	16	20
Recommended	3NA	3803	3803	3803	3803	3803	3805	3805	3807
For UL specified		*	*	*	*	*	*	*	*
Input Cable, min.	[mm ²] [awg]	1.0 18	1.0 18	1.0 18	1.0 18	1.0 18	1.0 18	1.0 18	1.0 18
Input Cable, max.	[mm ²] [awg]	2.5 14	2.5 14	2.5 14	2.5 14	2.5 14	6.0 10	6.0 10	6.0 10
Output Cable, min.	[mm ²] [awg]	1.0 18	1.0 18	1.0 18	1.0 18	1.0 18	1.0 18	1.0 18	1.0 18
Output Cable, max.	[mm ²] [awg]	2.5 14	2.5 14	2.5 14	2.5 14	2.5 14	6.0 10	6.0 10	6.0 10

Order No.	6SE6420-	2UC23-0CA1	2UC24-0CA1	2UC25-5CA1
Fuse	[A]	25	32	35
Recommended	3NA	3810	3812	3814
For UL specified		*	*	*
Input Cable, min.	[mm ²] [awg]	2.5 14	2.5 14	4.0 12
Input Cable, max.	[mm ²] [awg]	10.0 8	10.0 8	10.0 8
Output Cable, min.	[mm ²] [awg]	1.5 16	2.5 14	4.0 12
Output Cable, max.	[mm ²] [awg]	10.0 8	10.0 8	10.0 8

Input voltage range 3 AC 380 V – 480 V, ± 10 % (with built in Class A Filter)

Order No.	6SE6420-	2AD22-2BA1	2AD23-0BA1	2AD24-0BA1	2AD25-5CA1	2AD27-5CA1	2AD31-1CA1
Fuse	[A]	16	16	20	20	25	35
Recommended	3NA	3805	3805	3807	3807	3810	3814
For UL specified		*	*	*	*	*	*
Input Cable, min.	[mm ²] [awg]	1.0 18	1.0 18	1.5 16	2.5 14	4.0 12	6.0 10
Input Cable, max.	[mm ²] [awg]	6.0 10	6.0 10	6.0 10	10.0 8	10.0 8	10.0 8
Output Cable, min.	[mm ²] [awg]	1.0 18	1.0 18	1.0 18	1.5 16	2.5 14	4.0 12
Output Cable, max.	[mm ²] [awg]	6.0 10	6.0 10	6.0 10	10.0 8	10.0 8	10.0 8

Input voltage range 3 AC 200 V – 240 V, ± 10 % (Unfiltered)

Order No.	6SE6420-	2UC23-0CA1	2UC24-0CA1	2UC25-5CA1
Fuse	[A]	25	32	35
Recommended	3NA	3810	3812	3814
For UL specified		*	*	*
Input Cable, min.	[mm ²] [awg]	2.5 14	2.5 14	4.0 12
Input Cable, max.	[mm ²] [awg]	10.0 8	10.0 8	10.0 8
Output Cable, min.	[mm ²] [awg]	1.5 16	2.5 14	4.0 12
Output Cable, max.	[mm ²] [awg]	10.0 8	10.0 8	10.0 8

Input voltage range 3 AC 380 V – 480 V, ± 10 % (Unfiltered)

Order No.	6SE6420-	2UD13 -7AA1	2UD15 -5AA1	2UD17 -5AA1	2UD21 -1AA1	2UD21 -5AA1	2UD22 -2BA1	2UD23 -0BA1	2UD24 -0BA1
Fuse	[A]	10	10	10	10	10	16	16	20
Recommended For UL specified	3NA	3803	3803	3803	3803	3803	3805	3805	3807
		*	*	*	*	*	*	*	*
Input Cable, min.	[mm ²] [awg]	1.0 18	1.0 18	1.0 18	1.0 18	1.0 18	1.0 18	1.0 18	1.5 16
Input Cable, max.	[mm ²] [awg]	2.5 14	2.5 14	2.5 14	2.5 14	2.5 14	6.0 10	6.0 10	6.0 10
Output Cable, min.	[mm ²] [awg]	1.0 18	1.0 18	1.0 18	1.0 18	1.0 18	1.0 18	1.0 18	1.0 18
Output Cable, max.	[mm ²] [awg]	2.5 14	2.5 14	2.5 14	2.5 14	2.5 14	6.0 10	6.0 10	6.0 10

Order No.	6SE6420-	2UD25 -5CA1	2UD27 -5CA1	2UD31 -1CA1
Fuse	[A]	20	25	35
Recommended For UL specified	3NA	3807	3810	3814
		*	*	*
Input Cable, min.	[mm ²] [awg]	2.5 14	4.0 12	6.0 10
Input Cable, max.	[mm ²] [awg]	10.0 8	10.0 8	10.0 8
Output Cable, min.	[mm ²] [awg]	1.5 16	2.5 14	4.0 12
Output Cable, max.	[mm ²] [awg]	10.0 8	10.0 8	10.0 8

MM430 Specifications

Frame Size	Dimensions	Tightening torques for power terminals			
		Nm	lb-ft	Nm	lb-ft
C	B x H x T	mm	185 × 245 × 195		2,25
		inch	7,28 × 9,65 × 7,68		1,7
D	B x H x T	mm	275 × 520 × 245		Nm
		inch	10,82 × 20,47 × 9,65		10 (max.)
E	B x H x T	mm	275 × 650 × 245		lb-ft
		inch	10,82 × 25,59 × 9,65		7,4 (max.)
F	B x H x T	mm	350 × 850 mm × 320 (Height with filter 1150)		Nm
		inch	13,78 × 33,46 × 12,60 (Height with filter 45,28)		50
FX	B x H x T	mm	326 × 1400 × 356		lb-ft
		inch	12,80 × 55,12 × 12,83		36,9
GX	B x H x T	mm	326 × 1533 × 545		Nm
		inch	12,80 × 60,35 × 21,46		25
					lb-ft
					18,4

In order to have a UL compliant installation fuses from the SITOR range with the appropriate current rating must be used. *UL listed fuses such as Class NON from Bussmann are required for use in America

Input voltage range 3 AC 380 V ... 480 V, ± 10% (with built in Class A Filter)

Order No.	6SE6430-	2AD27 -SCA0	2AD31 -ICA0	2AD31 -SCA0	2AD31 -8DA0	2AD32 -2DA0	2AD33 -0DA0
Recommended Fuse	[A]	20	32	35	50	63	80
	3NA	3807	3812	3814	3820	3822	3824
Fuses recommended for UL applications	[A]				50	63	80
	3NE	*	*	*	1817-0	1818-0	1820-0
Input Cable Min.	[mm ²]	2,5	4,0	6,0	10,0	10,0	16,0
	[AWG]	14	12	10	8	8	6
Input Cable Max.	[mm ²]	10,0	10,0	10,0	35,0	35,0	35,0
	[AWG]	8	8	8	2	2	2
Output Cable Min.	[mm ²]	2,5	4,0	6,0	10,0	10,0	16,0
	[AWG]	14	12	10	8	8	6
Output Cable Max.	[mm ²]	10,0	10,0	10,0	35,0	35,0	35,0
	[AWG]	8	8	8	2	2	2

Order No.	6SE6430-	2AD33 -7EA0	2AD34 -5EA0	2AD35 -5FA0	2AD37 -5FA0	2AD38 -8FA0
Recommended Fuse	[A]	100	125	160	160	200
	3NA	3830	3832	3836	3140	3144
Fuses recommended for UL applications	[A]	100	125	160	200	200
	3NE	1021-0	1022-0	1224-0	1225-0	1227-0
Input Cable Min.	[mm ²]	25,0	25,0	35,0	70,0	70,0
	[AWG]	3	3	2	2/0	2/0
Input Cable Max.	[mm ²]	35,0	35,0	150,0	150,0	150,0
	[AWG]	2	2	300	300	300
Output Cable Min.	[mm ²]	25,0	25,0	50,0	70,0	95,0
	[AWG]	3	3	1/0	2/0	4/0
Output Cable Max.	[mm ²]	35,0	35,0	150,0	150,0	150,0
	[AWG]	2	2	300	300	300

Input voltage range 3 AC 380 V ... 480 V, ± 10% (Unfiltered)

Order No.	6SE6430-	2UD27- -5CA0	2UD31- -1CA0	2UD31- -5CA0	2UD31- -8DA0	2UD32- -2DA0	2UD33- -0DA0
Recommended Fuse	[A] 3NA	20 3807	32 3812	35 3814	50 3820	63 3822	80 3824
Fuses recommended for UL applications	[A] 3NE	*	*	*	50 1817-0	63 1818-0	80 1820-0
Input Cable Min.	[mm ²] [AWG]	2.5 14	4.0 12	6.0 10	10.0 8	10.0 8	16.0 6
Input Cable Max.	[mm ²] [AWG]	10.0 8	10.0 8	10.0 8	35.0 2	35.0 2	35.0 2
Output Cable Min.	[mm ²] [AWG]	2.5 14	4.0 12	6.0 10	10.0 8	10.0 8	16.0 6
Output Cable Max.	[mm ²] [AWG]	10.0 8	10.0 8	10.0 8	35.0 2	35.0 2	35.0 2

Order No.	6SE6430-	2UD33- -7EA0	2UD34- -5EA0	2UD35- -5FA0	2UD37- -5FA0	2UD38- -8FA0
Recommended Fuse	[A] 3NA	100 3830	125 3832	160 3836	160 3140	200 3144
Fuses recommended for UL applications	[A] 3NE	100 1021-0	125 1022-0	160 1224-0	200 1225-0	200 1227-0
Input Cable Min.	[mm ²] [AWG]	25.0 3	25.0 3	35.0 2	70.0 2/0	70.0 2/0
Input Cable Max.	[mm ²] [AWG]	35.0 2	35.0 2	150.0 300	150.0 300	150.0 300
Output Cable Min.	[mm ²] [AWG]	25.0 3	25.0 3	35.0 2	70.0 2/0	95.0 4/0
Output Cable Max.	[mm ²] [AWG]	35.0 2	35.0 2	150.0 300	150.0 300	150.0 300

Input voltage range 3 AC 380 V ... 480 V, ± 10% (Unfiltered)

Order No.	6SE6430-	2UD41-1FA0	2UD41-3FA0	2UD41-6GA0	2UD42-0GA0	2UD42-5GA0
Recommended Fuse	[A] 3NE1227-0	250 3NE1227-0	315 3NE1230-0	400 3NE1332-0	450 3NE1333-0	560 3NE1435-0
Input Cable Min.	[mm ²] [AWG] or [kcmil]	1 x 95 or 2 x 35 1 x 4/0 or 2 x 2	1 x 150 or 2 x 50 1 x 300 or 2 x 1/0	1 x 185 or 2 x 70 1 x 400 or 2 x 2/0	1 x 240 or 2 x 70 1 x 500 or 2 x 2/0	2 x 95 2 x 4/0
Input Cable Max.	[mm ²] [AWG] or [kcmil]	1 x 185 or 2 x 120 1 x 350 or 2 x 4/0	1 x 185 or 2 x 120 1 x 350 or 2 x 4/0	2 x 240 2 x 400	2 x 240 2 x 400	2 x 240 2 x 400
Output Cable Min.	[mm ²] [AWG] or [kcmil]	1 x 95 or 2 x 35 1 x 4/0 or 2 x 2	1 x 150 or 2 x 50 1 x 300 or 2 x 1/0	1 x 185 or 2 x 70 1 x 400 or 2 x 2/0	1 x 240 or 2 x 70 1 x 500 or 2 x 2/0	2 x 95 2 x 4/0
Output Cable Max.	[mm ²] [AWG] or [kcmil]	1 x 185 or 2 x 120 1 x 350 or 2 x 4/0	1 x 185 or 2 x 120 1 x 350 or 2 x 4/0	2 x 240 2 x 400	2 x 240 2 x 400	2 x 240 2 x 400
Pipe cable shoe to DIN 46235	[mm]	10	10	10	10	10

MM440 Specifications

Frame Size	Dimensions			Tightening torque for power connections	
A	WxHxD	mm	73 × 173 × 149	Nm	1.1
		inch	2.87 × 6.81 × 5.87		
B	WxHxD	mm	149 × 202 × 172	Nm	1.5
		inch	5.87 × 7.95 × 6.77		
C	WxHxD	mm	185 × 245 × 195	Nm	2.25
		inch	7.28 × 9.65 × 7.68		
D	WxHxD	mm	275 × 520 × 245	Nm	10 (max.)
		inch	10.82 × 20.47 × 9.65		
E	WxHxD	mm	275 × 650 × 245	Nm	10 (max.)
		inch	10.82 × 25.59 × 9.65		
F	WxHxD	mm	350 × 850 Height with filter 1150	Nm	50
		inch	13.78 × 33.46 × 12.60 Height with filter 45.28		
FX	WxHxD	mm	326 × 1400 × 356	Nm	25
		inch	12.80 × 55.12 × 12.83		
GX	WxHxD	mm	326 × 1533 × 545	Nm	25
		inch	12.80 × 60.35 × 21.46		

In order that the system is in compliance with UL, UL-certified fuses must be used with the appropriate rated current. *UL listed fuses such as Class NON from Bussmann are required for use in America

Input voltage range 1 AC 200 V – 240 V, ± 10 % (with built in Class A Filter)

Order No.	6SE6440-	2AB11 -2AA1	2AB12 -5AA1	2AB13 -7AA1	2AB15 -5AA1	2AB17 -5AA1	2AB21 -1BA1	2AB21 -5BA1	2AB22 -2BA1	2AB23 -0CA1
Fuse	[A]	10	10	10	16	16	20	20	32	40
Recommended for UL specified	3NA	3803	3803	3803	3805	3805	3807	3807	3812	3817
		*	*	*	*	*	*	*	*	*
Input Cable Min.	[mm ²]	1.0	1.0	1.0	1.5	1.5	2.5	2.5	4.0	6.0
	[awg]	18	18	18	16	16	14	14	12	10
Input Cable Max.	[mm ²]	2.5	2.5	2.5	2.5	2.5	6.0	6.0	6.0	10.0
	[awg]	14	14	14	14	14	10	10	10	8
Output Cable Min.	[mm ²]	1.0	1.0	1.0	1.0	1.0	1.0	1.0	1.0	1.5
	[awg]	18	18	18	18	18	18	18	18	16
Output Cable Max.	[mm ²]	2.5	2.5	2.5	2.5	2.5	6.0	6.0	6.0	10.0
	[awg]	14	14	14	14	14	10	10	10	8

Input voltage range 1 AC 200 V – 240 V, ± 10 % (Unfiltered)

Order No.	6SE6440-	2UC11 -2AA1	2UC12 -5AA1	2UC13 -7AA1	2UC15 -5AA1	2UC17 -5AA1	2UC21 -1BA1	2UC21 -5BA1	2UC22 -2BA1	2UC23 -0CA1
Fuse	[A]	10	10	10	16	16	20	20	32	40
Recommended for UL specified	3NA	3803	3803	3803	3805	3805	3807	3807	3812	3817
		*	*	*	*	*	*	*	*	*
Input Cable Min.	[mm ²]	1.0	1.0	1.0	1.5	1.5	2.5	2.5	4.0	6.0
	[awg]	18	18	18	16	16	14	14	12	10
Input Cable Max.	[mm ²]	2.5	2.5	2.5	2.5	2.5	6.0	6.0	6.0	10.0
	[awg]	14	14	14	14	14	10	10	10	8
Output Cable Min.	[mm ²]	1.0	1.0	1.0	1.0	1.0	1.0	1.0	1.0	1.5
	[awg]	18	18	18	18	18	18	18	18	16
Output Cable Max.	[mm ²]	2.5	2.5	2.5	2.5	2.5	6.0	6.0	6.0	10.0
	[awg]	14	14	14	14	14	10	10	10	8

Input voltage range 3 AC 200 V – 240 V, ± 10 % (with built in Class A Filter)

Order No.	6SE6440-	2AC23 -0CA1	2AC24 -0CA1	2AC25 -5CA1
Fuse	[A]	25	32	35
Recommended for UL specified	3NA	3810	3812	3814
	3NE	*	*	*
Input Cable Min.	[mm ²] [awg]	2.5 14	4.0 12	4.0 12
Input Cable Max.	[mm ²] [awg]	10.0 8	10.0 8	10.0 8
Output Cable Min.	[mm ²] [awg]	1.5 16	4.0 12	4.0 12
Output Cable Max.	[mm ²] [awg]	10.0 8	10.0 8	10.0 8

Input voltage range 3 AC 200 V – 240 V, ± 10 % (Unfiltered)

Order No.	6SE6440-	2UC11 -2AA1	2UC12 -5AA1	2UC13 -7AA1	2UC15 -5AA1	2UC17 -5AA1	2UC21 -1BA1	2UC21 -5BA1	2UC22 -2BA1	2UC23 -0CA1
Fuse	[A]	10	10	10	16	16	20	20	25	25
Recommended for UL specified	3NA	3803	3803	3803	3805	3805	3807	3807	3810	3810
	3NE	*	*	*	*	*	*	*	*	*
Input Cable Min.	[mm ²] [awg]	1.0 18	1.0 18	1.0 18	1.5 16	1.5 16	2.5 14	2.5 14	2.5 14	4.0 12
Input Cable Max.	[mm ²] [awg]	2.5 14	2.5 14	2.5 14	2.5 14	2.5 14	6.0 10	6.0 10	6.0 10	10.0 8
Output Cable Min.	[mm ²] [awg]	1.0 18	1.0 18	1.0 18	1.0 18	1.0 18	1.0 18	1.0 18	1.0 18	1.5 16
Output Cable Max.	[mm ²] [awg]	2.5 14	2.5 14	2.5 14	2.5 14	2.5 14	6.0 10	6.0 10	6.0 10	10.0 8

Order No.	6SE6440-	2UC24 -0CA1	2UC25 -5CA1	2UC27 -5DA1	2UC31 -1DA1	2UC31 -5DA1	2UC31 -8EA1	2UC32 -2EA1	2UC33 -0FA1	2UC33 -7FA1	2UC34 -5FA1
Fuse	[A]	32	35	50	80	80	100	125	200	200	250
Recommended for UL specified	3NA	3812	3814	3820	3824	3824	3830	3832	3140	3142	3144
	3NE	*	*	1817-0	1820-0	1820-0	1021-0	1022-0	1225-0	1225-0	1227-0
Input Cable Min.	[mm ²] [awg]	4.0 12	4.0 12	10.0 8	16.0 6	16.0 6	25.0 3	25.0 3	70.0 2/0	70.0 2/0	95.0 3/0
Input Cable Max.	[mm ²] [awg]	10.0 8	10.0 8	35.0 2	35.0 2	35.0 2	35.0 2	35.0 2	150.0 300	150.0 300	150.0 300
Output Cable Min.	[mm ²] [awg]	4.0 12	4.0 12	10.0 8	16.0 6	16.0 6	25.0 3	25.0 3	50.0 1/0	70.0 2/0	95.0 3/0
Output Cable Max.	[mm ²] [awg]	10.0 8	10.0 8	35.0 2	35.0 2	35.0 2	35.0 2	35.0 2	150.0 300	150.0 300	150.0 300

Input voltage range 3 AC 380 V – 480 V, ± 10 % (with built in Class A Filter)

Order No.	6SE6440-	2AD22 -2BA1	2AD23 -0BA1	2AD24 -0BA1	2AD25 -5CA1	2AD27 -5CA1	2AD31 -1CA1	2AD31 -5DA1
Fuse	[A]	16	16	20	20	32	35	50
Recommended for UL specified	3NA	3805	3805	3807	3807	3812	3814	3820
	3NE	*	*	*	*	*	*	1817-0
Input Cable Min.	[mm ²] [awg]	1.5 16	1.5 16	2.5 14	2.5 14	4.0 12	4.0 10	10.0 8
Input Cable Max.	[mm ²] [awg]	6.0 10	6.0 10	6.0 10	6.0 10	10.0 8	10.0 8	35.0 2
Output Cable Min.	[mm ²] [awg]	1.0 18	1.0 18	1.0 18	2.5 14	4.0 12	6.0 10	10.0 8
Output Cable Max.	[mm ²] [awg]	6.0 10	6.0 10	6.0 10	6.0 10	10.0 8	10.0 8	35.0 2

Order No.	6SE6440-	2AD31 -8DA1	2AD32 -2DA1	2AD33 -0EA1	2AD33 -7EA1	2AD34 -5FA1	2AD35 -5FA1	2AD37 -5FA1
Fuse	[A]	63	80	100	125	160	200	250
Recommended for UL specified	3NA	3822	3824	3830	3832	3836	3140	3144
	3NE	1818-0	1820-0	1021-0	1022-0	1224-0	1225-0	1227-0
Input Cable Min.	[mm ²]	10.0	16.0	25.0	25.0	35.0	70.0	95.0
	[awg]	8	6	3	3	2	2/0	3/0
Input Cable Max.	[mm ²]	35.0	35.0	35.0	35.0	150.0	150.0	150.0
	[awg]	2	2	2	2	300	300	300
Output Cable Min.	[mm ²]	10.0	16.0	25.0	25.0	50.0	70.0	95.0
	[awg]	8	6	3	3	1/0	2/0	3/0
Output Cable Max.	[mm ²]	35.0	35.0	35.0	35.0	150.0	150.0	150.0
	[awg]	2	2	2	2	300	300	300

Input voltage range 3 AC 380 V – 480 V, ± 10 % (Unfiltered)

Order No.	6SE6440-	2UD13 -7AA1	2UD15 -5AA1	2UD17 -8AA1	2UD21 -1AA1	2UD21 -5AA1	2UD22 -2BA1	2UD23 -0BA1	2UD24 -0BA1	2UD25 -5CA1	2UD27 -5CA1
Fuse	[A]	10	10	10	10	10	16	16	20	20	32
Recommended for UL specified	3NA	3803	3803	3803	3803	3803	3805	3805	3807	3807	3812
		*	*	*	*	*	*	*	*	*	*
Input Cable Min.	[mm ²]	1.0	1.0	1.0	1.0	1.0	1.5	1.5	2.5	2.5	4.0
	[awg]	18	18	18	18	18	16	16	14	14	12
Input Cable Max.	[mm ²]	2.5	2.5	2.5	2.5	2.5	6.0	6.0	6.0	10.0	10.0
	[awg]	14	14	14	14	14	10	10	10	8	8
Output Cable Min.	[mm ²]	1.0	1.0	1.0	1.0	1.0	1.0	1.0	1.0	2.5	4.0
	[awg]	18	18	18	18	18	18	18	18	14	12
Output Cable Max.	[mm ²]	2.5	2.5	2.5	2.5	2.5	6.0	6.0	6.0	10.0	10.0
	[awg]	14	14	14	14	14	10	10	10	8	8

Order No.	6SE6440-	2UD31 -1AA1	2UD31 -5DA1	2UD31 -8DA1	2UD32 -2DA1	2UD33 -0EA1	2UD33 -7EA1	2UD34 -5FA1	2UD35 -5FA1	2UD37 -5FA1
Fuse	[A]	35	50	63	80	100	125	160	200	250
Recommended for UL specified	3NA	3814	3820	3822	3824	3830	3832	3836	3140	3144
	3NE	*	1817-0	1818-0	1820-0	1021-0	1022-0	1224-0	1225-0	1227-0
Input Cable Min.	[mm ²]	6.0	10.0	10.0	16.0	25.0	25.0	35.0	70.0	95.0
	[awg]	10	8	8	6	3	3	2	2/0	3/0
Input Cable Max.	[mm ²]	10.0	35.0	35.0	35.0	35.0	35.0	150.0	150.0	150.0
	[awg]	8	2	2	2	2	2	300	300	300
Output Cable Min.	[mm ²]	6.0	10.0	10.0	16.0	25.0	25.0	35.0	70.0	95.0
	[awg]	10	8	8	6	3	3	2	2/0	3/0
Output Cable Max.	[mm ²]	10.0	35.0	35.0	35.0	35.0	35.0	150.0	150.0	150.0
	[awg]	8	2	2	2	2	2	300	300	300

Input voltage range 3 AC 380 V – 480 V, ± 10 % (Unfiltered)

Order No.	6SE6440-	2UD38-8FA1	2UD41-1FA1	2UD41-3GA1	2UD41-6GA1	2UD42-0GA1
Recommended Fuse	[A]	250	315	400	450	560
	3NE	1227-0	1230-0	1332-0	1333-0	1435-0
Pipe cable shoe to DIN 46235	[mm]	10	10	10	10	10
Input Cable Min.	[mm ²]	1 x 95 or 2 x 35	1 x 150 or 2 x 50	1 x 185 or 2 x 70	1 x 240 or 2 x 70	2 x 95
	[awg] or [kcmil]	1 x 4/0 or 2 x 2	1 x 300 or 2 x 1/0	1 x 400 or 2 x 2/0	1 x 500 or 2 x 2/0	2 x 4/0
Input Cable Max.	[mm ²]	1 x 185 or 2 x 120	1 x 185 or 2 x 120	2 x 240	2 x 240	2 x 240
	[awg] or [kcmil]	1 x 350 or 2 x 4/0	1 x 350 or 2 x 4/0	2 x 400	2 x 400	2 x 400
Output Cable Min.	[mm ²]	1 x 95 or 2 x 35	1 x 150 or 2 x 50	1 x 185 or 2 x 70	1 x 240 or 2 x 70	2 x 95
	[awg] or [kcmil]	1 x 4/0 or 2 x 2	1 x 300 or 2 x 1/0	1 x 400 or 2 x 2/0	1 x 500 or 2 x 2/0	2 x 4/0
Output Cable Max.	[mm ²]	1 x 185 or 2 x 120	1 x 185 or 2 x 120	2 x 240	2 x 240	2 x 240
	[awg] or [kcmil]	1 x 350 or 2 x 4/0	1 x 350 or 2 x 4/0	2 x 400	2 x 400	2 x 400

Input voltage range 3 AC 500 V – 600 V ± 10 % (Unfiltered)

Order No.	6SE6440-	2UE17 -SCA1	2UE21 -SCA1	2UE22 -2CA1	2UE24 -0CA1	2UE25 -SCA1	2UE27 -SCA1	2UE31 -1CA1	2UE31 -5DA1
Fuse	[A]	10	10	10	16	16	25	32	35
Recommended	3NA	3803-6	3803-6	3803-6	3805-6	3805-6	3810-6	3812-6	3814-6
for UL specified	3NE	*	*	*	*	*	*	*	1803-0
Input Cable Min.	[mm ²] [awg]	1.0 18	1.0 18	1.0 18	1.5 16	1.5 16	2.5 14	4.0 12	6.0 10
Input Cable Max.	[mm ²] [awg]	10.0 8	10.0 8	10.0 8	10.0 8	10.0 8	10.0 8	10.0 8	35.0 2
Output Cable Min.	[mm ²] [awg]	1.0 18	1.0 18	1.0 18	1.0 18	1.0 18	2.5 14	4.0 12	4.0 12
Output Cable Max.	[mm ²] [awg]	10.0 8	10.0 8	10.0 8	10.0 8	10.0 8	10.0 8	10.0 8	35.0 2

Order No.	6SE6440-	2UE31 -8DA1	2UE32 -2DA1	2UE33 -0EA1	2UE33 -7EA1	2UE34 -5FA1	2UE35 -5FA1	2UE37 -5FA1
Fuse	[A]	50	63	80	80	125	160	160
Recommended	3NA	3820-6	3822-6	3824-6	3824-6	3132-6	3136-6	3136-6
for UL specified	3NE	1817-0	1818-0	1820-0	1820-0	1022-0	1224-0	1224-0
Input Cable Min.	[mm ²] [awg]	10.0 8	10.0 8	16.0 8	25.0 3	25.0 3	50.0 10	50.0 10
Input Cable Max.	[mm ²] [awg]	35.0 2	35.0 2	35.0 2	35.0 2	150.0 300	150.0 300	150.0 300
Output Cable Min.	[mm ²] [awg]	6.0 10	10.0 8	16.0 6	16.0 6	25.0 3	35.0 2	50.0 10
Output Cable Max.	[mm ²] [awg]	35.0 2	35.0 2	35.0 2	35.0 2	150.0 300	150.0 300	150.0 300

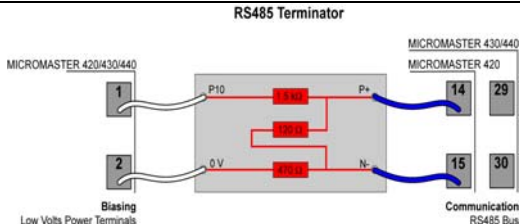

Fig. 1

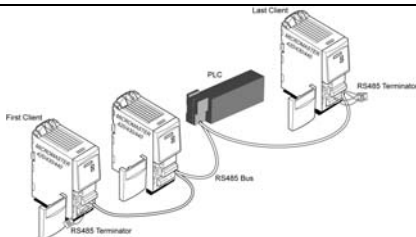

Fig. 2

Using MICROMASTER 420/430/440 with RS485 communication requires a proper termination at **both ends** of the bus (between P+ and N-), and correct pull up/ pull down resistors at at least one end of the bus (e.g. from P+ to P10, and N- to 0V).

► When the MICROMASTER drive inverter is the last slave on the bus (Fig 2 on the right), and there are no other pull up/pull down resistors on the bus, the supplied terminator must be connected shown in Fig.1.

► When the MICROMASTER is the first slave on the bus (Fig. 2) the RS485 Terminator may be used to terminate the bus by using P+ and N- only, for the bus is powered by the last drive as explained.

Note: The supply for the pull up/ pull down resistors must be available whenever RS485 communication is in progress! Further information is available in FAQ : ID 12462284 of the Siemens Drive Support in the Net:

<http://www.siemens.com/automation/service&support> (type 12462284 in the search box).

Der Einsatz des MICROMASTER 420/430/440 in einer RS485-Bus-Kommunikation erfordert 1. eine Stromversorgung und 2. an beiden Bus-Enden einen Abschlusswiderstand zwischen P+ und N-).

► Ist der Umrichter der letzte Slave auf dem Bus (im Bild 2), so ist dort P+ und N- des benachbarten RS485 Terminators mit den RS485 Klemmen wie gezeigt (Bild 1) zu verbinden. P10 und 0V können zur Stromversorgung mit Klemme 1 und 2 verbunden werden.

► Ist der Umrichter der erste Slave (Bild 2, links), so braucht man dort nur den Bus mit P+ N- zu terminieren. **Zu beachten:** Die Stromversorgung mittels Pull-Up-/Pull-down-Widerständen muss immer zur Verfügung stehen, wenn die RS485 Kommunikation läuft!

Weitere Informationen finden Sie in der FAQ Nr. (ID) 12462284 vom Siemens Drive Support unter

<http://www.siemens.com/automation/service&support>

L'utilisation des MICROMASTER 420/430/440 dans un réseau de communication RS485 exige : 1. Une alimentation de courant et 2. À chaque terminaison de réseau une résistance entre P+ et N-).

- Si le convertisseur est le dernier esclave du réseau (Image 2), il faut connecter P+ et N- du „RS485 terminator“ avec les bornes RS485 (voyez image 1). P10 et 0V peuvent être connecté avec les bornes 1 et 2 pour obtenir une alimentation
- Si le convertisseur est le premier esclave du réseau (image 2, la gauche), il ne faut que terminer le réseau avec P+ N-.

Attention : L'alimentation avec des résistances pull-up / pull-down doit toujours être disponible quand la communication RS485 fonctionne. Vous trouvez des informations supplémentaires sous le „FAQ numéro 12462284“ de Siemens Drive Support : <http://www.siemens.com/automation/service&support>

Comunicando en un bus RS485 requiere una terminación apropiada en ambos extremos del bus (entre P + y N-), y unas resistencias pull up/ pull down adecuadas al menos en un extremo del bus (por ejemplo de P + a P10, y de N- a 0V).

- Cuando el MICROMASTER es el último esclavo del bus (Fig. 2), y no hay ninguna resistencia pull up/ pull down en el bus, el terminador debe conectarse tal y como se muestra en la Fig. 1.
- Cuando el MICROMASTER es el primer esclavo del bus (Fig. 2) el terminador RS485 se usa para terminar el bus conectando sólo P+ y N-, ya que el bus es alimentado por el último convertidor.

Nota: ¡Las resistencias pull up/ pull down deben alimentarse siempre que la comunicación RS485 esté en el progreso! Para más información consulte el FAQ Nr. (ID) 12462284 en la página del Customer Support de Siemens en la red: <http://www.siemens.com/automation/service&support>

Il collegamento dei MICROMASTER 420/430/440 attraverso una connessione RS485 richiede una opportuna terminazione del bus ad entrambe le estremità (fra P+ e N-) e le corrette resistenze di pull up/down almeno ad una estremità del bus (p.e. da P+ e P10 e fra N- e 0V).

- Quando il MICROMASTER è l'ultimo slave sul bus (fig. 2), e non ci sono altre resistenze di pull up/down, i terminatori forniti devono essere collegati come in fig. 1.
- Quando il MICROMASTER è il primo slave sul bus (fig. 2), il terminatore deve essere usato solo per connettere P+ e N-

Nota: Quando la comunicazione è attiva, l'alimentazione per le resistenze di pull up/down deve essere sempre presente. Ulteriori informazioni sono disponibili nella FAQ ID 12462284 sul sito Support: <http://www.siemens.com/automation/service&support>

使用 MICROMASTER 420/430/440 变频器的 RS485 串行通讯时，必须在 总线末端的两个端子(P+和N-)

之间连接相应的终端电阻，而且至少应在总线的 一端安装适当的上拉 / 下拉电阻(例如，P+与P10(+10V)之间,N-与0V 之间)。

- ◆ 如果MICROMASTER变频器是总线上的最后一个从站(如图2中右面的一台变频器)，而且总线上没有其他的上拉/下拉电阻时，终端电阻必须按照图1所示的方法进行连接。
- ◆ 如果MICROMASTER变频器是总线上的第一个从站(如图2中左面的一台变频器)时，RS485的两个端子可以作为总线的终端，只使用P+ 和N-，关于总线由最后一台变频器供电的情况，请参看上面的说明。

说明:无论RS485是否在进行通讯，上拉/下拉电阻的电源都是必须接通的，详细的说明资料请参看FAQ ID 12462284，

西门子公司传动装置的客户支持 资料，网址：<http://www.siemens.com/automation/service&support>

English	<p>Commissioning</p> <p>The MICROMASTER comes with a Status Display Panel (SDP) and default parameters settings to cover the following:</p> <ul style="list-style-type: none"> ➤ Motor rating data; voltage, current and frequency are all compatible with the inverter data ➤ Linear V/f motor speed, controlled by an analog potentiometer ➤ Maximum speed 3000 rpm with 50 Hz (3600 rpm with 60 Hz); controllable using a potentiometer via the inverter's analogue inputs ➤ Ramp-up time / Ramp-down time = 10 s
Deutsch	<p>Inbetriebnahme</p> <p>Der MICROMASTER wird mit einem Zustands-Anzeigefeld (Status Display Panel, SDP) und mit Parametereinstellungen geliefert, die folgende Anforderungen abdecken:</p> <ul style="list-style-type: none"> ➤ Die Motordaten, Spannung, Strom und Frequenz sind sämtlich mit den Daten des Umrichters kompatibel ➤ Lineare U/f-Kennlinie für Motordrehzahl, durch ein analoges Potentiometer gesteuert ➤ Höchstdrehzahl 3000/min bei 50 Hz (3600/min bei 60 Hz); steuerbar über ein an die Analogeingänge des Umrichters angeschlossenes Potentiometer ➤ Rampenhochlaufzeit / Rampenrücklaufzeit = 10 s
Français	<p>Mise en service</p> <p>Le MICROMASTER est fourni avec un panneau d'affichage SDP et avec un préréglage des paramètres couvrant les exigences suivantes :</p> <ul style="list-style-type: none"> ➤ Les caractéristiques nominales du moteur, la tension, le courant et la fréquence sont compatibles avec les caractéristiques du variateur ➤ Caractéristique linéaire de vitesse U/f avec commande par potentiomètre ➤ Vitesse maximale 3000 tr/min à 50 Hz (3600 tr/min à 60 Hz) ; réglable par un potentiomètre raccordé à une entrée analogique du variateur ➤ Temps de montée et temps de descente de 10 s
Español	<p>Puesta en servicio</p> <p>El MICROMASTER se entrega equipado con un panel SDP (Status Display Panel) y parámetros ajustados por defecto que cubren los requisitos siguientes:</p> <ul style="list-style-type: none"> ➤ Los datos nominales del motor – tensión, corriente y frecuencia – son todos compatibles con los datos del convertidor ➤ Característica V/f lineal de variación de velocidad en el motor, controlada por un potenciómetro analógico ➤ Velocidad máxima 3000/min con 50 Hz (3600/min con 60 Hz), controlable con un potenciómetro a través de las entradas analógicas del convertidor ➤ Tiempo de aceleración / tiempo de deceleración = 10 s
Italiano	<p>Messa in servizio</p> <p>L MICROMASTER è fornito con un display (Status Display Panel) per la visualizzazione e l'impostazione di parametri di default con il quale si può verificare:</p> <ul style="list-style-type: none"> ➤ Compatibilità dei dati di targa del motore, della tensione, della corrente e della frequenza ai dati dell'inverter ➤ Velocità lineare V/f del motore controllata da un potenziometro analogico ➤ Velocità massima di 3000/min a 50 Hz (3600/min a 60 Hz); controllabile tramite potenziometro attraverso gli ingressi analogici dell'inverter ➤ Tempo di accelerazione / Tempo di decelerazione = 10 s

Additional documentation support

SD Manual Collection

The SD Manual Collection is a complete collection of all Standard Drives documentation across the entire range of Standard Drives products, including Inverters, Motors and Geared-Motors. It is available to order as a DVD which runs in its own java-driven HTML interface. The order number for the SD Manual Collection is: **6SL3298-OCA00-0MG0**

On-line documentation

All Standard Drives documentation is available on-line at the following site:

<http://support.automation.siemens.com/ww/view/en/4000024>

All documents are available for download, including Operating Instructions and Parameter Lists.

Device description files (GSD)

The device description files (GSD) are used to integrate an Inverter into a higher level control device, for example, SIMATIC S7. The required GSD files can be downloaded from the internet at the following site:

<http://support.automation.siemens.com/ww/view/en/6567719>

Commissioning file for DeviceNet (EDS file)

EDS file for the DeviceNet module for the MICROMASTER 420, 430 and 440. This is required to operate the MICROMASTER 4 via DeviceNet and to allow the configuration tools to recognise the inverter. The required EDS files can be downloaded from the internet at the following site: <http://support.automation.siemens.com/ww/view/en/11783545>

Zusätzlicher Dokumentations Support

SD Manual Collection

Die SD Betriebsanleitungen Kollektion ist eine umfassende, komplette Kollektion von allen Standard Drives Dokumenten. Diese Kollektion geht quer durch den gesamten Bereich der Standard Drive Produkte, einschließlich Frequenzumrichter, Motoren und Getriebemotoren. Es ist möglich die Dokumentation auch als DVD zu bestellen, die im Java Format mit HTML Schnittstelle verwendet werden kann. Die Bestellnummer für die SD Betriebsanleitungen Kollektion ist: **6SL3298-OCA00-0MG0**

On-line Dokumentation

Die gesamte Standard Drive Dokumentationen sind On-line auf der folgender Webseite verfügbar:

<http://support.automation.siemens.com/ww/view/en/4000024>

Alle Dokumente können heruntergeladen werden, inbegriffen sind Bedienungsanleitungen und Parameterlisten.

Generic Station Description Dateien (GSD)

Die Generic Station Description Dateien (GSD) werden benötigt, um einen Frequenzumrichter an eine übergeordnete Steuerung einzubinden, zum Beispiel SIMATIC Step7. Die erforderlichen GSD Dateien können von der folgenden Webseite heruntergeladen werden. <http://support.automation.siemens.com/ww/view/de/6567719>

Projektierungsdatei für DeviceNet (EDS Datei)

EDS Datei für die DeviceNet-Baugruppe für die MICROMASTER-Geräte 420, 430 und 440. Diese wird benötigt, um den MICROMASTER 4 als Teilnehmer am DeviceNet zu betreiben und das Gerät dem Projektierungstools bekannt zu machen. Die erforderlichen EDS Dateien können von der folgenden Webseite heruntergeladen werden. <http://support.automation.siemens.com/ww/view/en/11783545>

	English	Deutsch
P0010 1 = Quick Commissioning	Start Quick Commissioning P0010 must always be set back to '0' before operating the motor. However if P3900 = 1 is set after commissioning this is done automatically	Start Schnellinbetriebnahme P0010 muss vor der Betrieb des Motors auf '0' zurückgesetzt werden. Wird nach der Inbetriebnahme P3900 = 1 eingestellt, dann erfolgt dies automatisch.
P0100 0 = kW / 50 Hz 1 = hp / 60 Hz 2 = kW / 60 Hz	Operation for Europe / N. America For setting 0 and 1 use DIP Switch 2. For setting 2 use P0100	Betrieb für Europa / Nordamerika Die Einstellungen 0 und 1 sind über DIP-Schalter 2 herzustellen. Einstellung 2 über P0100
P0304 10 V - 2000 V	Rated Motor Voltage Nominal motor voltage (V) from rating plate	Motornennspannung Motornennspannung (V) vom Typenschild des Motors
P0305 0 ... $2 * I_{nom}$	Rated Motor Current Nominal motor current (A) from rating plate	Motornennstrom I_{nom} = Motornennstrom (A) vom Typenschild
P0307 0 kW - 2000 kW	Rated Motor Power Nominal motor power (kW) from rating plate. If P0100 = 1, values will be in hp	Motornennleistung Motornennleistung (kW) vom Typenschild. Bei P0100 = 1, sind die Werte in hp
P0310 12 Hz - 650 Hz	Rated Motor Frequency Nominal motor frequency (Hz) from rating plate	Motornennfrequenz Motornennfrequenz (Hz) vom Typenschild

Français	Español	Italiano
<p>Mise en service rapide A noter qu'avant la mise en service du moteur, P0010 doit toujours être réglé sur '0'. Ceci s'effectue automatiquement si P3900 = 1 après la mise en service</p>	<p>Puesta en servicio rápida Recuerde que P0010 debe retornarse siempre a '0' antes de poner en marcha el motor. Sin embargo, si tras la puesta en servicio se ajusta P3900 = 1, esto se hace automáticamente</p>	<p>Avvio messa in servizio rapida Si tenga presente che il parametro P0010 deve sempre essere riportato a '0' prima di azionare il motore. Tuttavia, se dopo la messa in servizio il parametro P3900 viene impostato a 1, questa operazione verrà eseguita automaticamente.</p>
<p>Exploitation en Europe / Amérique du Nord Pour les réglages 0 et 1, utiliser l'interrupteur DIP 2 Le réglage 2 s'établit par le par. P0100.</p>	<p>Europa / Norteamérica Para los ajustes 0 y 1, use interruptor DIP 2 Para el ajuste 2, use P0100</p>	<p>Funzionamento per Europa / N. America Impostare 0 e 1 mediante DIP Switch 2. Impostare 2 mediante P0100</p>
<p>Tension nom. du moteur Tension nominale du moteur (V) relevée sur la plaque signalétique</p>	<p>Tensión nom. del motor Tensión nominal del motor (V) tomada de la placa de características</p>	<p>Tensione nominale motore Tensione nominale del motore (V) ricavata dai dati di targa caratteristici.</p>
<p>Courant nom. du moteur Courant nominal du moteur (A) relevé sur la plaque signalétique</p>	<p>Corriente nom. del motor Corriente nominal del motor (A) tomada de la placa de características</p>	<p>Corrente nominale motore Corrente nominale del motore (A) ricavata dai dati di targa caratteristici.</p>
<p>Puissance nom. moteur Puissance nom. du moteur (kW) relevée sur la plaque signalétique. Pour P0100 = 1, valeurs en hp</p>	<p>Potencia nom. del motor Potencia nominal del motor (kW) tomada de la placa de características. Si P0100 = 1, los valores deberán ser en hp</p>	<p>Potenza nominale motore Potenza nominale del motore (kW) ricavata dai dati di targa caratteristici. Se il parametro P0100 = 1, i valori saranno in hp.</p>
<p>Fréquence nom. moteur Fréquence nominale du moteur (Hz) relevée sur la plaque signalétique</p>	<p>Frecuencia nominal del motor Frecuencia nominal del motor (Hz) tomada de la placa de características</p>	<p>Frequenza nominale motore Frequenza nominale del motore (Hz) ricavata dai dati di targa caratteristici.</p>

	English	Deutsch
P0311 0 - 40000 1/min	Rated Motor Speed Nominal motor speed (rpm) from rating plate	Motornennndrehzahl Motornennndrehzahl (1/min) vom Typenschild
P0700	Selection of Command Source (on / off / reverse) 1 = BOP 2 = Terminal / Digital Inputs (default)	Wahl von Befehlsquellen (EIN / AUS / Richtungsumkehr) 1 = BOP 2 = Klemmen (Werkseinstellung)
P1000	Selection of Frequency Setpoint 1 = BOP 2 = Analogue Setpoint (default)	Wahl des Frequenzsollwerts 1 = BOP 2 = Analogsollwert (Werkseinstellung)
P1080	Min. Motor Frequency Sets minimum motor frequency (0 - 650 Hz) at which the motor will run irrespective of the frequency setpoint. The value set here is valid for both clockwise and anti-clockwise rotation	Minimal Motorfrequenz Stellt die minimale Motorfrequenz (0 - 650 Hz) ein, mit der der Motor unabhängig vom Frequenzsollwert läuft. Der hier eingestellte Wert gilt für beide Drehrichtungen
P1082	Max. Motor Frequency Sets maximum motor frequency (0 - 650 Hz) at which the motor will run at irrespective of the frequency setpoint. The value set here is valid for both clockwise and anti-clockwise rotation	Maximal Motorfrequenz Stellt die höchste Motorfrequenz (0 - 650 Hz) ein, mit der der Motor unabhängig vom Frequenzsollwert läuft. Der hier eingestellte Wert gilt für beide Drehrichtungen

Français	Español	Italiano
Vitesse nom. du moteur Vitesse nominale du moteur (tr/min) relevée sur la plaque signalétique	Velocidad nominal del motor Velocidad nominal del motor (rpm) tomada de la placa de características	Velocità nominale motore Velocità nominale del motore (giri/minuto) ricavata dai dati di targa del motore.
Sélection de la source de commande (marche/arrêt/inversion de sens) 1 = BOP 2 = bornes (réglage usine)	Selección de la fuente de órdenes (on / off / inverso) 1 = BOP 2 = Bornes/terminales (Ajuste de fábrica)	Selezione della sorgente di comando (on / off / inversione) 1 = BOP 2 = Terminale (Default)
Sélection de la consigne de fréquence 1 = BOP 2 = consigne analogique (réglage usine)	Selección de la consigna de frecuencia 1 = BOP 2 = Consigna analógica (Ajuste de fábrica)	Selezione del valore di riferimento frequenza 1 = BOP 2 = Valore di riferimento analogico (Default)
Fréquence moteur min. Réglage de la fréquence minimale du moteur (0 - 650 Hz) indépendamment de la consigne de fréquence. Cette valeur est valable pour les deux sens de rotation.	Frecuencia mín. del motor Ajuste del mínimo de la frecuencia del motor (0 - 650 Hz) a partir de la cual girará el motor con indiferencia de la consigna de frecuencia ajustada. El valor aquí ajustado es válido tanto para giro horario (a derechas) como antihorario (a izquierdas)	Frequenza min. motore Imposta la frequenza minima (0 - 650 Hz) di funzionamento del motore, indipendentemente dal valore di riferimento frequenza. Il valore qui impostato è valido per il senso di rotazione sia orario sia antiorario.
Fréquence moteur max. Réglage de la fréquence maximale du moteur (0 - 650 Hz) indépendamment de la consigne de fréquence. Cette valeur est valable pour les deux sens de rotation	Frec. máx. del motor Ajuste del máximo de la frec. del motor (0 - 650 Hz) a partir de la cual girará el motor con indiferencia de la consigna de frec. ajustada. El valor aquí ajustado es válido tanto para giro horario como antihorario	Frequenza max. motore Imposta la frequenza massima (0 - 650 Hz) di funzionamento del motore, indipendentemente dal valore di riferimento frequenza. Il valore qui impostato è valido per il senso di rotazione sia orario sia antiorario.

	English	Deutsch
P1120 0 - 650 s	Ramp-Up Time Time taken for the motor to accelerate from standstill up to maximum motor frequency.	Rampenhochlaufzeit Zeit für das Beschleunigen vom Stillstand bis zur maximalen Motorfrequenz.
P1121 0 - 650 s	Ramp-Down Time Time taken for motor to decelerate from maximum motor frequency down to standstill	Rampenrücklaufzeit Zeit zum Verzögern von höchster Motorfrequenz bis zum Stillstand
P3900	End Quick Commissioning 0 = End Quick Commissioning without motor calculation or factory reset. 1 = End Quick Commissioning with motor calculation and factory reset (Recommended). 2 = End Quick Commissioning with motor calculation and with I/O reset. 3= End Quick Commissioning with motor calculation but without I/O reset.	Ende Schnellobetriebnahme 0 = Beendet die Schnellobetriebnahme auf Basis der aktuellen Einstellungen (ohne Motorberechnung). 1 = Beendet die Schnellobetriebnahme auf Basis der Werkseinstellung (mit Motorberechnung) (empfohlen). 2 = Beendet die Schnellobetriebnahme auf der Basis der aktuellen Einstellungen (mit Motorberechnung und E/A-Rücksetzung). 3= Beendet die Schnellobetriebnahme auf der Basis der aktuellen Einstellungen (mit Motorberechnung, ohne E/A-Rücksetzung).







Français	Español	Italiano
<p>Temps de montée Temps de rampe pour accélérer de l'arrêt à la fréquence moteur maximale.</p>	<p>Tiempo de aceleración Tiempo que lleva al motor acelerar de la parada a la frecuencia máxima ajustada</p>	<p>Tempo di accelerazione Tempo richiesto dal motore per accelerare da fermo sino alla frequenza massima.</p>
<p>Temps de descente Temps de rampe nécessaire à la décélération de la fréquence moteur maximale jusqu'à l'arrêt.</p>	<p>Tiempo de deceleración Tiempo que lleva al motor decelerar de la frecuencia máx. del motor a la parada</p>	<p>Tempo di decelerazione Tempo richiesto dal motore per decelerare dalla frequenza massima sino alla condizione di fermo</p>
<p>Fin de la mise en service rapide 0 = Termine la mise en service rapide sur la base des réglages actuels (sans calcul du moteur). 1 = Termine la mise en service rapide sur la base des réglages usine (avec calcul du moteur) (recommandé). 2 = Termine la mise en service rapide sur la base des réglages actuels (avec calcul du moteur et remise à zéro des E/S). 3 = Termine la mise en service rapide sur la base des réglages actuels (avec calcul du moteur, sans remise à zéro des E/S).</p>	<p>Fin de p. e. s. rápida 0 = Finaliza la puesta en servicio rápida basándose en los ajustes actuales (sin cálculo del motor). 1 = Finaliza la puesta en servicio rápida basándose en los ajustes de fábrica (con cálculo del motor) (recomendado). 2 = Finaliza la puesta en servicio rápida basándose en los ajustes actuales (con cálculo del motor y reseteo de E/S). 3 = Finaliza la puesta en servicio rápida basándose en los ajustes actuales (con cálculo de motor, sin reseteo de E/S).</p>	<p>Fine messa in servizio rapida 0 = Termina la messa in servizio rapida in base alle impostazioni attuali (senza calcolo motore). 1 = Termina la messa in servizio rapida in base all'impostazione di fabbrica (con calcolo motore) (Raccomandato). 2 = Termina la messa in servizio rapida in base alle impostazioni attuali (con calcolo motore e ripristino I/O). 3 = Termina la messa in servizio rapida in base alle impostazioni attuali (con calcolo motore, senza ripristino I/O).</p>

<ul style="list-style-type: none"> ● ● 	<p>Mains not present Keine Netzspannung Pas de tension réseau Red no presente Alimentazione di rete non presente</p>
<ul style="list-style-type: none"> ☀ ☀ 	<p>Ready to run Betriebsbereit Variateur prêt au service Preparado para funcionar Pronto ad entrare in funzione</p>
<ul style="list-style-type: none"> ● ☀ 	<p>Inverter fault - other than the ones listed below Andere Umrichterstörung als unten aufgezählt Autre défaut du variateur que ci-dessous Fallo en convertidor, uno de los listados abajo Errore inverter - diverso da quelli sotto elencati</p>
<ul style="list-style-type: none"> ☀ ● 	<p>Inverter running Umrichter in Betrieb Variateur en fonctionnement Convertidor en marcha Inverter in funzione</p>
<ul style="list-style-type: none"> ● ☉ 	<p>Fault overcurrent Störung Überstrom Défaut surintensité Fallo sobrecorriente Errore sovracorrente</p>
<ul style="list-style-type: none"> ☉ ● 	<p>Fault overvoltage Störung Überspannung Défaut surtension Fallo sobretensión Errore sovratensione</p>
<ul style="list-style-type: none"> ☉ ☀ 	<p>Fault motor overtemperature Störung Motorübertemperatur Défaut surchauffe moteur Fallo sobrettemperatura motor Errore surriscaldamento motore</p>



LEDs for indicating the drive state
Anzeige des Umrichterzustands
LED d'état du variateur
LEDs indicadores estado de accionamiento
Led di visualizzazione dello stato del convertitore

<ul style="list-style-type: none"> ☀ <p>On Ein Marche On On</p>	<ul style="list-style-type: none"> ● <p>Off Aus Arrêt Off Off</p>
<ul style="list-style-type: none"> ☉ <p>ca. 0,3 s Flashing Flackernd Papillotement Parpadeo Sfarfallante</p>	<ul style="list-style-type: none"> ☉ <p>ca. 1 s Twinkling Blinkend Clignotement Intermittenza Intermittente</p>

	<p>Fault inverter temperature Störung Umrichterübertemperatur Défaut surchauffe variateur Fallo sobretemperatura convertidor Errore surriscaldamento inverter</p>
	<p>Warning current limit - both LEDs twinkling same time Warnung Stromgrenzwert - Beide LEDs blinken gleichzeitig Seuil d'alarme de courant - les deux LED clignotent en phase Alarma límite corriente - Ambos LEDs intermiten al mismo tiempo Segnalazione limite corrente - Lampeggio intermittente contemporaneo di entrambi i LED</p>
	<p>Other warnings - both LEDs twinkling alternatively Sonstige Warnungen - Beide LEDs blinken abwechselnd Autres alarmes - les deux LED clignotent en alternance Otras alarmas - Ambos LEDs intermiten alternativamente Altre segnalazioni - Lampeggio intermittente alternato di entrambi i LED</p>
	<p>Undervoltage trip / undervoltage warning Unterspannungsabschaltung/-warnung Coupure/alarme de sous tension Disparo/alarma por minima tension Scatto per sottotensione / segnalazione sottotensione</p>
	<p>Drive is not in ready state - Display state > 0 Umrichter nicht bereit - Anzeige > 0 Variateur non prêt - affichage > 0 Accionamento no listo - Estado display > 0 Azionamento non in stato pronto - Stato display > 0</p>
	<p>ROM failure - Both LEDs flashing same time ROM Störung - Beide LEDs flackern gleichzeitig Défaut ROM - les deux LED papillotent en phase Fallo en ROM - Ambos LEDs parpadean al mismo tiempo Errore ROM - Sfarfallio contemporaneo di entrambi i LED</p>
	<p>RAM failure - Both LEDs flashing alternatively RAM Störung - Beide LEDs flackern abwechselnd Défaut RAM - les deux LED papillotent en alternance Fallo en RAM - Ambos LEDs parpadean alternativamente Errore RAM - Sfarfallio alternato di entrambi i LED</p>

MICROMASTER 420/430/440

入门指南



警告, 注意和提示

以下的“警告”, “注意”和“提示”是为了您的安全而提出的, 是为了防止变频器或与其连接的部件受到损坏而采取的一些措施。

特殊的“警告”, “注意”和“提示”适用于特定的操作, 放在有关章节的开始部分。请您仔细阅读这些信息, 因为它们为您提供的人身安全的保障, 并且有助于延长变频器以及与之连接的设备的使用寿命。

警告

- 本设备带有危险电压, 而且它所控制的是带有危险电压的转动机械。如果不遵守“警告”的规定, 或不按本手册的要求进行操作, 就可能造成死亡, 严重的人身伤害或重大的财产损失。
- 只有经过认证合格的专业人员才允许操作本设备, 而且在使用设备之前要熟悉本手册中所有的安全说明和有关安装、操作和维护的规定。正确地进行搬运装卸, 就位安装和操作维护, 是实现本设备安全和成功地投入运行的可靠保证。
- 在电源电压切断5分钟以内, MICROMASTER变频器的直流回路上仍然带有危险电压。因此, 切断变频器的供电电源5分钟以后, 才允许接触 MICROMASTER 变频器的任何部分。
本设备可以按照 UL508C (质量保证标准)第 42节的要求, 在变频器内部提供电动机的过载保护功能。请参看参数 P0610 (第 3访问级) 和 P0335的说明。电动机的过载保护功能也可以采用将外部PTC(正温度系数电阻) 信号接到变频器的数字输入端来实现。
- 当采用带有延迟时间的 H 或 K型熔断器作为保护器件时, 本设备适用于回路对称容量不大于 100,000安培 (均方根值) 的地方, 最大电压为:
 - MM420 = 230 V / 460 V
 - MM430 = 460 V
 - MM440 = 230 V / 460 V / 575 V

- 连接导线只能采用 1 级, 60/75° 的铜线.
- 安装变频器时, 有关固定螺丝的紧固扭矩的规定请参看"操作说明书"的有关部分.

注意:

在进行任何安装和调试之前, 请务必阅读以下的安全规则和警告, 以及设备上粘贴的所有警示标志. 确保警示标志置于醒目的地方, 并更换已经脱落或损坏的标志.

外形尺寸图

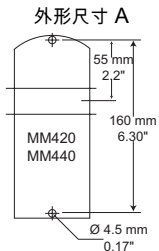

外形尺寸 D

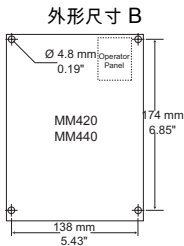

外形尺寸 E

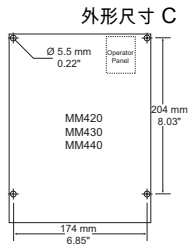

外形尺寸 F

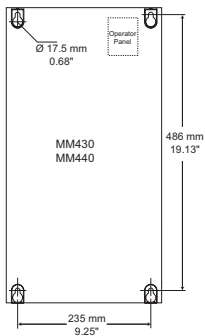

外形尺寸 FX

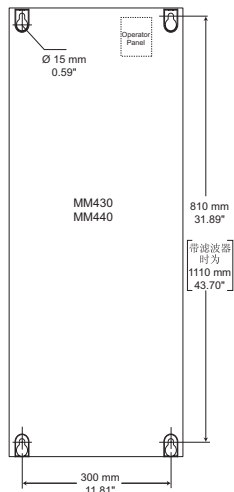
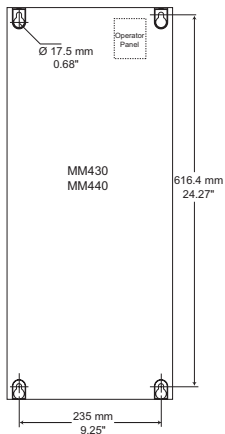

外形尺寸 GX

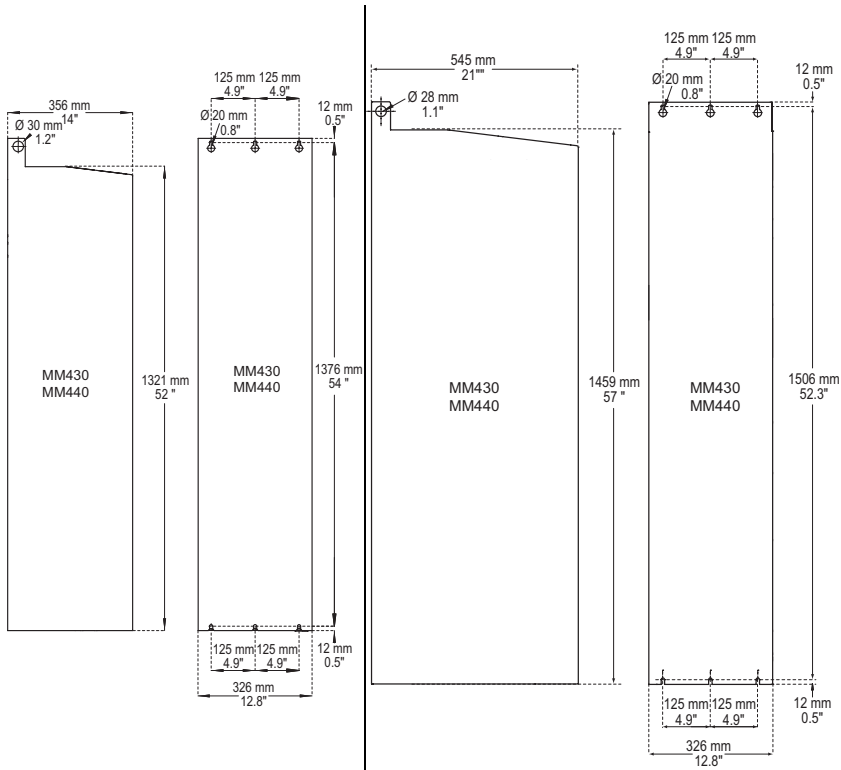

功率端子的连接 变频器

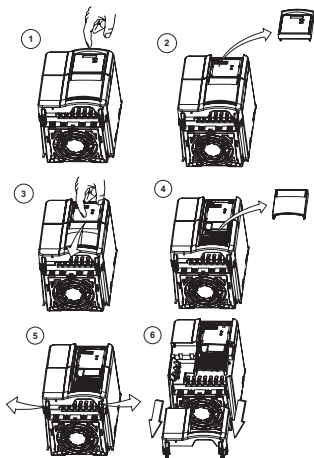
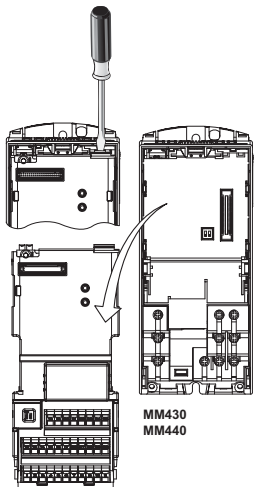

外形尺寸 A

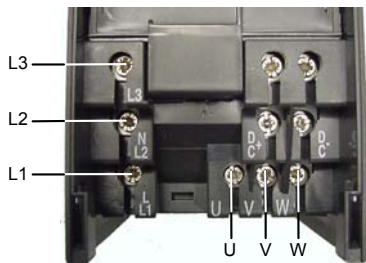

外形尺寸 B, C



外形尺寸 D, E

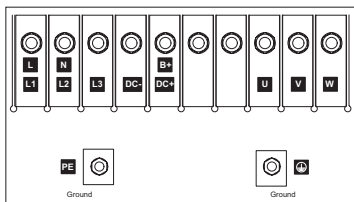
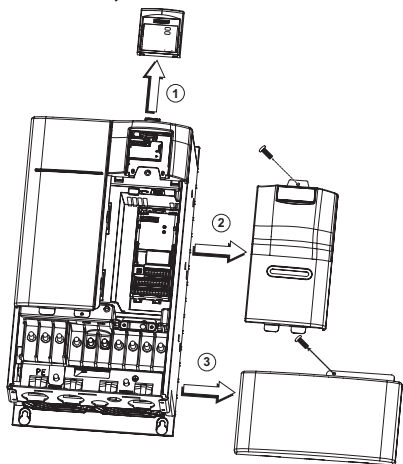

外形尺寸 F

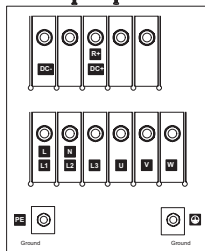
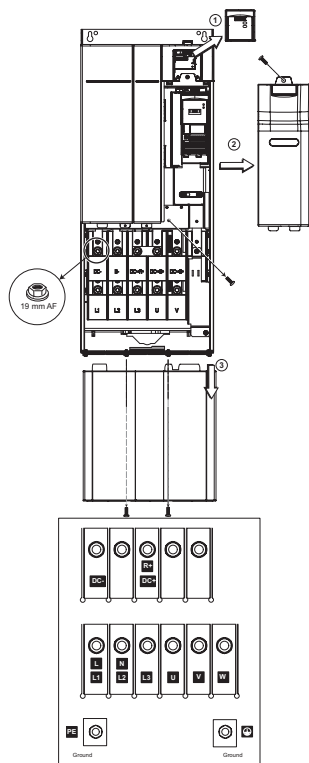

外形尺寸 FX, GX

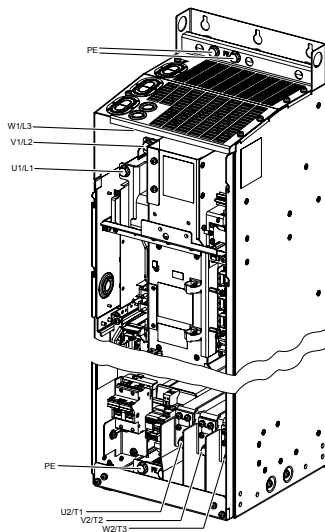

电动机

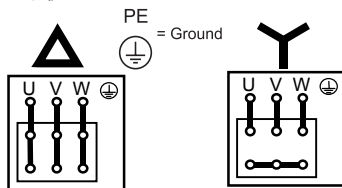

控制端子的连接

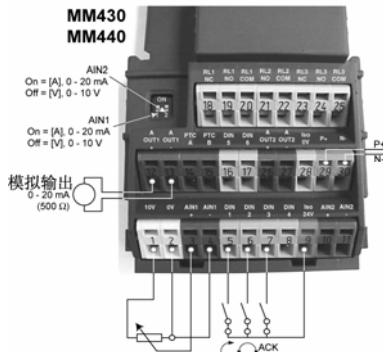
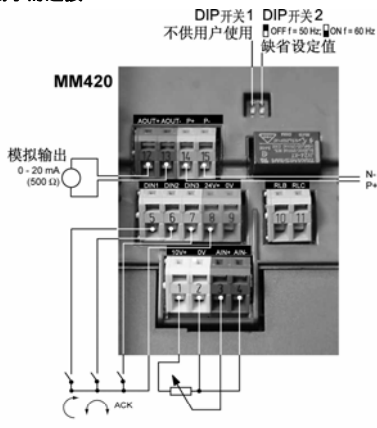

电源电压频率的设定

Remove SDP and I/O Board

**MM430
MM440**

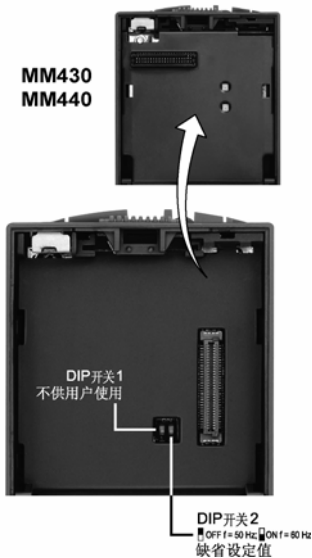

调试

MICROMASTER 变频器在供货时带有状态显示板 (SDP) 和涵盖以下内容的缺省参数设置:

- 电动机的额定数据: 电压、电流和频率与变频器的数据完全匹配。
- 电动机的速度特性为线性 V/f 控制, 由模拟式电位计进行控制。
- 50 Hz 时最大速度为 3000 转/分 (60 Hz 时为 3600 转/分); 可采用电位计通过变频器的模拟输入端进行控制。
斜坡上升时间 / 斜坡下降时间 = 10 s

如果需要更复杂的应用对象进行设置, 请参看“操作说明书”和“参数表”, 它们在变频器供货时以光盘的形式提供给用户。

本“入门指南”中, 提供了利用 BOP 进行快速调试的说明。有关 BOP 的说明, 可查阅“操作说明书”。

P0010 1 = 快速调试	开始快速调试 在电动机投入运行之前, P0010 必须回到'0'。但是, 如果调试结束后选定 P3900 = 1, 那么, P0010 的回 '0' 操作是自动进行的。
P0100 0 = kW / 50 Hz 1 = hp / 60 Hz 2 = kW / 60 Hz	选择工作地区是欧洲 / 北美 用 DIP 开关 2 设定为 0 或 1, 或 把参数 P0100 设定为 2。
P0304 10 V - 2000 V	电动机的额定电压 根据铭牌键入的电动机额定电压 (V)
P0305 0 ... 2 *I _{nom}	电动机的额定电流 根据铭牌键入的电动机额定电流 (A)
P0307 0 kW - 2000 kW	电动机的额定功率 根据铭牌键入的电动机额定功率。如果 P0100 = 1, 功率单位应是 hp
P0310 12 Hz - 650 Hz	电动机的额定频率 根据铭牌键入的电动机额定频率 (Hz)
P0311 0 - 40000 1/min	电动机的额定速度 根据铭牌键入的电动机额定速度 (rpm)

P0700	选择命令源 (on (接通) / off(断开) / reverse(反转)) 1 = 基本操作面板BOP 2 = 模入端子/ 数字输入 (缺省设置)
P1000	选择频率设定值源 1 = 用BOP给定频率 2 = 模拟设定值 (缺省设置)
P1080	电动机的最小频率 本参数设置电动机的最小频率(0-650Hz), 达到这一频率时, 电动机的运行速度将与频率的设定值无关. 这里设置的值对电动机的正转和反转都是有效的
P1082	电动机的最大频率 本参数设置电动机的最大频率(0-650Hz), 达到这一频率时, 电动机的运行速度将与频率的设定值无关. 这里设置的值对电动机的正转和反转都是有效的
P1120 0 - 650 s	斜坡上升时间 电动机从静止停车加速到最大电动机频率所需的时间.
P1121 0 - 650 s	斜坡下降时间 电动机从其最大频率减速到静止停车所需的时间.
P3900	结束快速调试 0 = 结束快速调试, 不进行电动机计算或复位为工厂缺省设置值. 1 = 结束快速调试, 进行电动机计算或复位为工厂缺省设置值 (推荐的方式). 2 = 结束快速调试, 进行电动机计算和I/O复位 3 = 结束快速调试, 进行电动机计算, 但不进行 I/O 复位.

故障和报警



指示变频器状态的发光
二极管(LED)指示灯



灯亮



约 0,3 秒, 闪光



灯灭



约 1 秒, 闪光

	没有电源		过电压故障
	运行准备就绪		电动机过热故障
	变频器故障 - 但不是下面列出的故障		变频器过温故障
	变频器正在运行		电流极限报警 - 两个LED同时闪光
	过电流故障		其它报警 - 两个LED交替闪光
			欠电压跳闸 / 欠电压报警
			变频器不在准备就绪状态 - 显示 "> 0 "
			ROM故障 - 两个LED同时闪光
			RAM故障 - 两个LED交替闪光



European Low Voltage Directive
Europäische Niederspannungsrichtlinie
Directive européenne basse tension
Directiva europea "Baja tensión"
Direttiva europea sulla bassa tensione

欧洲低电压规范

European Machinery Directive
Europäische Maschinenrichtlinie
Directive Machines européenne
Directiva europea "Maquinas"
Direttiva europea macchine

欧洲机械制造规范

European EMC Directive
Europäische EMV-Richtlinie
Directive CEM européenne
Directiva europea "Compatibilidad electromagnetica"
Direttiva europea EMC

欧洲电磁兼容性(EMC) 规范



Underwriters Laboratories

UL and CUL LISTED POWER CONVERSION EQUIPMENT for use in a pollution degree 2

质量保证实验室(UL)标准 UL 和 CUL 编目的功率转换设备 标准适用于 2 级污染的环境。

ISO 9001

Siemens plc operates a quality management system, which complies with the requirements of ISO 9001.

西门子公司按照 ISO 9001 标准的要求对其质量管理体系进行管理。

<http://www.siemens.de/micromaster>

在以下网址可以查到其他资料:

<http://www.ad.siemens.com.cn/products/sd>

**MM420/430/440
Multi-Language Pack**



A 5 E 0 2 4 5 5 4 1 4 A