



1SDC200003D0201



## Tmax, Isomax, Emax: Industrial<sup>IT</sup> enabled!

Industrial<sup>IT</sup> is the solution developed by ABB for the all-round integration of a company's activities, where each product is seen as part of a complete solution. Products and technologies are grouped into functional categories

(Suites), each of which measures,

controls, optimizes and

supports a specific "block"

of activities, and they can

ensure coordinated

interaction thanks to the

platform created by ABB

(AIP: Aspect Integrator

Platform).

In addition to interactivity between certified products, every

certified product also guarantees the ready availability of all

the information needed for it to function - technical

characteristics, installation instructions, use and maintenance

instructions, environmental certificates and declarations, all

updated to the latest version ... a considerable advantage for

the user\*.

After Tmax, which was the first Industrial<sup>IT</sup>-certified ABB

SACE product, now the whole range of Tmax and Isomax

molded case and Emax power circuit breakers has obtained

certification and is fully entitled to join the Protect<sup>IT</sup> suite of

products. These circuit breakers combine with about

700 products in the ranges of distribution boards,

thus enabling complete switchboards to be

assembled using all Industrial<sup>IT</sup>-certified

components.

Tmax, Isomax and Emax operation can be

integrated with the configurable ABB

products in a system: this compatibility has

always been a fundamental premise of the

ABB SACE design process. Mass customization, i.e. the mass

production of components customized to meet a given buyer's

specific needs is already feasible, as Industrial<sup>IT</sup> certification

demonstrates.

Yet again, ABB SACE is ahead of the field in offering a better

and better customer service!

*\* All product technical data and related documentation can be found in Internet and is accessible to the customer. The standard documentation is in English, but there are local language versions for each country where a given product is marketed.*

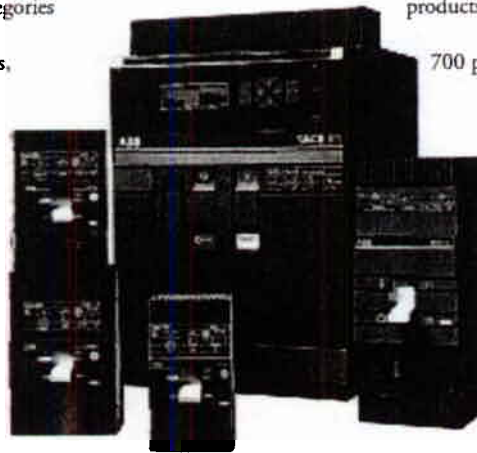

# Emax

## Overview



**Main characteristics**

1



**Installations**

2

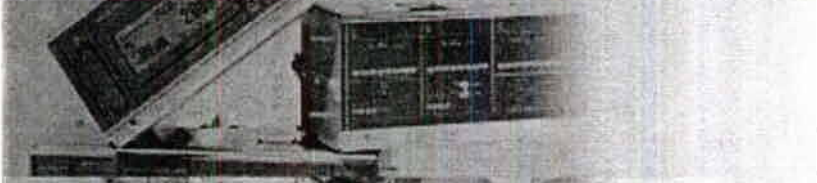

**Overcurrent trip units  
and related accessories**

3



**Accessories**

4



**Overall dimensions**

5



**Circuit diagrams**

6

# Emax power circuit breakers

## The power



*Emax power circuit breakers have always been appreciated for their high electrical performances, maximum modularity and standardisation which characterize all the ranges. Their very high safety, quality and rationality features, are the result of absolutely innovative design criteria.*



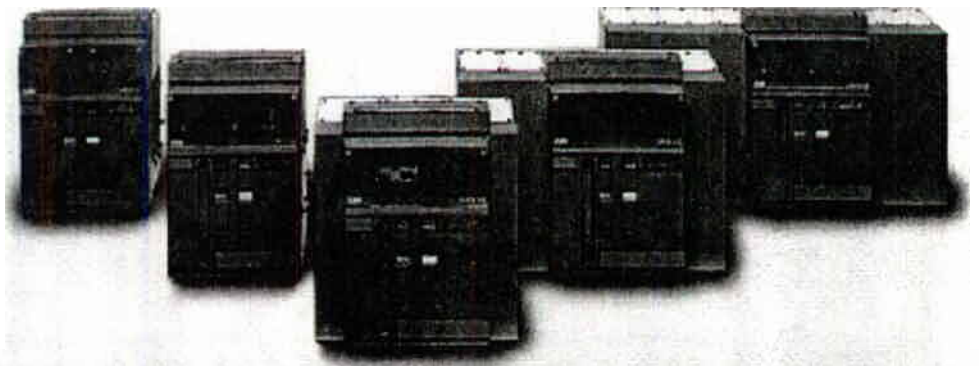

is on.

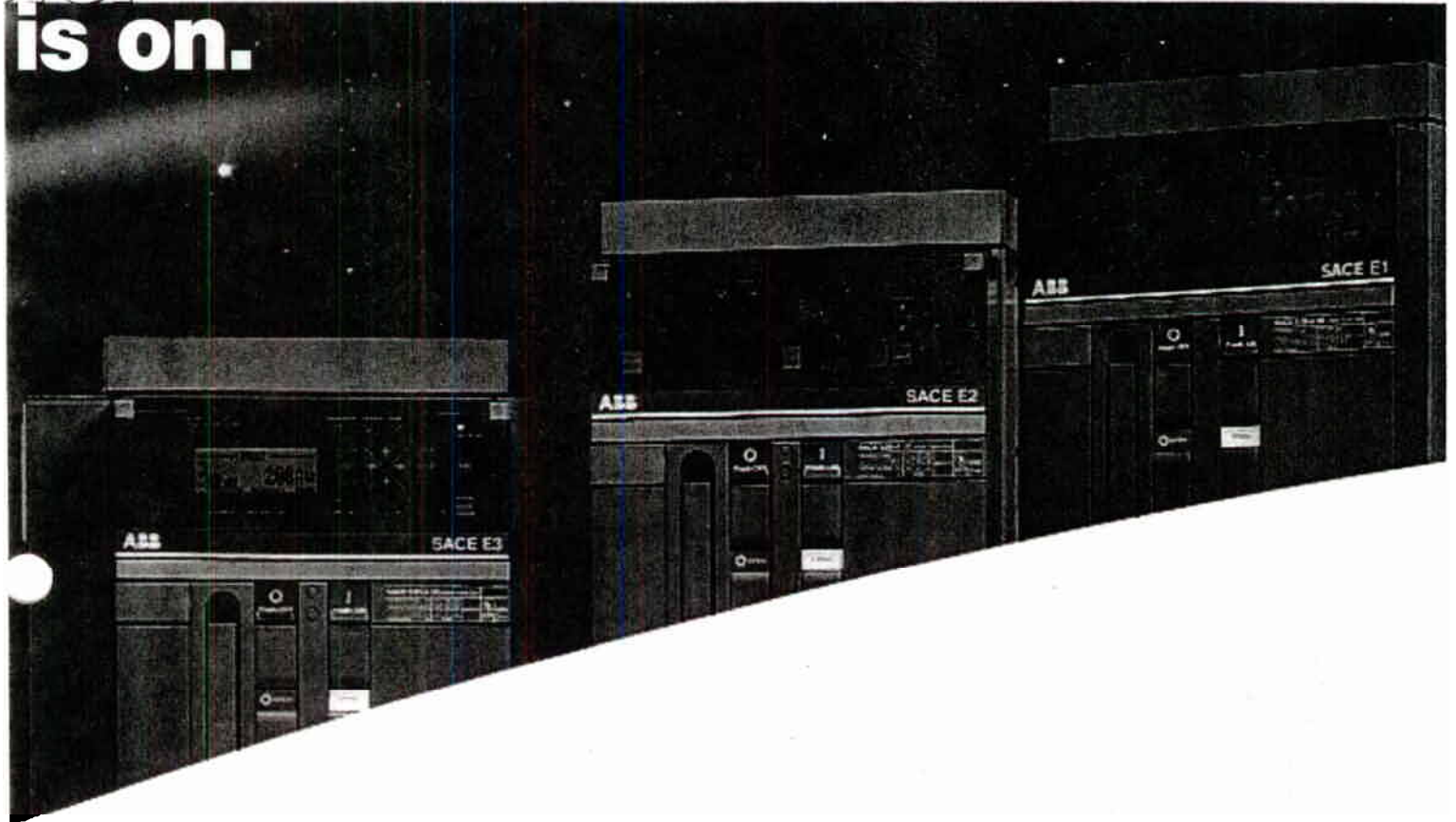

## Innovative by tradition.

The Emax low voltage power circuit breakers, designed and manufactured by ABB SACE, are at the top of the market for quality and functionality for all the different applications. Nothing comes about by chance: the long tradition of quality, reliability, and care that ABB SACE has always put into the design and production of its circuit breakers are the best

guarantee for anyone looking for advanced solutions in absolute peace of mind. Simply pass back over the history of ABB SACE power circuit breakers to see a long series of success products - fifty years spent in a persistent research of innovative and safe solutions and always at the top of the performances.





# Emax power circuit breakers Firm ground for you

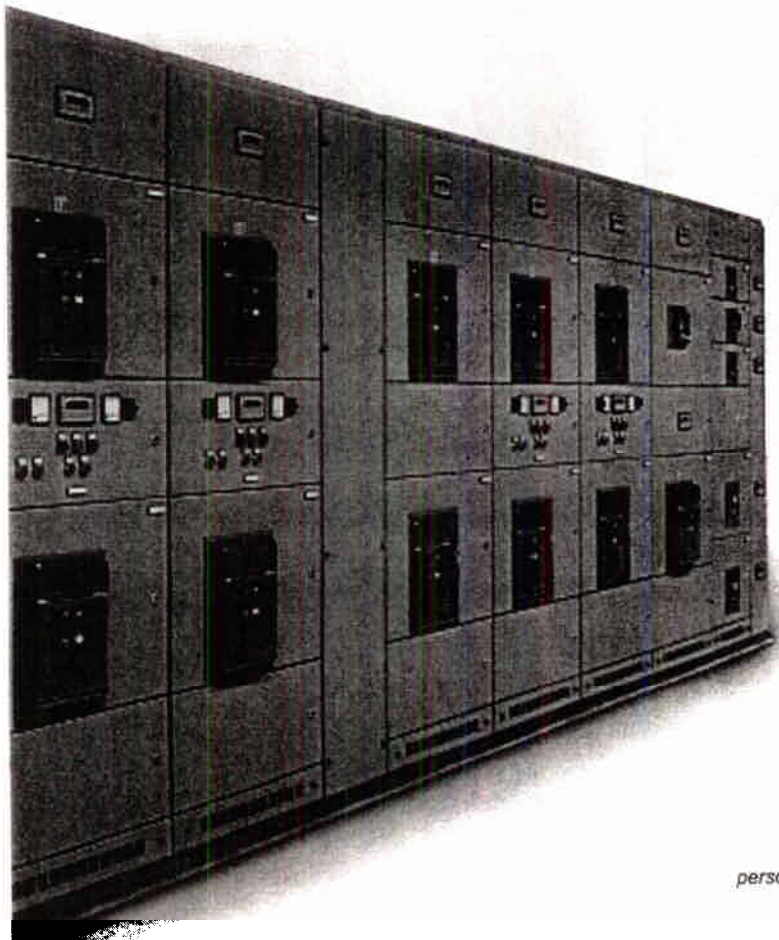

*Modularity and compactness of Emax power circuit breakers considerably simplify construction of the switchboards. The accessories are always fitted from the front simply and rapidly, without the need for cabling and in complete safety. The simplicity of these operations means that any personalisation required can be carried out directly by the end customer.*



ers.  
our solutions.

## **With this choice, there is no choice.**

Whatever the application you have in mind, there is **certainly the right** product that you need in the Emax family. Three or four pole version, fixed or draw out,

as an automatic circuit breaker or without the trip unit as a switch, **Emax** is always the solution able to satisfy your request.

# Emax power circuit breakers The benchmark for you

*The high electrical performances of all the Emax ranges go hand in hand with their mechanical and construction characteristics, thought up to provide top quality in all cases. The compactness of Emax power circuit breakers is the fruit of perfect integration of both their components and performances.*

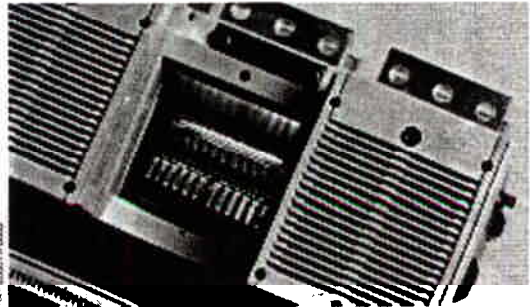



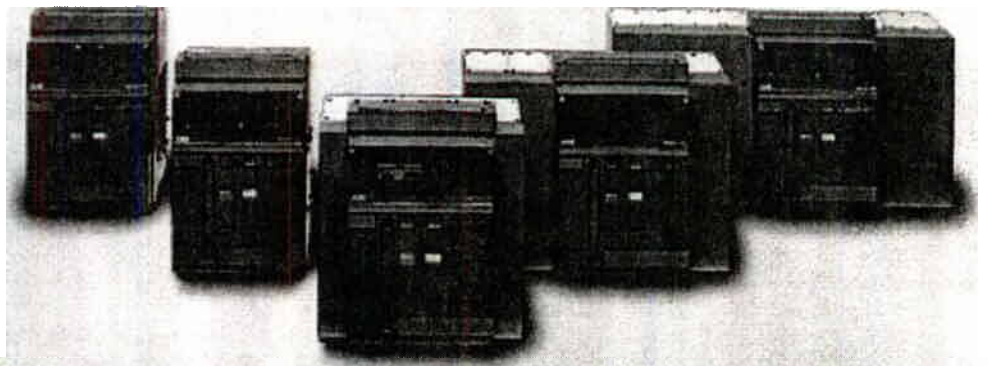

دست  
ur solutions.

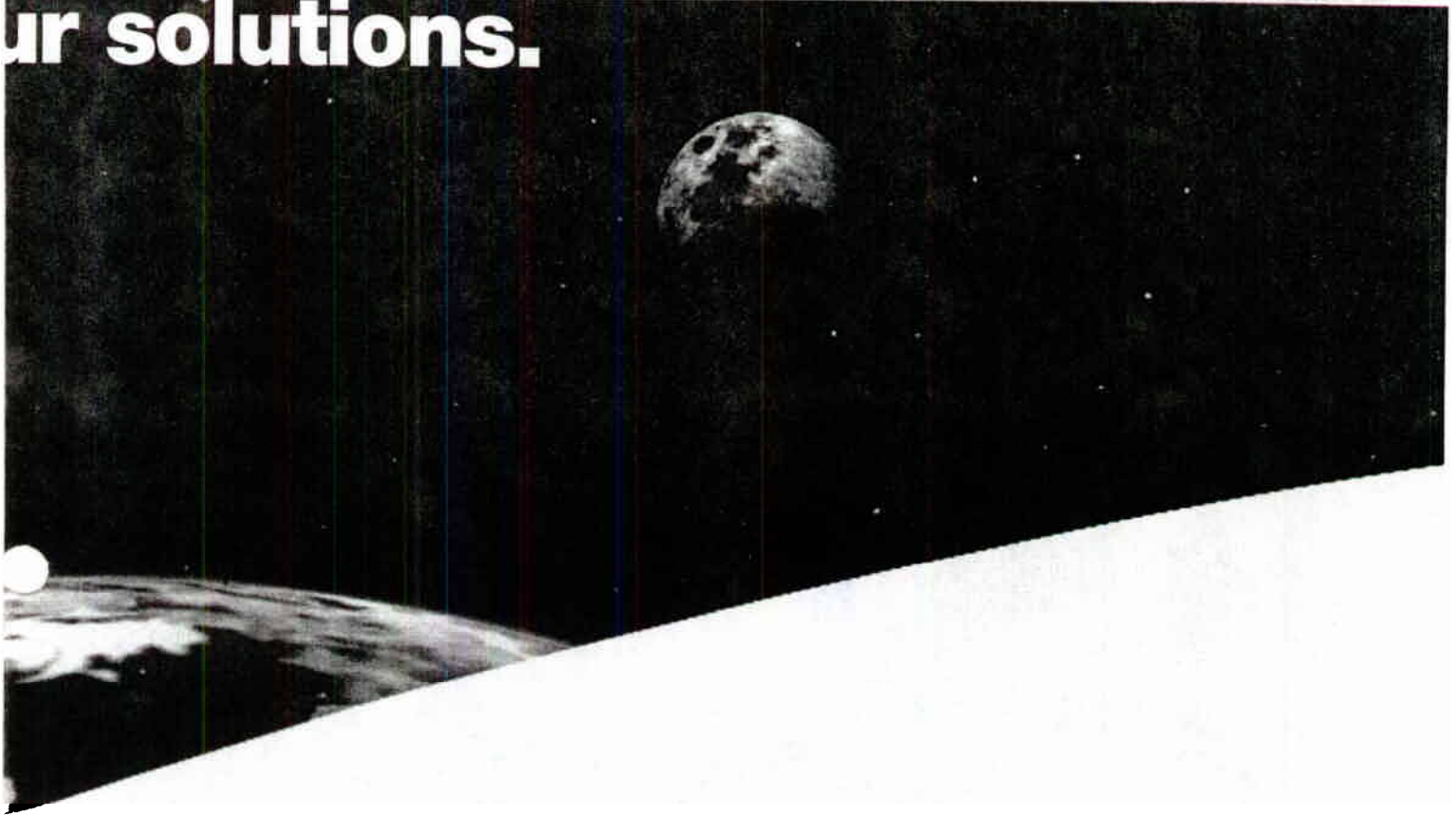

## The strong point - strength.

You can tell Emax power circuit breakers are solid at a glance. Built with an extremely sturdy metal structure, they deal brilliantly with any dynamic or thermal stresses, making each installation reliable and safe. Thanks to the materials used, an Emax power circuit breaker has a much longer mechanical life compared with the other

circuit breakers in its category, and during its very long working life, only requires minimum maintenance. As always, ABB SACE stands out for the quality of its products, for the care and attention it pays to all details - both constructional or technological - to offer products to the market which always achieves top performance.



# Emax power circuit breakers The finishing line for you



*The modern trip units Emax can be fitted with make all installations more complete and efficient: the intelligence they are equipped with can carry out many different functions, giving the circuit breaker high trip precision.*

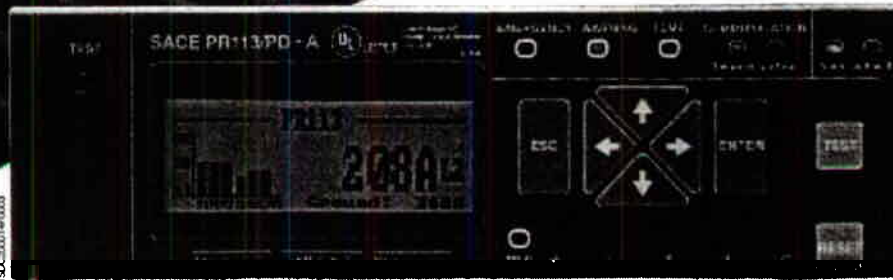

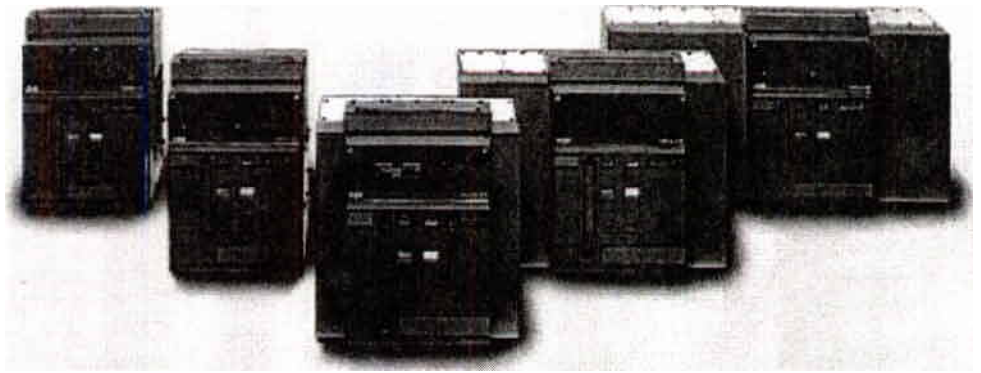

ers,  
our solutions.

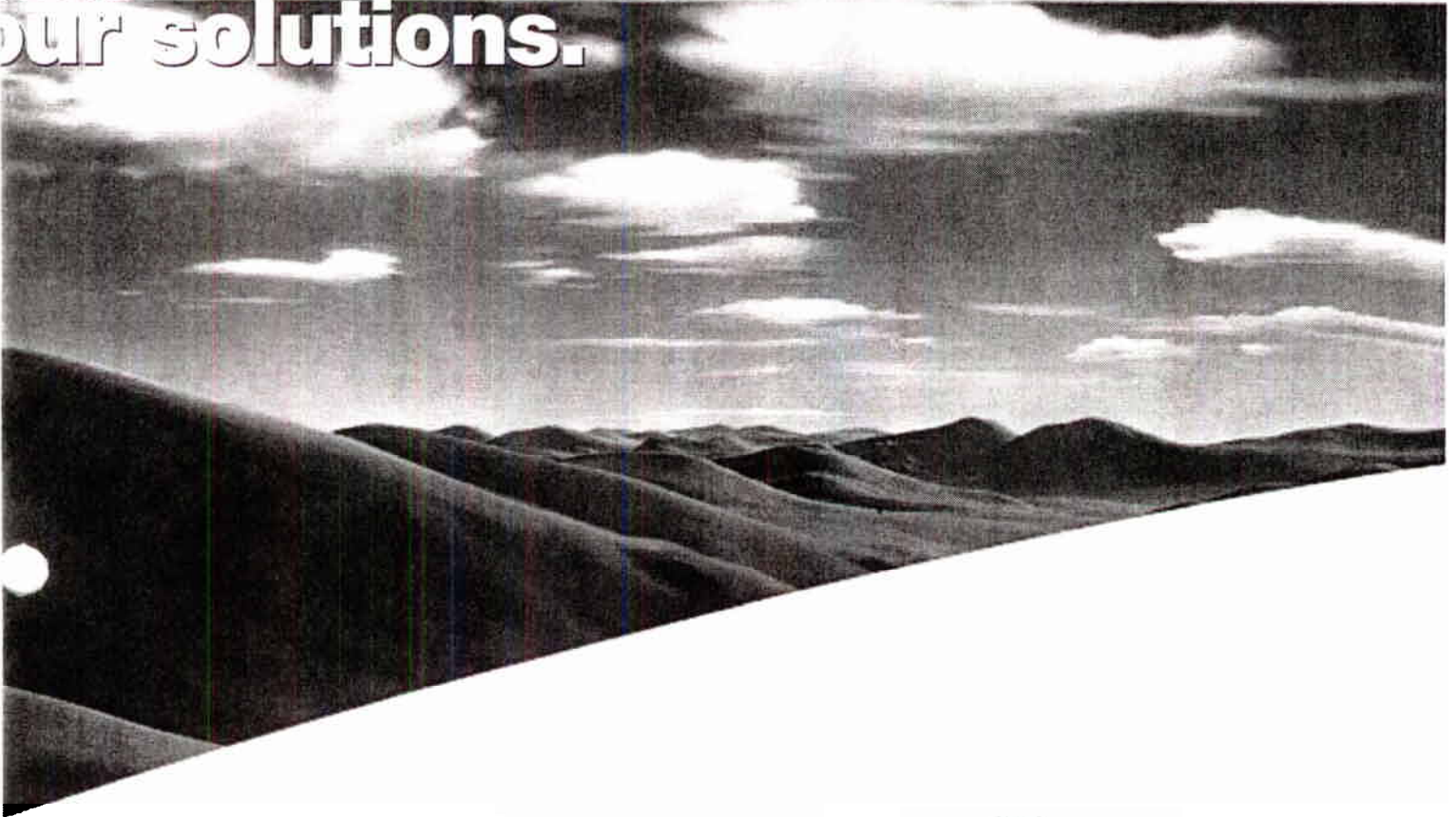

## The new intelligence - intelligent.

With Emax power circuit breakers you can always choose the amount of intelligence you need. Like the PR113-A, the latest generation of trip units for Emax, which provides a complete set of protection functions, measurements signalling, data storage and control functions. Equipped with a big and clear graphic display, this new trip unit is available in two different version, with or

without communication capabilities. The PR112-A trip units have also been improved and new functions have been added, like the five languages available to help the setting. And there are not only protection functions, but also communication capabilities that allow the breaker to be used in the most advanced automation and control systems, using the Modbus® protocol.





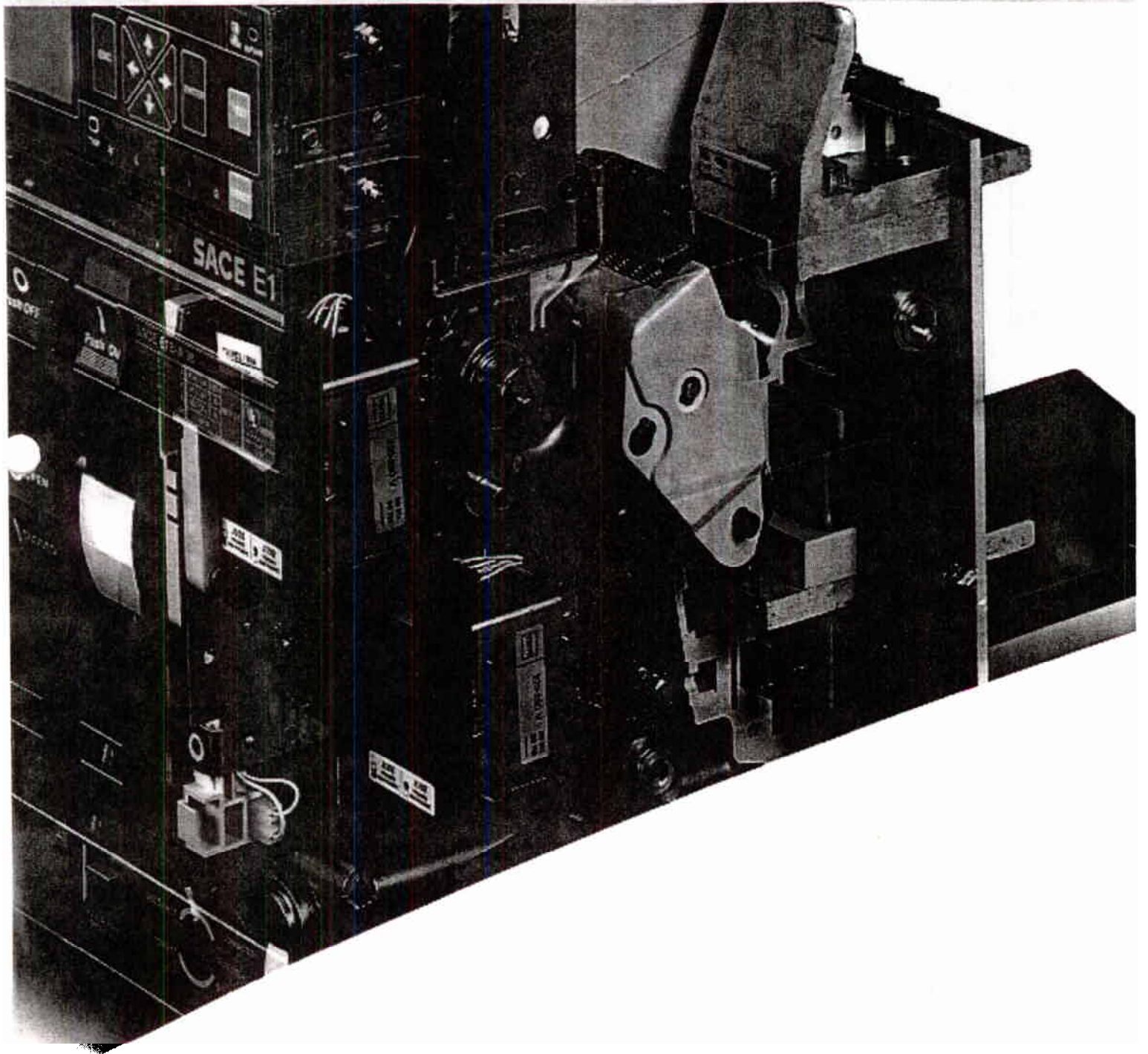

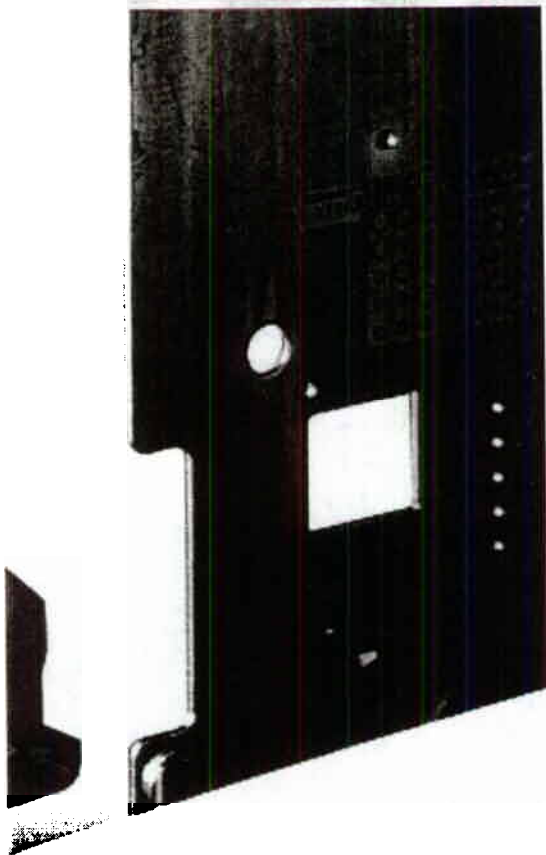

## Contents

<b>Emax UL circuit breakers</b> .....	1/2
<b>Emax UL switch disconnectors</b> .....	1/4
<b>Construction characteristics</b>	
Structure of the circuit breakers .....	1/6
Operating mechanism .....	1/7
Operating and signaling parts .....	1/8
Cradles of draw out circuit breakers .....	1/9
Circuit breaker components .....	1/10
<b>Versions and connections</b> .....	1/11
<b>Microprocessor-based trip units</b>	
General characteristics .....	1/12
UL versions available .....	1/13
Current transformer settings .....	1/15
<b>Compliance with Standards</b>	
Standards, approvals, certifications and company Quality system .....	1/16
A design dedicated to Quality and respect for the environment .....	1/17



# Emax UL circuit breakers

1

Common data	
<b>Voltages</b>	
Rated maximum voltage	[V] 635
Rated voltage	[V] 600
Test voltage (1 min. 50/60 Hz)	[kV] 2.2
Frequency	[Hz] 50 - 60
Number of poles	3 - 4
Version	Fixed (F) - Drawout (W)

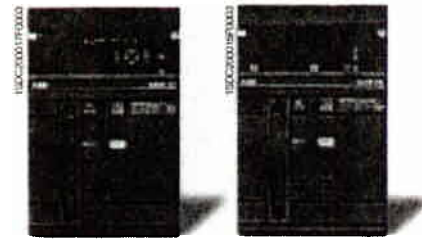

		E1	E2	
<b>Level of performance</b>		B-A	B-A	N-A
<b>Currents</b>				
Rated continuous current	[A]	800	1600	1200
	[A]	1200		1600
	[A]			
Capacity of neutral pole four-pole circuit breakers	[%I <sub>n</sub> ]	100	100	100
<b>Rated short circuit current</b>				
240 V	[kA]	42	42	65
480 V	[kA]	42	42	50
600 V	[kA]	35	42	50
Rated short time current	[kA]	35	42	50
<b>Trip units</b>				
PR111/P-A, PR111/PD-A		■	■	■
PR112/P-A, PR112/PD-A		■	■	■
PR113/P-A, PR113/PD-A		■	■	■
<b>Trip times</b>				
Closing time (max)	[ms]	80	80	80
Opening time (<ST current) (max)	[ms]	73	73	73
Opening time (>ST current) (max)	[ms]	30	30	30
<b>Overall dimensions</b>				
Fixed: H = 418 mm/16.46 in - D = 302 mm/11.89 in				
W (3 poles/4 poles)	[mm]	296/386	296/386	
W (3 poles/4 poles)	[in]	11.65/15.2	11.65/15.2	
Draw out: H = 461 mm/18.15 in - D = 396.5 mm/15.61 in				
W (3 poles/4 poles)	[mm]	324/414	324/414	
W (3 poles/4 poles)	[in]	12.76/16.3	12.76/16.3	
<b>Weights</b> (Circuit breaker complete with trip unit, RH terminals, CT, excluding accessories)				
Fixed				
3 poles/4 poles	[kg]	45/54	50/61	
3 poles/4 poles	[lbs]	99/119	110/134	
Draw out				
3 poles/4 poles	[kg]	70/82	78/93	
3 poles/4 poles	[lbs]	154/181	172/205	

		E1 B-A	E2 B-A / N-A
Rated continuous current	[A]	800	1200
Mechanical life with regular ordinary maintenance	[No. Operations x 1000]	20	20
Operation frequency	[Operations/hour]	30	30
Electrical life	[No. Operations x 1000]	10	10
Operation frequency	[Operations/hour]	30	30

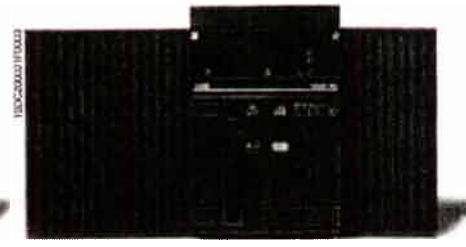

1

E3				E4			E6	
N-A	S-A	H-A	V-A	S-A	H-A	V-A	H-A	V-A
2000	1200	1200	1200	3200	3200	3200	4000	4000
2500	1600	1600	1600	3600	3600	3600	5000	5000
	2000	2000	2000					
	2500	2500	2500					
100	100	100	100	50	50	50	50	50
65	85	85	100	85	100	100	125	125
50	65	85	100	65	85	100	85	125
50	65	65	85	65	85	85	85	85
50	65	65	85	65	85	85	100	100
■	■	■	■	■	■	■	■	■
■	■	■	■	■	■	■	■	■
■	■	■	■	■	■	■	■	■
80	80	80	80	80	80	80	80	80
70	70	70	70	70	70	70	70	70
30	30	30	30	30	30	30	30	30
	404/530			566/656			782/908	
	15.91/20.82			22.28/25.83			30.79/35.78	
	432/558			594/684			810/936	
	17.01/21.97			23.39/26.93			31.89/36.85	
	66/80			97/117			140/160	
	145/176			214/258			308/353	
	104/125			147/165			210/240	
	229/275			324/363			463/529	

E3 N-A / S-A / H-A / V-A				E4 S-A / H-A / V-A		E6 H-A / V-A	
1200	1600	2000	2500	3200	3600	4000	5000
15	15	15	15	8	8	8	8
30	30	30	30	30	30	30	30
10	10	8	8	5	5	5	3
30	30	30	30	30	30	30	30





## Emax UL switch-disconnectors

The switch-disconnectors derive from the corresponding circuit breakers, of which they keep the overall dimensions and the possibility of mounting accessories unaltered. This version only differs from the circuit breakers in the absence of trip units. The switch-disconnector is available in both the three-pole and four-pole fixed and draw out version and is identified by the code "/MS". The electrical characteristics of the switch-disconnectors are given in the following table.

1



		E1B-A/MS
<b>Rated continuous current</b>	[A]	800
	[A]	1200
	[A]	
	[A]	
Number of poles		3/4
Capacity of neutral pole for four-pole circuit breakers	[%I <sub>n</sub> ]	100
<b>Rated voltage</b>	[V]	600
<b>Rated maximum voltage</b>	[V]	635
<b>Test voltage (1 min. 50/60 Hz)</b>	[kV]	2,2
<b>Frequency</b>	[Hz]	50-60
<b>Rated short time current</b>	[kA]	35
<b>Version</b>		F - W

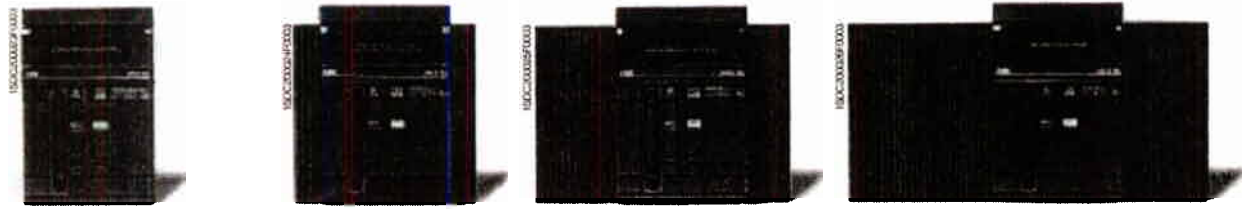

	E2B-A/MS	E2N-A/MS	E3N-A/MS	E3S-A/MS	E4S-A/MS	E4H-A/MS	E6H-A/MS
	1600	1200	2000	1200	3200	3200	4000
		1600	2500	1600	3600	3600	5000
			2000				
			2500				
	3/4	3/4	3/4	3/4	3/4	3/4	3/4
	100	100	100	100	50	50	50
	600	600	600	600	600	600	600
	635	635	635	635	635	635	635
	2.2	2.2	2.2	2.2	2.2	2.2	2.2
	50-60	50-60	50-60	50-60	50-60	50-60	50-60
	42	50	50	65	65	85	100
	F - W	F - W	F - W	F - W	F - W	F - W	F - W



## Construction characteristics

### Structure of the circuit breakers

The sheet steel structure of the circuit breaker is extremely compact, considerably reducing overall dimensions.

Safety is improved by adopting double insulation for the live parts and total segregation between phases.

The sizes have the same height and depth for all of the circuit breakers in each version.

The depth of the draw out version is suitable for installation of switchboards 500 mm/19.68 in deep.

The width of 324 mm/12.75 in (up to 2000 A) in the draw out version allows the equipment to be used in switchboard compartments 400 mm/15.74 in wide. The compact dimensions also allow them to replace power circuit breakers of any size from earlier series.

1

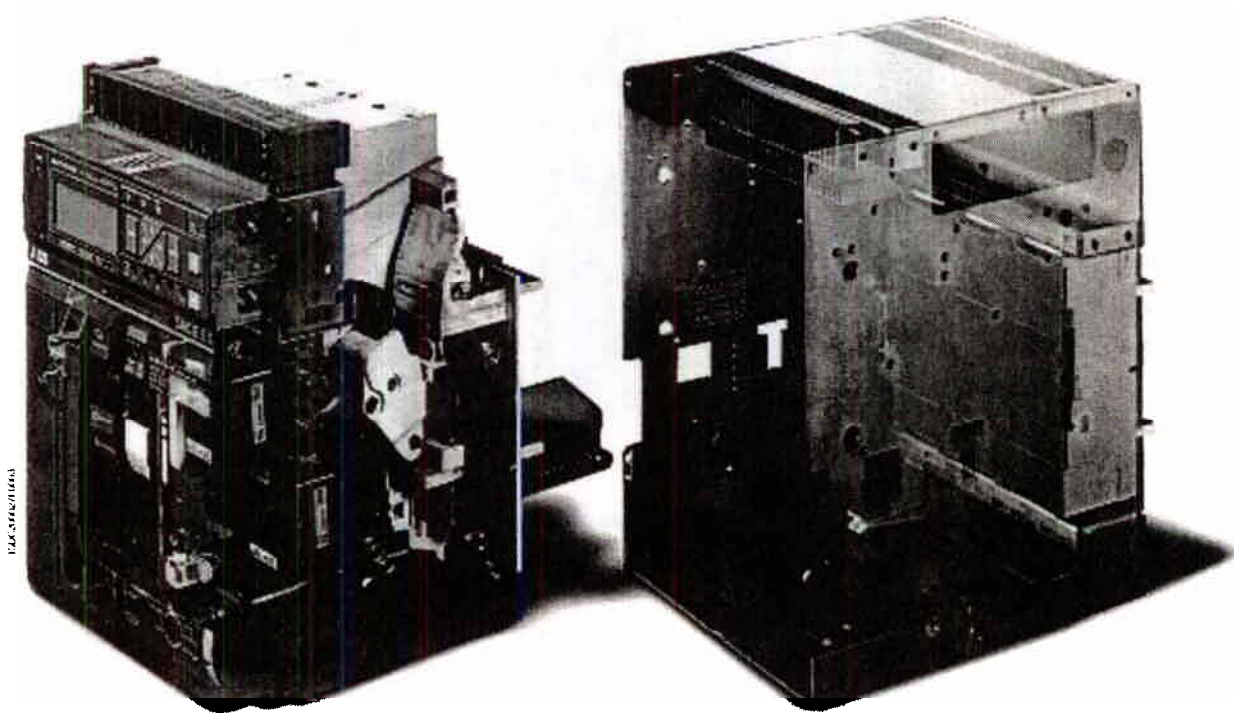

1234567890



## Construction characteristics

### Operating mechanism

The operating mechanism is of the stored energy type, operated using precharged springs.

The springs are charged manually by operating the front lever or using a geared motor, supplied on request.

The opening springs are charged automatically during the closing operation.

With the operating mechanism fitted with closing coil and shunt trip and the geared motor for charging the springs, the circuit breaker can be operated by remote control and, if required, managed by a supervision and control system.

1

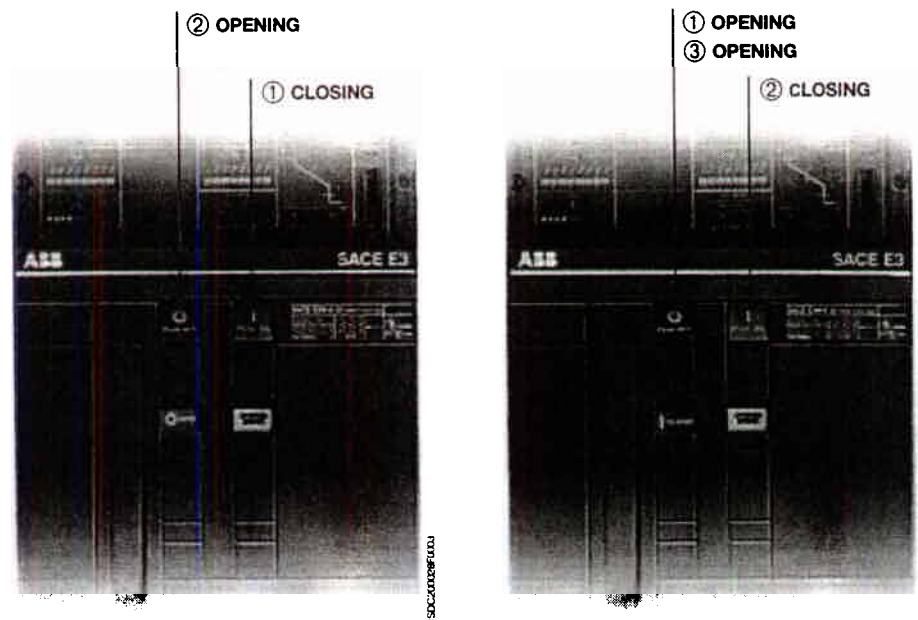

The following operating cycles are possible without recharging the springs:

- starting with the circuit breaker open (0) and the springs charged :  
closing-opening
- starting with the circuit breaker closed (I) and the springs charged :  
opening-closing-opening.

The same operating mechanism is used for the entire series and is fitted with a mechanical and electrical anti-pumping device.



# Construction characteristics

## Operating and signalling parts

### Fixed version

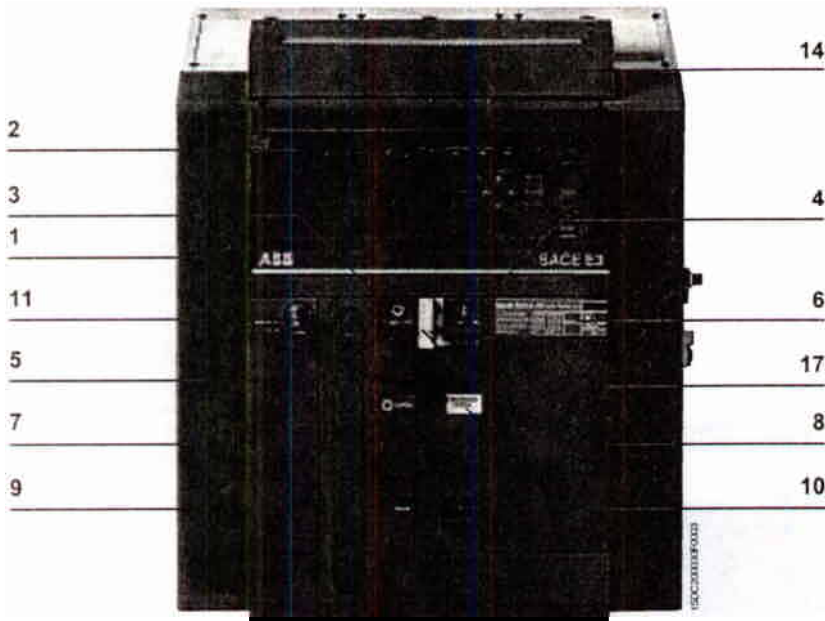

#### Legend

- |    |   |
|----|---|
| 1  | Trademark and size of circuit breaker   |
| 2  | SACE PR111-A, PR112-A or PR113-A Trip units   |
| 3  | Pushbutton for manual opening   |
| 4  | Pushbutton for manual closing   |
| 5  | Lever to manually charge closing springs  |
| 6  | Electrical rating plate   |
| 7  | Mechanical device to signal circuit breaker open "O" and closed "I"                                     |
| 8  | Signal for springs charged or discharged  |
| 9  | Mechanical signal for trip unit tripped   |
| 10 | Operation counter   |
| 11 | Key lock in open position   |
| 12 | Key lock and padlock in racked-in/racked-out position (for draw out version only)                       |
| 13 | Racking-in/racking out device (for draw out version only)   |
| 14 | Terminal box (for fixed version only)   |
| 15 | Sliding contacts (for draw out version only)  |
| 16 | Circuit breaker position indicator: connected/ isolated for test/racked-out (for draw out version only) |
| 17 | Padlock device in open position   |

### Draw out version

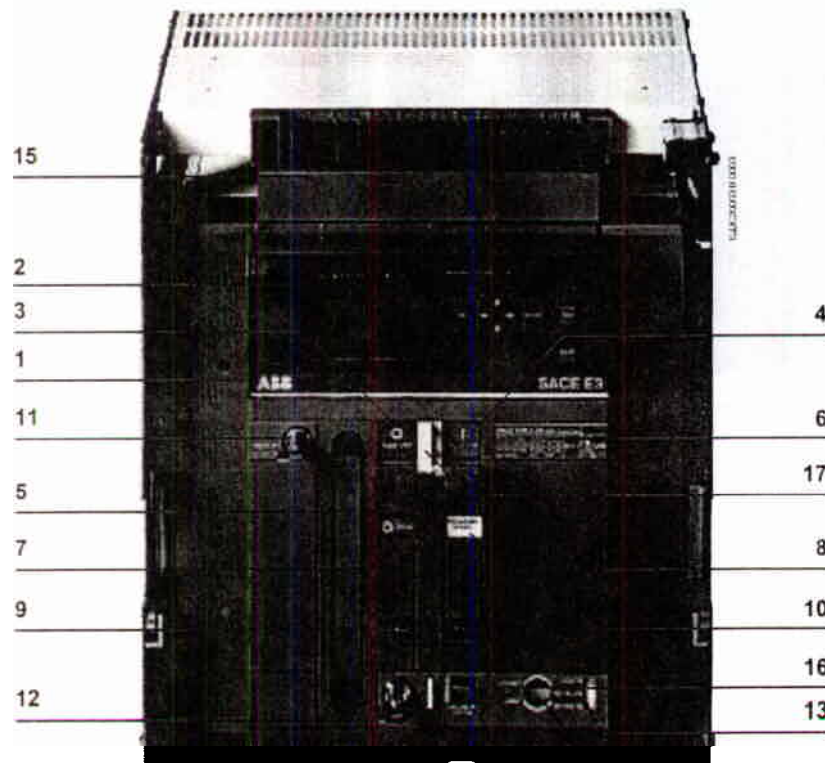

#### Note:

"Connected" refers to the position in which both the power contacts and auxiliary contacts are connected; "racked-out" is the position in which both the power contacts and auxiliary contacts are disconnected; "isolated for test" is the position in which the power contacts are disconnected, while the auxiliary contacts are connected.

1



## Construction characteristics

### Cradles of draw out circuit breakers

The cradles of draw out circuit breakers have shutters for segregating the fixed contacts when the circuit breaker is racked out of the compartment. These can be locked in their closed position using padlock devices.

#### Legend

- 1 Sheet steel supporting structure
- 2 Single earthing pliers mounted on the left for E1, E2 and E3, double earthing pliers for E4 and E6
- 3 Safety shutters (IP20 degree of protection)
- 4 Terminal support base
- 5 Terminals
- 6 Contacts signaling that the circuit breaker is connected, isolated for test, racked-out
- 7 Sliding contacts
- 8 Padlock device for safety shutters (on request)
- 9 Fixing points (4 for E1, E2, E3 and 6 for E4, E6)

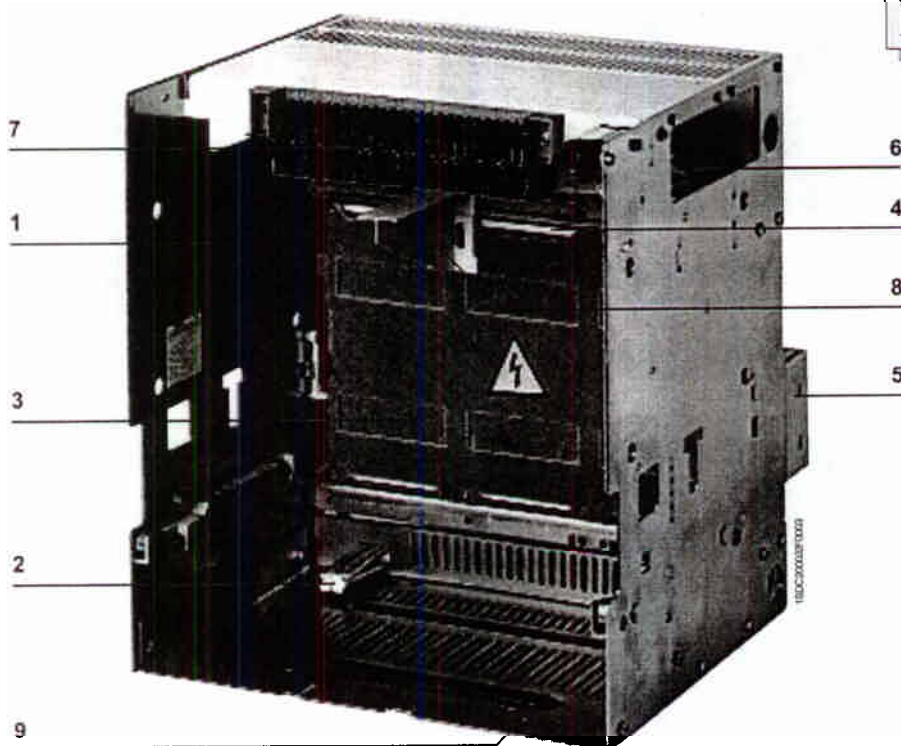



# Construction characteristics

## Circuit breaker components

1

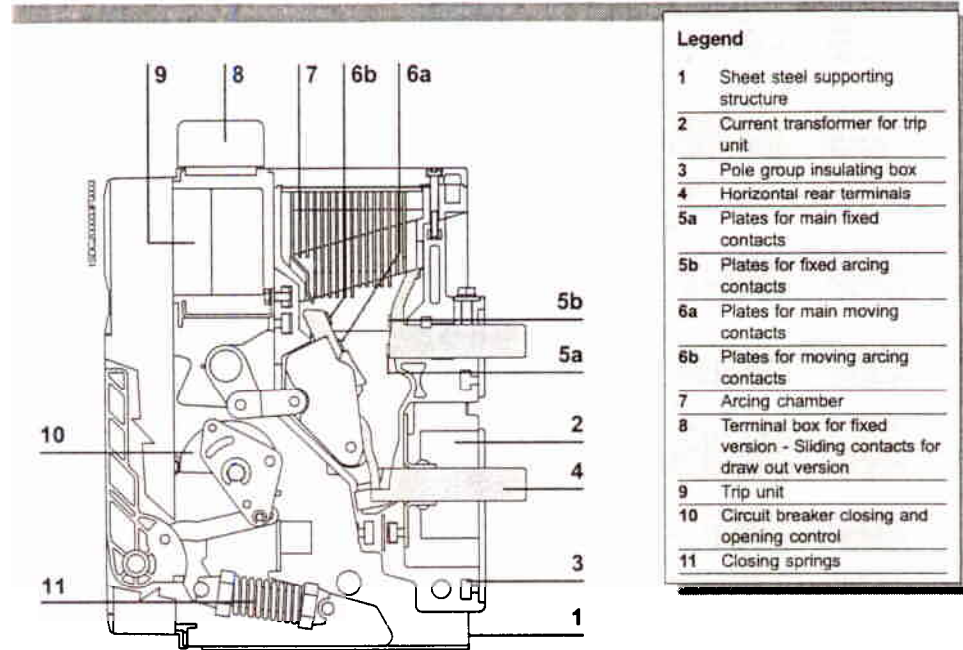

### Selective circuit breaker

E1 B-A, E2 B/N-A, E3 N/S/HV-A,  
E4 S/HV-A, E6 HV-A



## Versions and connections

All circuit breakers are available in fixed and draw out, three pole or four-pole versions.

Each series of circuit breakers offers terminals made of silver-plated copper bars in the same sizes, regardless of the continuous current ratings of the circuit breakers (except for E3).

The cradles for draw out circuit breakers are common to each size, regardless of the continuous current rating and interrupting rating of the relative moving parts (except for E3).

The availability of various types of terminals makes it possible to build switchboards against the wall, or switchboards to be accessed from behind with rear connections.

For special installation needs, the circuit breakers may be fitted with various combinations of upper and lower terminals.

The following terminals are also available in the IEC version: front for fixed and draw version and flat for draw out version.

1

### Fixed circuit breaker

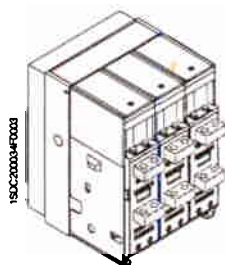

Horizontal rear terminals

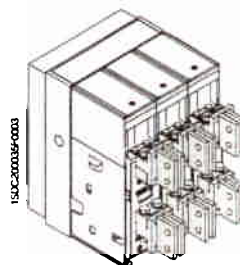

Vertical rear terminals

### Draw out circuit breaker

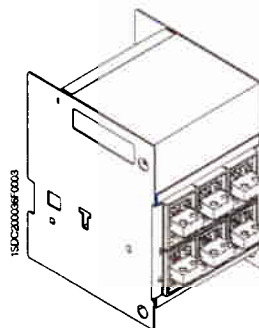

Horizontal rear terminals

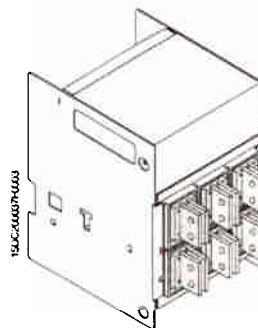

Vertical rear terminals





## Microprocessor-based trip units

### General characteristic

The overcurrent protection for AC installations uses three types of microprocessor-based trip units in the SACE PR111-A, PR112-A and PR113-A series, which can be installed as alternatives to one another on SACE Emax circuit breakers:

- SACE PR111-A with protection functions only
- SACE PR112-A with protection, current measurement and dialogue functions
- SACE PR113-A with a complete set of functions for protection, measurement, signaling, control and dialogue.

The protection systems can be three-phase or three-phase with neutral depending on the type of circuit breaker used (three-pole, three-pole with external neutral or four-pole).

The protection system is made up of:

- 3 or 4 current transformers (CT) depending on the number of circuit breaker poles; the fourth CT may be external
- a protection unit selected from among SACE PR111/P-A, SACE PR112 /P-A and SACE PR113/P-A, or a protection and communication unit selected from among SACE PR112 /PD-A and SACE PR113/PD-A with Modbus® protocol
- an opening solenoid which acts directly on the circuit breaker operating mechanism (supplied with the protection unit).

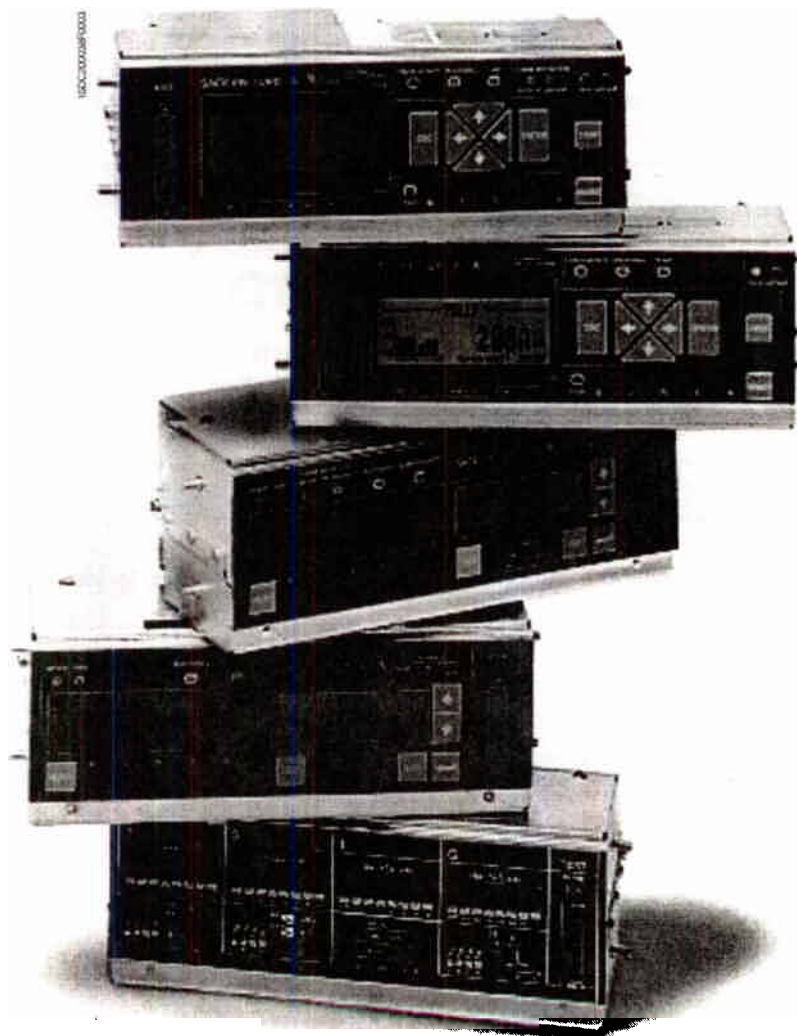



# Microprocessor-based trip units



## UL Versions available

General characteristics of the microprocessor-based trip units:

- operation without the need for an external power supply
- microprocessor technology (8-bit for SACE PR111-A and 16-bit for SACE PR112-A and PR113-A)
- high precision
- sensitivity to the true r.m.s. value of the current
- interchangeability among all types of trip units
- setting for neutral normally at 50% of the phase setting, with possibility of setting it to 100% (on request only for circuit -breakers E1, E2 and E3).

For the PR113-A trip unit, it is also possible to select neutral protection at 150% and 200% of the continuous current rating of the phases, if compatible with the setting of the current transformers. The main performance features of the trip units are listed in the tables below.

1

<b>SACE PR111-A</b>									
	<table border="0"> <tr> <td></td> <td>PR111/P-A</td> <td>PR111/P-A</td> <td>PR111/P-A</td> </tr> <tr> <td>Protection</td> <td><b>L S I G</b></td> <td><b>L S I</b></td> <td><b>L I</b></td> </tr> </table>		PR111/P-A	PR111/P-A	PR111/P-A	Protection	<b>L S I G</b>	<b>L S I</b>	<b>L I</b>
	PR111/P-A	PR111/P-A	PR111/P-A						
Protection	<b>L S I G</b>	<b>L S I</b>	<b>L I</b>						
<b>SACE PR112-A</b>									
	<table border="0"> <tr> <td></td> <td>PR112/P-A</td> <td>PR112/P-A</td> </tr> <tr> <td>Protection</td> <td><b>L S I G</b></td> <td><b>L S I</b></td> </tr> </table>		PR112/P-A	PR112/P-A	Protection	<b>L S I G</b>	<b>L S I</b>		
		PR112/P-A	PR112/P-A						
Protection	<b>L S I G</b>	<b>L S I</b>							
Protection and communication	<table border="0"> <tr> <td></td> <td>PR112/PD-A Modbus</td> <td>PR112/PD-A Modbus</td> </tr> <tr> <td></td> <td><b>L S I G</b></td> <td><b>L S I</b></td> </tr> </table>		PR112/PD-A Modbus	PR112/PD-A Modbus		<b>L S I G</b>	<b>L S I</b>		
	PR112/PD-A Modbus	PR112/PD-A Modbus							
	<b>L S I G</b>	<b>L S I</b>							
<b>SACE PR113-A</b>									
	<table border="0"> <tr> <td></td> <td>PR113/P-A</td> </tr> <tr> <td>Protection</td> <td><b>L S I G</b> <b>D U GT UV QV RV RP N</b></td> </tr> </table>		PR113/P-A	Protection	<b>L S I G</b> <b>D U GT UV QV RV RP N</b>				
		PR113/P-A							
Protection	<b>L S I G</b> <b>D U GT UV QV RV RP N</b>								
Protection and communication	<table border="0"> <tr> <td></td> <td>PR113/PD-A Modbus</td> </tr> <tr> <td></td> <td><b>L S I G</b> <b>D U GT UV QV RV RP N</b></td> </tr> </table>		PR113/PD-A Modbus		<b>L S I G</b> <b>D U GT UV QV RV RP N</b>				
	PR113/PD-A Modbus								
	<b>L S I G</b> <b>D U GT UV QV RV RP N</b>								



# Microprocessor-based trip units

UL Versions available

1

## Features

Protection	PR111-A	PR112-A	PR113-A
<b>L</b> Protection against overload with inverse long time-delay trip	■	■	■
<b>S</b> Selective protection against short circuit with inverse or definite short time-delay trip	■	■	■
<b>I</b> Protection against instantaneous short circuit with adjustable trip current threshold	■	■	■
<b>G</b> Protection against ground faults	residual (internal sensor)	■	■
	source ground return (external sensor)	■	■
<b>D</b> Protection against Directional short circuit with adjustable time delay			■
<b>U</b> Protection against phase unbalance			■
<b>OT</b> Protection against over-temperature		■	■
<b>UV</b> <b>OV</b> Undervoltage protection/Overvoltage protection			■
<b>RV</b> Residual voltage protection			■
<b>PR</b> Protection against active power reversal			■
<b>TM</b> Thermal memory for functions L and S		■	■
<b>Measurements</b>			
Currents (phases, neutral, ground fault)		■	■
Voltage (phase-phase, phase-neutral, residual)			■
Power (active, reactive, apparent)			■
Power factor			■
Frequency and peak factor			■
Energy (active, reactive, apparent, meter)			■
Harmonic calculation (wave form display and harmonics module)			■
<b>Maintenance events and data</b>			
Event storage in chronological order		■	■
Counting number of operations and contact wear		■	■
<b>Communication with centralized supervision and control system</b>			
Remote setting of the protection function parameters, unit configuration, communication		■	■
Transmission of measurements, states and alarms from circuit breaker to system		■	■
Transmission of events and maintenance data from circuit breaker to system		■	■
<b>Watchdog</b>			
Alarm and release due to release over-temperature		■	■
Alarm for microprocessor fault		■	■
<b>Interface with the user</b>			
Establishing parameters by means of dip switches	■		
Establishing parameters by means of keys and LCD display		■	■
Alarm signals for functions L, S, I and G		■	■
Alarm signal of one of the following protections: undervoltage, overvoltage, residual voltage, active power reversal			■
Signal for phase unbalance and over-temperature		■	■
Complete management of the pre-alarms and alarms for all the protection and fail-safe functions		■	■
Password for enabling use with "READ" consultation mode or "EDIT" consultation and setting mode		■	■
<b>Load control</b>			
Load connection and disconnection according to the current passing through the circuit breaker		■	■
<b>Zone discrimination</b>			
Can be activated for protection functions S or G		■	
Can be activated for protection functions S, G or D			■
<b>Number of programmable contacts</b>			
			2



## Microprocessor-based trip units

### Setting the current transformers

Current transformer settings continuous current rating of the CTs In [A]

Type of circuit breaker	Rated continuous current $I_n$	R250	R400	R800	R1000	R1200	R1600	R2000	R2500	R3200	R3600	R4000	R5000
E1B-A	800	■	■	■									
	1200	■	■	■	■	■							
E2B-A	1600	■	■	■	■	■	■						
	1200	■	■	■	■	■							
E2N-A	1600	■	■	■	■	■	■						
	2000	■	■	■	■	■	■	■					
E3N-A	2000	■	■	■	■	■	■	■	■				
	2500	■	■	■	■	■	■	■	■	■			
E3S-A	1200	■	■	■	■	■							
	1600	■	■	■	■	■	■						
	2000	■	■	■	■	■	■	■					
	2500	■	■	■	■	■	■	■	■				
E3H-A	1200	■	■	■	■	■							
	1600	■	■	■	■	■	■						
	2000	■	■	■	■	■	■	■					
	2500	■	■	■	■	■	■	■	■				
E3V-A	1200	■	■	■	■	■							
	1600	■	■	■	■	■	■						
	2000	■	■	■	■	■	■	■					
	2500	■	■	■	■	■	■	■	■				
E4S-A	3200						■	■	■	■			
	3600						■	■	■	■	■		
E4H-A	3200						■	■	■	■			
	3600						■	■	■	■	■		
E4V-A	3200						■	■	■	■			
	3600						■	■	■	■	■		
E6H-A	4000									■		■	
	5000									■		■	■
E6V-A	4000									■		■	
	5000									■		■	■

1



## Compliance with Standards

### Standards, approvals, certifications and company Quality System

The SACE Emax circuit breakers conform with the ANSI C37.13, C37.16, C37.17 and C37.50 Standards and are UL 1066 certified.

The UL 1066 certification allows Emax to be used in UL 1558 switchgears, gear UL891 Low Voltage switchboards and CSA C22.2 no. 31 Switchgear Assemblies.

All the Emax circuit breakers and their accessories are also available in the versions complying with the International IEC 60947, EN 60947 (harmonized in 17 CENELEC countries), CEI EN 60947 and IEC 61000 Standards and conform with the following EC directives:

- "Low Voltage Directive" (LVD) nr. 73/23 EEC
- "Electromagnetic Compatibility Directive" (EMC) nr. 89/336 EEC.

The main versions of the equipment are approved by the following Shipping Registries:

- RINA (Italian Shipping Register)
- ABS (American Bureau of Shipping)
- Det Norske Veritas
- Bureau Veritas
- Germanischer Lloyd
- Lloyd's Register of Shipping
- Polskj Reiestr Statkow
- Gost
- NK

Certification of conformity with the aforementioned product Standards is carried out in compliance with the EN 45011 European Standard by the Italian certification body ACAE (Associazione per la Certificazione delle Apparecchiature Elettriche - Association for Certification of Electrical Equipment), recognized by the European organization LOVAG (Low Voltage Agreement Group).

Note: Contact ABB SACE for a list of approved types of circuit breakers, approved performance data and the corresponding validity





## Compliance with Standards

A design dedicated to Quality and respect for the environment

Quality has always been the leading commitment of ABB SACE. This commitment involves every function of the company, and has allowed us to achieve prestigious recognition internationally.

The company's Quality System is certified by RINA, one of the most prestigious international certification bodies, and complies with ISO 9001 Standards; the ABB SACE test facility is accredited by SINAL; the plants in Frosinone, Patrica, Vittuone and Garbagnate Monastero are also certified in compliance with OHSAS 18001 Standards for health and safety in the workplace. ABB SACE, Italy's first industrial company in the electro-mechanical sector to achieve this, has been able to reduce its raw material consumption and machining scrap by 20% thanks to an ecology-orientated revision of its manufacturing process. All of the company's Divisions are involved in streamlining raw material and energy consumption, preventing pollution, limiting noise pollution and reducing scrap resulting from manufacturing processes, as well as to carrying out periodic environmental audits of its leading suppliers.

ABB SACE is committed to environmental protection, as is also evidenced by the Life Cycle Assessments (LCA) of products carried out at the Research Center: this means assessment and improvement of the environmental performance of products throughout their life cycle are included right from the initial design engineering stage. The materials, processes and packaging used are chosen with a view to optimizing the actual environmental impact of each product, including its energy efficiency and recyclability.

ENVIRONMENTAL MANAGEMENT  
SYSTEM CERTIFIED



130020046F030

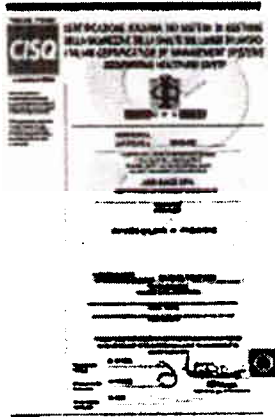

130020046F030

1





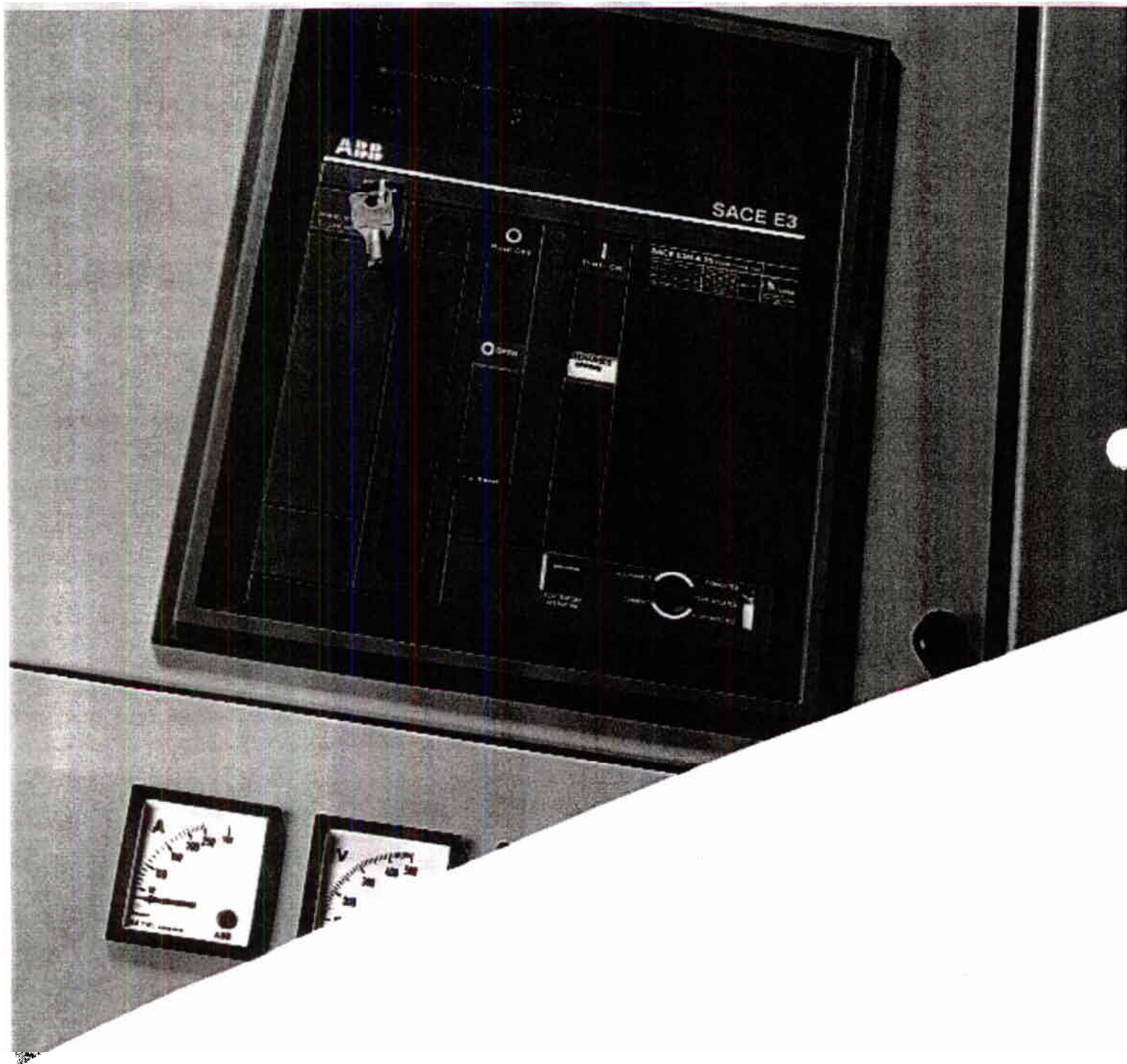



## Contents

### Installation in switchboards

Modular design .....	2/2
Selecting the type of circuit breaker .....	2/3



---

## Installation in switchboards

### Modular design

---

To allow easier installation and integration in Low Voltage switchboards, the SACE Emax series of circuit breakers have been built to modular design criteria, thanks to the same depth and height for all the sizes, as well as a significant reduction in their overall installation dimensions.

The front shield of the circuit breaker is, moreover, identical for the entire series. This simplifies the construction of the switchboard doors since only one type of drilling is required and makes the front of the switchboard the same for all sizes.

2

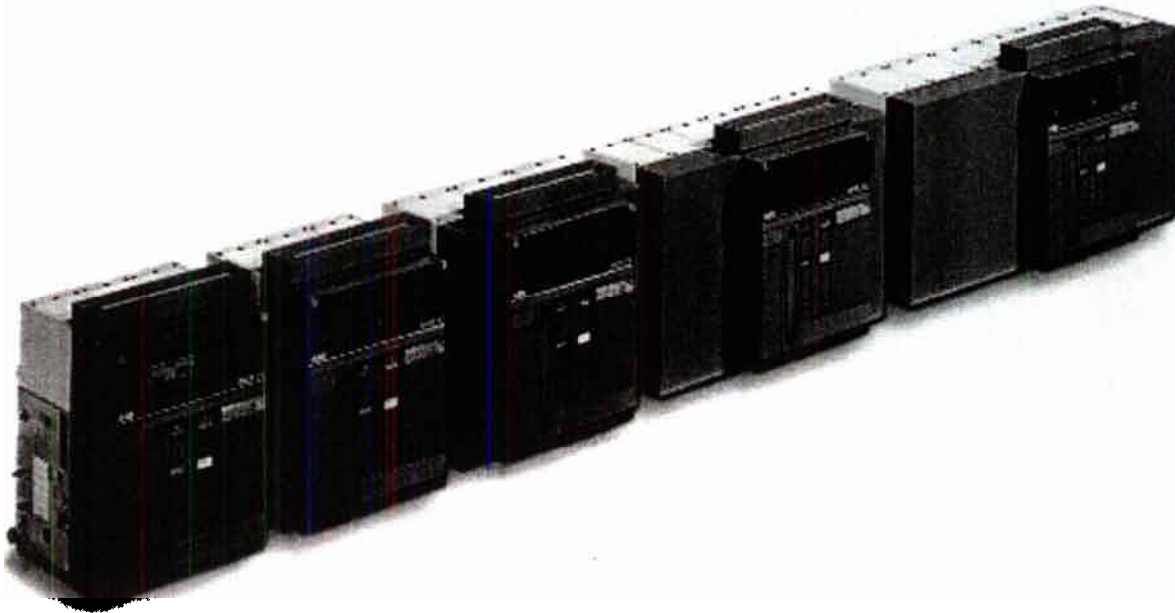

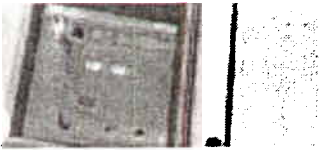

---

## Installation in switchboards

### Selecting the type of circuit breaker

---

---

#### Number of poles

The choice of the number of poles for circuit breakers that simultaneously provide switching, protection and isolation functions in three-phase installations depends on the type of electrical system and the type of user or, more generally, whether it features a distributed or non-distributed neutral.

2

---

#### Fixed or draw out version

The fixed version of the circuit breaker is more compact in size than the draw out version. It is recommended for installations that can tolerate service interruptions in the event of faults or routine maintenance.

The draw out version of the circuit breaker is recommended for:

- applications that can only tolerate brief interruptions due to faults or routine maintenance:
- dual lines, one of which is a standby for the other, with a single circuit breaker for each pair.

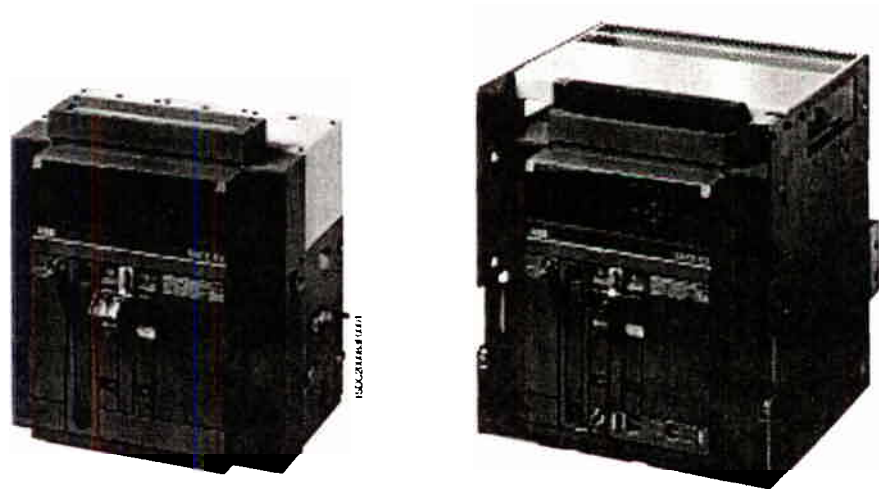



## Installation in switchboards

### Selecting the type of circuit breaker

2

#### Connecting the main circuit breaker circuits

When designing switchboards, one must always bear in mind the problem of making the most rational connections between the circuit breaker and main busbar system and the busbars to the users. The SACE Emax series offers switchboard experts a range of options to satisfy different circuit breaker connection requirements.

The figures at the side provide some indications for terminal selection.

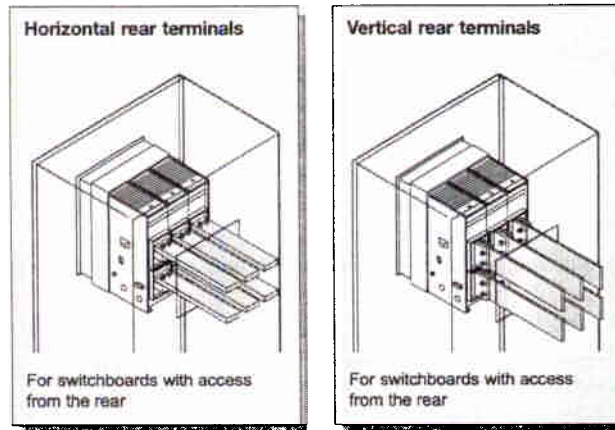

#### Protection degrees

A number of solutions have been adopted on SACE Emax circuit breakers to achieve IP22 protection degree for fixed or draw out circuit breakers, not including their terminals, and IP30 for their front parts using a flange. Automatic shutters have been realized for the cradles of draw out circuit breakers which can be locked using padlock devices to allow maintenance on the load side or supply side of the cradle.

A transparent protective cover is also available on request, to completely segregate the front part of the circuit breaker with IP54 protection degree (Nema 3/3S/13). In any case, the front and trip unit, as well as their indicators, still remain completely visible.

- IP22** Fixed or draw out circuit breaker, not including terminals.
- IP30** Front parts of circuit breakers (using flange).
- IP54** Fixed or draw out version circuit breaker, fitted with transparent protective cover to be fixed over the front of the switchboard (on request).



### Power losses

The following table provides the dissipated power for fixed and draw out circuit breakers.

Power loss			
Circuit breaker	Continuous current [A]	Fixed 3/4 poles [W]	Draw out 3/4 poles [W]
E1B-A	800	65	95
	1200	146	214
E2B-A	1800	115	215
E2N-A	1200	65	121
	1800	115	215
E3N-A	2000	130	225
	2500	205	350
E3S-A	1200	48	84
E3H-A	1800	85	150
E3V-A	2000	130	225
	2500	205	350
E4S-A	3200	235	425
E4H-A / E4V-A	3600	297	538
E6H-A	4000	265	445
E6V-A	5000	415	700

**Note**

The values indicated refer to balanced loads, a current flow of  $I_n$ , and automatic circuit breakers.

### Derating in altitude

SACE Emax power circuit breakers do not undergo any changes in their rated performance up to an altitude of 2000 meters.

As the altitude increases the atmospheric properties alter in terms of composition, dielectric capacity, cooling power and pressure.

The performance of the circuit breakers therefore undergoes derating which can be measured through the variation in significant parameters, such as the maximum rated operating voltage and the rated uninterrupted current.

The table below shows the aforementioned values in relation to altitude.

Altitude	[m]	<6600	9900	13200	16500
	[m]	2000	3000	4000	5000
Rated service voltage	$U_e$ [V]	600	600	500	440
Continuous current rating	$I_n$ [A]	$I_n$	0.98x $I_n$	0.93x $I_n$	0.90x $I_n$



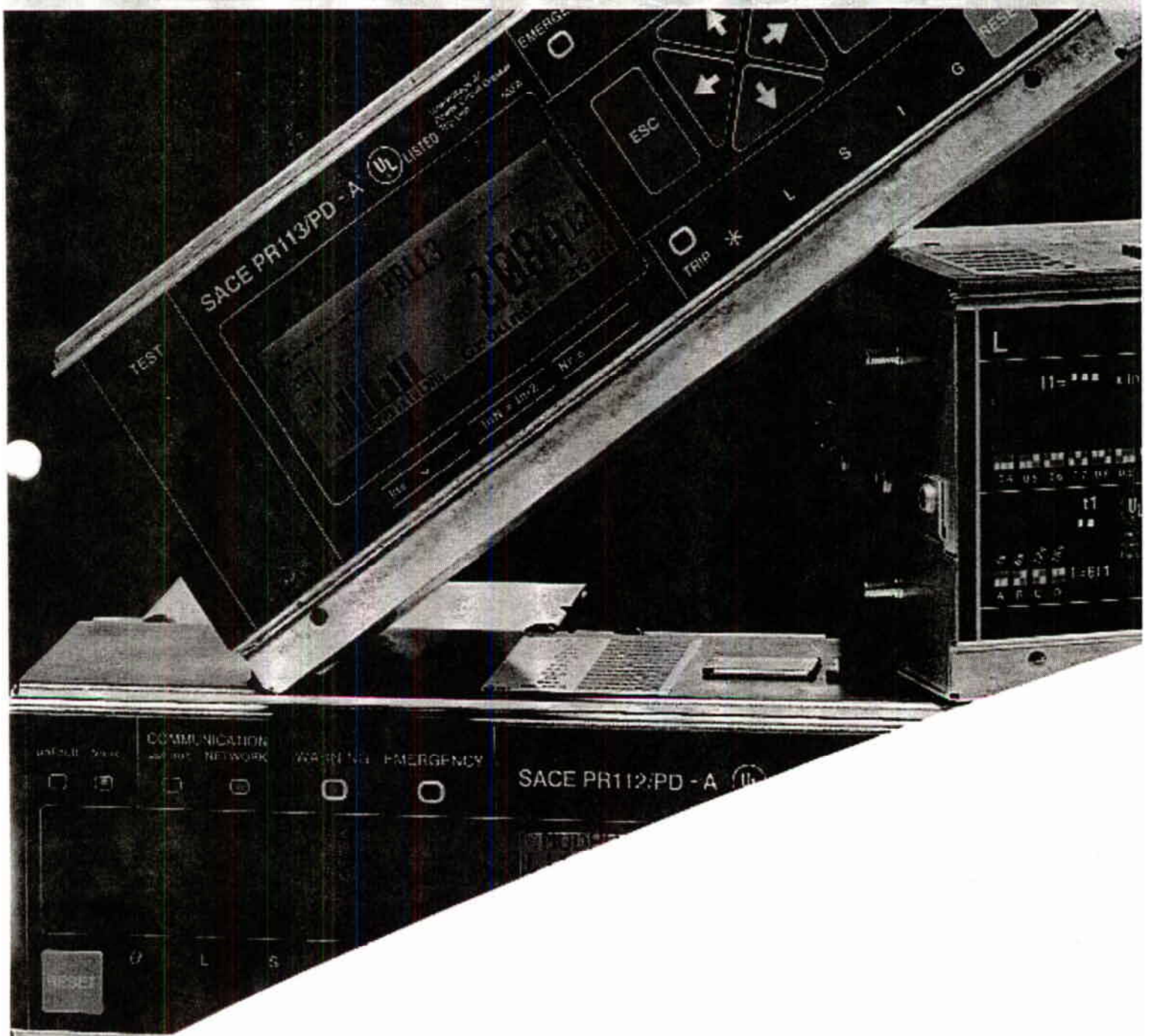
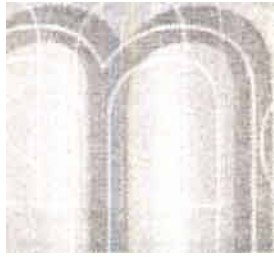



# Overcurrent trip units and related accessories

## Contents

### Microprocessor-based trip units and trip curves

PR111/P-A .....	3/2
PR112/P-A .....	3/8
PR113/P-A .....	3/18

### Trip and dialogue units for Modbus® networks

PR112/PD-A and PR113/PD-A .....	3/35
---------------------------------	------

### Accessories for trip units

SACE PR120/B power supply unit .....	3/37
SACE TT1 test unit .....	3/37
SACE PR010/T configuration test unit .....	3/37
SACE PR020/K signaling unit .....	3/39

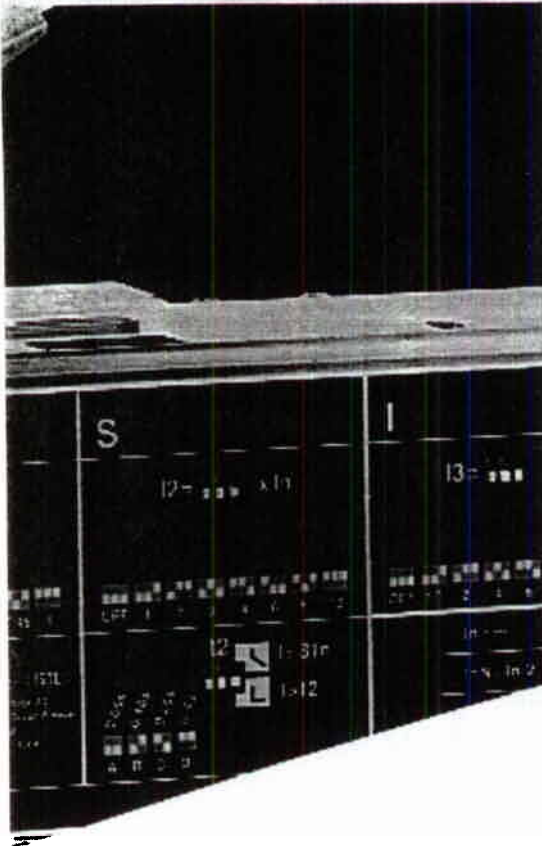



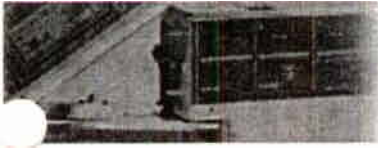

# Microprocessor-based trip units and trip curves

## PR111/P-A

### Characteristics

This is the basic trip unit for the Emax series. The complete range of protection functions and the variety of thresholds and trip times offered make it suitable for protecting any type of alternating current installation. The trip unit does not have any additional functions apart from its protection functions, except some alarm signals.

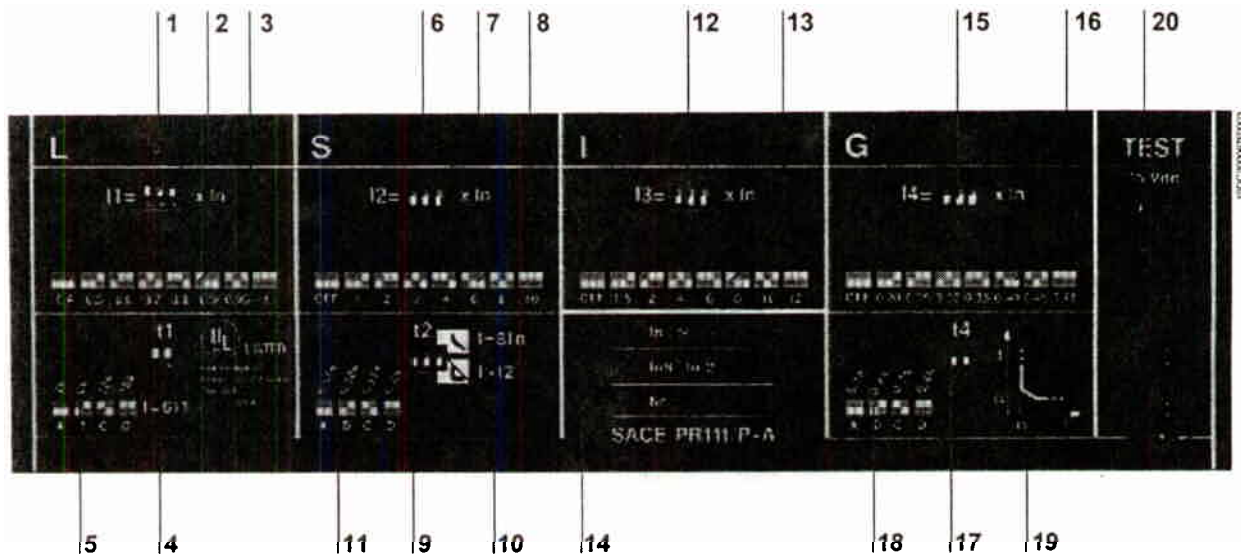

3

#### Legend

- 1 LED signaling alarm for protection function L
- 2 DIP switches for setting current threshold I1
- 3 Indication of correspondence between the DIP switch positions and the I1 current threshold values
- 4 DIP switches for setting trip time t1 (type of curve)
- 5 Indication of correspondence between the DIP switch positions and the times set
- 6 LED signaling alarm for protection function S
- 7 DIP switches for setting current threshold I2
- 8 Indication of correspondence between the DIP switch positions and the current threshold values I2
- 9 DIP switches for setting trip time t2 (type of curve)
- 10 Dip switches for selecting between inverse time or definite time characteristic
- 11 Indication of correspondence between the DIP switch positions and the times set
- 12 DIP switches for setting current threshold I3
- 13 Indication of correspondence between the DIP switch positions and the current threshold values I3
- 14 Rating plate showing the continuous current rating of the neutral CT and the trip unit serial number
- 15 DIP switches for setting current threshold I4
- 16 Indication of correspondence between the DIP switch positions and the current threshold values I4
- 17 DIP switches for setting trip time t4 (type of curve)
- 18 Indication of correspondence between the DIP switch positions and the times set
- 19 Symbol diagram showing trip of function G
- 20 Connection module with external units for testing the trip unit and socket for connection to the trip test device (SACE TT1 unit and SACE PR10/T unit)

## Operation and protection functions

### Power supply

The unit requires no external power supply. It is self-supplied by means of the current transformers installed on the circuit breaker. For it to operate, it is sufficient for at least one phase to be loaded at 18% of the continuous current rating of the current transformers ( $I_n$ ).

### Protection functions

The PR111/P-A trip unit offers the following protection functions:

- overload (L)
- selective short circuit (S)
- instantaneous short circuit (I)
- ground fault (G).

### Overload (L)

The inverse long time-delay trip overload protection L is type  $I^2t=k$ ; eight current thresholds and 4 curves are available, labeled A, B, C, D.

Each curve is identified by the trip time in relation to the current  $I = 6 \times I_1$  ( $I_1$ =set threshold).

### Selective short circuit (S)

The selective short circuit protection S can be set with two different types of curves with a trip time that is independent of the current ( $t=k$ ) or with a constant specific let-through energy ( $t = k/I^2$ ).

Seven current thresholds and 4 curves are available, labeled A, B, C, D. Each curve is identified as follows:

- for curves ( $t = k$ ) by the trip time for  $I > I_2$
- for curves  $t = k/I^2$  by the trip time for  $I = 8 \times I_n$  ( $I_n$  = continuous current rating of the current transformer).

The function can be excluded by setting the DIP switch combination to "OFF".

### Adjustable instantaneous short circuit (I)

The protection I offers 7 trip thresholds and can be excluded (dip switches in "OFF" position).

### Ground fault (G)

The inverse short time-delay trip ground fault protection G (which can be excluded) offers 7 current thresholds and 4 curves labeled A, B, C, D. Each curve is identified by the time  $t_4$  in relation to current  $I_4$  as shown in the diagram on the front of the trip unit.

Note: the function G is disabled for fault current values  $I > 4 \times I_n$  ( $I_n$ =continuous current rating of the CT).

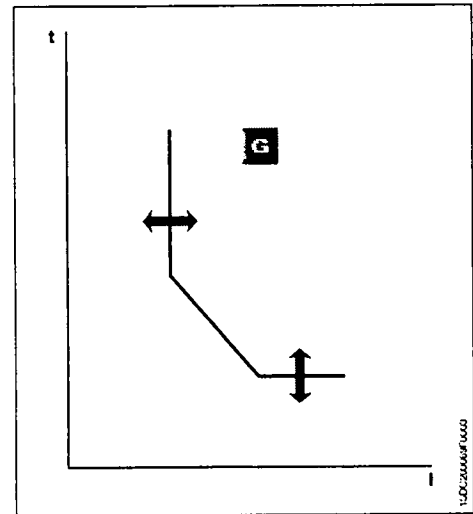
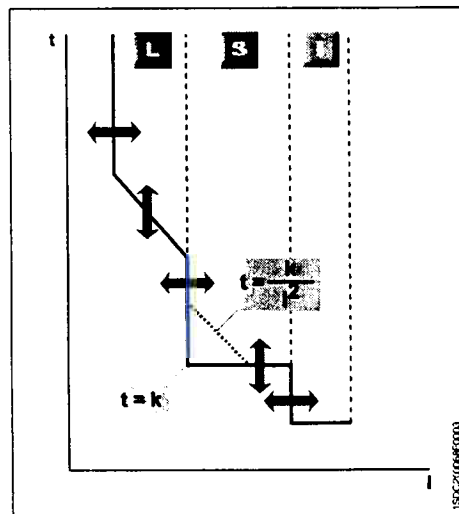



# Microprocessor-based trip units and trip curves

## PR111/P-A

### User interface

The user communicates with the trip unit in the trip parameter preparation stage by means of the dip switches.

Two LEDs are also available for alarm signaling (timing start) for the L and S functions respectively.

### Setting the neutral

Protection of the neutral is available at 50% (in the standard version) or at 100% (version which can be supplied on request for E1-E2-E3), of the phase currents.

### Test Function

The Test function is carried out by means of the pocket-sized SACE TT1 Trip Test unit, fitted with a two-pole polarized connector housed on the bottom of the box, which allows the device to be connected to the test input sockets on the front of PR111/P-A trip unit.

A complete test of the PR111/P-A microprocessor-based trip unit can be carried out using the special SACE PR010/T apparatus by applying it to the TEST connector.

All the trip unit functions can be checked by means of this unit.

### Versions available

The following versions are available:



PR111/P-A LI

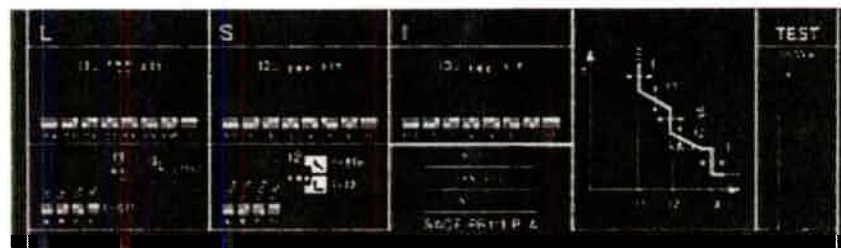

PR111/P-A LSI

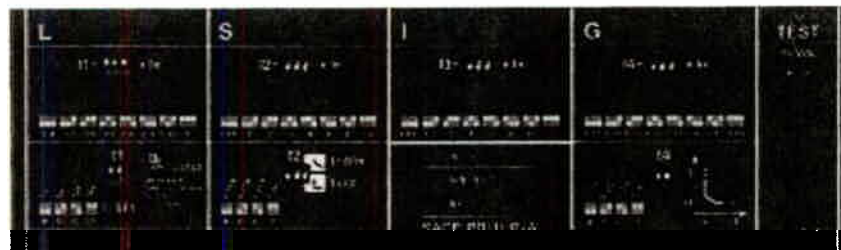

PR111/P-A LSIG

3

### Protection functions and setting values of the PR111/P-A trip unit

Function	Trip threshold	Trip time	Can be excluded	Relation t=f(I)
<b>L</b> Protection against overload	I1= 0.4 - 0.5 - 0.6 - 0.7 - 0.8 - 0.9 - 0.95 - 1 x In	At current I = 6 x I1 t1 = 3 s (curve A), 6 s (curve B), 12 s (curve C), 18 s (curve D)	—	t=k/I <sup>2</sup>
Tolerance <sup>(1)</sup>	± 10% (according to ANSI 37.17 Standard)	± 10% I <sub>g</sub> ≤ 3 x In ± 20% I <sub>g</sub> > 3 x In		
<b>S</b> Selection protection against short-circuit	I2= 1 - 2 - 3 - 4 - 6 - 8 - 10 x In	At current I = 8 x In t2 = 0.05 s (curve A), 0.10 s (curve B) 0.25 s (curve C), 0.4 s (curve D)	■	t=k/I <sup>2</sup> (trip curve I <sup>2</sup> t ON)
Tolerance <sup>(1)</sup>	± 10 %	± 20%		
	I2= 1 - 2 - 3 - 4 - 6 - 8 - 10 x In	At current I > I2 t2 = 0.05 s (curve A), 0.10 s (curve B) 0.25 s (curve C), 0.4 s (curve D)	■	t=k (trip curve I <sup>2</sup> t OFF)
Tolerance <sup>(1)</sup>	± 10 %	The best of the given: ± 20% or ± 50 ms		
<b>I</b> Instantaneous protection against short circuit	I3= 1.5 - 2 - 4 - 6 - 8 - 10 - 12 x In	Instantaneous	■	t=k
Tolerance <sup>(1)</sup>	± 20 %	≤ 35 ms I <sub>g</sub> ≤ 3 x In ≤ 30 ms I <sub>g</sub> > 3 x In		
<b>G</b> Protection against ground faults	I4= 0.20 - 0.25 - 0.30 - 0.35 - 0.40 - 0.45 - 0.48 x In	At current I = 4 x I4 t4 = 0.1 s (curve A), 0.2 s (curve B) 0.3 s (curve C), 0.4 s (curve D)	■	t=k/I <sup>2</sup>
Tolerance <sup>(1)</sup>	± 10 %	± 20%		

(1) These tolerances are valid with the following hypotheses:  
 - relay self-supplied when running (without start-up)  
 - two-phase or three phase power supply

In all cases not covered by the above hypotheses, the following tolerance values are valid:

	Trip threshold	Trip time
L	± 10% (according to ANSI 37.17 Standard)	± 20%
S	± 10%	± 20%
I	± 20%	≤ 60ms
G	± 15%	± 20%

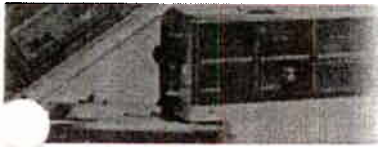

# Microprocessor-based trip units and trip curves

## PR111/P-A

### Functions L-I

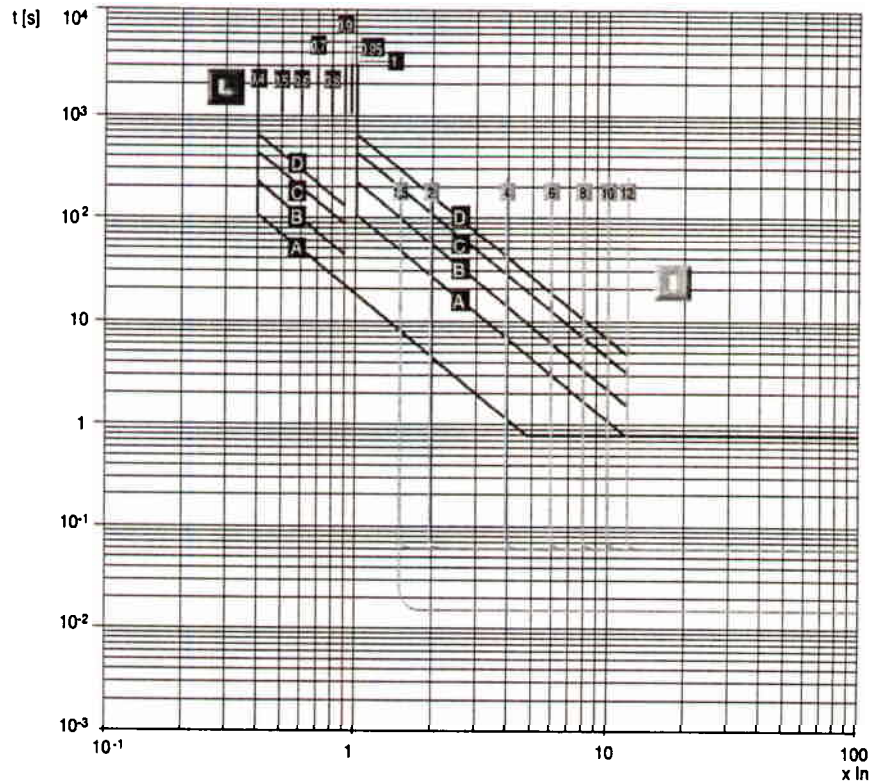

3

### Functions L-S-I

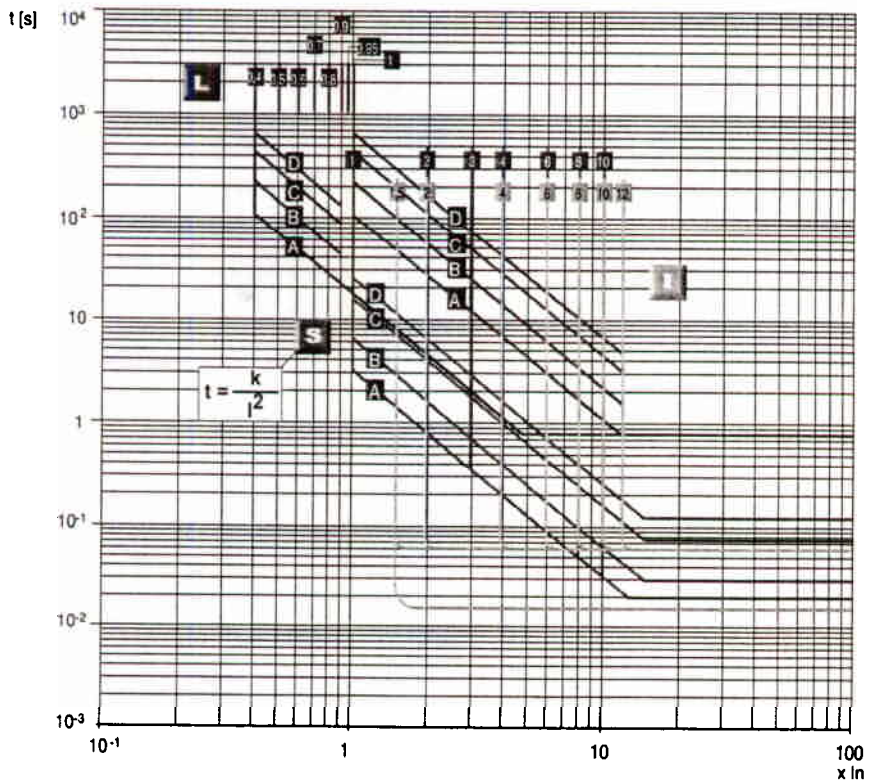

Tolerances on thresholds and trip times ..... page 3/5

Functions L-S-I

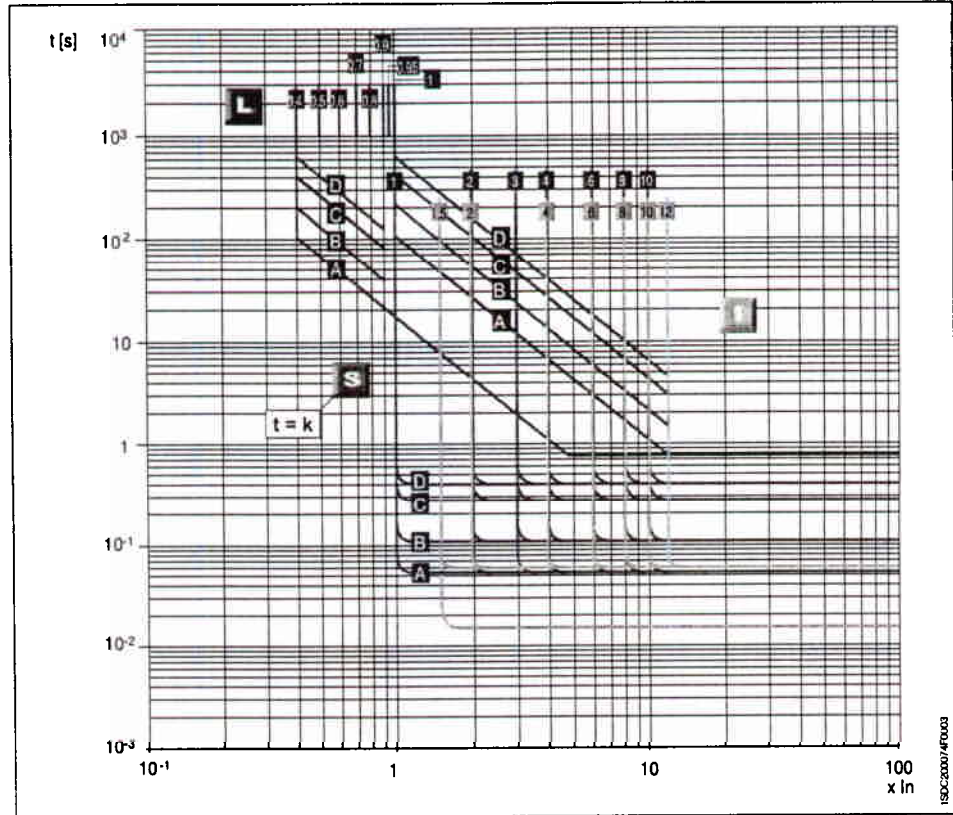

Function G

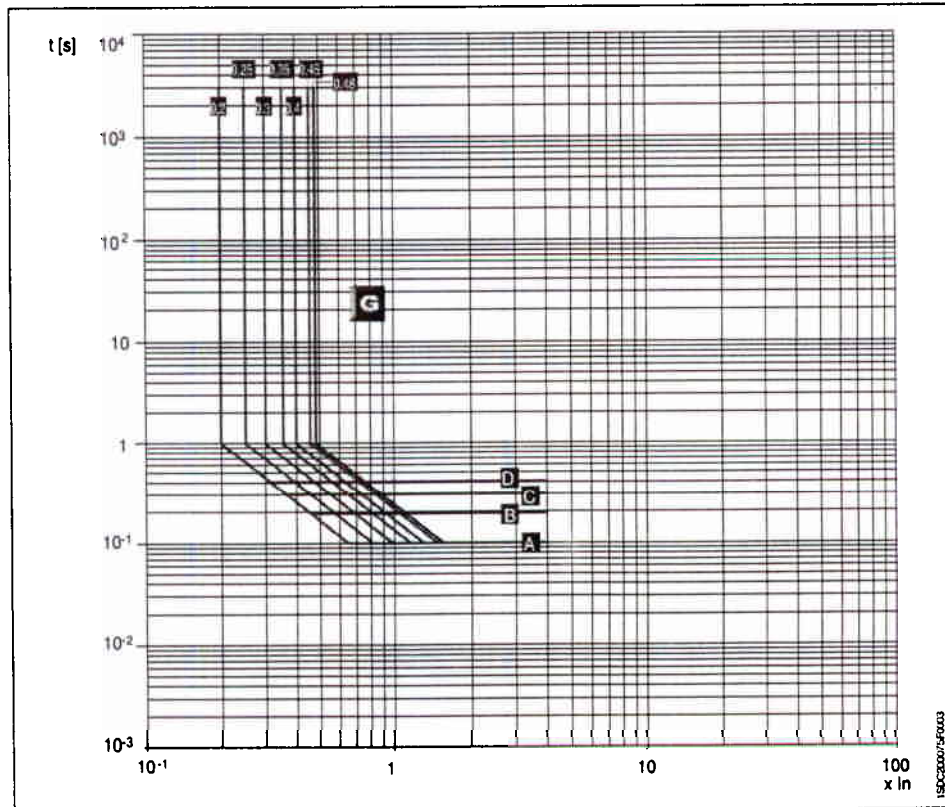

Tolerances on thresholds and trip times ..... page 3/5

# Microprocessor-based trip units and trip curves

## PR112/P-A

### Characteristics

The PR112/P-A trip unit is a sophisticated protection system using microprocessor technology. It comprises the PR112/P-A trip unit and, on request, the PR112/PD-A protection and dialogue unit with the Modbus® protocol.

The wide range of settings makes this trip unit ideal for general use in any type of installation.

Consulting information and programming is extremely easy using a keyboard and alphanumeric liquid crystal display.

An ammeter function and many additional functions are provided over and above the protection functions. These additional functions can be further increased with the addition of the dialogue and signaling unit.

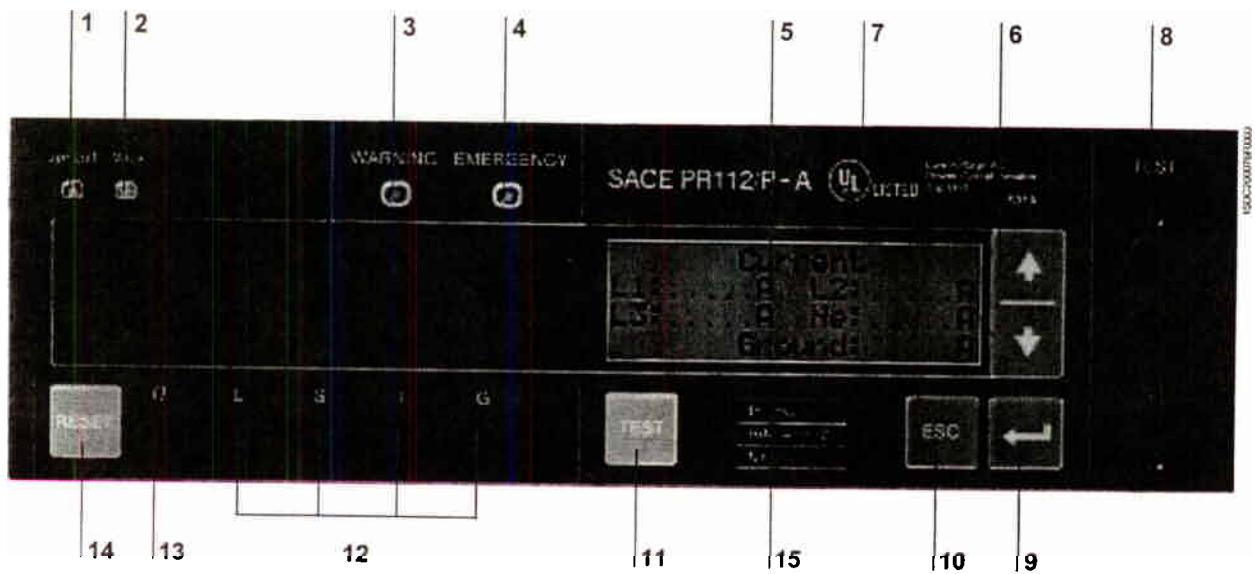

#### Legend

- |  |  |   |
|--|--|---|
| <p>1 LED signaling microprocessor fault</p> <p>2 LED signaling auxiliary power supply present</p> <p>3 LED signaling pre-alarm</p> <p>4 LED signaling alarm</p> <p>5 Alphanumeric display illuminated from the rear</p> <p>6 Cursor UP button</p> <p>7 Cursor DOWN button</p> <p>8 TEST connector for connection to external SACE PR010/T and SACE PR120/B accessory units</p> | <p>9 ENTER button to confirm data or change pages</p> <p>10 Pushbutton to exit submenus or cancel operations (ESC)</p> <p>11 TEST pushbutton</p> <p>12 Magnetic signaling devices for protection functions L, S, I, G tripped</p> <p>13 Magnetic signaling device for excessive temperature inside the trip unit box</p> | <p>14 RESET key for the magnetic signaling devices and contact for signaling protection devices tripped</p> <p>15 Rating plate indicating the continuous current rating of the CTs and neutral plus the trip unit serial number</p> |
|--|--|---|

## Operation, protection functions and self-test

### Power supply

The PR112/P-A trip unit does not normally require any external power supplies, being self-supplied from the current transformers (CT): to activate the protection and ammeter functions, it is sufficient for at least one phase to have a current load equivalent to 35% of the continuous current rating of the CTs (20% in cases where two phases are powered, 15% for three phases). In order for the display to come on, at least one phase must have a current load equivalent to 50% of the continuous current rating of the CTs, 30% if two phases are powered and 20% for three phases.

The unit ensures fully self-supplied operation; when an auxiliary power supply is present, it is also possible to use the unit with the circuit breaker open or closed.

It is also possible to use an auxiliary power supply provided by the PR120/B portable battery unit (always supplied) which allows the protection functions to be set when the trip unit is not self-supplied. A wide range of setting options is available for the thresholds and trip times of all the functions.

Functions S and G can operate with a time delay that is independent of the current ( $t = k$ ) or with an inverse time

delay (constant specific let-through energy:  $I^2t = k$ ), as required.

Protection against ground faults can also be obtained by connecting the PR112/P-A trip unit to an external toroid located on the conductor that connects the transformer star center to ground (homopolar toroid).

All the thresholds and trip curve delays of the protection functions are stored in special memories which retain the information even if no power is supplied.

	PR112/P-A	PR112/PD-A
Auxiliary power supply (galvanically insulated)	24 V DC $\pm$ 20%	24 V DC $\pm$ 20%
Maximum ripple	5%	5%
Inrush current @ 24V	-3 A for 30 ms	-5 A for 30 ms
Starting current @ 24V	-1.0 A for 150 ms	-1.0 A for 150 ms
Continuous current rating @ 24V	-125 mA	-250 mA
Rated power @ 24V	-3 W	-6 W

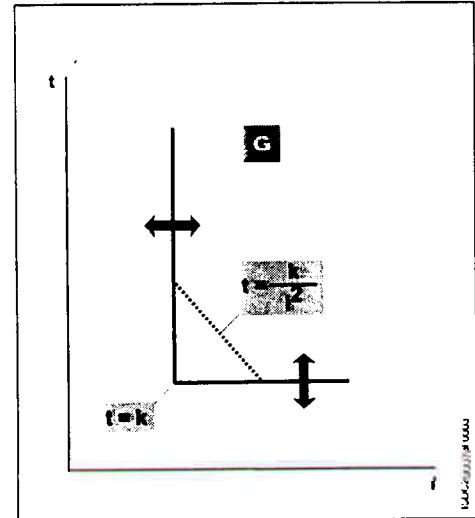
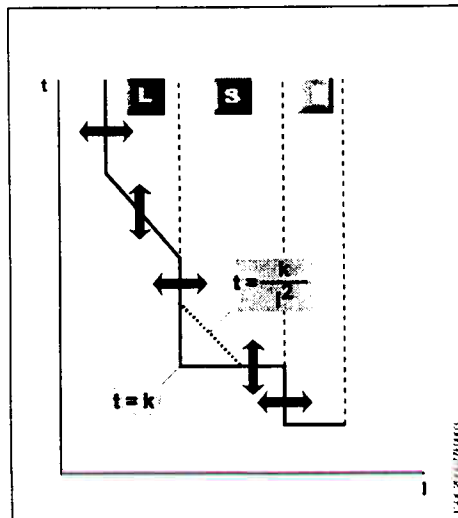



---

# Microprocessor-based trip units and trip curves

## PR112/P-A

---

### Protection functions

The PR112/P-A trip units offers the following protection functions:

- overload (L)
- selective short circuit (S)
- instantaneous short circuit (I)
- ground fault (G) (Residual or Source ground return: the latter via a toroid installed on the ground connection of the main power supply)
- fail-safe against over-temperature (OT)
- thermal memory for L and S functions
- zone discrimination for functions S or G

### Setting the neutral

The neutral protection is 50% of the value set for phase protection in the standard version. The neutral protection can be set to 100% for E1, E2, E3.

### Protection against over-temperature

The range of SACE PR112/P-A trip units allows the presence of abnormal temperatures, which could cause temporary or continuous malfunctions of the microprocessor, to be signaled to the user.

The user has the following signals or commands available:

- lighting up of the "Warning" LED when the temperature is higher than 70°C (temperature at which the microprocessor is still able to operate correctly)
- lighting up of the "Emergency" LED when the temperature is higher than 85°C (temperature above which the microprocessor can no longer guarantee correct operation) and, when decided during the unit configuration stage, simultaneous opening of the circuit breaker with changeover of the corresponding magnetic signal.

### Zone discrimination for S or G

The zone discrimination function S or G can be activated or deactivated using the keyboard. Protection is provided by connecting together all of the zone discrimination outputs of the trip units belonging to the same zone, and bringing this signal to the zone discrimination input of the trip unit immediately to the supply side. This type of discrimination allows the trip times of the circuit breaker closer to the fault to be reduced in relation to those provided by time discrimination.

Zone is intended as the part of the installation between two circuit breakers in series. Using a simple connection wire, each circuit breaker which senses a fault communicates this to the one on the supply side: the fault zone is the one immediately to the load side of the circuit breaker which detects the fault but which does not receive any communication from the ones on the load side; this circuit breaker will open without waiting for the set delay. Zone discrimination can be realized with all SACE Emax circuit breakers in the B-A, N-A, S-A, H-A and V-A versions fitted with a SACE PR112/P-A and PR113/P-A trip unit.

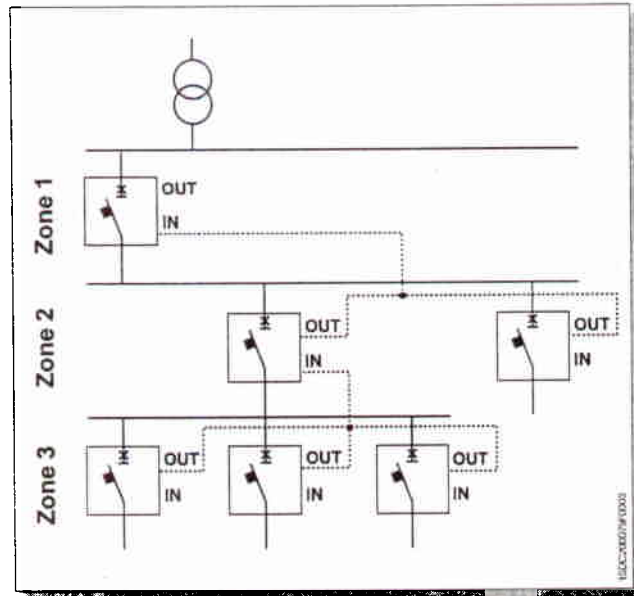



---

# Microprocessor-based trip units and trip curves

## PR112/P-A

---

### Phase unbalance U

Function U against phase unbalance simply emits a warning signal if an unbalance is detected between two or more phases. This function can be disabled.

### Microprocessor watchdog

The PR112/P-A range of trip units contains an electronic circuit which checks operation of the trip unit microprocessor in real time (an additional electronic circuit is provided for the PR112/PD-A unit for checking the dialogue unit microprocessor).

In case of a temporary or continuous malfunction, the following two signals are activated:

- lighting up of the "µP Fault" LED (if the 112/PD-A unit is present, the "µP Communication Fault" LED also lights)
- when there is auxiliary power supply, closure of the "µP Fault" contact.

### Test Functions

Once enabled from the "control" menu, the "TEST" pushbutton on the front of the trip unit allows correct operation of the chain consisting of the microprocessor, opening solenoid and circuit breaker to be checked.

The control menu also includes the option of testing correct operation of the display, indicator LEDs, magnetic signals and electrical contacts supplied in all versions of the PR112/P-A trip unit.

By means of the front multi-pin connector it is possible to apply a SACE PR010/T Test unit, which allows the functions of the PR111/P-A, PR112/P-A and PR113/P-A ranges of trip units to be tested and checked.

### User interface

The human-machine interface (HMI) of the device is made up of an alphanumeric display, LEDs, pushbuttons and magnetic flags to signal the trip unit trip causes.

A password system has been installed in this new version to manage "Read" or "Edit" modes. The protection parameters (curves and trip thresholds) can be set directly via the device's HMI. The parameters can only be changed when the trip unit is operating in "Edit" mode, but the information available and the parameter settings can be checked at any time in "Read" mode. The language can be selected from among five available options: Italian, English, German, French and Spanish.

### Indicator LEDs

LEDs on the front panel of the trip unit are used to indicate pre-alarms ("WARNING") and alarms ("ALARM"). A message on the display always explicitly indicates the type of event concerned.

Events indicated by the "WARNING" LED:

- unbalance between phases;
- pre-alarm for overload ( $I > 0.81 \times I_1$ );
- first temperature threshold exceeded (70 °C);
- contact wear beyond 80%.

Events indicated by the "EMERGENCY" LED:

- overload ( $I > 1.0 \times I_1$ );
- timing of function L;
- timing of function S;
- timing of function G;
- second temperature threshold exceeded (85 °C);
- contact wear 100%.

Other LEDs indicate, respectively:

- "µP Fault": indicates that the trip unit microprocessor has a temporary (briefly lit) or permanent (steadily lit) fault
- "Vaux": indicates there is an auxiliary power supply.

### Electrical signaling contacts

Three clean contacts provided on all versions of the PR112/P-A trip unit enable electrical signaling of the following:

- contact K51/p1, which can be set to any of the following based on user preference: timing for protections L, S, G; protections L, S, I, G, OT tripped and other events;
- contact K51/Y01, for when any of the protections L, S, I, G is tripped;
- contact K51/µP, for microprocessor with temporary or permanent fault.

**Note:**  
The overload and microcontroller fault alarm contacts are available with an external auxiliary power supply.

# Microprocessor-based trip units and trip curves

## PR112/P-A

### Resetting trip signals

The "RESET" pushbutton allows local resetting of the protection trip signals (trip unit contact tripped and magnetic flags).

In the case of remote control, the resetting signal for the protection trip signals can be transmitted by means of a dialogue unit (PR112/PD-A version) only for trip unit trip caused by over-temperature and by overload (L). Trip signals for the other functions (S, I and G) can only be reset locally. When the signal is not reset, the dialogue unit is prevented from actuating the circuit breaker closing command.

### Load control

The load control function takes place in combination with the PR020/K accessory unit. The function is only active when an auxiliary power supply is present.

Alternatively, using two separate curves (with threshold currents and trip times lower than those available for selection with protection L), the load-control function implements the following logics:

- disconnection of two separate loads,
- connection and disconnection of a load.

These functions make it possible to connect/disconnect individual loads on the load side before the overload protection L is tripped, thereby tripping the supply side circuit breaker.

### Measuring function

The current measuring function (ammeter) is present on all versions of the SACE PR112/P-A trip unit.

The display shows the currents of the three phases, neutral and ground fault.

The latter current value takes on two different meanings depending on whether the external toroidal transformer for the "Source Ground Return" function or the internal transformer (residual type) is connected.

The ammeter can operate either with self-supply or with auxiliary power supply voltage.

Accuracy of the ammeter measurement chain (current transformer plus ammeter) is a maximum of 5% in the 30% - 120% current range of  $I_n$ .

### Versions available

The following versions are available:



PR112/P-A LSI



PR112/P-A L SIG



PR112/PD-A LSI



PR112/PD-A LSIG

3

### Protection functions and setting values of the PR112/P-A trip unit

Function	Trip threshold	Threshold steps	Trip time	Step time	Can be excluded	Relation t=f(I)	Thermal memory	Zone discrimination
<b>L</b> Protection against overload Tolerance <sup>(4)</sup>	I1= 0.4...1 x In ± 10% (according to ANSI 37.17 Standard)	0.01 x In	t1= 3 s...144 s ± 10% I <sub>g</sub> ≤ 4 x In ± 20% I <sub>g</sub> > 4 x In	3 s <sup>(1)</sup>	-	t=k/I <sup>2</sup>	■	-
<b>S</b> Selective protection against short circuit Tolerance <sup>(4)</sup>	I2= 0.6...10 x In ± 7% I <sub>g</sub> ≤ 4 x In ± 10% I <sub>g</sub> > 4 x In	0.1 x In	t2= 0.05 s...0.4 s <sup>(2)</sup> The best of the two given: ± 10% or ± 50 ms I <sub>g</sub> ≤ 4 x In ± 15% or 50 ms I <sub>g</sub> > 4 x In	0.01s	■	t=k	-	■
Tolerance <sup>(4)</sup>	I2= 0.6...10 x In ± 7% I <sub>g</sub> ≤ 4 x In ± 10% I <sub>g</sub> > 4 x In	0.1 x In	t2= 0.05 s...0.4 s ± 15% I <sub>g</sub> ≤ 4 x In ± 20% I <sub>g</sub> > 4 x In	0.01s	■	t=k/I <sup>2</sup>	■	-
<b>I</b> Instantaneous protection against short circuit Tolerance <sup>(4)</sup>	I3= 1.5...15 x In ± 10% I <sub>g</sub> ≤ 4 x In ± 15% I <sub>g</sub> > 4 x In	0.1 x In	Instantaneous ≤ 25 ms	-	■	t=k	-	-
<b>G</b> Protection against ground faults Tolerance <sup>(4)</sup>	I4= 0.2...1 x In <sup>(3)</sup> ± 10%	0.02 x In	t4= 0.1 s...0.4s The best of the two given: ± 10% or ± 50 ms I <sub>g</sub> ≤ 4 x In	0.05 s	■	t=k	-	■
Tolerance <sup>(4)</sup>	I4= 0.2...1 x In <sup>(3)</sup> ± 10%	0.02 x In	t4= 0.1 s...0.4s ± 20%	0.05 s	■	t=k/I <sup>2</sup>	-	-
<b>OT</b> Protection against over-temperature	may not be set	-	Instantaneous	-	-	temp=k	-	-

- (1) The minimum value of this trip is 750ms regardless of the type of curve set (fail-safe)
- (2) Should the fixed time trip curve be selected (t=k), apart from the ones indicated, it will also be possible to set trip time t2=minimum time
- (3) ABB SACE conforms with the NEC Standards guaranteeing that the maximum ground fault current (I4) selectable does not exceed the value of 1200A. The setting range allowed for threshold I4 is automatically decreased, according to the type of circuit breaker selected, so that the following condition is respected: [(I4 x In) <= 1200 A]
- (4) These tolerances are valid with the following hypotheses:
  - relay self-supplied when running and/or auxiliary power supply (without start-up)
  - two-phase or three-phase power supply

In all cases not covered by the above hypotheses, the following tolerance values are valid

Trip threshold	Trip time
L ± 10% (according to ANSI 37.17 Standard)	± 20%
S ± 10%	± 20%
I ± 15%	≤ 60ms
G ± 15%	± 20%



# Microprocessor-based trip units and trip curves

## PR112/P-A

### Functions L-S-I

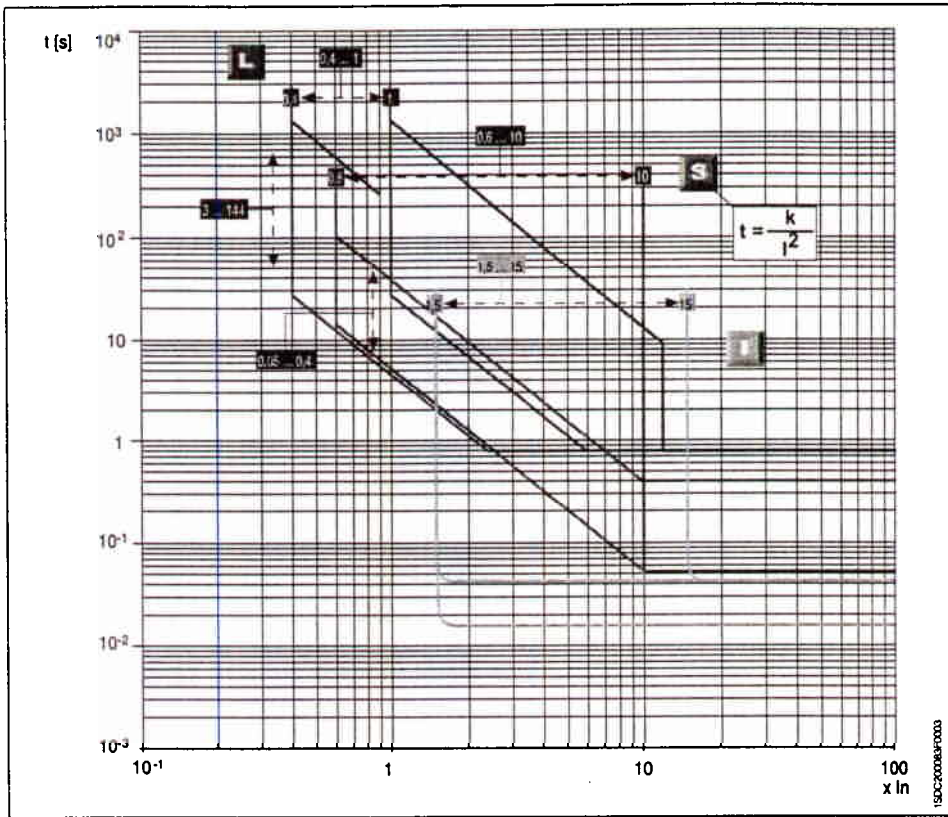

3

### Functions L-S-I

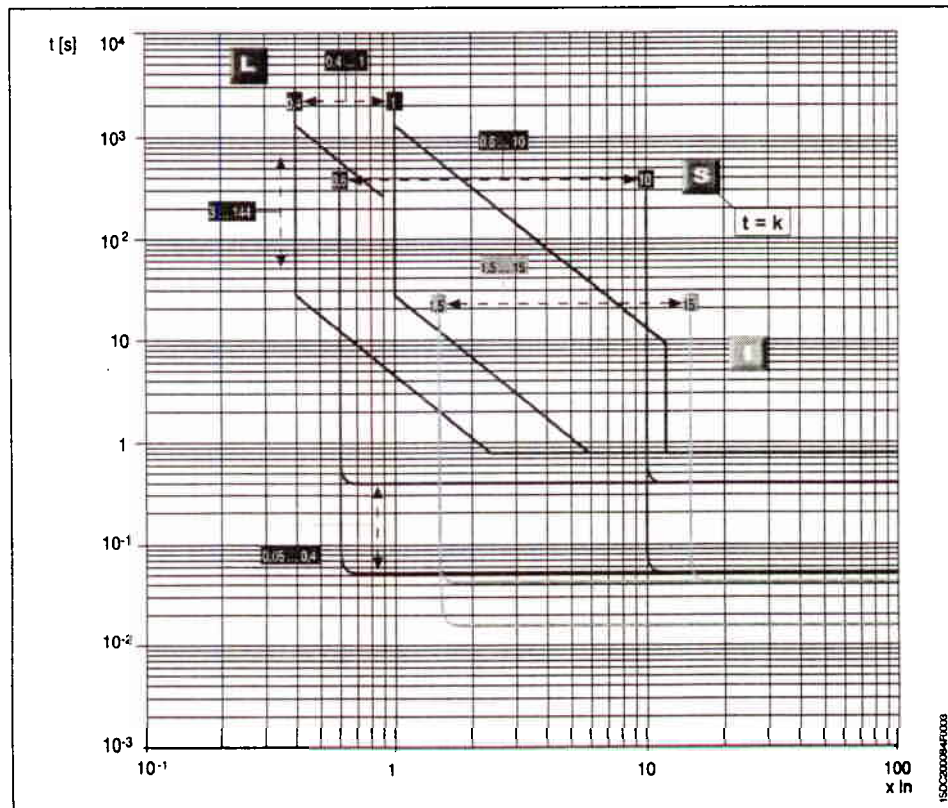

Tolerances on thresholds and trip times ..... page 3/13

# Function G

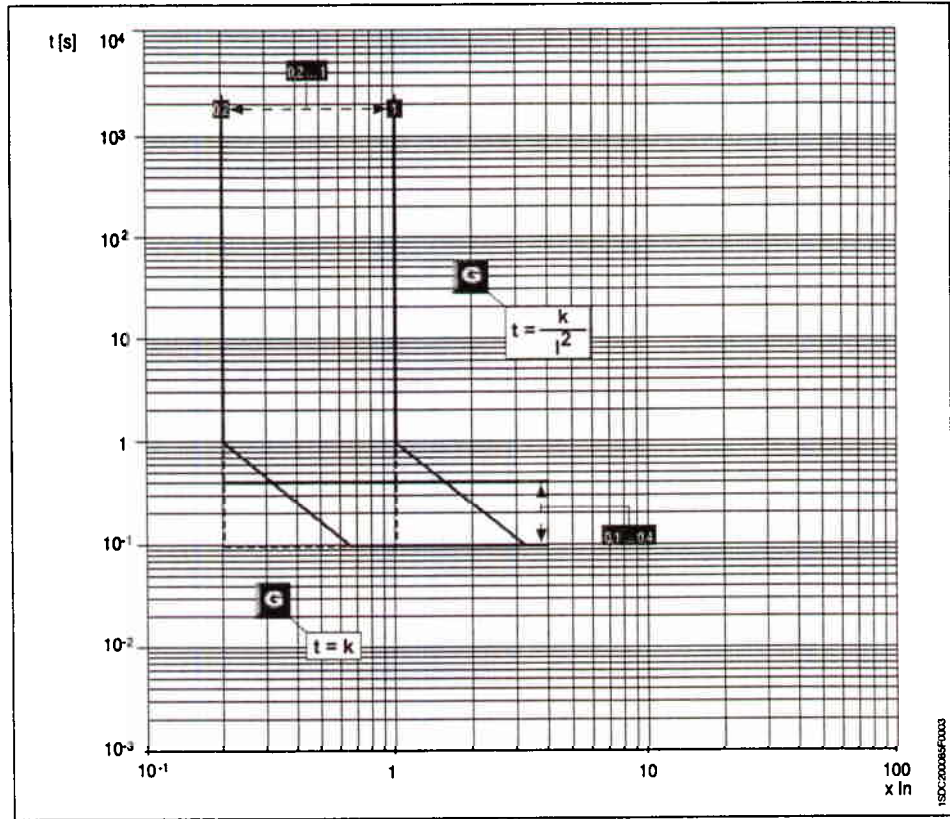





# Microprocessor-based trip units and trip curves

## PR113/P-A

ABB is a registered trademark of ABB Ltd. All other trademarks are the property of their respective owners.

### Characteristics

The PR113/P-A trip unit completes the range of trip units available for the Emax family of circuit breakers.

It is available in versions PR113/P-A, for the trip unit, and PR113/PD-A, fitted with a dialogue option.

It is a high-performance and extraordinarily versatile trip unit capable of offering a complete set of functions for protection, measurement, self-testing, signaling, data storage and control functions of the circuit breaker.

The front interface of the unit is extremely simple thanks to the liquid crystal graphics display. It is able to show diagrams, histograms, measurements and sinusoidal curves for the various electrical values.

The PR113/P-A trip unit also offers other functions in addition to standard protections, such as protection against under- and overvoltage, residual voltage protection, phase unbalance protection and protection against directional short circuit (i.e., which can be used, for example, for ring distribution networks).

3

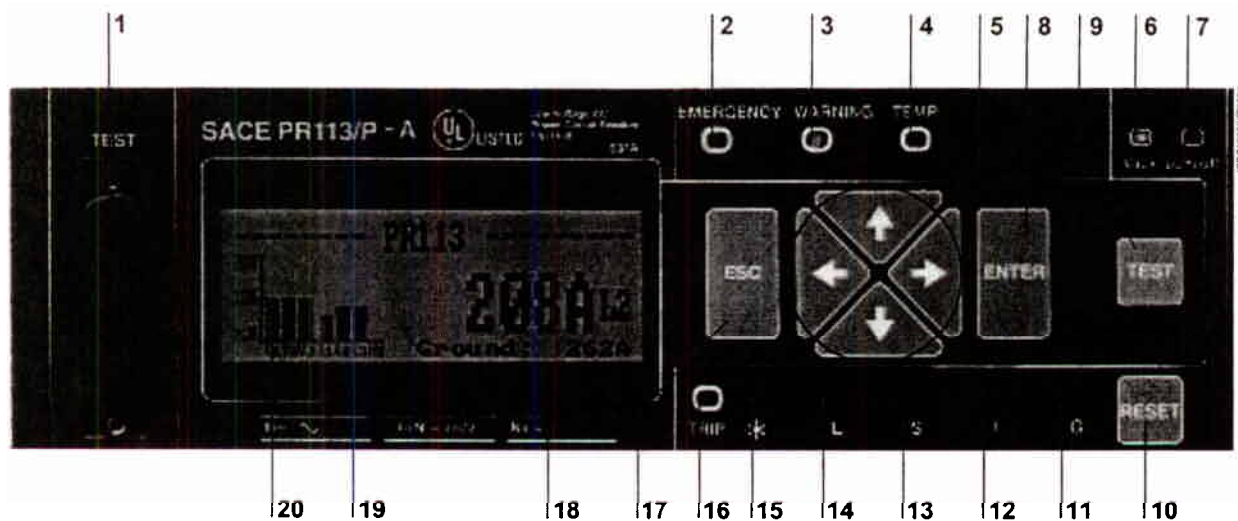

#### Legend

- |  |  |  |
|--|--|--|
| <p><b>1</b> TEST connector to apply SACE PR120/B or SACE PR010/T accessories</p> <p><b>2</b> LED signaling alarm</p> <p><b>3</b> LED signaling pre-alarm</p> <p><b>4</b> LED signaling over-temperature alarm</p> <p><b>5</b> Pushbuttons to move the cursor and set parameters: UP, DOWN, LEFT, RIGHT</p> <p><b>6</b> LED for signaling auxiliary power supply present</p> <p><b>7</b> LED signaling microprocessor fault</p> <p><b>8</b> ENTER pushbutton to enter or confirm data</p> | <p><b>9</b> Test pushbutton (TEST) and setting functions</p> <p><b>10</b> Pushbutton to reset magnetic and electrical alarm signals (RESET), to end the self-Test or return to the currents page from the Trip page</p> <p><b>11</b> Magnetic signal indicating ground fault protection "G" tripped</p> <p><b>12</b> Magnetic signal indicating instantaneous short circuit protection "I" tripped</p> <p><b>13</b> Magnetic signal indicating protection functions "S" or "D" tripped</p> <p><b>14</b> Magnetic signal indicating overload protection "L" tripped</p> | <p><b>15</b> Magnetic signal indicating that one of the following protections is tripped: undervoltage, overvoltage, residual voltage, reverse power, phase unbalance, over-temperature</p> <p><b>16</b> LED signaling "TRIP"</p> <p><b>17</b> Pushbutton to exit submenus or cancel operations (ESC)</p> <p><b>18</b> Serial number of the unit</p> <p><b>19</b> Rating plate indicating the continuous current rating of the CTs and neutral</p> <p><b>20</b> Graphics display lit from the rear</p> |
|--|--|--|

## Operation, protection functions and self-test

### Power supply

The PR113/P-A trip unit does not require an auxiliary power supply for its protection functions: it draws the energy it needs for operation from the current transformers (CT) installed in the circuit breaker. In fact, for the protections to operate, it is sufficient for at least one phase to be powered at 35% of the continuous current rating of the CTs (20% of the current if two phases are powered, and 15% for three phases). On the other hand, in order for the display to come on, at least one phase must have a current load equivalent to 50% of the continuous current rating of the CTs (30% if two phases are powered and 20% for three phases).

Complete operation of the trip unit can be guaranteed by providing an auxiliary power supply capable of monitoring the functions and protections, including: zone discrimination, load control, measuring and calculating harmonics, energy and maintenance.

Auxiliary power supply is available through the SACE PR120/B accessory, always supplied, which makes it possible to read data and program the trip units in cases where:

- circuit breaker is not powered
- circuit breaker cannot be powered
- draw out circuit breaker in racked-out position.

The ground fault protection can also be obtained by connecting the PR113/P-A trip unit to an external toroid located on the conductor that connects the transformer star center to ground (homopolar toroid).

All the thresholds and trip curve delays of the protection functions are stored in special memories which retain the information even when no power is supplied.

	PR113/P-A	PR113/PD-A
Auxiliary power supply (galvanically insulated)	24 V DC $\pm$ 20%	24 V DC $\pm$ 20%
Maximum ripple	5%	5%
Inrush current @ 24V	-3 A for 30 ms	-5 A for 30 ms
Starting current @ 24V	-1.0 A for 150 ms	-1.0 A for 150 ms
Continuous current rating @ 24V	-200 mA	-310 mA
Rated power @ 24V	-5 W	-8 W

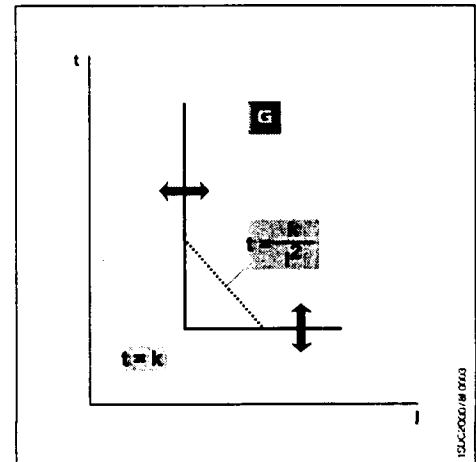
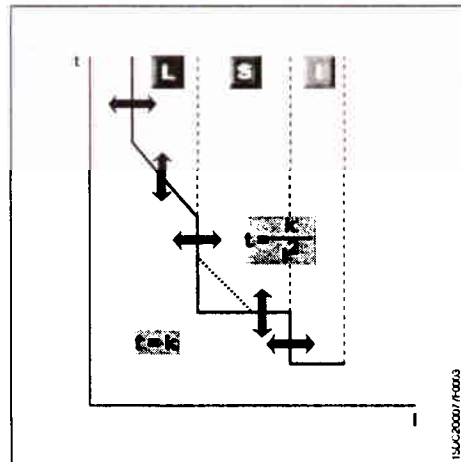

# Microprocessor-based trip units and trip curves

## PR113/P-A

### Protection functions

The PR113/P-A trip unit offers the following protection functions:

- overload (L),
- selective short circuit (S),
- instantaneous short circuit (I),
- ground fault with adjustable delay (G),
- directional short circuit with adjustable delay (D)<sup>(1)</sup>,
- phase unbalance (U),
- protection against over-temperature (OT),
- load control (K),
- undervoltage (UV)<sup>(1)</sup>,
- overvoltage (OV)<sup>(1)</sup>,
- residual voltage (RV)<sup>(1)</sup>,
- reverse power (RP)<sup>(1)</sup>

**Note (1):** For these protections it is necessary to use a set of three external voltage transformers.

Shielded Voltage Transformers			
Rated Primary Voltage ANSI/IEC	(Un)	[V]	[100, 115, 120, 190, 208, 220, 230, 240, 277, 347, 380, 400, 415, 440, 480, 500, 550, 600, 660, 690, 910, 950, 1000] / $\sqrt{3}$
Rated Secondary Voltage	(Us)	[V]	100/ $\sqrt{3}$
Precision class			0,5
Primary winding resistance		[Ohm]	> 600
Load resistance		[kOhm]	≥ 10
Overload			20% permanent
Insulation		[kV]	4 between IN and OUT 4 between shield and IN the shield must be grounded) between shield and OUT (the shield must be grounded)
Frequency		[Hz]	45 ≤ f ≤ 66

Note: sample selection of the voltage transformer.

For maximum measuring performance in installations with rated phase-phase voltage = 690V AC, it is necessary to use a voltage transformer with

$$U_n = 690/\sqrt{3}$$

$$\text{Class} = 0,5$$

### Directional short circuit protection with adjustable delay D

The protection works in a similar way to the fixed-time protection "S", with the added ability to recognize the direction of the phase current during the fault period. The current direction makes it possible to determine whether the fault is on the supply or load side of the circuit breaker; Particularly in ring distribution systems, this makes it possible to identify and disconnect the distribution segment where the fault has occurred, while keeping the rest of the installation running. If several PR112/P-A or PR113/P-A trip units are used, this protection can be associated with zone discrimination. Directional protection is based on the possibility of correlating the behavior of the circuit breaker with the direction of the fault current.

#### Notes:

The directional short circuit protection can be disabled for an adjustable set time (t = k), and can either be self-supplied or use the auxiliary power supply. Directional protection is not available on the 250A and 400A CTs.

According to the direction of the current, two different trip times can be set on the PR113/P-A trip unit:

- a time in concordant direction (Fw) with the reference direction set;
- a time in discordant direction (Bw) with the reference direction set.

With reference to the figure below, for a fault in point B, the current will be in direction A-B, discordant with the reference direction: the trip time will be Bw. Similarly, for a fault in A, the current direction will be B-A, concordant with the reference direction: the trip time will be Fw.

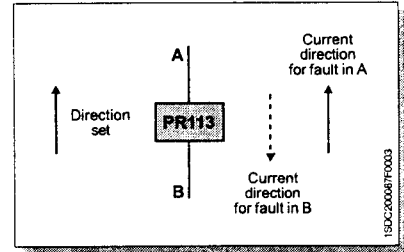

In the following example, the combinations present in the table occur:

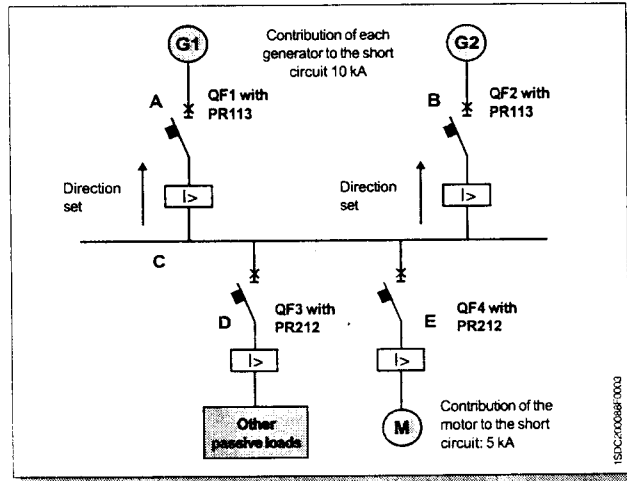

Circuit breaker	Fault In	Current measured [kA]	Direction	Trip time
QF1	A	15	Concordant	Fw
	B, C, D, E	10	Discordant	Bw
QF2	B	15	Concordant	Fw
	A, C, D, E	10	Discordant	Bw

In this installation, discrimination between QF1, QF2, QF3 and QF4 is required.

By analyzing the table, it can be noted that the only case where the fault current has a concordant direction with the one set for the QF1 circuit breaker is for a fault in point A. The QF1 circuit breaker must trip more rapidly than the other circuit breakers, since it is the closest to the fault. To obtain this, the trip time value Fw must be set to a lower value than that of the QF3 and QF4 circuit breakers.

For the other possible faults, the QF1 circuit breaker must be the slowest. Since the fault current always has a discordant direction compared with the one set, it is necessary to adjust the trip time Bw to a value higher than that of the QF3 and QF4 circuit breakers.

In the same way as described for the QF1 circuit breaker, the QF2 circuit breaker must trip first in the case of a fault in B and delay the trip when any faults occur in other points of the installation, guaranteeing discrimination.

---

# Microprocessor-based trip units and trip curves

## PR113/P-A

---

### Phase unbalance protection U

Protection function U, against phase unbalance, is used in those situations requiring particularly accurate control over missing and/or unbalanced phase currents. This function can be excluded.

### Load control function K

There are two separate curves with threshold currents and trip times lower than those available for selection with protection L, which can be used for the following two applications:

- disconnection of two separate loads;
- connection and disconnection of a load.

These functions make it possible to connect/disconnect individual loads before the overload protection L is tripped and definitively opens the circuit breaker.

The load control can be activated directly through the programmable contacts, or using the PR020/K load control and signaling device.

### UV, OV, RV Voltage protections

The PR113/P-A trip unit offers three types of voltage protection, which can be excluded:

- undervoltage (UV),
- overvoltage (OV),
- residual voltage (RV).

The residual voltage protection RV identifies interruptions of the neutral (or of the grounding conductor in systems with grounded neutral) and faults that shift the star center in systems with insulated neutral (e.g. large ground faults). The star center shift is calculated as a vector sum of the phase voltages.

With the circuit breaker closed, these protections also operate when the trip unit is self-supplied. With the circuit breaker open they only operate when the auxiliary power supply is present: in this case the trip unit will indicate the "ALARM" status.

### Protection against reverse power RP

Protection against reverse power is especially suited for protecting large machines such as engines and generators. The PR113/P-A trip unit can analyze the direction of the active power and open the circuit breaker if the direction is opposite to normal operation. The reverse power threshold and the trip time are adjustable. The protection against reverse power trips when the active power is entering the generator and not coming out as under normal conditions. The reverse power takes place when there is a sharp reduction in the mechanical power supplied by the prime mover drawing the generator. Under this condition, the generator acts as a motor and serious damage to the prime movers can occur, such as overheating for steam turbines, cavitations for hydraulic turbines or explosions of unburnt fuel for Diesel engines.

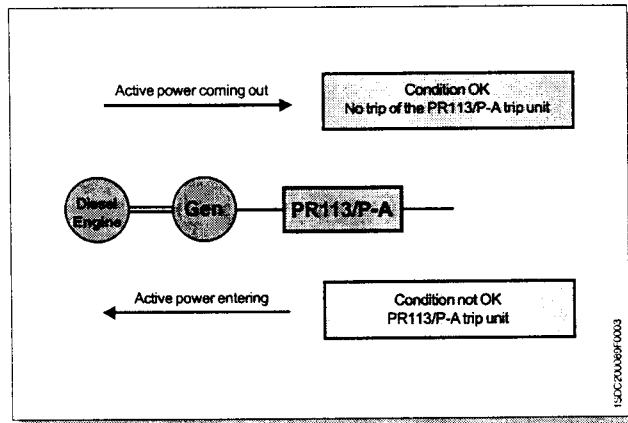

When the power measured by the trip unit falls below zero, the PR113/P-A trips, opening the circuit breaker and thereby preventing any damage occurring.

# Microprocessor-based trip units and trip curves

## PR113/P-A

### Setting the neutral

The neutral protection is normally set to a current value equivalent to 50% of the phase setting. In some installations where very high harmonics occur, the resulting current at the neutral can be higher than that of the phases.

This protection can be set for the following values on the PR113/P-A trip unit:

$I_{1N} = 50\% - 100\% - 150\% - 200\% \times I_1$

The table below lists the neutral settings for the various possible combinations between type of circuit breaker and the setting of threshold  $I_1$ .

Settings which can be made for protection of the Neutral			
	Setting of threshold $I_1$ (protection against overload)		
Circuit breaker size	$0,4 \leq I_1 \leq 0,5$	$0,5 < I_1 \leq 0,66$	$0,66 < I_1 \leq 1$
E1B-A	50-100-150-200%	50-100-150%	50-100%
E2B-A	50-100-150-200%	50-100-150%	50-100%
E2N-A	50-100-150-200%	50-100-150%	50-100%
E3N-A	50-100-150-200%	50-100-150%	50-100%
E3S-A	50-100-150-200%	50-100-150%	50-100%
E3H-A	50-100-150-200%	50-100-150%	50-100%
E3V-A	50-100-150-200%	50-100-150%	50-100%
E4S-A	50-100%	50%	50%
E4H-A	50-100%	50%	50%
E4V-A	50-100%	50%	50%
E6H-A	50-100%	50%	50%
E6V-A	50-100%	50%	50%

### Start-up function

The start-up function allows the protections S, D, I and G to operate with higher trip thresholds during the start-up phase. This avoids untimely tripping caused by the high inrush currents of certain loads (motors, transformers, lamps).

The start-up phase lasts from 100 ms to 1.5 s, in steps of 0.05 s. It is automatically recognized by the PR113/P-A trip unit as follows:

- when the circuit breaker closes with the trip unit self-supplied;
- when the peak value of the overcurrent exceeds  $0.1 \times I_n$ ; a new start-up becomes possible after the current has fallen below the threshold of  $0.1 \times I_n$ , if the trip unit is powered from an external source.

**Zone discrimination function**

The zone discrimination function permits the fault area to be insulated by very rapidly segregating the system only at the level closest to the fault, while leaving the rest of the installation running.

This is done by connecting the trip units together: the one nearest the fault is instantly tripped, sending a block signal to the other trip units affected by the same fault.

The zone discrimination function can be enabled if the fixed time curve has been selected and the auxiliary power supply is present.

Zone discrimination can be applied with protections S and G or, alternatively, with protection D.

**Directional zone discrimination**

By means of zone discrimination with function D, it is possible to coordinate the behavior of the various PR113/P-A by suitably cabling the trip unit buses. In fact, each trip unit has 4 signals available, two input signals (one in concordant and one in discordant direction), by means of which the trip unit receives the locking signal coming from other trip units, and two output signals (one in concordant and one in discordant direction), by means of which the trip unit sends the locking signal to other trip units. Thanks to these connections, the circuit breaker which trips will always be the one closest to the fault, thereby guaranteeing maximum discrimination in the installation. For example, following diagram indicates the connections which have to be made to activate the locks between the various trip units. In particular, it is noted that:

for a fault in A, the QF1 circuit breaker is passed through by a current coming from busbar B1; this current is in concordant direction with the one set. The OUT Fw bus of QF1 locks the bus IN Bw of the QF2 circuit breaker and bus IN Fw of the QF3 circuit breaker: in fact, QF2 is passed through by a current in a discordant direction in relation to the one set, whereas QF3 is passed through by a current concordant with the one set.

The following figure indicates all the connections between the trip units. Apart from the connection, the thicker arrows indicate the active lock.

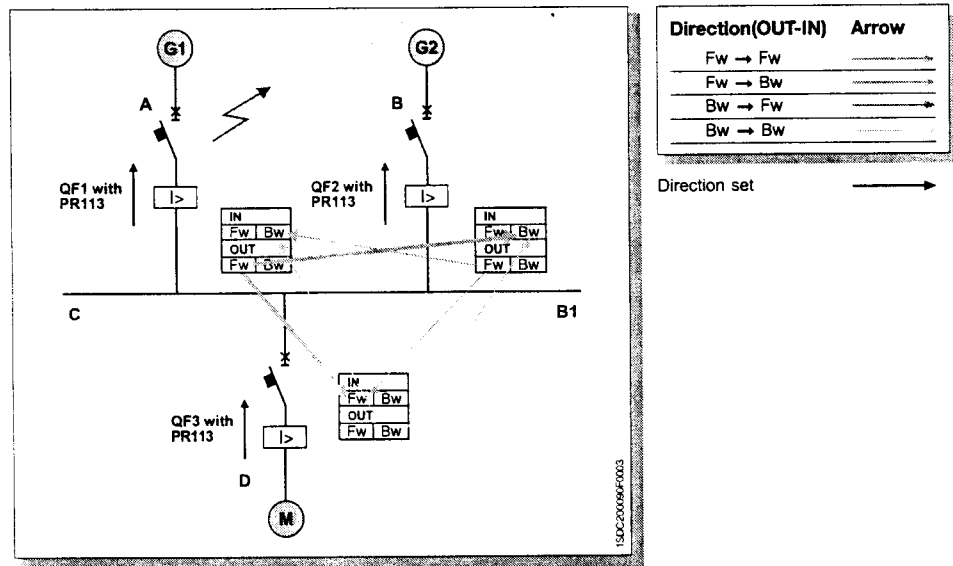



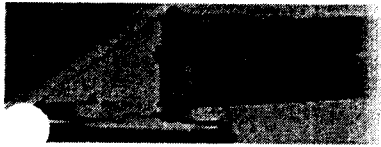

---

# Microprocessor-based trip units and trip curves

## PR113/P-A

---

### Contact programming functions

The PR113/P-A trip unit is equipped with two relays, with contacts known as K51/p1 and K51/p2 (the latter is not available on PR113/PD-A).

These can signal a variety of situations selected by the user, including: protection timing, alarms, cause of opening, temperature thresholds exceeded, zone discrimination, load control, disconnection of opening solenoid or CT, harmonic distortion, etc.

### Measuring functions

The PR113/P-A trip unit provides a complete set of measurements:

- Currents: three phases (L1, L2, L3), neutral (Ne), ground fault
- Voltage: phase-phase, phase-neutral, residual voltage<sup>(1)</sup>
- Power: active, reactive, apparent<sup>(1)</sup>
- Power factor<sup>(1)</sup>
- Frequency and peak factor
- Energy: active, reactive, apparent, meter<sup>(1)</sup>
- Harmonics calculation: up to the twentieth harmonic (waveform and module of the harmonics displayed); up to the nineteenth for frequency  $f=60\text{Hz}$
- Maintenance: number of operations, percentage of contact wear, opening data storage.

The PR113/P-A unit is able to provide the pattern of measurements for some values over an adjustable period of time P, such as: average active power, maximum active power, maximum current, maximum voltage and minimum voltage. The last 24 P periods (adjustable from 5 to 120 min.) are stored in non-volatile memory and displayed in a histogram.

**Note (1):** These measurements require voltage transformers



### Signaling functions

The PR113/P-A unit provides optic signals (via indicator LEDs, magnetic flags and display messages) and electrical signals.

**Optic signals** on the front of the trip unit:

- Vaux LED (green): indicates there is an auxiliary power supply
- $\mu$ P Fault LED (red): indicates a temporary or permanent fault in the microprocessor
- Temp LED (orange): the signal flashes for internal relay temperatures  $<-20^{\circ}\text{C}$  or  $>+70^{\circ}\text{C}$ , and is steadily lit for temperatures  $<-25^{\circ}\text{C}$  or  $>+85^{\circ}\text{C}$
- Trip LED (red): with auxiliary voltage only, this lights after the circuit breaker opens due to tripped protections
- Warning LED (yellow): is a generic pre-alarm signal following the occurrence of any of the conditions listed below:
  - one or more phases with current values in the range of  $I > 0.83 \times I_1$
  - two or three phases with unbalance greater than the programmed level for the protection U (phase unbalance), with protection trip disabled
  - distorted waveform with peak factor  $> 2.1$  (harmonic distortion)
  - contact wear beyond 80%.
  - frequency out of range
  - Warning Threshold exceeded (current pre-alarm threshold settable from the configuration menu)
  - circuit breaker status error
- Emergency LED (red): is a generic alarm signal when one of the conditions listed below occurs:
  - one or more phases overloaded with current values  $I > 1.0 \times I_1$
  - timing in progress for protection functions: S, I, G, D, UV, OV, RV, RP
  - timing in the event of a phase unbalance greater than the value set, with protection trip set to on
  - contact wear at 100%
  - CTs disconnected
  - opening solenoid disconnected
- Yellow magnetic flag  $\star$ : indicates one of the following protections is tripped: undervoltage (UV), overvoltage (OV), residual voltage (RV), reverse power (RP), phase unbalance (U), over-temperature (OT). The trip unit display indicates which protection has been tripped
- Yellow magnetic flag L: indicates protection L tripped
- Yellow magnetic flag S: signals protection S or D tripped
- Yellow magnetic flag I: instantaneous short circuit protection I tripped
- Yellow magnetic flag G: ground fault protection G tripped.

The **electrical signals** refer instead to the contacts:

- K51/p1 and K51/p2, which can be set by the user (with auxiliary power supply only)
- K51/YO1, which signals that one of the following protections is tripped: L, S, D, I, G, U, OT, UV, OV, RV, RP
- K51/ $\mu$ P, to signal temporary or permanent fault of the microprocessor.

In addition to the optic and electrical signals, the PR113/P-A trip unit display also shows messages about incorrect configurations, general alarms, tripped protection functions, load control (with the aid of SACE PR020/K) and password management.



# Microprocessor-based trip units and trip curves

## PR113/P-A

### Versions available

The following versions are available:



PR113/P-A LSIG



PR113/PD-A LSIG

3

## Protection functions and setting values of the PR113/P-A trip unit

Function	Trip threshold	Threshold steps	Trip time	Step time	Can be excluded	Relation t=f(I)	Thermal memory discrimination	Zones discrimination
<b>L</b> Protection against overload Tolerance <sup>(4)</sup>	I1= 0,4....1 x In ± 10% (according to ANSI 37.17 Standard)	0,01 x In	t1= 3 s....144 s ± 10% I <sub>g</sub> ≤ 4 x In ± 20% I <sub>g</sub> > 4 x In	3 s <sup>(1)</sup>	-	t=k/I <sup>2</sup>	■	-
<b>S</b> Selective protection against short circuit Tolerance <sup>(4)</sup>	I2= 0,6....10 x In ± 7% I <sub>g</sub> ≤ 4 x In ± 10% I <sub>g</sub> > 4 x In	0,1 x In	t2= 0,05 s....0,40 s <sup>(2)</sup> The best of the two given: ± 10% or ± 50 ms I <sub>g</sub> ≤ 4 x In ± 15% or ± 50 ms I <sub>g</sub> > 4 x In	0,01s	■	t=k	-	■
	I2= 0,6....10 x In ± 7% I <sub>g</sub> ≤ 4 x In ± 10% I <sub>g</sub> > 4 x In	0,1 x In	t2= 0,05 s....0,40 s ± 15% I <sub>g</sub> ≤ 4 x In ± 20% I <sub>g</sub> > 4 x In	0,01s	■	t=k/I <sup>2</sup>	■	-
<b>I</b> Instantaneous protection against short circuit Tolerance <sup>(4)</sup>	I3= 1,5....15 x In ± 10% I <sub>g</sub> ≤ 4 x In ± 15% I <sub>g</sub> > 4 x In	0,1 x In	Instantaneous ≤ 25 ms	-	■	t=k	-	-
<b>G</b> Protection against ground faults Tolerance <sup>(4)</sup>	I4= 0,2....1 x In <sup>(3)</sup> ± 7% I <sub>g</sub> ≤ 4 x In	0,02 x In	t4= 0,1 s....0,4 s The best of the two given: ± 10% or ± 50 ms I <sub>g</sub> ≤ 4 x In	0,05 s	■	t=k	-	■
	I4= 0,2....1 x In <sup>(3)</sup> ± 7% I <sub>g</sub> ≤ 4 x In	0,02 x In	t4= 0,1 s....0,4 s ± 15%	0,05 s	■	t=k/I <sup>2</sup>	-	-
<b>●</b> Protection against directional short circuit Tolerance	I7= 0,6....10 x In ± 10%	0,1 x In	t7= 0,20 s....0,75 s ± 20%	0,01 s	■	t=k	-	■
<b>●</b> Protection against phase unbalance Tolerance	I6= 10%....90% ± 10%	10%	t6= 0,5 s....60 s ± 20%	0,5 s	■	t=k	-	-
<b>OT</b> Protection against over-temperature	cannot be set	-	Instantaneous	-	-	temp=k	-	-
<b>UV</b> Protection against undervoltage Tolerance	I8= 0,6....0,95 x Un ± 5%	0,01 x In	t8= 0,1 s....5 s ± 20%	0,1 s	■	t=k	-	-
<b>OV</b> Protection against overvoltage Tolerance	I9= 1,05....1,2 x Un ± 5%	0,01 x In	t9= 0,1 s....5 s ± 20%	0,1 s	■	t=k	-	-
<b>RV</b> Protection against residual voltage Tolerance	I10= 0,1....0,4 x Un ± 5%	0,05 Un	t10= 0,5 s....30 s ± 20%	0,5 s	■	t=k	-	-
<b>RP</b> Protection against reverse power Tolerance	P11= -0,3....-0,1 x Pn ± 10%	0,02 Pn	t11= 0,5 s....25 s ± 20%	0,1 s	■	t=k	-	-

- (1) The minimum value of this trip is 750ms regardless of the type of curve set (fail-safe)  
 (2) Should the fixed time trip curve be selected (t=k), apart from the ones indicated, it will also be possible to set trip time t2=minimum time  
 (3) ABB conforms with the NEC Standards guaranteeing that the maximum ground fault current (I4) selectable does not exceed the value of 1200A.  
 The setting range allowed for threshold I4 is automatically decreased, according to the type of circuit breaker selected, so that the following condition is respected: [(I4 x In) <= 1200 A]  
 (4) These tolerances are valid with the following hypotheses:  
 - relay self-supplied when running and/or auxiliary power supply (without start-up)  
 - two-phase or three-phase power supply

In all cases not covered by the above hypotheses, the following tolerance values are valid:

Trip threshold	Trip time
L ± 10% (according to ANSI 37.17 Standard)	± 20%
S ± 10%	± 20%
I ± 15%	± 60ms
G ± 10%	± 20%



# Microprocessor-based trip units and trip curves

## PR113/P-A

### Functions L-S-I

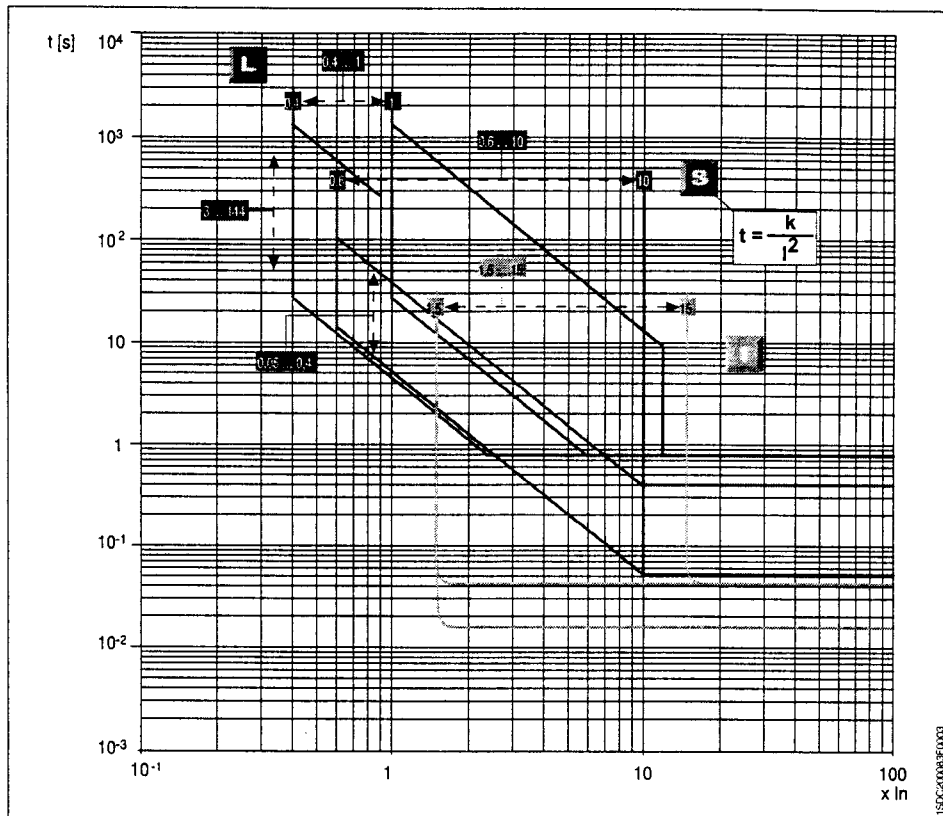

3

### Functions L-S-I

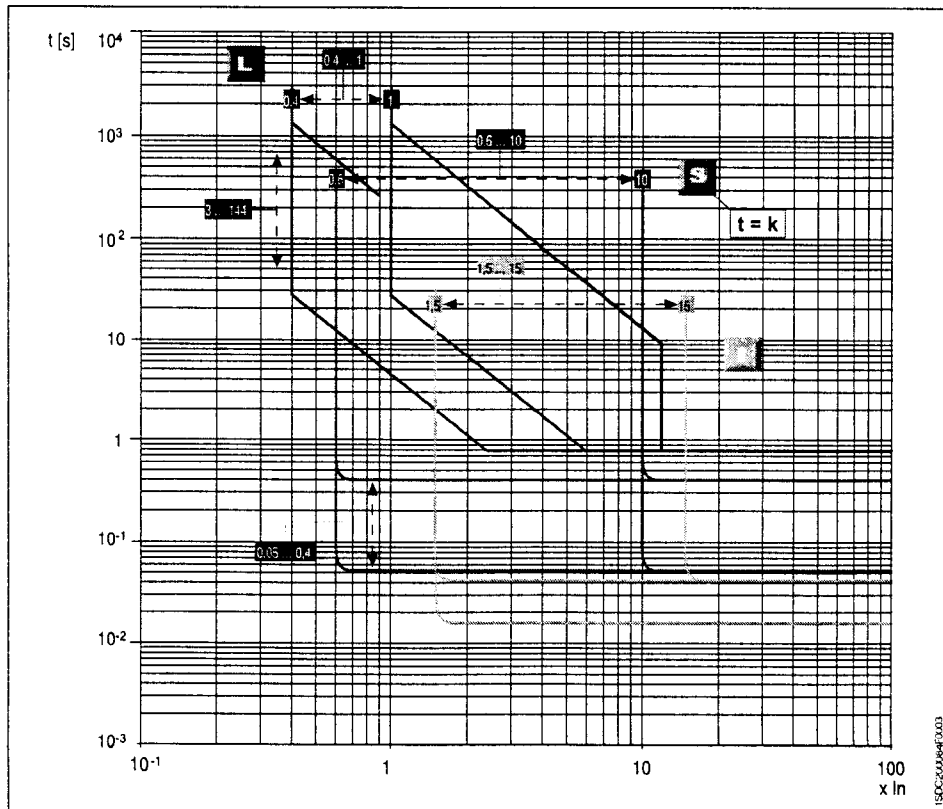

Tolerances on thresholds and trip times ..... page 3/24

Function G

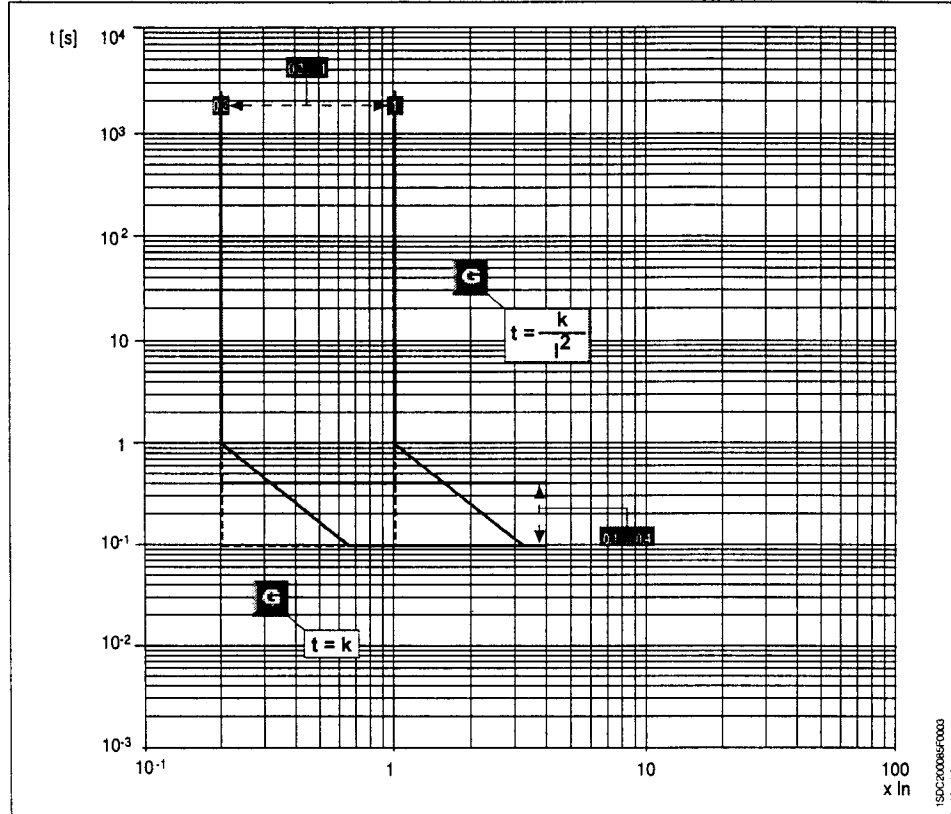

3

Tolerances on thresholds and trip times ..... page 3/24

# Microprocessor-based trip units and trip curves

## PR113/P-A

### Function D

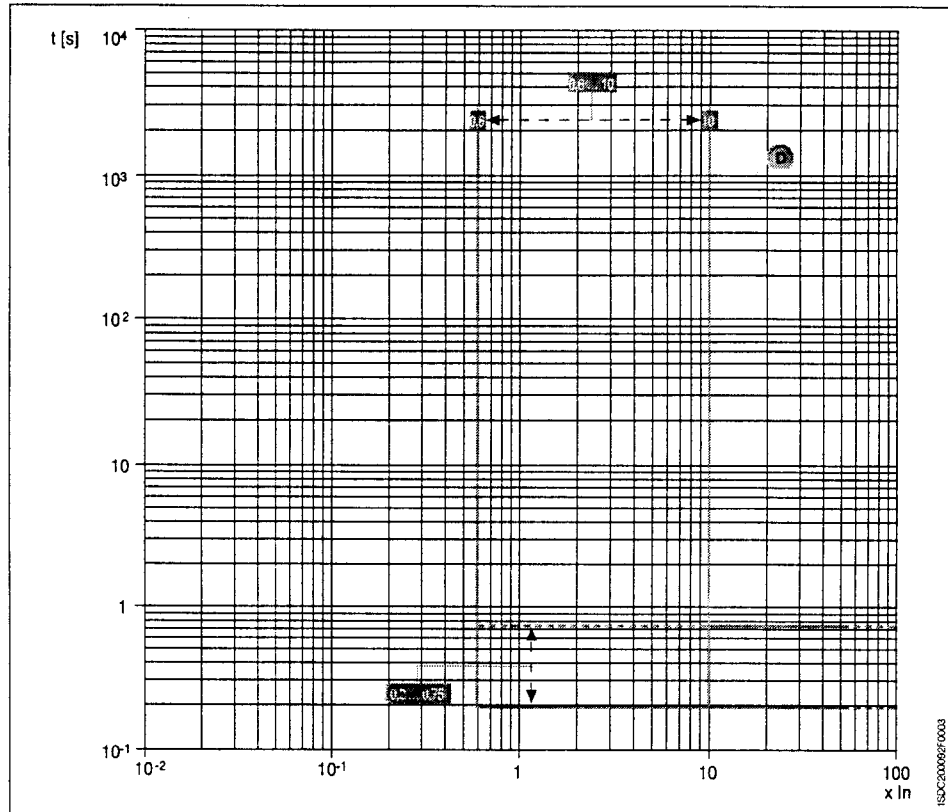

### Function U

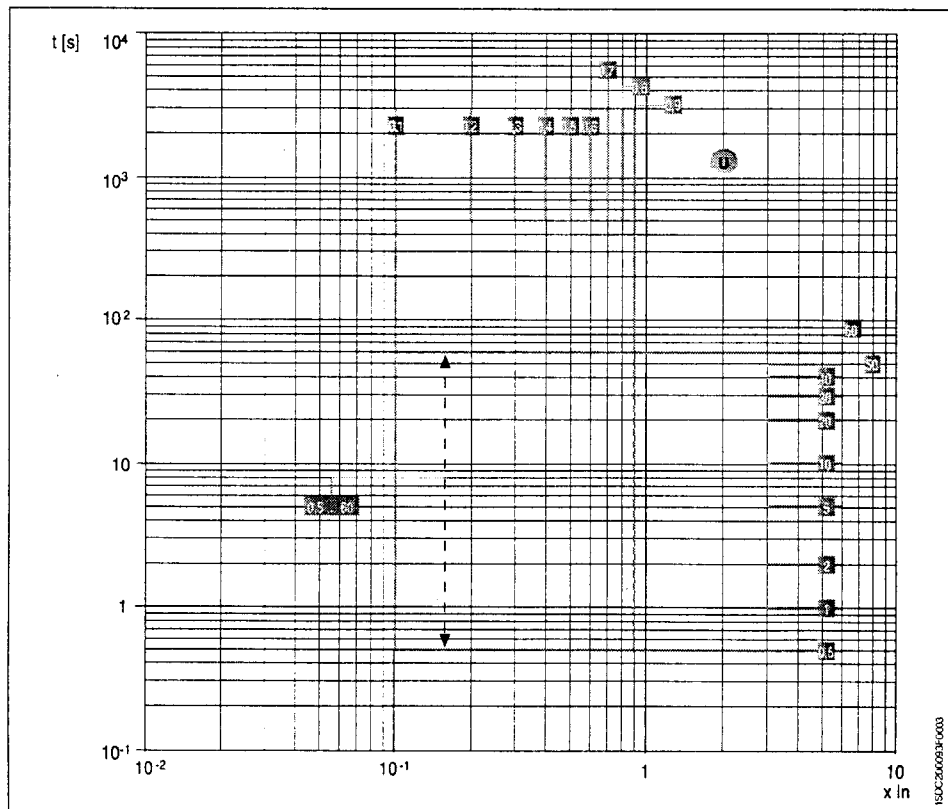

Tolerances on thresholds and trip times ..... page 3/24

## Function UV

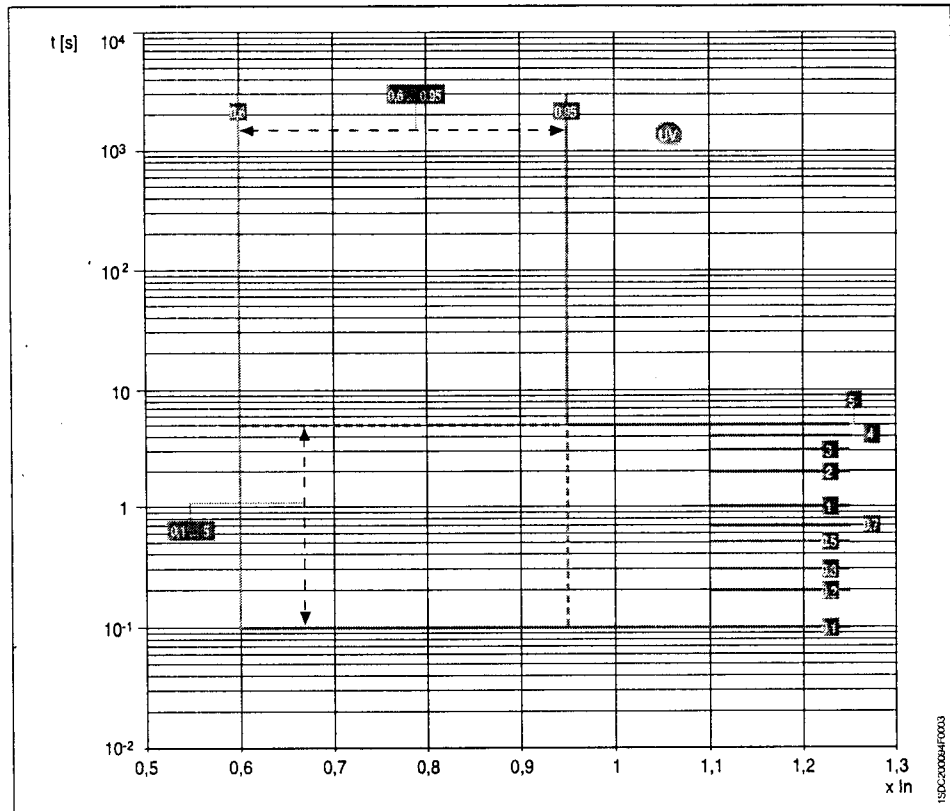

## Functions OV

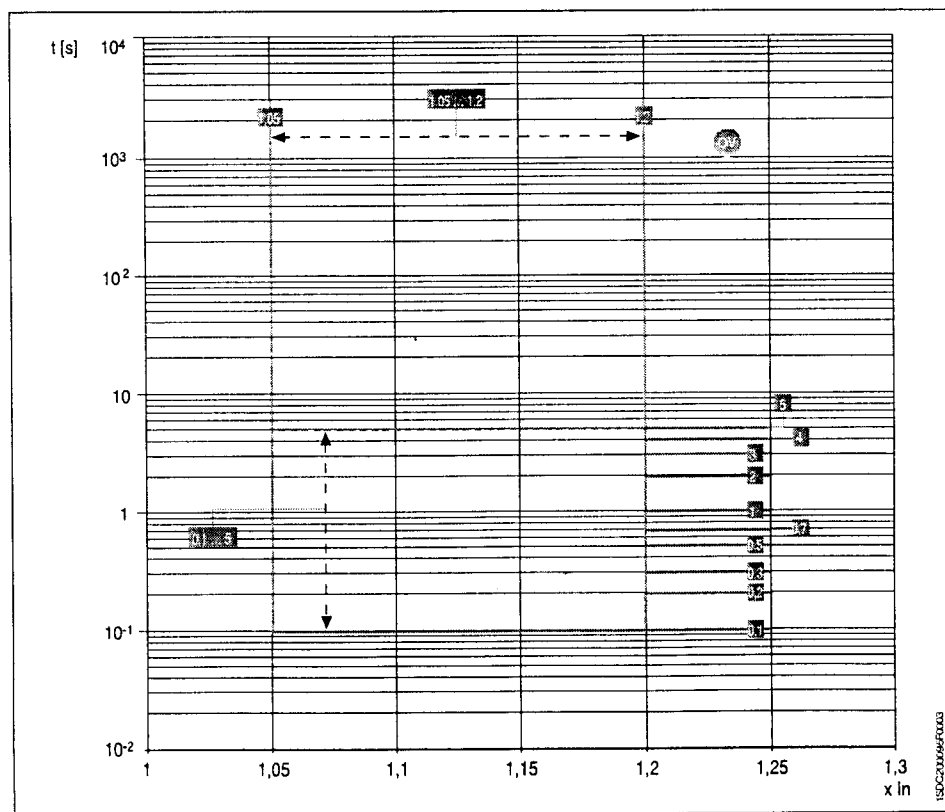

Tolerances on thresholds and trip times ..... page 3/24



# Microprocessor-based trip units and trip curves PR113/P-A

## Function RV

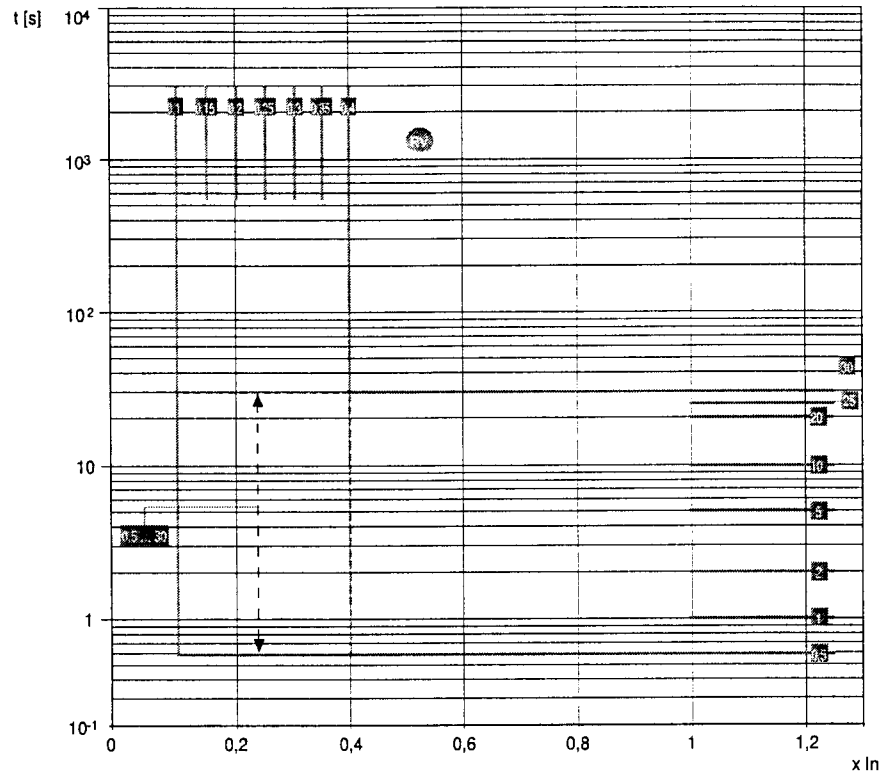

## Function RP

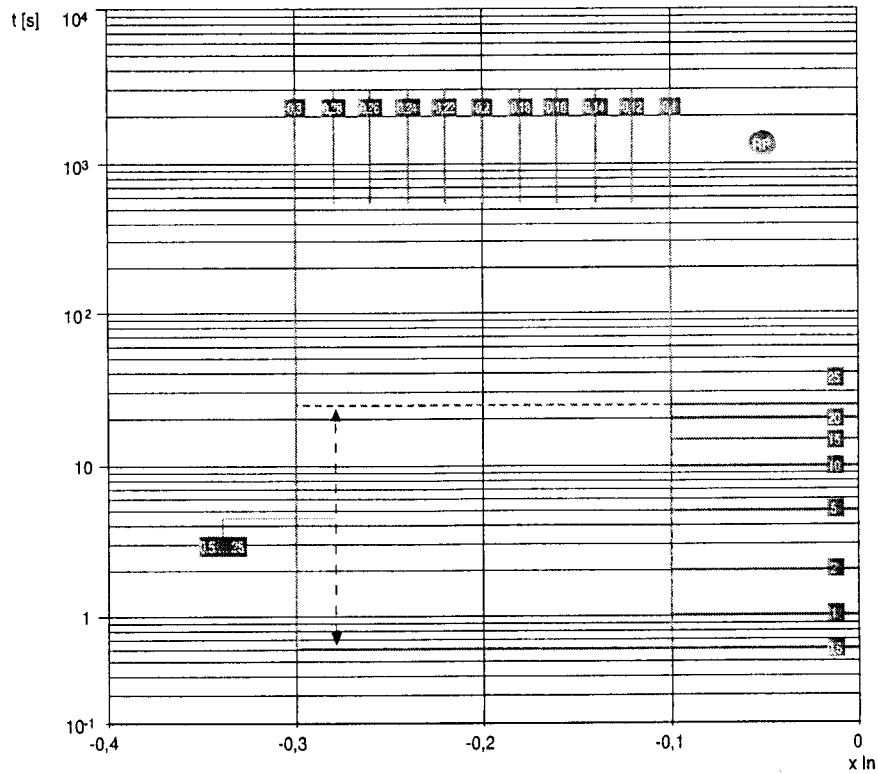

Tolerances on thresholds and trip times ..... page 3/24

---

# Trip and dialogue units for Modbus® RTU networks

## PR112/PD-A and PR113/PD-A

---

Functional integration among various kinds of technological installations in industry and services is gradually increasing the need for communication, control and automation in low-voltage electrical installations. Modern microprocessor-based systems that operate using a logic of distributed intelligence (through components able to process data, exchange information, signals and commands) offer the most effective and flexible solution and cover a variety of different applications and specific needs. For a prompt and effective response to the demand for interconnection, intelligence, functionality, flexibility, interoperability and ease of installation, ABB has developed new communication and control devices for low-voltage circuit breakers based on the Modbus® RTU protocol.

In particular, the new devices developed for the Emax range of power circuit breakers include:

- PR112/PD-A Modbus® trip units, based on the Modbus® RTU protocol;
- PR113/PD-A Modbus® trip units, based on the Modbus® RTU protocol.

### Modbus® RTU

The Modbus® RTU protocol has been well-known and used worldwide for several years. It is essentially the market standard thanks to its ease of installation, configuration and integration into different supervision, control and automation systems, in addition to good performance. PR112/PD-A Modbus (available in LSI and LSI<sup>2</sup> versions) and PR113/PD-A Modbus trip units, allow ABB SACE Emax power circuit breakers to be integrated. Modbus® RTU provides a Master-Slave system architecture in which a Master (PLC, PC, etc.) cyclically queries several Slaves (field devices). The devices use the standard EIA RS485 as the physical data transmission means, and a maximum transmission rate of 19200 bit/sec.

**Note:**  
Modbus® and Modbus® RTU are registered trademarks of Modicon, Inc.

### PR112/PD-A and PR113/PD-A dialogue units

The human-machine interface (HMI) of the PR112/PD-A and PR113/PD-A devices is made up of a graphics display, LEDs, magnetic flags and touch pad pushbuttons.

The user can choose from among five available languages: Italian, English, German, French and Spanish. The HMI is active when the auxiliary power supply is used, if the PR120/B battery unit is connected, or, finally, if the single-phase current is more than 35% of the continuous current rating of the current transformers.

The PR112/PD-A and PR113/PD-A trip units are always supplied with the PR120/B battery unit. This accessory is connected to the front connector of the trip unit, and allows the protection parameters to be set regardless of the circuit breaker status.

The communication functions and relative parameter settings are only available when the auxiliary power supply is present.

### Data receiving and transmitting

The PR112/PD-A and PR113/PD-A trip units with built-in communication and control functions allow remote acquisition and transmission of a wide range of information, opening and closing commands, thanks to shunt trips and closing coils installed on the circuit breaker; and storage of configuration and programming parameters for the unit itself: the current thresholds of the protection functions and the protection curves.

All the information can be consulted either locally, directly on the front of the circuit breaker, or remotely via supervision and control systems.

### Protection functions

All the trip units with communication functions perform the same protection functions as the corresponding trip units. See the corresponding sections for the trip units.



# Trip and dialogue units for Modbus® RTU networks

## PR112/PD-A and PR113/PD-A

### Measuring, signaling, available data functions

The table provides details of the functions available on each of the PR112/PD-A and PR113/PD-A trip units.

	PR112/PD-A Modbus	PR113/PD-A Modbus
<b>Communication functions</b>		
Protocol	Modbus RTU standard	Modbus RTU standard
Physical means	EIA RS485	EIA RS485
Speed (maximum)	19200bps	19200bps
<b>Measurement functions</b>		
Phase currents	■	■
Neutral	■	■
Ground	■	■
Voltage (phase-phase, phase-neutral, residual)		■
Power (active, reactive, apparent)		■
Power factor		■
Frequency and peak Factor		■
Energy (active, reactive, apparent)		■
Harmonic calculation up to 20 <sup>th</sup> harmonic		■
<b>Signaling functions</b>		
LED: auxiliary power supply, microprocessor fault, warning	■	■
Temperature		■
Magnetic flags: trip indication for L, S, I, G and T	■	
Magnetic flags: trip indication for L, S, I, G and other protection		■
Output contacts: microprocessor fault, trip and one freely configurable	■	
Output contacts: microprocessor fault, trip and two freely configurable		■
<b>Data available</b>		
State of circuit breaker (open, closed)	■	■
Circuit breaker position (connected, racked-out)	■	■
Mode (local, remote)	■	■
Protection setting parameters	■	■
Parameters for load control	■	■
<b>Alarms</b>		
Protection L	■	■
Protection S	■	■
Protection I	■	■
Protection G	■	■
Protection OT	■	■
Trip unit command for fault failure	■	■
Undervoltage, overvoltage and residual voltage protection (timing and trip)		■
Protection against reverse power flow (timing and trip)		■
<b>Maintenance</b>		
Total number of operations	■	■
Total number of trips	■	■
Number of trip tests	■	■
Number of manual operations	■	■
Number of trips for each protection function	■	■
Contact wear (%)	■	■
Recording data of the last trip	■	■
<b>Controls</b>		
Circuit breaker opening/closing	■	■
Alarm reset	■	■
Setting curves and thresholds of the trip unit	■	■
<b>Safety function</b>		
Automatic opening in the case of trip unit failure due to fault (by means of opening coil)	■	■

3

## Accessories for trip units

### SACE PR120/B power supply unit

This accessory, always supplied with the PR112/P-A and PR113/P-A range of trip units, makes it possible to read and configure the parameters of the unit whatever the status of the circuit breaker (open-closed, in test isolated or racked-in position, with/without auxiliary power supply).

An internal electronic circuit powers the unit for approximately 3 consecutive hours only for reading and configuring data operations.

In proportion to the amount of use, the battery life decreases if the SACE PR120/B accessory is also used to perform the "COMMAND" menu functions (Trip test, Auto test).



1SUC20089F003

### SACE TT1 test unit

The SACE TT1 unit allows tripping of the PR111/P-A trip units to be checked and tests tripping of the opening solenoid.

The device is powered by a 12V replaceable battery.



1SUC20089F003

### SACE PR010/T test and configuration unit

The SACE PR010/T unit is an instrument capable of performing the Test, programming and parameter reading functions for the trip units equipping SACE Emax low-voltage power circuit breakers.

The test function in particular involves the following units:

- PR111/P-A (all versions)
- PR112/P-A (all versions)
- PR113/P-A (all versions)

while the parameter programming and reading functions concern the range of PR112/P-A and PR113/P-A trip units.

All of the functions mentioned can be carried out "on board" by connecting the SACE PR010/T unit to the front multi-pin connector on the various trip units. Special interfacing cables supplied with the unit ensure this connection.

The human-machine interface takes the form of a touch pad and multi-line alphanumeric display.

The unit also has two LEDs to indicate the following respectively:

- **POWER-ON** and **STAND BY**
- state of battery charge.



1SUC20089F003



## Accessories for trip units

Two different types of test are available: automatic (for PR111/P-A, PR112/P-A and PR113/P-A) and manual.

By connecting to a PC (using the disk supplied by ABB SACE), it is also possible to update the SACE PR010/T unit software, thereby upgrading the test unit to the development of new products.

It is also possible to store the most interesting test results in the unit itself, and send a report to the personal computer with the following information:

- type of protection tested
- threshold selected
- curve selected
- phase tested
- test current
- estimated trip time
- measured trip time
- test results.

At least 5 complete tests can be stored in the memory. The report downloaded onto a PC allows creation of an archive of tests carried out on the installation.

In automatic mode, the SACE PR010/T unit is capable of testing the following with the PR112/P-A and PR112/PD-A range:

- protection functions L, S, I,
- G protection function with internal transformer,
- G protection function with toroid on the transformer star center,
- monitoring of correct microprocessor operation.

The following are also tested with the PR113/P-A and PR113/PD-A trip units:

- overvoltage protection function OV,
- undervoltage protection function UV,
- residual voltage protection function RV,
- phase unbalance protection function U.

The same tests can be repeated manually for PR111/P-A and PR112/P-A.

The SACE PR010/T unit is portable and runs on rechargeable batteries and/or with an external power supply (always supplied) with a rated voltage of 100-240V AC/12V DC.

The standard version of the SACE PR010/T unit includes:

- SACE PR010/T test unit complete with rechargeable batteries
- SACE TT1 test unit
- 100 - 240V AC/12V DC external power supply with cord
- cables to connect the unit and connector
- cable to connect the unit and computer (RS232 serial )
- user manual and disk containing application software
- plastic suitcase.

### SACE PR020/K signaling unit

The SACE PR020/K signaling unit can convert the digital signals supplied by the PR112-A and PR113-A trip units (in version P or PD) into electrical signals by means of normally open electrical contacts.

The unit is connected to the protection trip unit by means of a dedicated serial line over which all of the information about the activation status of the protection functions flows. The corresponding power contacts are closed based on this information.

In particular, the following signals/contacts are available for the PR112/P-A and PR112/PD-A trip units:

- overload pre-alarm L
- timing and trip of protections L, S and G
- protection I trip
- timing and over-temperature threshold exceeded ( $T > 85\text{ }^{\circ}\text{C}$ )
- two load control contacts (connection and disconnection of a load, or disconnection of two loads)
- trip unit trip
- communication fault on a serial line (connecting the protection and signaling units).

With the PR113/P-A and PR113/PD-A trip units in standard configuration, tripping of the phase unbalance protection is also indicated in addition to the signals listed above.

Setting a dip-switch allows up to seven signal contacts to be freely configured, including: directional protection D trip, UV and OV undervoltage and overvoltage trip, reverse power RP trip, and others.

Two contacts available on the SACE PR020/K unit (load control) can pilot a circuit breaker shunt trip or closing coil. These contacts allow various applications, including load control, alarms, signals and electrical locks.

The alarm signal remains active throughout the overload, until any trip unit trip. The trip signals of the protections remain active during the timing phase, and even after trip unit trip. Pressing the Reset pushbutton resets the status of all signals.

The unit also contains ten LEDs to visually signal the following information:

- "Power ON": auxiliary power supply present
- "TX (Int Bus)": flashing synchronized with the communication activity with the Internal Bus
- eight LEDs associated with the internal contacts

The table below indicates the characteristics of the signaling relays available in the SACE PR020/K unit.

Auxiliary power supply	24 V DC $\pm$ 20%
Maximum ripple	5%
Rated power @ 24 V	4.4 W

Characteristics of the signaling relays	
Type	Monostable STDP
Maximum switching power (resistive load)	100 W/1250 VA
Maximum switching voltage	130 V DC/250 V AC
Maximum switching current	5 A
Interrupting capacity (resistive load)	
@ 30V DC	3.3 A
@ 250V AC	5 A
Contact/coil insulation	2000 V eff (1 min@ 50 Hz)



1998  
1999  
2000  
2001  
2002  
2003  
2004  
2005  
2006  
2007  
2008  
2009  
2010  
2011  
2012  
2013  
2014  
2015  
2016  
2017  
2018  
2019  
2020  
2021  
2022  
2023  
2024  
2025

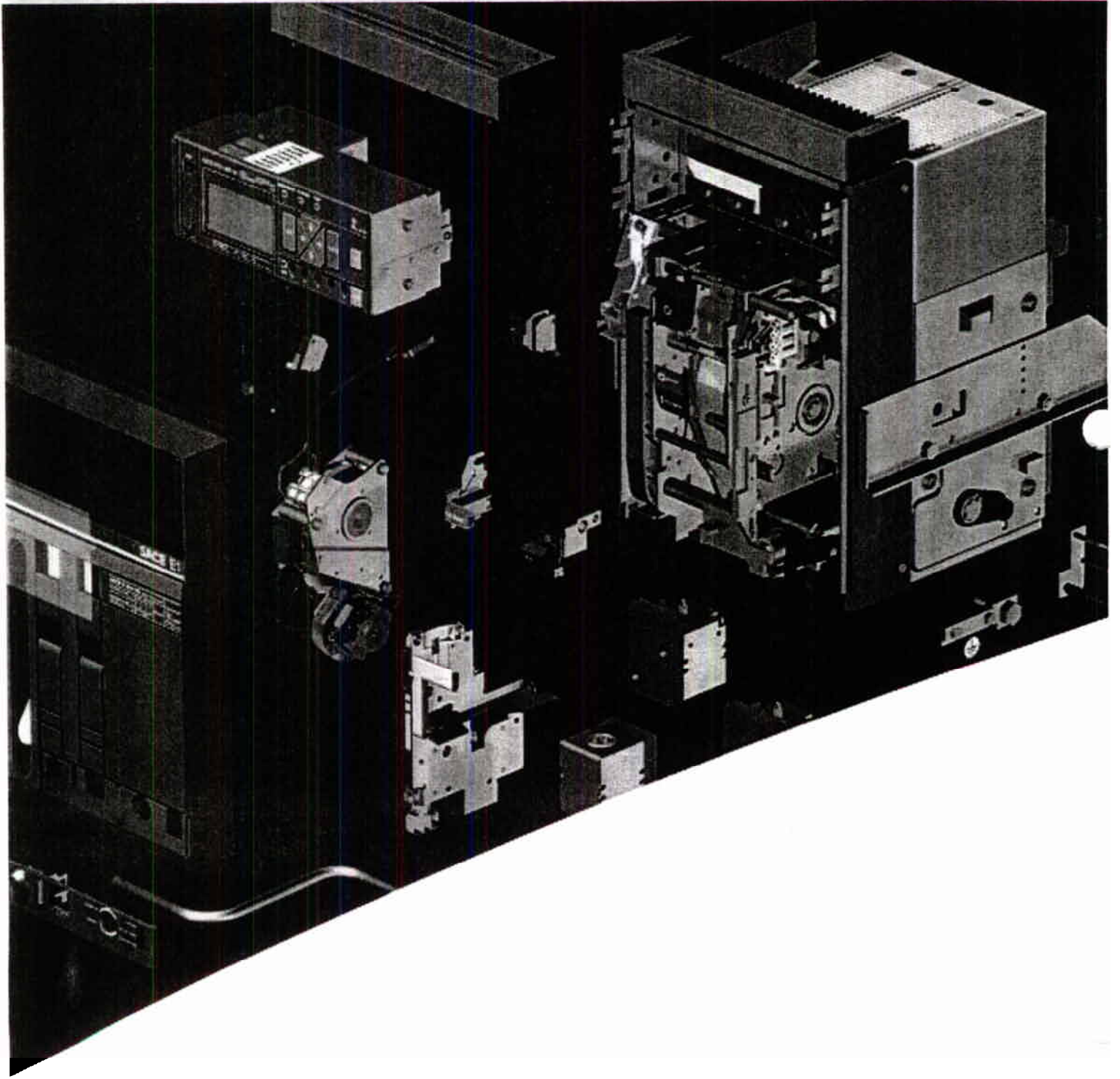
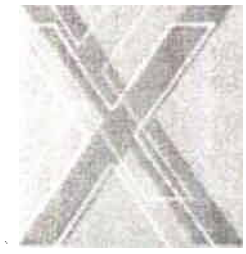
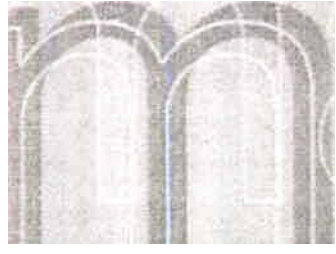



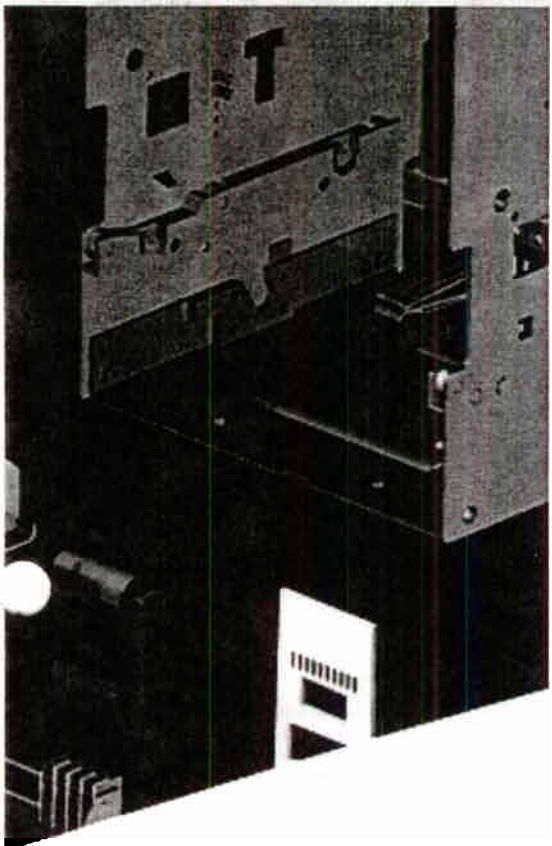

## Contents

Functions of the accessories .....	4/2
Accessories supplied as standard .....	4/3
Accessories supplied on request .....	4/4
Shunt trip and closing coils .....	4/6
Undervoltage release .....	4/8
Gearmotor for the automatic charging of closing springs .....	4/10
Signaling of trip units tripped .....	4/11
Auxiliary contacts .....	4/12
Transformers and operation counters .....	4/15
Mechanical safety locks .....	4/16
Transparent protective covers .....	5/18
Interlock between circuit breakers .....	4/19
Automatic transfer switch - ATS010 (IEC only) .....	4/22
Spare parts .....	4/25





## Functions of the accessories

The table that follows lists a few functions that can be obtained by selecting the appropriate accessories from among those provided. Several of the functions listed can be needed at the same time depending on how the circuit breaker is used. See the related section for a detailed description of the individual accessories.

Function	Components
Remote control	<ul style="list-style-type: none"> <li>• Shunt trip</li> <li>• Closing coil</li> <li>• Gearmotor for the automatic charging of closing springs</li> </ul>
Remote signaling or actuation of automatic functions depending on the state (open-closed) or position (racked-in, test isolated, racked-out) of the circuit breaker.	<ul style="list-style-type: none"> <li>• Auxiliary contacts of open-closed circuit breaker</li> <li>• Auxiliary contacts of circuit breaker racked-in, test isolated, racked-out (draw out circuit breaker only)</li> <li>• Contact for electrical signaling of trip units tripped</li> <li>• Contact for signaling undervoltage release de-energized</li> <li>• Contact for signaling springs charged</li> </ul>
Remote opening for various needs, including: <ul style="list-style-type: none"> <li>– manual emergency control</li> <li>– opening dependent on the tripping of other protective interrupting devices or system automation needs.</li> </ul> Examples: <ul style="list-style-type: none"> <li>– circuit breakers on L.V. side of parallel transformers that must open automatically when the M.V. side device opens.</li> <li>– automatic opening for control by external relay (undervoltage, residual current, etc.)</li> </ul>	<ul style="list-style-type: none"> <li>• Opening or undervoltage release</li> </ul>
Automatic opening of the circuit breaker for undervoltage (for example, when switching asynchronous motors)	<ul style="list-style-type: none"> <li>• Instantaneous or time delay undervoltage release NOTE: The time-delay device is recommended when unwarranted tripping due to temporary voltage drops is to be avoided (for functional or safety reasons)</li> <li>• Contact for signaling undervoltage release energized</li> </ul>
Increased degree of protection	<ul style="list-style-type: none"> <li>• IP54 door protection</li> </ul>
Mechanical safety locks for maintenance or functional requirements for interlocking two or more circuit breakers	<ul style="list-style-type: none"> <li>• Key lock in open position</li> <li>• Padlock device in open position</li> <li>• Key lock and padlocks in: racked-in, test isolated, racked-out position</li> </ul>
Automatic switching of power supplies	<ul style="list-style-type: none"> <li>• Mechanical interlock between two or three circuit breakers</li> <li>• Automatic transfer switch - ATS010 (IEC only)</li> </ul>

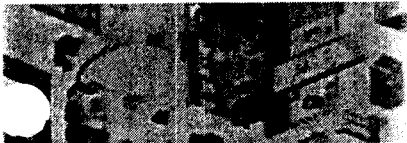

---

## Accessories supplied as standard

---

The following standard accessories are supplied depending on the circuit breaker version:

---

### Fixed circuit breaker:

- flange for switchboard compartment door (IP30)
- support for service releases
- four auxiliary contacts for electrical signaling of circuit breaker open/closed (for automatic circuit breakers only)
- terminal box for connecting outgoing auxiliaries
- horizontal rear terminals
- lifting plate

---

### Draw out circuit breaker:

- flange for switchboard compartment door
- support for service releases
- four auxiliary contacts for electrical signaling of circuit breaker open/closed (for automatic circuit breakers only)
- sliding contacts for connecting outgoing auxiliaries
- horizontal rear terminals
- anti-racking-in lock for circuit breakers with different continuous current ratings
- racking-out crank handle
- lifting plate
- anti-racking-out device when springs are charged (fail safe)

## Accessories supplied on request



### The ranges

#### Circuit breaker version

- 1a) Shunt trip/closing coil (YO/YC) and second shunt trip (YO2)
- 1b) SOR test unit
- 2a) Undervoltage release (YU)
- 2b) Time-delay device for undervoltage release (D)
- 3) Gearmotor for the automatic charging of the closing springs (M)
- 4a) Mechanical signaling of trip unit tripped
- 4b) Electrical and mechanical signaling of trip unit tripped
- 5a) Electrical signaling of circuit breaker open/closed <sup>(1)</sup>
- 5b) Electrical signaling of circuit breaker racked-in/test isolated/racked-out/
- 5c) Contact signaling closing springs charged
- 5d) Contact signaling undervoltage release de-energized (C. Aux YU)
- 6a) Current transformer for neutral conductor outside circuit breaker
- 6b) Homopolar toroid for the main power supply grounding conductor (star center of the transformer)
- 7) Mechanical operation counter
- 8a) Lock in open position
- 8b) Circuit breaker lock in racked-in/racked-out/test isolated position
- 8c) Accessories for lock in racked-out/test isolated
- 8d) Accessory for shutter padlock device
- 8e) Mechanical lock for compartment door
- 8f) Anti-racking-out device when the springs are charged (FAIL SAFE)
- 9a) Protection for opening and closing pushbuttons
- 9b) IP54 door protection
- 10) Interlock between circuit breakers
- 11) Automatic transfer switch - ATS010

#### LEGEND

- Accessory on request on fixed circuit breaker or moving part
- ▣ Accessory on request on cradle
- Accessory on request on moving part

Automatic circuit breakers		Switch-disconnectors (MS)	
Fixed	Draw out	Fixed	Draw out
■	■	■	■
■	■	■	■
■	■	■	■
■	■	■	■
■	■	■	■
■	■	■	■
■	■	■	■
■	■	■	■
■	■	■	■
■	■	■	■
■	■	■	■
■	■	■	■
■	■	■	■
■	■	■	■
■	■	■	■
■	■	■	■
■	■	■	■
■	■	■	■
■	■	■	■
■	■	■	■
■	■	■	■
■	■	■	■
■	■	■	■
■	■	■	■
■	■	■	■
■	■	■	■
■	■	■	■
■	■	■	■
■	■	■	■
■	■	■	■
■	■	■	■

(1) For automatic circuit-breakers, four auxiliary contacts to electrically signal circuit-breaker open/closed are included in the supply as standard.



# Shunt trip and closing coils

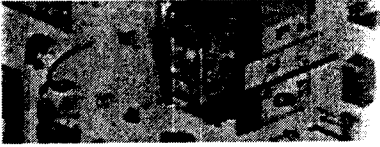

## 1a) Shunt trip/closing coil (YO/YC) and second shunt trip (YO2)

(1) The minimum impulse current duration time in instantaneous service must be 100 ms

(2) If the shunt trip is permanently connected to the power supply, wait at least 30 ms before sending the command to the closing coil.

Allows remote control opening or closing of the switchgear depending on the installation position and connection of the releases in the support. The release can be used for either of these applications. Given the characteristics of the circuit breaker operating mechanism, opening (with the circuit breaker closed) is always possible, while closing is only possible when the closing springs are charged. The release can operate with either direct current or alternating current. This release provides instantaneous operation <sup>(1)</sup>, but can be supplied permanently <sup>(2)</sup>. Some installations require very high safety in controlling remote circuit breaker opening. The control and shunt trip circuits in particular must be duplicated. To meet these needs, SACE Emax circuit breakers can be equipped with a second shunt trip, fitted with a special support to hold it, that can house the standard closing coils and shunt trips.

The housing of the second shunt trip is that of the undervoltage release, which is therefore incompatible with this type of installation. The special support, including the second shunt trip, is installed in place of the standard support.

The technical specifications of the second shunt trip remain identical to those of the standard shunt trip.

When used as a permanently supplied closing coil, it is necessary to momentarily de-energize the closing coil in order to close the circuit breaker again after opening (in fact, the circuit breaker operating mechanism is fitted with an anti-pumping device).

Reference figure in circuit diagrams: YO (4-5) - YC (2-3) - YO2 (8)

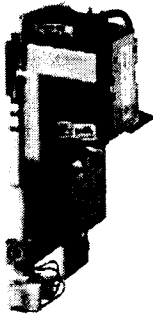

1S0C20013P0001

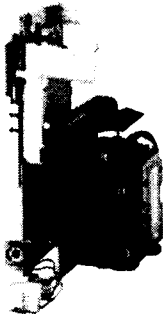

1S0C20013P0001

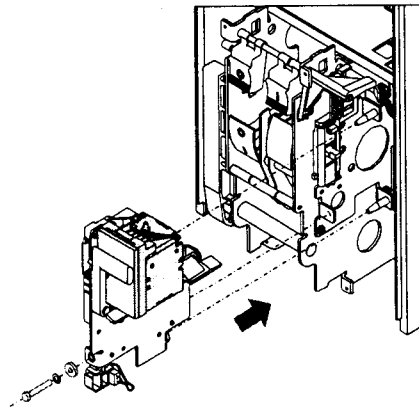

1S0C20013P0001

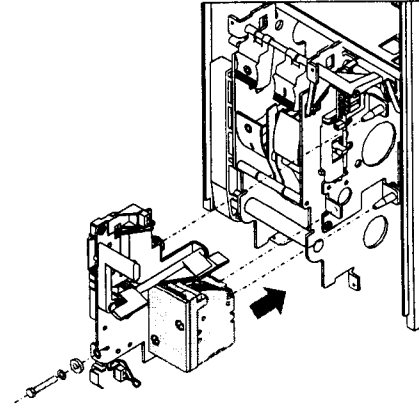

1S0C20013P0001

Characteristics		
Power supply (Un):	24 V DC	125-127 V AC/DC
	30 V AC/DC	220-240 V AC/DC
	48 V AC/DC	250 V AC/DC
	60 V AC/DC	380-400 V AC
	110-120 V AC/DC	440-480 V AC
Operating limits:	(YO-YO2): 70% ... 110% Un	
	(YC): 85% ... 110% Un	
Inrush power (Ps):	DC = 200 W	
Inrush time ~100 ms	AC = 200 VA	
Continuous power (Pc):	DC = 5 W	
	AC = 5 VA	
Opening time (YO- YO2):	(max) 60 ms	
Closing time (YC)	(max) 80 ms	
Insulation voltage:	2500 V 50 Hz (for 1 min)	

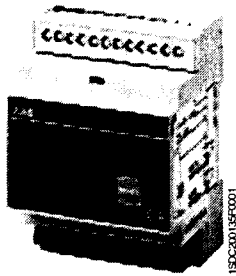

## 1b) SOR Test Unit

The SOR control and monitoring Test Unit helps ensure that the various versions of SACE Emax shunt trips are running smoothly, for high reliability in controlling circuit breaker opening.

Under particularly severe operating conditions or simply for remote control of the circuit breaker, the shunt trip is widely used as an accessory for the SACE Emax series of power circuit breakers.

Maintenance of all functions of this accessory is a necessary condition to guarantee a high level of safety in the installation: this means there is the need to have a device available which cyclically checks correct operation of the release, signaling any malfunctions.

The SOR control and monitoring Test Unit ensures continuity of shunt trips with a rated operating voltage between 24 V and 250 V (AC and DC), as well as the functions of the opening coil electronic circuit.

Continuity is checked cyclically with an interval of 20s between tests.

The unit has optic signals via LEDs on the front, which provide the following information:

- POWER ON: power supply present
- YO TESTING: test in progress
- TEST FAILED: signal following a failed test or lack of auxiliary power supply
- ALARM: signal following three failed tests.

Two relays with one change-over are also available on board the unit, which allow remote signaling of the following two events:

- failure of a test (resetting takes place automatically when the alarm stops )
- failure of three tests (resetting only occurs by pressing the manual RESET on the front of the unit)

There is also a manual RESET button on the front of the unit.

Characteristics	
Auxiliary power	24 V ... 250 V AC/DC
Maximum interrupted current	6 A
Maximum interrupted voltage	250V AC

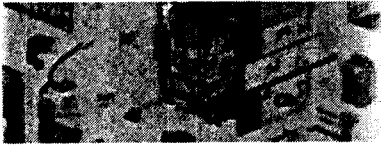

# Undervoltage release

## 2a) Undervoltage release (YU)

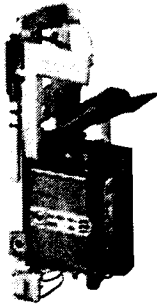

1SDC200136F001

The undervoltage release opens the circuit breaker when there is a significant voltage drop or power failure. It can be used for remote release (using normally closed pushbuttons), for a lock on closing or for monitoring the voltage in the primary and secondary circuits. The power supply for the release is therefore obtained on the supply side of the circuit breaker or from an independent source. The circuit breaker can be closed only when the release is supplied (closing is mechanically locked). The release can operate with either direct current or alternating current.

The circuit breaker is opened with release power supply voltages of 30-60%  $U_n$ .

The circuit breaker can be closed with a release power supply voltage of 85%  $U_n$ .

It can be fitted with a contact to signal when the undervoltage release is energized (C. aux YU) (see accessory 5d).

Reference figure in circuit diagrams: YU (6)

**Note**

With the undervoltage release, the use of the anti-racking-out device is not allowed when the springs are charged (fail safe).

**Characteristics**

Power supply ( $U_n$ ):	24 V DC	125-127 V AC/DC
	30 V AC/DC	220-240 V AC/DC
	48 V AC/DC	250 V AC
	60 V AC/DC	380-400 V AC
	110-120 V AC/DC	440-480 V AC
Inrush power ( $P_s$ ):	DC = 200 W	
	AC = 200 VA	
Continuous power ( $P_c$ ):	DC = 5 W	
	AC = 5 VA	
Opening time (YU)	30 ms	
Insulation voltage:	2500 V 50 Hz (for 1 min)	

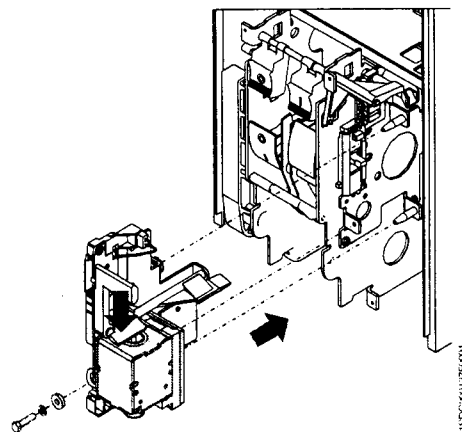

1SDC200137F001

4



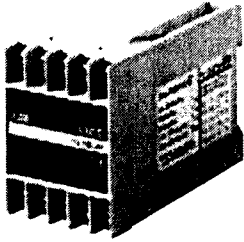

19CC20014P0001

## 2b) Time-delay device for undervoltage release (D)

The undervoltage release can be combined with an electronic time-delay device for installation outside the circuit breaker, allowing delayed release tripping with preset and adjustable times. Use of the delayed undervoltage release is recommended to prevent tripping when the power supply network for the release can be subject to brief voltage drops or power supply failures.

Closing of the circuit breaker is prevented when it is not supplied.

The time-delay device must be used with an undervoltage release with the same operating voltage.

*Reference figure in circuit diagrams: YU +D (7)*

Characteristics	
Power supply (D):	24-30 V DC
	48 V AC/DC
	60 V AC/DC
	110-127 V AC/DC
	220-250 V AC/DC
Adjustable opening time (YU+D):	0,5-1-1,5-2-3 s





## Gearmotor for the automatic charging of closing springs

### 3) Gearmotor for the automatic charging of closing springs (M)



1SCC200148P0001

Automatically charges the closing springs of the circuit breaker operating mechanism. The geared motor immediately recharges the closing springs after closing the circuit breaker.

The closing springs can, however, be charged manually (using the relative operating mechanism lever) in the event of a power supply failure or during maintenance work.

It is always supplied with a limit contact and microswitch for signaling that the closing springs are charged (see accessory 5c).

Reference figure in circuit diagrams: M (1)

Characteristics	
Power supply	24-30 V AC/DC
	48-60 V AC/DC
	100-130 V AC/DC
	220-250 V AC/DC
Operating limits:	85%...110% $U_n$
Inrush power ( $P_s$ ):	DC = 500 W
	AC = 500 VA
Rated power ( $P_n$ ):	DC = 200 W
	AC = 200 VA
Inrush time	0,2 s
Charging time:	4-5 s
Insulation voltage:	2500 V 50 Hz (for 1 min)

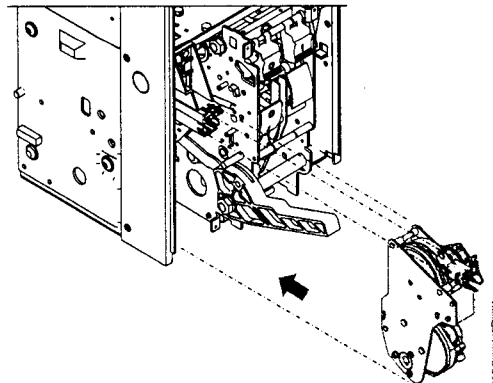

1SCC200148P0001



## Signal for trip units tripped

### 4) Mechanical and electrical signaling of trip units tripped

The following signals are available after the trip unit has tripped:

#### 4a) Mechanical signaling of trip units tripped

Where the circuit breaker is open following operation of the trip units, this can be signaled visually on the operating mechanism, moving the release tripped pushbutton out. The circuit breaker can only be closed again by resetting the pushbutton to its normal position.

Reference figure in circuit diagrams: S51 (12)

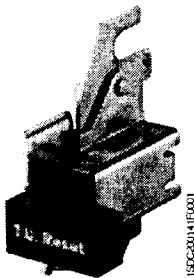

1SDC200141F0001

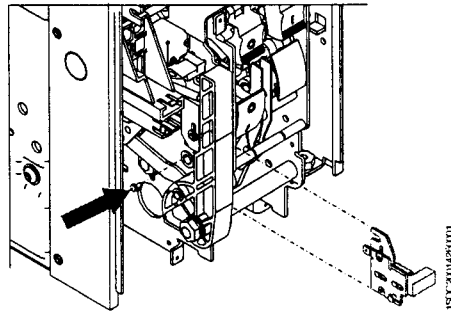

1SDC200141F0001

4

#### 4b) Electrical and mechanical signaling of trip units tripped

Allows visual signaling on the operating mechanism (mechanical) and remote signaling (electrical by means of changeover switch) that the circuit breaker is open following operation of the trip units. The mechanical signaling pushbutton must be rearmed to reset the circuit breaker.

SACE PR112 and PR113 trip units are already equipped with an internal overcurrent signaling contact.

Reference figure in circuit diagrams: S51 (12)



1SDC200141F0001

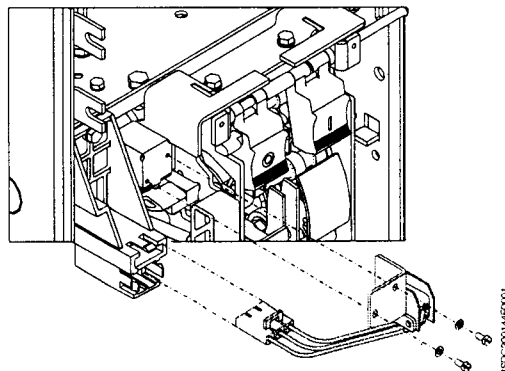

1SDC200141F0001

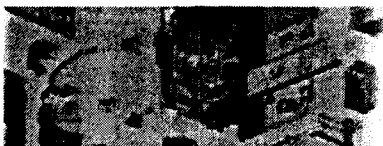

## Auxiliary Contacts

### 5) Auxiliary contacts

Auxiliary contacts are available installed on the circuit breaker, which enable signaling of the circuit breaker status.

Characteristics		
Un	In max	T
125 V DC	0,3 A	10 ms
250 V DC	0,15 A	
Un	In max	cosφ
250 V AC	5 A	0,3

The versions available are as follows:

#### 5a) Electrical signaling of circuit breaker open/closed

It is possible to have electrical signaling of the status (open/closed) of the circuit breaker using 4, 10 or 15 auxiliary contacts.

The auxiliary contacts have the following configurations:

- 4 open/closed contacts (2 normally open + 2 normally closed)
- 10 open/closed contacts (5 normally open + 5 normally closed); not available when the SACE PR112 or SACE PR113 trip units are required
- 15 supplementary open/closed contacts for installation outside the circuit breaker.

The basic configuration described above can be modified by the user for normally open or normally closed indication by repositioning the faston connector on the microswitch.

*Reference figures in circuit diagrams: Q/1-10 (21-22)*

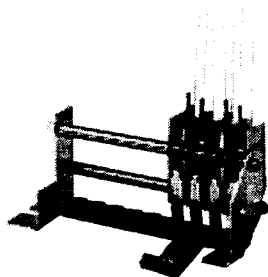

1SXC20014P0001

1SXC20014P0001

### 5b) Electrical signaling of circuit breaker racked-in/test isolated/racked-out

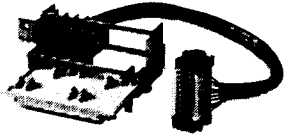

150CC20014970001

In addition to mechanical signaling of the circuit breaker position, it is also possible to obtain electrical signaling using 5 or 10 auxiliary contacts which are installed on the cradle.

It is only available for draw out circuit breakers, for installation on the cradle.

The auxiliary contacts take on the following configurations:

- 5 contacts; set comprising 2 contacts for racked-in signal, 2 contacts for racked-out signal, and 1 contact to signal the test isolated position (main pliers isolated, but sliding contacts connected).
- 10 contacts; set comprising 4 contacts for racked-in signal, 4 contacts for racked-out signal, and 2 contacts to signal the test isolated position (main clamps isolated, but sliding contacts connected).

Reference figures in circuit diagrams:

S75I (31-32)

S75T (31-32)

S75E (31-32)

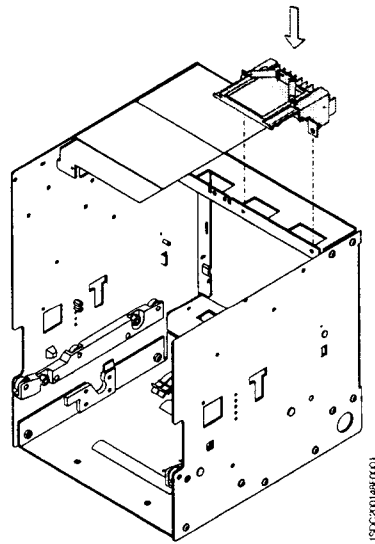

150CC20014970001

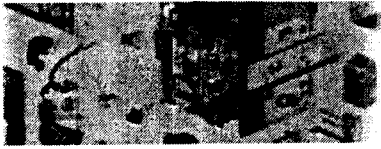

## Auxiliary Contacts

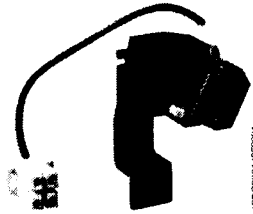

1SDC200145P001

### 5c) Contact for signaling closing springs charged

This is made up of a microswitch that allows remote signaling of the status of the circuit breaker operating mechanism closing springs (always supplied with the spring charging geared motor).

Reference figure in circuit diagrams: S33 M/2 (11)

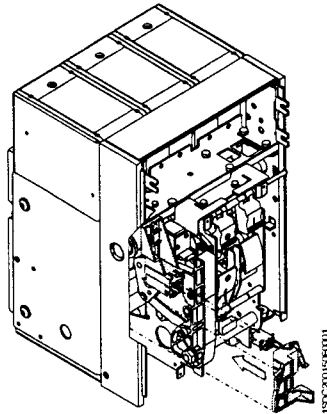

1SDC200156P001

4

### 5d) Contact signaling undervoltage release de-energized (C.aux YU)

The undervoltage releases can be fitted with a contact (normally closed or open as preferred) for signaling undervoltage release energized, to remotely signal the status of the undervoltage release.

Reference figure in circuit diagrams: (12)

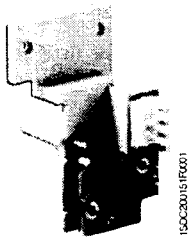

1SDC200157P001

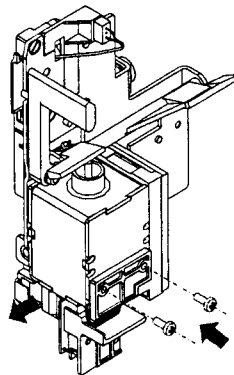

1SDC200156P001



## Transformers and operation counters

### 6a) Current transformer for neutral conductor outside circuit breaker

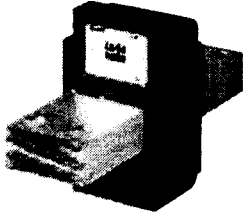

150C20154F001

For three-pole circuit breakers only, this allows protection of the neutral by connection to the trip unit. Supplied on request.

Reference figure in circuit diagrams: T1/N-UI/N (51-52)

### 6b) Homopolar toroid for the main power supply grounding conductor (star center of the transformer)



150C20154F001

SACE PR112 and PR113 microprocessor-based electronic trip units can be used in combination with an external toroid located on the conductor, which connects the star center of the MV/LV transformer (homopolar transformer) to ground. In this case, the ground protection is defined as Source Ground Return.

The homopolar transformer is available in four different versions in terms of continuous current rating (but keeping the same overall dimensions in any case).

Reference figure in circuit diagrams: T1/O (51-52)

Characteristics				
Rated current	100 A	250 A	400 A	800 A

### 7) Mechanical operation counter

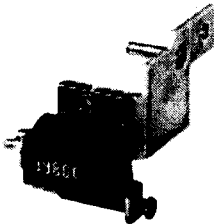

150C20154F001

This is connected to the operating mechanism by means of a simple lever mechanism, and indicates the number of mechanical operations carried out by the circuit breaker.

The count is shown on the front of the circuit breaker.

150C20154F001



## Mechanical locks

### 8) Mechanical locks

#### 8a) Lock in open position

Several different mechanisms are available which allow the circuit breaker to be locked in the open position.

These devices can be controlled by:

- Key: a special circular lock with different keys (for a single circuit breaker) or the same keys (for several circuit breakers). In the latter case, up to four different key numbers are available.
- Padlocks: up to 3 padlocks (not supplied):  $\varnothing$  4 mm.
- Key for Kirk lock (only preset)

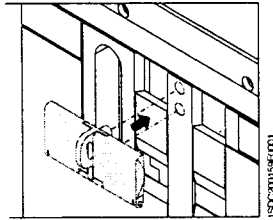
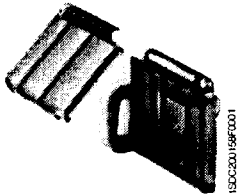
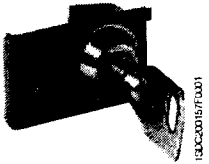

#### 8b) Circuit breaker lock in racked-in/test isolated/racked-out position

This device can be controlled by a special circular lock with different keys (for a single circuit breaker) or the same keys (for several circuit breakers - up to four different key numbers available) and padlocks (up to 3 padlocks, not supplied -  $\varnothing$  4 mm). It is only available for draw out circuit breakers, to be installed on the moving part.

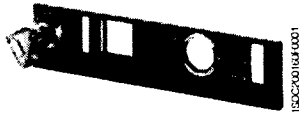

1SUC201158F001

#### 8c) Accessories for lock in test isolated/racked-out position

In addition to the circuit breaker lock in racked-in/test isolated/racked-out position, this allows the circuit breaker to be locked only in the racked-out or test isolated positions.

It is only available for draw out circuit breakers, to be installed on the moving part.

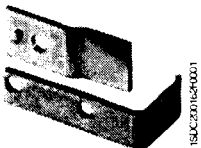



#### 8d) Accessory for shutter padlock device

Allows the shutters (installed on the cradle) to be padlocked in the closed position.

It is only available for draw out circuit breakers, to be installed on the cradle.

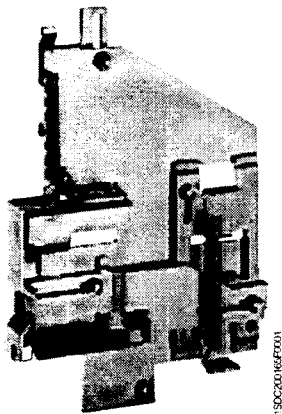
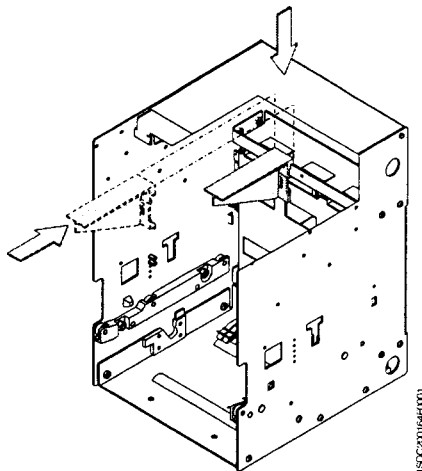
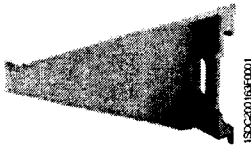

#### 8e) Mechanical lock for compartment door

Stops the compartment door from being opened when the circuit breaker is closed (and circuit breaker racked-in for draw out circuit breakers) and prevents the circuit breaker from closing when the compartment door is open.

#### 8f) Anti-racking-out device when the springs are charged (FAIL SAFE)

Prevents the moving part of the draw out version circuit breaker from being racked out of the cradle when the springs are charged.

**Note**

This accessory, always supplied with the draw out version circuit breaker, is an alternative to the undervoltage release.



## Transparent protective covers

### 9) Transparent protective covers

#### 9a) Protective cover for opening and closing pushbuttons

These protections are fitted over the opening and closing pushbuttons, preventing the relative circuit breaker operations unless a special tool is used.

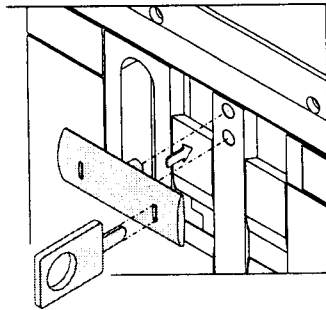

#### 9b) IP54 door protection (NEMA 3/S/13)

This is a transparent plastic protective cover which completely protects the front panel of the circuit breaker, with IP54 degree of protection. Mounted on hinges, it is fitted with a key lock.

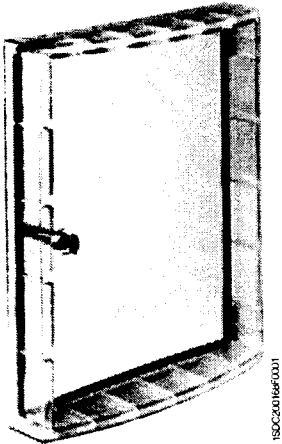

1SXC201167F001

# Interlock between circuit breakers

## 10) Mechanical interlock

This mechanism creates a mechanical interlock between two or three circuit breakers (even different models and in any fixed/draw out version) using a flexible cable. The electrical diagram for electrical switching by means of a relay (to be provided by the customer) is supplied with the mechanical interlock. The circuit breakers can be installed vertically or horizontally.

Four types of mechanical interlocks are available:

- Type A: between 2 circuit breakers (power supply + emergency power supply)
- Type B: between 3 circuit breakers (2 power supplies + emergency power supply)
- Type C: between 3 circuit breakers (2 power supplies + bus-tie)
- Type D: between 3 circuit breakers (3 power supplies/one single closed circuit breaker)

**Note**

See the chapters "Overall dimensions" and "Electrical diagrams" for information about dimensions (fixed and draw out versions) and settings.

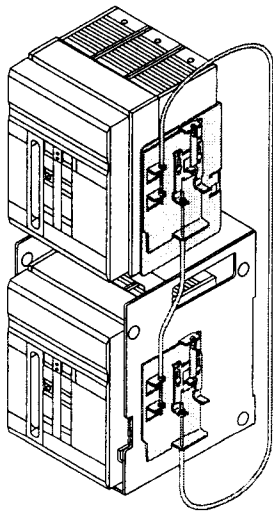
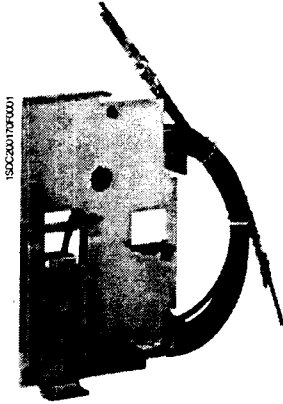

Vertical interlock

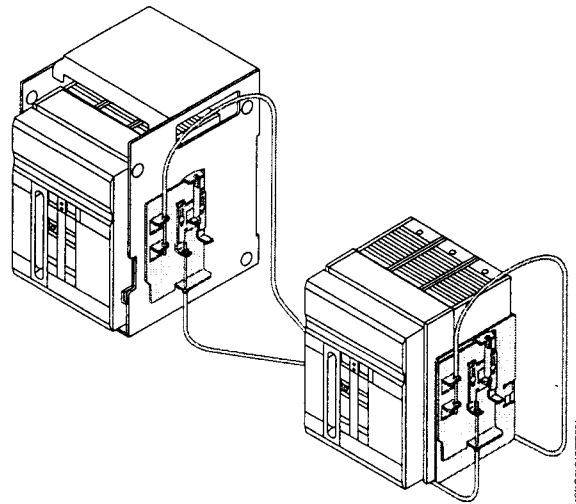

Horizontal interlock

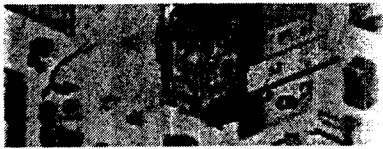

# Interlock between circuit breakers

The possible mechanical interlocks are shown below, depending on whether 2 or 3 circuit breakers (any model in any version) are used in the switching system.

Type of interlock	Typical circuit	Possible interlocks																								
<b>Type A</b> <b>Between two circuit breakers</b> One normal power supply and one emergency power supply	<p>O = Circuit breaker open I = Circuit breaker closed</p>	Circuit breaker 1 can only be closed if 2 is open, and vice-versa. <table border="1"> <thead> <tr> <th>1</th> <th>2</th> </tr> </thead> <tbody> <tr> <td>O</td> <td>O</td> </tr> <tr> <td>I</td> <td>O</td> </tr> <tr> <td>O</td> <td>I</td> </tr> </tbody> </table>	1	2	O	O	I	O	O	I																
1	2																									
O	O																									
I	O																									
O	I																									
<b>Type B</b> <b>Between three circuit breakers</b> Two normal power supplies and one emergency power supply.	<p>O = Circuit breaker open I = Circuit breaker closed</p>	Circuit breakers 1 and 3 can only be closed if 2 is open. Circuit breaker 2 can only be closed if 1 and 3 are open. <table border="1"> <thead> <tr> <th>1</th> <th>2</th> <th>3</th> </tr> </thead> <tbody> <tr> <td>O</td> <td>O</td> <td>O</td> </tr> <tr> <td>I</td> <td>O</td> <td>O</td> </tr> <tr> <td>O</td> <td>O</td> <td>I</td> </tr> <tr> <td>I</td> <td>O</td> <td>I</td> </tr> <tr> <td>O</td> <td>I</td> <td>O</td> </tr> </tbody> </table>	1	2	3	O	O	O	I	O	O	O	O	I	I	O	I	O	I	O						
1	2	3																								
O	O	O																								
I	O	O																								
O	O	I																								
I	O	I																								
O	I	O																								
<b>Type C</b> <b>Between three circuit breakers</b> The two half-busbars can be supplied by a single transformer (bus-tie closed) or by both at the same time (bus-tie open)	<p>O = Circuit breaker open I = Circuit breaker closed</p>	One or two circuit breakers out of three can be closed at the same time. <table border="1"> <thead> <tr> <th>1</th> <th>2</th> <th>3</th> </tr> </thead> <tbody> <tr> <td>O</td> <td>O</td> <td>O</td> </tr> <tr> <td>I</td> <td>O</td> <td>O</td> </tr> <tr> <td>O</td> <td>I</td> <td>O</td> </tr> <tr> <td>O</td> <td>O</td> <td>I</td> </tr> <tr> <td>O</td> <td>I</td> <td>I</td> </tr> <tr> <td>I</td> <td>I</td> <td>O</td> </tr> <tr> <td>I</td> <td>O</td> <td>I</td> </tr> </tbody> </table>	1	2	3	O	O	O	I	O	O	O	I	O	O	O	I	O	I	I	I	I	O	I	O	I
1	2	3																								
O	O	O																								
I	O	O																								
O	I	O																								
O	O	I																								
O	I	I																								
I	I	O																								
I	O	I																								
<b>Type D</b> <b>Between three circuit breakers</b> Three power supplies (generators or transformers) on the same busbar, so parallel operation is not allowed	<p>O = Circuit breaker open I = Circuit breaker closed</p>	Only one of three circuit breakers can be closed. <table border="1"> <thead> <tr> <th>1</th> <th>2</th> <th>3</th> </tr> </thead> <tbody> <tr> <td>O</td> <td>O</td> <td>O</td> </tr> <tr> <td>I</td> <td>O</td> <td>O</td> </tr> <tr> <td>O</td> <td>I</td> <td>O</td> </tr> <tr> <td>O</td> <td>O</td> <td>I</td> </tr> </tbody> </table>	1	2	3	O	O	O	I	O	O	O	I	O	O	O	I									
1	2	3																								
O	O	O																								
I	O	O																								
O	I	O																								
O	O	I																								

4

---

---

The emergency power supply is usually installed to take over from the normal power supply in two instances:

- to supply safety services for people (e.g., hospital installations);
- to supply parts of installations which are essential for requirements other than safety (e.g., continuous-cycle industrial plants).

The range of accessories for SACE Emax circuit breakers includes solutions for a wide variety of different plant engineering requirements.

See the specific regulations regarding protections against overcurrents, direct and indirect contacts, and provisions to improve the reliability and safety of emergency circuits.

Switching from the normal to the emergency power supply can be carried out manually (locally or by remote control) or automatically.

To this end, the circuit breakers used for switching must be fitted with the accessories required to allow electric remote control and to provide the electrical and mechanical interlocks required by the switching logic.

These include:

- the shunt trip
- the closing coil
- the motor control
- the auxiliary contacts.

Switching can be automated by means of a special electronically-controlled relay circuit, to be installed by the customer (diagrams provided by ABB).

Mechanical interlocks between two or three circuit breakers are achieved using cables that can be applied to horizontally or vertically installed circuit breakers.



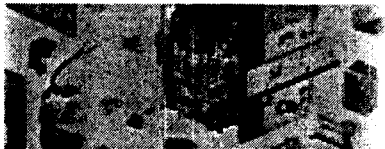

## Automatic transfer switch - ATS010 (IEC only)

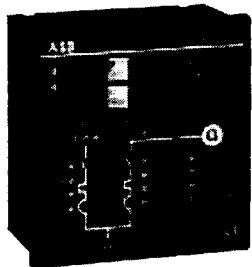

1SXC20017R0001

### 11) Automatic transfer switch - ATS010 (IEC only)

The ATS010 switching unit (Automatic Transfer Switch) is the new network-unit switching device offered by ABB. It is based on microprocessor technology in compliance with the major electromagnetic compatibility and environmental standards (EN 50178, EN 50081-2, EN 50082-2, IEC 68-2-1, IEC 68-2-2, IEC 68-2-3).

The device is able to manage the entire switching procedure between the normal line and emergency line circuit breakers automatically, allowing great flexibility of settings.

In case of an error in the normal line voltage, in accordance with the delays set, the normal line circuit breaker is opened, the generator started and the emergency line circuit breaker closed. Similarly, when the normal line returns to range, the reverse switching procedure is automatically controlled.

It is especially suited for use in all emergency power supply systems requiring a solution that is ready to install, easy to use and reliable.

Some of the main applications include: power supply for UPS (Uninterrupted Power Supply) units, operating theatres and primary hospital services, emergency power supply for civilian buildings, airports, hotels, data banks and telecommunication systems, and power supply of industrial lines for continuous processes.

The switching system consists of the ATS010 unit connected to two motor-driven and mechanically interlocked circuit breakers. Any of the circuit breakers in the SACE Emax series can be used. The built-in mains sensor of the SACE ATS010 device makes it possible to detect errors in the mains voltage. The three inputs can be directly connected to the three phases of the normal power supply line for networks with rated voltage up to 500V AC. Networks with a higher voltage require the insertion of voltage transformers (TV), setting a rated voltage for the device that matches their secondary voltage (typically 100V).

Two change-over contacts for each circuit breaker allow direct connection to the shunt trip and closing coils. The circuit breaker connection is completed by wiring the status contacts: Open/Closed, Relay tripped, Racked-in (for draw out/plug-in circuit breakers).

For this reason, apart from the mechanical interlock accessories, the following are provided on each circuit breaker connected to the ATS010 unit:

- spring charging motor,
- opening and closing coil,
- open/closed contact,
- racked-in contact (for draw out versions),
- signal and mechanical lock for protection relay tripped.

The ATS010 device is designed to ensure extremely high reliability for the system it controls. It contains various safety systems intrinsically related to software and hardware operation.

For software safety, a special logic prevents unwarranted operations, while a constantly operative watchdog system points out any microprocessor malfunctions by means of a LED on the front of the device.

Hardware safety allows integration of an electrical interlock by means of a power relay, making the use of an external electrical interlocking system superfluous. The manual selector on the front of the device can also control the entire switching procedure, even in the event of a microprocessor fault, by working electromechanically on the control relays.

### General specifications

Rated supply voltage (galvanically insulated from ground)	24V DC $\pm$ 20% 48V DC $\pm$ 10% (maximum ripple $\pm$ 5%)
Maximum absorbed power	5W at 24V DC 10W at 48V DC
Rated power (mains present and circuit breakers not controlled)	1,8W at 24V DC 4,5W at 48V DC
Operating temperature	-25 °C...+70 °C
Maximum humidity	90% without condensation
Storage temperature	-25 °C...+80 °C
Degree of protection	IP54 (front panel)
Dimensions [mm]	144 x 144 x 85
Weight [kg]	0.8

### Setting range for thresholds and times

Minimum voltage	Un Min	-5%...-30% Un
Maximum voltage	Un Max	+5%...+30% Un
Fixed frequency thresholds		10%...+10% fn
T1: opening delay of the normal line circuit breaker due to network error (CB-N)		
		0...32 s
T2: generator start-up delay due to network error		
		0...32 s
T3: stopping delay of the generator		
		0...254 s
T4: switching delay due to network stop		
		0...254 s
T5: closing delay of the emergency line circuit breaker after detecting the generator voltage (CB-E)		
		0...32 s

Rated voltage settings available 100, 115, 120, 208, 220, 230, 240, 277,  
347, 380, 400, 415, 440, 480, 500 V

### Operating sequence

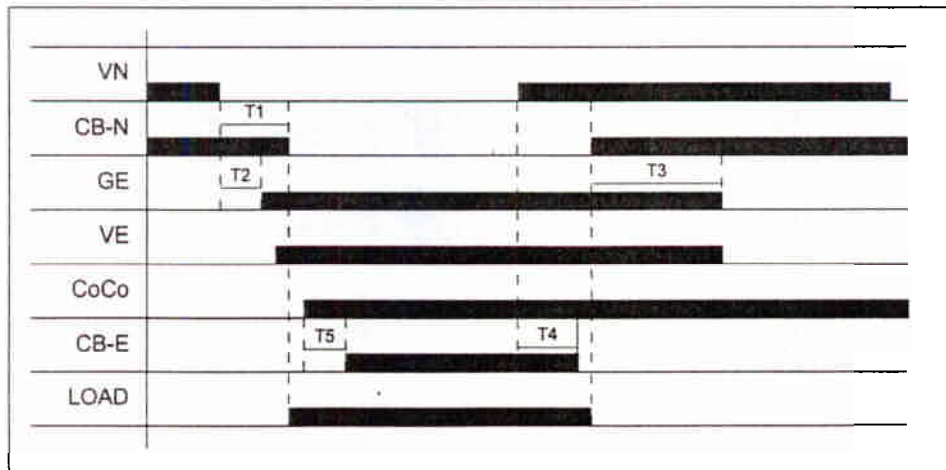

#### Caption

- VN** Mains voltage
- CB-N** Normal line circuit breaker closed
- GE** Generator
- VE** Emergency line voltage
- CoCo** Enable switching to emergency line
- CB-E** Emergency line circuit breaker closed
- LOAD** Disconnection of lower priority connected loads

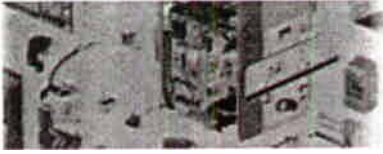

# Automatic transfer switch - ATS010

## Front panel

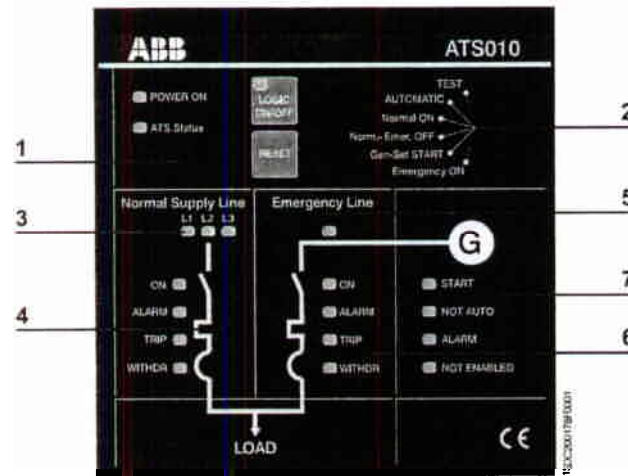

### Caption

- 1 Status of the ATS010 unit and logic
- 2 Operating mode selector
- 3 Normal line check
- 4 Normal line circuit breaker status
- 5 Voltage on the emergency line
- 6 Emergency line circuit breaker status
- 7 Generator status



## Side panel settings

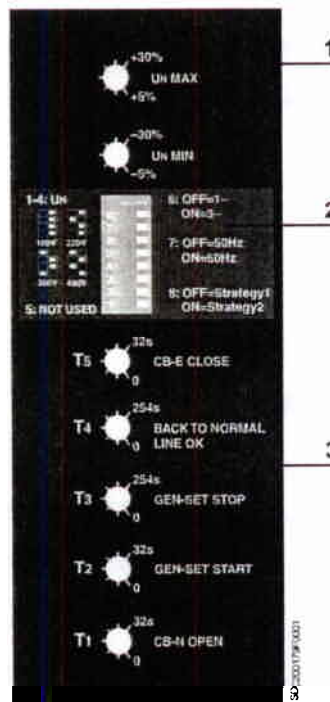

### Caption

- 1 Selectors to set the under- and overvoltage thresholds
- 2 Dip-switches to set:
  - rated voltage
  - normal single-phase or three-phase line
  - mains frequency
  - switching strategy
- 3 Switching delay time settings for T1... T5





---

## Spare parts

---

---

### Spare parts

The following spare parts are available:

- front shields and escutcheon plate
- opening solenoid for PR111, PR112 and PR113 trip units
- arcing chamber
- closing springs
- plier isolation contact for the cradle of the draw out circuit breaker
- grounding sliding contact (for draw out version)
- shutters for cradle
- complete pole
- operating mechanism
- connection cables between releases and current transformers
- transparent protective cover for releases
- SACE PR120/B power supply unit
- toolbox
- battery for SACE PR120/B power supply unit
- front escutcheon plate for Ronis key lock

For further details, request a copy of the ABB SACE spare parts catalog.





# Enax

**B**

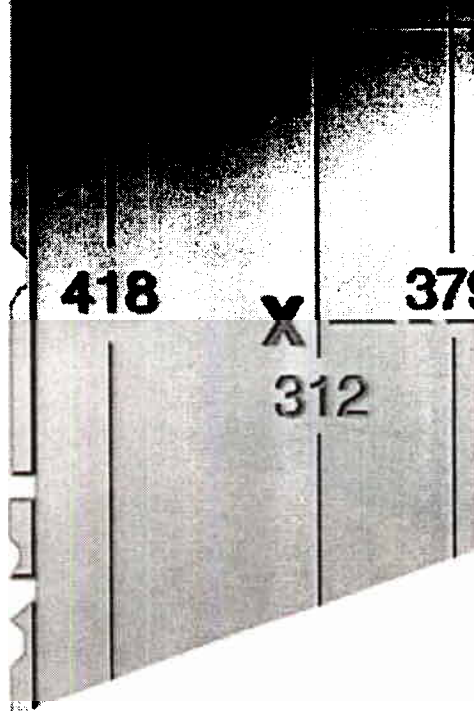
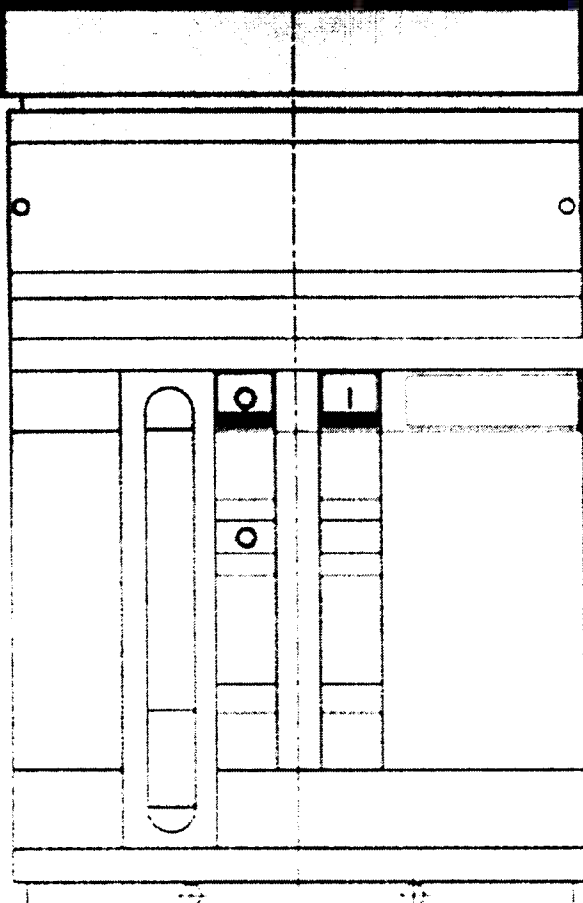

**C**

**Y**

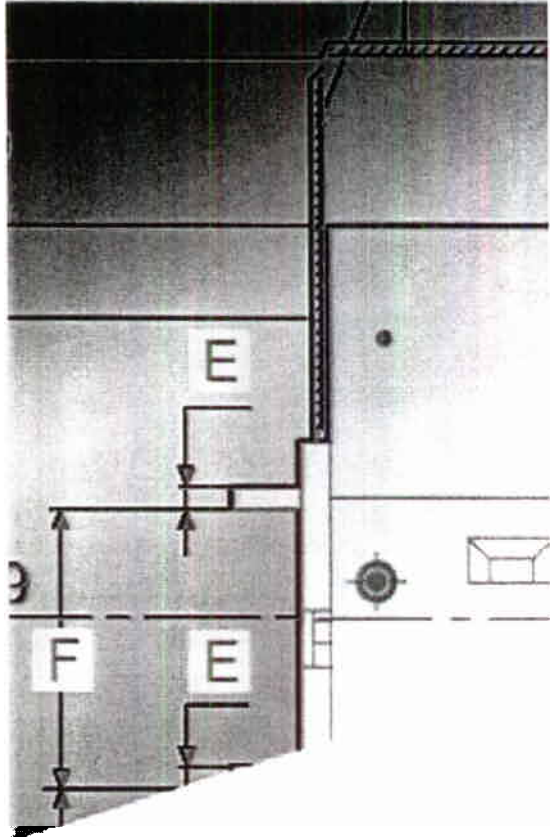

## Contents

Fixed circuit breaker .....	5/2
Draw out circuit breaker .....	5/7
Installation in switchboard .....	5/15
Mechanical interlock .....	5/16
Circuit breaker accessories .....	5/18



# Overall dimensions

## Fixed circuit breaker

**Basic version**  
**with horizontal**  
**rear terminals**

[mm/in]

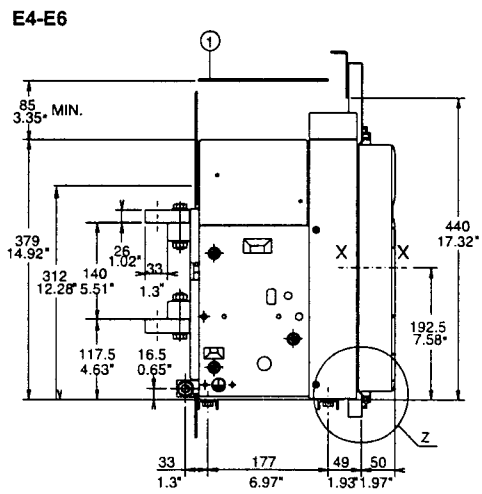
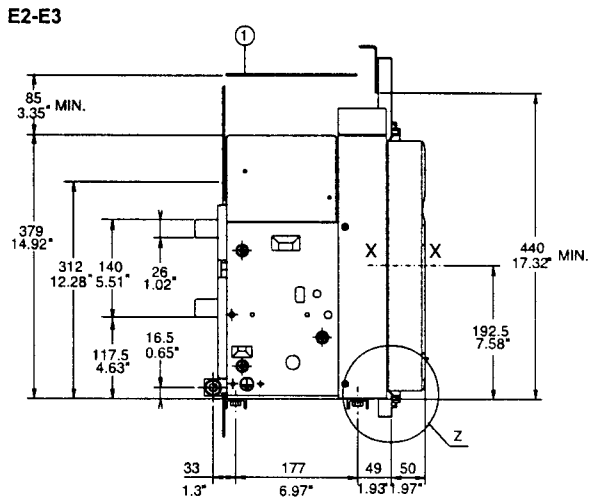
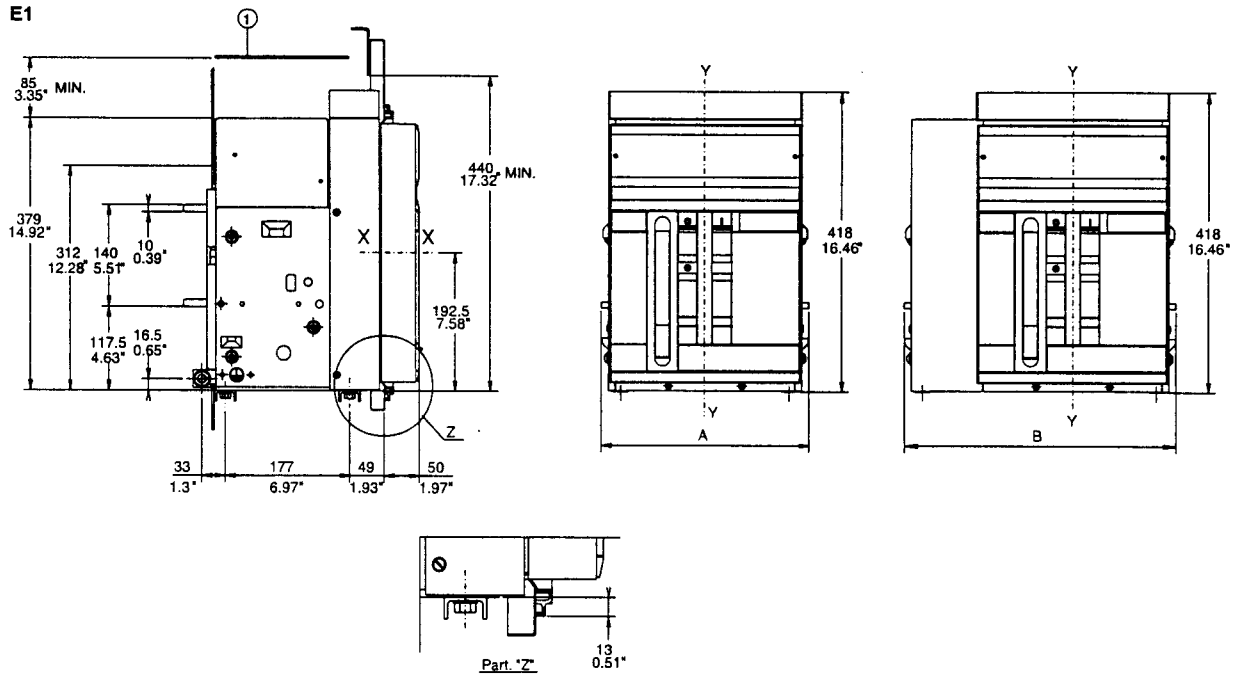

**Caption**

① Insulating wall or insulated metal wall

**A 3 Poles    B 4 Poles**

<b>E1-A</b>	296/11.65"	386/15.2"
<b>E2-A</b>	296/11.65"	386/15.2"
<b>E3-A</b>	404/15.91"	530/20.87"
<b>E4-A</b>	566/22.28"	656/25.83"
<b>E6-A</b>	782/30.79"	908/35.75"

E1 3 poles / E2 3 poles

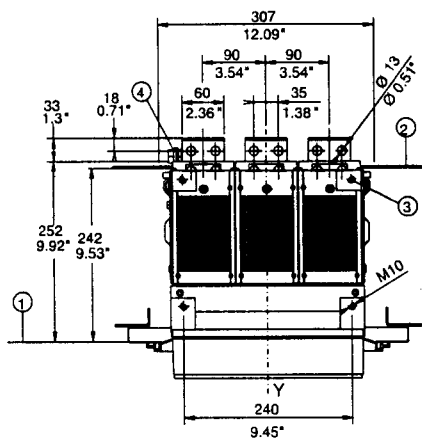

E1 4 poles / E2 4 poles

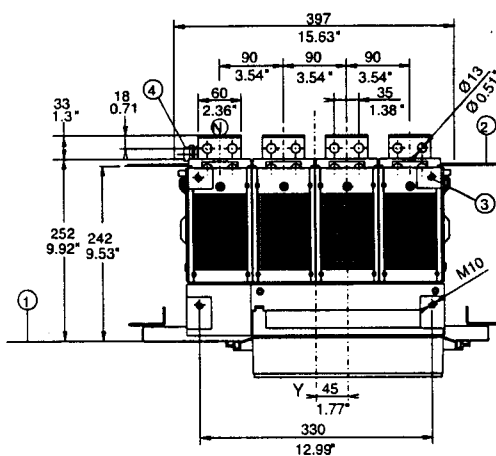

E3 3 poles

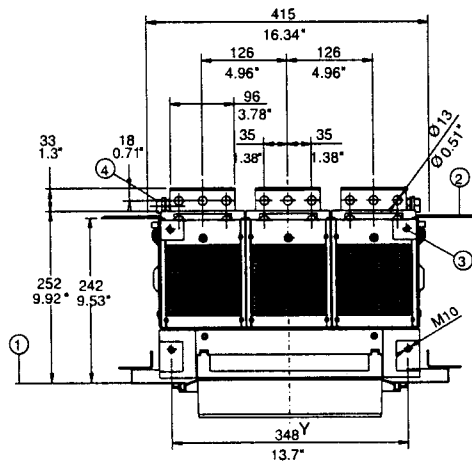

E3 4 poles

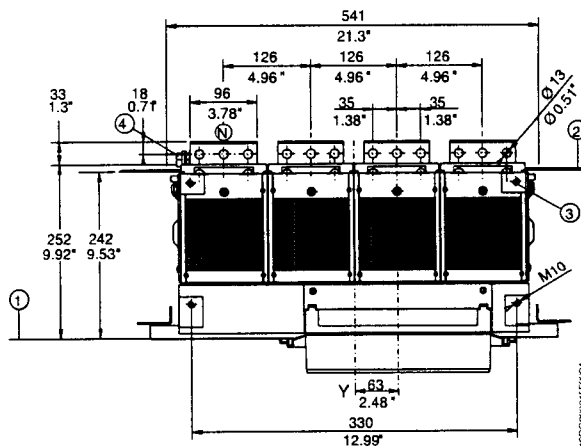

**Caption**

- ① Inside edge of compartment door
- ② Segregation (when provided)
- ③ M10 mounting holes for circuit breaker (included in the supply)
- ④ 1x M12 screw for earthing (included in the supply)

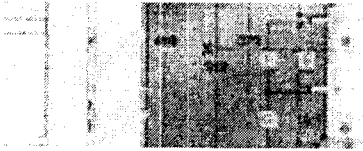

# Overall dimensions

## Fixed circuit breaker

### Basic version with horizontal rear terminals

[mm/in]

E4 3 poles

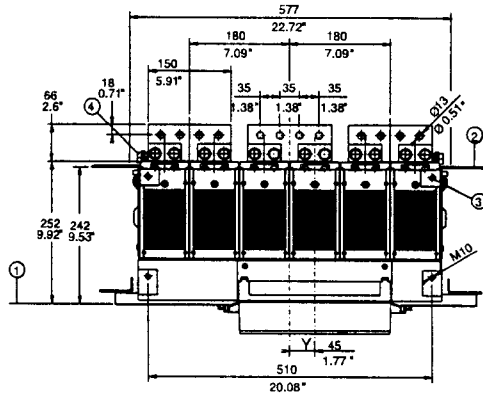

E4 4 poles

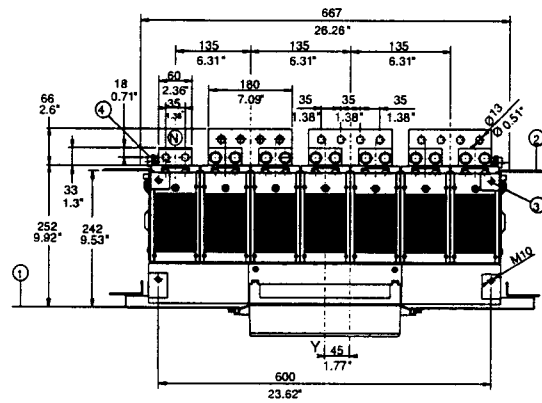

E6 3 poles

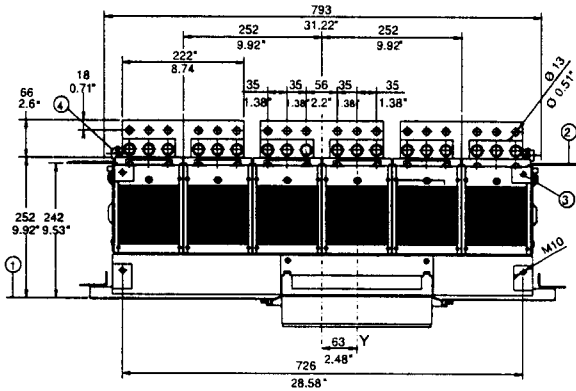

E6 4 poles

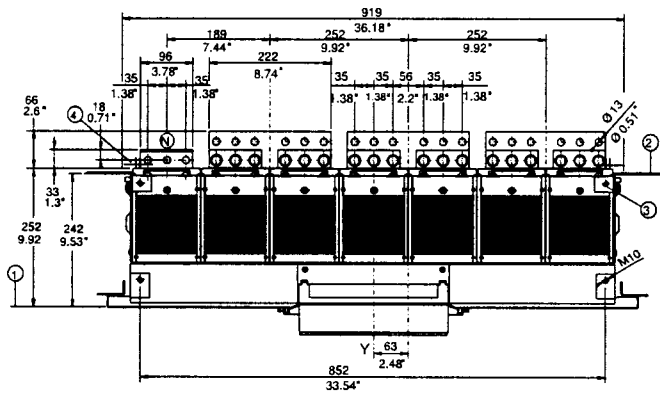

#### Caption

- ① Inside edge of compartment door
- ② Segregation (when provided)
- ③ M10 mounting holes for circuit breaker (included in the supply)
- ④ 1x M12 screw for earthing (included in the supply)

**Basic version**  
**with vertical**  
**rear terminals**

[mm/in]

E1

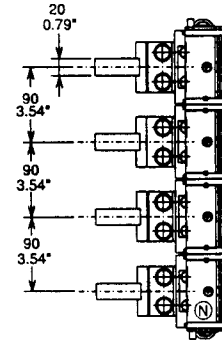

E2

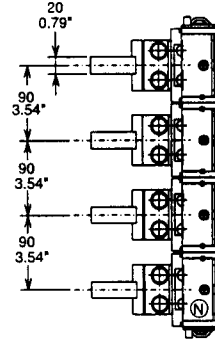

E3 1200+2000 A

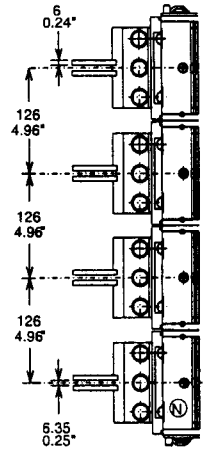

E1

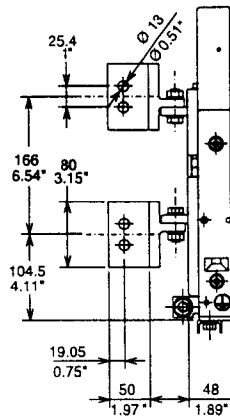

E2

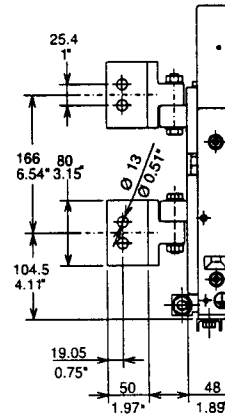

E3 1200+2000 A

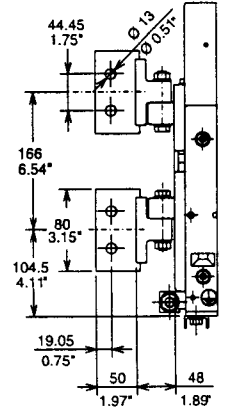



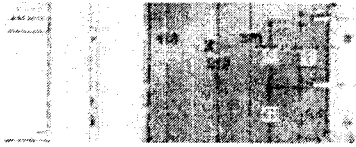

# Overall dimensions

## Fixed circuit breaker

Basic version  
with vertical  
rear terminals

[mm/in]

E3 2500 A

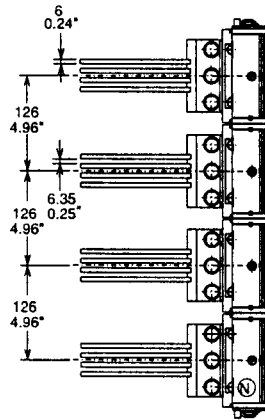

E4

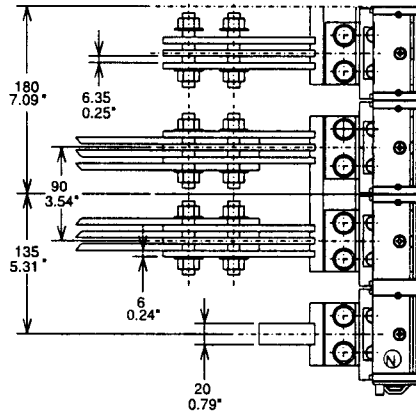

E6

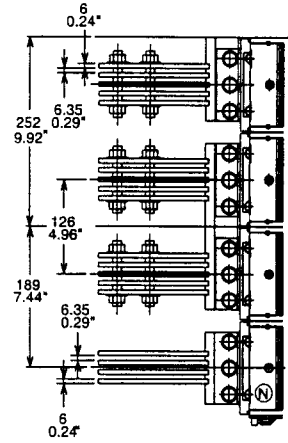

E3 2500 A

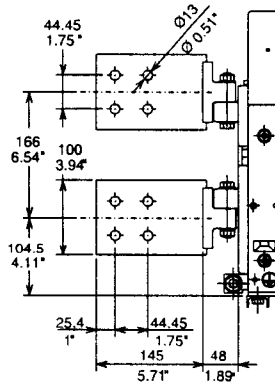

E4

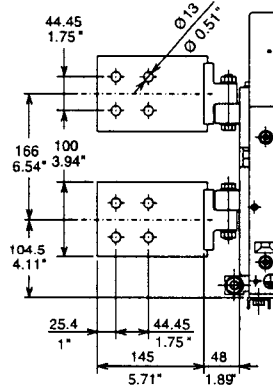

E6

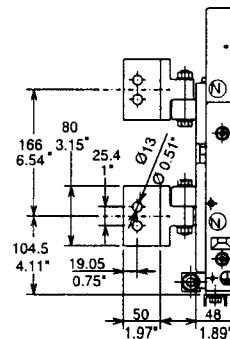
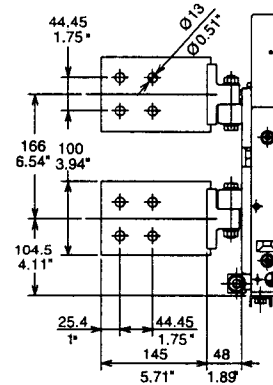

# Overall dimensions

## Draw out circuit breaker

### Basic version

[mm/in]

### with horizontal rear terminals

E1

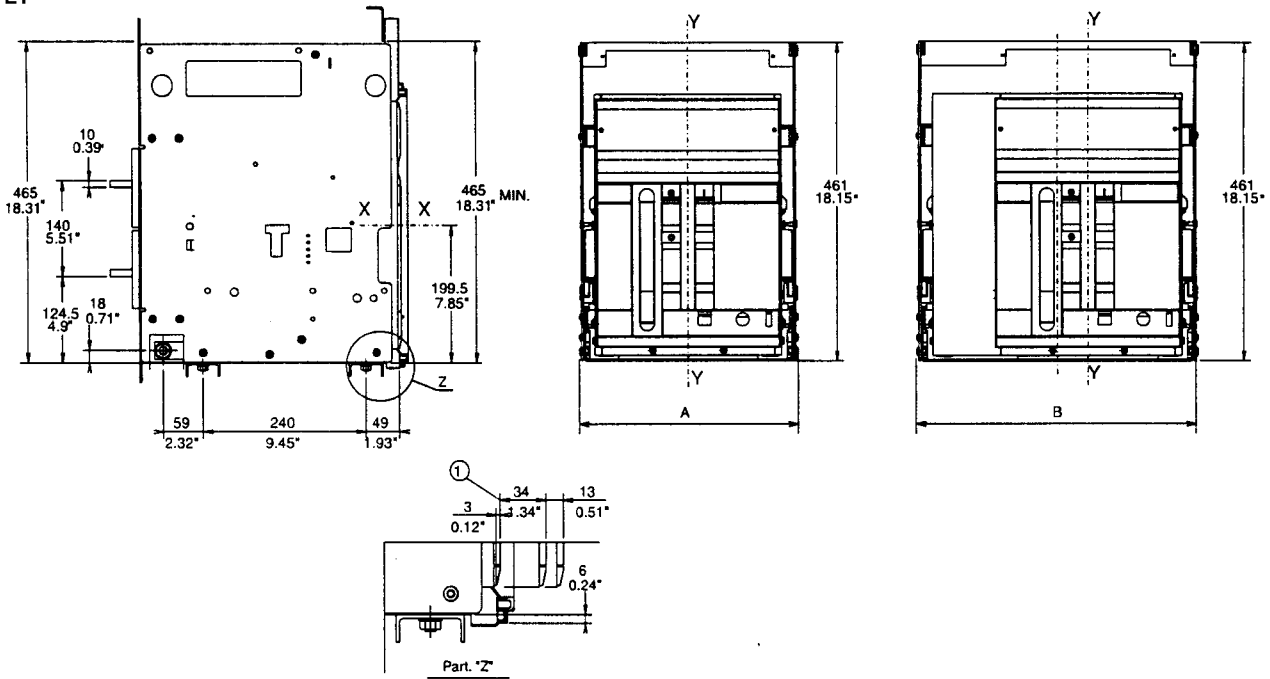

E2-E3-E4-E6

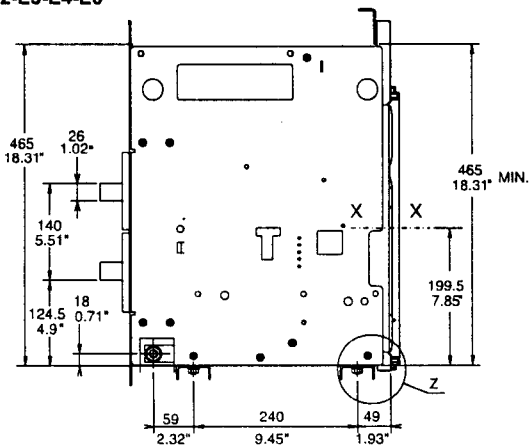

#### Caption

- ① Travel from connected for testing to isolated

	A 3 Poles	B 4 Poles
E1-A	324/12.76"	414/16.3"
E2-A	324/12.76"	414/16.3"
E3-A	432/17.01"	558/21.97"
E4-A	594/23.39"	684/26.93"
E6-A	810/31.89"	936/36.85"

# Overall dimensions

## Draw out circuit breaker

### Basic version with horizontal rear terminals

[mm/in]

E1 3 poles / E2 3 poles

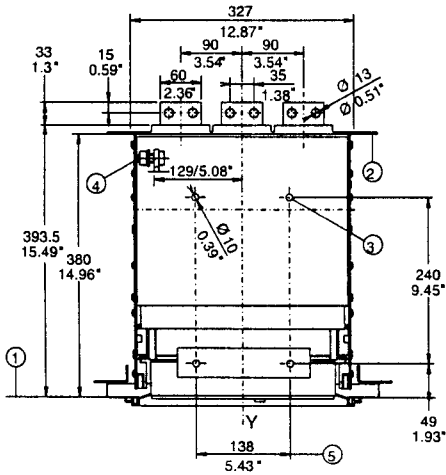

E1 4 poles / E2 4 poles

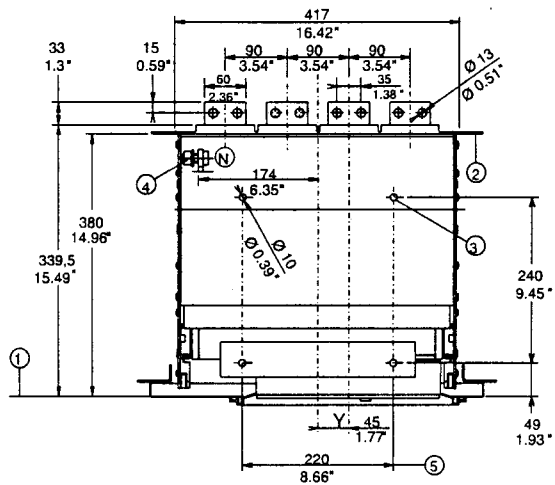

E3 3 poles

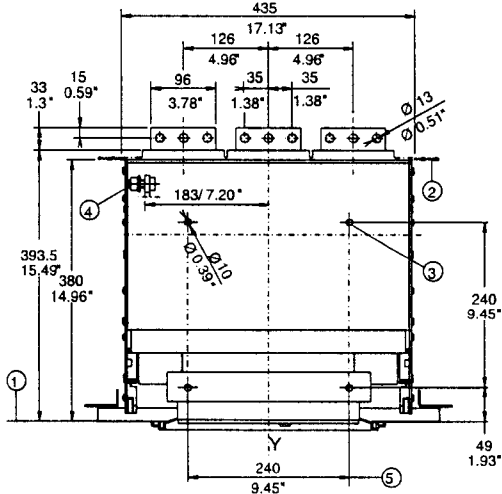

E3 4 poles

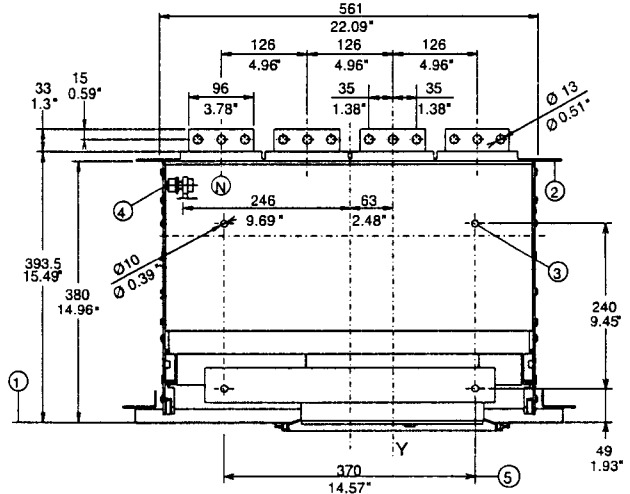

#### Caption

- ① Inside edge of compartment door
- ② Segregation (when provided)
- ③ M8 mounting holes for circuit breaker (included in the supply)
- ④ 1x M12 screws for earthing (included in the supply)
- ⑤ 4 holes for mounting fixed part (standard)

E4 3 poles

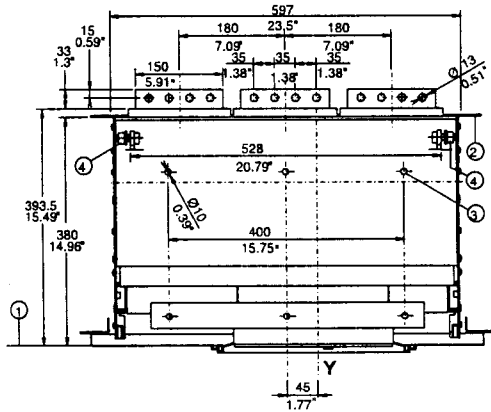

E4 4 poles

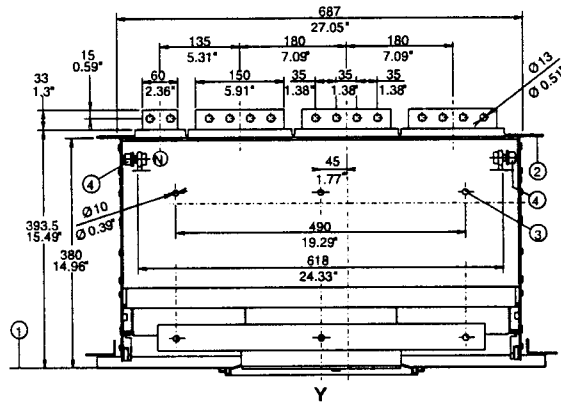

E6 3 poles

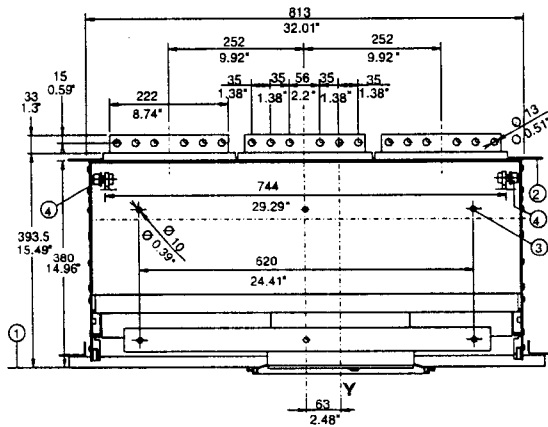

E6 4 poles

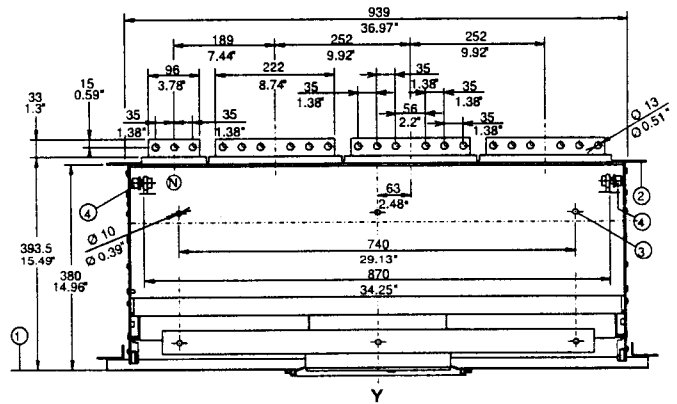

**Caption**

- ① Inside edge of compartment door
- ② Segregation (when provided)
- ③ M8 mounting holes for circuit breaker (included in the supply)
- ④ 1x M12 screw for earthing (included in the supply)

# Overall dimensions

## Draw out circuit breaker

Basic version  
with vertical  
rear terminals

[mm/in]

E1 3 poles / E2 3 poles

E1 4 poles / E2 4 poles

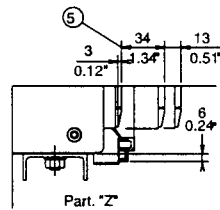
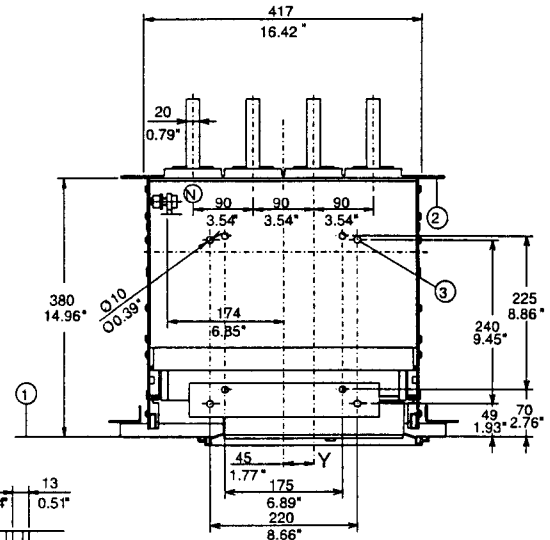
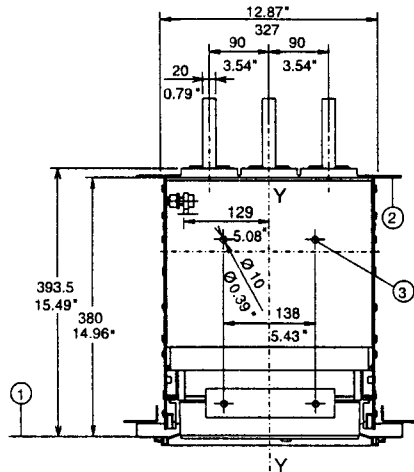

E1-E2

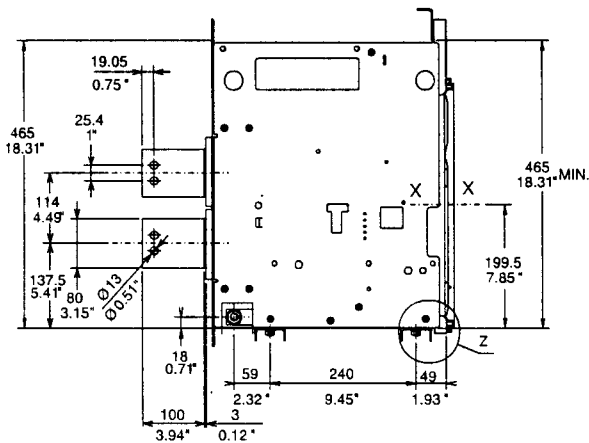

### Caption

- ① Inside edge of compartment door
- ② Segregation (when provided)
- ③ M8 mounting holes for circuit breaker (included in the supply)
- ⑤ Travel from connected for testing to isolated

[mm/in]

E3 3 poles 1200+2000 A

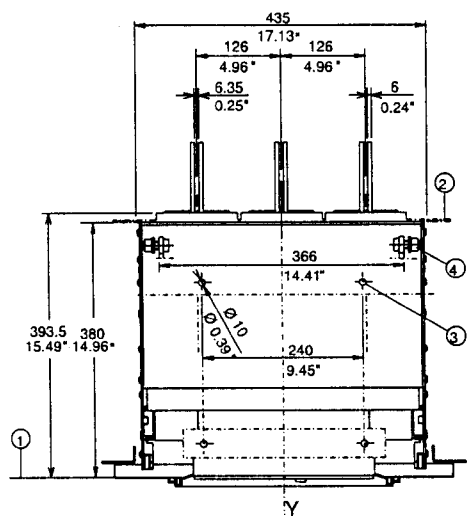

E3 4 poles 1200+2000 A

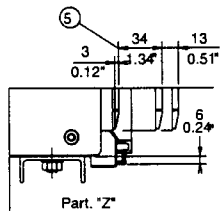
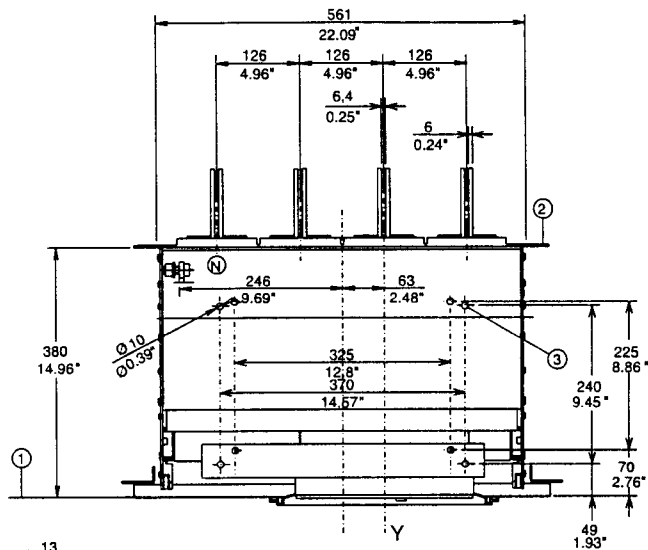

E3 1200+2000 A

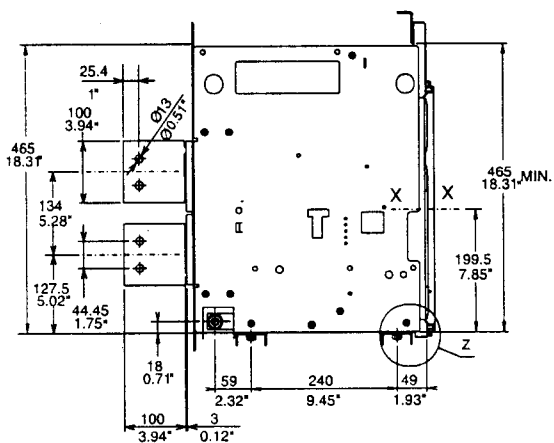

**Caption**

- ① Inside edge of compartment door
- ② Segregation (when provided)
- ③ M8 mounting holes for circuit breaker (included in the supply)
- ④ 2x M12 screws for earthing (included in the supply)
- ⑤ Travel from connected for testing to isolated



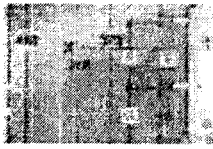

# Overall dimensions

## Draw out circuit breaker

Basic version

with vertical rear terminals

[mm/in]

E3 3 poles 2500 A

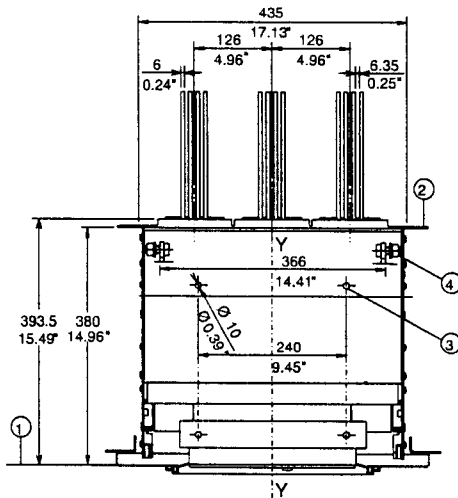

E3 4 poles 2500 A

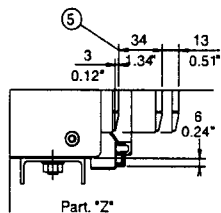
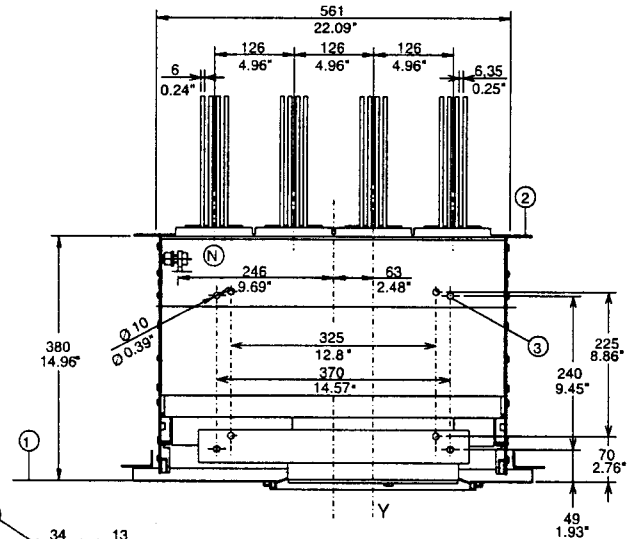

E3 2500 A

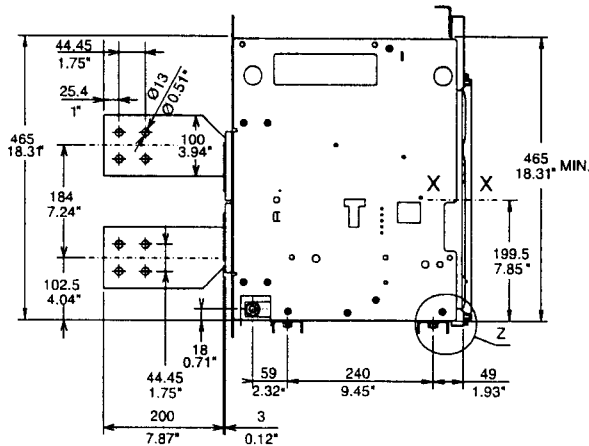

### Caption

- ① Inside edge of compartment door
- ② Segregation (when provided)
- ③ M8 mounting holes for circuit breaker (included in the supply)
- ④ 2x M12 screws for earthing (included in the supply)
- ⑤ Travel from connected for testing to isolated

E4 3 poles

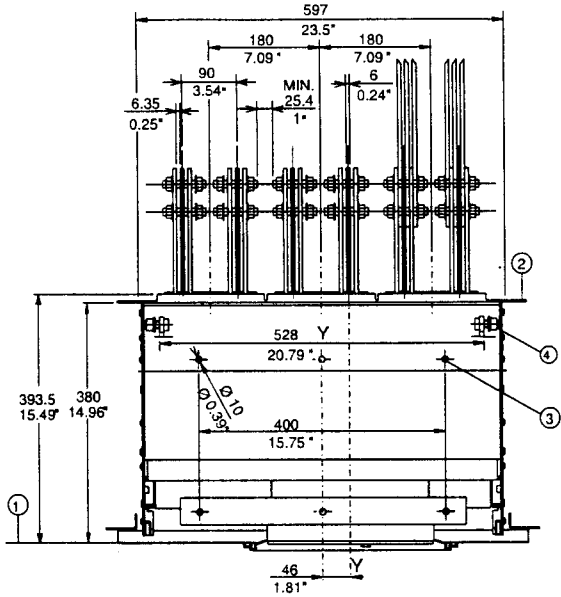

E4 4 poles

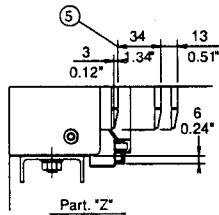
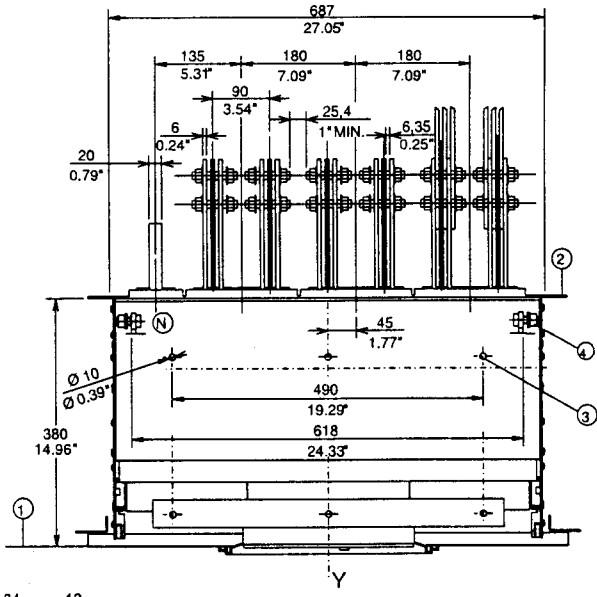

E4

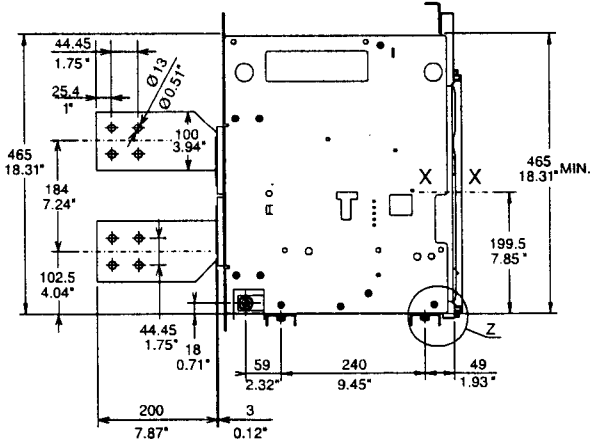

**Caption**

- ① Inside edge of compartment door
- ② Segregation (when provided)
- ③ M8 mounting holes for circuit breaker (included in the supply)
- ④ 2x M12 screws for earthing (included in the supply)
- ⑤ Travel from connected for testing to isolated



# Overall dimensions

## Draw out circuit breaker

### Basic version

### with vertical rear terminals

[mm/in]

#### E6 3 poles

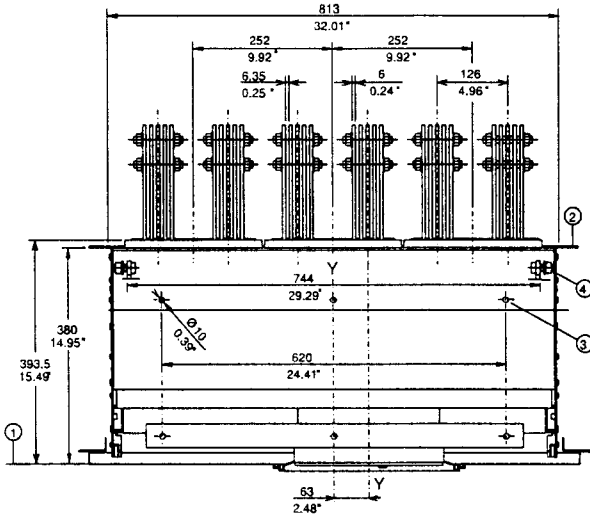

#### E6 4 poles

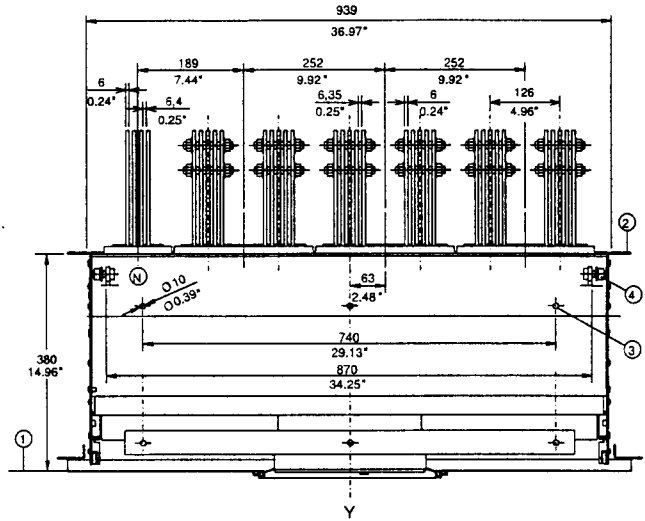

#### E6

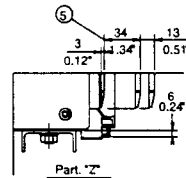
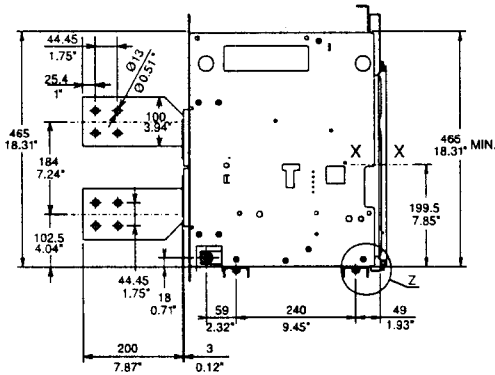

#### Caption

- ① Inside edge of compartment door
- ② Segregation (when provided)
- ③ M8 mounting holes for circuit breaker (included in the supply)
- ④ 2x M12 screws for earthing (included in the supply)
- ⑤ Travel from connected for testing to isolated

# Overall dimensions

## Installation in switchboard

[mm/in]

### Dimensions of compartment

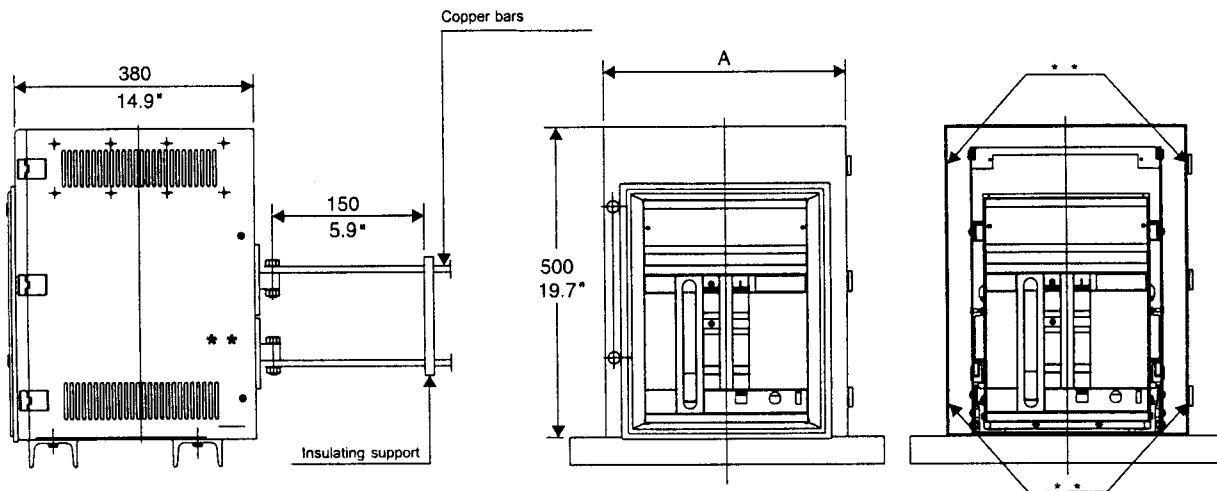

	A 3 Poles	A 4 Poles
<b>E1-A</b>	400/11.65"	490/19.30"
<b>E2-A</b>	400/15.7"	490/19.30"
<b>E3-A</b>	500/19.7"	630/24.82"
<b>E4-A</b>	700/25.7"	790/30.62"
<b>E6-A</b>	1000/39.3"	1130/44.52"

Suitable for continuous operation at 100% rating in a minimum cubicle space (see the table), with a ventilation of 48 (12x4) sq. in. side bottom and side top.

Refer to shop drawings for verification.

### Drilling of compartment door

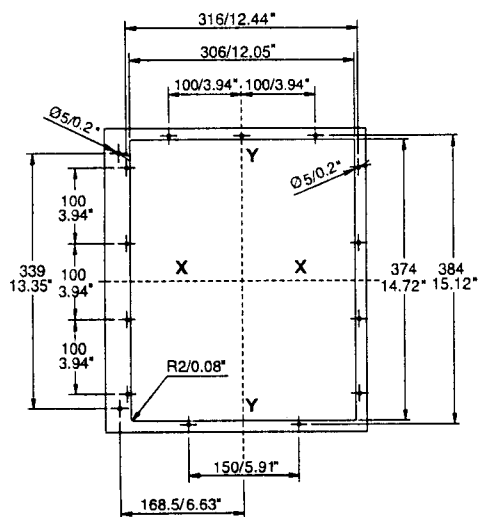

Tightening torque for fastening screws Nm 20 - 177 lb/in  
 Tightening torque for main terminals Nm 70 - 620 lb/in  
 Tightening torque for earthing screw Nm 70 - 620 lb/in

	High strength M12 screw Number per terminal	
	PHASE	NEUTRAL
<b>E1-E2</b>	2	2
<b>E3</b>	3	3
<b>E4</b>	4	2-4
<b>E6</b>	6	3-6

# Overall dimensions

## Mechanical interlock

### Interlock assembly

[mm/in]

**Type A**  
Horizontal  
Vertical

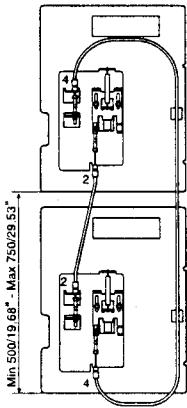

**Type B**  
(emergency interlock  
interlock below)  
Horizontal Vertical

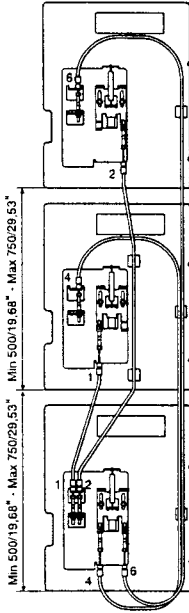

**Type B**  
(emergency interlock  
in the middle)  
Horizontal Vertical

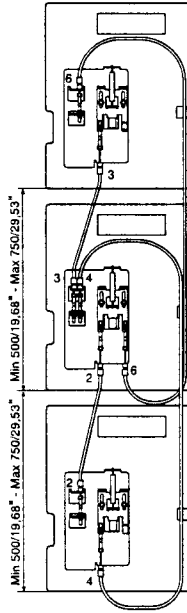

**Type B**  
(emergency interlock  
above)  
Horizontal Vertical

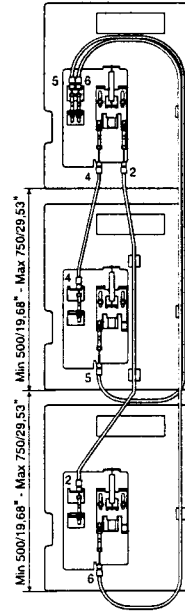

**Type C**  
Horizontal Vertical

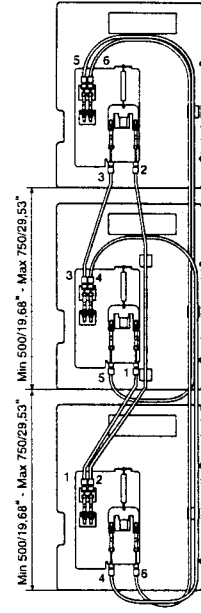

**Type D**  
Horizontal Vertical

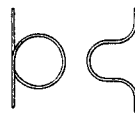
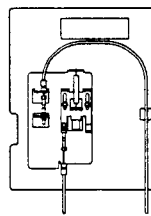
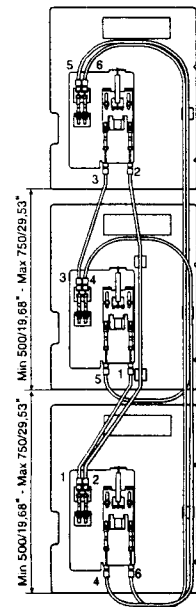

#### Horizontal interlocks

Maximum distance between two interlocks: 1200/47.28 mm from one interlock to the other. The cables pass under the cradles, following the same connection diagram shown for vertical circuit breakers.

Take up the excess cable by making it go through only one complete turn or an omega as shown in the figure.

#### Notes

When fitting interlocks between two circuit breakers, it is necessary to make suitable holes (through the switchboard) in the mounting surface for fixed circuit breakers or for the cradle of draw out circuit breakers, in order to pass the flexible cables through, respecting the measurements shown in the figures on page 5/17. For vertical interlocks, align the right-hand sides vertically and reduce the bends in the flexible cables to a minimum (minimum radius R: 70 mm / 2.76 in). All the angle values of the bends which the cable passes through added together must not exceed 720°.

Through-holes for flexible cables for mechanical interlocks

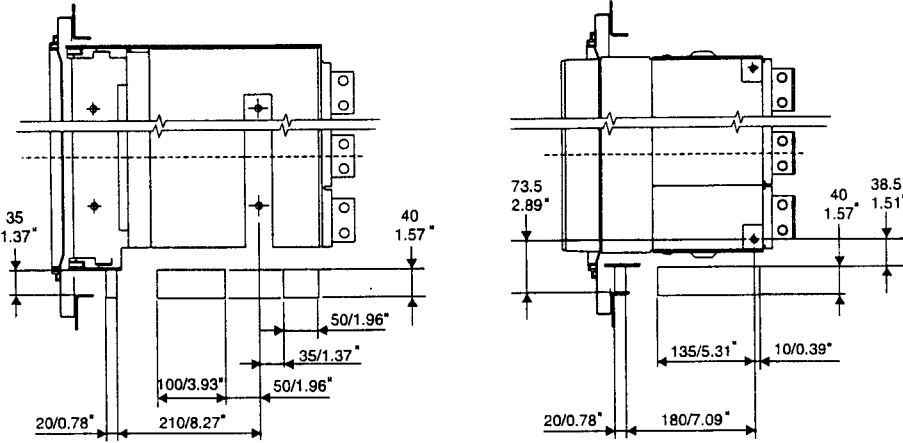

# Overall dimensions

## Circuit breaker accessories

### Mechanical compartment door lock

[mm/in]

### Drilling in compartment door

### Minimum distance between circuit breaker and switchboard wall

Fixed version

Draw out version

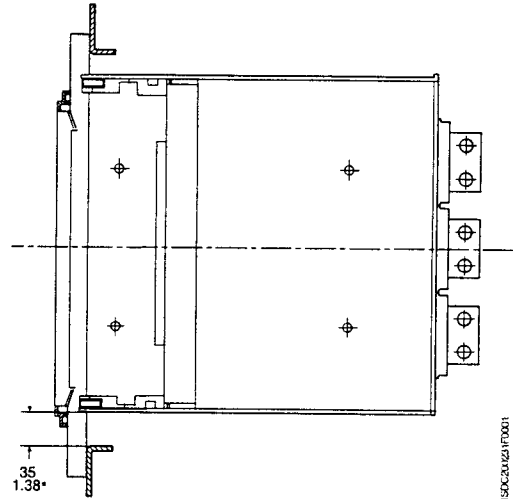
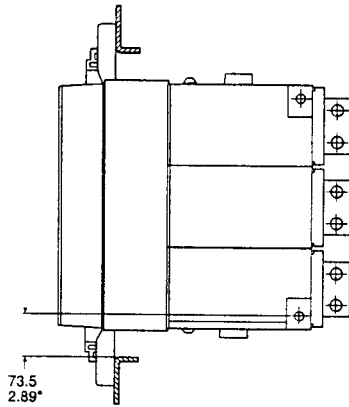
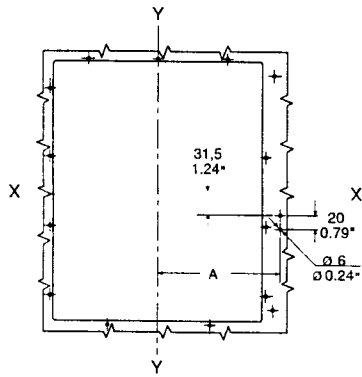

150C20124/TD001

A  
3 Poles 4 Poles

	3 Poles	4 Poles
E1	180	180
E2	180	180
E3	234	234
E4	270	360
E6	360	486

### Homopolar toroid

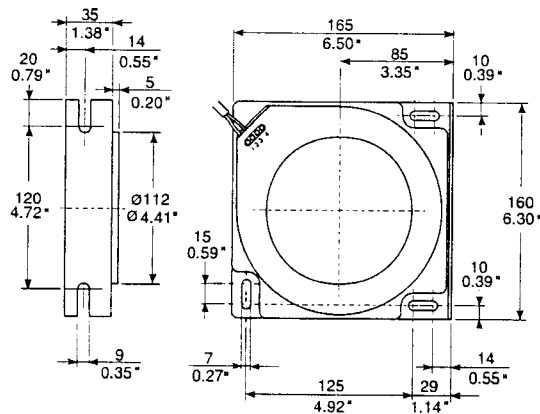

150C20032/F001

**Current transformer  
for the external  
neutral**

[mm/in]

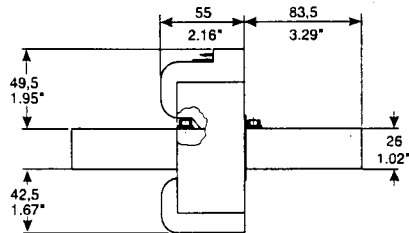

**E1 - E2 - E4**

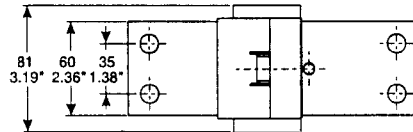

**E3 - E6**

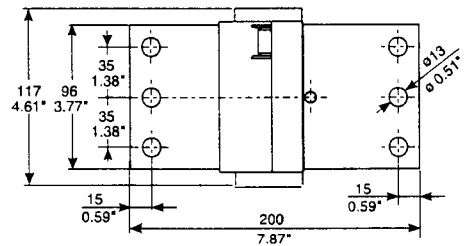

1500-20063R001

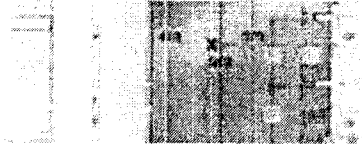

# Overall dimensions

## Circuit breaker accessories

### Electrical signalling of circuit breaker open/closed

[mm/in]

#### 15 supplementary auxiliary contacts

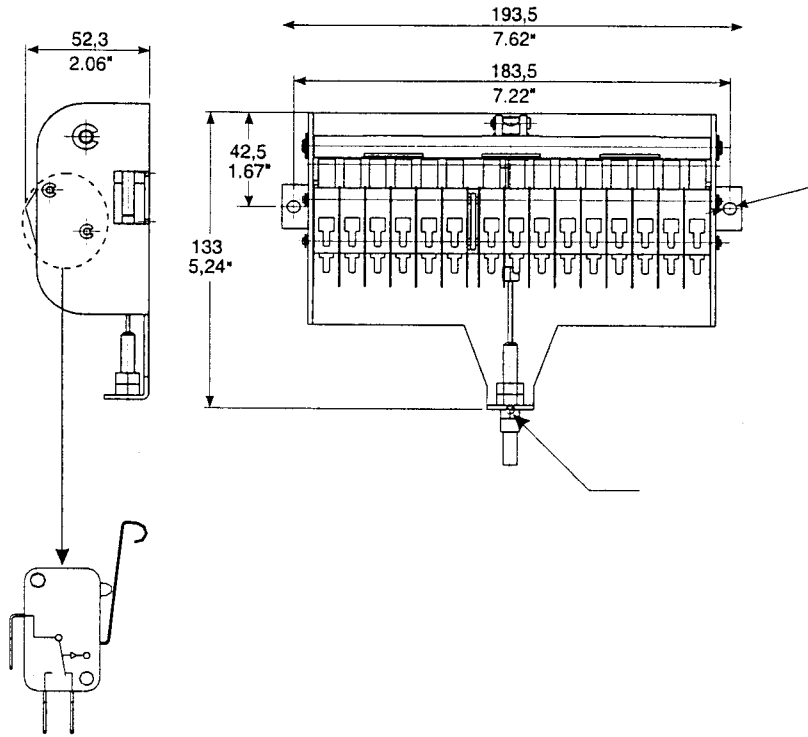

A flexible cable 650 mm / 25.59 in long is available from point "A" to point "B".

#### Fixed version

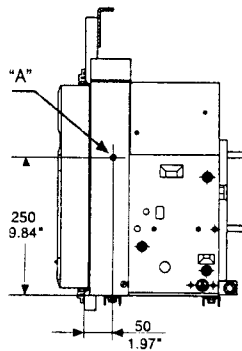

#### Draw out version

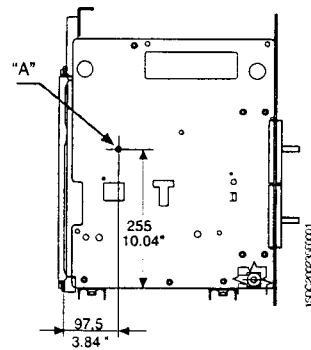

ATS010

[mm/in]

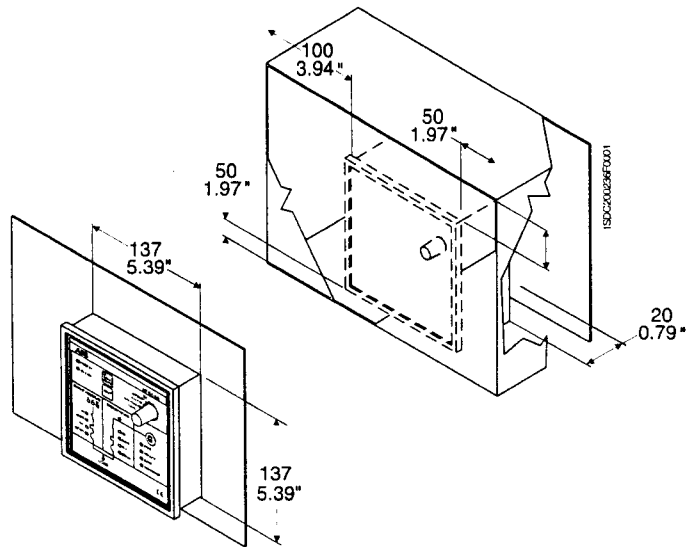

**Electronic  
time-delay device**

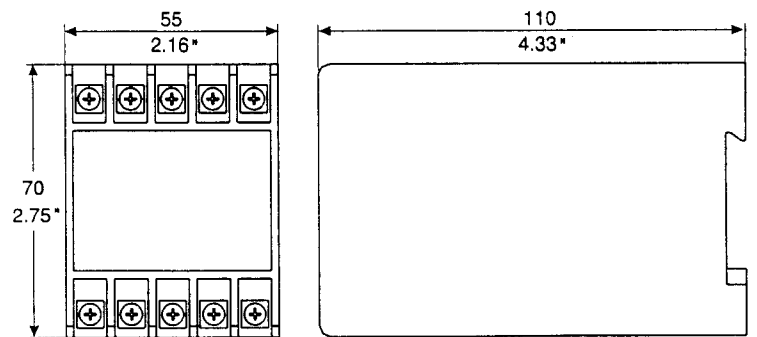



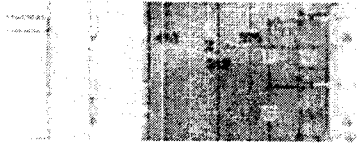

# Overall dimensions

## Circuit breaker accessories

**IP54 Protective cover**

[mm/in]

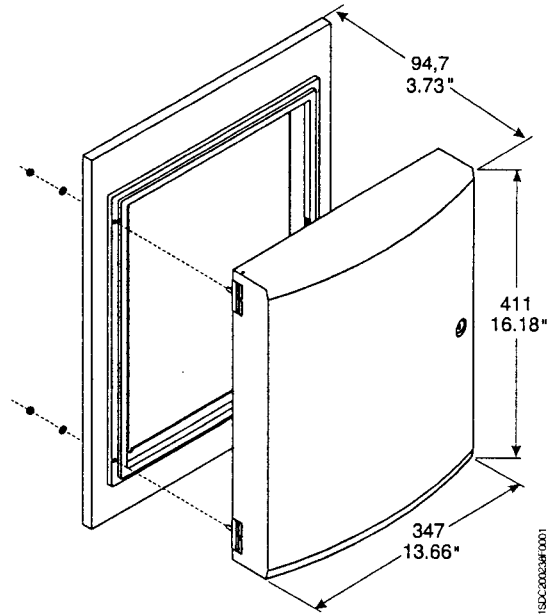

**PR020/K Unit**

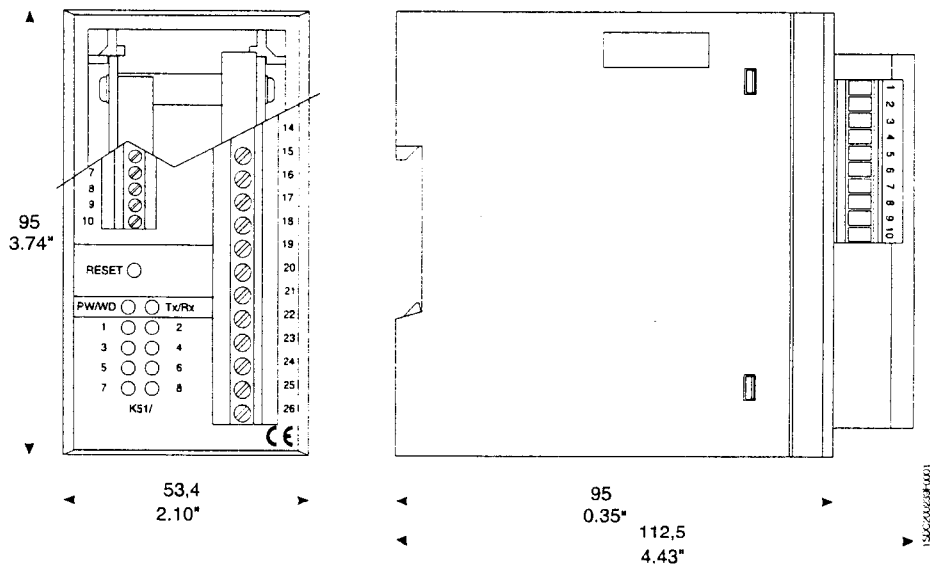





# Emax

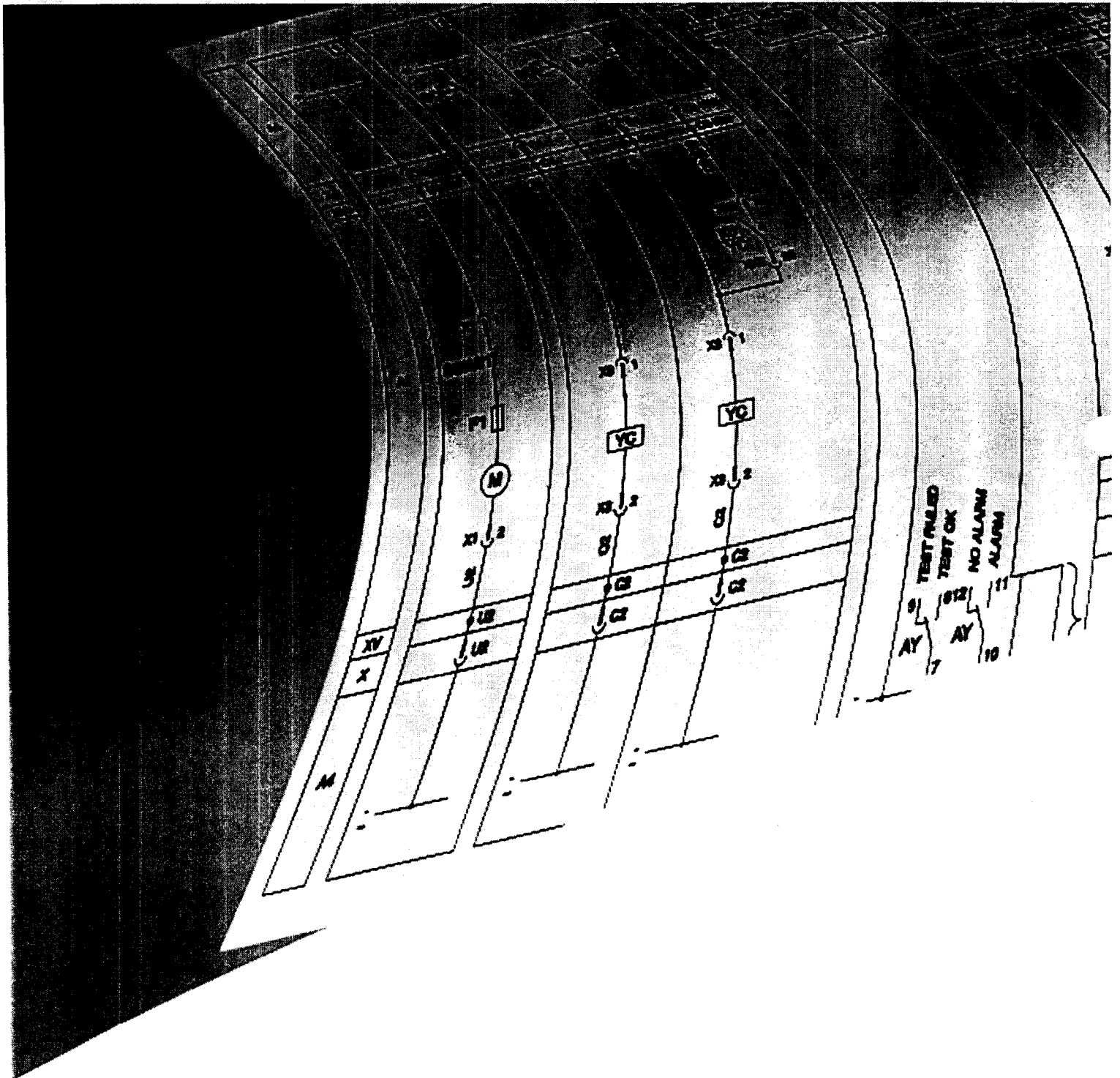

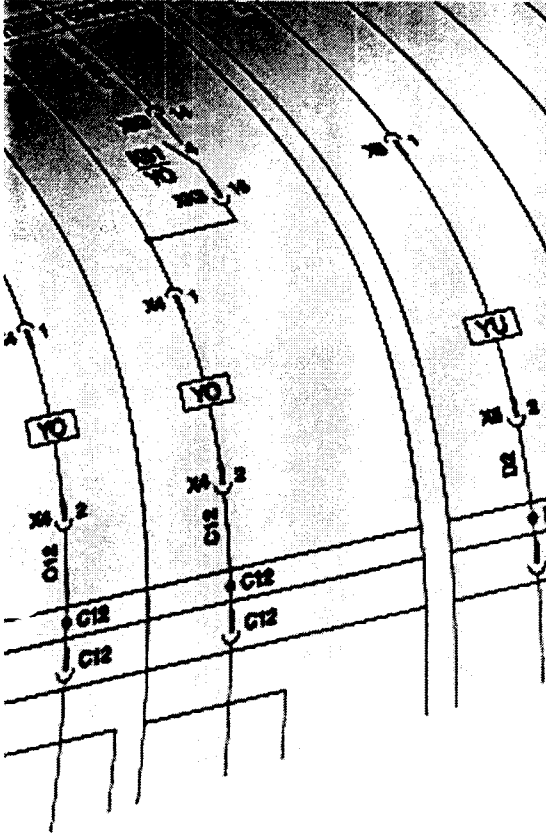

## Contents

Reading information - circuit breakers .....	6/2
Reading information - ATS010 unit .....	6/6
Circuit diagram symbols (IEC 60617 and CEI 3-14 ... 3-26 Standards) .....	6/7
<b>Circuit diagrams</b>	
Circuit breakers .....	6/8
Electrical accessories .....	6/9
Automatic transfer switch - ATS010 (IEC only) .....	6/14

# Circuit diagrams

## Reading information - circuit breakers

### Operating status shown of the circuit breakers

The circuit diagram is shown under the following conditions:

- draw out circuit breaker, open and racked-in
- circuits de-energized
- trip units not tripped
- motor operator with springs discharged.

### Versions

The diagram shows a draw out circuit breaker, but is also valid for fixed version circuit breakers.

#### Fixed version

The control circuits are between terminals XV (connector X is not supplied).

With this version, the applications indicated in figures 31, 32 and 51 cannot be provided.

#### Draw out version

The control circuits are between the poles of connector X (terminal box XV is not supplied).

With this version, the application shown in figure 52 cannot be supplied.

#### Version without overcurrent trip unit

With this version, the applications shown in figures 3, 5, 13, 41, 42, 43, 44, 51, 52, 53 and 62 cannot be supplied.

#### Version with PR111-A microprocessor-based trip unit

The PR111-A overcurrent trip unit is only fitted with the trip unit.

With this version, the applications shown in figures 3, 5, 41, 42, 43, 44, 53 and 62 cannot be supplied.

#### Version with PR112/P-A microprocessor-based trip unit

The PR112/P-A overcurrent trip unit is only fitted with the trip unit.

With this version, the applications shown in figures 3, 5, 22, 42, 43, 44 and 53 cannot be supplied.

#### Version with PR112/PD-A microprocessor-based trip unit

The PR112/PD-A overcurrent trip unit is fitted with the trip and dialogue units.

With this version, the applications shown in figures 22, 41, 43, 44 and 53 cannot be supplied.

#### Version with PR113/P-A microprocessor-based trip unit

The PR113/P-A overcurrent trip unit is only fitted with the trip unit.

With this version, the applications shown in figures 3, 5, 22, 41, 42 and 44 cannot be supplied.

#### Version with PR113/PD-A microprocessor-based trip unit

The PR113/PD-A overcurrent trip unit is fitted with the trip and dialogue units.

With this version, the applications shown in figures 22, 41, 42 and 43 cannot be supplied.

### Caption

- = Figure number of diagram
- \* = See the note indicated by the letter
- A1 = Circuit breaker applications
- A13 = PR020/K Signalling unit (only available with PR112/P-A, PR112/PD-A, PR113/P-A or PR113/PD-A trip unit)
- A3 = Applications located on the cradle of the circuit breaker (only available with draw out circuit breakers)
- A4 = Examples of switchgear and connections for control and signalling, outside the circuit breaker
- AY = SACE SOR TEST UNIT control/monitoring Unit (see note R)
- D = Electronic time-delay device of the undervoltage release, outside the circuit breaker
- F1 = Delayed-trip fuse
- K51 = PR111-A, PR112/P-A, PR112/PD-A, PR113/P-A or PR113/PD-A microprocessor-based trip unit with the following protection functions (see note G):
  - L overload protection with inverse long time-delay trip - setting I1
  - S short-circuit protection with inverse or definite short time-delay trip - setting I2
  - I short-circuit protection with instantaneous trip - setting I3
  - G ground fault protection with inverse short time-delay trip - setting I4
- K51/μP = Electrical signalling of alarm due to microprocessor operating faults (only with Uaux. and PR112/P-A, PR112/PD-A, PR113/P-A or PR113/PD-A trip unit)
- K51/1...8 = Contacts of the PR020/K signalling unit
- K51/GZin = Zone discrimination: input for protection G or "reverse" direction input for protection D (DBin) (only provided with Uaux. and PR113/P-A or PR113/PD-A trip unit)
- K51/GZout = Zone discrimination: output for protection G or "reverse" direction output for protection D (DBout) (only provided with Uaux. and PR113/P-A or PR113/PD-A trip unit)

K51/P1	= Programmable electrical signalling (only provided with Uaux. and PR112/P-A, PR112/PD-A, PR113/P-A or PR113/PD-A trip unit)
K51/P2	= Programmable electrical signalling (only provided with Uaux. and PR113/P-A trip unit)
K51/SZin (DFin)	= Zone discrimination: input for protection S or "direct" direction input for protection D (only provided with Uaux. and PR113/P-A or PR113/PD-A trip unit)
K51/SZout (DFout)	= Zone discrimination: output for protection S or "direct" direction output for protection D (only with Uaux. and PR113/P-A or PR113/PD-A trip unit)
K51/YC	= Closing control from PR112/PD-A or PR113/PD-A microprocessor-based trip unit
K51/Y0	= Opening control from PR112/PD-A or PR113/PD-A microprocessor-based trip unit
K51/Y01	= Electrical alarm signal for trip unit Y01 TRIPPED (only with PR112/P-A, PR112/PD-A, PR113/P-A or PR113/PD-A trip unit)
K51/Zin	= Zone discrimination: input (only with Uaux. and PR112/P-A or PR112/PD-A trip unit)
K51/Zout	= Zone discrimination: output (only with Uaux. and PR112/P-A or PR112/PD-A trip unit)
M	= Motor for charging the closing springs
Q	= Circuit breaker
Q/1...25	= Auxiliary contacts of the circuit breaker
S33M/1	= Limit contact of the spring charging motor
S33M/2	= Contact for electrical signalling of springs charged
S43	= Switch for setting remote/local control
S51	= Contact for electrical signalling of circuit breaker open due to overcurrent trip unit tripped. The circuit breaker can only be closed after the reset pushbutton has been pressed.
S75E/14	= Contacts for electrical signalling of circuit breaker in racked-out position (only with draw out circuit breakers)
S75I/14	= Contacts for electrical signalling of circuit breaker in racked-in position (only with draw out circuit breakers)
S75T/14	= Contacts for electrical signalling of circuit breaker in test isolated position (only with draw out circuit breakers)
SC	= Pushbutton or contact for closing the circuit breaker
SO	= Pushbutton or contact for opening the circuit breaker
SO	= Pushbutton or contact for opening the circuit breaker with delayed trip
SO2	= Pushbutton or contact for opening the circuit breaker with instantaneous trip
TI/L1	= Current transformer located on phase L1
TI/L2	= Current transformer located on phase L2
TI/L3	= Current transformer located on phase L3
TI/N	= Current transformer located on neutral
TI/O	= Homopolar current transformer located on the conductor that connects the transformer star center MV/LV to ground (see note G)
TU	= Insulating transformer
Uaux.	= Auxiliary power supply voltage (see note F)
UI/L1	= Current sensor (Rogowski coil) located on phase L1
UI/L2	= Current sensor (Rogowski coil) located on phase L2
UI/L3	= Current sensor (Rogowski coil) located on phase L3
UI/N	= Current sensor (Rogowski coil) located on neutral
W1	= Serial interface with the control system (external bus): EIA RS485 interface (see note E)
W2	= Serial interface with the accessories of PR112/P-A, PR112/PD-A, PR113/P-A and PR113/PD-A trip units (internal bus)
X	= Delivery connector for auxiliary circuits of the draw out version circuit breaker
X1...X7	= Connectors for circuit breaker applications
XF	= Delivery terminal box for the position contacts of the draw out version circuit breaker (located on the cradle of the circuit breaker)
XK1	= Connector for the power circuits of the PR111-A, PR112/P-A, PR112/PD-A, PR113/P-A and PR113/PD-A trip units
XK2 - XK3	= Connectors for the auxiliary circuits of the PR112/P-A, PR112/PD-A, PR113/P-A and PR113/PD-A trip units
XO	= Connector for the trip unit YO1
XV	= Delivery terminal box for the auxiliary circuits of the fixed circuit breaker
YC	= Closing coil
YO	= Shunt trip
YO1	= Shunt trip overcurrent trip unit
YO2	= Second shunt trip (see note Q)
YU	= Undervoltage release (see notes B and Q)



# Circuit diagrams

## Reading information - circuit breakers

### Description of figures

- Fig. 1 = Motor circuit for charging the closing springs
- Fig. 2 = Closing coil circuit
- Fig. 3 = Closing coil circuit controlled by the dialogue unit of the PR112/PD-A or PR113/PD-A trip unit
- Fig. 4 = Shunt trip
- Fig. 5 = Shunt trip circuit controlled by the dialogue unit of the PR112/PD-A or PR113/PD-A trip unit
- Fig. 6 = Instantaneous undervoltage release (see notes B and Q)
- Fig. 7 = Undervoltage release with electronic time-delay device, outside the circuit breaker (see notes B and Q)
- Fig. 8 = Second shunt trip (see note Q)
- Fig. 11 = Contact for electrical signalling of springs charged.
- Fig. 12 = Contact for electrical signalling of undervoltage release it energized (see notes B, L and S)
- Fig. 13 = Contact for electrical signalling of circuit breaker open due to overcurrent trip unit tripped. The circuit breaker can only be closed after the reset pushbutton has been pressed.
- Fig. 21 = First set of circuit breaker auxiliary contacts
- Fig. 22 = Second set of circuit breaker auxiliary contacts (not available with PR112/P-A, PR112/PD-A, PR113/P-A and PR113/PD-A trip units).
- Fig. 23 = Third set of supplementary auxiliary contacts outside the circuit breaker
- Fig. 31 = First set of contacts for electrical signalling of circuit breaker in racked-in, test isolated or racked-out position
- Fig. 32 = Second set of contacts for electrical signalling of circuit breaker in racked-in, test isolated or racked-out position
- Fig. 41 = Auxiliary circuits of the PR112/P-A trip unit (see note F)
- Fig. 42 = Auxiliary circuits of the PR112/PD-A trip unit (see notes D, F and M)
- Fig. 43 = Auxiliary circuits of the PR113/P-A trip unit (see note F)
- Fig. 44 = Auxiliary circuits of the PR113/PD-A trip unit (see notes F and M)
- Fig. 51 = Circuit of current transformer on neutral conductor outside circuit breaker, for draw out circuit breaker
- Fig. 52 = Circuit of current transformer on neutral conductor outside circuit breaker, for fixed circuit breaker (see note C)
- Fig. 53 = Circuit valid for three-pole circuit breaker with PR113/P-A or PR113/PD-A trip unit without current transformer on neutral conductor outside circuit breaker (see note H)
- Fig. 61 = SACE SOR TEST UNIT control/monitoring unit (see note R)
- Fig. 62 = PR020/K Signalling unit (only with PR112/P-A, PR112/PD-A, PR113/P-A or PR113/PD-A trip unit)

### Incompatibility

The circuits indicated in the following figures cannot be supplied simultaneously on the same circuit breaker:

- 2 - 3
- 4 - 5
- 6 - 7 - 8
- 22 - 41 - 42 - 43 - 44
- 31 - 51
- 51 - 52 - 53



## Notes

- A) The circuit breaker is only fitted with the applications specified in the ABB order acknowledgement.  
Consult this catalog for information on how to make out an order.
- B) The undervoltage release is supplied for operation using a power supply branched on the supply side of the circuit breaker or from an independent source. The circuit breaker can only close when the trip unit is energized (there is a mechanical lock on closing).  
If the same power supply is used for the closing coil and undervoltage release and the circuit breaker is required to close automatically when the auxiliary power supply comes back on, a 30 ms delay must be introduced between the undervoltage release accept signal and energizing of the closing coil.
- C) For fixed circuit breakers with current transformers on the neutral conductors outside the circuit breakers, the terminals of transformer TI/N must be short-circuited to remove the circuit breaker.
- D) Connect the contact S33M/2 shown in fig. 11, one of the make contacts and one of the break contacts of the circuit breaker shown in fig. 21 as illustrated in fig. 42.
- E) See the following documentation on how to connect the EIA RS485 serial line:  
- RH0298.002 for MODBUS communication
- F) The auxiliary voltage Uaux. allows actuation of all operations of the PR112/P-A, PR112/PD-A, PR113/P-A and PR113/PD-A trip units. To this regard, refer to the corresponding user manuals.
- G) Ground fault protection is available with the PR112/P-A, PR112/PD-A, PR113/P-A and PR113/PD-A trip units by means of a current transformer located on the conductor connecting the star center of the MV/LV transformer to ground.  
The connection between terminals 1 and 2 of the TI/O current transformer and poles T5 and T6 of connector X (or XV) must be made with a two-pole shielded and stranded cable (see user manual) no more than 15 m long. The shield must be grounded on the circuit breaker side and current transformer side.
- H) In the case of PR113/P-A or PR113/PD-A trip units mounted on a three-pole circuit breaker without connection to the external neutral, poles T3 and T4 of connector X (or XV) should be short-circuited by the customer.
- I) The contact cannot be used if the PR112/PD-A or PR113/PD-A unit is present.
- L) The contact cannot be used if the PR113/P-A or PR113/PD-A unit is present.
- M) Connect one of the S75I contacts shown in fig. 31 or 51 as illustrated in fig. 42-44.  
On fixed circuit breakers, connect terminal XV-K14 directly to terminal XV-K16 (contact S75I does not exist).
- N) Connections to the zone discrimination inputs and outputs on PR112/P-A, PR112/PD-A, PR113/P-A and PR113/PD-A trip units must be made using a two-pole shielded and stranded cable (see user manual) no more than 300m long. The shield must be grounded on the selectivity input side.
- O) The connection between the voltage sensors (TV) and circuit breaker on PR113/P-A and PR113/PD-A trip units must be made using a two-pole shielded and stranded cable (see user manual) no more than 15m long.  
The shield must be grounded on both sides (sensor and circuit breaker).
- P) The power supply of coils YO and YC must not be derived from the main power supply on PR112/PD-A and PR113/PD-A trip units.  
The coils can be controlled directly by contacts K51/YO and K51/YC with maximum voltages of 60VDC and 240-250VAC for PR112/PD-A, 240-250VDC and 240-250VAC for PR113/PD-A.
- Q) The second shunt trip can be installed as an alternative to the undervoltage release.
- R) The SACE SOR TEST UNIT + shunt trip (YO) is guaranteed to operate starting at 75% of the Uaux of the shunt trip itself.  
While the YO power supply contact is closing (short-circuit on terminals 4 and 5), the SACE SOR TEST UNIT is unable to detect the opening coil status.  
For this reason:  
- For continuously powered opening coil, the TEST FAILED and ALARM signals will be activated  
- If the coil opening command is of the pulsing type, the TEST FAILED signal can appear at the same time. In this case, the TEST FAILED signal is actually only an alarm signal if it remains lit for more than 20s.
- S) Also available in version with normally-closed contact.
- T) Configuration valid for four-pole or three-pole circuit breaker with external neutral. See the manual for additional installation configurations.

Rules to follow when replacing PR111-A, PR112/P-A, PR112/PD-A, PR113/P-A or PR113/PD-A trip units:

- Pay careful attention to the notes provided on the circuit diagrams supplied
- The contact to electrically signal the undervoltage release energized (Fig. 12 of the enclosed diagrams) must be removed from the terminal box.

# Circuit diagrams

## Reading information - ATS010 unit

### Operating status shown of the ATS010 unit

The circuit diagram is shown under the following conditions:

- circuit breakers open and racked-in #
- generator not under alarm
- closing springs discharged
- trip units not tripped \*
- ATS010 not powered
- generator in automatic mode and not started
- generator switching enabled
- circuits de-energized
- logic enabled by means of special input (terminal 47).

# This diagram shows draw out circuit breakers, but is also valid for fixed version circuit breakers: the auxiliary circuits of the circuit breakers are not headed to connector X but to terminal box XV; also connect terminal 17 to 20 and terminal 35 to 38 on the ATS010 device.

\* This diagram shows circuit breakers with trip units, but is also valid for circuit breakers without trip units: connect terminal 18 to 20 and terminal 35 to 37 of the ATS010 device.

@ This diagram shows four-pole circuit breakers but is also valid for two-pole circuit breakers: use only terminals 26 and 24 (phase and neutral) for the voltage connections of the normal power supply to the ATS010 device; also use the Q61/2 two-pole rather than four-pole auxiliary protection circuit breaker.

### Caption

A1	= Circuit breaker applications
A	= ATS010 device for automatic switching of two circuit breakers
F1	= Delayed-trip fuse
K1	= Auxiliary contact for emergency power supply voltage present
K2	= Auxiliary contact for normal supply voltage present
K51/Q1	= Trip unit of the emergency power supply line *
K51/Q2	= Trip unit of the normal power supply line *
M	= Motor for charging the closing springs
Q/1	= Auxiliary contact of the circuit breaker
Q1	= Emergency power supply line circuit breaker
Q	= Normal power supply line circuit breaker
Q61/1-2	= Thermomagnetic circuit breakers for isolating and protecting the auxiliary circuits @
S11...S16	= Signalling contacts for the inputs of the ATS010 device
S33M/1	= Limit contact of the closing springs
S51	= Contact for electrical signalling of circuit breaker open due to trip unit tripped *
S75I/1	= Contact for electrical signalling of draw out version circuit breaker racked-in #
TI/ ...	= Current transformers for the trip unit power supply
X	= Connector for the auxiliary circuits of the draw version out circuit breaker
XF	= Delivery terminal box for the position contacts of the draw out version circuit breaker
XV	= Delivery terminal box for the auxiliary circuits of the fixed version circuit breaker
YC	= Closing coil
YO	= Shunt trip

### Note

A) For the auxiliary circuits of the circuit breakers, see the circuit diagram of the circuit breaker/accessory. The applications shown in the following figures are compulsory: 1 - 2 - 4 - 13 (only if the trip unit is supplied) - 21 - 31 (only for draw out version circuit breakers).

# Circuit diagrams

Circuit diagram symbols (IEC 60617 and CEI 3-14 ... 3-26 Standards)

	Shield (may be drawn in any shape)		Terminal or clamp		Changeover position contact with momentary breaking (limit contact)
	Timing		Socket and plug (female and male)		Power circuit breaker-isolator with automatic opening
	Mechanical connection		Motor (general symbol)		Molded case switch
	Manual mechanical control (general)		Current transformer		Control coil (general symbol)
	Rotary hand operating mechanism		Voltage transformer		Instantaneous overcurrent relay
	Pushbutton control		Winding of three-phase transformer, star connection		Overcurrent relay with adjustable short time delay trip characteristic
	Equipotentiality		Make contact		Overcurrent relay with inverse short time delay trip characteristic
	Galvanically separated converter		Break contact with automatic circuit breaking		Overcurrent relay with inverse long time delay trip characteristic
	Shielded cable conductors (e.g. = 3 conductors)		Changeover contact		Overcurrent relay for ground fault with inverse short time delay trip characteristic
	Stranded conductors or cables (e.g. = 3 conductors)		Make position contact (limit contact)		Fuse (general symbol)
	Conductors connections		Break position contact (limit contact)		Current sensor
	Thermal effect		Electromagnetic effect		Mechanical interlock between two circuit breakers

# Circuit diagrams

## Circuit breakers

### Operating status

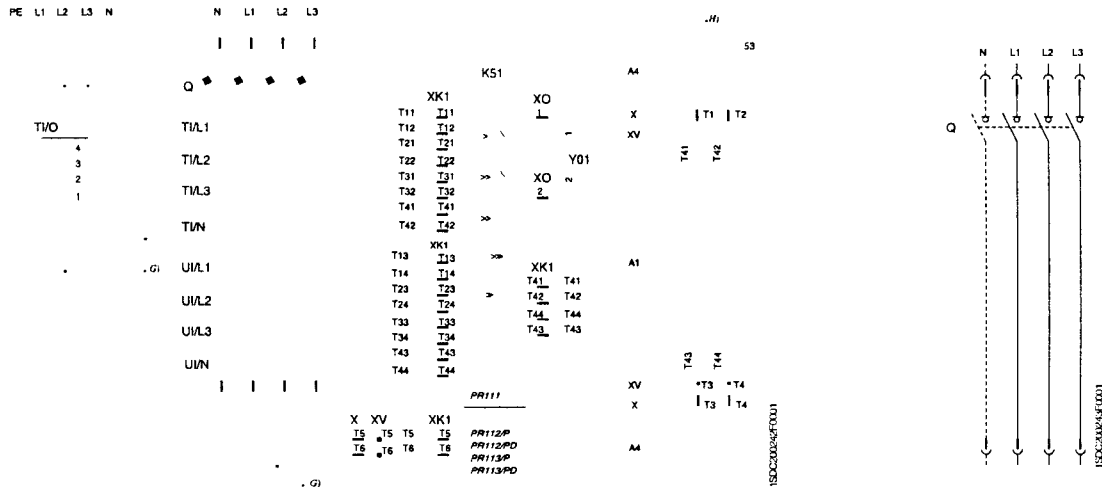

Three- or four-pole circuit breaker with microprocessor-based PR111-A, PR112/P-A, PR112/PD-A, PR113P-A and PR113/PD-A trip unit

Three- or four-pole switch-disconnector

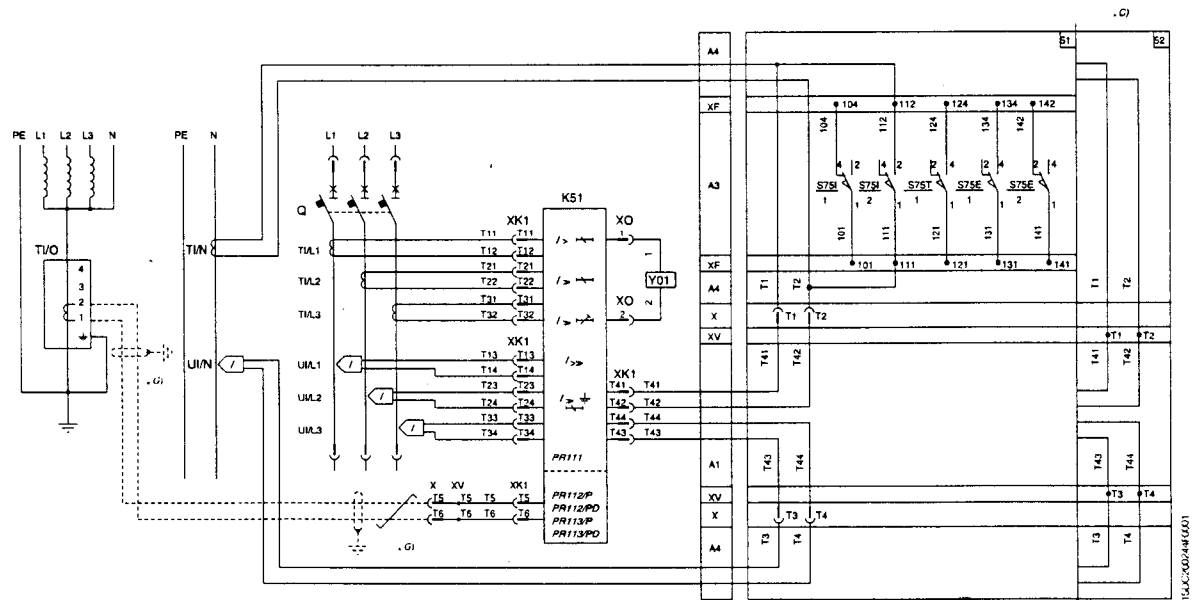

Three-pole circuit breaker with PR111-A, PR112/P-A, PR112/PD-A, PR113P-A and PR113/PD-A microprocessor-based trip unit and current transformer on neutral conductor outside circuit breaker

# Circuit diagrams

## Electrical accessories

### Motor operator, shunt trip, closing coil and undervoltage release

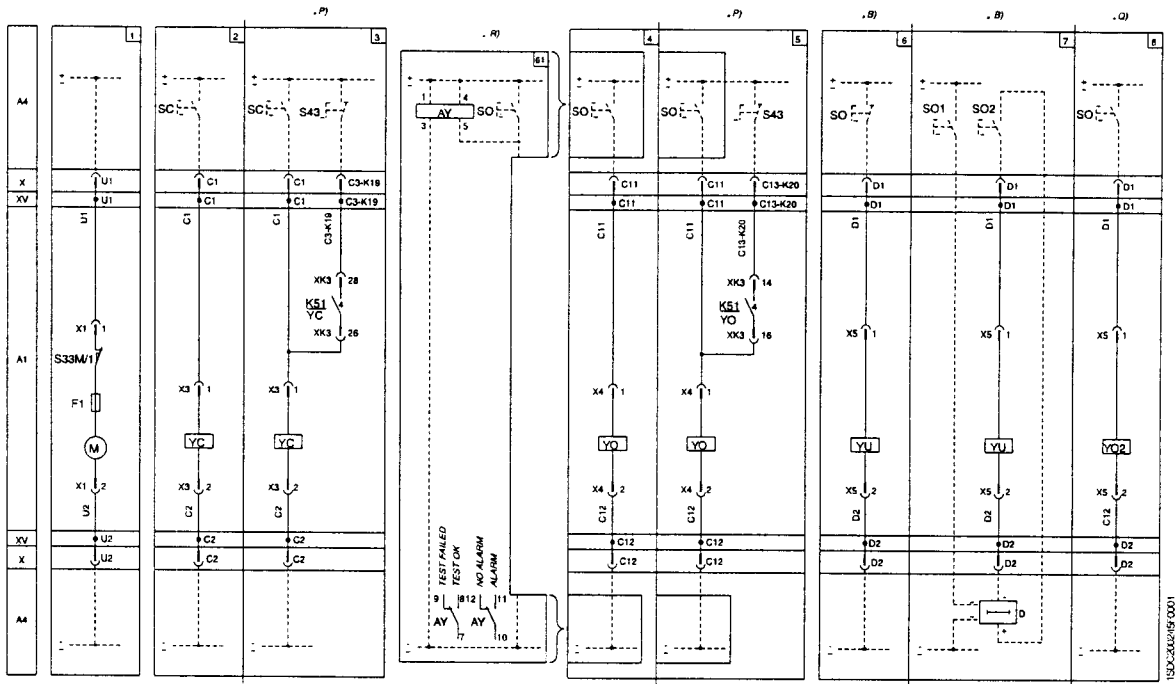

### Signalling contacts

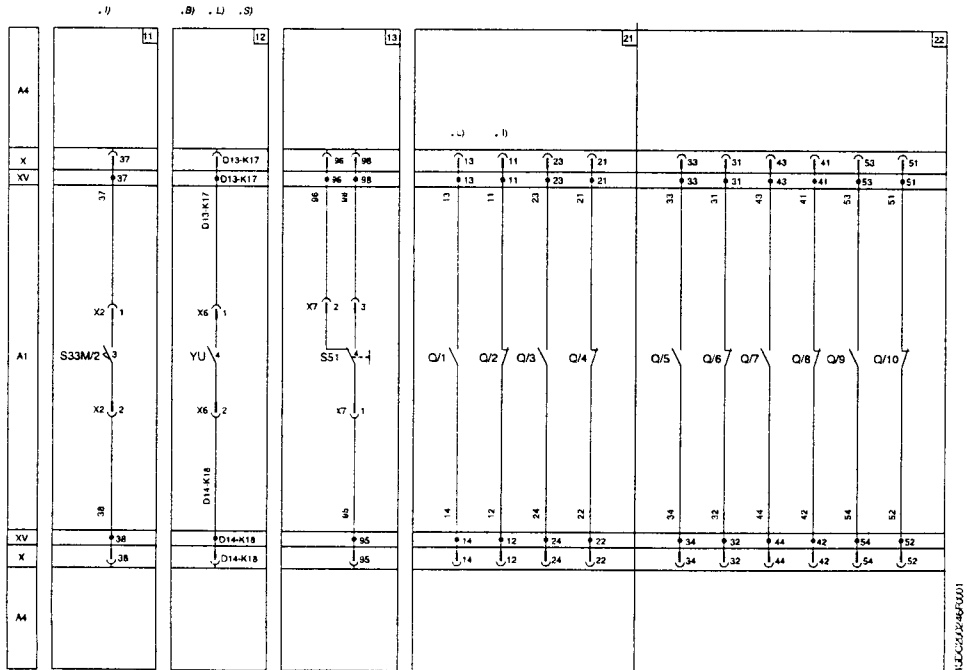

# Circuit diagrams

## Electrical accessories

### Signalling contacts

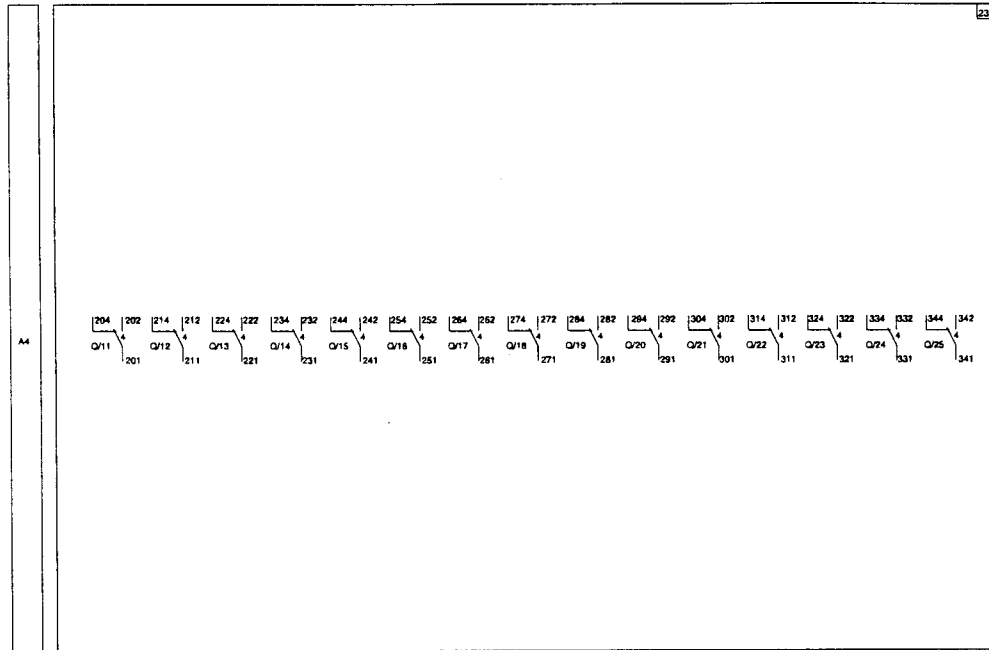

1SD020247F001

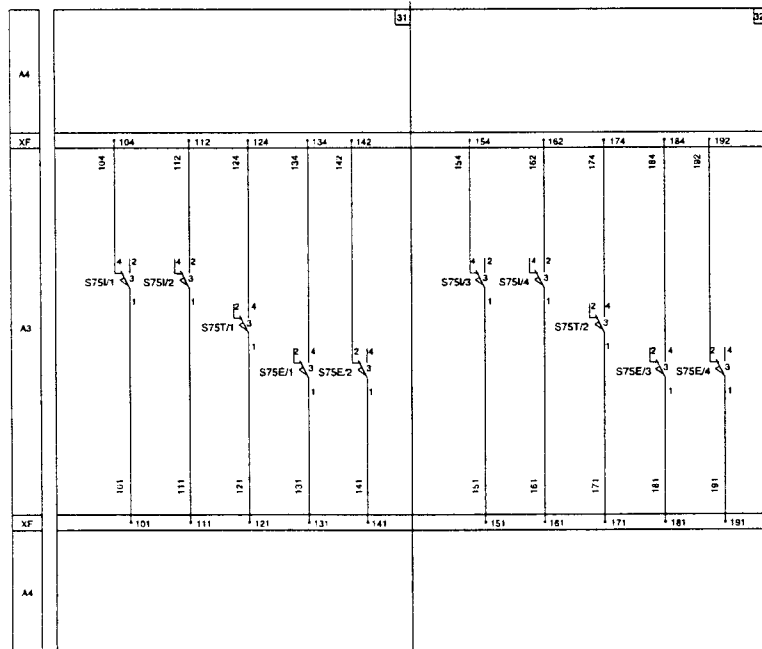

1SD020247F001

### Auxiliary circuits of the PR112/P-A trip unit

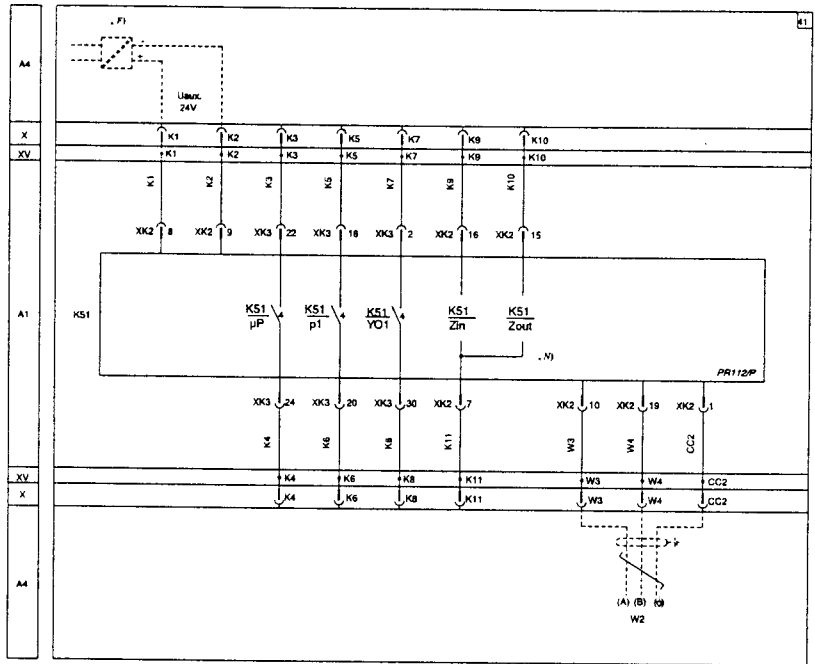

1SDC202049D001

### Auxiliary circuits of the PR112/PD-A trip unit

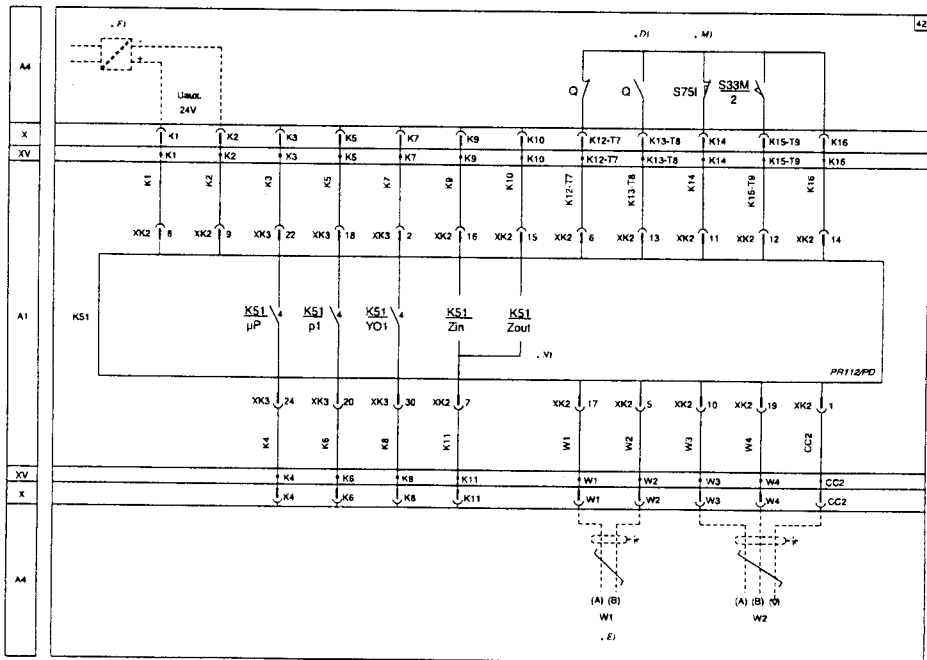

1SDC202049D001

# Circuit diagrams

## Electrical accessories

### Auxiliary circuits of the PR113/P-A trip unit

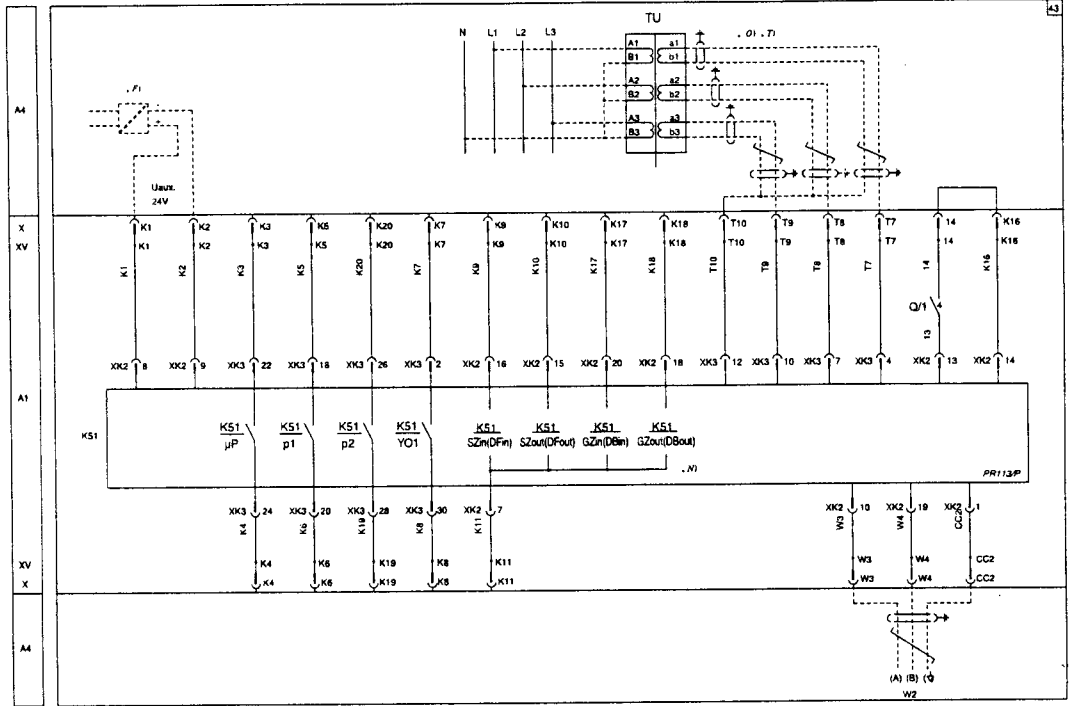

### Auxiliary circuits of the PR113/PD-A trip unit

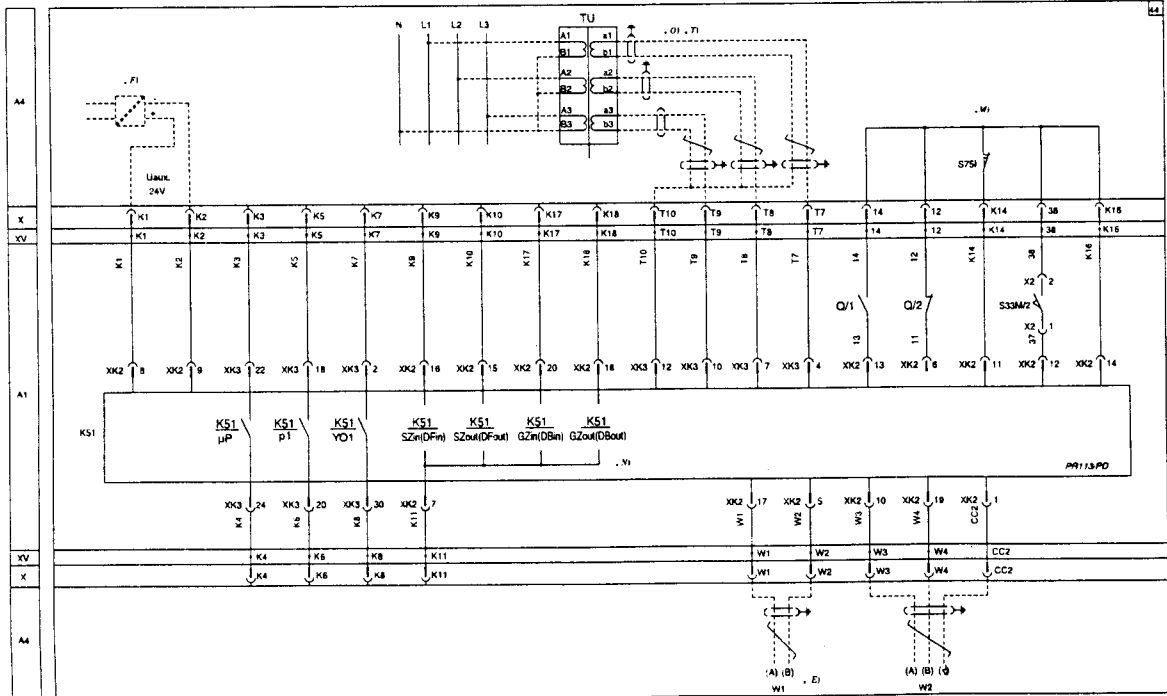



# PR020/K signalling unit

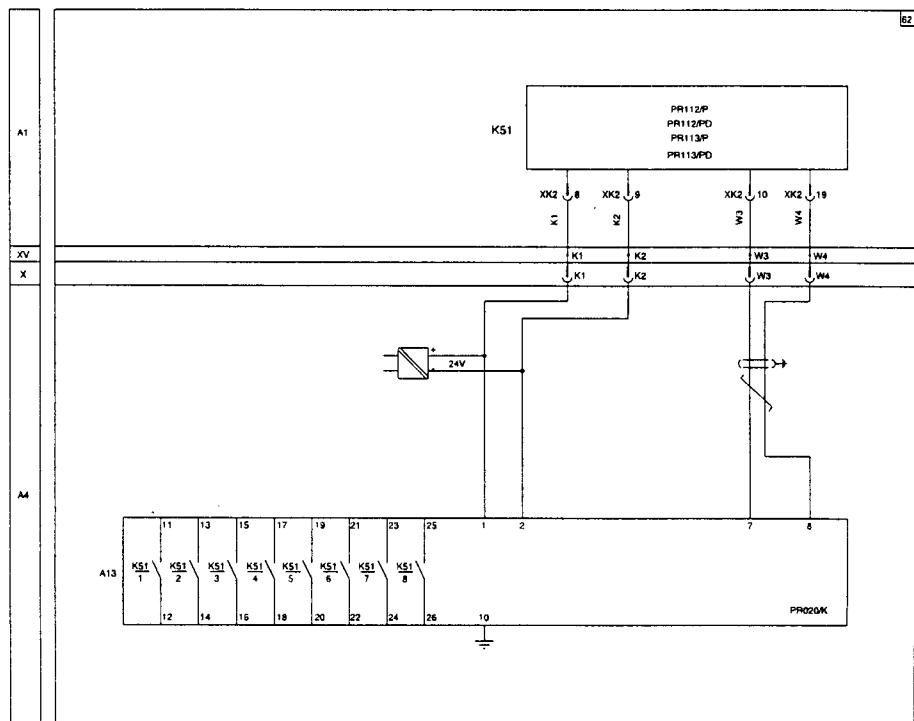

# Circuit diagrams

## Automatic transfer switch - ATS010 (IEC only)

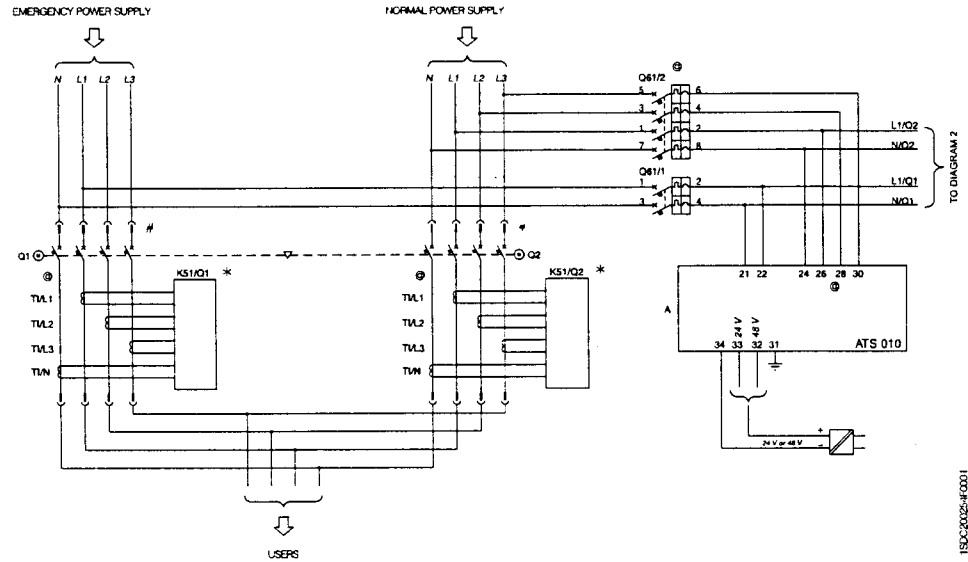

### WITHOUT AUXILIARY SAFETY POWER SUPPLY

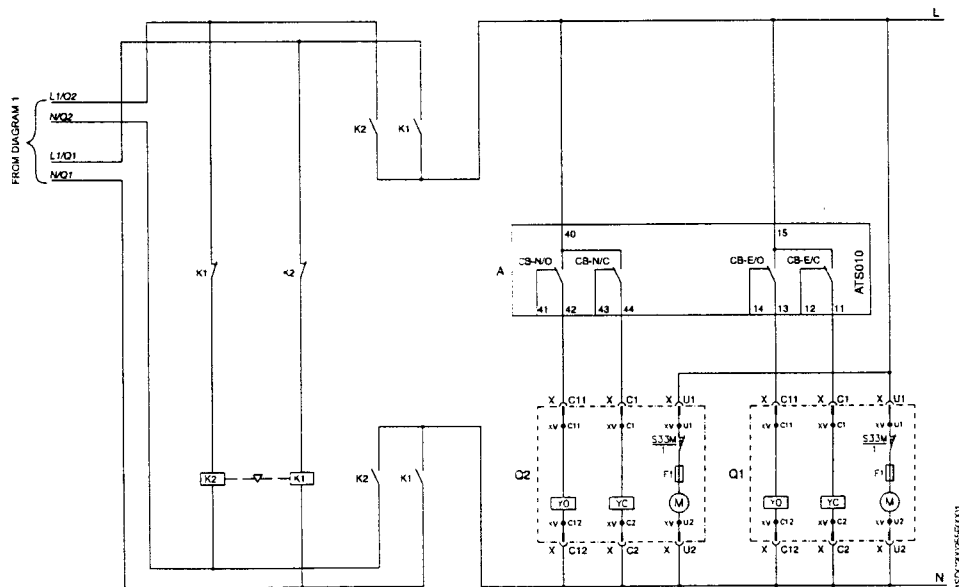

WITH AUXILIARY SAFETY POWER SUPPLY

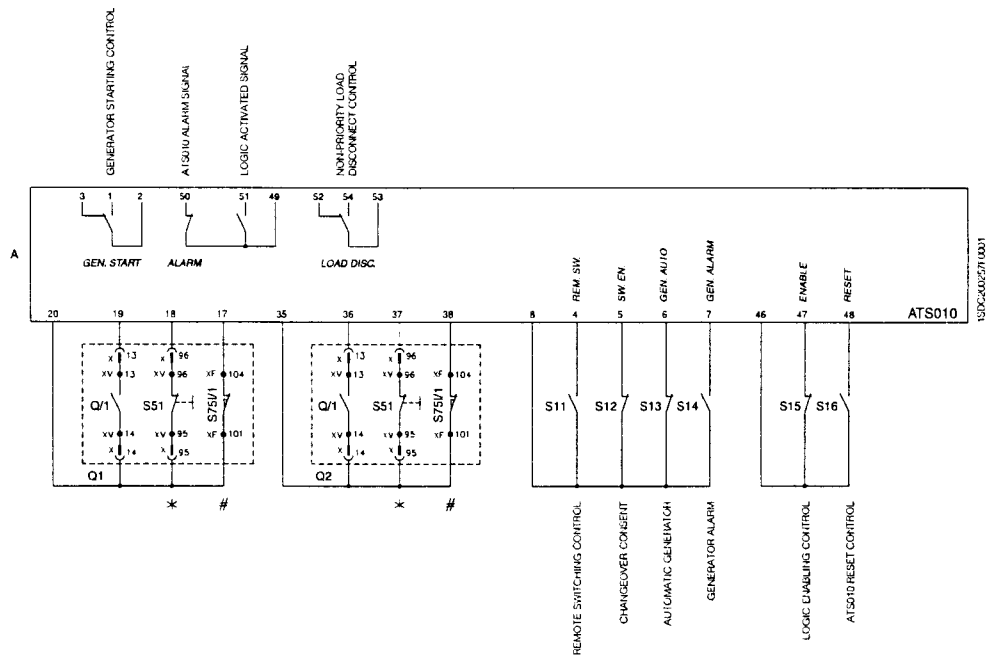
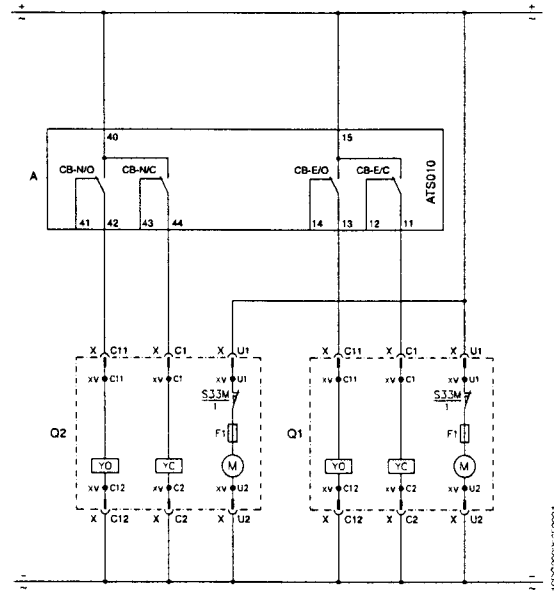





# NZM Circuit Breakers, N Molded Case Switches

## Overview

**NZM 7**  
150 A

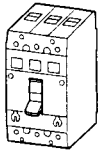

**NZM 10**  
600 A

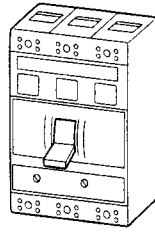



	<b>Page</b>
<b>Ratings overview</b>	09/004
<b>System overview</b>	09/006
<b>Overview of combination options</b>	09/008
<b>Inverse time circuit breakers</b>	
Thermal-magnetic	09/010
<b>Molded case switches, 200A</b>	
Manual, non-automatic	09/013
<b>Accessories</b>	
Auxiliary contacts	09/014
Shunt trips	09/016
Undervoltage trips	09/018
Remote control drive	09/020
Accessories	09/022
Handles	09/022
Mechanical interlocks	09/026
Terminal kits	09/028
<b>Tripping characteristics</b>	09/088
<b>Technical data</b>	09/094
<b>Dimensions</b>	09/103

	<b>Page</b>
<b>Ratings overview</b>	09/004
<b>System overview</b>	09/030
<b>Overview of combination options</b>	09/032
<b>Inverse time circuit breakers</b>	
Solid state trip type	09/034
<b>Molded case circuit breakers</b>	
Instantaneous trip type	09/038
<b>Molded case switches, 630A</b>	
Manual, non-automatic	09/039
<b>Switch blocks, solid-state trip modules</b>	90/040
<b>Accessories</b>	
Auxiliary contacts	09/042
Differential fault indication, pre-alarm	09/042
Shunt trips	09/043
Undervoltage trips	09/044
Remote control drive	09/045
Accessories	09/046
Handles	09/048
Mechanical interlocks	09/050
Terminal kits	09/051
<b>Tripping characteristics</b>	09/089
<b>Technical data</b>	09/094
<b>Dimensions</b>	09/106

Notes For weights → page 14/020

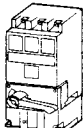
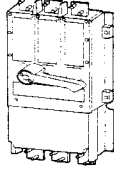

## Overview

NZMH 4 80 A		NZM 6B 125 A	
			
	Page		Page
<b>Ratings overview</b>	09/005	<b>Ratings overview</b>	09/005
<b>Molded case circuit breakers</b>		<b>Inverse time circuit breakers</b>	
Instantaneous trip type	09/052	Thermal magnetic	09/060
		Instantaneous trip type	09/061
<b>Motor disconnect switches, 80 A</b>		<b>Molded case switches, 150 A</b>	
Manual, non-automatic	09/053	Thermal magnetic manual motor disconnect	09/062
		Manual, non-automatic	09/063
<b>Accessories</b>		<b>Accessories</b>	
Auxiliary contacts	09/054	Auxiliary contacts	09/064
Shunt trips, Undervoltage trips	09/055	Shunt trips, Undervoltage trips	09/065
Handles	09/056	Handles	09/066
Accessories	09/056	Accessories	09/066
<b>Tripping characteristics</b>	09/091	<b>Tripping characteristics</b>	09/091
<b>Technical data</b>	09/098	<b>Technical data</b>	09/098
<b>Dimensions</b>	09/109	<b>Dimensions</b>	09/109
<b>NZM 9 250 A</b>		<b>NZM 12 1000 A</b>	
			
	Page		Page
<b>Technical overview</b>	09/004	<b>Technical overview</b>	09/004
<b>Inverse time circuit breakers</b>		<b>Inverse time circuit breakers</b>	
Thermal-magnetic	09/070	Thermal-magnetic	09/080
Instantaneous trip type	09/071		
<b>Motor disconnect switches, 250 A</b>		<b>Motor disconnect switches, 1200 A</b>	
Thermal magnetic manual motor disconnect	09/072	Manual, non-automatic	09/081
Manual, non-automatic	09/073		
<b>Accessories</b>		<b>Accessories</b>	
Auxiliary contacts	09/074	Auxiliary contacts	09/082
Shunt trips, Undervoltage trips	09/075	Shunt trips, Undervoltage trips	09/083
Motor operators	09/075	Motor operators	09/083
Handles	09/076	Handles	09/084
Accessories	09/076	Accessories	09/084
<b>Tripping characteristics</b>	09/091	<b>Tripping characteristics</b>	09/091
<b>Technical data</b>	09/098	<b>Technical data</b>	09/098
<b>Dimensions</b>	09/109	<b>Dimensions</b>	09/109

Notes

For weights → page 14/020



# Circuit Breakers Type NZM...-(C)NA

## Ratings Overview

UL / CSA / IEC / CE / EN 60 947

## Inverse time circuit breakers

Frame rating

UL/CSA Interrupting ratings  
kA RMS sym. at

A

240 VAC

480 VAC

## Thermal magnetic trip

UL 489/CSA 22.2 No. 5.1; IEC/EN 60 947-2



fuseless current limiting

NZM6B-.../ZM6A-...-NA	15 - 125	25	25
NZMH6-.../ZM6A-...-NA		100	65



fuseless current limiting

NZM7(A)-...N-NA	25 - 150	65	25
NZM7(A)-...S-NA		100	50



fuseless current limiting

NZM9-.../ZM9A-...-NA	70 - 250	30	25
NZMH9-.../ZM9A-...-NA		200	85

## Solid state trip

UL 489/CSA 22.2 No. 5.1; IEC/EN 60 947-2

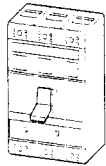

fuseless current limiting

NZM10-...N/ZM10(A)-...-NA	200 - 600	65	42
NZM10-...S/ZM10(A)-...-NA		100	65
NZM10-...H/ZM10(A)-...-NA		200	100

with trip delay feature for  
selectivity in networks

NZM10-...N/ZM10V(A)-...-NA		65	42
NZM10-...S/ZM10V(A)-...-NA		100	65

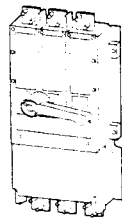
with trip delay feature for  
selectivity in networks

NZM12-...ZM12-(A)-...-NA <sup>1)</sup>	300 - 1000	65	65
NZM12-.../ZM12V-...-NA <sup>1)</sup>			



## Notes

<sup>1)</sup> Type NZM12-... UL/CSA only.

All inverse time circuit breakers are UL listed and CSA certified, in compliance with IEC/EN 60 947-2 (circuit breaker) and CE marked. Consult the technical data and Moeller Electric for IEC/EN ratings.



# Circuit Breakers / Disconnect Switches / Molded Case Switches

## Ratings Overview

UL / CSA / IEC / CE / EN 60 947

**Instantaneous trip circuit breakers**

Frame rating

UL/CSA Interrupting ratings  
kA RMS sym. at

A

240 VAC

480 VAC

**Instantaneous trip type circuit breakers**

UL 489 / CSA 22.2 No. 5.1

NZMH4-...-OBI-CNA	2.1 - 18
NZMH4-...-OBI-Form CDN	
NZM6B-.../ZM6-...-OBI-CNA	0.6 - 125
NZMH6-.../ZM6-...-OBI-CNA	33 - 125
NZM9-.../ZM9-...-OBI-CNA	63 - 250
NZMH9-.../ZM9-...-OBI-CNA	63 - 250
NZM10-...N/ZM-...-OBI-CNA	400 - 600
NZM10-...H/ZM-...-OBI-CNA	

UL recognized and CSA certified instantaneous trip circuit breakers no longer carry interrupting ratings as stand-alone devices.

Per the intent of NEC Article 430-52, an instantaneous trip circuit breaker shall be used only if part of a listed combination motor controller. Short circuit ratings are, therefore, established and valid only for the listed combination motor controller assembly and associated housing or enclosure.

Consult Section 03 of this catalog for combination motor controller short circuit ratings as standard starters featuring NZM instantaneous trip circuit breakers. Consult Moeller Electric for combination motor controller high fault short circuit ratings as motor control center unit starters featuring NZM instantaneous trip circuit breakers.

**UL/CSA Short circuit ratings****Motor disconnect switches**

UL 508 / CSA 22.2 Nr. 14, IEC/EN 60 947-2, CE

HP rated,  
with adjustable thermal  
and magnetic trips

NZMH4-...-CNA <sup>1)</sup>	4 - 80	100	25
NZM6B-.../ZM6-...-CNA	15 - 125	25	25
NZMH6-.../ZM6-...-CNA	15 - 125	100	65
NZM9-.../ZM9-...-CNA	63 - 250	30	25
NZMH9-.../ZM9-...-CNA	63 - 250	200	85

**Motor disconnect switches**

UL 508 / CSA 22.2 Nr. 14, IEC/EN 60 947-3, CE

HP rated,  
without trip elements

N6-...-CNA	150	10	10
N9-...-CNA	250	10	10
N12-...-CNA <sup>2)</sup>	1200	42	42

**Molded case switches**

UL 1087 / CSA 22.2 Nr.5.2, IEC/EN 60 947-3, CE

Without trip elements

NZM7-...-NA(-M8)	200	25	25
NZM10-...N/B-NA	600	25	25

**Notes**

<sup>1)</sup> NZMH4-...-CNA in the range of 4 - 16A, UL/CSA only

<sup>2)</sup> N12-... UL/CSA only.

Consult the technical data and Moeller Electric for IEC/EN ratings.



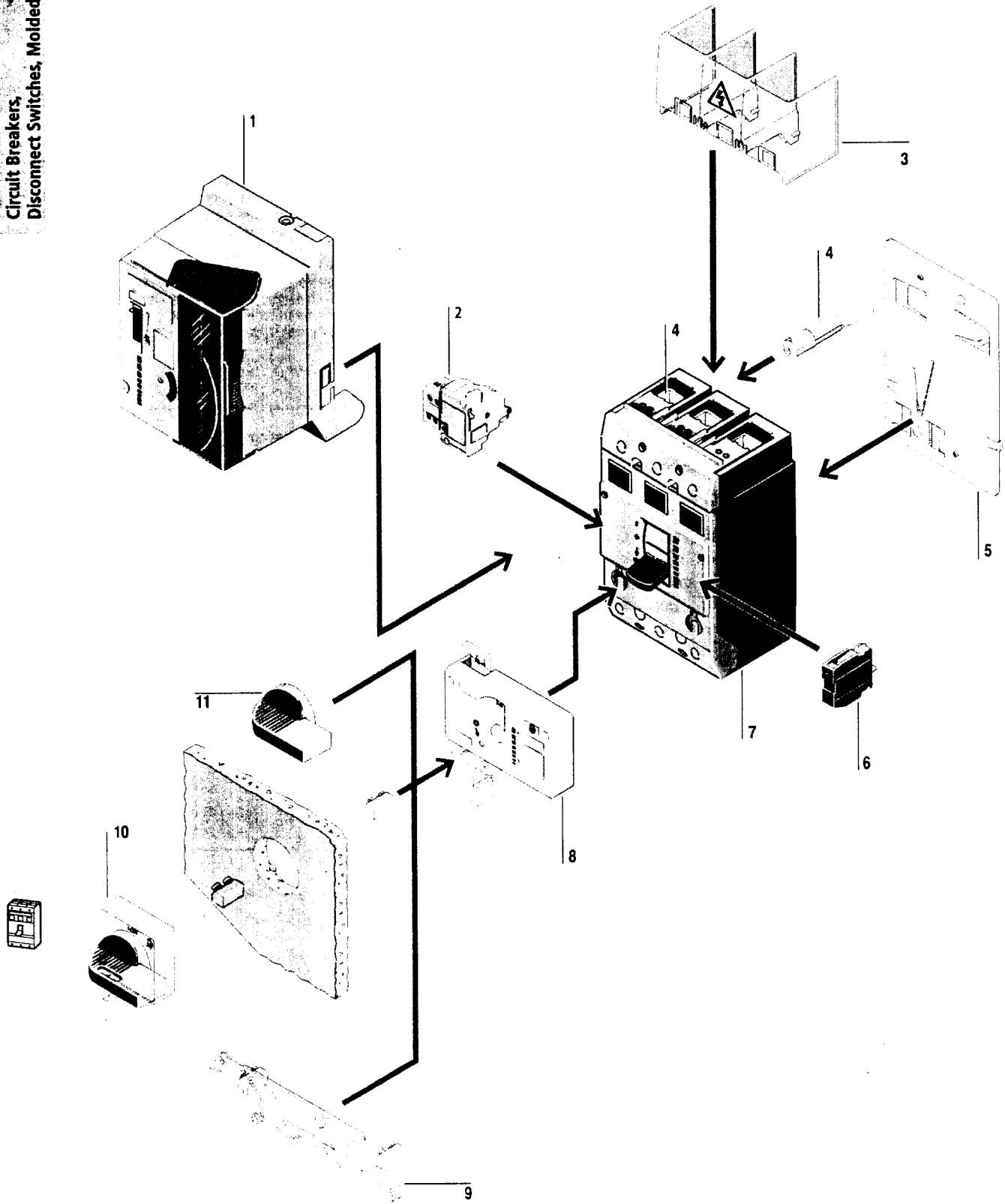

# Molded Case Circuit Breakers and Switches

## Type NZM 7... Overview

<b>Basic devices</b>	
<b>Circuit breakers</b>	7
600 V AC, 150 A rating	
25 kA @ 480 V AC interrupting rating	
Field installable accessories	
Supplied with terminals for cable hookup or bolt-on connection	
UL listed (UL 489), CSA certified (C 22.2 No. 5.1)	
Conformity with (Circuit Breakers) IEC/EN 60 947-2	
→ page 09/010	
<b>Molded case switches</b>	7
600 V AC, 200 A rating	
Field installable accessories	
UL listed (UL 1087), CSA certified (C 22.2 No. 5.2)	
Conformity with IEC/EN 60 947-3 (Switch-disconnectors)	
→ page 09/013	
<b>Add-on modules</b>	
<b>NHI standard auxiliary contacts</b>	6
indicates switching status ON or OFF	
<b>RHI trip-indicating auxiliary contacts</b>	6
indicates switching status Tripped	
<b>VHI early-make auxiliary contact</b>	2
for interlocking and load-shedding circuits	
for early-make closing of the undervoltage trip	
→ page 09/014	
<b>Voltage trips</b>	2
Shunt trips	
Undervoltage trips	
• undelayed	
• undelayed, c/w early-make auxiliary contact	
→ page 09/016	
<b>Remote control drive</b>	1
Remote ON/OFF	
Remote reset	
For use as synchronizing switch	
Manual local switching possible	
Switch lockable in OFF position	
→ page 09/020	
<b>Rotary drive mechanism</b>	8
Conversion of toggle switching to rotary movement	
Switch lockable in OFF position	
→ page 09/022	
<b>Rotary handle</b>	11
to operate switch equipped with rotary drive mechanism	
→ page 09/022	
<b>Door/cover interlocking rotary handle</b>	10
For cover or door mounting	
Interlocking feature to prevent opening of door/cover with the switch in the ON position	
Padlockable in the OFF or ON position with up to 3 padlocks (hasp size 1/4", 4-8mm) (optional, also comes without padlocking feature)	
Standard color: black Available in red/yellow for Emergency-Stop function per CE and IEC/EN 60 204-1	
Degree of protection: UL/NEMA 12, IEC/EN: IP55	
→ page 09/022	
<b>Paralleling mechanism</b>	9
For simultaneous actuation of 2 switches mounted side by side	
→ page 09/026	
<b>Mounting accessories</b>	
<b>Terminations</b>	4
Terminals for round or flat-strip conductors	
Bolt-on connection for busbars or cable lugs	
Rear connections	
Built-in terminal covers	
→ page 09/028	
<b>Terminal</b>	3
→ page 09/036	
<b>Clip plate</b>	5
For mounting on top hat rail	
→ page 09/026	



# Molded Case Circuit Breakers and Switches

## Overview of Combination Options for Type NZM 7...

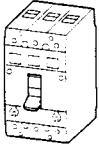
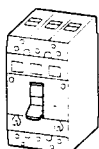
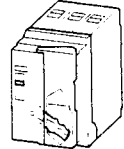
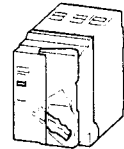





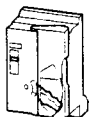

Type	Auxiliary contacts			Voltage trips				
	EK... (NHI)	EK... (RHI)	VHI-NZM 7	A-NZM 7	AVHI-NZM 7	U-NZM 7	UHI-NZM 7	
<b>Molded case circuit breaker</b>								
 NZM 7(A)...N(S)-NA	● ●	●	● or	● or	● or	● or	● or	
<b>Molded case switch</b>								
 NZM 7...-NA	● ●	●	● or	● or	● or	● or	● or	
<b>Molded case circuit breaker with remote control drive</b>								
 NZM 7(A)...N(S)-NA +R-NZM7	● ●	●	–	●	or	●	or	
<b>Molded case switch with remote control drive</b>								
 NZM 7...-NA +R-NZM7	● ●	●	–	●	or	●	or	

**Notes**

- Options for combination
- ◆ Included as standard
- Dots in each row represent the types which can be combined together in the types shown at left
- Dashes indicate incompatibility
- A● corresponds with one device
- All accessories can be field or factory installed

# Molded Case Circuit Breakers and Switches

## Overview of Combination Options for Type NZM 7...

Remote control drive	Handle operators					Connection systems		
	Rotary Drive Mechanism	Rotary handle	Cover/door interlocking Rotary handle NEMA/UL Type 12; IP 55			Cable terminals	Bolt-on connection (optional)	
							front	rear
								
R-NZM 7	DA(OV)-NZM 7	HU-NZM 7	(R)H-NZM 7	HOV-NZM 7	K 150-NZM 7		NZM 7...-NA M8	RG-NZM 7
• or	•	• or	• or	•	◆	•	•	
• or	•	• or	• or	•	◆	•	•	
◆	-	-	-	-	◆	•	•	
◆	-	-	-	-	◆	•	•	



## Inverse Time Circuit Breakers, 150A, 600V AC

### Thermal-magnetic Type NZM 7...-NA

UL / CSA / IEC / EN 60 947-2 / CE

**Normal Interrupting Capacity 25 kA at 480 V 50/60 Hz**  
**14 kA at 600 V 50/60 Hz**

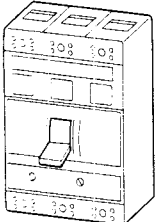
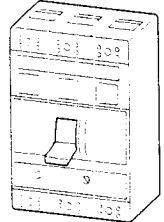
Continuous Current Rating $I_n$ A	Fixed Thermal Setting A	Magnetic Trip Setting for Instantaneous Response A	UL/CSA Interrupting Ratings (AC, 60Hz) kA RMS symmetrical @			Type Article No.	List Price see price list
			240V	480V	600V		
With fixed thermal setting and pressure wire terminals							
	40	25	380	65	25	14	<b>NZM7A-25N-NA</b> 208658
		30	380				<b>NZM7A-30N-NA</b> 208659
		35	380				<b>NZM7A-35N-NA</b> 208660
		40	380				<b>NZM7A-40N-NA</b> 208661
	60	50	378 - 760				<b>NZM7A-50N-NA</b> 208662
		60	378 - 760				<b>NZM7A-60N-NA</b> 208663
	80	70	480 - 960				<b>NZM7A-70N-NA</b> 208664
		80	480 - 960				<b>NZM7A-80N-NA</b> 208665
	100	90	600 - 1200				<b>NZM7A-90N-NA</b> 208666
		100	600 - 1200				<b>NZM7A-100N-NA</b> 208667
	125	125	750 - 1500				<b>NZM7A-125N-NA</b> 208668
	150	150	960 - 1900				<b>NZM7A-150N-NA</b> 210086
With fixed thermal setting and provisions for bolt-on connection							
	40	25	380	65	25	14	<b>NZM7A-25N-NA-M8</b> 208669
		30	380				<b>NZM7A-30N-NA-M8</b> 208670
		35	380				<b>NZM7A-35N-NA-M8</b> 208671
		40	380				<b>NZM7A-40N-NA-M8</b> 208672
	60	50	378 - 760				<b>NZM7A-50N-NA-M8</b> 208673
		60	378 - 760				<b>NZM7A-60N-NA-M8</b> 208674
	80	70	480 - 960				<b>NZM7A-70N-NA-M8</b> 208675
		80	480 - 960				<b>NZM7A-80N-NA-M8</b> 208676
	100	90	600 - 1200				<b>NZM7A-90N-NA-M8</b> 208677
		100	600 - 1200				<b>NZM7A-100N-NA-M8</b> 208678
	125	125	750 - 1500				<b>NZM7A-125N-NA-M8</b> 208679
	150	150	960 - 1900				<b>NZM7A-150N-NA-M8</b> 210087

**Notes:**

- <sup>1)</sup> Type **NZM7A-...N(S)-NA(-M8)** molded-case circuit breakers are UL listed (UL 489) and CSA certified (22.2 No. 5.1) Inverse Time, 150A Thermal-magnetic Trip Circuit Breakers with a fixed thermal trip feature and an adjustable magnetic trip function (In breakers rated 25 to 40A, the magnetic trip function is fixed at 380A).
- <sup>2)</sup> NZM7A-...N(S)-NA are supplied as standard with pressure wire terminals to accept cable connection, but are also suitable for bolt-on connections using crimped lugs or straight lengths of Cu busbar (type suffix "-M8").

# Inverse Time Circuit Breakers, 150A, 600V AC

Thermal-magnetic Type NZM7...-NA

UL / CSA / IEC / EN 60 947-2 / CE

Circuit Breakers, Disconnect Switches, Molded Case Switches

**High Interrupting Capacity 50 kA at 480 V 50/60 Hz**  
**22 kA at 600 V 50/60 Hz**  
 Fuseless current-limiting circuit breaker

UL/CSA Interrupting Ratings (AC, 60Hz)

**Type**  
Article No.

**List Price**  
see price list

kA RMS symmetrical @

240V 480V 600V

100	50	22		
			<b>NZM7A-25S-NA</b>	
			220936	
			<b>NZM7A-30S-NA</b>	
			220937	
			<b>NZM7A-35S-NA</b>	
			220938	
			<b>NZM7A-40S-NA</b>	
			220939	
			<b>NZM7A-50S-NA</b>	
			220940	
			<b>NZM7A-60S-NA</b>	
			220941	
			<b>NZM7A-70S-NA</b>	
			220942	
			<b>NZM7A-80S-NA</b>	
			220943	
			<b>NZM7A-90S-NA</b>	
			220944	
			<b>NZM7A-100S-NA</b>	
			220945	
			<b>NZM7A-125S-NA</b>	
			220946	
			<b>NZM7A-150S-NA</b>	
			220947	

100	50	22		
			<b>NZM7A-25S-NA-M8</b>	
			220948	
			<b>NZM7A-30S-NA-M8</b>	
			220949	
			<b>NZM7A-35S-NA-M8</b>	
			220950	
			<b>NZM7A-40S-NA-M8</b>	
			220951	
			<b>NZM7A-50S-NA-M8</b>	
			220952	
			<b>NZM7A-60S-NA-M8</b>	
			220953	
			<b>NZM7A-70S-NA-M8</b>	
			220954	
			<b>NZM7A-80S-NA-M8</b>	
			220955	
			<b>NZM7A-90S-NA-M8</b>	
			220956	
			<b>NZM7A-100S-NA-M8</b>	
			220957	
			<b>NZM7A-125S-NA-M8</b>	
			220958	
			<b>NZM7A-150S-NA-M8</b>	
			220959	

**Notes**

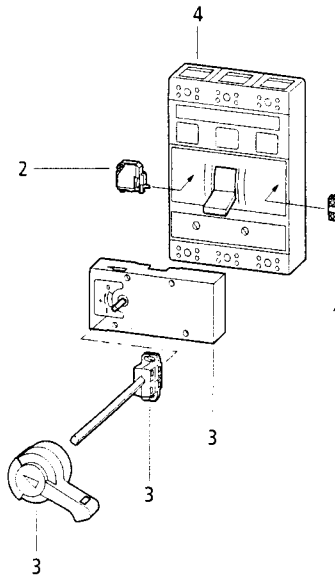

Accessories	Page
1 Auxiliary contacts	09/014
2 Voltage trips	09/016
3 Handles and operators	09/022
4 Terminals	09/028
Other accessories	09/022



## Inverse Time Circuit Breakers, 150A, 600V AC

### Thermal-magnetic Type NZM 7...-NA

**Normal Interrupting Capacity** **25 kA at 480 V 50/60 Hz**  
**14 kA at 600 V 50/60 Hz**

Continuous Current Rating $I_u$ A	Adjustable Thermal Setting A	Magnetic Trip Setting for Instantaneous Response A	UL/CSA Interrupting Ratings (AC, 60Hz) kA RMS symmetrical @		
			240V	480V	600V

**Type**  
Article No.

**List Price**  
see price list

With adjustable thermal setting and pressure wire terminals

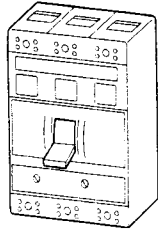

40	25 - 40	380	65	25	14	<b>NZM7-40N-NA</b> 210076
63	40 - 63	378 - 760				<b>NZM7-63N-NA</b> 210077
80	63 - 80	480 - 960				<b>NZM7-80N-NA</b> 210078
100	80 - 100	600 - 1200				<b>NZM7-100N-NA</b> 210079
125	80 - 125	750 - 1500				<b>NZM7-125N-NA</b> 207875
150	125 - 150	960 - 1900				<b>NZM7-150N-NA</b> 210084

With adjustable thermal setting and provisions for bolt-on connection

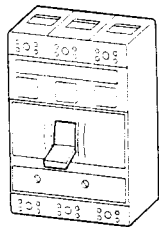

40	25 - 40	380	65	25	14	<b>NZM7-40N-NA-M8</b> 210080
63	40 - 63	378 - 760				<b>NZM7-63N-NA-M8</b> 210081
80	63 - 80	480 - 960				<b>NZM7-80N-NA-M8</b> 210082
100	80 - 100	600 - 1200				<b>NZM7-100N-NA-M8</b> 210083
125	80 - 125	750 - 1500				<b>NZM7-125N-NA-M8</b> 207839
150	125 - 150	960 - 1900				<b>NZM7-150N-NA-M8</b> 210085

**High Interrupting Capacity** **50 kA at 480 V 50/60 Hz**  
**22 kA at 600 V 50/60 Hz**

With adjustable thermal setting and pressure wire terminals

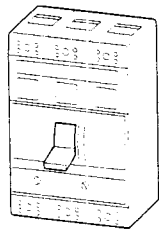

40	25 - 40	380	100	50	22	<b>NZM7-40S-NA</b> 220961
63	40 - 63	378 - 760				<b>NZM7-63S-NA</b> 220962
80	63 - 80	480 - 960				<b>NZM7-80S-NA</b> 220963
100	80 - 100	600 - 1200				<b>NZM7-100S-NA</b> 220964
125	80 - 125	750 - 1500				<b>NZM7-125S-NA</b> 220965
150	125 - 150	960 - 1900				<b>NZM7-150S-NA</b> 220966

With adjustable thermal setting and provisions for bolt-on connection

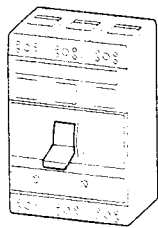

40	25 - 40	380	100	50	22	<b>NZM7-40S-NA-M8</b> 220967
63	40 - 63	378 - 760				<b>NZM7-63S-NA-M8</b> 220968
80	63 - 80	480 - 960				<b>NZM7-80S-NA-M8</b> 220969
100	80 - 100	600 - 1200				<b>NZM7-100S-NA-M8</b> 220970
125	80 - 125	750 - 1500				<b>NZM7-125S-NA-M8</b> 220971
150	125 - 150	960 - 1900				<b>NZM7-150S-NA-M8</b> 220972

#### Notes:

- Type NZM7-...N(S)-NA(-M8) molded-case circuit breakers are UL listed (UL 489) and CSA certified (22.2 No. 5.1) Inverse Time, 150A Thermal-magnetic Trip Circuit Breakers with an adjustable thermal trip feature and an adjustable magnetic trip function (In breakers rated 25 to 40A, the magnetic trip function is fixed at 380A).
- NZM7-...N(S)-NA molded case circuit breakers and NZM7-...-NA molded case switches are supplied as standard with pressure wire terminals to accept cable connection, but are also suitable for bolt-on connections using crimped lugs or straight lengths of Cu busbar (type suffix "-M8").



## Molded Case Switches, 200A, 600V AC

UL / CSA / IEC / EN 60 947-3 / CE

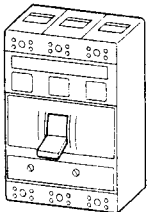
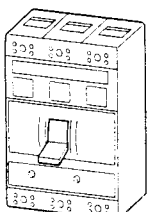
	Ampere Rating	Type Article No.	List Price see price list
A			
With pressure wire terminals for cable connection			
	60	<b>NZM7-60-NA</b> 205580	
	100	<b>NZM7-100-NA</b> 205581	
	125	<b>NZM7-125-NA</b> 205582	
	150	<b>NZM7-150-NA</b> 207600	
	200	<b>NZM7-200-NA</b> 215430	
With provisions for bolt-on connections			
	60	<b>NZM7-60-NA-M8</b> 205584	
	100	<b>NZM7-100-NA-M8</b> 205585	
	125	<b>NZM7-125-NA-M8</b> 205586	
	150	<b>NZM7-150-NA-M8</b> 207601	
	200	<b>NZM7-200-NA-M8</b> 205588	

## Notes

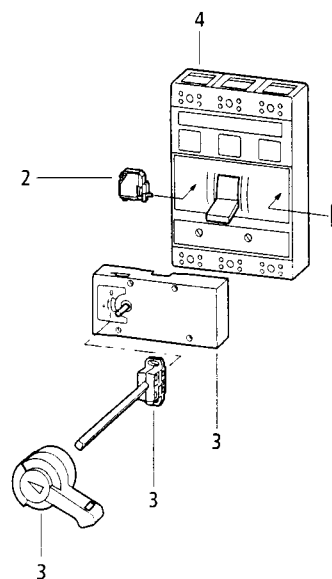

Accessories	Page
1 Auxiliary contacts	09/014
2 Voltage trips	09/016
3 Handles and operators	09/022
4 Terminals	09/028
Other accessories	09/022

## Notes:

UL/CSA Short Circuit Current Rating for Molded Case Switches

with 225A fuse backup:

- 50 kA RMS sym at 600 V AC

with 250A circuit breaker backup:

- 25 kA RMS sym at 480 V AC
- 18 kA RMS sym at 600 V AC

NZM7-...-NA(-M8) molded case switches are virtually identical in construction to the molded case circuit breakers, except that they are manual, non-automatic switches without any overload or overcurrent protective features, and are rated up to 200A.

All molded case switches are UL listed (UL 1087) and CSA certified (C 22.2 Nr. 5.2). They are also in conformity with IEC/EN 60 947-3 (switch-disconnectors) and are CE marked. Consult technical data and Moeller Electric for IEC/EN ratings. Molded case switches are tested to determine their acceptability for continuous operation at their marked rated load. Also, they are tested at 6 times their full ampere rating to cover motor circuit applications and are suitable for use as motor circuit disconnects per Section 430-109 of the NEC and Section 28-602 of the CEC.



## Molded Case Circuit Breakers and Switches

### Auxiliary Contacts for Type NZM7...-NA

Contact sequence

Type suffix

List Price

Article No.  
when ordering with  
basic device

see price  
list

#### NHI Standard auxiliary contact

Simultaneous switching with the main contacts. They can be typically used for signalling, interlocking or switching auxiliary contacts such as a control circuit.

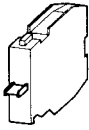

(1) contact sequence when installed in position 1.1  
(2) contact sequence when installed in position 1.2

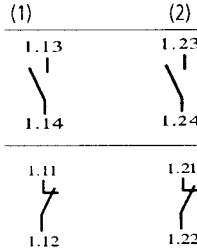

**+EK10**  
051082

**+EK01**  
051083

#### VHI Early-make auxiliary contact

Leading the main contacts when switching ON as well as switching OFF. Ideal for load shedding purposes or in conjunction with voltage trips in control circuits.

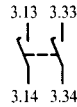
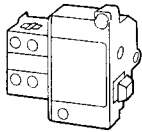

**+VHI-NZM7**  
051085

#### RHI Trip-indicating auxiliary contact

Actuating independently of the normal ON and OFF operations of the device, switching only when the device has tripped due to overcurrents or other tripping causes such as those indicated by voltage trips

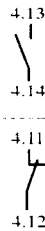
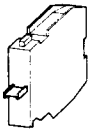

**+EK10**  
051082

**+EK01**  
051083

#### Notes



Auxiliary contacts and voltage trips can be installed as follows:

NHI 2 x EK...	RHI 1 x EK...	VHI	A	AVHI	U	U(V)HI
●	●	●	-	-	-	-
●	●	-	●	-	-	-
●	●	-	-	●	-	-
●	●	-	-	-	●	-
●	●	-	-	-	-	●

Dots in each row represent the types which can be combined together:

- allowed combination
- combination not allowed

# Molded Case Circuit Breakers and Switches

## Auxiliary Contacts for Type NZM7...-NA

Type	List Price	
Article No. when ordering separately <sup>1)</sup>	see price list	
<b>EK10</b> 027039		Two EK... type contacts can be snap-mounted into the circuit breaker or molded case switch
<b>EK01</b> 031785		
<b>VHI-NZM7</b> 051084		One VHI... type contact module per circuit breaker or molded case switch.  Cannot be used in conjunction with the R-NZM 7 remote control drive.
<b>EK10</b> 027039		One EK... type contact (either N.O. or N.C.) can be snap mounted into the circuit breaker or the molded case switch for trip indication
<b>EK01</b> 031785		

<sup>1)</sup> Auxiliary contacts are field installable



# Molded Case Circuit Breakers and Switches

## Shunt Trips for Type NZM7...-NA

Contact diagram

Rated Actuating Voltage  $U_s$

**Type suffix**  
Article No.  
when ordering with basic device

**List Price**  
see price list

V

### Shunt trip

Shunt trips are typically used to electrically trip the device from a remote location. The A...-NZM 7 series is rated for 100% continuous duty. Shunt trips cannot be mounted together with undervoltage trips



Without auxiliary contacts



AC/DC <sup>2)</sup>

12	<b>+A-NZM7(12V)</b> 027640
24	<b>+A-NZM7(24V)</b> 027641
48	<b>+A-NZM7(48V)</b> 027642
60	<b>+A-NZM7(60V)</b> 027643
110 – 120	<b>+A-NZM7(110-120V)</b> 027644
125 – 130	<b>+A-NZM7(125-130V)</b> 027304
208 – 215	<b>+A-NZM7(208-215V)</b> 027305
220 – 240	<b>+A-NZM7(220-240V)</b> 026469
380 – 415	<b>+A-NZM7(380-415V)</b> 027306
440 – 480	<b>+A-NZM7(440-480V)</b> 027307

With early-make auxiliary contacts

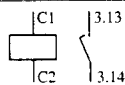

AC/DC <sup>2)</sup>

12	<b>+AVHI-NZM7(12V)</b> 028897
24	<b>+AVHI-NZM7(24V)</b> 028898
48	<b>+AVHI-NZM7(48V)</b> 028899
60	<b>+AVHI-NZM7(60V)</b> 028900
110 – 120	<b>+AVHI-NZM7(110-120V)</b> 028901
125 – 130	<b>+AVHI-NZM7(125-130V)</b> 028902
208 – 215	<b>+AVHI-NZM7(208-215V)</b> 028903
220 – 240	<b>+AVHI-NZM7(220-240V)</b> 026470
380 – 415	<b>+AVHI-NZM7(380-415V)</b> 028904
440 – 480	<b>+AVHI-NZM7(440-480V)</b> 028905



### Notes

Auxiliary contacts and voltage trips can be installed as follows:

NHI 2 x EK...	RHI 1 x EK...	VHI	A	AVHI	U	U(V)HI
●	●	●	-	-	-	-
●	●	-	●	-	-	-
●	●	-	-	●	-	-
●	●	-	-	-	●	-
●	●	-	-	-	-	●

Dots in each row represent the types which can be combined together:

- allowed combination
- combination not allowed

# Molded Case Circuit Breakers and Switches

## Shunt Trips for Type NZM7...-NA

Type	List Price
Article No. when ordering separately <sup>1)</sup>	see price list

<b>A-NZM7(12V)</b> 027360		Suitable for mounting into NZM 7 circuit breakers and molded case switches.  Shunt trips are rated for both AC and DC voltages and can accommodate a frequency range between 0 and 400 Hz.
<b>A-NZM7(24V)</b> 027361		
<b>A-NZM7(48V)</b> 027362		
<b>A-NZM7(60V)</b> 027363		
<b>A-NZM7(110-120V)</b> 027364		
<b>A-NZM7(125-130V)</b> 028831		
<b>A-NZM7(208-215V)</b> 028832		
<b>A-NZM7(220-240V)</b> 026471		
<b>A-NZM7(380-415V)</b> 028833		
<b>A-NZM7(440-480V)</b> 028834		
<b>AVHI-NZM7(12V)</b> 028836		Suitable for mounting into NZM 7 circuit breakers and molded case switches.  Shunt trips are rated for both AC and DC voltages and can accommodate a frequency range between 0 and 400 Hz.  The shunt trip and early-make contacts operate independently of one another. Note: the early-make feature of the contact is not effective when it is combined with R-NZM7 remote control drive.
<b>AVHI-NZM7(24V)</b> 028837		
<b>AVHI-NZM7(48V)</b> 028838		
<b>AVHI-NZM7(60V)</b> 028839		
<b>AVHI-NZM7(110-120V)</b> 028840		
<b>AVHI-NZM7(125-130V)</b> 028841		
<b>AVHI-NZM7(208-215V)</b> 028842		
<b>AVHI-NZM7(220-240V)</b> 028843		
<b>AVHI-NZM7(380-415V)</b> 028844		
<b>AVHI-NZM7(440-480V)</b> 028845		

<sup>1)</sup> Auxiliary contacts are field installable  
<sup>2)</sup> Maximum UL/CSA DC voltage is 125V



## Molded Case Circuit Breakers and Switches

### Undervoltage Trips for Type NZM7...-NA

Contact Diagram	Rated Actuating Voltage $U_s$	Type Suffix Article No. when ordered with basic device	List Price see price list	Type Article No. when ordered separately <sup>1)</sup>	List Price see price list
	V				

#### Undervoltage trip, undelayed

Undervoltage trips will electrically trip the device open under power loss (when supply voltage drops below 35% - 70% of rated trip coil value) and can be used for control interlocking purposes, e.g. to disconnect the main switch in Emergency-stop circuits. They are rated for continuous duty. Undervoltage trips cannot be mounted together with shunt trips.

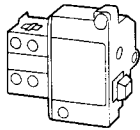

Contact Diagram	Rated Actuating Voltage $U_s$	Type Suffix Article No. when ordered with basic device	Type Article No. when ordered separately <sup>1)</sup>	
D1 U<  D2	AC	24	<b>+U-NZM7(24VAC)</b> 027309	<b>U-NZM7(24VAC)</b> 028847
	48	<b>+U-NZM7(48VAC)</b> 027310	<b>U-NZM7(48VAC)</b> 028848	
	60	<b>+U-NZM7(60VAC)</b> 027311	<b>U-NZM7(60VAC)</b> 028849	
	110 – 120	<b>+U-NZM7(110-120VAC)</b> 027312	<b>U-NZM7(110-120VAC)</b> 028850	
	125 – 130	<b>+U-NZM7(125-130VAC)</b> 027313	<b>U-NZM7(125-130VAC)</b> 028851	
	208 – 215	<b>+U-NZM7(208-215VAC)</b> 027314	<b>U-NZM7(208-215VAC)</b> 028852	
	220 – 240	<b>+U-NZM7(220-240VAC)</b> 027315	<b>U-NZM7(220-240VAC)</b> 027608	
	380 – 415	<b>+U-NZM7(380-415VAC)</b> 027316	<b>U-NZM7(380-415VAC)</b> 065565	
	440 – 480	<b>+U-NZM7(440-480VAC)</b> 027317	<b>U-NZM7(440-480VAC)</b> 028854	
	DC	24	<b>+U-NZM7(24VDC)</b> 027599	<b>U-NZM7(24VDC)</b> 027607
	48	<b>+U-NZM7(48VDC)</b> 027342	<b>U-NZM7(48VDC)</b> 028879	
	60	<b>+U-NZM7(60VDC)</b> 027343	<b>U-NZM7(60VDC)</b> 028880	
	110 – 120	<b>+U-NZM7(110-120VDC)</b> 027344	<b>U-NZM7(110-120VDC)</b> 028881	
	125	<b>+U-NZM7(125-130VDC)</b> 027345	<b>U-NZM7(125-130VDC)</b> 028882	

**Notes**

<sup>1)</sup> Undervoltage trips are field-installable

Auxiliary contacts and voltage trips can be installed as follows:

NHI 2 x EK...	RHI 1 x EK...	VHI	A	AVHI	U	U(V)HI
●	●	●	-	-	-	-
●	●	-	●	-	-	-
●	●	-	-	●	-	-
●	●	-	-	-	●	-
●	●	-	-	-	-	●

Dots in each row represent the types which can be combined together:

- allowed combination
- combination not allowed



# Molded Case Circuit Breakers and Switches

## Undervoltage Trips for Type NZM7...-NA

Circuit Breakers, Disconnect Switches, Molded Case Switches

Contact Diagram	Rated Actuating Voltage $U_s$	Type Suffix Article No. when ordered with basic device	List Price see price list	Type Article No. when ordered separately <sup>2)</sup>	List Price see price list
V					

**Undervoltage trip, undelayed**  
with early-make auxiliary contacts<sup>1)</sup>

Undervoltage trips will electrically trip the device open under power loss (when supply voltage drops below 35% - 70% of rated trip coil value) and can be used for control interlocking purposes, e.g. to disconnect the main switch in Emergency-stop circuits. They are rated for continuous duty. Undervoltage trips cannot be mounted together with shunt trips.

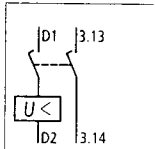
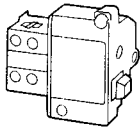

AC	Rated Actuating Voltage $U_s$	Type Suffix Article No. when ordered with basic device	List Price see price list	Type Article No. when ordered separately <sup>2)</sup>	List Price see price list
AC	24	<b>+UHI-NZM7(24VAC)</b> 027319		<b>UHI-NZM7(24VAC)</b> 028856	
	48	<b>+UHI-NZM7(48VAC)</b> 027320		<b>UHI-NZM7(48VAC)</b> 028857	
	60	<b>+UHI-NZM7(60VAC)</b> 027321		<b>UHI-NZM7(60VAC)</b> 028858	
	110 - 120	<b>+UHI-NZM7(110-120VAC)</b> 027322		<b>UHI-NZM7(110-120VAC)</b> 028859	
	125 - 130	<b>+UHI-NZM7(125-130VAC)</b> 027323		<b>UHI-NZM7(125-130VAC)</b> 028860	
	208 - 215	<b>+UHI-NZM7(208-215VAC)</b> 027324		<b>UHI-NZM7(208-215VAC)</b> 028861	
	220 - 240	<b>+UHI-NZM7(220-240VAC)</b> 027602		<b>UHI-NZM7(220-240VAC)</b> 027610	
	380 - 415	<b>+UHI-NZM7(380-415VAC)</b> 027325		<b>UHI-NZM7(380-415VAC)</b> 028862	
	440 - 480	<b>+UHI-NZM7(440-480VAC)</b> 027326		<b>UHI-NZM7(440-480VAC)</b> 028863	
	DC	24	<b>+UHI-NZM7(24VDC)</b> 027601		<b>UHI-NZM7(24VDC)</b> 027609
48		<b>+UHI-NZM7(48VDC)</b> 027351		<b>UHI-NZM7(48VDC)</b> 028888	
60		<b>+UHI-NZM7(60VDC)</b> 027352		<b>UHI-NZM7(60VDC)</b> 028889	
110 - 120		<b>+UHI-NZM7(110-120VDC)</b> 027353		<b>UHI-NZM7(110-120VDC)</b> 028890	
125		<b>+UHI-NZM7(125-130VDC)</b> 027354		<b>UHI-NZM7(125-130VDC)</b> 028891	

**Notes**

- <sup>1)</sup> Cannot be used in conjunction with R-NZM 7 remote control drive
- <sup>2)</sup> Undervoltage trips are field-installable



**Molded Case Circuit Breakers and Switches**

Remote Control Drive for Type NZM7...-NA

Rated  
Actuating  
Voltage  $U_s$ **Type Suffix**  
Article No.  
when ordered with basic  
device**List Price**  
see price list

V

**Remote Control Drive**

Operates the NZM 7 circuit breaker or molded case switch electrically from a remote location.  
Switching times: ON 100ms, OFF 100ms  
Local manual operation of the switch possible

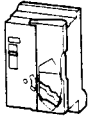

AC/DC	110 – 120	<b>+R-NZM7(110-120V)</b> 027634
AC/DC	220 – 240	<b>+R-NZM7(220-240V)</b> 026473
DC	24	<b>+R-NZM7(24V)</b> 027632
DC	48 – 60	<b>+R-NZM7(48-60V)</b> 027633





# Molded Case Circuit Breakers and Switches

## Remote Control Drive for Type NZM7...-NA

Type	List Price
Article No. when ordered separately <sup>1)</sup>	see price list

<b>R-NZM7(110-120V)</b> 027637
<b>R-NZM7(220-240V)</b> 026474
<b>R-NZM7(24V)</b> 027635
<b>R-NZM7(48-60V)</b> 027636

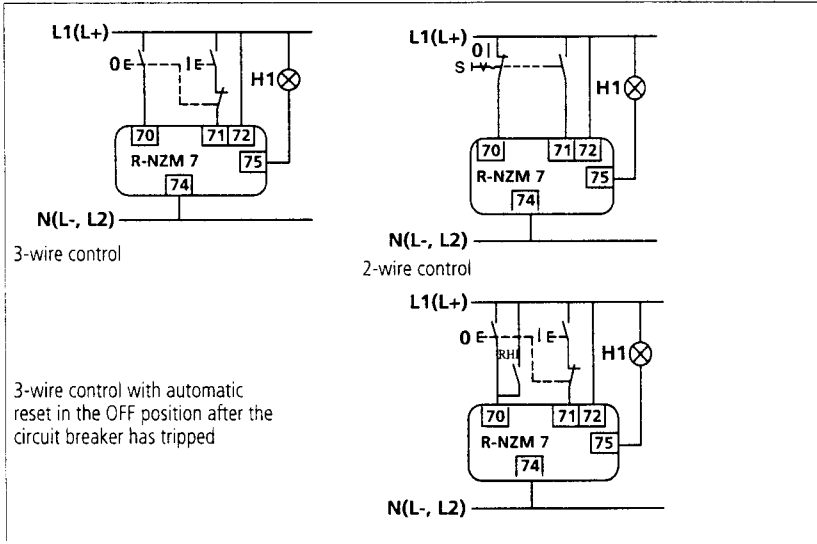

**Notes:**

<sup>1)</sup> Remote control drives are field installable



**Molded Case Circuit Breakers and Switches**

## Accessories for Type NZM7...-NA

**Type Suffix**Article No.  
when ordered with basic device**List Price**

see price list

**Insulating frame for door cutout**Fits around the cutout area of the panel door through which the toggle mechanism on the front of the switch protrudes  
Degree of protection IP 40**+RT-NZM7**  
051093**Rotary drive mechanism**

Converts ON and OFF switching from a toggle motion to a rotary motion

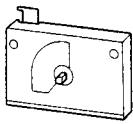

Without padlocking feature

**+DAOV-NZM7**  
051328

With additional padlocking feature

**+DA-NZM7**  
051097**Rotary handle for open or panel-mounted switches**Black color  
Rotary drive mechanism required  
Fastens to shaft, not padlockable**+HU-NZM7**  
051487**Handle for cover/door interlocking**Degree of protection UL/NEMA 12, IP 55,<sup>1)</sup>  
Door coupling rotary handle. For front mounting in doors and covers.  
Rotary drive mechanism required

Black color (standard)

**+H-NZM7**  
051712Red-yellow  
For use as Emergency-stop main disconnect switch  
per IEC/EN 60 204-1 (CE, Machinery Directive)**+RH-NZM7**  
052141

Black, without padlocking feature

**+HOV-NZM7**  
051714**Extension shaft**

Can be cut to required length

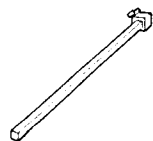

For mounting depths in the range of 175 – 400 mm

**+A400-NZM7**  
052741

For mounting depths in the range of 260 – 600 mm

**+A600-NZM7**  
052927**Notes**<sup>1)</sup> IP 65, when mounted vertically

# Molded Case Circuit Breakers and Switches

Accessories for Type NZM7...-NA

Type Article No. when ordered separately	List Price see price list	
<b>RT-NZM7</b> 051092		Fastened from the back using screws. can be inscribed.
<b>DAOV-NZM7</b> 051327		
<b>DA-NZM7</b> 051096		Can be locked in the OFF position with up to 3 padlocks. Hasp thickness 4 - 8 mm
<b>HU-NZM7</b> 051329		
<b>H-NZM7</b> 051711		Door/cover interlocking supplied standard set in OFF position. 3 distinct handle positions: <b>OFF</b> - + (tripped) - <b>ON</b>  Handles can be locked in the OFF or ON position with up to 3 padlocks. Hasp thickness 4 - 8 mm.  Handle position is fixed when door or cover is open.
<b>RH-NZM7</b> 052089		
<b>HOV-NZM7</b> 051713		Same features as H-NZM7, except that the padlocking feature is omitted
<b>A400-NZM7</b> 052572		
<b>A600-NZM7</b> 053373		



## Molded Case Circuit Breakers and Switches

### Accessories for Type NZM7...-NA

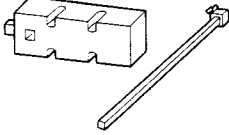
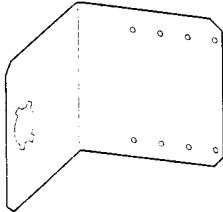
	Type Suffix	List Price
	Article No. when ordered with basic device	see price list
<b>Side wall operator</b>		
Enables actuation of the switch from its left or right side as opposed to the front for operation on the left	<b>+SWA-NZM7-L</b> 054520	
		
for operation on the right	<b>+SWA-NZM7-R</b> 054522	
<b>Mounting bracket for side panel mounting</b>		
For mounting the switch directly into the side panel of the enclosure	<b>+MSWA-NZM7</b> 054524	
		
<b>Main disconnect switch assembly kits</b>		
For CE marked control panels per IEC/EN 60 204-1 (CE Machinery Directive)		
With door-interlocking rotary handle. Color: black (standard) for main disconnect function	<b>+V-NZM7-SW</b> 065590	
With door-interlocking rotary handle. Color: red-yellow for main disconnect switches fulfilling the Emergency-stop function	<b>+V-NZM7</b> 061543	
<b>Main disconnect switch assembly kits for side wall installation</b>		
With black rotary handle		
for operation on the left	<b>+EA-NZM-7-L</b> 205049	
for operation on the right	<b>+EA-NZM-7-R</b> 205051	
With red-yellow rotary handle, for use as Emergency-stop devices to IEC/EN 60 204-1 (CE Machinery Directive)		
for operation on the left	<b>+EA-RT-NZM-7-L</b> 205053	
for operation on the right	<b>+EA-RT-NZM-7-R</b> 205055	
<b>External warning plate</b>		
"Main Switch - Open only in OFF Position"		
English	<b>+ZFS 62-NZM7</b> 065937	
French	<b>+ZFS 63-NZM7</b> 065938	
Other languages are available with this article and type number	<b>+ZFS...NZM7</b> 108821	
Blank Can be engraved and printed	<b>+ZFS 60-NZM7</b> 065895	



# Molded Case Circuit Breakers and Switches

Accessories for Type NZM7...-NA

Type	List Price																					
Article No. when ordered separately	see price list																					
<b>SWA-NZM7-L</b> 054519		<p>The SWA... shifts the rotary movement of the switch by 90° and permits the rotary handle to mount and actuate the switch from the side of the control panel enclosure.</p> <p>The SWA... mechanism mounts directly on top of the DA(OV) rotary drive mechanism.</p> <p>An extension shaft (280mm) with a special coupling piece is supplied with the unit.</p>																				
<b>SWA-NZM7-R</b> 054521																						
<b>MSWA-NZM7</b> 054523		For use only with SWA... side wall operator equipped switches																				
<b>V-NZM7-SW</b> 065589		<p>These kits provide the necessary accessories to fulfill the main disconnect switch function per the Machinery Directive standard IEC 60 204-1.</p> <p>Note: in cases where the main disconnect switch also fulfills the Emergency-stop function, please specify kits containing red handle and yellow backing plate assemblies.</p> <p>Kits contain:</p> <ul style="list-style-type: none"> <li>• Door coupling rotary handle</li> <li>• DAOV rotary drive</li> <li>• Extension shaft for 400mm mounting depth</li> <li>• External warning plate</li> <li>• Black lightning symbol</li> </ul>																				
<b>V-NZM7</b> 061453																						
<b>EA-NZM-7-L</b> 205050		<p>Kits contain:</p> <ul style="list-style-type: none"> <li>• Door coupling rotary handle</li> <li>• DAOV rotary drive</li> <li>• Side wall operator with extension shaft</li> <li>• Mounting brackets</li> <li>• External warning plate</li> <li>• Black lightning symbol</li> </ul>																				
<b>EA-NZM-7-R</b> 205052																						
<b>EA-RT-NZM-7-L</b> 205054																						
<b>EA-RT-NZM-7-R</b> 205056																						
<b>ZFS 62-NZM7</b> 065957		<table> <tbody> <tr> <td>61 German</td> <td>73 Romanian</td> </tr> <tr> <td>64 Bulgarian</td> <td>74 Russian</td> </tr> <tr> <td>65 Danish</td> <td>75 Swedish</td> </tr> <tr> <td>66 Finnish</td> <td>76 Serbo-croatian</td> </tr> <tr> <td>67 Dutch</td> <td>77 Spanish</td> </tr> <tr> <td>68 Italian</td> <td>78 Czech</td> </tr> <tr> <td>69 Greek</td> <td>79 Turkish</td> </tr> <tr> <td>70 Norwegian</td> <td>80 Hungarian</td> </tr> <tr> <td>71 Polish</td> <td>81 Afrikaans</td> </tr> <tr> <td>72 Portuguese</td> <td></td> </tr> </tbody> </table> <p>To obtain warning plates in other languages, insert the language code number into the type reference.</p> <p><b>Example</b> External warning plate in Spanish: ZFS 77-NZM7</p>	61 German	73 Romanian	64 Bulgarian	74 Russian	65 Danish	75 Swedish	66 Finnish	76 Serbo-croatian	67 Dutch	77 Spanish	68 Italian	78 Czech	69 Greek	79 Turkish	70 Norwegian	80 Hungarian	71 Polish	81 Afrikaans	72 Portuguese	
61 German	73 Romanian																					
64 Bulgarian	74 Russian																					
65 Danish	75 Swedish																					
66 Finnish	76 Serbo-croatian																					
67 Dutch	77 Spanish																					
68 Italian	78 Czech																					
69 Greek	79 Turkish																					
70 Norwegian	80 Hungarian																					
71 Polish	81 Afrikaans																					
72 Portuguese																						
<b>ZFS 63-NZM7</b> 065958																						
<b>ZFS...NZM7</b> 108822																						
<b>ZFS 60-NZM7</b> 065896																						



## Molded Case Circuit Breakers and Switches

### Accessories for Type NZM7...-NA

Type Suffix	List Price
Article No. when ordered with basic device	see price list

#### Mechanical interlock

For interlocking two type NZM7-... circuit breakers or molded-case switches of the same size

3-pole	-	-
--------	---	---

#### Paralleling mechanism

For simultaneous operation of 2 molded case switches, mounted side by side, using a rotary drive

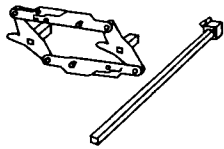

#### Clip plate

For mounting type NZM7-... circuit breakers or molded case switches onto a DIN top hat rail, conforming to EN 50 022

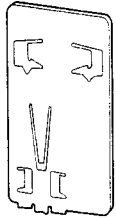

<b>+C-NZM7</b> 054526	-	-
--------------------------	---	---



# Molded Case Circuit Breakers and Switches

Accessories for Type NZM7...-NA

---

**Type**

Article No.  
when ordered separately

**List Price**

see price list

---

**KV 2-NZM7**  
200468

---

**K 2-P7**  
054517

Extension shaft for 400mm mounting depth included

Not to be used with shunt or undervoltage trip  
Not for circuit breaker

---

**C-NZM7**  
054525

Clip plate is not suitable for switches equipped with R-  
NZM7 remote control drives



## Molded Case Circuit Breakers and Switches

### Terminal Connections for Type NZM7...-NA

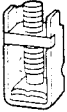
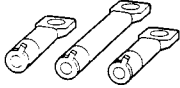
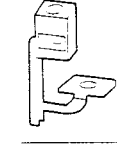
	Type Suffix	List Price	Type	List Price
	Article No. when ordered with basic device	see price list	Article No. when ordered separately	see price list
<b>Terminal kits</b>				
Box terminals for copper conductors 3 per set Terminal cover removable, conductor can be laid in from the front. 1 conductor: # 12 AWG - 1 x 300MCM <sup>1)</sup> 2 conductors: # 12 AWG - 250MCM <sup>1)</sup>				
For 3-pole switches				
	for up to 125A circuit breakers and up to 150A molded-case switches	<b>+K150-NZM7-O</b> 028909	-	
		<b>+K150-NZM7-U</b> 058772	-	
	for 150A circuit breakers and 200A molded-case switches	<b>+K185-NZM7-O</b> 215428	-	
		<b>+K185-NZM7-U</b> 215429	-	
<b>Rear terminal bolts</b>				
For connection of cable lugs or flat copper strips With M8 internal thread 1 kit consists of • 2 short terminal bolts • 1 long terminal bolt				
For 3-pole switches				
		<b>+RG250-NZM7-O</b> 065579	<b>RG250-NZM7</b> 202936	
		<b>+RG250-NZM7-U</b> 065578	-	
<b>Control circuit tap-off terminals</b>				
Installed on the upper and/or lower field-wiring terminals of circuit breakers and molded-case switches 1 terminal supplied when ordered separately 2 terminals supplied when ordered with basic unit Control circuit wire range: AWG 14 ... 18; Cu only				
	For circuit breakers and molded case switches with terminal connectors	<b>+ST250-NZM7-O</b> 065582	<b>ST250-NZM7</b> 037096	
		<b>+ST250-NZM7-U</b> 065583		
	For circuit breakers and molded-case switches with bolt-on connection terminals	<b>+STM8-NZM7-O</b> 065587	<b>STM8-NZM7</b> 065588	
		<b>+STM8-NZM7-U</b> 065586		

**Notes**

- <sup>1)</sup> Use ferrules with flexible wire  
-O = mounted at the top  
-U = mounted at the bottom



# Notes

---



# Molded Case Circuit Breakers and Switches, 600 A, 600 V AC

Type NZM 10... Overview

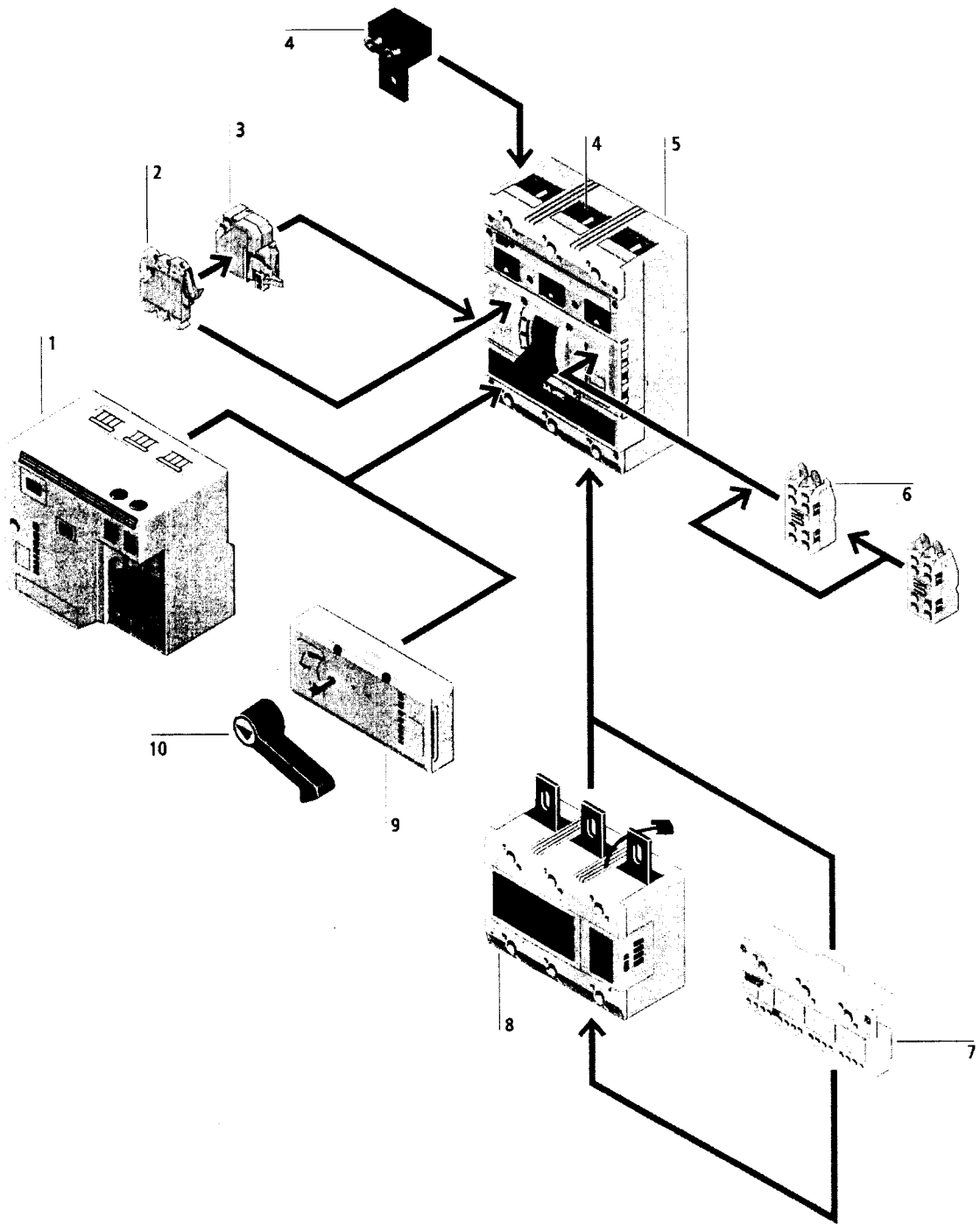

### Basic devices

#### Molded case circuit breaker 5

600 V AC, 600 A rating

Up to 100 kA @ 480 V AC interrupting rating

Standard and fuseless current-limiting version

Solid-state trip

Field installable accessories

Supplied with terminals for cable hookup or bolt-on connection

UL listed (UL 489),  
CSA certified (C 22.2 # 5.1)

Conformity with IEC/EN 60 947-2  
(Circuit Breakers)

→ page 09/034

#### Molded case switch 5

600 V AC, 600 A rating

Field installable accessories

UL listed (UL 1087),  
CSA certified (C 22.2 No. 5.2)

Conformity with IEC/EN 60 947-3  
(Switch-disconnector)

→ page 09/039

### Add-on functions

#### NHI standard auxiliary contact 6

Signalling ON and OFF positions

Suitable for actuation from PLC

→ page 09/042

#### VHI early-make auxiliary contact 2

For interlocking and load shedding purposes

To power up the undervoltage trip prior to main contact closing

→ page 09/042

#### RHI trip-indicating auxiliary contact 6

For signalling the tripped ("+") position

→ page 09/042

#### Signalling block 7

Differential fault indication

Overload early warning signal for load shedding purposes

Local or remote signalling of breaker status

Local, remote or automatic reset

→ page 09/042

#### Voltage releases 3

Shunt trip

- AC and DC versions

Undervoltage trip

- non-delayed
- off-delayed

→ page 09/043

#### Ground fault trip module 8

Plugs directly into the breaker or mounts separately

Not fed from separate power source

Adjustable ground fault trip and time delay settings

Automatic reset

→ page 09/044

#### Remote control drive 1

Electric operation of the circuit breaker from a remote location:

- Remote ON/OFF
- Remote reset after trip

Local manual operation possible

Padlockable OFF position

→ page 09/045

#### Rotary drive mechanism 9

Converts toggle switch operation of the switch into a rotary movement suitable for rotary style operators

Lockable in OFF position

#### Rotary handle 10

To operate switch equipped with rotary drive mechanism

→ page 09/046

### Terminal connections 4

Pressure wire terminations for cable connection

Bolt-on connection for crimped lug or busbar

Terminal covers for additional protection against shock hazards

→ page 09/051



# Molded Case Circuit Breakers and Switches

## Type NZM10... Overview of Combination Options

Type	Solid state trip modules			Auxiliary contacts NHI...: standard RHI...: trip-indicating VHI...: early-make			Signalling block
	ZM(A)...-NA 250 400 600	ZMV(A)...-NA 250 400 600	VHI-NZM 10 not in conjunction with R-NZM 10	NHI- NZM 10	RHI- NZM 10		M- NZM 10

### Molded-case circuit breaker

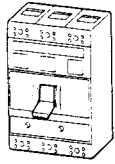

NZM 10...N(S)/ZM(V)(A)...-NA	◆	◆	◆	or	◆	◆	◆	●	●	●	●
NZM 10...H/ZM(A)...-NA	◆	◆	◆	-	-	-	-	●	●	●	●

### Molded-case switches

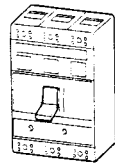

NZM 10...N/B-NA	-	-	-	-	-	-	-	●	●	●	-
-----------------	---	---	---	---	---	---	---	---	---	---	---

### Circuit breakers with remote operator

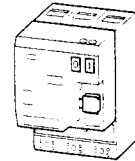

NZM 10...N(S)/ZM(V)(A)...-NA +R-NZM 10	◆	◆	◆	or	◆	◆	◆	●	●	-	●
NZM 10...H/ZM(A)...-NA +R-NZM 10	◆	◆	◆	-	-	-	-	●	●	-	●

### Molded-case switch with remote operator

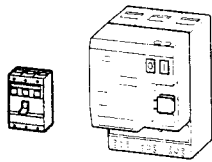

NZM 10...N/B-NA +R-NZM 10	-	-	-	-	-	-	-	●	●	-	-
------------------------------	---	---	---	---	---	---	---	---	---	---	---

### Circuit breaker switch blocks without trip modules

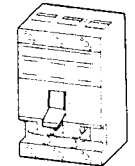









										with ZM(V)
NZM 10-400N-NA	●	●	-	●	●	-	●	●	●	●
NZM 10-400S-NA	●	●	-	●	●	-	●	●	●	●
NZM 10-400H-NA	●	●	-	-	-	-	●	●	●	●
NZM 10-600N-NA	●	●	●	●	●	●	●	●	●	●
NZM 10-600S-NA	●	●	●	●	●	●	●	●	●	●
NZM 10-600H-NA	●	●	●	-	-	-	●	●	●	●

### Notes

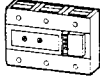
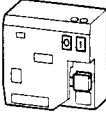
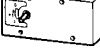
- Options for combination
- ◆ Included as standard

# Molded Case Circuit Breakers and Switches

## Type NZM10... Overview of Combination Options

Voltage trips ^ ...: shunt trip ...: undervoltage trip		Ground fault trip	Remote control drive	Rotary drive mechanism Rotary handle Door-coupling rotary handle			Terminals Bolt-on connection included as standard			
										
A- NZM 10	U- NZM 10	TV- NZM 10	R- NZM 10	D- NZM 10	H 10U- NZM 10	(R)H 10- NZM 10	K 300- NZM 10	K 2x120- NZM 10	K 2x240- NZM 10	K 22x21- NZM 10 (for flexibus only)

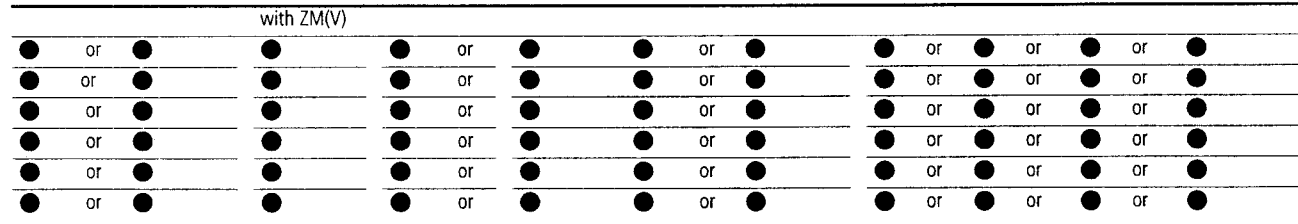
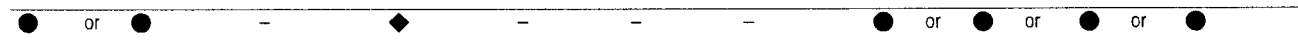
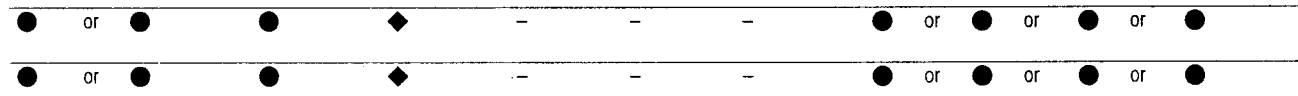

# Inverse Time Circuit Breakers, 600 A, 600 V AC

## Solid State Trip Type NZM 10-...-NA

UL / CSA / IEC/EN 60 947-2 / CE

**Normal Interrupting Capacity****42 kA** at 480 V 50/60 Hz**35 kA** at 600 V 50/60 Hz**Type**

Article No.

**List Price**

see price list

Long time  
response  
current setting

## Setting ranges

Adjustable  
instantaneous  
pick-up setting $I_r$   
A

A

**NZM 10-.../ZMA-...-NA**

With fixed long time response settings

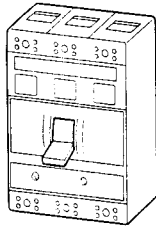

150	300 - 1800	<b>NZM10-400N/ZMA-150-NA</b> 226744
175	350 - 2100	<b>NZM10-400N/ZMA-175-NA</b> 226745
200	400 - 2400	<b>NZM10-400N/ZMA-200-NA</b> 093938
225	450 - 2700	<b>NZM10-400N/ZMA-225-NA</b> 093939
250	500 - 3000	<b>NZM10-400N/ZMA-250-NA</b> 093975
300	600 - 3600	<b>NZM10-400N/ZMA-300-NA</b> 093993
350	700 - 4200	<b>NZM10-400N/ZMA-350-NA</b> 093824
400	800 - 4800	<b>NZM10-400N/ZMA-400-NA</b> 093825
500	1000 - 6000	<b>NZM10-600N/ZMA-500-NA</b> 093915
600	1200 - 7200	<b>NZM10-600N/ZMA-600-NA</b> 093916

**NZM 10-.../ZM-...-NA**

With adjustable long time response settings

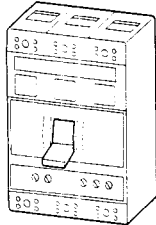

125 - 250	250 - 3000	<b>NZM10-400N/ZM-250-NA</b> 226750
200 - 400	400 - 4800	<b>NZM10-400N/ZM-400-NA</b> 093914
300 - 600	600 - 7200	<b>NZM10-600N/ZM-600-NA</b> 093913



Type **NZM10-...(N)(S)/ZM(A)-...-NA** molded-case circuit breakers are UL listed (UL 489) and CSA certified (22.2 No. 5.1) Inverse Time, Solid State Trip Circuit Breakers with a fixed or adjustable long time response and adjustable instantaneous pick-up range.

Type **NZM10-...H/ZM(A)-...-NA** molded case circuit breakers are UL listed (UL 489) and CSA certified (22.2 Nor. 5.1) Current-limiting Inverse Time, Solid State Trip Circuit Breakers with a fixed or adjustable long time response and adjustable instantaneous pick-up range.

**Notes:**

- <sup>1)</sup> NZM10 circuit breakers and molded-case switches are supplied with toggle operator. Consult page 09/046 for additional handle types.
- <sup>2)</sup> NZM10 circuit breakers and molded-case switches are supplied with bolt-on connection as standard. For line and load field-wiring terminals for cable connection, refer to page 09/051 for details on available terminals.

# Inverse Time Circuit Breakers, 600 A, 600 V AC

## Solid State Trip Type NZM 10-...-NA

UL / CSA / IEC/EN 60 947-2 / CE

Circuit Breakers, Disconnect Switches, Molded Case Switches

<b>Medium Interrupting Capacity</b> <b>65 kA</b> at 480 V 50/60 Hz <b>42 kA</b> at 600 V 50/60 Hz Type Article No.		<b>High Interrupting Capacity</b> <b>100 kA</b> at 480 V 50/60 Hz <b>50 kA</b> at 600 V 50/60 Hz Type Article No.	
List Price see price list		List Price see price list	

Fuseless current limiting circuit breaker

NZM10-400S/ZMA-150-NA 226746	NZM10-400H/ZMA-150-NA 226748
NZM10-400S/ZMA-175-NA 226747	NZM10-400H/ZMA-175-NA 226749
NZM10-400S/ZMA-200-NA 093880	NZM10-400H/ZMA-200-NA 093705
NZM10-400S/ZMA-225-NA 093881	NZM10-400H/ZMA-225-NA 093706
NZM10-400S/ZMA-250-NA 093918	NZM10-400H/ZMA-250-NA 093707
NZM10-400S/ZMA-300-NA 093919	NZM10-400H/ZMA-300-NA 093708
NZM10-400S/ZMA-350-NA 093944	NZM10-400H/ZMA-350-NA 093709
NZM10-400S/ZMA-400-NA 093979	NZM10-400H/ZMA-400-NA 093710
NZM10-600S/ZMA-500-NA 093854	NZM10-600H/ZMA-500-NA 093703
NZM10-600S/ZMA-600-NA 093879	NZM10-600H/ZMA-600-NA 093704
NZM10-400S/ZM-250-NA 226751	NZM10-400H/ZM-250-NA 226752
NZM10-400S/ZM-400-NA 093853	NZM10-400H/ZM-400-NA 093702
NZM10-600S/ZM-600-NA 093826	NZM10-600H/ZM-600-NA 093701

Notes

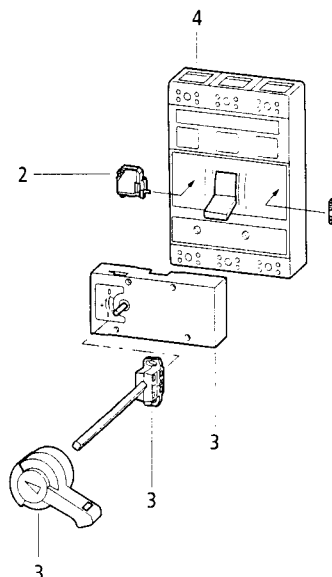

Accessories	Page
1 Auxiliary contacts	09/042
2 Voltage trips	09/043
3 Handles and operators	09/045
4 Terminals	09/051
Other accessories	09/046

UL/CSA Interrupting Ratings (AC, 60Hz)

Type	RMS sym. kA at		
	240V	480V	600V
NZM 10-...N/ZM(A)-...-NA	65	42	35
NZM 10-...S/ZM(A)-...-NA	100	65	42
NZM 10-...H/ZM(A)-...-NA	200	100	50



**Inverse Time Circuit Breakers, 600 A, 600 V AC**  
Solid State Trip Type NZM 10-...-NA

UL / CSA / IEC/EN 60 947-2 / CE

**Normal Interrupting Capacity**

**42 kA** at 480 V 50/60 Hz  
**35 kA** at 600 V 50/60 Hz

Long time response current setting	Setting ranges	
	Adjustable instantaneous pick-up setting	Adjustable short-time delay pick-up setting for selectivity in networks Time delay range: 0 - 1000 ms delayed
$I_r$ A	A	A

**Type**  
Article No.

**List Price**  
see price list

NZM 10-.../ZMVA-...-NA  
with fixed long time response settings  
with short-time delay pick-up for selectivity

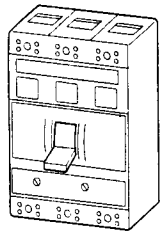

200	1000 - 9000	2 - 12 x $I_r$	<b>NZM10-400N/ZMVA-200-NA</b> 093713
225			<b>NZM10-400N/ZMVA-225-NA</b> 093714
250			<b>NZM10-400N/ZMVA-250-NA</b> 093715
300			<b>NZM10-400N/ZMVA-300-NA</b> 093716
350			<b>NZM10-400N/ZMVA-350-NA</b> 093717
400			<b>NZM10-400N/ZMVA-400-NA</b> 093718
500			<b>NZM10-600N/ZMVA-500-NA</b> 093719
600			<b>NZM10-600N/ZMVA-600-NA</b> 093720

NZM 10-.../ZMV-...-NA  
with adjustable long time response settings  
with short-time delay pick-up for selectivity

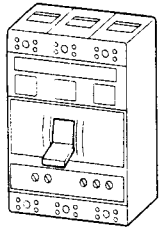

200 - 400	1000 - 9000	400 - 4800	<b>NZM10-400N/ZMV-400-NA</b> 093711
300 - 600	1000 - 9000	600 - 7200	<b>NZM10-600N/ZMV-600-NA</b> 093712



Type **NZM10-...(N)(S)/ZMV(A)-...-NA** are UL listed (UL 489) and CSA certified (22.2 No. 5.1) and have an additional short-time delay pick-up range for selectivity in energy distribution networks. The time delay response is adjustable from 0 to 1000 milliseconds.

Features of ZMV(A) trip modules used for selectivity:

- Fixed (ZMVA....) or adjustable (ZMV....) long time response current
- Adjustable time delay (2 - 4 - 6 - 8 - 10 - 12 - 14 - 17 - 20 sec.) for current levels at 6 times the long time response current ( $I_r$ )
- Long time response current can be disconnected
- Adjustable time delay (0 - 10 - 50 - 100 - 150 - 200 - 300 - 500 - 750 - 1000 ms) pick-up setting
- Adjustable instantaneous pick-up response

**Notes:**

- <sup>1)</sup> NZM10 circuit breakers and molded-case switches are supplied with toggle operator. Consult page 09/046 for additional handle types.
- <sup>2)</sup> NZM10 circuit breakers and molded-case switches are supplied with bolt-on connection as standard. For line and load field-wiring terminals for cable connection, refer to page 09/051 for details on available terminals.



**Inverse Time Circuit Breakers, 600 A, 600 V AC**  
 Solid State Trip Type NZM 10-...-NA

UL / CSA / IEC/EN 60 947-2 / CE

**Medium Interrupting Capacity**

**65 kA** at 480 V 50/60 Hz  
**42 kA** at 600 V 50/60 Hz

**Type** **List Price**  
 Article No. see price list

<b>NZM10-400S/ZMVA-200-NA</b> 093725	
<b>NZM10-400S/ZMVA-225-NA</b> 093726	
<b>NZM10-400S/ZMVA-250-NA</b> 093727	
<b>NZM10-400S/ZMVA-300-NA</b> 093728	
<b>NZM10-400S/ZMVA-350-NA</b> 093729	
<b>NZM10-400S/ZMVA-400-NA</b> 093730	
<b>NZM10-600S/ZMVA-500-NA</b> 093724	
<b>NZM10-600S/ZMVA-600-NA</b> 093723	

<b>NZM10-400S/ZMV-400-NA</b> 093722	
<b>NZM10-600S/ZMV-600-NA</b> 093721	

**UL/CSA Interrupting Ratings (AC, 60Hz)**

Type	240V	RMS sym. kA at	
		480V	600V
NZM 10-...N/ZMV(A)-...-NA	65	42	35
NZM 10-...S/ZMV(A)-...-NA	100	65	42

**Notes**

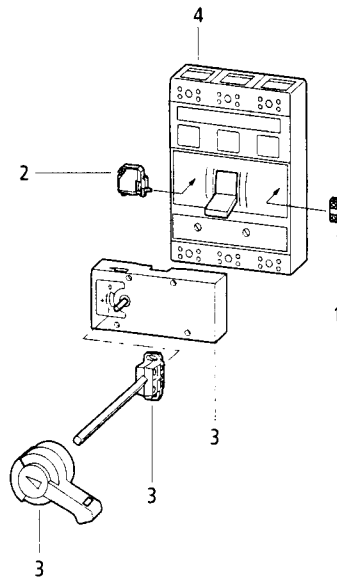

Accessories	Page
1 Auxiliary contacts	09/042
2 Voltage trips	09/043
3 Handles and operators	09/045
4 Terminals	09/051
Other accessories	09/046



## Molded Case Circuit Breakers - Instantaneous Trip Type, 600A

NZM10-.../ZM-...-OBI...-CNA

Rating Data			Type	List Price
Frame Rating	Continuous Current Rating	Adjustable Instantaneous Trip Response Range	Article No.	see price list
	A	A		

### Solid state instantaneous trip circuit breakers

600V AC, UL/CSA  
Normal level short-circuit rating

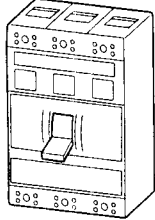

600A	250	500 ... 3000	<b>NZM10-400N/ZM-250-OBI-CNA</b> 226753
	400	800 ... 4800	<b>NZM10-400N/ZM-400-OBI-CNA</b> 093912
	600	1200 ... 7200	<b>NZM10-600N/ZM-600-OBI-CNA</b> 093911

### Solid state instantaneous trip circuit breakers

600V AC, UL/CSA  
High level short-circuit rating

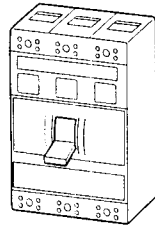

600A	250	500 ... 3000	<b>NZM10-400H/ZM-250-OBI-CNA</b> 226754
	400	800 ... 4800	<b>NZM10-400H/ZM-400-OBI-CNA</b> 093700
	600	1200 ... 7200	<b>NZM10-600H/ZM-600-OBI-CNA</b> 093999



### Notes

UL recognized (UL 489) and CSA certified (C22.2 Nr. 5.1) Instantaneous trip type circuit breaker with an adjustable trip function.

Per NEC and CEC, they provide motor short circuit protection as part of a listed combination motor controller that includes coordinated motor overload protection. Short-circuit interrupting ratings are, therefore, established and valid only for the listed combination motor controller assembly and associated housing or enclosure.

The NZM10...H instantaneous trip circuit breaker features a current limiting design contact assembly and can provide high fault short-circuit current ratings for motor starters up to 65kA @ 480 V AC.

NZM 10 circuit breakers are supplied with toggle operator. Consult page 09/046 for additional handle types

NZM 10 circuit breakers are supplied standard with bolt-on connection. For load and line field-wiring terminals for cable connection, see page 09/051 for details on available terminals

**Molded Case Switches, 600 A, 600 V AC**

UL / CSA / IEC / EN 60 947-3 / CE

Type NZM10-...-NA

Circuit Breakers, Disconnect Switches, Molded Case Switches

Ampere Rating	Type Article No.	List Price se price list
A		

**Molded-case switches**

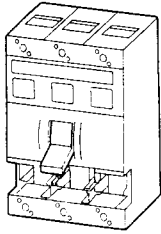

400	<b>NZM10-400 N/B-NA</b> 063929	
630	<b>NZM10-600 N/B-NA</b> 063928	

Type NZM10-...N/B-NA molded case switches are virtually identical in construction to NZM 10 molded case circuit breakers except that they are manual, non-automatic switches without any overload or overcurrent protective features. They are equally rated up to 600A. All molded-case switches are UL listed (UL 1087) and CSA certified (C 22.2 Nr. 5.2), in conformity with IEC/EN 60 947-3 (switch disconnectors) and CE marked.

Molded-case switches are tested to determine their acceptability for continuous operation at their marked rated load. In addition, they are tested at six times their full ampere rating to cover motor circuit applications and are suitable for use as motor circuit disconnects per NEC section 430-109 and CEC section 28-602.

NZM 10 molded case switches are supplied with toggle operator. Consult page 09/046 for additional handle types

NZM 10 molded case switches are supplied standard with bolt-on connection. For load and line field-wiring terminals for cable connection, see page 09/051 for details on available terminals

**Notes**

**UL/CSA**

Short circuit current rating  
25 kA rms sym. @ 600 V AC

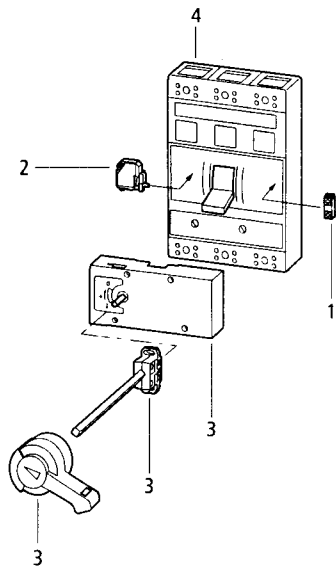

**Accessories**

Accessories	Page
1 Auxiliary contacts	09/042
2 Voltage trip	09/043
3 Operators	09/045
4 Terminals	09/051
Other accessories	09/046

Accessories such as voltage trips, auxiliary contacts, rotary handles etc. are common to all NZM10 circuit breakers and molded case switches are UL listed and CSA certified for field installation



# Inverse Time Circuit Breaker Components, 600 A, 600 VAC

## Type NZM 10-...-NA Switch Blocks, Solid State Trip Modules

UL / CSA / IEC / EN 60 947-2 / CE

NZM10 inverse time molded case circuit breakers are made up of a switch block and a protective trip module. Switch blocks and trip modules can be ordered separately and combined per the charts and columns shown here to suit any particular application.

Switch block ratings  
Continuous current

Trip module setting ranges

Long time response current setting

Adjustable instantaneous pick-up setting

Adjustable short time delay pick-up setting for selectivity in networks

Compatibility of switch block with trip module

Dots (●) in each row indicate which trip module can be used with the switch block type shown below. Dashes (-) indicate incompatibility

Refer to chart at bottom of opposite page for resulting interrupting ratings.

$I_u$   
A

$I_r$   
A

A

A

**NZM10-400...**    **NZM10-600...**

### Switch blocks, suitable for insertion of trip modules

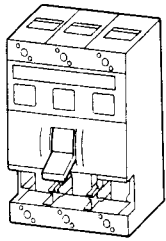

400
400
400
600
600
600

### Solid State Trip Modules

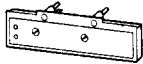

with fixed long time response settings

150	300 - 1800
175	350 - 2100
200	400 - 2400
225	450 - 2700
250	500 - 3000
300	600 - 3600
350	700 - 4200
400	800 - 4800
500	1000 - 6000
600	1200 - 7200

●	●
●	●
●	●
●	●
●	●
●	●
●	●
●	●
-	●
-	●

with adjustable long time response settings

125 - 250	250 - 3000
200 - 400	400 - 4800
300 - 600	600 - 7200

●	●
●	●
-	●

### Solid State Trip Modules for selectivity in networks

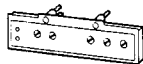

with fixed long time response settings

200	1000 - 9000
225	
250	
300	
350	
400	
500	
600	

2 - 12 x I <sub>r</sub>	●	●
	●	●
	●	●
	●	●
	●	●
	●	●
	-	●
	-	●

with adjustable long time response setting

200 - 400	1000 - 9000
300 - 600	

400 ... 4800	●	●
600 ... 7200	-	●



**Inverse Time Circuit Breaker Components, 600 A, 600 V AC**  
 Type NZM10-...-NA Switch Blocks, Solid State Trip Modules

UL / CSA / IEC / EN 60 947-2 / CE

**Type**                      **List Price**  
 Article No.                see price list

<b>NZM10-400N-NA</b> 063922	
<b>NZM10-400S-NA</b> 063958	
<b>NZM10-400H-NA</b> 063957	
<b>NZM10-600N-NA</b> 063956	
<b>NZM10-600S-NA</b> 063955	
<b>NZM10-600H-NA</b> 063954	

NZM10 switch blocks make up a complete breaker minus the protective trip module. Add a trip module from below to complete the breaker assembly. Refer to compatibility information on switch blocks and trip modules.  
  
 Refer to chart at bottom of page for resulting interrupting ratings.

<b>ZMA-150-NZM10-NA</b> 226742	
<b>ZMA-175-NZM10-NA</b> 226743	
<b>ZMA-200-NZM10-NA</b> 063952	
<b>ZMA-225-NZM10-NA</b> 063953	
<b>ZMA-250-NZM10-NA</b> 063947	
<b>ZMA-300-NZM10-NA</b> 063946	
<b>ZMA-350-NZM10-NA</b> 063945	
<b>ZMA-400-NZM10-NA</b> 063944	
<b>ZMA-500-NZM10-NA</b> 063943	
<b>ZMA-600-NZM10-NA</b> 063942	
<b>ZM-250-NZM10-NA</b> 226741	
<b>ZM-400-NZM10-NA</b> 063948	
<b>ZM-600-NZM10-NA</b> 063949	

ZMA solid state trip modules have a fixed long time response and an adjustable instantaneous pick-up range.

<b>ZMVA-200-NZM10-NA</b> 063941	
<b>ZMVA-225-NZM10-NA</b> 063940	
<b>ZMVA-250-NZM10-NA</b> 063939	
<b>ZMVA-300-NZM10-NA</b> 063938	
<b>ZMVA-350-NZM10-NA</b> 063937	
<b>ZMVA-400-NZM10-NA</b> 063936	
<b>ZMVA-500-NZM10-NA</b> 063935	
<b>ZMVA-600-NZM10-NA</b> 063934	
<b>ZMV-400-NZM10-NA</b> 063950	
<b>ZMV-600-NZM10-NA</b> 063951	

ZM solid state trip modules have an adjustable long time response and an adjustable instantaneous pick-up range.  
  
 Features of ZMV(A)... trip modules used for selectivity:  
 Fixed (ZMVA...) or adjustable (ZMV...) long time response current (2, 4, 6, 8, 10, 12, 14, 17, 20 sec.)  
 Adjustable time delay (2-20 sec.) for current levels at 6 x the long time response current (I<sub>r</sub>). Long time response current can be disconnected (t<sub>r</sub> = 00)  
 Adjustable time delay pick-up setting (0, 10, 50, 100, 150, 200, 300, 500, 750, 1000 ms).  
 Adjustable instantaneous pick-up response.

Note: ZMVA... and ZMV trip modules cannot be combined with NZM 10-400H-NA and NZM10-600H-NA switch blocks.

**Notes:**

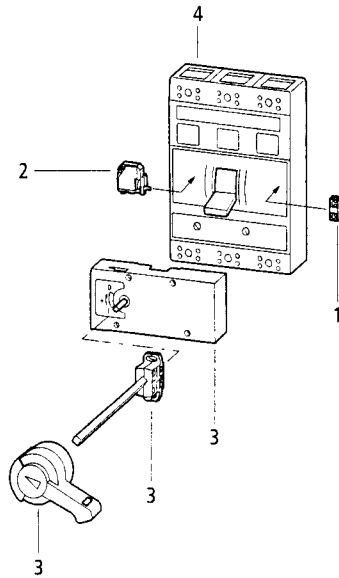

Accessories	Page
1 Auxiliary contacts	09/042
2 Voltage trips	09/043
3 Handles and operators	09/045
4 Terminals	09/051

Compatible trip modules will easily fit into the front part of the switch block. Incompatible trip modules and switch block combinations are mechanically blocked to prevent creation of improper combinations.

NZM 10 switch blocks are supplied with toggle operators as standard.

NZM 10 circuit breakers and molded case switches are supplied with bolt-on connection as standard.

**UL/CSA interrupting ratings (AC, 60Hz)**

Type	RMS sym. kA @		
	240V	480V	600V
<b>NZM10-...N/ZM(V)(A)-...-NA</b>	65	42	35
<b>NZM10-...S/ZM(V)(A)-...-NA</b>	100	65	42
<b>NZM10-...H/ZM(V)(A)-...-NA</b>	200	100	50



## Molded Case Circuit Breakers and Switches

### Auxiliary Contacts, Signalling Unit for Type NZM10-...-NA

Contact diagram	Type suffix	List Price	Type	List Price
	Article No. when ordered with basic device	see price list	Article No. when ordered separately <sup>1)</sup>	see price list

#### NHI standard auxiliary contact

Switching simultaneously with the main contacts. They can be typically used for signalling, interlocking or switching auxiliary circuits such as a control circuit.

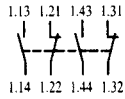

**+NHI-NZM10**  
034798

**NHI-NZM10**  
034943

#### VHI early-make auxiliary contact

Typically used for powering up the undervoltage trip prior to closing of main contacts and for control circuit interlocking tasks. Cannot be used in conjunction with R-NZM10 remote control drive.

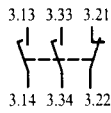

**+VHI-NZM10**  
034800

**VHI-NZM10**  
034944

#### RHI trip-indicating auxiliary contact

Actuating independently of the normal ON and OFF operations of the device, switching only when the device has tripped due to overcurrents or other tripping causes such as those initiated by voltage trips.

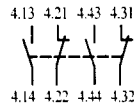

**+RHI-NZM10**  
034797

**RHI-NZM10**  
034945

#### Signalling block

Differential fault indication and visual display of breaker operating states:  
 (1)+(2) tripping due to short circuit  
 (2) tripping due to overload and general trip condition  
 (3) overload early warning signal in the event that the long time response setting is about to be exceeded (i.e. useful for load shedding purposes)

Each function signals via a pair of contacts (1 N.O. and 1 N.C.)

Mounts directly onto lower portion of circuit breaker  
 Required supply voltage: 24 - 230V, AC or DC

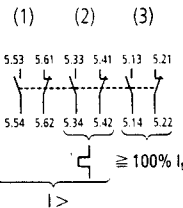
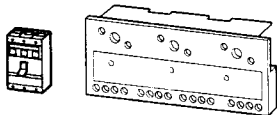

3 poles

**+M-NZM10**  
034801

**M-NZM10**  
034946

Notes:

<sup>1)</sup> Auxiliary contacts and signalling blocks are field installable.

# Molded Case Circuit Breakers and Switches

## Shunt Trips for Type NZM10-...-NA

Rated Actuating Voltage $U_s$	Type Suffix	List Price	Type	List Price
	Article No. when ordered with basic device	see price list	Article No. when ordered separately <sup>1)</sup>	see price list

V

### Shunt trips

Typically used to electrically trip the device from a remote location. Rated for 100% continuous duty. Shunt trips cannot be mounted together with undervoltage trips.



AC/DC	Rated Voltage	Type Suffix	Article No.	Type	Article No.
AC/DC	24	<b>+A-NZM10(24V)</b>	036641	<b>A-NZM10(24V)</b>	036642
	48	<b>+A-NZM10(48V)</b>	036643	<b>A-NZM10(48V)</b>	036644
	60	<b>+A-NZM10(60V)</b>	036645	<b>A-NZM10(60V)</b>	036646
	110 – 120	<b>+A-NZM10(110-120V)</b>	036647	<b>A-NZM10(110-120V)</b>	036648
	125 – 130	<b>+A-NZM10(125-130V)</b>	036649	<b>A-NZM10(125-130V)</b>	036650
	208 – 215	<b>+A-NZM10(208-215V)</b>	036651	<b>A-NZM10(208-215V)</b>	036652
	220 – 240	<b>+A-NZM10(220-240V)</b>	036653	<b>A-NZM10(220-240V)</b>	036654
	380 – 415	<b>+A-NZM10(380-415V)</b>	036655	<b>A-NZM10(380-415V)</b>	036656
	440 – 480	<b>+A-NZM10(440-480V)</b>	036657	<b>A-NZM10(440-480V)</b>	036658
	500	<b>+A-NZM10(500V)</b>	036659	<b>A-NZM10(500V)</b>	036660
	600	<b>+A-NZM10(600V)</b>	036661	<b>A-NZM10(600V)</b>	036662

**Notes**

<sup>1)</sup> Shunt trips are field installable.



## Molded Case Circuit Breakers and Switches

### Undervoltage Trips and Ground Fault Modules for Type NZM10-...-NA

Rated Actuating Voltage $U_s$	Type Suffix	List Price	Type	List Price
V	Article No. when ordered with basic device	see price list	Article No. when ordered separately <sup>1)</sup>	see price list

#### Undervoltage trips, undelayed response

Electrically trip the device open under power loss (when supply voltage drops below 35 - 70 % of rated trip coil value) and can be used for control interlocking purposes, e.g. to disconnect the main switch in Emergency-Stop circuits. They are rated for continuous duty. Undervoltage trips cannot be mounted together with shunt trips.



AC	DC																																																						
<table border="1"> <tr><td>24</td><td><b>+U-NZM10(24VAC)</b> 036665</td><td><b>U-NZM10(24VAC)</b> 036666</td></tr> <tr><td>48</td><td><b>+U-NZM10(48VAC)</b> 036667</td><td><b>U-NZM10(48VAC)</b> 036668</td></tr> <tr><td>60</td><td><b>+U-NZM10(60VAC)</b> 036669</td><td><b>U-NZM10(60VAC)</b> 036670</td></tr> <tr><td>110 - 120</td><td><b>+U-NZM10(110-120VAC)</b> 036671</td><td><b>U-NZM10(110-120VAC)</b> 036672</td></tr> <tr><td>125 - 130</td><td><b>+U-NZM10(125-130VAC)</b> 036673</td><td><b>U-NZM10(125-130VAC)</b> 036674</td></tr> <tr><td>208 - 215</td><td><b>+U-NZM10(208-215VAC)</b> 036675</td><td><b>U-NZM10(208-215VAC)</b> 036676</td></tr> <tr><td>220 - 240</td><td><b>+U-NZM10(220-240VAC)</b> 036677</td><td><b>U-NZM10(220-240VAC)</b> 036678</td></tr> <tr><td>380 - 415</td><td><b>+U-NZM10(380-415VAC)</b> 036679</td><td><b>U-NZM10(380-415VAC)</b> 036680</td></tr> <tr><td>440 - 480</td><td><b>+U-NZM10(440-480VAC)</b> 036681</td><td><b>U-NZM10(440-480VAC)</b> 036682</td></tr> <tr><td>500</td><td><b>+U-NZM10(500VAC)</b> 036683</td><td><b>U-NZM10(500VAC)</b> 036684</td></tr> <tr><td>600</td><td><b>+U-NZM10(600VAC)</b> 036686</td><td><b>U-NZM10(600VAC)</b> 036685</td></tr> </table>	24	<b>+U-NZM10(24VAC)</b> 036665	<b>U-NZM10(24VAC)</b> 036666	48	<b>+U-NZM10(48VAC)</b> 036667	<b>U-NZM10(48VAC)</b> 036668	60	<b>+U-NZM10(60VAC)</b> 036669	<b>U-NZM10(60VAC)</b> 036670	110 - 120	<b>+U-NZM10(110-120VAC)</b> 036671	<b>U-NZM10(110-120VAC)</b> 036672	125 - 130	<b>+U-NZM10(125-130VAC)</b> 036673	<b>U-NZM10(125-130VAC)</b> 036674	208 - 215	<b>+U-NZM10(208-215VAC)</b> 036675	<b>U-NZM10(208-215VAC)</b> 036676	220 - 240	<b>+U-NZM10(220-240VAC)</b> 036677	<b>U-NZM10(220-240VAC)</b> 036678	380 - 415	<b>+U-NZM10(380-415VAC)</b> 036679	<b>U-NZM10(380-415VAC)</b> 036680	440 - 480	<b>+U-NZM10(440-480VAC)</b> 036681	<b>U-NZM10(440-480VAC)</b> 036682	500	<b>+U-NZM10(500VAC)</b> 036683	<b>U-NZM10(500VAC)</b> 036684	600	<b>+U-NZM10(600VAC)</b> 036686	<b>U-NZM10(600VAC)</b> 036685	<table border="1"> <tr><td>24</td><td><b>+U-NZM10(24VDC)</b> 036689</td><td><b>U-NZM10(24VDC)</b> 036690</td></tr> <tr><td>48</td><td><b>+U-NZM10(48VDC)</b> 036691</td><td><b>U-NZM10(48VDC)</b> 036692</td></tr> <tr><td>60</td><td><b>+U-NZM10(60VDC)</b> 036693</td><td><b>U-NZM10(60VDC)</b> 036694</td></tr> <tr><td>110 - 120</td><td><b>+U-NZM10(110-120VDC)</b> 036695</td><td><b>U-NZM10(110-120VDC)</b> 036696</td></tr> <tr><td>125 - 130</td><td><b>+U-NZM10(125-130VDC)</b> 036697</td><td><b>U-NZM10(125-130VDC)</b> 036698</td></tr> <tr><td>208 - 215</td><td><b>+U-NZM10(208-215VDC)</b> 036699</td><td><b>U-NZM10(208-215VDC)</b> 036700</td></tr> <tr><td>220 - 240</td><td><b>+U-NZM10(220-240VDC)</b> 036701</td><td><b>U-NZM10(220-240VDC)</b> 036702</td></tr> </table>	24	<b>+U-NZM10(24VDC)</b> 036689	<b>U-NZM10(24VDC)</b> 036690	48	<b>+U-NZM10(48VDC)</b> 036691	<b>U-NZM10(48VDC)</b> 036692	60	<b>+U-NZM10(60VDC)</b> 036693	<b>U-NZM10(60VDC)</b> 036694	110 - 120	<b>+U-NZM10(110-120VDC)</b> 036695	<b>U-NZM10(110-120VDC)</b> 036696	125 - 130	<b>+U-NZM10(125-130VDC)</b> 036697	<b>U-NZM10(125-130VDC)</b> 036698	208 - 215	<b>+U-NZM10(208-215VDC)</b> 036699	<b>U-NZM10(208-215VDC)</b> 036700	220 - 240	<b>+U-NZM10(220-240VDC)</b> 036701	<b>U-NZM10(220-240VDC)</b> 036702
24	<b>+U-NZM10(24VAC)</b> 036665	<b>U-NZM10(24VAC)</b> 036666																																																					
48	<b>+U-NZM10(48VAC)</b> 036667	<b>U-NZM10(48VAC)</b> 036668																																																					
60	<b>+U-NZM10(60VAC)</b> 036669	<b>U-NZM10(60VAC)</b> 036670																																																					
110 - 120	<b>+U-NZM10(110-120VAC)</b> 036671	<b>U-NZM10(110-120VAC)</b> 036672																																																					
125 - 130	<b>+U-NZM10(125-130VAC)</b> 036673	<b>U-NZM10(125-130VAC)</b> 036674																																																					
208 - 215	<b>+U-NZM10(208-215VAC)</b> 036675	<b>U-NZM10(208-215VAC)</b> 036676																																																					
220 - 240	<b>+U-NZM10(220-240VAC)</b> 036677	<b>U-NZM10(220-240VAC)</b> 036678																																																					
380 - 415	<b>+U-NZM10(380-415VAC)</b> 036679	<b>U-NZM10(380-415VAC)</b> 036680																																																					
440 - 480	<b>+U-NZM10(440-480VAC)</b> 036681	<b>U-NZM10(440-480VAC)</b> 036682																																																					
500	<b>+U-NZM10(500VAC)</b> 036683	<b>U-NZM10(500VAC)</b> 036684																																																					
600	<b>+U-NZM10(600VAC)</b> 036686	<b>U-NZM10(600VAC)</b> 036685																																																					
24	<b>+U-NZM10(24VDC)</b> 036689	<b>U-NZM10(24VDC)</b> 036690																																																					
48	<b>+U-NZM10(48VDC)</b> 036691	<b>U-NZM10(48VDC)</b> 036692																																																					
60	<b>+U-NZM10(60VDC)</b> 036693	<b>U-NZM10(60VDC)</b> 036694																																																					
110 - 120	<b>+U-NZM10(110-120VDC)</b> 036695	<b>U-NZM10(110-120VDC)</b> 036696																																																					
125 - 130	<b>+U-NZM10(125-130VDC)</b> 036697	<b>U-NZM10(125-130VDC)</b> 036698																																																					
208 - 215	<b>+U-NZM10(208-215VDC)</b> 036699	<b>U-NZM10(208-215VDC)</b> 036700																																																					
220 - 240	<b>+U-NZM10(220-240VDC)</b> 036701	<b>U-NZM10(220-240VDC)</b> 036702																																																					

#### Ground fault trip module

No outside power source required

Ground fault trip current adjustable in steps:

$I_{\Delta n} = 80, 100, 130, 160, 200, 240, 280, 320, 360, 400$  A,

with adjustable delay time:

$t_d = 0, 60, 150, 200, 300, 500, 750, 1000$  ms

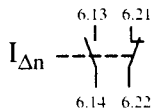
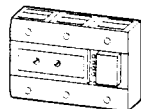

Module is attached directly to the circuit breaker  
Ground fault trip current is signalled directly to the electronic circuitry

**+TV-NZM10**  
095126

**TV-NZM10**  
034811

Module is mounted separately. Ground fault trip current is signalled directly to a shunt or undervoltage trip via auxiliary contacts

-

**TV-NZM10/E**  
034813

#### Notes:

<sup>1)</sup> Accessories are field installable



# Molded Case Circuit Breakers and Switches

## Remote Control Drives and Accessories for Type NZM10-...-NA

Rated Actuating Voltage $U_s$ V	Type Suffix Article No. when ordering with basic device	Type Article No. when ordering separately <sup>1)</sup>	List Price see price list
---------------------------------------	---	---	------------------------------

### Remote control drive

To be mounted on top of circuit breakers and molded case switches  
Switching times: ON 60 ms, OFF 30 ms  
Manual switching possible

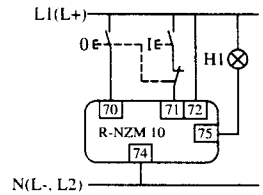
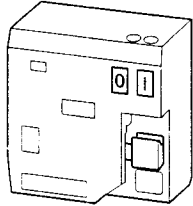

3-wire control

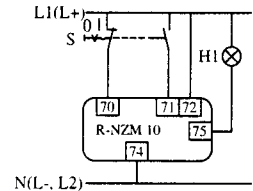

2-wire control

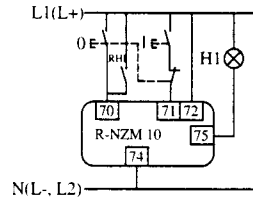

3-wire control with automatic reset to the OFF position after the switch has tripped.

AC	110	<b>+R-NZM10(110-120VAC)</b> 027622	<b>R-NZM10(110-120VAC)</b> 027619
	220	<b>+R-NZM10(220-240VAC)</b> 027620	<b>R-NZM10(220-240VAC)</b> 027617

### Pushbutton operator

For manual ON-OFF switching of encapsulated NZM10 breakers and switches equipped with a remote control drive



Mounting depth 250 – 285 mm	-	<b>MD-NZM10</b> 034823	Not for use in conjunction with KVR2-NZM10 mechanical interlock
Mounting depth 285 – 400 mm	-	<b>MDV-NZM10</b> 034824	

### Protective cover for door cutout

Transparent cover to provide a panel cutout area with IP 54 protection

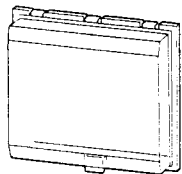

-	<b>RTR-NZM10</b> 034825	For use where the remote control drive protrudes from the cutout area of the enclosure door
---	----------------------------	---

### Sealing plate

Blocks off manual switching access of the remote control drive at the device



-	<b>PL-NZM10</b> 028907	Electrical switching from a remote location and manual tripping of the circuit breaker (push to trip feature) are not affected.
---	---------------------------	---



## Molded Case Circuit Breakers and Switches

### Accessories for Type NZM10-...-NA

#### Type Suffix

Article No.  
when ordered with  
basic device

#### List Price

see price list

#### Toggle switch interlock

Permits the OFF position of the toggle operator to be locked with up to 3 padlocks (hasp thickness 6-8mm)



**+SVB-NZM10**  
034829

#### Insulating cutout frame

for use where the toggle switch protrudes from the enclosure. Provides degree of protection IP 40



**+RT-NZM10**  
094927

#### Rotary drive mechanism

converts ON and OFF switching from a vertical toggle movement to a rotary motion.

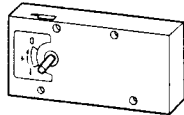

**+D-NZM10**  
034827

#### Rotary handle

black  
requires rotary drive mechanism



**+H10U-SW**  
044608

#### Extension shaft

can be cut to required length

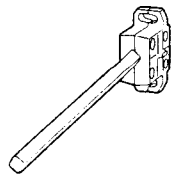

Mounting depth 175 – 400 mm

**+A-NZM10**  
051378

Mounting depth 260 – 600 mm

**+A600-NZM10**  
025373



#### Maintenance handle

for panel mounted switches  
push-fits onto the extension shaft

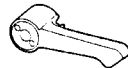

for A-NZM10

**+H10UZ**  
044757

for A600-NZM-10

**+H12UZ**  
065794

## Molded Case Circuit Breakers and Switches

### Accessories for NZM10-...-NA

<b>Type</b> Article No. when ordered separately <sup>1)</sup>	<b>List Price</b> see price list
<b>SVB-NZM10</b> 034948	
<b>RT-NZM10</b> 034828	Affixed from the rear with screws. Can be inscribed.
<b>D-NZM10</b> 034949	Required for the use of rotary and door coupling/ interlocking rotary handles.  Can be locked in the OFF position with up to 3 padlocks. Hasp thickness, 4-8mm.
<b>H10U-SW</b> 044607	Suitable for open mount switches. No door interlocking or padlocking provisions.
<b>A-NZM10</b> 051377	
<b>A600-NZM10</b> 047892	
<b>H10UZ</b> 044756	To actuate the device when the panel door is open
<b>H12UZ</b> 047427	

**Notes:**

<sup>1)</sup> Accessories are field installable

## Molded Case Circuit Breakers and Switches

### Accessories for Type NZM10-...-NA

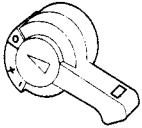
	Type Suffix	List Price
	Article No. when ordered with basic device	see price list
<b>Handle for cover/door interlocking</b>		
Degree of protection IP 55, with cover padlocking and padlocking feature, Rotary drive mechanism required, Can be locked in the ON and OFF position with up to 3 padlocks		
black	for standard main disconnect switch applications	<b>+H10-SW-NA</b> 097560
		
red-yellow	enables the switch to be used as Emergency-Stop disconnect	<b>+RH10-NA</b> 097620
<b>Switch position indicator</b>		
Indicates position of switch (OFF, tripped or ON) when panel door is open		
		<b>+SA-NZM10</b> 045051
<b>Main disconnect switch assembly kits for CE marked control panels per IEC/EN 60 204-1</b>		
Type NZM10-...-NA breakers and switches have dual UL/CSA and IEC/EN ratings. They are suitable for use as main disconnect switches in control panels that must be CE marked and designed to comply with the Machinery Directive standard EN 60 204-1.		
With black door interlocking rotary handle		<b>+V-NZM10-SW</b> 054138
With red/yellow door interlocking rotary handle to apply the switch as Emergency-Stop according to IEC/EN 60 204-1, VDE 0113 part 1		<b>+V-NZM10</b> 025372
<b>Main disconnect warning plates</b>		
„Main Switch - Open only in OFF Position“		
English		<b>+ZS62-NZM10</b> 027559
French		<b>+ZS63-NZM10</b> 027560
Warning plates also available in other languages		
		<b>+ZS...NZM10</b> 108825
Blank plate (for engraving or printing)		<b>+ZS60-NZM10</b> 045054



# Molded Case Circuit Breakers and Switches

Accessories for NZM10-...-NA

Type	List Price
Article No. when ordered separately <sup>1)</sup>	see price list

<b>H10-SW-NA</b> 093193	Degree of protection: UL/NEMA 3R, 12; IEC IP 55  3 distinct handle positions: OFF - + (tripped) - ON
<b>RH10-NA</b> 093239	

<b>SA-NZM10</b> 045050	To be mounted on axle of rotary drive
---------------------------	---------------------------------------

<b>V-NZM10-SW</b> 054150	Kit includes: • door interlocking rotary handle • rotary drive mechanism • extension shaft for 400mm mounting depth • external warning plate • black lightning symbol
<b>V-NZM10</b> 047893	

<b>ZS62-NZM10</b> 027579	Available languages:  61 German            72 Portuguese 64 Bulgarian        73 Romanian 65 Danish            74 Russian 66 Finnish            75 Swedish 67 Dutch             76 Serbo-Croatian 68 Italian            77 Spanish 69 Greek             78 Czech 70 Norwegian       79 Turkish 71 Polish             80 Hungarian 81 Afrikaans
<b>ZS63-NZM10</b> 027580	
<b>ZS...NZM10</b> 108824	
<b>ZS60-NZM10</b> 045055	

To obtain warning plates in other languages, insert the language code number into the type reference

**Example**

Main disconnect warning plate in Finnish:  
ZS66-NZM10

**Notes:**

<sup>1)</sup> Accessories are field installable



## Molded Case Circuit Breakers and Switches

### Accessories for Type NZM10-...-NA

**Type**  
Article No.  
when ordered  
separately <sup>1)</sup>

**List Price**  
see price list

**Mechanical interlocks**

Fits toggle operators or rotary drive mechanisms

for mechanically interlocking two NZM10 circuit breakers or molded case switches mounted in a panel.

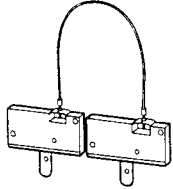

For two circuit breakers

**KV2-NZM10**  
034831

For two circuit breakers equipped with R-NZM10 remote control drives.

**KVR2-NZM10**  
034832

R-NZM10 must be electrically interlocked at the same time

For mechanically interlocking three NZM10 circuit breakers or molded case switches mounted in a panel

**KV3-NZM10**  
047891

Fits toggle operators or rotary drive mechanisms

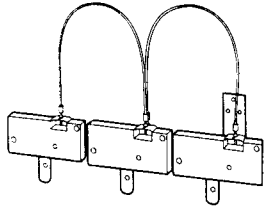

For mechanical power supplies:  
Mechanically interlocking two incoming supply circuit breakers with one emergency supply breaker.  
Fits toggle operators or rotary drive mechanisms

**KVA3-NZM10**  
034833

Possible switching positions

Incomer 1	Emergency	Incomer 2
0	0	0
1	V	0
1	V	1
0	V	1
0	0	0
V	1	V

0 = OFF  
V = interlocked  
1 = ON



**Note:**

<sup>1)</sup> Accessories are field installable



# Molded Case Circuit Breakers and Switches

## Terminals for Type NZM10-...-NA

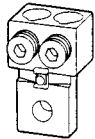
	Maximum Rated Current	Conductor Cross-section Range and Material	Type Suffix Article No. when ordered with basic device <sup>1)</sup>	List Price see price list	Type Article No. individual terminals supplied separately for field mounting	List Price see price list
A						
<b>Terminals</b>						
Supplied as						
<ul style="list-style-type: none"> <li>• 1 set of 3 terminals when ordered with basic device</li> <li>• 1 terminal when ordered separately</li> </ul>						
Single cable clamp terminal Not supplied with terminal cover	350	250 - 500 kcmil Cu only	<b>+K300-NZM10-O</b> 093732		<b>K300-NZM10</b> 034937	
			<b>+K300-NZM10-U</b> 093731		-	
Double cable clamp terminal Not supplied with terminal cover	500	2 x AWG 3/0 - 250 kcmil Cu only	<b>+K2X120-NZM10-O</b> 093734		<b>K2X120-NZM10</b> 034938	
			<b>+K2X120-NZM10-U</b> 093733		-	
Supplied with 3 terminal covers H-NZM10 and an insulating plate onto which the circuit breaker is mounted	600	2 x AWG 2 - 500 kcmil Cu/Al	<b>+K2X240IP-NZM10-O</b> 063925		-	
			<b>+K2X240IP-NZM10-U</b> 063923		-	
Supplied with 1 terminal cover (type H-NZM10) and an insulating plate onto which the circuit breaker is mounted					<b>K2X240IP-NZM10 <sup>2)</sup></b> 063927	
Supplied with 1 terminal cover (type H-NZM10)					<b>K2X240-NZM10 <sup>2)</sup></b> 034939	

### Terminal covers

suitable for cable lug terminals

Supplied as standard with K2 x 240(IP)

Supplied as

- 1 set of 3 terminal covers when ordering with basic device
- 1 terminal cover when ordering separately



One piece, 3 pole terminal cover,  
suitable for K300 and K2 x 120

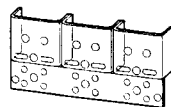

**+H-NZM10-O**  
025348

**H-NZM10**  
047889

**+H-NZM10-U**  
025347

-

**+HH-NZM10-O**  
047578

**HH-NZM10**  
043254

**+HH-NZM10-U**  
047479

-

### Notes

<sup>1)</sup> When ordering with the device, the type suffix specifies which side should be equipped with terminals

-O = mounted on the top

-U = mounted on the bottom

<sup>2)</sup> Complete set of three (for top or bottom) type K2x240(IP) terminals for field installation consists of the following:

- Quantity of one K2X240IP terminal which is supplied with one H-NZM10 terminal cover and one insulating plate

- Quantity of two K2X240 terminals, which are supplied each with one H-NZM10 terminal cover



## Molded Case Circuit Breakers - Instantaneous Trip

Type NZMH4-...-OBI-...

			Type	List Price see price list	Notes:						
	Continuous Current Rating	Adjustable Magnetic Trip Range	Article No.								
<b>Instantaneous trip circuit breakers</b>											
Frame rated at 18A Line and load field-wiring terminals for cable connection supplied as standard											
up to 480V AC, UL/CSA	2.1	6 - 12	<b>NZMH4-2.1-12-OBI-CNA</b> 031314		Type NZMH4-...-OBI molded case circuit breakers are UL recognized (UL 489) and CSA certified (2.2 Nr. 5.1) instantaneous trip type circuit breakers with an adjustable magnetic trip function. Per NEC, they provide motor short circuit protection as part of a listed combination motor controller that includes coordinated motor overload protection. Short circuit interrupting ratings are, therefore, established and valid only for the listed combination motor controller assembly and associated housing or enclosure.						
	3.7	11 - 20	<b>NZMH4-3.7-20-OBI-CNA</b> 033687								
	6.6	18 - 32	<b>NZMH4-6.6-32-OBI-CNA</b> 036060								
	10	28 - 50	<b>NZMH4-10-50-OBI-CNA</b> 038433								
	12	42 - 80	<b>NZMH4-12-80-OBI-CNA</b> 040806								
	15	64 - 120	<b>NZMH4-15-120-OBI-CNA</b> 043179								
	18	100 - 200	<b>NZMH4-18-200-OBI-CNA</b> 045552								
up to 600Y/347V AC CSA certified only	2.1	6 - 12	<b>NZMH4-2.1-12-OBI-FORMCDN</b> 005466		The NZMH4 instantaneous trip circuit breaker features a current limiting design contact assembly and can provide high fault short circuit current ratings of up to 100kA at 480V AC.						
	3.7	11 - 20	<b>NZMH4-3.7-20-OBI-FORMCDN</b> 005467								
	6.6	18 - 32	<b>NZMH4-6.6-32-OBI-FORMCDN</b> 005468								
	10	28 - 50	<b>NZMH4-10-50-OBI-FORMCDN</b> 005469								
	12	42 - 80	<b>NZMH4-12-80-OBI-FORMCDN</b> 005470								
	15	64 - 120	<b>NZMH4-15-120-OBI-FORMCDN</b> 005471								
	18	100 - 200	<b>NZMH4-18-200-OBI-FORMCDN</b> 005472								
<table border="1"> <thead> <tr> <th>Accessories</th> <th>Page</th> </tr> </thead> <tbody> <tr> <td>Handles</td> <td>09/056</td> </tr> <tr> <td>Accessories</td> <td>09/054</td> </tr> </tbody> </table>						Accessories	Page	Handles	09/056	Accessories	09/054
Accessories	Page										
Handles	09/056										
Accessories	09/054										





# Motor Disconnect Switches

## Type NZMH4-...-CNA

UL / CSA / IEC / EN 60 947-2

Circuit Breakers, Disconnect Switches, Molded Case Switches

Adjustable Thermal Range for motor overload protection	Adjustable Magnetic Trip Range	Motor Rating				Type Article No.	List Price see price list	Notes:
		200V HP	230V HP	460V HP	575V HP			
A	A	200V HP	230V HP	460V HP	575V HP			
<b>NZM4-...-CNA Motor Disconnect Switch</b> Frame rated at 80A Line and load field-wiring terminals for cable connection supplied as standard								
							Accessories	Page
							Handles	09/056
							Accessories	09/054
NZMH4-...-CNA disconnect switches are UL recognized (UL 508) and CSA certified (22.2 Nr. 14) as 3 pole, HP rated manual motor disconnects with built-in thermal trips for motor overload protection. An adjustable dial on the front of the switch can be set to the motor full load current. An adjustable magnetic trip provides additional protection in case of short circuits.								
Suitable for group applications per the intent of NEC 430-53 and CEC part 1, rule 28-206 (see below).								
4 - 6	40 - 80	1 ½	1 ½	3	5	<b>NZMH4-6-CNA</b> 047925		
6 - 10	60 - 120	2	3	5	7 ½	<b>NZMH4-10-CNA</b> 050298		
10 - 16	100 - 200	3	5	10	10	<b>NZMH4-16-CNA</b> 052671		
16 - 25	160 - 320	5	7 ½	15	20	<b>NZMH4-25-CNA<sup>1)</sup></b> 055044		
25 - 40	260 - 500	10	10	30	40	<b>NZMH4-40-CNA<sup>1)</sup></b> 057417		
40 - 63	400 - 800	20	20	40	60	<b>NZMH4-63-CNA<sup>1)</sup></b> 059790		
63 - 80	600 - 1000	25	30	60	75	<b>NZMH4-80-CNA<sup>1)</sup></b> 062163		

Notes:

<sup>1)</sup> Disconnect switch is CE marked and in conformity with IEC/EN 60 947-2 (Circuit Breakers), which makes it suitable internationally as inverse time molded case circuit breaker with adjustable thermal and magnetic trips. Consult the technical data and Moeller Electric for IEC/EN ratings.

### NEC/CEC Group Application Ratings:

#### Maximum Group Fuse or Circuit Breaker

#### UL/CSA Short Circuit Current Rating RMS sym. at

Listed Branch Circuit Protective Fuse	Listed Branch Circuit Protective Breaker	240 V AC	480 V AC	600 V AC
A	A	kA	kA	kA
600	600	100	25	25



# Molded Case Circuit Breakers and Disconnect Switches

## Auxiliary Contacts for Type NZMH4-...

Contacts	Type Suffix	List Price
N.O. = normally open N.C. = normally closed	Article No. when ordering with basic device	see price list
N.O.      N.C.		
<b>Standard auxiliary contacts</b>		
	<b>+NHI22-NZM4/6-NA</b> 082860	
<b>Early-make auxiliary contacts</b>		
	<b>+VHI-NZMH4-NA</b> 082864	
<b>Handle-operated early-make auxiliary contacts</b>		
	<b>+AHI-NZMH4-NA</b> 082865	
<b>Trip-indicating auxiliary contacts</b>		
	<b>+RHI-NZMH4-NA</b> 082866	

**Notes**

VHI, AHI and RHI are supplied as 1 N.O. and 1 N.C. contact set but can be field modified as 2 N.O. or 2 N.C.

Combination possibilities of auxiliary contacts:

NHI	VHI	AHI	RHI
●	●	-	-
●	-	●	-
●	-	-	●

Dots in each row represent the types which can be combined together. Dashes indicate incompatibility.

	NHI	VHI	AHI	RHI
	NHI standard auxiliary contacts operate simultaneously with the main contacts.  Typically used for signalling or switching auxiliary circuits such as a control circuit.	VHI early make auxiliary contacts lead the main contacts when switching ON as well as switching OFF.  Typically used for load shedding purposes or in conjunction with voltage trips in control circuits.	AHI handle operated auxiliary contacts operate in advance of the main contacts, shortly after the handle has left the OFF position.  Typically used to convert the manual actuation of the switch into a control function for circuit interlocking purposes.	RHI trip-indicating auxiliary contacts work independently of the normal ON and OFF operations of the device, switching only when the device has tripped due to overloads, overcurrents or other tripping functions such as voltage trips.
Position of auxiliary contacts →	same as main contacts	same contact position in both OFF and Tripped position of the device	same contact position in both ON and Tripped position of the device	operates only when device is tripped
Main contacts ■ closed □ open Switching ON ○ → I Switching OFF ○ ← I Tripped position + ← I				

**Notes:**  
Auxiliary contacts must be ordered with the device

# Molded Case Circuit Breakers and Disconnect Switches

## Voltage Trips for Type NZMH4-...

Circuit Breakers  
Disconnect Switches, Molded Case Switches

Rated Control Voltage	Type Suffix	List Price	Notes
V/Hz	Article No. to be ordered with device only	see price list	
<b>Shunt trips</b>			
Short-time duty rating			
			
Short time actuation can be achieved by using the NHI auxiliary contact ahead in series with the shunt trip coil Cannot be mounted together with under-voltage trips.			
AC	110/50 120/60	<b>+A-NZM4/6(110V50HZ/120V60HZ)-NA</b> 084879	Shunt trips are typically used to electrically trip the device from a remote location
	120/60	<b>+A-NZM4/6(120V60HZ)-NA</b> 084874	
	208/60	<b>+A-NZM4/6(208V60HZ)-NA</b> 084875	
	240/60	<b>+A-NZM4/6(240V60HZ)-NA</b> 084876	
	480/60	<b>+A-NZM4/6(480V60HZ)-NA</b> 084877	
	600/60	<b>+A-NZM4/6(600V60HZ)-NA</b> 084878	
DC	24	<b>+A-NZM4/6(24VDC)</b> 082228	

<b>Undervoltage trips,</b> non-delayed			
Continuous duty rating			
			
Power can be applied to the undervoltage trip using VHI early-make auxiliary contacts in series with the undervoltage trip coil.			
Cannot be mounted together with shunt trips.			
AC	120/60	<b>+U-NZM4/6(120V60HZ)</b> 082872	Undervoltage trips will electrically trip the device open under power loss and can be used for control interlocking purposes, e.g. to disconnect the main switch in Emergency-Stop circuits.
	208/60	<b>+U-NZM4/6(208V60HZ)</b> 082873	
	240/60	<b>+U-NZM4/6(240V60HZ)</b> 082874	
	480/60	<b>+U-NZM4/6(480V60HZ)</b> 082875	
	600/60	<b>+U-NZM4/6(600V60HZ)</b> 082876	
DC	24	<b>+U-NZM4/6(24VDC)</b> 082242	



## Molded Case Circuit Breakers and Disconnect Switches

### Accessories for Type NZMH4-...

	Color of handle	for use with	Type Suffix Article No. when ordering with basic device	Type Article No. when ordering separately <sup>1)</sup>	List Price see price list
<b>Handle for open or panel mounted devices</b>					
Fastens to shaft, not padlockable	gray	NZMH4-...	<b>+H4U</b> 002278	<b>H4U</b> 073789	
	black	NZMH4-...	<b>+H4U-SW</b> 063062	<b>H4U-SW</b> 034179	



#### Handle for cover/door interlocking

Degree of protection UL/NEMA 3R, 12; IP 55  
 Door coupling rotary handle. For front mounting in doors and covers. Can be locked in the OFF position with up to 3 padlocks (hasp thickness 6 - 8mm).  
 Door/cover interlocking supplied standard set in OFF position. Can be field modified for setting in ON position.  
 3 distinct handle positions: OFF - + (tripped) - ON



	gray	NZMH4-... NZM(H)6(B)-...	<b>+H6-NA</b> 005346	<b>H6-NA</b> 088445	
	black	NZMH4-... NZM(H)6(B)-...	<b>+H6-SW-NA</b> 106023	<b>H6-SW-NA</b> 088865	
for Emergency-Stop function	red-yellow	NZMH4-... NZM(H)6(B)-...	<b>+RH6-NA</b> 094994	<b>RH6-NA</b> 026874	

#### Extension shaft

Mounting depth 150-400 mm.  
 Extends shaft length by 266 mm.  
 Can also be used with mechanical interlock.

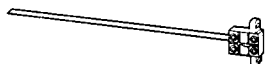

	NZMH4-... NZM(H)6(B)-...	<b>+A-NZM6</b> 058392	<b>A-NZM6</b> 026643	
--	-----------------------------	--------------------------	-------------------------	--

#### Switch position indicator

indicates position of switch when panel door is open

	NZMH4-... NZM(H)6(B)-...	<b>+SA-NZM6</b> 056019	<b>SA-NZM6</b> 045867	
--	-----------------------------	---------------------------	--------------------------	--

#### Mechanical interlock

For mechanically interlocking 2 devices of the same frame size against one another (requires two handles, one for each switch). Order separately.  
 When using a motor operator, electrical interlocking is required

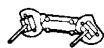

	NZMH4-...	<b>+KV-2NZM4</b> 052565	<b>KV-2NZM4</b> 067471	
--	-----------	----------------------------	---------------------------	--

Notes:

<sup>1)</sup> Accessories are field installable.

# Molded Case Circuit Breakers and Disconnect Switches

## Accessories for NZMH4-...

Color of handle	for use with	Type Suffix Article No. when ordered with basic device	Type Article No. when ordered separately <sup>1)</sup>	List Price see price list
-----------------	--------------	---	--	------------------------------

### Rear operation shafts

For side panel mounting where device is only accessible from the rear (e.g. sides of enclosure panels). Must be combined with H...R rear operation handle. Factory installed only. Order with device

NZMH4-...	<b>+R-NZMH4</b> 002963	-		
-----------	---------------------------	---	--	--

### Operating handle for rear operation

Used with rear operation shaft.  
Degree of protection UL/NEMA 3R, 12; IP 55  
Can be locked in the OFF position with up to 3 padlocks (hasp thickness 6 - 8mm).  
No cover/door interlocking provisions.  
3 distinct handle positions: OFF - + (tripped) - ON



gray	NZMH4-... NZM(H)6(B)-...	<b>+H6-R-NA</b> 005347	<b>H6-R-NA</b> 059551	
black	NZMH4-... NZM(H)6(B)-...	<b>+H6-R-SW-NA</b> 106022	<b>H6-R-SW-NA</b> 201665	
for Emergency-Stop functions red-yellow	NZMH4-... NZM(H)6(B)-...	<b>+RH6-R-NA</b> 095224	<b>RH6-R-NA</b> 069043	

### Legend plate (for mounting with operating handle)

Silver-colored



Specify desired text Black lettering; height of letters 3.5, 5 and 7mm	NZMH4-... NZM(H)6(B)-...	<b>+ZSSOND-NZM6</b> 075003	<b>ZSSOND-NZM6</b> 064984	
Blank for engraving or printing	NZMH4-... NZM(H)6(B)-...	<b>+ZS60-NZM6</b> 077376	<b>ZS60-NZM6</b> 064913	

### Main disconnect warning plate

Silver-colored, black lettering,  
English inscription:  
"Main Switch - Open only in OFF Position"

English	NZMH4-... NZM(H)6(B)-...	<b>+ZS62-NZM6</b> 053654	<b>ZS62-NZM6</b> 044161	
French		<b>+ZS63-NZM6</b> 056027	<b>ZS63-NZM6</b> 046534	
For other languages, see below <sup>2)</sup>		<b>+ZS...-NZM6</b> 108827	<b>ZS...-NZM6</b> 108826	

**Notes:** <sup>1)</sup> Accessories shown in this column are field installable

<sup>2)</sup> Engraved main disconnect warning plates are available in the following languages:

61 German	68 Italian	73 Romanian	78 Czech
64 Bulgarian	69 Greek	74 Russian	79 Turkish
65 Danish	70 Norwegian	75 Swedish	80 Hungarian
66 Finnish	71 Polish	76 Serbo-Croatian	81 Afrikaans
67 Dutch	72 Portuguese	77 Spanish	

Insert language key number into type number

**Example:**  
Warning plate in Italian language:  
ZS 68-NZM 6



## Molded Case Circuit Breakers and Disconnect Switches

Accessories for NZMH4-...

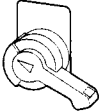
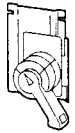
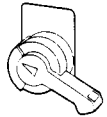
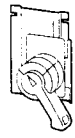
	Type Suffix Article No. when ordered with basic device	Type Article No. when ordered separately <sup>1)</sup>	List Price see price list
<b>Main disconnect switch assembly kits for CE marked control panels per IEC/EN 60 204-1</b>			
<p>NZMH4-... switches with dual UL/CSA and IEC/EN ratings are suitable for use as main disconnect switches in control panels that must be CE marked and designed to comply with the Machinery Directive Standard EN 60 204-1.</p> <p>The kits shown below, ordered with the device or separately, will provide the necessary accessories to fulfill the main disconnect switch function for these applications.</p> <p>Note: in cases where the main disconnect switch also fulfills the Emergency-Stop function, please specify kits containing red handle and yellow backing plate assemblies.</p>			
<ul style="list-style-type: none"> <li>• Main disconnect handle with door/cover interlock for front mounting,</li> <li>• Red color handle with yellow backing plate for Emergency-Stop function,</li> <li>• Terminal cover</li> <li>• Main switch marking plate</li> </ul> 	<b>+V-NZMH4</b> 047462	<b>V-NZMH4</b> 019939	
<ul style="list-style-type: none"> <li>• Main disconnect handle for rear operated switches, red in color with yellow backing plate for Emergency-Stop function,</li> <li>• supplied with steel plate for panel side mounting,</li> <li>• Terminal cover</li> <li>• Main switch marking plate</li> </ul> 	<b>+EA-NZM4</b> 081176	<b>EA-NZM4</b> 009963	
<b>Main disconnect switch assembly kit, black</b>			
<p>for front mounting</p> <p>Same as V-NZMH4, except that the main disconnect handle is black in color with silver backing plate for standard, non-Emergency-Stop function</p> 	<b>+V-NZMH4-SW</b> 054135	<b>V-NZMH4-SW</b> 054147	
<p>for rear operated switches</p> <p>Same as EA-NZMH4, except that the main disconnect handle is black in color with silver backing plate for standard, non-Emergency-Stop function</p> 	<b>+EA-NZM4-SW</b> 054143	<b>EA-NZM4-SW</b> 054155	

Notes:

<sup>1)</sup> Kits are field-installable

# Molded Case Circuit Breakers and Disconnect Switches

## Accessories for Type NZMH4-...-NA

	Type Suffix Article No. when ordered with basic device	Type Article No. when ordered separately <sup>1)</sup>	List Price see price list
<b>Terminal cover</b>			
Provides shock hazard protection in the area of the field wiring power terminals. Can be used at top or bottom, one cover per side. Mandatory requirement on the supply side of main disconnect switches to provide protection against accidental contact with line side feed.			
	<b>+H-NZMH4</b> 091614	<b>H-NZMH4</b> 014880	
<b>Clip</b>			
for mounting NZMH4-... devices on a DIN rail (rail conforming to the standard EN 50 022)			
	<b>+C-NZMH4</b> 058364	<b>C-NZMH4</b> 034534	
<b>Notes:</b>	<sup>1)</sup> Accessories are field installable		



**Inverse Time Circuit Breakers, 125 A**  
Thermal-magnetic Type NZM(H)6(B)-...-NA

Circuit Breakers, Disconnect Switches, Molded Case Switches

Fixed Thermal Setting	Adjustable magnetic trip, supplied standard with the breaker	Adjustable magnetic trip, available as a substitute to standard ratings	UL/CSA Interrupting Ratings (AC, 60Hz)	Type, without handle Article No.	List Price see price list
A	A	A	kA RMS sym. at 240V 480V 600V		

**Standard Interrupting Rating**

Frame rated at 125A  
Line and load field-wiring terminals for cable connection supplied as standard

15	160 - 320	100 - <b>200</b>	25 25 14	<b>NZM6B-63/ZM6A-15-NA</b> 040556
20				<b>NZM6B-63/ZM6A-20-NA</b> 042929
25				<b>NZM6B-63/ZM6A-25-NA</b> 045302
30	260 - 500	100 - <b>200</b> , 160 - <b>320</b>		<b>NZM6B-63/ZM6A-30-NA</b> 047675
35				<b>NZM6B-63/ZM6A-35-NA</b> 050048
40	400 - 800	160 - <b>320</b> , 260 - <b>500</b>		<b>NZM6B-63/ZM6A-40-NA</b> 052421
50				<b>NZM6B-63/ZM6A-50-NA</b> 054794
60				<b>NZM6B-63/ZM6A-60-NA</b> 057167
70	600 - 1200	260 - <b>500</b> , 400 - <b>800</b>		<b>NZM6B-100/ZM6A-70-NA</b> 097508
80				<b>NZM6B-100/ZM6A-80-NA</b> 099881
90				<b>NZM6B-100/ZM6A-90-NA</b> 000216
100				<b>NZM6B-100/ZM6A-100-NA</b> 002589
125	1000 - 2000	400 - <b>800</b> , 600 - <b>1200</b>		<b>NZM6B-160/ZM6A-125-2000-NA</b> 086175

**High Interrupting Rating**  
**UL/CSA Current-limiting Circuit Breaker**

Frame rated at 125A  
Line and load field-wiring terminals for cable connection supplied as standard

15	160 - 320	100 - <b>200</b>	100 65 25	<b>NZMH6-63/ZM6A-15-NA</b> 071408
20				<b>NZMH6-63/ZM6A-20-NA</b> 073781
25				<b>NZMH6-63/ZM6A-25-NA</b> 076154
30	260 - 500	100 - <b>200</b> , 160 - <b>320</b>		<b>NZMH6-63/ZM6A-30-NA</b> 078527
35				<b>NZMH6-63/ZM6A-35-NA</b> 080900
40	400 - 800	160 - <b>320</b> , 260 - <b>500</b>		<b>NZMH6-63/ZM6A-40-NA</b> 083273
50				<b>NZMH6-63/ZM6A-50-NA</b> 085646
60				<b>NZMH6-63/ZM6A-60-NA</b> 088019
70	600 - 1200	260 - <b>500</b> , 400 - <b>800</b>		<b>NZMH6-100/ZM6A-70-NA</b> 016830
80				<b>NZMH6-100/ZM6A-80-NA</b> 019203
90				<b>NZMH6-100/ZM6A-90-NA</b> 021576
100				<b>NZMH6-100/ZM6A-100-NA</b> 023949
125	1000 - 2000	400 - <b>800</b> , 600 - <b>1200</b>		<b>NZMH6-160/ZM6A-125-2000-NA</b> 050585



**Notes:**

Accessories	Page
Handles	09/066
Accessories	09/064

NZM6B-.../ZM6A-...-NA molded case circuit breakers are UL listed (UL 489) and CSA certified (C22.2 Nr. 5.1) inverse time, thermal-magnetic circuit breakers with a fixed thermal and adjustable magnetic trip function.

NZMH6-.../ZM6A-...-NA molded case circuit breakers are UL listed (UL 489) and CSA certified (C22.2 Nr. 5.1) inverse time, thermal-magnetic current-limiting circuit breakers with a fixed thermal and adjustable magnetic trip function.

Both types are CE marked and in conformity with IEC/EN 60 947-2 (circuit breakers), which also makes them suitable internationally as inverse time molded case circuit breakers. Consult the technical data and Moeller Electric for IEC/EN ratings.

**Ordering information:**

State type, example:  
**NZM6B-63/ZM6A-50-NA**

Optionally, select a substitute magnetic trip range and insert the bold number into type number, example:  
**NZM6B-63/ZM6A-50-500-NA**



# Molded Case Circuit Breakers - Instantaneous Trip, 125A

Type NZM(H)6(B)-.../ZM6-...-OBI-...

Continuous Current Rating	Adjustable Magnetic Trip Range	Type, without handle Article No.	List Price see price list	Notes:
A	A			
<b>Standard Interrupting Rating up to 600V AC</b> Frame rated at 125A Line and load field-wiring terminals for cable connection supplied as standard				Accessories Page Handles 09/066 Accessories 09/064
0.6	2.6 - 5	<b>NZM6B-63/ZM6-0.6-5-OBI-CNA</b> 090921		NZM6B-.../ZM6-...-OBI-CNA and NZMH6-.../ZM6-...-OBI-CNA molded case circuit breakers are UL recognized (UL 489) and CSA certified (C22.2 Nr. 5.1) instantaneous trip type circuit breakers with an adjustable magnetic trip function. Per NEC, they provide motor short circuit protection as part of a listed combination motor controller that includes coordinated motor overload protection. Short circuit interrupting ratings are, therefore, established and valid only for the listed combination motor controller assembly and associated housing or enclosure.  The NZMH6 instantaneous trip circuit breaker features a current-limiting design contact assembly and can provide high fault short circuit current ratings of up to 65kA at 480V AC.  Consult Section 03 of this catalog for combination motor controller short-circuit ratings as standard starters featuring type NZM instantaneous trip circuit breakers. Consult Moeller Electric for combination motor controller high fault short circuit ratings as motor control centre unit starters featuring NZMH instantaneous trip circuit breakers.
1.2	4 - 8	<b>NZM6B-63/ZM6-1.2-8-OBI-CNA</b> 098040		
2.1	6 - 12	<b>NZM6B-63/ZM6-2.1-12-OBI-CNA</b> 024478		
3.7	10 - 20	<b>NZM6B-63/ZM6-3.7-20-OBI-CNA</b> 033970		
6.6	16 - 32	<b>NZM6B-63/ZM6-6.6-32-OBI-CNA</b> 055327		
6.6	26 - 50	<b>NZM6B-63/ZM6-6.6-50-OBI-CNA</b> 060073		
12	40 - 80	<b>NZM6B-63/ZM6-12-80-OBI-CNA</b> 014986		
15.5	60 - 120	<b>NZM6B-63/ZM6-15-120-OBI-CNA</b> 019732		
33	100 - 200	<b>NZM6B-63/ZM6-33-200-OBI-CNA</b> 038716		
50	260 - 500	<b>NZM6B-63/ZM6-50-500-OBI-CNA</b> 052954		
60	400 - 800	<b>NZM6B-63/ZM6-60-800-OBI-CNA</b> 067192		
80	260 - 500	<b>NZM6B-100/ZM6-80-500-OBI-CNA</b> 052953		
100	600 - 1200	<b>NZM6B-100/ZM6-100-1200-OBI-CNA</b> 038715		
125	1000 - 2000	<b>NZM6B-160/ZM6-125-2000-OBI-CNA</b> 071937		
<b>High Fault Interrupting Rating up to 600V AC</b> Frame rated at 125A Line and load field-wiring terminals for cable connection supplied as standard				
33	100 - 200	<b>NZMH6-63/ZM6-33-200-OBI-CNA</b> 081434		
50	260 - 500	<b>NZMH6-63/ZM6-50-500-OBI-CNA</b> 093299		
60	400 - 800	<b>NZMH6-63/ZM6-60-800-OBI-CNA</b> 014991		
80	260 - 500	<b>NZMH6-100/ZM6-80-500-OBI-CNA</b> 029228		
100	600 - 1200	<b>NZMH6-100/ZM6-100-1200-OBI-CNA</b> 029855		
125	1000 - 2000	<b>NZMH6-160/ZM6-125-2000-OBI-CNA</b> 038720		

Notes:

<sup>1)</sup> Optional magnetic trip ranges are available for some sizes of circuit breakers. Consult Moeller Electric



# Motor Disconnect Switches

## Type NZM(H)6(B)-.../ZM6-...-CNA

Adjustable thermal trip range	Adjustable magnetic trip range	Maximum HP Rating 3 phase at				Type, without handle Article No.	List Price see price list
		200V HP	230V HP	460V HP	575V HP		
A	A						

### Standard Short Circuit Rating

Frame rated at 125A  
Line and load field-wiring terminals for cable connection supplied as standard

15 - 25	160 - 320	5	7½	15	20	<b>NZM6B-63/ZM6-25-CNA</b> 029224
25 - 40	260 - 500	10	10	30	40	<b>NZM6B-63/ZM6-40-CNA</b> 043462
40 - 63	400 - 800	20	20	40	60	<b>NZM6B-63/ZM6-63-CNA</b> 069565
63 - 100	600 - 1200	30	30	75	100	<b>NZM6B-100/ZM6-100-CNA</b> 048207
100 - 125	1000 - 2000	40	40	100	125	<b>NZM6B-160/ZM6-125-2000-CNA</b> 067191

With optional lower magnetic trip values <sup>1)</sup>

15 - 25	100 - 200	5	7½	15	20	<b>NZM6B-63/ZM6-25-200-CNA</b> 017936
25 - 40	160 - 320	10	10	30	40	<b>NZM6B-63/ZM6-40-320-CNA</b> 014461
40 - 63	260 - 500	20	20	40	60	<b>NZM6B-63/ZM6-63-500-CNA</b> 019207
63 - 100	400 - 800	30	30	75	100	<b>NZM6B-100/ZM6-100-800-CNA</b> 023953
100 - 125	600 - 1200	40	40	100	125	<b>NZM6B-160/ZM6-125-1200-CNA</b> 208031

### High Fault Short Circuit Rating

Frame rated at 125A  
Line and load field-wiring terminals for cable connection supplied as standard

15 - 25	160 - 320	5	7½	15	20	<b>NZMH6-63/ZM6-25-CNA</b> 076688
25 - 40	260 - 500	10	10	30	40	<b>NZMH6-63/ZM6-40-CNA</b> 086180
40 - 63	400 - 800	20	20	40	60	<b>NZMH6-63/ZM6-63-CNA</b> 019737
63 - 100	600 - 1200	30	30	75	100	<b>NZMH6-100/ZM6-100-CNA</b> 014990
100 - 125	1000 - 2000	40	40	100	125	<b>NZMH6-160/ZM6-125-2000-CNA</b> 036347

With optional lower magnetic trip values: <sup>1)</sup>

15 - 25	100 - 200	5	7½	15	20	<b>NZMH6-63/ZM6-25-200-CNA</b> 065396
25 - 40	160 - 320	10	10	30	40	<b>NZMH6-63/ZM6-40-320-CNA</b> 050055
40 - 63	260 - 500	20	20	40	60	<b>NZMH6-63/ZM6-63-500-CNA</b> 054801
63 - 100	400 - 800	30	30	75	100	<b>NZMH6-100/ZM6-100-800-CNA</b> 059547
100 - 125	600 - 1200	40	40	100	125	<b>NZMH6-160/ZM6-125-1200-CNA</b> 207958

Notes:

<sup>1)</sup> Additional optional magnetic trip ranges are available for some sizes of disconnect switches. Consult Moeller Electric

Accessories	Page
Handles	09/066
Accessories	09/064

NZM6B-.../ZM6-...-CNA and NZMH6-.../ZM6-...-CNA disconnect switches are UL recognized (UL 508) and CSA certified (C22.2 Nr. 14) manual motor disconnects with built-in thermal trips for motor overload protection. An adjustable dial on the front of the switch can be set to the motor full load current. An adjustable magnetic trip provides additional protection in the case of short circuits. Per NEC, branch circuit overcurrent protection devices must be provided separately.

NZM6B-.../ZM6-...-CNA and NZMH6-.../ZM6-...-CNA disconnect switches are CE marked and in conformity with IEC/EN 60 947-2 (circuit breakers), which makes them suitable internationally as inverse time molded case circuit breakers with adjustable thermal and magnetic trips.

Consult the technical data and Moeller Electric for IEC/EN ratings.



Type	UL/CSA Short circuit current rating RMS sym. at		
	240V AC	480V AC	600V AC
NZM6B-.../ZM6-...-CNA	25 kA	25 kA	14 kA
NZMH6-.../ZM6-...-CNA	100 kA	65 kA	25 kA

# Motor Disconnect Switches, 150 A

Type N6-...-CNA

UL / CSA / IEC / EN 60 947-3

Circuit Breakers, Disconnect Switches, Molded Case Switches

Continuous Current Rating	Maximum HP rating 3 phase at				Type without handle Article No.	List Price see price list	Notes:						
	200V HP	230V HP	460V HP	575V HP									
A													
<p><b>UL/CSA short circuit withstand rating at 600V AC: 10 kA RMS sym.</b>                      Frame rated at 150A                      Line and load field-wiring terminals for cable connection supplied as standard</p>							<table border="1"> <tr> <th>Accessories</th> <th>Page</th> </tr> <tr> <td>Handles</td> <td>09/066</td> </tr> <tr> <td>Accessories</td> <td>09/064</td> </tr> </table>	Accessories	Page	Handles	09/066	Accessories	09/064
Accessories	Page												
Handles	09/066												
Accessories	09/064												
63	20	25	50	60	<b>N6-63-CNA</b> 048197		N6-...-CNA disconnect switches are UL recognized (UL 508) and CSA certified (C22.2 Nr. 14) as 3 pole, HP rated, non-automatic manual motor disconnects without any overload or short circuit tripping element. The switching mechanism has 3 positions (OFF, ON, + "tripped") and they can be equipped with voltage trip accessories, such as shunt trip and undervoltage trip coils.						
100	30	40	75	100	<b>N6-100-CNA</b> 067180								
150	40	60	100	125	<b>N6-160-CNA</b> 095656								





**Notes:**

- 1) For direct online switching of motors, use in combination with a listed magnetic contactor.
- 2) N6-...-CNA disconnect switches are also CE marked and in conformity with IEC/EN 60 947-3 (switch-disconnectors), which makes them suitable internationally as main disconnect switches in a broad range of industrial applications.
- 3) Backup overcurrent protection:  
 Maximum fuse - 300 A  
 Maximum circuit breaker - 300 A



## Molded Case Circuit Breakers and Disconnect Switches

Auxiliary Contacts for NZM(H)6(B)-....

Contacts	Type Suffix	List Price
N.O. = normally open N.C. = normally closed N.O.      N.C.	Article No. when ordering with basic device	see price list
<b>Standard auxiliary contacts</b>		
 2      2	<b>+NHI22-NZM4/6-NA</b> 082860	
<b>Early-make auxiliary contacts</b>		
 2 form C (change over) contacts	<b>+VHI002-NZM6-NA</b> 082861	
<b>Handle-operated early-make auxiliary contacts</b>		
 2 form C (change over) contacts	<b>+AHI002-NZM6-NA</b> 082862	
<b>Trip-indicating auxiliary contacts</b>		
 2 form C (change over) contacts	<b>+RHI002-NZM6-NA</b> 082863	

### Notes

Combination possibilities of auxiliary contacts:

NHI	VHI	AHI	RHI
●	●	-	-
●	-	●	-
●	-	-	●

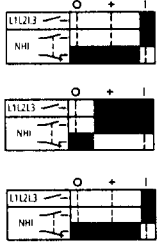
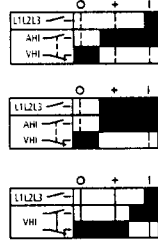
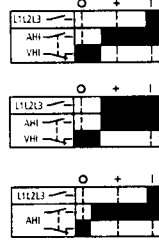
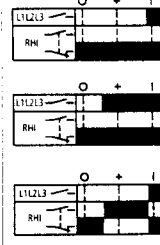

Dots in each row represent the types which can be combined together. Dashes indicate incompatibility.

Auxiliary contacts must be ordered with the device.

	NHI	VHI	AHI	RHI
	NHI standard auxiliary contacts operate simultaneously with the main contacts.  Typically used for signalling or switching auxiliary circuits such as a control circuit.	VHI early make auxiliary contacts lead the main contacts when switching ON as well as switching OFF.  Typically used for load shedding purposes or in conjunction with voltage trips in control circuits.	AHI handle operated auxiliary contacts operate in advance of the main contacts, shortly after the handle has left the OFF position.  Typically used to convert the manual actuation of the switch into a control function for circuit interlocking purposes.	RHI trip-indicating auxiliary contacts work independently of the normal ON and OFF operations of the device, switching only when the device has tripped due to overloads, over-currents or other tripping functions such as voltage trips.
Position of auxiliary contacts →	Same as main contacts	Same contact position in both <b>OFF</b> and <b>Tripped</b> position of the device	Same contact position in both <b>ON</b> and <b>Tripped</b> position of the device	Operates only when device is tripped
 Main contacts ■ closed □ open  Switching ON ○ → I  Switching OFF ○ ← I  Tripped position + ← I				
		VHI and AHI-NZM6 operate in similar fashion during switching ON and OFF		

# Molded Case Circuit Breakers and Disconnect Switches

## Voltage Trips for NZM(H)6(B)-...

Rated Control Voltage	Type Suffix	List Price	Notes
V/Hz	to be ordered with device only Article No.	see price list	
<b>Shunt trips</b>			
Short-time duty rating			
			
Short time actuation can be achieved by using the NHI auxiliary contact ahead in series with the shunt trip coil			
Cannot be mounted together with undervoltage trips.			
AC	110/50 120/60	<b>+A-NZM4/6(110V50HZ/120V60HZ)-NA</b> 084879	Shunt trips are typically used to electrically trip the device from a remote location
	120/60	<b>+A-NZM4/6(120V60HZ)-NA</b> 084874	
	208/60	<b>+A-NZM4/6(208V60HZ)-NA</b> 084875	
	240/60	<b>+A-NZM4/6(240V60HZ)-NA</b> 084876	
	480/60	<b>+A-NZM4/6(480V60HZ)-NA</b> 084877	
	600/60	<b>+A-NZM4/6(600V60HZ)-NA</b> 084878	
DC	24	<b>+A-NZM4/6(24VDC)</b> 082228	
<b>Undervoltage trips, non-delayed</b>			
Continuous duty rating			
			
Power can be applied to the undervoltage trip using VHI early-make auxiliary contacts in series with the undervoltage trip coil.			
Cannot be mounted together with shunt trips.			
AC	120/60	<b>+U-NZM4/6(120V60HZ)</b> 082872	Undervoltage trips will electrically trip the device open under power loss and can be used for control interlocking purposes, e.g. to disconnect the main switch in Emergency-Stop circuits.
	208/60	<b>+U-NZM4/6(208V60HZ)</b> 082873	
	240/60	<b>+U-NZM4/6(240V60HZ)</b> 082874	
	480/60	<b>+U-NZM4/6(480V60HZ)</b> 082875	
	600/60	<b>+U-NZM4/6(600V60HZ)</b> 082876	
DC	24	<b>+U-NZM4/6(24VDC)</b> 082242	





**Notes:**

<sup>1)</sup> Voltage trips must be ordered with the device.

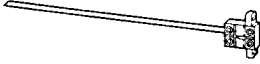
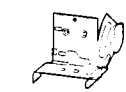

## Molded Case Circuit Breakers and Disconnect Switches

Accessories for NZM(H)6(B)-...

	Color of handle	for use with	Type Suffix Article No. when ordering with basic device	Type Article No. when ordering separately <sup>1)</sup>	List Price see price list
<b>Handle for open or panel mounted devices</b>					
Fastens to shaft, not padlockable					
					
	gray	NZM(H)6(B)... N6	<b>+H6U</b> 060765	<b>H6U</b> 093191	
	black	NZM(H)6(B)... N6	<b>+H6U-SW</b> 064370	<b>H6U-SW</b> 034176	
<b>Handle for cover/door interlocking</b>					
Degree of protection UL/NEMA 3R, 12; IP 55					
Door coupling rotary handle. For front mounting in doors and covers. Can be locked in the OFF position with up to 3 padlocks (hasp thickness 6 - 8mm).					
Door/cover interlocking supplied standard set in OFF position. Can be field modified for setting in ON position.					
3 distinct handle positions: OFF - + (tripped) - ON					
					
	gray	NZMH4-... NZM(H)6(B)-...	<b>+H6-NA</b> 005346	<b>H6-NA</b> 088445	
	black	NZMH4-... NZM(H)6(B)-...	<b>+H6-SW-NA</b> 106023	<b>H6-SW-NA</b> 088865	
for Emergency-Stop function	red-yellow	NZMH4-... NZM(H)6(B)-...	<b>+RH6-NA</b> 094994	<b>RH6-NA</b> 026874	
<b>Extension shaft</b>					
Mounting depth 150–400 mm, extends shaft length by 266 mm.					
Only one extension shaft possible.					
Can also be used with mechanical interlock.					
					
		NZMH4-... NZM(H)6(B)-... N6	<b>+A-NZM6</b> 058392	<b>A-NZM6</b> 026643	
<b>Padlocking accessory</b>					
Enables the device to be padlocked OFF when the panel door is open.					
Accommodates up to 3 padlocks (hasp thickness 6 - 8 mm).					
A limit switch (Type AT0) can also be installed for signalling or electrical interlocking purposes.					
					
		NZM(H)6(B)... N6	<b>+SVB-NZM6</b> 051238	<b>SVB-NZM6</b> 048253	
<b>Switch position indicator</b>					
indicates position of switch when panel door is open					
		NZMH4-... NZM(H)6(B)-...	<b>+SA-NZM6</b> 056019	<b>SA-NZM6</b> 045867	
<b>Maintenance handle</b>					
To actuate the device when the panel door is open					
					
		NZM(H)6(B)... N6	<b>+H6UZ</b> 065883	<b>H6UZ</b> 065884	
<b>Mechanical interlock</b>					
For mechanical interlocking of two devices. Requires two handles, one for each switch. Order separately					
					
		NZM(H)6(B)... N6	<b>+KV-2NZM6</b> 052566	<b>KV-2NZM6</b> 071864	

Notes:

<sup>1)</sup> Accessories are field installable.

# Molded Case Circuit Breakers and Disconnect Switches

Accessories for NZM(H)6(B)-....

Color of handle	for use with	Type Suffix Article No. when ordered with basic device	Type Article No. when ordered separately <sup>1)</sup>	List Price see price list
-----------------	--------------	---	--	------------------------------

## Rear operation shafts

For side panel mounting where device is only accessible from the rear (e.g. sides of enclosure panels). Must be combined with H...R rear operation handle. Factory installed only. Order with device

NZM(H)6(B)-...  
N6

**+R-NZM6**  
002964

## Operating handle for rear operation

Used with rear operation shaft.

Degree of protection UL/NEMA 3R, 12; IP 55

Can be locked in the OFF position with up to 3 padlocks (hasp thickness 6 - 8mm).

No cover/door interlocking provisions.

3 distinct handle positions: OFF - + (tripped) - ON



gray	NZMH4-... NZM(H)6(B)-... N6	<b>+H6-R-NA</b> 005347	<b>H6-R-NA</b> 059551
black	NZMH4-... NZM(H)6(B)-... N6	<b>+H6-R-SW-NA</b> 106022	<b>H6-R-SW-NA</b> 201665
for Emergency-Stop functions red-yellow	NZMH4-... NZM(H)6(B)-... N6	<b>+RH6-R-NA</b> 095224	<b>RH6-R-NA</b> 069043

## Legend plate (for mounting with operating handle)

Silver-colored



Specify desired text.

Black lettering; height of letters 3.5, 5 and 7mm

Blank

for engraving or printing

NZMH4-...  
NZM(H)6(B)-...

**+ZSSOND-NZM6**  
075003

**ZSSOND-NZM6**  
064984

NZMH4-...  
NZM(H)6(B)-...

**+ZS60-NZM6**  
077376

**ZS60-NZM6**  
064913

## Main disconnect warning plate

Silver-colored, black lettering.

English inscription:

"Main Switch - Open only in OFF Position"

English

NZMH4-...  
NZM(H)6(B)-...

**+ZS62-NZM6**  
053654

**ZS62-NZM6**  
044161

French

**+ZS63-NZM6**  
056027

**ZS63-NZM6**  
046534

For other languages, see below <sup>2)</sup>

**+ZS...-NZM6**  
108827

**ZS...-NZM6**  
108826



## Notes:

<sup>1)</sup> Accessories shown in this column are field installable

<sup>2)</sup> Engraved main disconnect warning plates are available in the following languages:

61 German	68 Italian	73 Romanian	78 Czech
64 Bulgarian	69 Greek	74 Russian	79 Turkish
65 Danish	70 Norwegian	75 Swedish	80 Hungarian
66 Finnish	71 Polish	76 Serbo-Croatian	81 Afrikaans
67 Dutch	72 Portuguese	77 Spanish	

Insert language key number into type number

### Example:

Warning plate in Italian language:  
ZS 68-NZM 6

## Molded Case Circuit Breakers and Disconnect Switches

Accessories for NZM(H)6(B)-...

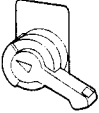
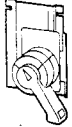
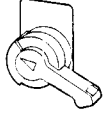
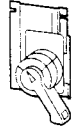
	Type Suffix Article No. when ordered with basic device	Type Article No. when ordered separately <sup>1)</sup>	List Price see price list
<b>Main disconnect switch assembly kits for CE marked control panels per IEC/EN 60 204-1</b>			
NZM(H)6(B)-... switches with dual UL/CSA and IEC/EN ratings are suitable for use as main disconnect switches in control panels that must be CE marked and designed to comply with the Machinery Directive Standard EN 60 204-1. The kits shown below, ordered with the device or separately, will provide the necessary accessories to fulfill the main disconnect switch function for these applications. Note: in cases where the main disconnect switch also fulfills the Emergency-Stop function, please specify kits containing red handle and yellow backing plate assemblies.			
<ul style="list-style-type: none"> <li>• Main disconnect handle with door/cover interlock for front mounting,</li> <li>• Red color handle with yellow backing plate for Emergency-Stop function,</li> <li>• Terminal cover</li> <li>• Main switch marking plate</li> </ul> 	<b>+V-NZM6</b> 070257	<b>V-NZM6</b> 086257	
<ul style="list-style-type: none"> <li>• Main disconnect handle for rear operated switches, red in color with yellow backing plate for Emergency-Stop function,</li> <li>• supplied with steel plate for panel side mounting,</li> <li>• Terminal cover</li> <li>• Main switch marking plate</li> </ul> 	<b>+EA-NZM6</b> 072630	<b>EA-NZM6</b> 043322	
<b>Main disconnect switch assembly kit, black</b>			
For front mounting Same as V-NZM6, except that the main disconnect handle is black in colour with silver backing plate for standard, non-Emergency-Stop function			
	<b>+V-NZM6-SW</b> 054136	<b>V-NZM6-SW</b> 054148	
	<b>+EA-NZM6-SW</b> 054144	<b>EA-NZM6-SW</b> 054156	
Notes:			
<sup>1)</sup> Kits are field-installable			





# Molded Case Circuit Breakers and Disconnect Switches

Accessories for NZM(H)6(B)-...

	<b>Type Suffix</b> Article No. when ordering with basic device	<b>Type</b> Article No. when ordering separately <sup>1)</sup>	<b>List Price</b> see price list
<b>Control circuit tap-off terminals</b> Supplementary terminals attached to main terminals. 3 connections top and bottom. Factory addition only, must be ordered with device	<b>+ST-NA</b> 092761	—	
<b>Terminal cover</b> Provides shock hazard protection in the area of the field wiring power terminals. Can be used at top or bottom, one cover per side. Mandatory requirement on the supply side of main disconnect switches to provide protection against accidental contact with line side feed.	<b>+H-NZM6</b> 098733	<b>H-NZM6</b> 093188	

**Notes:**

<sup>1)</sup> Accessories are field installable



## Inverse Time Circuit Breakers, 250A

Thermal-magnetic Type NZM(H)9-...-NA

Fixed Thermal Setting	Adjustable magnetic trip, supplied standard with the breaker	Adjustable magnetic trip, available as a substitute to standard ratings	UL/CSA Interrupting Ratings (AC, 60Hz) kA RMS sym. at	Type, without handle Article No.	List Price see price list
A	A	A	240V 480V 600V		

### Standard Interrupting Rating

Frame rated at 250A  
Line and load field-wiring terminals for cable connection supplied as standard

70	600 - 1200	400 - <b>800</b>	30 25 18	<b>NZM9-250/ZM9A-70-NA</b> 026319
80				<b>NZM9-250/ZM9A-80-NA</b> 028692
90				<b>NZM9-250/ZM9A-90-NA</b> 031065
100	1000 - 2000	600 - <b>1200</b> , 400 - <b>800</b>		<b>NZM9-250/ZM9A-100-NA</b> 033438
125				<b>NZM9-250/ZM9A-125-NA</b> 035811
150	1000 - 2000	600 - <b>1200</b>		<b>NZM9-250/ZM9A-150-NA</b> 038184
175	1600 - 2400	600 - <b>1200</b> 1000 - <b>2000</b>		<b>NZM9-250/ZM9A-175-NA</b> 074312
200				<b>NZM9-250/ZM9A-200-NA</b> 040557
225				<b>NZM9-250/ZM9A-225-NA</b> 042930
250				<b>NZM9-250/ZM9A-250-NA</b> 076685

### High Interrupting Rating

#### UL/CSA Current-limiting Circuit Breaker

Frame rated at 250A  
Line and load field-wiring terminals for cable connection supplied as standard

70	600 - 1200	400 - <b>800</b>	200 85 42	<b>NZMH9-250/ZM9A-70-NA</b> 052425
80				<b>NZMH9-250/ZM9A-80-NA</b> 054798
90				<b>NZMH9-250/ZM9A-90-NA</b> 057171
100	1000 - 2000	600 - <b>1200</b> , 400 - <b>800</b>		<b>NZMH9-250/ZM9A-100-NA</b> 059544
125				<b>NZMH9-250/ZM9A-125-NA</b> 061917
150	1000 - 2000	600 - <b>1200</b>		<b>NZMH9-250/ZM9A-150-NA</b> 064290
175	1600 - 2400	600 - <b>1200</b> , 1000 - <b>2000</b>		<b>NZMH9-250/ZM9A-175-NA</b> 041095
200				<b>NZMH9-250/ZM9A-200-NA</b> 066663
225				<b>NZMH9-250/ZM9A-225-NA</b> 069036
250				<b>NZMH9-250/ZM9A-250-NA</b> 043468

**Notes:**

Accessories	Page
Handles	09/076
Accessories	09/074

NZM9-.../ZM9A-...-NA molded case circuit breakers are UL listed (UL 489) and CSA certified (22.2 Nr. 5.1) inverse time, thermal-magnetic circuit breakers with a fixed thermal and adjustable magnetic trip function.

NZMH9-.../ZM9A-...-NA molded case circuit breakers are UL listed (UL 489) and CSA certified (22.2 Nr. 5.1) inverse time, thermal-magnetic current-limiting circuit breakers with a fixed thermal and adjustable magnetic trip function.

Both types are CE marked and in conformity with IEC/EN 60 947-2 (circuit breakers), which also make them suitable internationally as inverse time molded case circuit breakers. Consult the technical data and Moeller Electric for IEC/EN ratings.

**Ordering Information:**

State type, example:  
**NZM9-250/ZM9A-250-NA**

Optionally, select a substitute magnetic trip range and insert the bold number into type number, example:  
**NZM9-250/ZM9A-250-2000-NA**



# Molded Case Circuit Breakers, Instantaneous Trip, 250A

Type NZM(H)9-.../ZM9-...-OBI-...

Continuous Current Rating	Adjustable Magnetic Trip Range <sup>1)</sup>	Type, without handle Article No.	List Price see price list	Notes:
A	A			
<b>Standard Interrupting Rating up to 600V AC</b> Frame rated at 250A Line and load field-wiring terminals for cable connection supplied as standard				Accessories Page Handles 09/076 Accessories 09/074
63	400 - 800	<b>NZM9-250/ZM9-63-800-OBI-CNA</b> 069566		NZM9-250/ZM9-...-OBI-CNA and NZMH9-250/ZM9-...-OBI-CNA molded case circuit breakers are UL recognized (UL 489) and CSA certified (22.2 Nr. 5.1) instantaneous trip type circuit breakers with an adjustable magnetic trip function. Per NEC, they provide motor short circuit protection as part of a listed combination motor controller that includes coordinated motor overload protection. Short circuit interrupting ratings are, therefore, established and valid only for the listed combination motor controller assembly and associated housing or enclosure.  The NZMH9 instantaneous trip circuit breaker features a current-limiting design contact assembly and can provide high fault short circuit current ratings of up to 85kA at 480V AC.  Consult Section 03 of this catalog for combination motor controller short-circuit ratings as standard starters featuring type NZM instantaneous trip circuit breakers.  Consult Moeller Electric for combination motor controller high fault short circuit ratings as motor control centre unit starters featuring NZMH instantaneous trip circuit breakers.
100	600 - 1200	<b>NZM9-250/ZM9-100-1200-OBI-CNA</b> 093295		
160	1000 - 2000	<b>NZM9-250/ZM9-160-2000-OBI-CNA</b> 019733		
200	1600 - 2400	<b>NZM9-250/ZM9-200-2400-OBI-CNA</b> 033971		
250	1600 - 2400	<b>NZM9-250/ZM9-250-2400-OBI-CNA</b> 048209		
<b>High Fault Interrupting Rating up to 600V AC</b> Frame rated at 250A Line and load field-wiring terminals for cable connection supplied as standard				
63	400 - 800	<b>NZMH9-250/ZM9-63-800-OBI-CNA</b> 036349		
100	600 - 1200	<b>NZMH9-250/ZM9-100-1200-OBI-CNA</b> 079062		
160	1000 - 2000	<b>NZMH9-250/ZM9-160-2000-OBI-CNA</b> 088554		
200	1600 - 2400	<b>NZMH9-250/ZM9-200-2400-OBI-CNA</b> 098046		
250	1600 - 2400	<b>NZMH9-250/ZM9-250-2400-OBI-CNA</b> 019738		

Notes:

<sup>1)</sup> Optional magnetic trip ranges are available for some sizes of circuit breakers. Consult Moeller Electric.



**Motor Disconnect Switches**  
Type NZM(H)9-.../ZM9-...-CNA

Circuit Breakers, Disconnect Switches, Molded Case Switches

Setting range Thermal trip	Instantaneous magnetic trip	Maximum HP Rating 3 phase at				Type, without handle	List Price
		200V HP	230V HP	460V HP	575V HP		
A	A					Article No.	see price list

**Standard Short Circuit Rating**

Frame rated at 250A  
Line and load field-wiring terminals for cable connection supplied as standard

Setting range	Instantaneous magnetic trip	200V HP	230V HP	460V HP	575V HP	Article No.
63 - 100	600 - 1200	30	30	75	100	<b>NZM9-250/ZM9-100-CNA</b> 098041
100 - 160	1000 - 2000	50	60	125	150	<b>NZM9-250/ZM9-160-CNA</b> 024479
160 - 200	1600 - 2400	60	75	150	200	<b>NZM9-250/ZM9-200-CNA</b> 038717
200 - 250	1600 - 2400	75	75	150	225	<b>NZM9-250/ZM9-250-CNA</b> 052955

With optional lower magnetic trip values <sup>1)</sup>

63 - 100	400 - 800	30	30	75	100	<b>NZM9-250/ZM9-100-800-CNA</b> 035818
100 - 160	600 - 1200	50	60	125	150	<b>NZM9-250/ZM9-160-1200-CNA</b> 040564
160 - 200	1000 - 2000	60	75	150	200	<b>NZM9-250/ZM9-200-2000-CNA</b> 045310
200 - 250	1000 - 2000	75	75	150	225	<b>NZM9-250/ZM9-250-2000-CNA</b> 047683

**High Fault Short Circuit Rating**

Frame rated at 250A  
Line and load field-wiring terminals for cable connection supplied as standard

63 - 100	600 - 1200	30	30	75	100	<b>NZMH9-250/ZM9-100-CNA</b> 081435
100 - 160	1000 - 2000	50	60	125	150	<b>NZMH9-250/ZM9-160-CNA</b> 090927
160 - 200	1600 - 2400	60	75	150	200	<b>NZMH9-250/ZM9-200-CNA</b> 012619
200 - 250	1600 - 2400	75	75	150	225	<b>NZMH9-250/ZM9-250-CNA</b> 022111

With optional lower magnetic trip values <sup>1)</sup>

63 - 100	400 - 800	30	30	75	100	<b>NZMH9-250/ZM9-100-800-CNA</b> 069039
100 - 160	600 - 1200	50	60	125	150	<b>NZMH9-250/ZM9-160-1200-CNA</b> 073785
160 - 200	1000 - 2000	60	75	150	200	<b>NZMH9-250/ZM9-200-2000-CNA</b> 078531
200 - 250	1000 - 2000	75	75	150	225	<b>NZMH9-250/ZM9-250-2000-CNA</b> 083277

**Notes:**

Accessories	Page
Handles	09/076
Accessories	09/074

NZM9-.../ZM9-...-CNA and NZMH9-.../ZM9-...-CNA disconnect switches are UL recognized (UL 508) and CSA certified (C22.2 Nr. 14) 3-pole HP rated manual motor disconnects with built-in thermal trips for motor overload protection. An adjustable dial on the front of the switch can be set to the motor full load current.

An adjustable magnetic trip provides additional protection in the case of short circuits. Per NEC, branch circuit overcurrent protection devices must be provided separately.

NZM9-.../ZM9-...-CNA and NZMH9-.../ZM9-...-CNA disconnect switches are CE marked and in conformity with IEC/EN 60 947-2 (circuit breakers), which makes them suitable internationally as inverse time molded case circuit breakers with adjustable thermal and magnetic trips.

Consult the technical data and Moeller Electric for IEC/EN ratings.

For direct online switching of motors, use in combination with listed magnetic contactor.

**Notes:**

<sup>1)</sup> Optional magnetic trip ranges are available for some sizes of circuit breakers. Consult Moeller Electric

Type	UL/CSA Short circuit current rating RMS sym. at		
	240V AC	480V AC	600V AC
NZM9-.../ZM9-...-CNA	30 kA	25 kA	18 kA
NZMH9-.../ZM9-...-CNA	200 kA	85 kA	42 kA



**Motor Disconnect Switches, 250 A**

UL / CSA IEC / EN 60 947-3

Type N9-...-CNA

Circuit Breakers, Disconnect Switches, Molded Case Switches





Continuous Current Rating	Maximum HP rating 3 phase at				Type without handle Article No.	List Price see price list	Notes:						
	200V HP	230V HP	460V HP	575V HP									
A													
<p><b>UL/CSA short circuit rating at 600V AC: 10 kA RMS sym.</b>                      Frame rated at 250A                      Line and load field-wiring terminals for cable connection supplied as standard</p>													
							<table border="1"> <thead> <tr> <th>Accessories</th> <th>Page</th> </tr> </thead> <tbody> <tr> <td>Handles</td> <td>09/076</td> </tr> <tr> <td>Accessories</td> <td>09/074</td> </tr> </tbody> </table>	Accessories	Page	Handles	09/076	Accessories	09/074
Accessories	Page												
Handles	09/076												
Accessories	09/074												
250	60	75	150	200	<b>N9-250-CNA</b> 031587		<p>N9-...-CNA disconnect switches are UL recognized (UL 508) and CSA certified (C22.2 Nr. 14) as 3 pole, HP rated, non-automatic manual motor disconnects without any overload or short circuit tripping element. The switching mechanism has 3 positions (OFF, "tripped", ON) and they can be equipped with voltage trip accessories, such as shunt trip and undervoltage trip coils.</p>						

**Notes:**

- 1) For direct online switching of motors, use in combination with a listed magnetic contactor.
- 2) N9-...-CNA disconnect switches are also CE marked and in conformity with IEC/EN 60 947-3 (switch-disconnectors), which makes them suitable internationally as main disconnect switches in a broad range of industrial applications.
- 3) Backup overcurrent protection:  
 Maximum fuse - 450 A  
 Maximum circuit breaker - 500 A



## Molded Case Circuit Breakers and Disconnect Switches Auxiliary Contacts for NZM(H)9-...

Contacts	Type Suffix	List Price
N.O. = normally open N.C. = normally closed	Article No. when ordering with basic device	see price list
N.O.      N.C.		
<b>Standard auxiliary contacts</b>		
 2      2	<b>+NHI22-NZM9</b> 091579	
<b>Early-make auxiliary contacts</b>		
 2 form C (change over) contacts	<b>+VHI002-NZM9</b> 093952	
<b>Handle-operated early-make auxiliary contacts</b>		
 2 form C (change over) contacts	<b>+AHI002-NZM9</b> 044120	
<b>Trip-indicating auxiliary contacts</b>		
 2 form C (change over) contacts	<b>+RHI002-NZM9</b> 046493	

### Notes

Combination possibilities of auxiliary contacts:

NHI	VHI	AHI	RHI
●	●	-	-
●	-	●	-
●	-	-	●

Dots in each row represent the types which can be combined together. Dashes indicate incompatibility.

Auxiliary contacts must be ordered with the device.

NHI	VHI	AHI	RHI
NHI standard auxiliary contacts operate simultaneously with the main contacts.	VHI early make auxiliary contacts lead the main contacts when switching ON as well as switching OFF.	AHI handle operated auxiliary contacts operate in advance of the main contacts, shortly after the handle has left the OFF position.	RHI trip-indicating auxiliary contacts work independently of the normal ON and OFF operations of the device, switching only when the device has tripped due to overloads, over-currents or other tripping functions such as voltage trips.
Typically used for signalling or switching auxiliary circuits such as a control circuit.	Typically used for load shedding purposes or in conjunction with voltage trips in control circuits.	Typically used to convert the manual actuation of the switch into a control function for circuit interlocking purposes.	

Position of auxiliary contacts →

Same as main contacts	Same contact position in both OFF and Tripped position of the device	Same contact position in both ON and Tripped position of the device	Operates only when device is tripped



Main contacts  
 ■ closed  
 □ open

Switching ON  
 ○ → |

Switching OFF  
 ○ ← |

Tripped position  
 + ← |

# Molded Case Circuit Breakers and Disconnect Switches

## Voltage Trips, Motor Operators for NZM(H)9-...

Rated Control Voltage	Type Suffix	List Price	Notes
V/Hz	Article No. to be ordered with device only	see price list	
<b>Shunt trips</b>			
100% continuous duty rating			
			
If desired, automatic disconnection of the shunt trip coil can be achieved by using the NHI auxiliary contact in series with the coil. Shunt trips cannot be mounted together with undervoltage trips.			
AC	120/60	<b>+A-NZM9(120V60HZ)</b> 057267	Shunt trips are typically used to electrically trip the device from a remote location
	208/60	<b>+A-NZM9(208V60HZ)</b> 057750	
	240/60	<b>+A-NZM9(240V60HZ)</b> 057982	
	480/60	<b>+A-NZM9(480V60HZ)</b> 059333	
	600/60	<b>+A-NZM9(600V60HZ)</b> 059641	
DC	24	<b>+A-NZM9(24VDC)</b> 060081	Intermittent operation requires coil clearing auxiliary contact NH122-NZM9





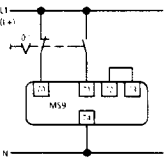
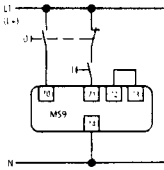

<b>Undervoltage trips, non-delayed</b>			
Continuous duty rating			
			
Power can be applied to the undervoltage trip using VHI early-make auxiliary contacts in series with the undervoltage trip coil. Cannot be mounted together with shunt trips.			
AC	120/60	<b>+U-NZM9(120V60HZ)</b> 048136	Undervoltage trips will electrically trip the device open under power loss and can be used for control interlocking purposes, e.g. to disconnect the main switch in Emergency-Stop circuits.
	208/60	<b>+U-NZM9(208V60HZ)</b> 048287	
	240/60	<b>+U-NZM9(240V60HZ)</b> 048427	
	480/60	<b>+U-NZM9(480V60HZ)</b> 048729	
	600/60	<b>+U-NZM9(600V60HZ)</b> 048841	
DC	24	<b>+U-NZM9(24VDC)</b> 049868	

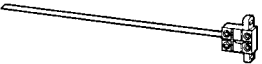

<b>Motor operator for quick-acting switches</b>			
Closing time on receipt of signal ≤ 60 ms Time lag between signals must be at least 3 s.	AC	120/60	<b>+MS9(120V60HZ)</b> 015644
		208/220/60	<b>+MS9(208/220V60HZ)</b> 002448
Can only be supplied with device. With three wire control, manual operation possible with handle.			
Two-wire control			
Maintain pilot command min. 1.5s			
			
Three-wire control			
$I \geq 1s$ $I \geq 30ms$			
			

**Molded Case Circuit Breakers and Disconnect Switches**

Accessories for NZM(H)9-...

	Color of handle	for use with	Type Suffix Article No. when ordering with basic device	Type Article No. when ordering separately <sup>1)</sup>	List Price see price list
<b>Handle for open or panel mounted devices</b>					
Fastens to shaft, not padlockable					
					
	gray	NZM(H)9-... N9	<b>+H9U</b> 042716	<b>H9U</b> 017256	
	black	NZM9-... N9	<b>+H9U-SW</b> 065009	<b>H9U-SW</b> 034175	
<b>Handle for cover/door interlocking</b>					
Degree of protection UL/NEMA 3R, 12; IP 55					
Door coupling rotary handle. For front mounting in doors and covers. Can be locked in the OFF position with up to 3 padlocks (hasp thickness 6 - 8mm).					
Door/cover interlocking supplied standard set in OFF position. Can be field modified for setting in ON position.					
3 distinct handle positions: OFF - + (tripped) - ON					
					
	gray	NZM(H)9-... N9	<b>+H9-NA</b> 005349	<b>H9-NA</b> 012510	
	black	NZM(H)9-... N9	<b>+H9-SW-NA</b> 106026	<b>H9-SW-NA</b> 088864	
for Emergency-Stop function	red-yellow	NZM(H)9-... N9	<b>+RH9-NA</b> 095462	<b>RH9-NA</b> 033993	
<b>Extension shaft</b>					
Mounting depth 150–400 mm, extends shaft length by 266 mm.					
Only one extension shaft possible.					
Can also be used with mechanical interlock.					
					
		NZM(H)9-... N9	<b>+A-NZM9</b> 044155	<b>A-NZM9</b> 033762	
<b>Padlocking accessory</b>					
Enables the device to be padlocked OFF when the panel door is open.					
Accommodates up to 3 padlocks (hasp thickness 6 - 8 mm).					
A limit switch (Type ATO) can also be installed for signalling or electrical interlocking purposes.					
					
		NZM(H)9-... N9	<b>+SVB-NZM9</b> 032161	<b>SVB-NZM9</b> 050626	
<b>Switch position indicator</b>					
Indicates position of switch when panel door is open					
		NZM(H)9-... N9	<b>+SA-NZM9</b> 041782	<b>SA-NZM9</b> 048240	
<b>Maintenance handle</b>					
To actuate the device when the panel door is open					
					
		NZM(H)9-... N9	<b>+H9UZ</b> 043929	<b>H9UZ</b> 043927	
<b>Mechanical interlock</b>					
For mechanical interlocking of two devices. Requires two handles, one for each switch. Order separately					
					
		NZM(H)9-... N9	<b>+KV-2NZM9</b> 052570	<b>KV-2NZM9</b> 076610	



Notes:

<sup>1)</sup> Accessories are field installable.



## Molded Case Circuit Breakers and Disconnect Switches

## Accessories for NZM(H)9-...

	Color of handle	for use with	Type Suffix Article No. when ordered with basic device	Type Article No. when ordered separately <sup>1)</sup>	List Price see price list
<b>Rear operation shafts</b>					
For side panel mounting where device is only accessible from the rear (e.g. sides of enclosure panels). Must be combined with H...R rear operation handle. Factory installed only. Order with device					
		NZM(H)9-... N9	<b>+R-NZM9</b> 002966	-	
<b>Operating handle for rear operation</b>					
Used with rear operation shaft. Degree of protection UL/NEMA 3R, 12; IP 55 Can be locked in the OFF position with up to 3 padlocks (hasp thickness 6 - 8mm). No cover/door interlocking provisions. 3 distinct handle positions: OFF - + (tripped) - ON					
					
	gray	NZM(H)9-... N9	<b>+H9-R-NA</b> 005350	<b>H9-R-NA</b> 061924	
	black	NZM(H)9-... N9	<b>+H9-R-SW-NA</b> 106025	<b>H9-R-SW-NA</b> 201666	
for Emergency-Stop functions	red-yellow	NZM(H)9-... N9	<b>+RH9-R-NA</b> 095584	<b>RH9-R-NA</b> 071416	
<b>Legend plate (for mounting with operating handle)</b>					
Silver-colored					
					
Specify desired text Black lettering; height of letters 3.5, 5 and 7mm		NZM(H)9-... N9	<b>+ZSSOND-NZM9</b> 046528	<b>ZSSOND-NZM9</b> 067357	
Blank for engraving or printing		NZM(H)9-... N9	<b>+ZS60-NZM9</b> 048901	<b>ZS60-NZM9</b> 067286	
<b>Main disconnect warning plate</b>					
Silver-colored, black lettering, English inscription: "Main Switch - Open only in OFF Position"					
English		NZM(H)9-... N9	<b>+ZS62-NZM9</b> 013314	<b>ZS62-NZM9</b> 093994	
French			<b>+ZS63-NZM9</b> 015687	<b>ZS63-NZM9</b> 096367	
For other languages, see below <sup>2)</sup>			<b>+ZS...-NZM9</b> 109309	<b>ZS...-NZM9</b> 109308	

**Notes:** <sup>1)</sup> Accessories shown in this column are field installable

<sup>2)</sup> Engraved main disconnect warning plates are available in the following languages:

61 German	68 Italian	73 Romanian	78 Czech
64 Bulgarian	69 Greek	74 Russian	79 Turkish
65 Danish	70 Norwegian	75 Swedish	80 Hungarian
66 Finnish	71 Polish	76 Serbo-Croatian	81 Afrikaans
67 Dutch	72 Portuguese	77 Spanish	

Insert language key number into type number

**Example:**

Warning plate in Italian language:  
ZS 68-NZM 9

## Molded Case Circuit Breakers and Disconnect Switches

### Accessories for NZM(H)9-...

	Type Suffix	Type	List Price
	Article No. when ordered with basic device	Article No. when ordered separately <sup>1)</sup>	see price list

#### Main disconnect switch assembly kits for CE marked control panels per IEC/EN 60 204-1

NZMH9-... switches with dual UL/CSA and IEC/EN ratings are suitable for use as main disconnect switches in control panels that must be CE marked and designed to comply with the Machinery Directive Standard EN 60 204-1.

The kits shown below, ordered with the device or separately, will provide the necessary accessories to fulfill the main disconnect switch function for these applications.

Note: in cases where the main disconnect switch also fulfills the Emergency-Stop function, please specify kits containing red handle and yellow backing plate assemblies.

- Main disconnect handle with door/cover interlock for front mounting,
- Red color handle with yellow backing plate for Emergency-Stop function,
- Terminal cover
- Main switch marking plate

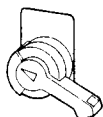

**+V-NZM9**  
058393

**V-NZM9**  
091003

- Main disconnect handle for rear operated switches, red in color with yellow backing plate for Emergency-Stop function,
- supplied with steel plate for panel side mounting,
- Terminal cover
- Main switch marking plate

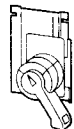

**+EA-NZM9**  
060766

**EA-NZM9**  
045695

#### Main disconnect switch assembly kit, black

For front mounting  
Same as V-NZM9, except that the main disconnect handle is black in color with silver backing plate for standard, non-Emergency-Stop function

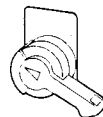

**+V-NZM9-SW**  
054137

**V-NZM9-SW**  
054149

For rear operated switches  
Same as EA-NZM9, except that the main disconnect handle is black in color with silver backing plate for standard, non-Emergency-Stop function

**+EA-NZM9-SW**  
054146

**EA-NZM9-SW**  
054158



#### Notes:

<sup>1)</sup> Kits are field-installable

# Molded Case Circuit Breakers and Disconnect Switches

Accessories for NZM(H)9-...

Circuit Breakers, Disconnect Switches, Molded Case Switches

	<b>Type Suffix</b> Article No. when ordered with basic device	<b>Type</b> Article No. when ordered separately <sup>1)</sup>	<b>List Price</b> see price list
<b>Control circuit tap-off terminals</b> Supplementary terminals attached to main terminals. 3 connections top and bottom. Factory addition only, must be ordered with device	<b>+ST</b> 052918	-	
<b>Terminal cover</b> Provides shock hazard protection in the area of the field wiring power terminals. Can be used at top or bottom, one cover per side. Mandatory requirement on the supply side of main disconnect switches to provide protection against accidental contact with line side feed.	<b>+H-NZM9</b> 063139	<b>H-NZM9</b> 012507	

**Notes:** <sup>1)</sup> Accessories are field installable



Circuit Breakers, Disconnect Switches, Molded Case Switches

**Inverse Time Circuit Breakers, 1000 A**  
Solid State Trip Type NZM12-...-NA

Long time response current setting	Adjustable instantaneous pick-up setting	Adjustable short time delay pick-up setting for selectivity in networks	UL/CSA Interrupting Ratings (AC, 60Hz)	Type without handle Article No.	List Price see price list
A	A	A	240V 480V 600V		

**Notes:**

**Fixed long time response setting**

Frame rated at 1000A  
Line and load field-wiring terminals for cable connection supplied as standard. <sup>1)</sup>

400	1200 - 12000	-	65 65 50	<b>NZM12-630/ZM12A-400-NA</b> 019857
500				<b>NZM12-630/ZM12A-500-NA</b> 080899
600				<b>NZM12-630/ZM12A-600-NA</b> 083272
700	1600 - 16000			<b>NZM12-800/ZM12A-700-NA</b> 002591
800				<b>NZM12-800/ZM12A-800-NA</b> 004964
1000	2000 - 20000			<b>NZM12-1250/ZM12A-1000-NA</b> 022099

Accessories Page

Handles 09/084

Accessories 09/082

NZM12-.../ZM12(A)-...-NA molded case circuit breakers are UL listed (UL 489) and CSA certified (C22.2 Nr. 5.1) inverse time, solid state trip circuit breakers with a fixed or adjustable long time response and adjustable instantaneous pick-up range.

**Adjustable long time response setting**

Frame rated at 1000A  
Line and load field-wiring terminals for cable connection supplied as standard <sup>1)</sup>

300 - 600	1200 - 12000	-	65 65 50	<b>NZM12-630/ZM12-600-NA</b> 017999
400 - 800	1600 - 16000			<b>NZM12-800/ZM12-800-NA</b> 019083
500 - 1000	2000 - 20000			<b>NZM12-1250/ZM12-1000-NA</b> 019314

**Adjustable long time response setting and short time delay pick-up for selectivity**

Frame rated at 1000A  
Line and load field-wiring terminals for cable connection supplied as standard <sup>1)</sup>

300 - 600	1200 - 12000	600 - 7200	65 65 50	<b>NZM12-630/ZM12V-600-NA</b> 019590
400 - 800	1600 - 16000	800 - 9600		<b>NZM12-800/ZM12V-800-NA</b> 019633
500 - 1000	2000 - 20000	1000 - 12000		<b>NZM12-1250/ZM12V-1000-NA</b> 019654

NZM12-.../ZM12V-...-NA molded case circuit breakers are UL listed (UL 489) and CSA certified (C22.2 Nr. 5.1) and have an additional short time delay pick-up range for selectivity in energy distribution networks. The time delay response is adjustable from 0 to 1000ms. <sup>2)</sup>



Notes:

- <sup>1)</sup> Refer to technical data for conductor sizes
- <sup>2)</sup> Time releases: 0, 10, 50, 100, 150, 200, 300, 500, 750, 1000 ms.

**Motor Disconnect Switches, 1200 A**  
Type N12-...-CNA

UL / CSA / IEC / EN 60 947-3

Circuit Breakers,  
Disconnect Switches, Molded Case Switches

Continuous Current Rating	Maximum HP Rating 3 Phase at				Type without handle Article No.	List Price  see price list	Notes:						
	200V HP	230V HP	460V HP	575V HP									
A													
Frame rated at 1200A Line and load field-wiring terminals for cable connection supplied as standard <sup>1)</sup>							<table border="1"> <thead> <tr> <th>Accessories</th> <th>Page</th> </tr> </thead> <tbody> <tr> <td>Handles</td> <td>09/084</td> </tr> <tr> <td>Accessories</td> <td>09/082.</td> </tr> </tbody> </table>	Accessories	Page	Handles	09/084	Accessories	09/082.
Accessories	Page												
Handles	09/084												
Accessories	09/082.												
600	200	250	450	600	<b>N12-630-CNA</b> 017347		N12-...-CNA disconnect switches are UL recognized (UL 508) and CSA certified (C22.2 Nr. 14) as 3 pole, HP rated non-automatic manual motor disconnects without any overload or short circuit tripping elements.  Their switching mechanism has 3 positions, OFF - ON - + (tripped) and they can be equipped with voltage trip accessories such as shunt trip and undervoltage trip coils.  UL/CSA short circuit rating: 42kA RMS sym. at 600V AC						
800	250	300	600	750	<b>N12-800-CNA</b> 022093								
1000	250	300	600	750	<b>N12-1000-CNA</b> 081487								
1200	300	450	1000	1000	<b>N12-1200-CNA <sup>2)</sup></b> 081517								

**Notes:**

- <sup>1)</sup> Refer to technical data for conductor sizes
- <sup>2)</sup> N12-1200-CNA is supplied standard with bolt-on connection only. Field-wiring terminals for conductor hook-up can be supplied but must be ordered with the device. Add the following suffixes to the type number:
  - +K240AL-NZM12-O (for top mounted terminals, set of three)  
076912
  - +K240AL-NZM12-U (for bottom mounted terminals, set of three)  
076916
 Each terminal will accept four conductors # 4 AWG - 500 MCM
- <sup>3)</sup> For direct on-line switching of motors, use in combination with a listed magnetic controller.



# Molded Case Circuit Breakers and Disconnect Switches

## Auxiliary Contacts for NZM12-...

Contacts	Type Suffix	List Price
N.O. = normally open N.C. = normally closed	Article No. when ordering with basic device	see price list
N.O.      N.C.		
<b>Standard auxiliary contacts <sup>1)</sup></b>		
2      2	<b>+NHI22-NZM12</b> 013272	
<b>Early-make auxiliary contacts</b>		
2      1	<b>+VHI21-NZM12</b> 015645	
<b>Handle-operated early-make auxiliary contacts</b>		
2      1	<b>+AHI21-NZM12</b> 018018	
<b>Trip-indicating auxiliary contacts</b>		
2      1	<b>+RHI21-NZM12</b> 020391	

### Notes

Combination possibilities of auxiliary contacts:<sup>1)</sup>

	NHI	VHI	AHI	RHI
N12	●	●	-	●
	●	-	●	●
NZM12-....	F	●	-	●
	F	-	●	●

Dots in each row represent the types which can be combined together. Dashes indicate incompatibility. F indicates standard equipment

<sup>1)</sup> NHI22-NZM12 auxiliary contact comes standard with all versions of the NZM12-.../ZM12-...-NA molded case circuit breakers. It is an optional accessory only for the non-automatic N12-...-CNA disconnect switches and must be ordered with the device if desired.

Auxiliary contacts must be ordered with device.

### NHI

NHI standard auxiliary contacts operate simultaneously with the main contacts.

Typically used for signalling or switching auxiliary circuits such as a control circuit.

### VHI

VHI early make auxiliary contacts lead the main contacts when switching ON as well as switching OFF.

Typically used for load shedding purposes or in conjunction with voltage trips in control circuits.

### AHI

AHI handle operated auxiliary contacts operate in advance of the main contacts, shortly after the handle has left the OFF position.

Typically used to convert the manual actuation of the switch into a control function for circuit interlocking purposes.

### RHI

RHI trip-indicating auxiliary contacts work independently of the normal ON and OFF operations of the device, switching only when the device has tripped due to overloads, over-currents or other tripping functions such as voltage trips.

Position of auxiliary contacts →

Same as main contacts

Same contact position in both **OFF** and **Tripped** position of the device

Same contact position in both **ON** and **Tripped** position of the device

Operates only when device is tripped



Main contacts  
O closed  
G open

Switching ON  
F → I

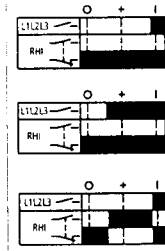
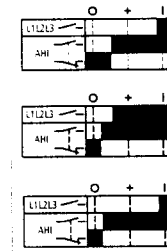
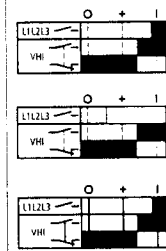
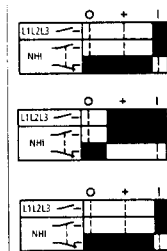

Switching OFF  
F ← I

Tripped position  
+ ← I



# Molded Case Circuit Breakers and Disconnect Switches



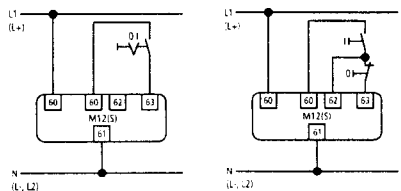
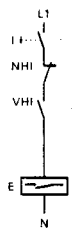

## Voltage Trips, Motor Operators for NZM12-...

Rated Control Voltage V/Hz	Type Suffix to be ordered with device only Article No.	List Price see price list	Notes
<b>Shunt trips</b> 100% continuous duty rating			
			
AC	120/60	<b>+A-NZM12(120V60HZ)</b> 050365	Shunt trips are typically used to electrically trip the device from a remote location  Automatic disconnection of the shunt trip can be achieved by using the NHI auxiliary contact ahead in series with the shunt trip coil Cannot be mounted together with undervoltage trips
	208/60	<b>+A-NZM12(208V60HZ)</b> 050482	
	240/60	<b>+A-NZM12(240V60HZ)</b> 050810	
	480/60	<b>+A-NZM12(480V60HZ)</b> 051098	
	600/60	<b>+A-NZM12(600V60HZ)</b> 052204	
DC	24	<b>+A-NZM12(24VDC)</b> 052324	
<b>Undervoltage trips, non-delayed</b> Continuous duty rating			
			
AC	120/60	<b>+U-NZM12(120V60HZ)</b> 050812	Undervoltage trips will electrically trip the device open under power loss and can be used for control interlocking purposes, e.g. to disconnect the main switch in Emergency-Stop circuits.  Power can be applied to the undervoltage trip using VHI early-make auxiliary contacts in series with the undervoltage trip coil. Cannot be mounted together with shunt trips
	208/60	<b>+U-NZM12(208V60HZ)</b> 051111	
	240/60	<b>+U-NZM12(240V60HZ)</b> 051200	
	480/60	<b>+U-NZM12(480V60HZ)</b> 052213	
	600/60	<b>+U-NZM12(600V60HZ)</b> 052261	
DC	24	<b>+U-NZM12(24VDC)</b> 052349	
<b>Motor operator</b> Closing time on receipt of signal ≤ 30 ms			
AC	120/60	<b>+M12(120V60HZ)</b> 088756	Can only be supplied with device. With three-wire control, manual operation possible with handle.  
	208/220/60	<b>+M12(208/220V60HZ)</b> 078384	
DC	60	<b>+M12(60VDC)</b> 083130	
	110/125	<b>+M12(110/125VDC)</b> 087876	
	220/240	<b>+M12(220/240VDC)</b> 090249	
<b>Motor operator for quick-acting switches</b>			
AC	120/60	<b>+M12S(120V60HZ)</b> 036551	Can only be supplied with device. Closing release supplied as standard. Suitable only for short-time operation of up to 1 s. Can also be achieved using NHI22 + VHI21 auxiliary contacts  
	208/220/60	<b>+M12S(208/220V60HZ)</b> 000076	

Note:

1) Voltage trips and motor operators must be ordered with the device.

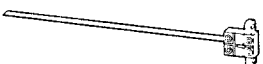
## Molded Case Circuit Breakers and Disconnect Switches Accessories for NZM12-...

Color of handle	for use with	Type Suffix Article No. when ordered with basic device	Type Article No. when ordered sepa- rately <sup>1)</sup>	List Price see price list																												
<b>Handle for open or panel mounted devices</b>																																
Fastens to shaft, not padlockable																																
																																
gray	NZM12... N12	<b>+H12U</b> 051272	<b>H12U</b> 052850																													
black	NZM12... N12	<b>+H12U-SW</b> 061727	<b>H12U-SW</b> 034173																													
<b>Handle for cover/door interlocking</b>																																
Degree of protection UL/NEMA 3R, 12; IP 55 Door coupling rotary handle. For front mounting in doors and covers. Can be locked in the OFF position with up to 3 padlocks (hasp thickness 6 - 8mm). Door/cover interlocking supplied standard set in OFF position. Can be field modified for setting in ON position. 3 distinct handle positions: OFF - + (tripped) - ON																																
																																
gray	NZM12... N12	<b>+H12-NA</b> 005341	<b>H12-NA</b> 048104																													
black	NZM12... N12	<b>+H12-SW-NA</b> 106020	<b>H12-SW-NA</b> 088863																													
for Emergency-Stop function	NZM12... N12	<b>+RH12-NA</b> 094919	<b>RH12-NA</b> 088571																													
<b>Extension shaft</b>																																
Mounting depth 240-400 mm. Extends shaft length by 183 mm. Only one extension shaft permitted. Can also be used with mechanical interlock.																																
																																
	NZM12... N12	<b>+A-NZM12</b> 041780	<b>A-NZM12</b> 081221																													
<b>Switch position indicator</b>																																
indicates position of switch when panel door is open																																
	NZM12... N12	<b>+SA-NZM12</b> 039407	<b>SA-NZM12</b> 038748																													
<b>Maintenance handle</b>																																
To actuate the device when the panel door is open																																
																																
	NZM12... N12	<b>+H12UZ</b> 065794	<b>H12UZ</b> 047427																													
<b>Mechanical interlock</b>																																
																																
	NZM12... N12	-	<b>KV-2NZM12</b> 062372																													
	NZM12... N12	-	<b>KVA-2NZM12</b> 078983																													
	NZM12... N12	-	<b>KVA-3NZM12</b> 086102																													
<p>Possible switch positions kVA-3NZM12</p> <table border="0"> <tr> <td>Mains 1</td> <td>Emergency</td> <td>Mains 2</td> <td></td> </tr> <tr> <td>0</td> <td>0</td> <td>0</td> <td></td> </tr> <tr> <td>1</td> <td>V</td> <td>0</td> <td></td> </tr> <tr> <td>1</td> <td>V</td> <td>1</td> <td></td> </tr> <tr> <td>0</td> <td>V</td> <td>1</td> <td></td> </tr> <tr> <td>0</td> <td>0</td> <td>0</td> <td></td> </tr> <tr> <td>V</td> <td>1</td> <td>V</td> <td></td> </tr> </table> <p>0 = Off V = interlocked 1 = On</p>					Mains 1	Emergency	Mains 2		0	0	0		1	V	0		1	V	1		0	V	1		0	0	0		V	1	V	
Mains 1	Emergency	Mains 2																														
0	0	0																														
1	V	0																														
1	V	1																														
0	V	1																														
0	0	0																														
V	1	V																														

Notes:

<sup>1)</sup> Accessories are field installable



# Molded Case Circuit Breakers and Disconnect Switches

## Accessories for NZM12-...

Color of handle	for use with	Type Suffix Article No. when ordered with basic device	Type Article No. when ordered separately <sup>1)</sup>	List Price see price list
-----------------	--------------	---	--	------------------------------

### Rear operation shafts

For side panel mounting where device is only accessible from the rear (e.g. sides of enclosure panels). Must be combined with H...R rear operation handle. Factory installed only. Order with device

NZM12-... N12	<b>+R-NZM12</b> 002968	-		
------------------	---------------------------	---	--	--

### Operating handle for rear operation

Used with rear operation shaft.  
Degree of protection UL/NEMA 3R, 12; IP 55  
Can be locked in the OFF position with up to 3 padlocks (hasp thickness 6 - 8mm).  
No cover/door interlocking provisions.  
3 distinct handle positions: OFF - + (tripped) - ON



gray	NZM12-... N12	<b>+H12-R-NA</b> 005342	<b>H12-R-NA</b> 057178	
black	NZM12-... N12	<b>+H12-R-SW-NA</b> 106019	<b>H12-R-SW-NA</b> 201667	
for Emergency-Stop functions red-yellow	NZM12-... N12	<b>+RH12-R-NA</b> 094950	<b>RH12-R-NA</b> 066670	

### Legend plate (for mounting with operating handle)

Silver-colored



Specify desired text Black lettering; height of letters 3.5, 5 and 7mm	NZM12-... N12	<b>+ZSSOND-NZM12</b> 044153	<b>ZSSOND-NZM12</b> 072103	
Blank for engraving or printing	NZM12-... N12	<b>+ZS60-NZM12</b> 063137	<b>ZS60-NZM12</b> 057794	

### Main disconnect warning plate

Silver-colored, black lettering,  
English inscription:  
"Main Switch - Open only in OFF Position"

English	NZM12-... N12	<b>+ZS62-NZM12</b> 022807	<b>ZS62-NZM12</b> 075008	
French		<b>+ZS63-NZM12</b> 025180	<b>ZS63-NZM12</b> 077381	
For other languages, see below <sup>2)</sup>		<b>+ZS...-NZM12</b> 109314	<b>ZS...-NZM12</b> 109313	

**Notes:** <sup>1)</sup> Accessories shown in this column are field installable

<sup>2)</sup> Engraved main disconnect warning plates are available in the following languages:

61 German	68 Italian	73 Romanian	78 Czech
64 Bulgarian	69 Greek	74 Russian	79 Turkish
65 Danish	70 Norwegian	75 Swedish	80 Hungarian
66 Finnish	71 Polish	76 Serbo-Croatian	81 Afrikaans
67 Dutch	72 Portuguese	77 Spanish	

Insert language key number into type number

**Example:**  
Warning plate in Italian language:  
ZS 68-NZM 12



**Molded Case Circuit Breakers and Switches**  
Accessories for NZM12-...

	<b>Type Suffix</b> Article No. when ordered with basic device	<b>Type</b> Article No. when ordered separately	<b>List Price</b> see price list
<b>Terminal cover</b>			
<p>Provides shock hazard protection in the area of the field wiring power terminals. Can be used at top or bottom, one cover per side. Mandatory requirement on the supply side of main disconnect switches to provide protection against accidental contact with line side feed.</p>			
	+H-NZM12 065510	H-NZM12 083696	
<b>Test unit for NZM12 circuit breakers</b>			
<p>Supply terminal voltage can be selected from 120/220/240V, 50/60Hz. The portable test unit can be used to verify that the long time, instantaneous and short time delayed tripping characteristics of the circuit breaker are operating as per preset values. Various test voltages simulate a short circuit or an overload condition which would cause the circuit breaker to trip out. All measuring and connection leads, as well as operating instructions, are supplied with the unit.</p>			
		PG-NZM 210525	



# Notes

---



# NZM7 Molded Case Circuit Breakers and Switches

## Tripping Characteristics, Let-through Characteristics

### Tripping characteristics, system protection

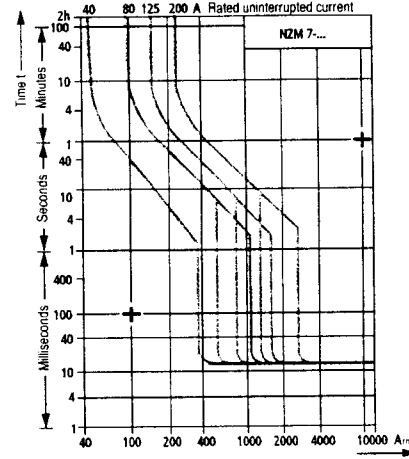
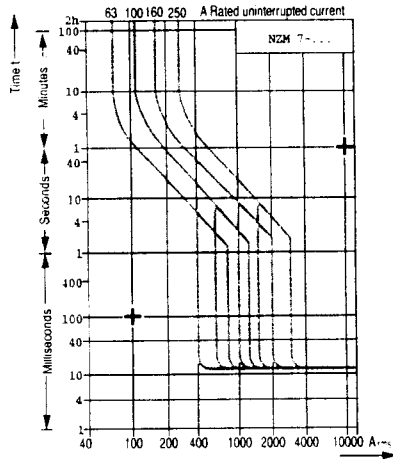

The tripping characteristics show the tripping time of the breakers in relation to the response current.

They show mean values of the tolerance band at an ambient temperature of 20°C, starting from cold.

### Let-through energy I²t

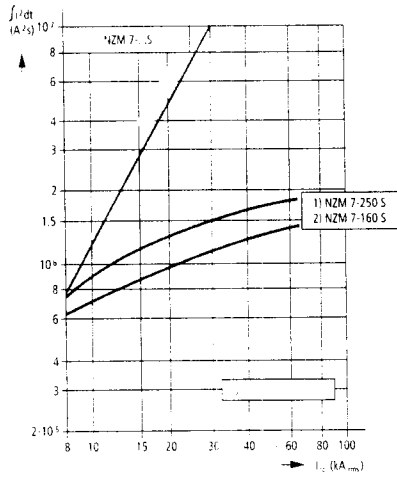

### Let-through current I\_b

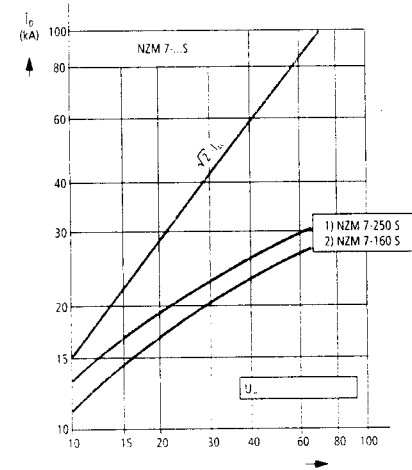

### Let-through energy I²t

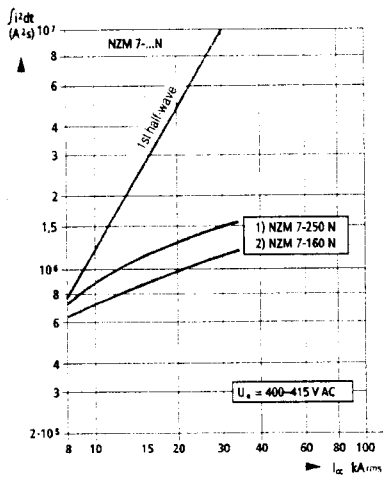

### Let-through current I\_b

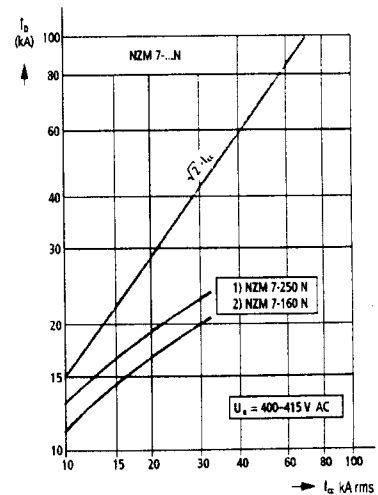

# NZM10 Molded Case Circuit Breakers and Switches

## Tripping Characteristics

Inverse time and instantaneous response

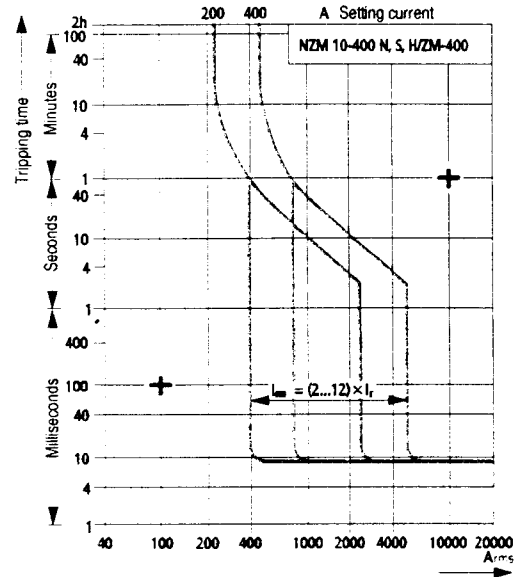
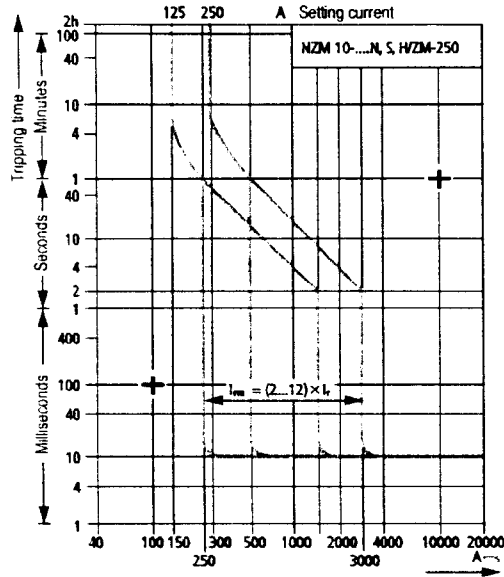

with selectivity settings

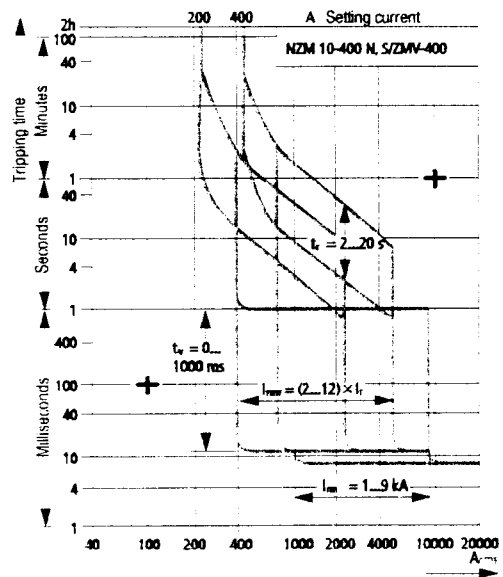
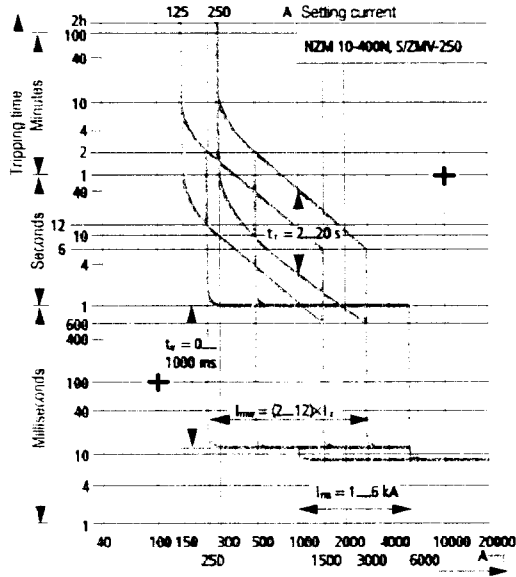

The tripping characteristics show the tripping time of the breakers in relation to the response current

They show mean values of the tolerance band at an ambient temperature of 20°C, starting from cold



**Circuit Breakers, Disconnect Switches, Molded Case Switches**  
**NZM10 Molded Case Circuit Breakers and Switches**  
 Tripping Characteristics, Let-through Characteristics

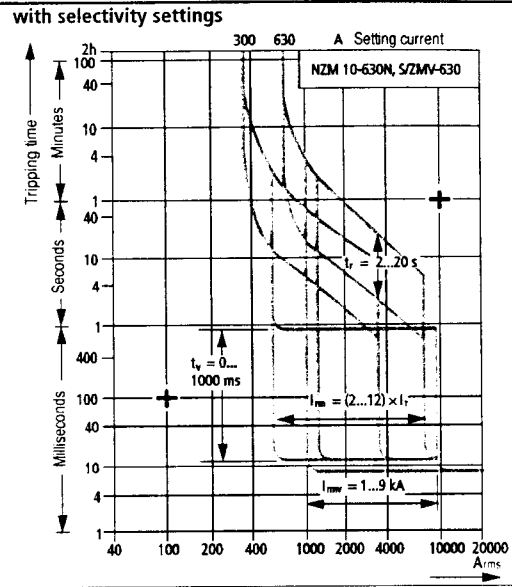
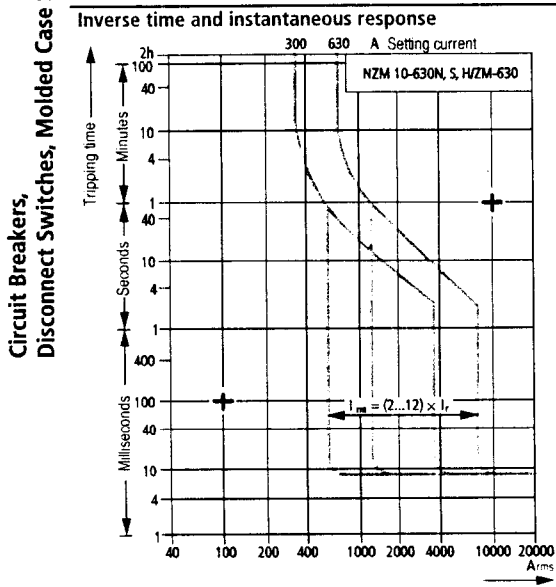

Let-through current  $I_D$

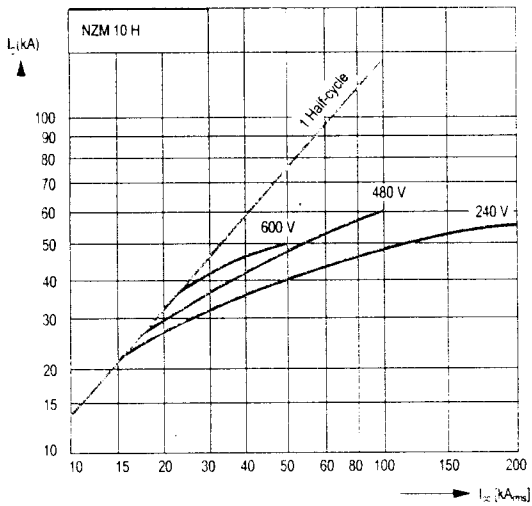

Let-through energy  $I^2t$

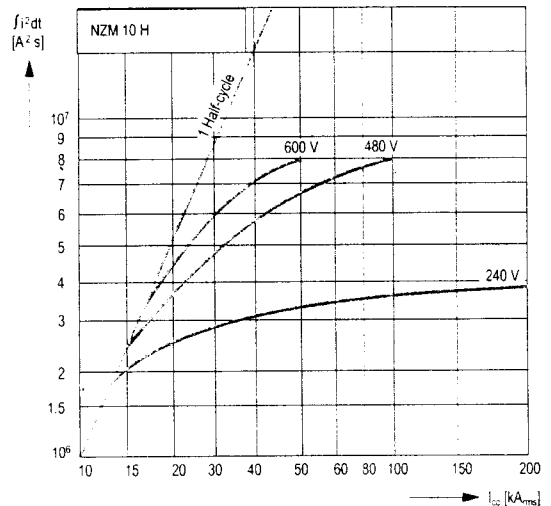

The tripping characteristics show the tripping time of the breakers in relation to the response current.

They show mean values of the tolerance bands at an ambient temperature of 20°C, starting from cold.



# NZM 4, 6, 9, 12 Molded Case Circuit Breakers and Switches

## Tripping Characteristics

### Tripping characteristics

The tripping characteristics show the tripping time of the breakers in relation to the reponse current.

The mean values of the tolerance bands are indicated at an ambient temperature of 20°C, starting from cold.

The tripping time of overload trips at operational temperature reduces to approximately 1/4 of that shown.

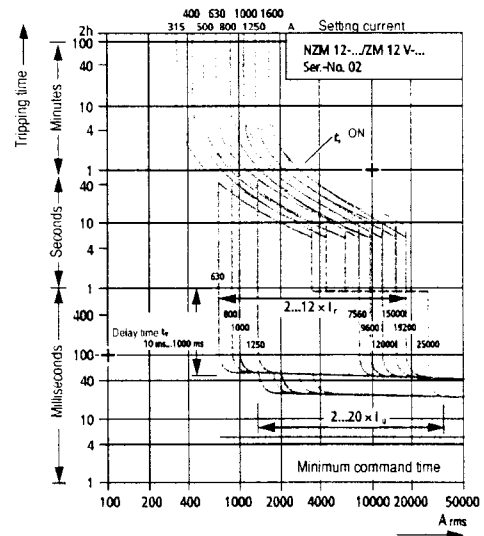
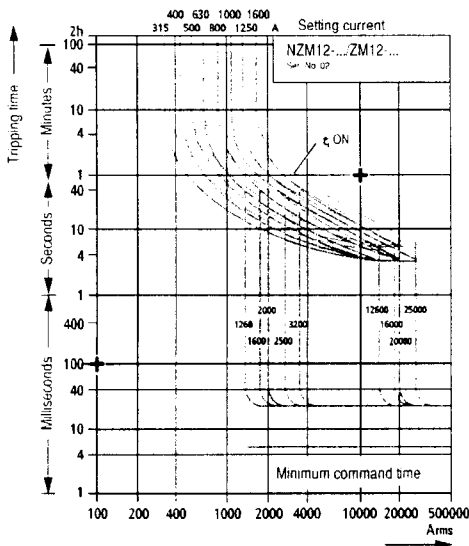
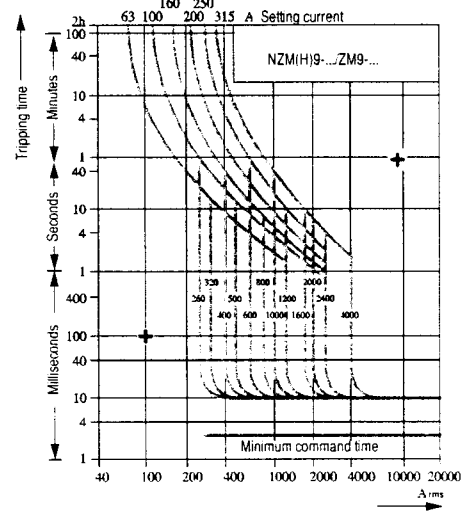
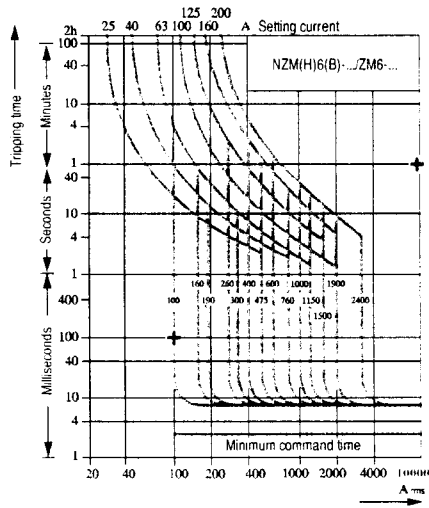
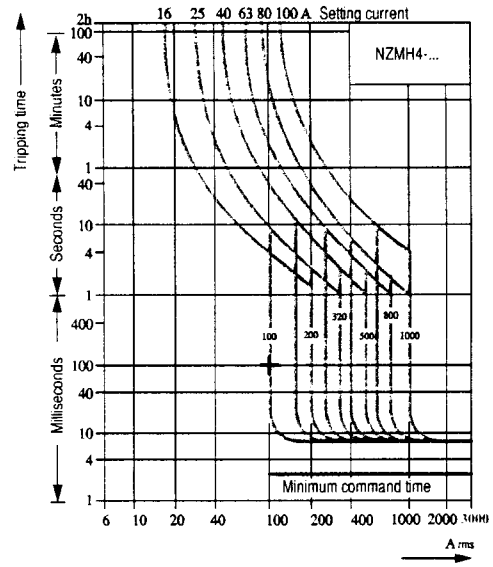

NZMH 4, 6, 9 Molded Case Circuit Breakers and Switches  
Let-through Characteristics

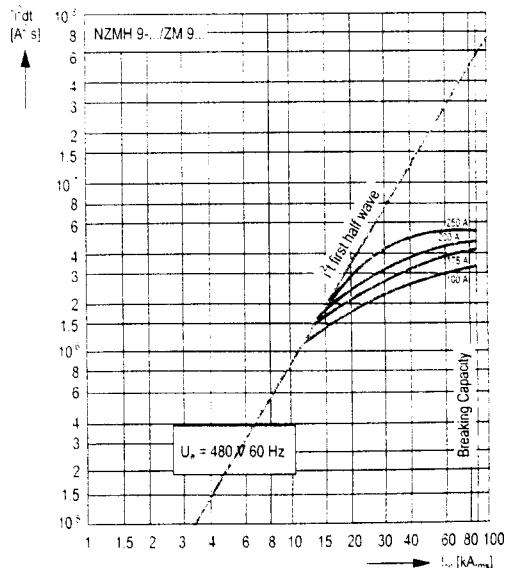
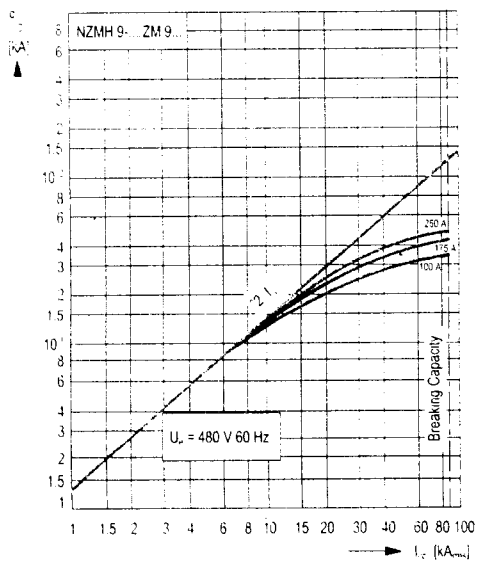
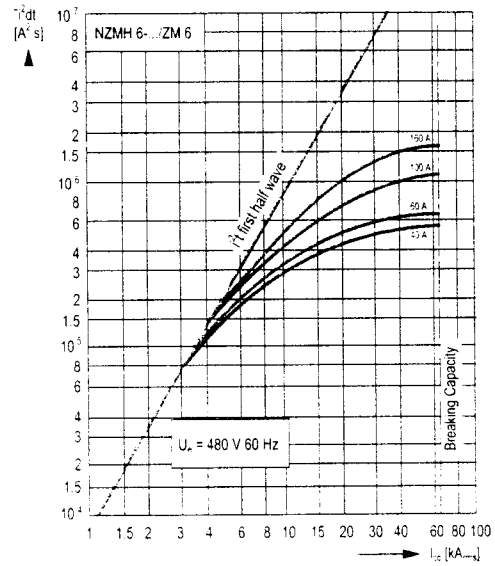
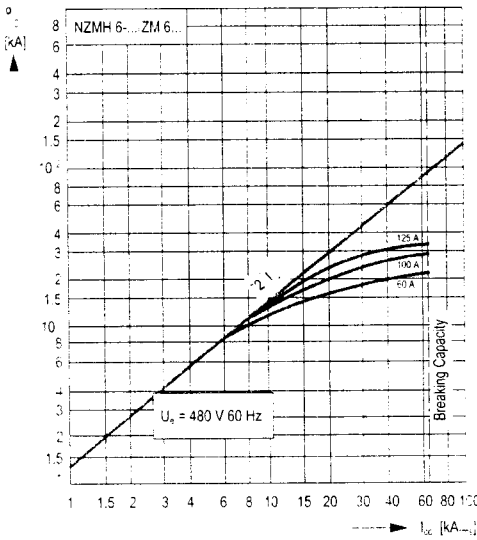
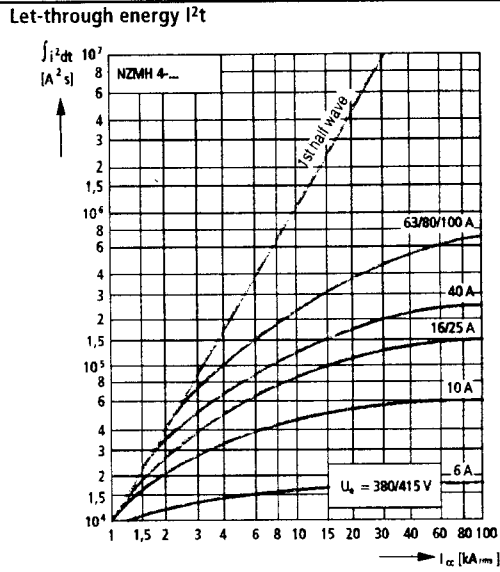
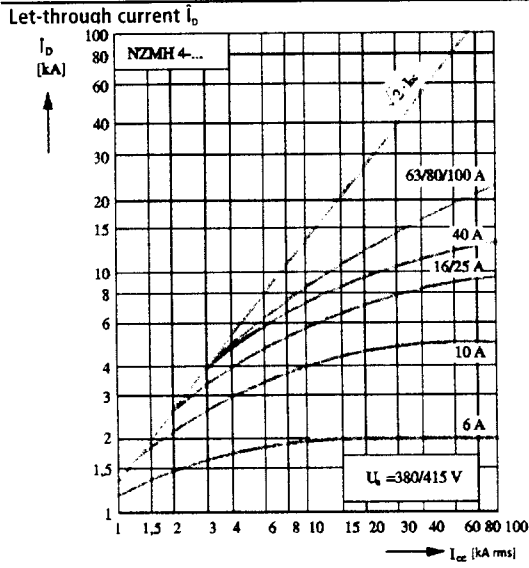



Notes

---



## NZM 7, 10 Molded Case Circuit Breakers

### Technical Data

Molded Case Circuit Breakers			NZM7(A)...N-NA	NZM7(A)...S-NA
Frame Size		A	150	150
<b>IEC 60 947-2 circuit breaker electrical ratings</b>				
Rated impulse withstand voltage $U_{imp}$		V	8000	8000
Rated operational voltage $U_n$ 50/60 Hz		V	690	690
Overvoltage category/pollution degree			III/3	III/3
Short-circuit interrupting ratings				
Rated short-circuit making capacity $I_{cm}$		kA	94.5	220
Rated short-circuit breaking capacity $I_{cn}$				
$I_{cu}$ IEC/EN 60 947 Test cycle O-t-CO				
$I_{cs}$ IEC/EN 60 947 Test cycle O-t-CO-t-CO				
230 V AC	$I_{cu}$	kA	45	100
	$I_{cs}$	kA	45	75
400/415 V AC	$I_{cu}$	kA	35	65
	$I_{cs}$	kA	35	49
440 V AC	$I_{cu}$	kA	25	40
	$I_{cs}$	kA	19	20
500 V AC	$I_{cu}$	kA	12	20
	$I_{cs}$	kA	9	10
690 V AC	$I_{cu}$	kA	6	8
	$I_{cs}$	kA	6	6
<b>UL 489/CSA 5 short circuit interrupting ratings</b>				
240V 60Hz		kA	65	100
480V 60Hz		kA	25	50
600V 60Hz		kA	14	22



# NZM 7, 10 Molded Case Circuit Breakers

## Technical Data

NZM10...N-NA 600	NZM10...S-NA 600	NZM10...H-NA 600
8000	8000	8000
690	690	690
III/3	III/3	III/3
143	220	440
65	100	200
33	50	100
45	65	100
23	33	50
45	55	85
23	28	43
30	42	65
15	21	33
20	25	30
10	13	15
65	100	200
42	65	100
35	42	50

**General technical data**

Standards	UL 489, CSA 22.2 & 5.1 IEC/EN 60 947, VDE 0660
Shock hazard protection	finger and back of hand safe to VDE 0106, part 100
Climatic proofing	Damp heat, constant to IEC 60 068-2-3  Damp heat, cyclical to IEC 60 068-2-30
Ambient temperature min./max. °C	-25/+40 (at 100% loading)
Shock resistance	20g (shock duration 20 ms)
Dimensions	→ page 09/103
Weights	→ page 14/020
Mounting position	90° in any direction

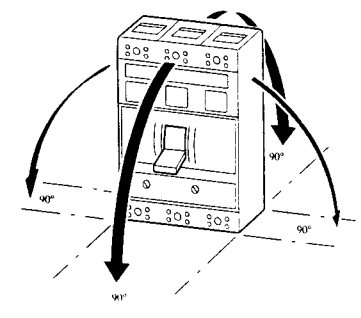

Circuit Breakers, Disconnect Switches, Molded Case Switches



## NZM 7, 10 Molded Case Circuit Breakers

### Technical Data

Molded Case Circuit Breakers		AC = 50/60 Hz		NZM7...		NZM 10...	
Auxiliary contact types				EK...(NHI/RHI)	VHI	NHI/RHI/VHI	
IEC/EN 60 947 electrical ratings							
Rated operational current I <sub>n</sub>							
AC-15	115 V	A	6	4	6		
	230 V	A	6	4	6		
	400 V	A	4	2	3		
	500 V	A	2	1	1.5		
DC-13	24 V	A	6	3	1		
	60 V	A	3	1.5	0.8		
	110 V	A	1	0.5	0.7		
	220 V	A	0.5	0.2	0.3		
Short-circuit protection							
max. fuse, IEC type			A	10	10	6	
max. miniature circuit breaker			A	10	10	6	
Terminal capacity	IEC/EN: 1 or 2 conductors, solid or stranded	mm <sup>2</sup>	0.75 - 2.5	0.75 - 2.5	0.5 - 2.5		
	UL/CSA	AWG	18 - 14	18 - 14	18 - 14		
UL/CSA electrical ratings							
Pilot duty rating		AC/DC		A 600 / P 300	C 300 / Q 300	-	
Current ratings				-	-	10A @ 600 V AC 0.5A @ 125 V DC 0.25A @ 250 V DC <sup>1)</sup>	
Voltage trips, shunt trip							
Operational voltage rating U <sub>s</sub>		V AC	12 - 480		24 - 600		
		V DC	12 - 125		24 - 600		
Operating range (U <sub>s</sub> = rated control voltage)		AC	0.7 - 1.1 x U <sub>s</sub>		0.7 - 1.1 x U <sub>s</sub>		
		DC	0.7 - 1.1 x U <sub>s</sub>		0.85 - 1.1 x U <sub>s</sub>		
Rating	pull-in	AC/DC	VA/W	2/2		5/3	
	sealing	AC/DC	VA/W	-		3/3	
Undervoltage trips							
Operational voltage rating U <sub>s</sub>		V AC	24 - 480		24 - 600		
		V DC	24 - 125		24 - 600		
Operating range	dropout	AC/DC	0.7 - 0.35 x U <sub>s</sub>		0.7 - 0.35 x U <sub>s</sub>		
	pickup	DC/DC	0.85 - 1.1 x U <sub>s</sub>		0.85 - 1.1 x U <sub>s</sub>		
Rating	pull-in	AC/DC	VA/W	2/2		5/3	
	sealing	AC/DC	VA/W	2/2		5/3	
Terminal capacity	IEC/EN: 1 or 2 conductors, solid or stranded	mm <sup>2</sup>	0.75 - 2.5		0.5 - 2.5		
	UL/CSA	AWG	18 - 14		18 - 14		
Remote control drives							
Rated control voltage U <sub>c</sub>		V AC	48 - 240		110 - 415		
		V DC	24 - 240		24 - 240		
Operating range		AC	0.8 - 1.1 x U <sub>s</sub>		0.8 - 1.1 x U <sub>s</sub>		
		DC	0.85 - 1.1 x U <sub>s</sub>		0.85 - 1.1 x U <sub>s</sub>		
Power draw	110/120 V AC	VA	400		240		
	220/240 V AC	VA	400		320		
	380/415 V AC	VA	1000		440		
	24 V DC	W	350		240		
	48/60 V DC	W	400		240		
	100/130 V DC	W	-		240		
	110/120 V DC	W	400		-		
220/240 V DC		W	400		240		
Total closing/opening time			ms	100		60/30	
Mechanical lifespan		operations	ops.	20 000		10 000	
Max. operating frequency			ops./h	20		20	
Terminal capacity	IEC/EN: 1 or 2 conductors, solid or stranded	mm <sup>2</sup>	0.75 - 2.5		0.5 - 2.5		
	UL/CSA	AWG	18 - 14		18 - 14		

Notes: <sup>1)</sup> above 150 V DC, same polarity



# NZM 7, 10 Molded Case Switches

## Technical Data

### UL/CSA Molded case switches

#### IEC/EN Switch-disconnectors

Frame Size	A	NZM 7-...-NA 200	NZM 10-...N/B-NA 600
------------	---	---------------------	-------------------------

#### General technical data

UL 1087 / CSA 22.2 # 5.2 molded case switches	→ page 09/096	→ page 09/096
---	---------------	---------------

#### IEC/EN 60 947-3 switch disconnector ratings

Rated impulse withstand voltage	V	8000	8000
Rated short-time withstand current $I_{cw}$ (1 s current)	kA	3.5	8
Overtoltage category / pollution degree		III/3	III/3
Mechanical lifespan	ops.	20 000	20 000
Maximum operating frequency	ops./h	120	60
Electrical lifespan	AC-1 400V / 690V	ops. 3 000 / 2 000	10 000

### Terminal Capacity

Type		NZM 7(A)-...N-NA Molded case circuit breaker	NZM 7(A)-...S-NA Molded case circuit breaker	NZM 7-...-NA Molded case switch	NZM 10...-NA Molded case circuit breakers and switches
Maximum continuous current	A	150	150	200	
Field wiring terminals					
Conductor cross section		1 conductor AWG 14 ... 250 kcmil CU only	1 conductor AWG 14 ... 250 kcmil CU only	1 conductor AWG 14 ... 250 kcmil CU only	→ page 09/051
Terminal torque rating	Nm	14	14	14	
		NZM 7(A)-...N-NA-M8 Molded case circuit breaker	NZM 7(A)-...S-NA-M8 Molded case circuit breaker	NZM 7-...-NA-M8 Molded case switch	
Bolt-on connection size		M8	M8	M8	

### Let-through Values for UL/CSA Fuseless Current-limiting Circuit Breakers

Type		NZMH6-.../ZM6A-...-NA			NZMH9-.../ZM9A-...-NA			NZM10H-.../ZM10(A)-...-NA		
Max. continuous current	A	125			250			600		
Current limiting values	at	240 V	480 V	600 V	240 V	480 V	600 V	240 V	480 V	600 V
Threshold Current										
RMS sym.	kA	7.5	7.5	7.5	16.25	16.25	16.25	39	39	39
Peak	kA	9	10	10.6	18	21	23	34	42	40
$I^2t \times 10^3$	A <sup>2</sup> s	350	430	468	1500	2000	2204	2800	55000	5500
Intermediate Current										
RMS sym.	kA	50	42	14	100	50	30	125	65	42
Peak	kA	22	26	16	36	38	32	50	52	45
$I^2t \times 10^3$	A <sup>2</sup> s	800	1300	1000	1800	5000	5000	3500	6600	7200
High Interrupting Capacity										
RMS sym.	kA	100	65	25	200	85	42	200	100	50
Peak	kA	30	35	21	42	48	39	55	61	48
$I^2t \times 10^3$	A <sup>2</sup> s	1000	2100	1590	3200	6000	6300	4000	8000	8000



## NZMH4, NZM(H)6(B), NZM(H)9, NZM12

## Technical Data

Molded case circuit breakers	3 pole	NZMH 4-...-CNA <sup>1)</sup>	NZM6B.../ZM6A...-NA	NZMH6-.../ZM6A...-NA	
Frame size	A	80	125	125	
<b>IEC 60 947-2 Electrical Ratings</b>					
Rated impulse withstand voltage $U_{imp}$	V	8000	8000	8000	
Rated operational voltage $U_e$ 50/60 Hz	V	500	690	690	
Rated short-circuit making capacity $I_{cm}$	kA	220	275	275	
Short-circuit interrupting rating $I_{cn}$					
$I_{cu}$ IEC/EN 60 947 test cycle O-t-CO					
$I_{cs}$ IEC/EN 60 947 test cycle O-t-CO-t-CO					
220–240 V 50/60 Hz	$I_{cu}$	kA	100	30	125
		cos $\varphi$	0,2	0,25	0,2
	$I_{cs}$	kA	75	15	95
		cos $\varphi$	0,2	0,3	0,2
380–400/415 V 50/60 Hz	$I_{cu}$	kA	100/65	25/24	100/90
		cos $\varphi$	0,2	0,25	0,2
	$I_{cs}$	kA	50/33	13/12	50/45
		cos $\varphi$	0,25	0,3	0,25
500 V 50/60 Hz	$I_{cu}$	kA	20	10	35
		cos $\varphi$	0,3	0,5	0,25
	$I_{cs}$	kA	10	5	18
		cos $\varphi$	0,5	0,7	0,3
660/690 V 50/60 Hz	$I_{cu}$	kA	–	10	20
		cos $\varphi$	–	0,5	0,3
	$I_{cs}$	kA	–	3	5
		cos $\varphi$	–	0,7	0,7
DC voltage $T \leq 15$ ms					
110 V DC		kA	30	20	30
250 V DC		kA	20	15	20
440 V DC		kA	12	12	12

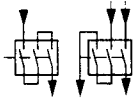

# NZMH4, NZM(H)6(B), NZM(H)9, NZM12

## Technical Data

NZM9-.../ZM9A-...-NA	NZMH9-.../ZM9A-...-NA	NZM12-.../ZM(A)-...-NA <sup>2)</sup>
250	250	1000
8000	8000	-
690	690	-
73	220	-
35	100	100
0,25	0,2	0,2
18	75	50
0,3	0,2	0,2
35	100/90	100/85
0,25	0,2	0,2
18	75/68	25/43
0,3	0,2	0,25
25	65	65
0,25	0,2	0,2
13	33	33
0,3	0,25	0,25
10	28	43
0,5	0,25	0,25
10	14	22
0,5	0,3	0,25
-	-	-
25	35	-
20	30	-
15	25	-

### General technical data

Standards and specifications	UL 489, CSA 22.2 No. 5.1 IEC/EN 60 947-2, VDE 0660
Climatic proofing	Damp heat, constant to IEC 60 068-2-3 Damp heat, cyclical to IEC 60 068-2-30
Ambient temperature, min./max. °C	
open	-25/+55 (lower temperatures on request)
enclosed	-25/+40
Shock resistance	25 g (shock duration 20 ms)
Dimension	→ page 09/109
Weights	→ page 14/020
Mounting position	

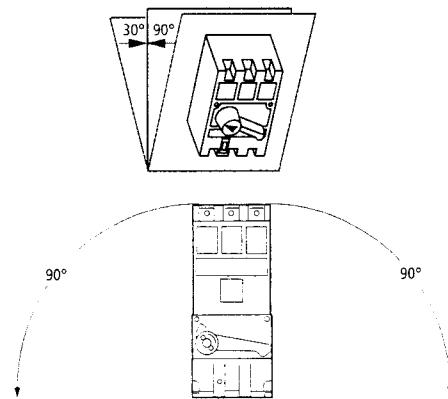

### Notes

- <sup>1)</sup> Type NZMH4-...-CNA thermal magnetic devices (16 - 80 A) are rated as circuit breakers per IEC/EN 60 947-2 only. See page 09/... for more information
- <sup>2)</sup> Type NZM12-...-NA circuit breakers are UL/CSA only. Consult Moeller Electric for IEC/EN rated versions.



## NZMH4, NZM(H)6(B), NZM(H)9, NZM12

## Technical Data

Molded case circuit breakers			NZMH4-.../ CNA <sup>1)</sup>	NZM6B-.../ ZM6A-...- NA	NZMH6-.../ ZM6A-...- NA	NZM9-.../ ZM9A-...- NA	NZMH9-.../ ZM9A-...- NA	NZM12-.../ ZM(A)-...- NA <sup>2)</sup>
Frame size	A		80	125	125	250	250	1000
<b>Overload trips</b>								
Bimetal type (directly heated)	A		4 - 80	15 - 125	15 - 125	63 - 250	63 - 250	–
Solid state type	A		–	–	–	–	–	300 - 1000
Temperature compensation, residual error in the range –25/ +55 °C (reference 20 °C)	%/K		0.3	0.7	0.7	0.3	0.3	–
<b>Undervoltage trips</b>								
Pull-in voltage range	% U <sub>s</sub>		85–110	85–110	85–110	85–110	85–110	85–110
Dropout voltage range	% U <sub>s</sub>		70–35	70–35	70–35	70–35	70–35	70–35
Minimum command time	ms		10–15	10–15	10–15	10–15	10–15	10–15
Inrush rating AC	VA		6.5	6.5	6.5	40	40	100
Sealing AC	VA		3.5	3.5	3.5	7	7	12
Inrush rating DC	W		2.8	2.8	2.8	1.9	1.9	160
Sealing DC	W		2.8	2.8	2.8	1.9	1.9	3.6
<b>Shunt trips</b>								
Pull-in voltage range	% U <sub>s</sub>		70–110	70–110	70–110	70–110	70–110	70–110
Minimum command time	ms		10–15	10–15	10–15	10–15	10–15	10–15
Inrush rating AC (50 Hz)	VA		50	50	50	150	150	350
Sealing AC	VA		–	–	–	15	15	20
Inrush rating DC (intermittent duty operation)	W		40	40	40	120	120	200
<b>Switching times</b>								
Tripping in the event of a short-circuit								
Minimum command time	ms		2	3	3	4	4	4
Opening delay	ms		0.3	0.3	0.3	6	0.3	12
Total opening delay	ms		5	6	6	20	6	25
Opening delay with:								
Shunt trips (100 % of rated coil voltage)	ms		10–20	10–20	10–20	10–20	10–20	15–25
Undervoltage trips	ms		15–20	15–20	15–20	15–20	15–20	20–25
<b>NHI, VHI, AHI, RHI auxiliary contacts <sup>3)</sup></b>								
<b>IEC/EN 60 947 ratings</b>								
Rated operational current I <sub>e</sub>								
AC-15	115 V 50 Hz	A	6	6 (1)	6 (1)	6 (1)	6 (1)	6
	230 V 50 Hz	A	6	6 (1)	6 (1)	6 (1)	6 (1)	6
	400 V 50 Hz	A	4	4 (1)	4 (1)	4 (1)	4 (1)	4
DC-13 (L/R ≤ 200 ms)	24 V DC	A	1	1 (1)	1 (1)	1 (1)	1 (1)	1
	60 V DC	A	0.8	0.8 (0.4)	0.8 (0.4)	0.8 (0.4)	0.8 (0.4)	0.8
	110 V DC	A	0.7	0.7 (0.2)	0.7 (0.2)	0.7 (0.2)	0.7 (0.2)	0.7
	220 V DC	A	0.3	0.3 (0.1)	0.3 (0.1)	0.3 (0.1)	0.3 (0.1)	0.3
Life span, electrical								
to AC-15	ops.		20 000	20 000	20 000	20 000	20 000	20 000
to DC-13	ops.		5 000	5 000	5 000	7 500	7 500	2 500
Short-circuit rating without welding (contacts closed)								
Fuseless			PKZM0-2.5	PKZM0-2.5	PKZM0-2.5	PKZM0-2.5	PKZM0-2.5	PKZM0-2.5
Fuses	A gL		10	10	10	10	10	10
<b>UL/CSA Pilot Duty Ratings</b>								
Type NHI	Pilot Duty		A600/P600	A600/P600	A600/P600	A600/P600	A600/P600	A600
Type VHI, AHI, RHI			C300	C300	C300	C300	C300	A600

**Notes:**

<sup>1)</sup> Type NZMH4-...-CNA thermal-magnetic devices (16 - 80A) are rated as circuit breaker per IEC/EN 60 947-2 only. See page 09/053 for further information

<sup>2)</sup> Type NZM12-...-NA circuit breakers are UL/CSA only. Consult Moeller Electric for IEC/EN rated version.

<sup>3)</sup> For IEC/EN 60 947 ratings, values which appear in brackets apply to VHI, AHI, and RHI contacts. Otherwise values apply to all contacts.





# NZMH4, NZM(H)6(B), NZM(H)9, NZM12

## Technical Data

UL/CSA Motor disconnect switches with adjustable thermal and magnetic trips IEC/EN Molded case circuit breakers	3 pole	NZMH4-...-CNA	NZM(H)6(B)/ZM6-...-CNA	NZM(H)9/ZM9-...-CNA
Frame size	A	80	125	250
<b>Motor disconnect switches with adjustable thermal and magnetic trips</b>				
General technical data		→ page 09/098	→ page 09/098	→ page 09/098
IEC/EN 60 947-2 circuit breaker ratings		→ page 09/098	→ page 09/098	→ page 09/098
UL 508 / CSA 22.2 No. 14 motor disconnect switches				
Adjustable range of thermal overload trips	A	4 - 80	15 - 125	63 - 250
HP ratings	HP	→ page 09/053	→ page 09/062	→ page 09/072
Auxiliary contacts, voltage trips		→ page 09/100	→ page 09/100	→ page 09/100

UL/CSA Motor disconnect switches without adjustable thermal and magnetic trips IEC/EN switch-disconnectors	3 pole	N6-...-CNA	N9-...-CNA	N12-...-CNA
Frame size	A	150	150	1200
<b>Motor disconnect switches without adjustable thermal and magnetic trips</b>				
General technical data		→ page 09/098	→ page 09/098	→ page 09/098
IEC/EN 60 947-3 switch disconnector ratings				
Rated impulse withstand voltage	V	8000	8000	8000
Rated short-time withstand current $I_{cw}$ (1s current)	kA	3	7	20
Lifespan, mechanical				
	ops.	20 000	20 000	20 000
Max. operating frequency	ops./h	60	60	60
Lifespan, electrical				
	AC-1	ops x 10 <sup>3</sup>	10	10
	AC-2, AC-3	ops x 10 <sup>3</sup>	5	5
	DC-2, DC-5	ops x 10 <sup>3</sup>	1	0.5
UL/508 / CSA 22.2 No. 14 motor disconnect switches				
HP ratings		→ page 09/053	→ page 09/062	→ page 09/072
Auxiliary contacts, voltage trips		→ page 09/100	→ page 09/100	→ page 09/100

### Mounting position

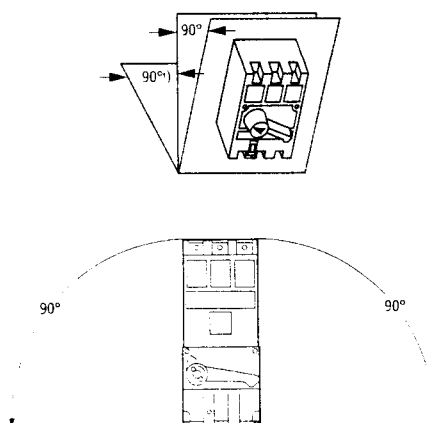

## NZMH4, NZM(H)6(B), NZM(H)9, NZM12

### Technical Data

Type		NZMH4-...-OBI-CNA	NZMH4-...-CNA	NZMH6(B)-.../ZM6(A)-...-(C)NA NZM(H)6(B)-.../ZM6-...-OBI-CNA	NZM(H)6(B)-160/ZM6(A)-125-(C)NA NZM(H)6(B)-160/ZM6-125-OBI-(C)NA
Maximum continuous current	A	18	80	100	125
Field wiring terminals					
Conductor cross section		1 conductor: AWG 14 ... 3 Cu only	1 conductor: AWG 14 ... 3 Cu only	1 conductor: AWG 14 ... 1/0, Cu only up to 90A, 60/75 °C cable 100A, 60 °C cable	1 conductor: AWG 4 ... 3/0, Cu only 125A, 60 °C cable
Terminal torque rating	Nm	4	4	10	10

Type		NZM(H)9-.../ZM9(A)-...-(C)NA NZM(H)9-.../ZM9-...-OBI-CNA	NZM12-.../ZM12(V)(A)-...-NA	
Maximum continuous current	A	250	800	1000
Field wiring terminals				
Conductor cross section		1 conductor: AWG 8 ... Kcmil 300  Cu only	1 conductor: Kcmil 250 - 600 2 conductors: AWG 3/0 ... Kcmil 500 3 conductors: Kcmil 250 ... 400  Cu and Al	4 conductors: AWG 2 ... Kcmil 500  Cu and Al
Terminal torque rating	Nm	40	50	50

Type		N6-...-CNA	N9-...-CNA	N12-...-CNA			
Maximum continuous current	A	100	150	250	800	1000	1200
Field wiring terminals							
Conductor cross section		1 conductor: AWG 14 ... 1/0  Cu only 75 °C cable	1 conductor: AWG 4 ... 3/0  Cu only 75 °C cable	1 conductor: AWG 8 ... Kcmil 300  Cu only	1 conductor: Kcmil 250 - 600 2 conductors: AWG 3/0 ... Kcmil 500 3 conductors: Kcmil 250 - 400 Cu and Al	4 conductors: AWG 2 ... Kcmil 500  Cu and Al	4 conductors: AWG 2 ... Kcmil 500  Cu and Al
Terminal torque rating	Nm	10	15	40	50	50	50



Notes: All devices shown above except type NZM12-... are dual rated UL/CSA and IEC/EN.  
Consult Moeller Electric for IEC/EN conductor cross section information.

**Circuit breakers, molded case switches**

NZM7-...-NA

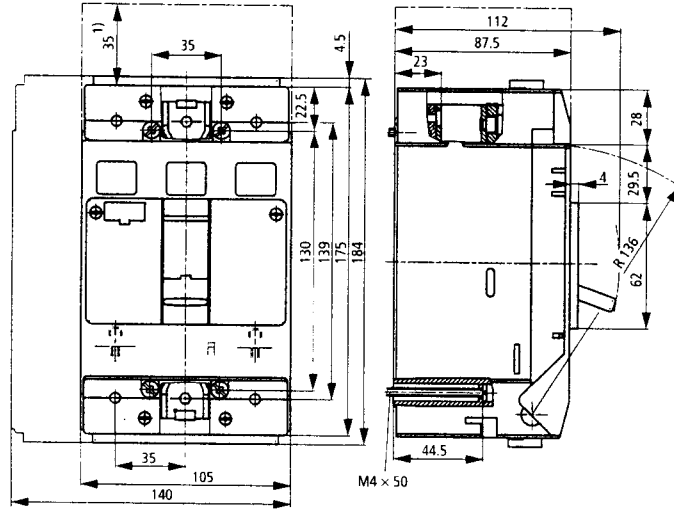

<sup>1)</sup> Required safety clearance to conductive materials with different potential. A lateral clearance of 18mm is required between devices mounted side by side (clearance results automatically when A-, U-, VHI-NZM7 are mounted)

**Shunt trips, undervoltage trips, early make auxiliary contacts**

A-, U-, VHI-NZM7

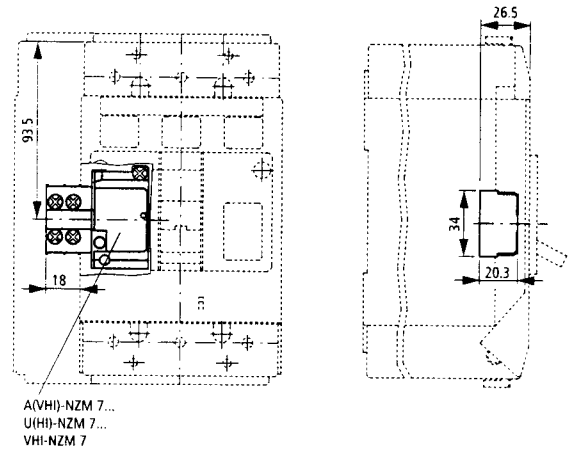

**Insulating frame**

RT-NZM7

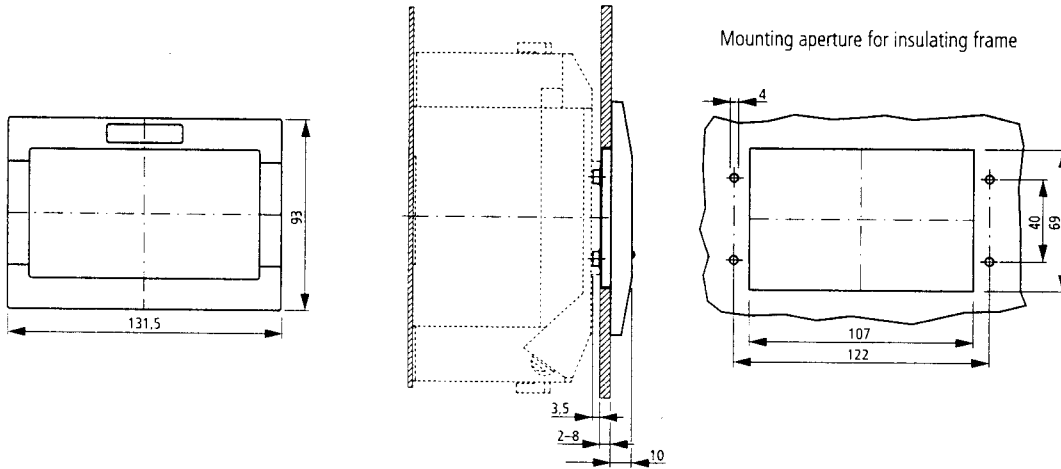

**Rotary drive/rotary handle for open mounted breakers and switches**

DA(OV)-NZM 7 HU-NZM 7

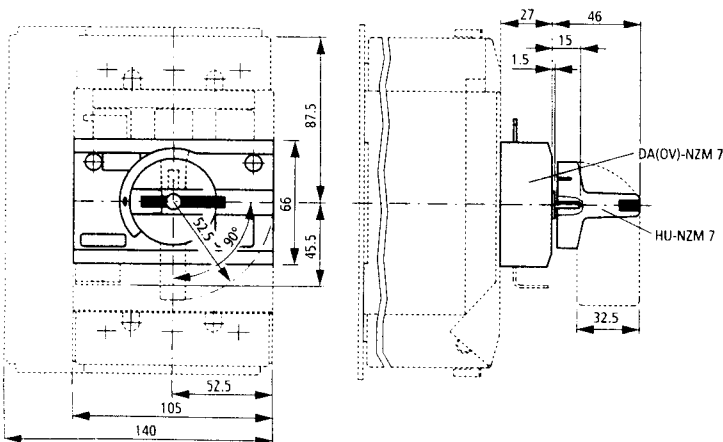

max. 3 padlocks

d = 4 - 8 mm  
 b = min. 34 mm



# Molded Case Circuit Breakers and Switches

## Dimensions for Type NZM7-...

### Extension shaft

<sup>1)</sup> Mounting depth

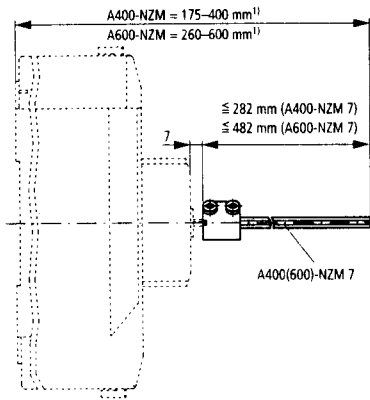

### Clip plate

C-NZM 7

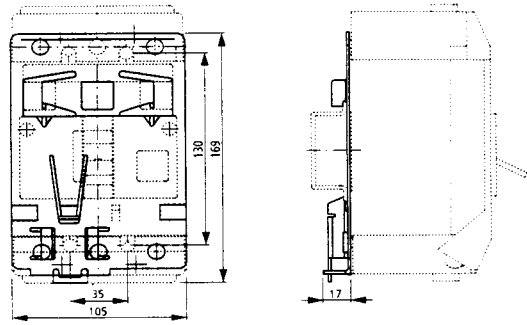

### Door interlocking handle for base mounted breakers and switches

(R)H-NZM 7  
HOV-NZM 7

Mounting opening for door coupling rotary handle

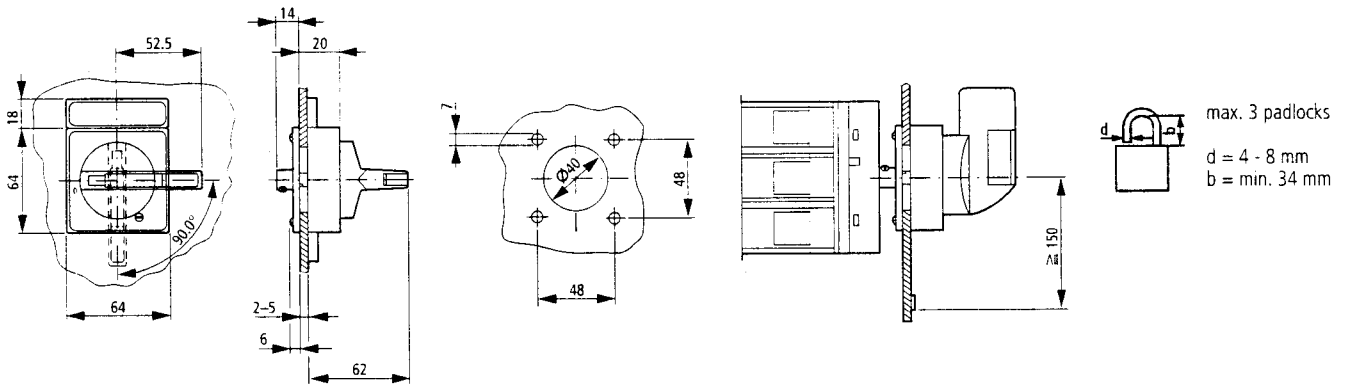

### Paralleling mechanism

K2-P 7

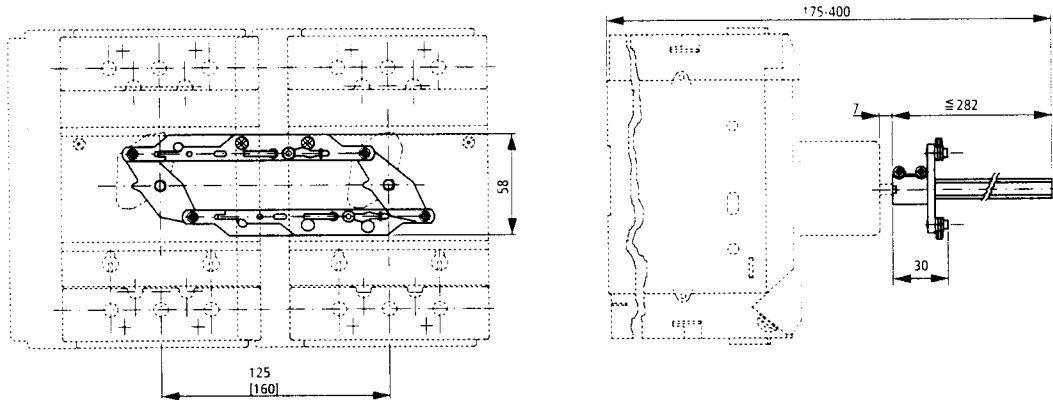

### Mechanical interlock

KV-2 NZM 7

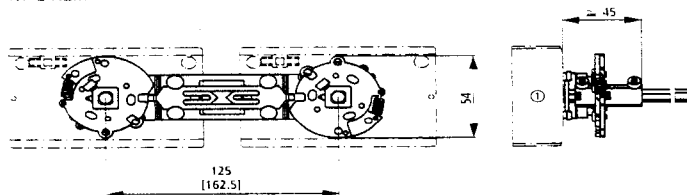

① Rotary drive

# Molded Case Circuit Breakers and Switches

Dimensions for Type NZM7-...

## Remote control drive

R-NZM 7

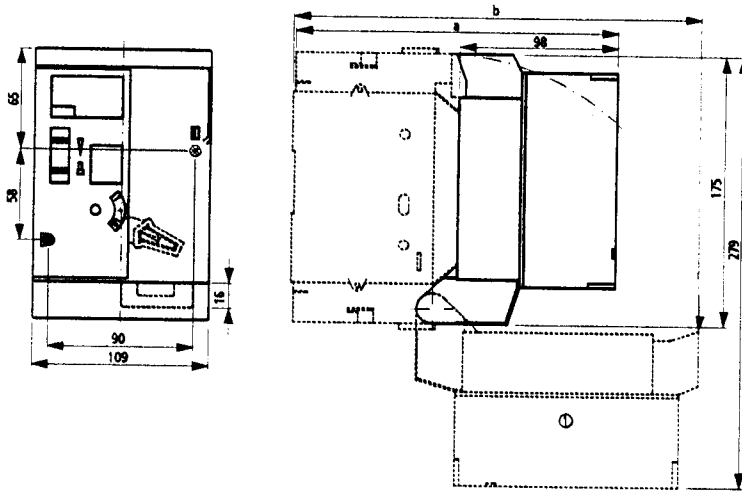

Type	NZM7(A)-...-NA NZM7-...-NA
a	200
b	251

① remote operator tilted

## Cable lug / cable lug cover

KS...-NZM 7

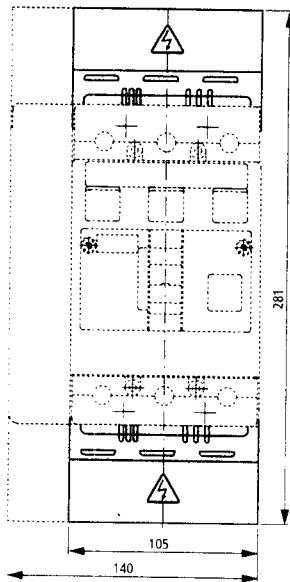

KS 150-NZM 7

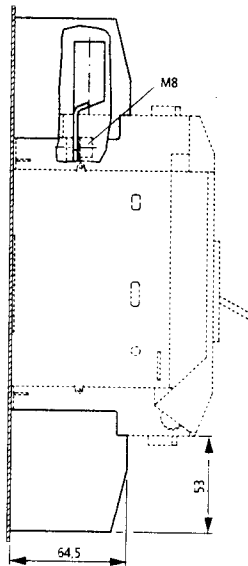

## Side wall operator

SWA-NZM 7 -

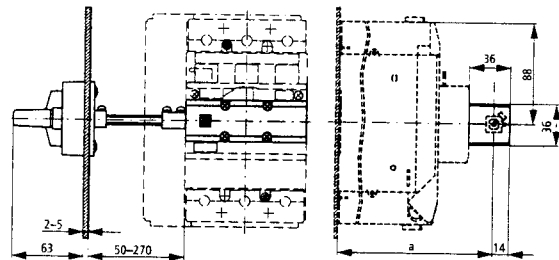

Type	NZM7-...-NA
a	154
b	134

## Mounting bracket for side wall operator

MSWA-NZM 7

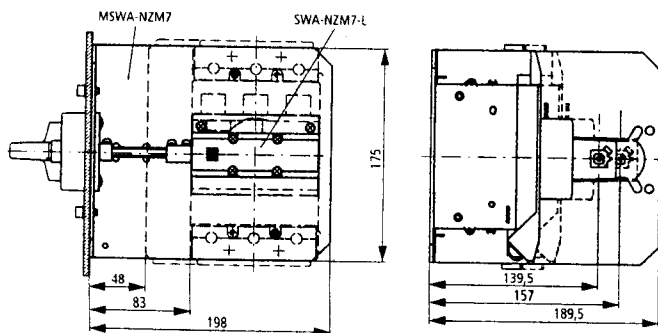

## Mounting aperture for rotary handle

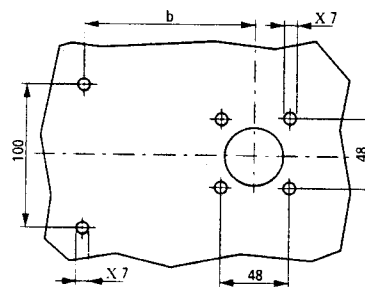

# Molded Case Circuit Breakers and Switches

## Dimensions for Type NZM10-...

### Circuit breakers, molded case switches

NZM10-...-NA

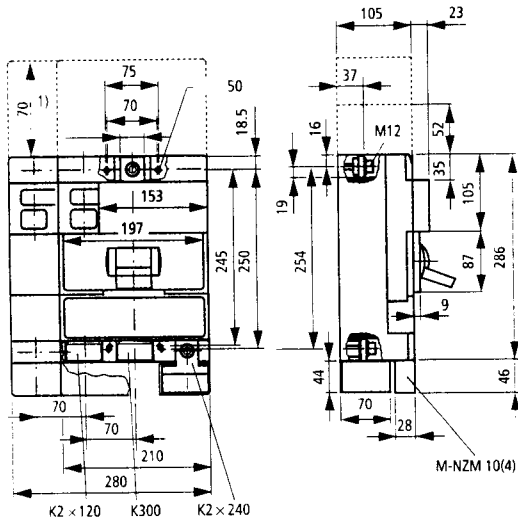

When mounting devices side by side, 15 mm clearance is required between them..

- 1) Safety clearance is required to conductive materials having a different potential; does not apply to connected stripped conductors.

### Rotary drive

D-NZM 10

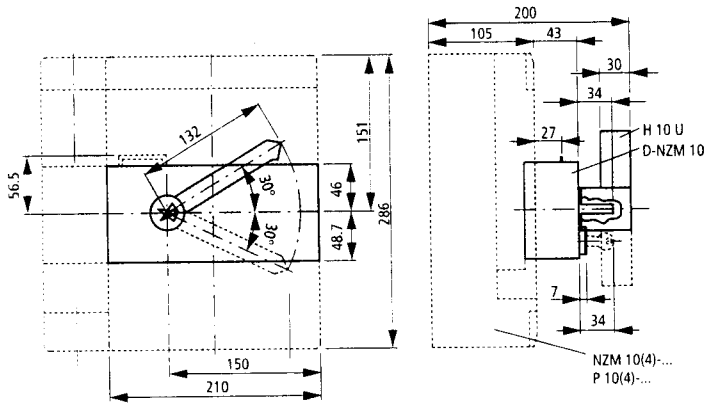

### Door interlocking handle

(R)H10-NA

Drilling template (R)H10-NA

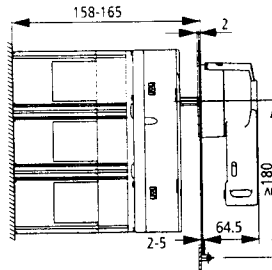
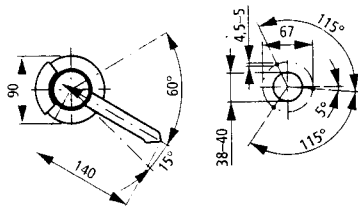

# Molded Case Circuit Breakers and Switches

Dimensions for Type NZM10-...

## Paralleling mechanism

K2-P 10

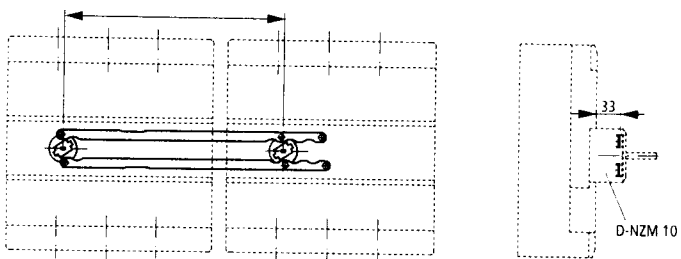

## Remote operator

R-NZM 10

① remote operator tilted

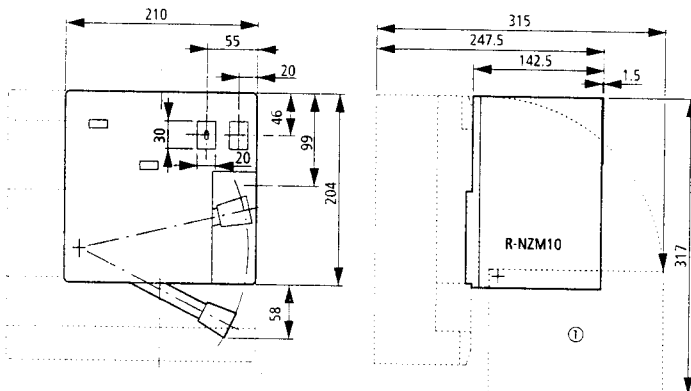

## Pushbuttons for enclosed breakers/switches operated with a remote control drive

MD-NZM 10  
MDV-NZM 10

Mounting opening for pushbuttons

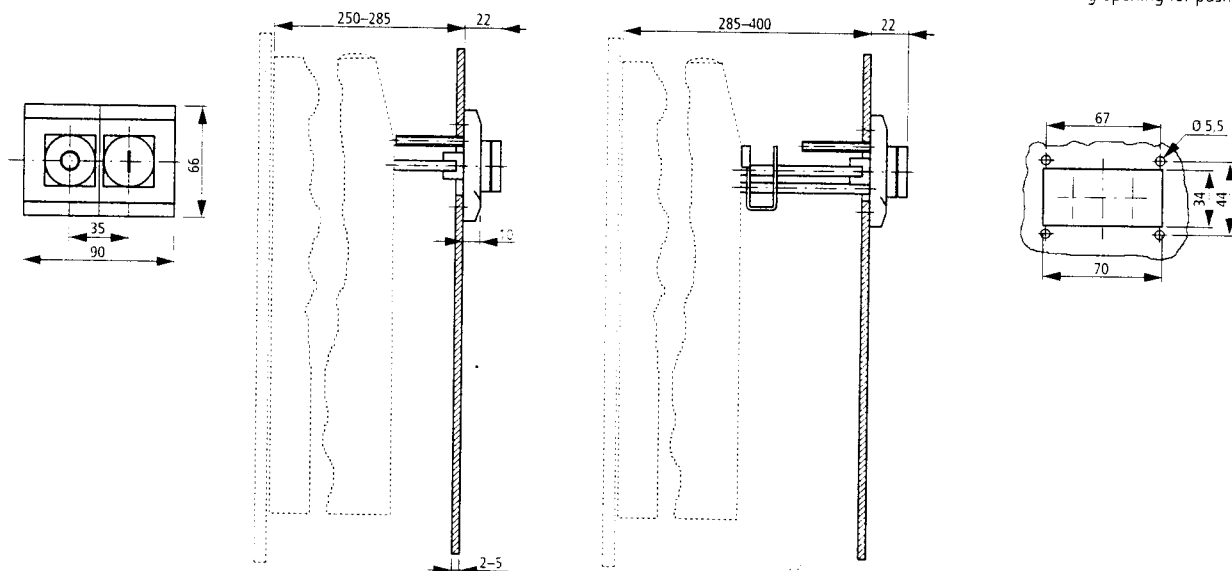





# Molded Case Circuit Breakers and Disconnect Switches

## Dimensions for Type NZM(H) 4, 6, 9 and 12

Circuit-breakers

NZMH4-...-OBI-CNA  
NZMH4-...-CNA

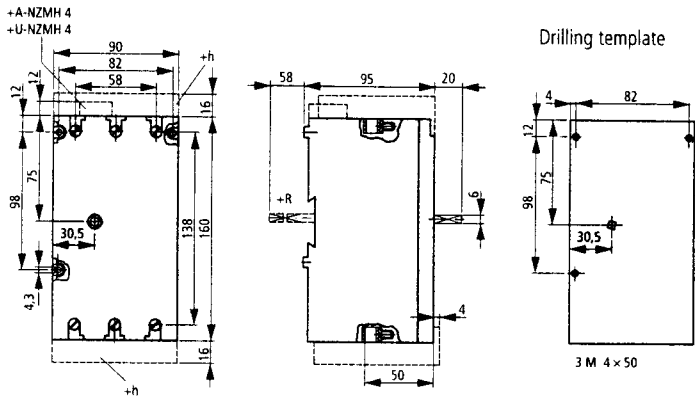

N6-...-CNA  
NZMH6/ZM6(A)-(C)NA  
NZM6B/ZM6(A)-(C)NA  
NZM(H)6(B)/ZM6-OBI-CNA

Type	a	a	b	d	e	f	g	h	k
N6-...-CNA	-	133	109	-	125	92	95	106	7
NZMH6/ZM6(A)-(C)NA	210	-	109	180	-	112	95	126	7
NZM6B/ZM6(A)-(C)NA	210	-	109	180	-	112	95	126	7

1) For connection of copper busbars strip: max. 9 mm wide

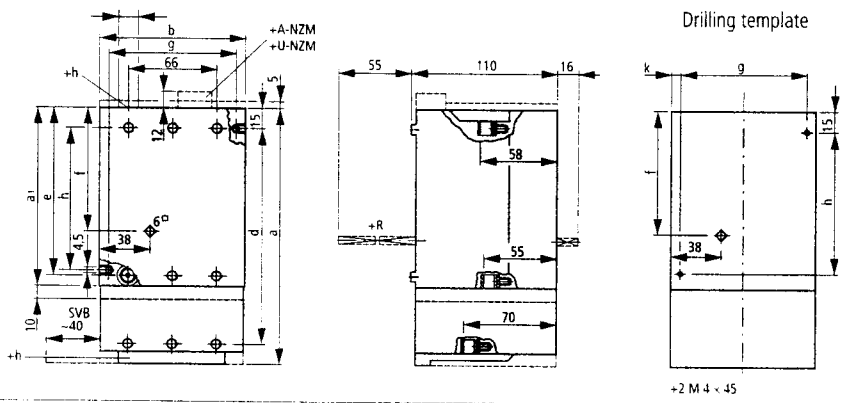

N9-...-CNA  
NZM9/ZM9(A)-...-(C)NA  
NZMH9/ZM9(A)-...-(C)NA  
NZMH9/ZM9-OBI-CNA

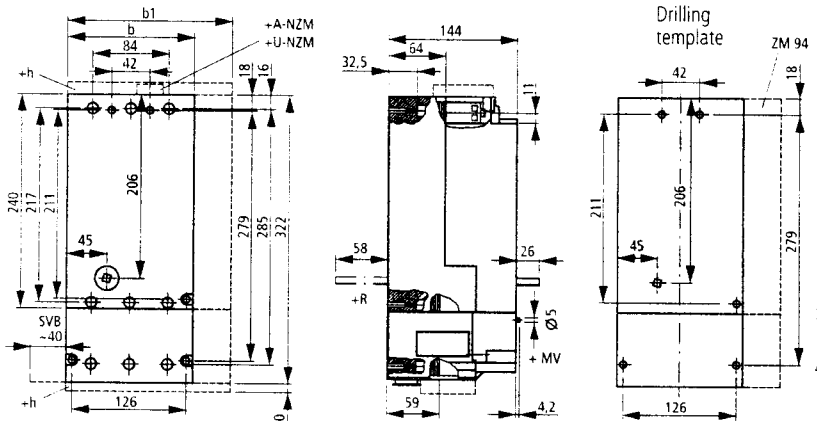

Type	b	b1
N9-...-CNA	140	-
NZM9/ZM9-...-NA	140	-
NZMH9/ZM9-...-NA	140	-

Notes

Safety vertical clearance between upper edge of NZM circuit breakers and conductive materials with a different potential:

Type	Clearance
NZM 4	40
NZM 6	60
NZM 9	100

+R: When switch shaft extended to the rear: provide 20 mm diameter hole in mounting plate for switch shaft.

Front switch shaft is then omitted except for frame sizes 4 and 6.





# Molded Case Circuit Breakers and Disconnect Switches

Dimensions for Type NZM(H) 4, 6, 9 and 12

Standard handle

Door coupling rotary handle

Handle for switch shaft extended to rear



$d = 6 - 8 \text{ mm}$   
 $b = \text{min. } 36 \text{ mm}$

For NZM4

H4U

H6(-NA)

H6R(-NA)

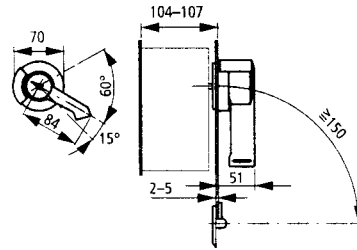
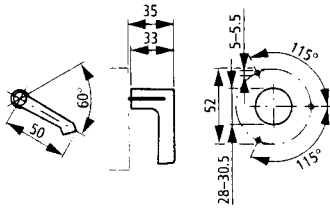

Mounting opening as on left, but turned clockwise through 90°

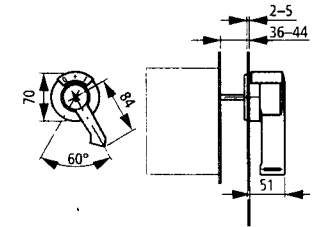

For NZM6

H6U

H6(-NA)

H6R(-NA)

Mounting opening as on left, but turned clockwise through 90°

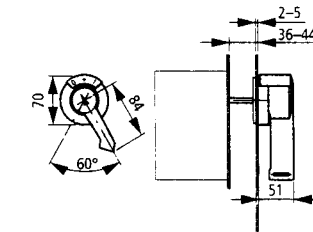
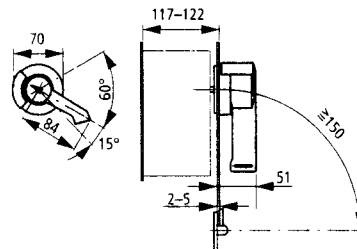
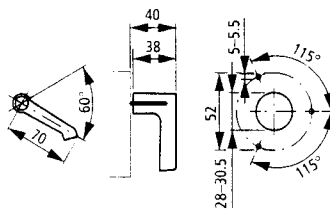

For NZM9

H9U

H9(-NA)

H9R(-NA)

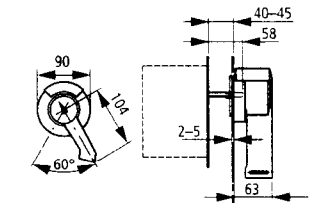
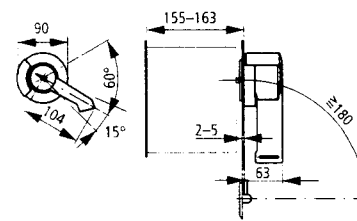
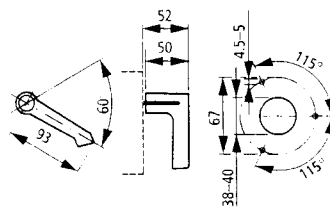

For NZM12

H12U

H12(-NA)

H12R(-NA)

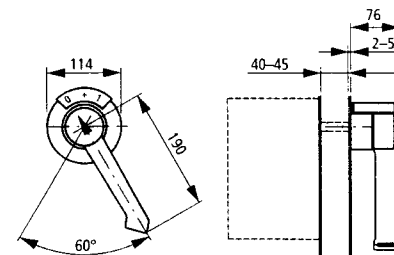
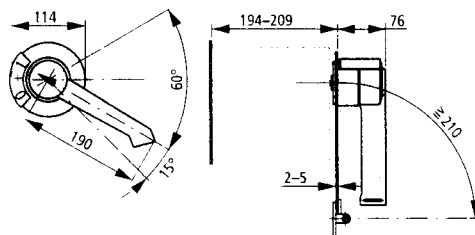
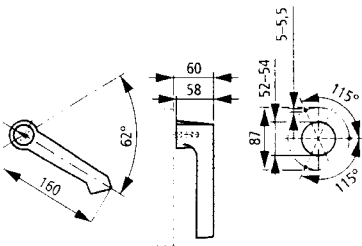

# Molded Case Circuit Breakers and Disconnect Switches

Dimensions for Type NZM(H)4, 6, 9 and 12

## K(V), KU coupling kits

KV-2 N(ZM)

K-2 N  
KU-2 N

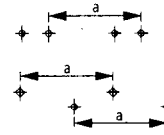
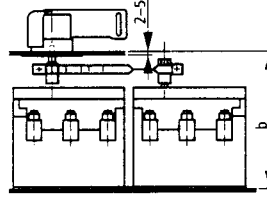
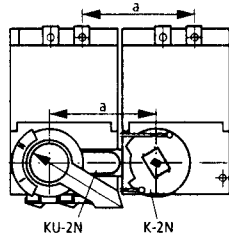
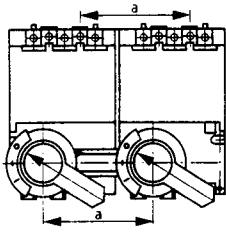

Type	a	b
NZM 4	125	145-185
NZM 6	125	150-190
NZM 9	150	190-240
NZM 12	300	240-300

## M... motor operators

M9

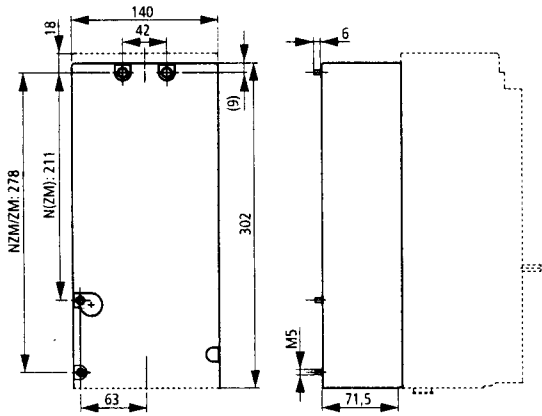

M12 (S)

