

	<b>Page</b>
<b>Technical overview</b>	03/002
<b>System overview</b>	03/004
<b>DIL EM miniature contactors</b>	03/008
Basic devices	03/008
Modules	03/008
<b>DIL contactors</b>	03/010
Basic devices	03/010
Modules	03/010
Complete units	03/014
Reversing contactor combinations	03/018
Contactors for DC loads	03/020
<b>Magnetic starters</b>	03/022
AC magnetic full voltage non-reversing starters	03/024
SYST-M starters	03/026
AC magnetic two-speed starters	03/030
<b>Combination starters</b>	
Self-protected combination starters	03/031
Breaker-type combination starters	03/036
Fusible disconnect switch type	03/038
Non-fusible disconnect switch type	03/041
<b>Combination reversing starters</b>	
Fusible disconnect switch type	03/042
Non-fusible disconnect switch type	03/045
<b>Factory modifications - full voltage starters</b>	03/046
<b>Magnetic reduced voltage starters</b>	03/047
Autotransformer type	03/048
Automatic star-delta type	03/049
Part-winding type	03/050
Factory modifications	03/051
<b>Field modification kits</b>	03/052
<b>Accessories</b>	03/053
<b>Travel diagrams</b>	03/062
<b>Coil voltages</b>	03/064
<b>Selection guide</b>	03/074
<b>Technical data</b>	03/076
<b>Dimensions</b>	03/091





# DIL Contactors

## Technical Overview

UL / CSA / IEC / CE

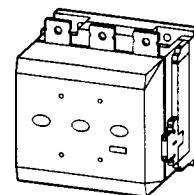
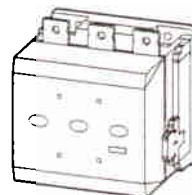
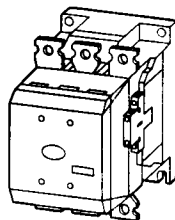
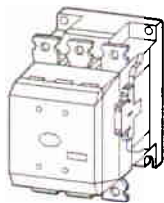
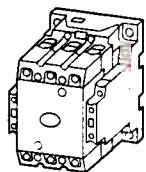
Magnetic Contactors,  
Magnetic Starters

4M 115	M 185	M 225	M 250	M 300	M 400	M 500	M 580	M 650	M 750	M 820
03/013	-	-	-	-	-	-	-	-	-	-
03/016	03/016	03/016	03/016	03/016	03/016	03/016	03/016	03/016	03/016	03/016
HP	HP	HP	HP	HP	HP	HP	HP	HP	HP	HP
10	-	-	-	-	-	-	-	-	-	-
25	-	-	-	-	-	-	-	-	-	-
25	-	-	-	-	-	-	-	-	-	-
40	50	60	75	100	125	150	200	200	250	290
50	60	75	100	125	150	200	200	250	300	350
100	125	150	200	250	300	400	400	500	600	700
125	150	200	250	300	400	500	600	600	700	860
A	A	A	A	A	A	A	A	A	A	A
130	225	250	350	350	450	550	630	700	800	850
.W	kW	kW	kW	kW	kW	kW	kW	kW	kW	kW
37	55	70	75	90	125	155	185	205	240	260
55	90	110	132	160	200	250	315	355	400	450
64	115	142	157	190	255	345	370	420	480	525
75	132	160	180	215	290	360	420	470	550	600
90	175	215	240	286	344	344	560	630	720	750
55	108	108	108	132	132	132	600	600	800	800
26	41	51	62	75	92	112	143	161	181	209
45	75	90	110	132	160	200	250	280	315	355
52	85	102	125	140	186	229	290	326	367	418
55	96	116	143	172	214	260	330	370	417	474
55	127	155	189	229	283	344	440	494	556	633
45	108	108	108	132	132	132	509	509	678	678
58	81	90	108	126	162	199	228	253	289	307
100	140	156	187	218	281	343	393	437	500	531
116	161	180	215	250	323	394	452	502	575	610
132	183	204	245	285	368	449	514	572	655	695
174	244	271	325	380	488	597	684	760	868	923
32	370	411	493	575	740	904	1036	1151	1316	1398
A	A	A	A	A	A	A	A	A	A	A
160	225	250	300	350	450	550	630	700	800	850
160	225	250	300	350	450	550	630	700	800	850

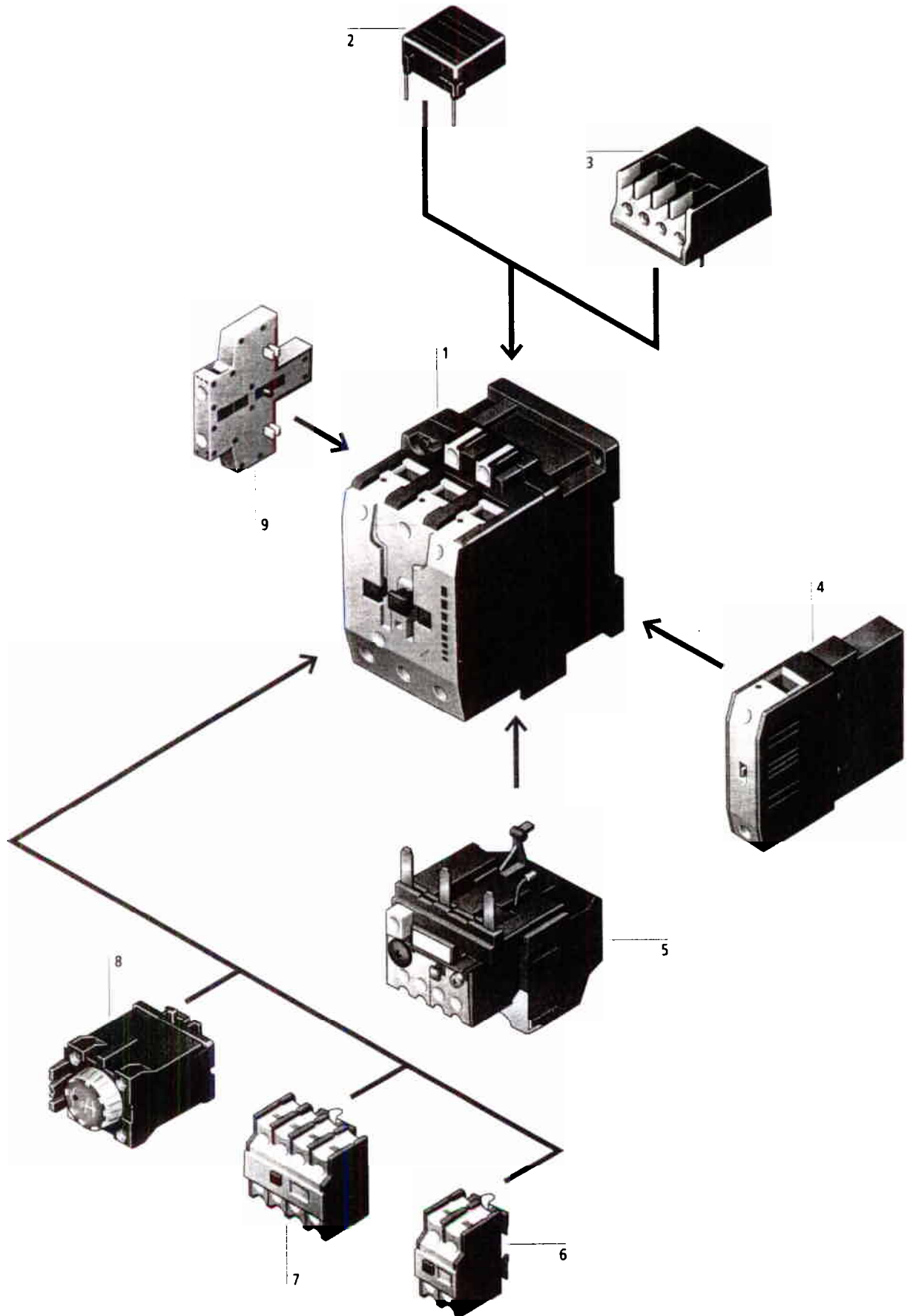

<b>Contactors</b>	1	<b>4th pole</b>	4	<b>Auxiliary contact modules</b>	7
DIL EM - DIL 4M115		Contact for AC-1 load can be mounted to contactors up to DILZAM		4-pole plug-in type	
Magnet systems				Overlapping contacts	
AC: 12 – 600 V, 50, 60, 50/60 Hz					
0,8 – 1,1 × V <sub>r</sub>		→ page 03/057			
DC: 12 – 250 V					
0,85 – 1,1 × V <sub>r</sub>				→ page 03/008	
Coils for non-standard voltages					
"Safe isolation" to IEC 536 between coil and contacts					
→ page 03/008					
<b>Suppressors</b>	2	<b>Overload relays</b>	5	<b>Pneumatic timer modules</b>	8
RC suppressors		For direct mounting		On- and Off-delayed, plug-in type	
Varistor suppressors		For separate mounting			
Free-wheel diode suppressors		Protection of EEx e-motors		→ page 03/057	
		PTB certificate			
→ page 03/053		→ page 04/004			
				<b>Auxiliary contact modules</b>	9
				For side mounting without tools	
				1- or 2-pole	
				→ page 03/012	
<b>Interface modules</b>	3	<b>Auxiliary contact modules</b>	6		
Plug-in type		2-pole, plug-in type			
With and without integral suppressor circuit					
Separate mounting		→ page 03/008			
→ page 03/059					

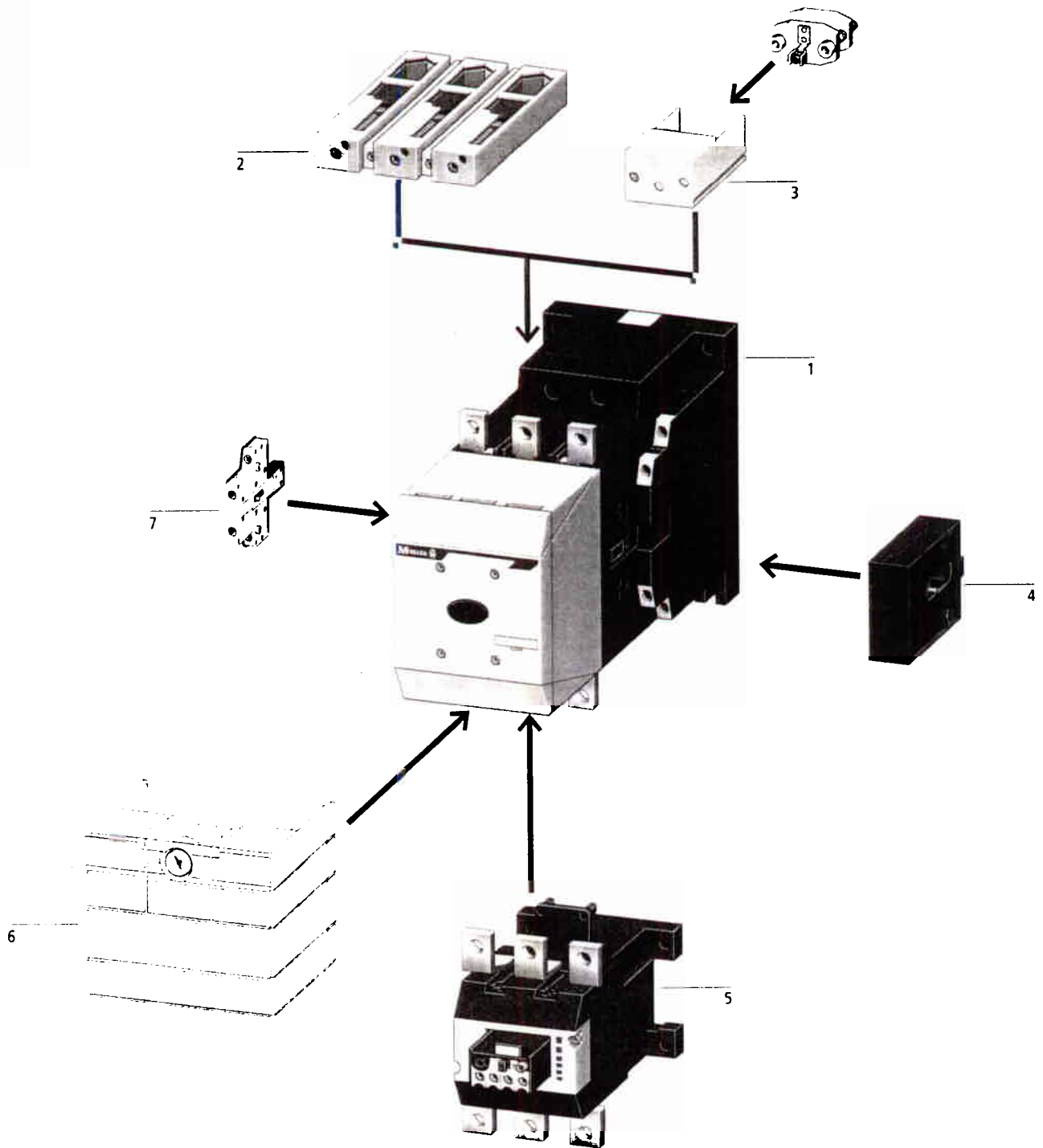

---

**Contactors** 1  
**DILM185 - DILM820**

---

**Multivoltage coils**

- 24 – 48 V DC
- 48 – 110 V AC/DC
- 110 – 250 V AC/DC
- 250 – 500 V AC
- 0,7 – 1,15 × V<sub>r</sub>

**Operating options:**

- directly
- from the PLC
- via a low-consumption contact

**Minimal pick-up and sealing consumption**

---

 → page 03/016
 

---



---

**Cable terminal block** 2
 

---

 1 or 2 conductors per phase
 

---

 Round and flat conductor connectable
 

---

 Finger-safe
 

---

 → page 03/056
 

---



---

**Flat strip conductor terminals** 3
 

---

 1 or 2 strips per phase
 

---

 Control circuit terminal
 

---

 Cover to keep finger safe
 

---

 → page 03/056
 

---



---

**Mechanical interlock** 4
 

---

 → page 03/055
 

---



---

**Overload relay** 5
 

---

 For direct mounting
 

---

 For separate mounting
 

---

 Protection of EEx e motors
 

---

 PTB certificate
 

---

 → page 04/004
 

---



---

**Terminal cover** 6
 

---

 Finger safe
 

---

 → page 03/056
 

---



---

**Auxiliary contact modules** 7
 

---

 2-pole, for side mounting
 

---

 → page 03/016
 

---



**DIL Contactors**  
Basic Devices, Modules

Magnetic Contactors,  
Magnetic Starters

Rating data  
UL/CSA max. Horsepower rating  
50/60 Hz

General purpose  
continuous  
current  
open/  
enclosed

IEC/EN 60 947  
Max. 3-phase  
motor ratings (kW)

Standard  
auxiliary contacts

Terminal  
markings

1 phase			3 phase			
115 V	200 V	230 V	200 V	230 V	460 V	575 V
HP	HP	HP	HP	HP	HP	HP

A

AC-3		
220 V	380 V	660 V
230 V	400 V	690 V
kW	kW	kW

N.O. = normally open  
N.C. = normally closed

N.O.    N.C.

Circuit diagram

**Basic devices**

3-pole,  
with auxiliary  
contacts



1/2	1	1 1/2	2	3	5	5
1/2	1	1 1/2	2	3	5	5

15/13.5

2.2	4	4	1	-
2.2	4	4	-	1

1    -

-    1

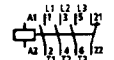

4-pole

1/2	1	1 1/2	2	3	5	5
-----	---	-------	---	---	---	---

2.2	4	4	-	-
-----	---	---	---	---

-    -

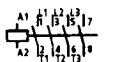

**Auxiliary contact  
modules**

2-pole



1/2	1	1 1/2	2	3	5	5
-----	---	-------	---	---	---	---

10

-    2

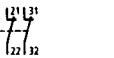

1    1

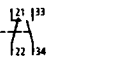

2    2

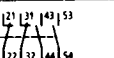

4-pole

1/2	1	1 1/2	2	3	5	5
-----	---	-------	---	---	---	---

10

-    2

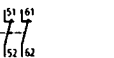

1    1

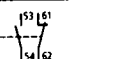

2    -

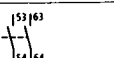

1 1)    1 1)

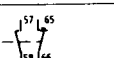

2-pole

1/2	1	1 1/2	2	3	5	5
-----	---	-------	---	---	---	---

10

-    4

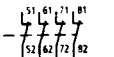

1    3

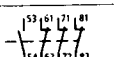

2    2

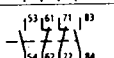

3    1

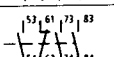

4    -

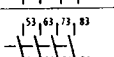

2 1)    2 1)

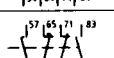

Notes:

1) 1 early-make contact, 1 late-break contact



# DIL Contactors

## Basic Devices, Modules

UL / CSA / IEC / CE

AC operated		DC operated	
Type	List Price	Type	List Price
Article No.	see price list	Article No.	see price list
Coil voltages shown in (...) For other coil voltages, → page 03/064		Coil voltages shown in (...) For other coil voltages, → page 03/064	
● -	<b>DILEM-10(120V60HZ)</b> 051783	<b>DILEM-10-G(24VDC)</b> 010213	
- ●	<b>DILEM-01(120V60HZ)</b> 051792	<b>DILEM-01-G(24VDC)</b> 010343	
● -	<b>DILEM-4(120V60HZ)</b> 051801	<b>DILEM4-G(24VDC)</b> 012701	
● -	<b>02DILEM</b> 010064	<b>02DILEM</b> 010064	
● -	<b>11DILEM</b> 010080	<b>11DILEM</b> 010080	
● -	<b>22DILEM</b> 010112	<b>22DILEM</b> 010112	
● ●	<b>02DILE</b> 010240	<b>02DILE</b> 010240	
● ●	<b>11DILE</b> 010224	<b>11DILE</b> 010224	
● ●	<b>20DILE</b> 010208	<b>20DILE</b> 010208	
● ●	<b>11DDILE</b> <sup>1)</sup> 049824	<b>11DDILE</b> <sup>1)</sup> 049824	
● ●	<b>04DILE</b> 010256	<b>04DILE</b> 010256	
● ●	<b>13DILE</b> 002397	<b>13DILE</b> 002397	
● ●	<b>22DILE</b> 010288	<b>22DILE</b> 010288	
● ●	<b>31DILE</b> 048912	<b>31DILE</b> 048912	
● ●	<b>40DILE</b> 010304	<b>40DILE</b> 010304	
● ●	<b>22DDILE</b> <sup>1)</sup> 049823	<b>22DDILE</b> <sup>1)</sup> 049823	

## Notes:

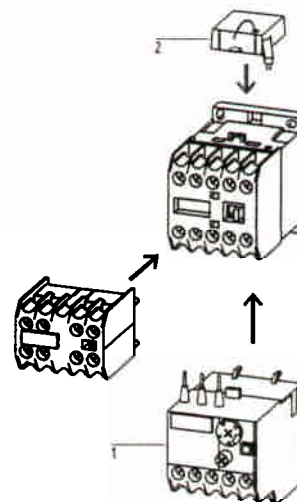

Accessories	Page
1 Overload relay	04/004
2 Suppressor	03/053
Other operating voltages	03/064
Accessories	03/053

Miniature contactors with positively driven contacts. Not in the case of early-make or late-break contacts.

The DC operated contactors are supplied as standard with a diode/resistor combination surge suppressor.

Coil power consumption: 2,6 W

Contactors contacts to EN 50 012  
Auxiliary contact module contact:  
...DIL EM to EN 50 012  
...DIL E to EN 50 005  
Contacts to EN 50 012 should be given preference.

Magnetic Contactors,  
Magnetic Starters



**DIL Contactors**  
Basic Devices, Modules

Magnetic Contactors,  
Magnetic Starters

Rating data  
UL/CSA max. Horsepower rating  
50/60 Hz

1 phase		
115 V	200 V	230 V
HP	HP	HP

General purpose continuous current open/enclosed  
A

IEC/EN 60 947 Max. 3-phase motor ratings (kW) AC-3		
220 V	380 V	660 V
230 V	400 V	690 V
kW	kW	kW <sup>1)</sup>

Standard auxiliary contacts  
N.O. = normally open  
N.C. = normally closed  
N.O. N.C.

Terminal markings

Circuit diagram

**Basic devices**

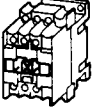
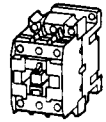
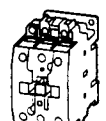
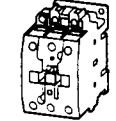
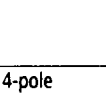
3-pole	1/2	1	1 1/2
	1	2	2
	2	2	3
	2	3	5
	3	5	5
	3	5	7 1/2
	3	7 1/2	10
	5	10	15
4-pole	1/2	1	1 1/2

20/18	2,2	4	5,5	-	-
20/18	3	5,5	7,5	-	-
35/31	4	7,5	11	-	-
35/31	5,5	11	15	-	-
55/50	7,5	15	18,5	-	-
55/50	11	18,5	22	-	-
90/81	15	22	30	-	-
90/81	18,5	30	37	-	-
20/18	2,2	4	5,5	-	-

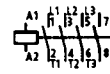

**Auxiliary contact modules**

Side mounting

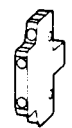

Top mounting

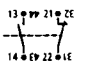
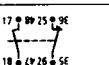
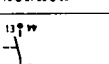
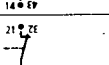
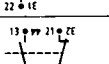
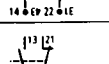
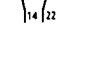
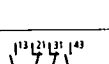
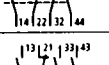

10				1	1	
10				1 <sup>2)</sup>	1 <sup>2)</sup>	
15				1	-	
				-	1	
				1	1	
				1	1	
				2	2	
				3	1	
				2 <sup>2)</sup>	2 <sup>2)</sup>	

Notes  
<sup>1)</sup> Do not reverse directly  
<sup>2)</sup> 1 early-make contact, 1 late-break contact  
<sup>3)</sup> Do not combine a DIL0(A)M-G with a DILM820-XHI...

**DIL Contactors**  
Basic Devices, Modules

UL / CSA / IEC / CE

AC operation			DC operation	
Combination options				
Type	List Price	Type	List Price	
Article No.	see price list	Article No.	see price list	
Coil voltages shown in (...) For other coil voltages, → page 03/065		Coil voltages shown in (...) For other coil voltages, → page 03/065		
● -	<b>DIL00M(120V60HZ)</b> 060477	<b>DIL00M-G(24VDC)</b> 048587		
● -	<b>DIL00AM(120V60HZ)</b> 061222	<b>DIL00AM-G(24VDC)</b> 048567		
- ● <sup>3)</sup>	<b>DIL0M(120V60HZ)</b> 061254	<b>DIL0M-G(24VDC)<sup>3)</sup></b> 048597		
- ● <sup>3)</sup>	<b>DIL0AM(120V60HZ)</b> 061262	<b>DIL0AM-G(24VDC)<sup>3)</sup></b> 048592		
- ●	<b>DIL1M(120V60HZ)</b> 061270	<b>DIL1M-G(24VDC)</b> 048605		
- ●	<b>DIL1AM(120V60HZ)</b> 061427	<b>DIL1AM-G(24VDC)</b> 048602		
- ●	<b>DIL2M(120V60HZ)</b> 046563	<b>DIL2M-G(24VDC)</b> 048615		
- ●	<b>DIL2AM(120V60HZ)</b> 046571	<b>DIL2AM-G(24VDC)</b> 048610		
● -	<b>DIL00M4(120V60HZ)</b> 046926	<b>DIL00M4-G(24VDC)</b> 063171		
- ●	<b>DILM820-XHI11-SI</b> 208281	<b>DILM820-XHI11-SI</b> 208281		
- ●	<b>DILM820-XHI11V-SI<sup>2)</sup></b> 208283	<b>DILM820-XHI11V-SI<sup>2)</sup></b> 208283		
- ●	<b>10SDILM</b> 089080	<b>10SDILM</b> 089080		
- ●	<b>01SDILM</b> 001930	<b>01SDILM</b> 001930		
- ●	<b>11SDILM</b> 024626	<b>11SDILM</b> 024626		
● ●	<b>11DILM</b> 017507	<b>11DILM</b> 017507		
● ●	<b>22DILM</b> 019880	<b>22DILM</b> 019880		
● ●	<b>31DILM</b> 022253	<b>31DILM</b> 022253		
● ●	<b>22DDILM<sup>2)</sup></b> 026999	<b>22DDILM<sup>2)</sup></b> 026999		

Notes

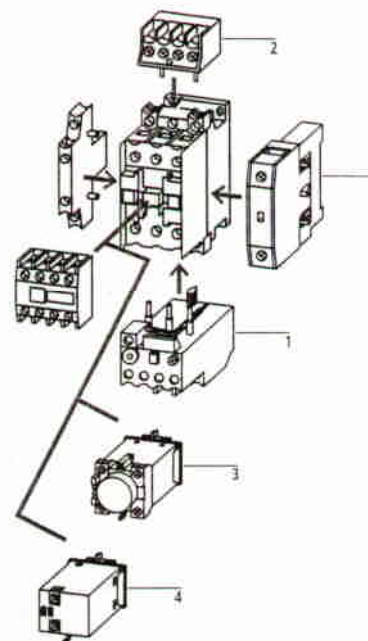

Accessories Page

1 Overload relay	04/004
2 Interface module or suppressor module	03/059 03/053
3 Pneumatic timer module	03/057
4 Mechanical latching module	03/057
5 Additional 4th pole (DIL0M(-G) to DIL2AM(-G))	03/057
Additional auxiliary contact modules	02/010
Accessories	03/053
Other operating voltages	03/065 03/066

DILM820-XHI... auxiliary contacts cannot be combined with auxiliary contact module ...SDILM

Auxiliary contacts for side mounting can be combined with auxiliary contacts for top mounting up to a maximum of 5 contacts.

Maximum of one side-mounting auxiliary contact module on either side.

Magnetic Contactors,  
Magnetic Starters



# DIL Contactors

## Basic Devices, Modules

Magnetic Contactors,  
Magnetic Starters

**Rating data**

UL/CSA max. Horsepower rating  
50/60 Hz

General  
purpose  
continuous  
current  
open/  
enclosed  
A

IEC/EN 60 947  
Max. 3-phase  
motor ratings (kW)  
AC-3  
220 V 380 V 660 V 1000 V  
230 V 400 V 690 V  
kW kW kW kW

Standard  
auxiliary contacts  
N.O. = normally open  
N.C. = normally closed

Terminal  
markings

N.O. N.C.

Circuit diagram

**Basic devices**

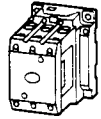

1 phase			3 phase			
115 V	200 V	230 V	200 V	230 V	460 V	575 V
HP	HP	HP	HP	HP	HP	HP
7 1/2	15	15	25	30	60	75

100/90	22	37	55	37

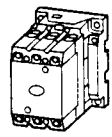
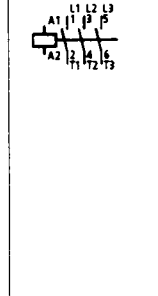

10	25	25	40	50	100	125
----	----	----	----	----	-----	-----

160/144	37	55	90	55
---------	----	----	----	----

**Auxiliary contact modules**



Side mounting



16						
----	--	--	--	--	--	--

	1	1		
	1 <sup>1)</sup>	1 <sup>1)</sup>		
	1	1		

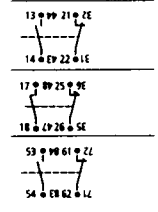

**Notes**

<sup>1)</sup> 1 early-make contact, 1 late-break contact

# DIL Contactors

## Basic Devices, Modules

UL / CSA / IEC / CE

AC operation		DC operation	
Type Article No.	List Price see price list	Type Article No.	List Price see price list
Coil voltages shown in (...) For other coil voltages, → page 03/066		Coil voltages shown in (...) For other coil voltages, → page 03/066	
● DIL3M80(120V60HZ) 209691		DIL3M80(24VDC) 209709	
● DIL4M115(120V60HZ) 209750		DIL4M115(24VDC) 209765	
● DILM820-XHI11-SI 208281		DILM820-XHI11-SI 208281	
● DILM820-XHI11V-SI <sup>1)</sup> 208283		DILM820-XHI11V-SI <sup>1)</sup> 208283	
● DILM820-XHI11-SA 208282		DILM820-XHI11-SA 208282	

**Notes**

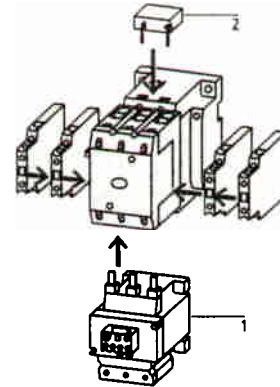

Accessories	Page
1 Overload relay	04/004
2 Suppressor	03/053
Accessories	03/053

Auxiliary contact mounting options:

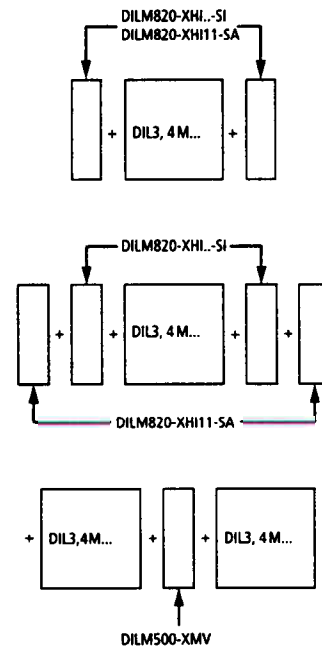

The contactors can be snap-mounted onto a 75mm top-hat rail to EN 50 023.  
 DC operated contactors are supplied as standard with a varistor surge suppressor.  
 Up to 8 auxiliary contacts possible, but only up to 4 N.C. contacts or 4 N.O. contacts.  
 No auxiliary contacts can be mounted between the mechanical interlock and the contactor

Magnetic Contactors  
Magnetic Starters



# DIL Contactors

Units complete with auxiliary contacts

Magnetic Contactors,  
Magnetic Starters

**Rating data**

UL/CSA max. Horsepower rating  
50/60 Hz

General purpose  
continuous  
current  
open/ enclosed











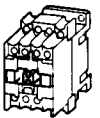

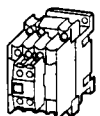

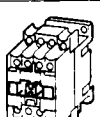
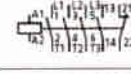
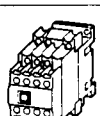
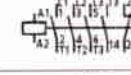
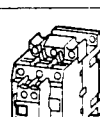
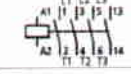
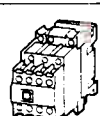
IEC/EN 60 947  
Max. 3-phase  
motor ratings (kW)

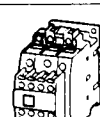
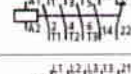
Terminal markings

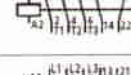
1 phase			3 phase			
115 V	200 V	230 V	200 V	230 V	460 V	575 V
HP	HP	HP	HP	HP	HP	HP

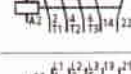
AC-3		
220 V	380 V	660 V
230 V	400 V	690 V
kW	kW	kW

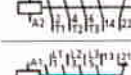
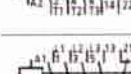
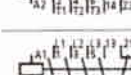
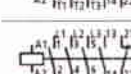
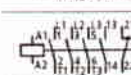
Circuit diagram

	1/2	1	1 1/2	3	3	5	7 1/2	20/18	2,2	4	5,5	
	1/2	1	1 1/2	3	3	5	7 1/2	20/18	2,2	4	5,5	
	1/2	1	1 1/2	3	3	5	7 1/2	20/18	2,2	4	5,5	
	1/2	1	1 1/2	3	3	5	7 1/2	20/18	2,2	4	5,5	
	1	2	2	3	3	7 1/2	10	20/18	3	5,5	7,5	
	1	2	2	3	3	7 1/2	10	20/18	3	5,5	7,5	
	1	2	2	3	3	7 1/2	10	20/18	3	5,5	7,5	
	2	2	3	7 1/2	7 1/2	10	15	35/31	4	7,5	11	
	2	2	3	7 1/2	7 1/2	10	15	35/31	4	7,5	11	
	2	3	5	7 1/2	10	15	20	35/31	5,5	11	15	
	2	3	5	7 1/2	10	15	20	35/31	5,5	11	15	
	3	5	5	10	10	20	25	55/50	7,5	15	18,5	
	3	5	7 1/2	10	15	25	30	55/50	11	18,5	22	
	3	7 1/2	10	15	20	40	40	90/81	15	22	30	
	5	10	15	20	25	50	50	90/81	18,5	30	37	

# DIL Contactors

Units complete with auxiliary contacts

AC operation		DC operation	
Type Article No.	List Price see price list	Type Article No.	List Price see price list
Coil voltages shown in (...) For other coil voltages, → pages 03/067, 068		Coil voltages shown in (...) For other coil voltages, → pages 03/067, 068	
DIL00M-10(120V60HZ) 046643		DIL00M-G-10(24VDC) 048670	
DIL00M-01(120V60HZ) 046651		DIL00M-G-01(24VDC) 048665	
DIL00M/11(120V60HZ) 046659		DIL00M-G/11(24VDC) 048675	
DIL00M/22(120V60HZ) 046667		DIL00M-G/22(24VDC) 048680	
DIL00AM-10(120V60HZ) 046675		DIL00AM-G-10(24VDC) 048650	
DIL00AM-01(120V60HZ) 046683		DIL00AM-G-01(24VDC) 048645	
DIL00AM/11(120V60HZ) 046691		DIL00AM-G/11(24VDC) 048655	
DIL00AM/22(120V60HZ) 046699		DIL00AM-G/22(24VDC) 048660	
DIL0M/11(120V60HZ) 046707		DIL0M-G/11(24VDC) 048686	
DIL0M/22(120V60HZ) 046715		DIL0M-G/22(24VDC) 048953	
DIL0AM/11(120V60HZ) 046753		DIL0AM-G/11(24VDC) 049000	
DIL0AM/22(120V60HZ) 046761		DIL0AM-G/22(24VDC) 049997	
DIL1M/22(120V60HZ) 046769		DIL1M-G/22(24VDC) 051692	
DIL1AM/22(120V60HZ) 046777		DIL1AM-G/22(24VDC) 050858	
DIL2M/22(120V60HZ) 046785		DIL2M-G/22(24VDC) 051702	
DIL2AM/22(120V60HZ) 046793		DIL2AM-G/22(24VDC) 051697	

## Notes

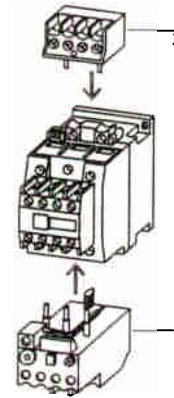

Accessories	Page
1 Overload relay	04/004
2 Interface module or Suppressor	03/040 03/053
Accessories	03/053
Other operating voltages	03/067 03/068

Magnetic Contactors,  
Magnetic Starters



Terminal marking of coil to EN 50 005  
Contacts to EN 50 005 and EN 50 012

# DIL Contactors

Units complete with auxiliary contacts

Magnetic Contactors,  
Magnetic Starters

Rating data  
UL/CSA max. Horsepower rating  
50/60 Hz

General purpose  
continuous  
current  
open/enclosed

IEC/EN 60 947  
Max. 3-phase  
motor ratings (kW)  
AC-3

	220 V	380 V	660 V	1000 V
A	230 V	400 V	690 V	
	kW	kW	kW	kW

3 phase  
115 V 200 V 230 V

	HP	HP	HP
--	----	----	----

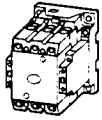

7 1/2	15	15
-------	----	----

100/90	22	37	55	37
--------	----	----	----	----

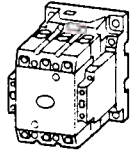

10	25	25
----	----	----

160/144	37	55	90	55
---------	----	----	----	----

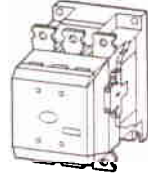

-	-	-
---	---	---

225/ 3)	55	90	175	108
---------	----	----	-----	-----

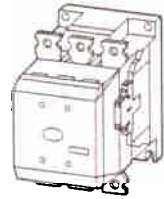

-	-	-
---	---	---

250/ 3)	70	110	215	108
---------	----	-----	-----	-----

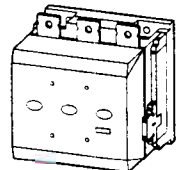

-	-	-
---	---	---

350/ 3)	75	132	240	108
---------	----	-----	-----	-----

**Auxiliary contacts**

Right or left, internal

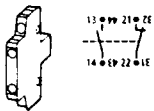

10

Right or left, external

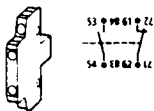

10

Right or left, internal



10

**Notes:**

- 1) 110 - 250 V AC/DC
- 2) 24 - 48 V DC
- 3) Consult Moeller Electric



# DIL Contactors

Units complete with auxiliary contacts

UL / CSA / IEC / CE

Magnetic Contactors  
Magnetic Starters

AC operation		DC operation	
Type	List Price	Type	List Price
Article No.	see price list	Article No.	see price list
Coil voltages shown in (...) For other coil voltages, → pages 03/068, 069		Coil voltages shown in (...) For other coil voltages, → pages 03/068, 069	
DIL3M80/22(120V60HZ) 209866		DIL3M80/22(24VDC) 209880	
DIL4M115/22(120V60HZ) 209920		DIL4M115/22(24VDC) 209934	
DILM185/22(RA250) <sup>1)</sup> 208193		DILM185/22(RDC48) <sup>2)</sup> 208191	
DILM225/22(RA250) <sup>1)</sup> 208197		DILM225/22(RDC48) <sup>2)</sup> 208195	
DILM250/22(RA250) <sup>1)</sup> 208201		DILM250/22(RDC48) <sup>2)</sup> 208199	
DILM300/22(RA250) <sup>1)</sup> 208205		DILM300/22(RDC48) <sup>2)</sup> 208203	
DILM400/22(RA250) <sup>1)</sup> 208209		DILM400/22(RDC48) <sup>2)</sup> 208207	
DILM500/22(RA250) <sup>1)</sup> 208213		DILM500/22(RDC48) <sup>2)</sup> 208211	
DILM580/22(RA250) <sup>1)</sup> 208216		DILM580/22(RA250) <sup>1)</sup> 208216	
DILM650/22(RA250) <sup>1)</sup> 208219		DILM650/22(RA250) <sup>1)</sup> 208219	
DILM750/22(RA250) <sup>1)</sup> 208222		DILM750/22(RA250) <sup>1)</sup> 208222	
DILM820/22(RA250) <sup>1)</sup> 208225		DILM820/22(RA250) <sup>1)</sup> 208225	
DILM820-XHI11-SI 208281		DILM820-XHI11-SI 208281	
DILM820-XHI11-SA 208282		DILM820-XHI11-SA 208282	
DILM820-XHI11V-SI 208283		DILM820-XHI11V-SI 208283	

**Notes:**

DIL3M80 to DIL4M115:

Accessories	Page
1 Overload relay	04/004
2 Suppressor	03/053
Accessories	03/053
Other operating voltages	03/068, 03/069

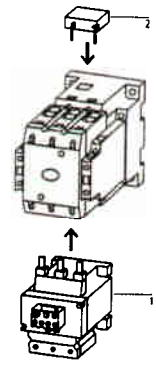

**Terminal markings**      Coil to EN 50 005  
Contacts to EN 50 005 + EN 50 012

DIL3M80 and DIL4M115 can be snap-mounted onto 75mm top-hat rail to EN 50 023

DC operated contactors DIL3M80 to DIL4M115 and all contactors DILM185 to DILM820 have an integral suppressor circuit. When operating DILM580 to DILM820 with frequency inverter, the suppressor circuit on the load side must be removed.

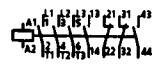

DIL 3M80/22 to DILM820/22

Operating options: DILM185-820 with electronically controlled magnet systems

**Conventional:**  
A1/A2 have voltage applied, as normal.

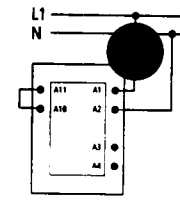

**Direct from the PLC:**  
A 24V output from the PLC can be connected directly to the A3/A4 terminals

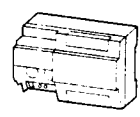
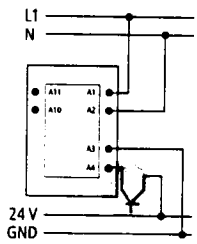

**From low consumption command devices:**  
Low-consumption command devices such as printed circuit board relays, control circuit devices or position switches can be connected directly to A10/A11.

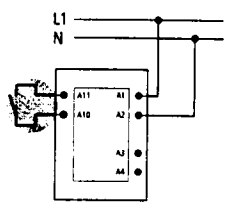

**Auxiliary contact modules mounting options:**

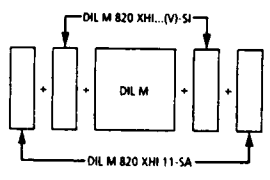

Max. 8 auxiliary contacts possible

DILM820-XHI11V-SI with 1 early-make and 1 late-break contact.

No auxiliary contacts can be mounted between the mechanical interlock and the contactor.



# DIL Contactors

## Reversing Contactor Combinations

Magnetic Contactors,  
Magnetic Starters

### Rating data

UL/CSA maximum Horsepower rating (HP)  
50/60Hz

IEC/EN 60 947  
Max. 3-phase motor ratings (kW)  
50/60 Hz

### AC operation

3 phase

200 V    230 V    460 V    575 V

HP    HP    HP    HP

AC-3

220 V    380 V    660 V  
230 V    400 V    690 V  
240 V    440 V

kW    kW    kW

Type

Article No.  
Coil voltages shown in (...)  
For other coil voltages,  
→ page 03/070

List  
Price  
see price  
list

### Reversing contactors

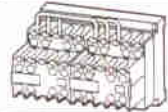

2    3    5    5

2,2    4    4

DIULEM/21/MV(120V60HZ)  
051846

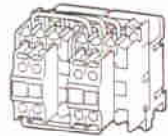

3    3    7 ½    10

3    5,5    -

DIUL00AM/11/MV(120V60HZ)  
110199

7 ½    7 ½    10    15

4    7,5    -

DIUL0M/11/MV(120V60HZ)  
110215

7 ½    10    15    20

5,5    11    -

DIUL0AM/11/MV(120V60HZ)  
110231

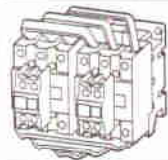

10    15    25    30

11    18,5    -

DIUL1AM/11/MV(120V60HZ)  
110246

20    25    50    50

18,5    30    -

DIUL2AM/11/MV(120V60HZ)  
110262

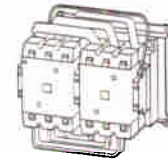

25    30    60    75

22    37    55

DIUL3M80/11/MV(120V60HZ)  
110278

40    50    100    125

37    55    90

DIUL4M115/11/MV(120V60HZ)  
110295



# DIL Contactors

## Reversing Contactor Combinations

UL / CSA / IEC / CE

Magnetic Contactors,  
Magnetic Starters

Individual components of the combination

Contactor K1M	Contactor K2M	Spare auxiliary contacts		Mechanical interlock
		K1M	K2M	
Type	Type			
DILEM-10 + 11DILEM	DILEM-10 + 11DILEM			+
DIL00AM + 11DILM	DIL00AM + 11DILM	-	-	+
DIL0M + 11DILM	DIL0M + 11DILM	-	-	+
DIL0AM + 11DILM	DIL0AM + 11DILM	-	-	+
DIL1AM + 11DILM	DIL1AM + 11DILM	-	-	+
DIL2AM + 11DILM	DIL2AM + 11DILM	-	-	+
DIL3M80 + DILM820-XHI11-SI	DIL3M80 + DILM820-XHI11-SI	-	-	+
DIL4M115 + DILM820-XHI11-SI	DIL4M115 + DILM820-XHI11-SI	-	-	+

Notes:

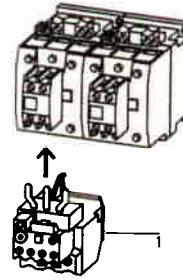

Accessories

Accessories	Page
1 Overload relay	04/004
Accessories	03/053
Other operating voltages	03/070



**DIL Contactors**  
For DC Loads, AC and DC operated

Magnetic Contactors,  
Magnetic Starters

Rating data  
UL/CSA  
max. DC Horsepower rating  
3 pole

115 V  
HP

230 V  
HP

General purpose  
continuous  
current  
open/  
enclosed

A

Standard  
auxiliary contacts

N.O. = normally open  
N.C. = normally closed

N.O.    N.C.

Terminal  
markings

Circuit diagram

Basic devices

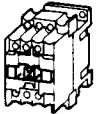
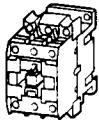
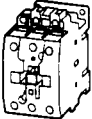
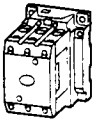
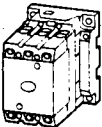
	1	2	20/18
	1 ½	3	20/18
	2	5	35/31
	2	5	35/31
	5	10	55/50
	5	10	55/50
	7 ½	15	90/81
	10	20	90/81
	7 ½	30	100/90
	10	50	160/144

→ page 03/010

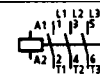

→ page 03/012



# DIL Contactors

For DC Loads, AC and DC operated

UL / CSA / IEC / CE

AC operation		DC operation	
Type	List Price	Type	List Price
Article No.	see price list	Article No.	see price list
Coil voltages shown in (...) For other coil voltages, → pages 03/065, 066		Coil voltages shown in (...) For other coil voltages, → pages 03/065, 066	
<b>DIL00M(120V60HZ)</b> 060477		<b>DIL00M-G(24VDC)</b> 048587	
<b>DIL00AM(120V60HZ)</b> 061222		<b>DIL00AM-G(24VDC)</b> 048567	
<b>DIL0M(120V60HZ)</b> 061254		<b>DIL0M-G(24VDC)</b> 048597	
<b>DIL0AM(120V60HZ)</b> 061262		<b>DIL0AM-G(24VDC)</b> 048592	
<b>DIL1M(120V60HZ)</b> 061270		<b>DIL1M-G(24VDC)</b> 048605	
<b>DIL1AM(120V60HZ)</b> 061427		<b>DIL1AM-G(24VDC)</b> 048602	
<b>DIL2M(120V60HZ)</b> 046563		<b>DIL2M-G(24VDC)</b> 048615	
<b>DIL2AM(120V60HZ)</b> 046571		<b>DIL2AM-G(24VDC)</b> 048610	
<b>DIL3M80(120V60HZ)</b> 209691		<b>DIL3M80(24VDC)</b> 209709	
<b>DIL4M115(120V60HZ)</b> 209750		<b>DIL4M115(24VDC)</b> 209765	

## Notes

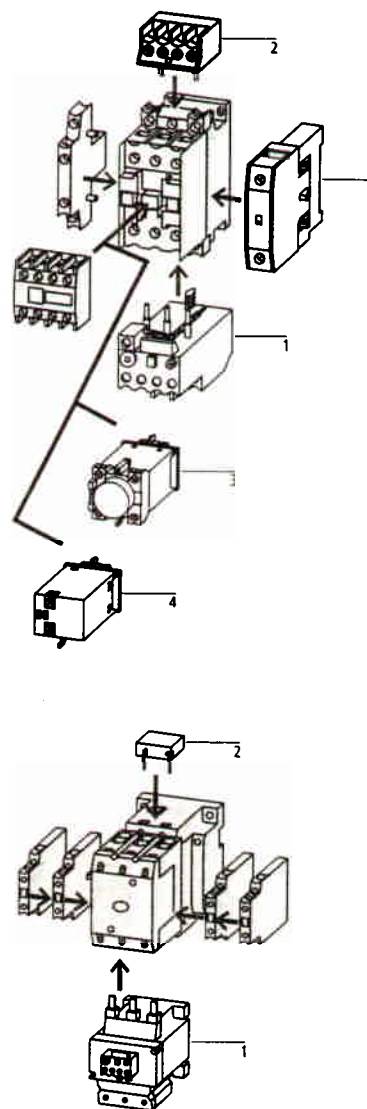

Accessories	Page
1 Overload relay	04/004
2 Interface module or suppressor module	03/059 03/053
3 Pneumatic timer module	03/057
4 Mechanical latching module	03/057
5 Additional 4th pole from DIL0M(-G)	03/057
Additional auxiliary contact modules	02/010
Accessories	03/053
Other operating voltages	03/065 03/066

## Magnetic Starters

### Ordering Information

#### Selecting and completing the type number

Type numbers provide full, and in some cases, coded descriptions, of the standard devices to which they apply. The most frequently used starter type numbers are explained as follows:

#### Key to completion of type number

Starter type	Frame size	Auxiliary contacts	Overload relay	Enclosure	Coil voltage
<ul style="list-style-type: none"> <li>- <b>DIL</b> = Non-reversing</li> <li>- <b>DIUL</b> = Reversing</li> <li>- <b>M</b> = Combination</li> <li>- <b>MW</b> = Combination Reversing</li> <li>- <b>ZS</b> = Two Speed</li> <li>- <b>AT</b> = Autotransformer</li> <li>- <b>SD</b> = Star Delta</li> <li>- <b>PW</b> = Part Winding</li> </ul>	<ul style="list-style-type: none"> <li>↳ DIL contactors are available in a variety of sizes to match the motor being started</li> </ul>	<ul style="list-style-type: none"> <li>- <b>10</b> = 1 N.O. - 0 N.C.</li> <li>- <b>11</b> = 1 N.O. - 1 N.C.</li> <li>- <b>20</b> = 2 N.O. - 0 N.C.</li> <li>- <b>22</b> = 2 N.O. - 2 N.C.</li> </ul>	<ul style="list-style-type: none"> <li>- <b>Z00-...</b> complete the part number by adding</li> <li>- <b>Z1-...</b> suffix code from</li> <li>- <b>Z5-...</b> the table on the</li> <li>- <b>ZW7-...</b> opposite page</li> <li>- <b>ZEV</b></li> </ul>	<ul style="list-style-type: none"> <li>- <b>/S</b> = General Purpose, Type 1</li> <li>- <b>/SD</b> = Dust and Drip Resistant, Type 12</li> <li>- <b>/DW</b> = Outdoor Use, Type 3R</li> <li>- <b>/I</b> = Corrosion-resistant, Type 12, 13, Indoor 4X</li> <li>- <b>no suffix</b> = open type (no enclosure)</li> </ul>	<ul style="list-style-type: none"> <li>↳ Standard coil voltage is 120V 60Hz. Other coil voltages in the range of 12V DC to 480V AC can be provided. Select required coil voltage from page 03/065</li> </ul>

To order a magnetic starter, specify the following:

- Type number, consisting of starter type, frame size and auxiliary contacts
- Overload relay suffix (see selection table on the opposite page)
- Enclosure suffix
- Coil voltage
- Accessories



# Magnetic Starters

## Ordering Information

### Ordering Example

Required is a full voltage, non-reversing, non-combination starter in a general purpose Type 1 enclosure and with a coil voltage of 120V 60Hz for a 10 HP motor at 460V AC, 3-phase.

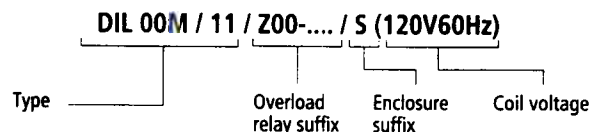

#### Type

**DIL** Non-reversing, across-the-line starter

**0M** Contactor frame size (10 HP @ 460V AC, 3-phase).

Accessories are chosen according to contactor frame size.

**/11** Auxiliary contacts: 1 N.O., 1 N.C.

**/Z00-** Type Z00 overload relay (motor current setting range suffix must be added)

#### Overload relay suffix

**Z00-** This part requires completion by adding a suffix code from the table below

For the 10 HP motor @ 460V AC, 3-phase, the motor full load current is 14 (if possible, actual nameplate rating should be used).

Select the appropriate overload setting range within the Z00- type listing below that includes the 14A motor FLC. This is **Z00-16** with an adjustable range of 10 to 16A. The suffix to be inserted into the starter catalog number is the maximum of the setting range, in this case 16.

#### Enclosure Suffix

**/S** General purpose indoor, Type 1 (as shown on previous page)

#### Coil voltage

**120V 60Hz** Select the required coil voltage from the list shown on page 03/065 and 066.



### Overload relay selection table

Adjustable setting range	Type	Suffix code	Adjustable setting range	Type	Suffix code	Adjustable setting range	Type	Suffix code
0.1 - 0.16	Z00-	<b>0.16</b>	6 - 10	Z1-	<b>10</b>	50 - 70	Z5-	<b>70/FF250</b>
0.16 - 0.24	Z00-	<b>0.24</b>	10 - 16	Z1-	<b>16</b>	70 - 100	Z5-	<b>100/FF250</b>
0.24 - 0.4	Z00-	<b>0.4</b>	16 - 24	Z1-	<b>24</b>	95 - 125	Z5-	<b>125/FF250</b>
0.4 - 0.6	Z00-	<b>0.6</b>	24 - 40	Z1-	<b>40</b>	120 - 160	Z5-	<b>160/FF250</b>
0.6 - 1.0	Z00-	<b>1.0</b>	40 - 57	Z1-	<b>57</b>	160 - 220	Z5-	<b>220/FF250</b>
1.0 - 1.6	Z00-	<b>1.6</b>	50 - 63	Z1-	<b>63</b>	200 - 250	Z5-	<b>250/FF250</b>
1.6 - 2.4	Z00-	<b>2.4</b>	63 - 75	Z1-	<b>75</b>			
2.4 - 4	Z00-	<b>4</b>				42 - 63	ZW7-	<b>63</b>
4 - 6	Z00-	<b>6</b>	25 - 35	Z5-	<b>35/SK3</b>	60 - 90	ZW7-	<b>90</b>
6 - 10	Z00-	<b>10</b>	35 - 50	Z5-	<b>50/SK3(4)</b>	85 - 125	ZW7-	<b>125</b>
10 - 16	Z00-	<b>16</b>	50 - 70	Z5-	<b>70/SK3(4)</b>	110 - 160	ZW7-	<b>160</b>
16 - 24	Z00-	<b>24</b>	70 - 100	Z5-	<b>100/SK3(4)</b>	160 - 240	ZW7-	<b>240</b>
			95 - 125	Z5-	<b>120/SK4</b>	190 - 290	ZW7-	<b>290</b>
			120 - 150	Z5-	<b>150/SK4</b>	270 - 400	ZW7-	<b>400</b>
						360 - 540	ZW7-	<b>540</b>

# AC Magnetic Full Voltage Non-reversing Starters

Magnetic Contactors, Magnetic Starters

UL/CSA max. Hp rating 50/60Hz				Standard auxiliary contacts		Type <sup>1)</sup> Specify coil voltage and frequency → page 03/065, 066  Specify overload relay suffix code → page 03/023	Price includes 3 phase, bimetallic overload relay			Open			
							Enclosed	General purpose Type 1 Replace <input type="checkbox"/> with suffix /S	Industrial use Type 12 dusttight Replace <input type="checkbox"/> with suffix /SD Type 3R weatherproof Replace <input type="checkbox"/> with suffix /DW	Insulating material Type 12, 13, indoor 4X corrosion-resistant dusttight Replace <input type="checkbox"/> with suffix /I	without enclosure  Delete <input type="checkbox"/> in type		
200 V	230 V	460 V	575 V	HP	HP	N.O.	N.C.	...	(...)	see price list	see price list	see price list	see price list

Three phase				HP	HP	HP	HP	N.O.	N.C.	...	(...)	see price list	see price list	see price list	see price list
3	3	5	7 ½	1	1										
3	3	7 ½	10	1	1										
5	7 ½	10	15	1	1										
-	-	15	20	1	1										
7 ½	10	-	-	1	1										
10	10	20	25	1	1										
-	-	25	30	1	1										
10	15	-	-	1	1										
15	20	40	40	1	1										
-	-	-	50	1	1										
20	-	-	-	1	1										
-	25	50	-	1	1										
25	30	60	75	1	1										
40	50	100	125	1	1										
50	60	125	150	2	2										
60	75	150	200	2	2										
75	100	200	250	2	2										

Single phase				HP	HP	HP	N.O.	N.C.	...	(...)	see price list	see price list	see price list	see price list	
115 V	200 V	230 V		HP	HP	HP	N.O.	N.C.							
½	1	1 ½	1	1											
1	2	2	1	1											
2	2	3	1	1											
2	3	3	1	1											
3	5	5	1	1											
3	5	7 ½	1	1											
3	-	-	1	1											
-	7 ½	10	1	1											
5	-	-	1	1											
-	10	-	1	1											
-	-	15	1	1											

Notes: <sup>1)</sup> Overload relays supplied with starters on this page can also be field-installed, for more flexibility in selection. Consult Moeller Electric for additional details.  
<sup>2)</sup> These starters are not available with suffix /I enclosures.

**To order specify:**  
Type number  
Overload relay suffix  
Enclosure suffix  
Coil voltage  
Accessories

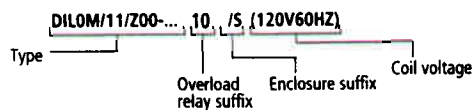

Additional information	Page
Technical data	03/080
Dimensions	03/091
Overload relays	04/004
Accessories	03/053
Factory modifications	03/046
Weights	14/020



# AC Magnetic Full Voltage Reversing Starters

UL/CSA max. Hp rating 50/60Hz				Standard auxiliary contacts		Type	Price includes 3 phase, bimetallic overload relay				
						Specify coil voltage and frequency → page 03/070	Enclosed		Open		
						Specify overload relay suffix code → page 03/023	General purpose Type 1 Replace <input type="checkbox"/> with suffix /S	Industrial use Type 12 dusttight Replace <input type="checkbox"/> with suffix /SD Type 3R weatherproof Replace <input type="checkbox"/> with suffix /DW	Insulating material Type 12, 13, indoor 4X corrosion-resistant dusttight Replace <input type="checkbox"/> with suffix /I	without enclosure  Delete <input type="checkbox"/> in type	
200 V	230 V	460 V	575 V	N.O.	N.C.	...	(...)	see price list	see price list	see price list	see price list

Three phase										
3	3	5	7 ½	1	1	DIUL00M/11/Z00-.../MV <input type="checkbox"/> (...)				
3	3	7 ½	10	1	1	DIUL00AM/11/Z00-.../MV <input type="checkbox"/> (...)				
7 ½	7 ½	10	15	1	1	DIUL0M/11/Z00-.../MV <input type="checkbox"/> (...)				
-	-	15	20	1	1	DIUL0AM/11/Z00-.../MV <input type="checkbox"/> (...)				
10	10	20	25	1	1	DIUL1M/11/Z1-.../MV <input type="checkbox"/> (...)				
10	15	25	30	1	1	DIUL1AM/11/Z1-.../MV <input type="checkbox"/> (...)				
15	20	40	40	1	1	DIUL2M/11/Z1-.../MV <input type="checkbox"/> (...)				
20	25	50	50	1	1	DIUL2AM/11/Z5-.../MV <input type="checkbox"/> (...)				
25	30	60	75	1	1	DIUL3M80/11/Z5-.../XMV <input type="checkbox"/> (...)				
40	50	100	125	1	1	DIUL4M115/11/Z5-.../XMOV <input type="checkbox"/> (...) <sup>1)</sup>				
50	60	125	150	2	2	DIULM185/22/Z5-160/XMV <input type="checkbox"/> (...) <sup>2)</sup>				
60	75	150	200	2	2	DIULM225/22/Z5-220/XMV <input type="checkbox"/> (...) <sup>2)</sup>				
75	100	200	250	2	2	DIULM250/22/Z5-250/XMV <input type="checkbox"/> (...) <sup>2)</sup>				

Notes: <sup>1)</sup> These starters with suffix /I enclosure are available in types 12 and 13 only.  
<sup>2)</sup> These starters are not available with suffix /I enclosures.

- To order specify:**
- Type number
  - Overload relay suffix
  - Enclosure suffix
  - Coil voltage
  - Accessories

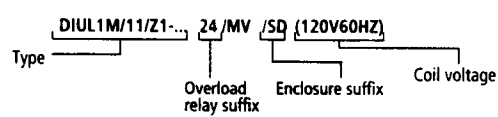

Additional information	Page
Technical data	03/080
Dimensions	03/091
Overload relays	04/004
Accessories	03/053
Factory modifications	03/046
Weights	14/020

Magnetic Contactors, Magnetic Starters



## SYST-M Starters

### AC Magnetic Full Voltage Non-reversing

 Magnetic Contactors,  
Magnetic Starters

UU/CSA max. Hp rating 50/60Hz						Type	List Price
1 phase <sup>4)</sup>		3 phase				120V coil <sup>1)</sup>	see price list
115 V	230 V	200 V	230 V	460 V	575 V	Overload relay not included <sup>2)</sup>	
HP	HP	HP	HP	HP	HP	Article No.	
1/2	1 1/2	3	3	5	7 1/2	<b>DIL00M/11/Z00 X/SM</b> 100460	
1	2	3	3	7 1/2	10	<b>DIL00AM/11/Z00 X/SM</b> 100458	
2	3	5	7 1/2	10	15	<b>DIL0M/11/Z00 X/SM</b> 100464	
2	3	5	7 1/2	15	20	<b>DIL0AM/11/Z00 X/SM</b> 100462	
3	5	10	10	20	25	<b>DIL1M/11S/Z1 X/SM</b> 100467	
3	7 1/2	10	15	25	30	<b>DIL1AM/11S/Z1 X/SM</b> 100466	
3	10	15	20	40	40	<b>DIL2M/11/Z1 X/SM</b> 100470	
5	-	20	-	-	50	<b>DIL2AM/11/Z1 X/SM</b> 100469	
-	15	-	25	50	-	<b>DIL2AM/11/Z1-75/SM <sup>3)</sup></b> 100468	

**Notes:**

- <sup>1)</sup> For coil voltages other than 120V, refer to page 03/065.
- <sup>2)</sup> Select required overload relay from page 03/023 and add price to starter price as shown in the price list.
- <sup>3)</sup> Overload relay included in price.
- <sup>4)</sup> Refer to instructions included with the starter for use in single-phase applications.

#### SYST-M Magnetic Starters

Moeller Electric offers full voltage non-reversing and reversing starters factory-wired to accept plug-in field modification kits and control transformers.

Select from any of twelve different combinations of pilot devices and simply plug-in the kit. These starters eliminate the need of field wiring.

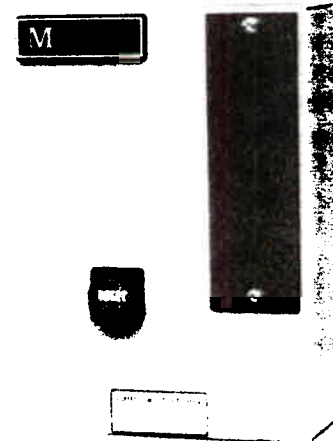
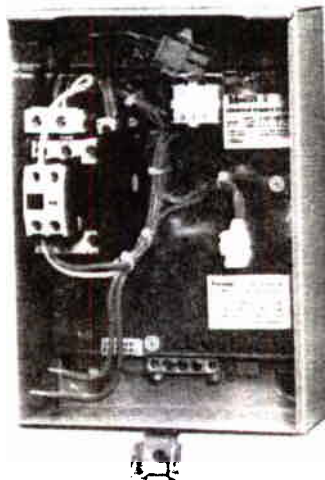

# SYST-M Starters

## AC Magnetic Full Voltage Reversing

UL/CSA max. Hp rating 50/60Hz				Type	List Price
3 phase				EEMAC Type 1 enclosure 120V coil <sup>1)</sup> Overload relay not included <sup>2)</sup>	
200 V	230 V	460 V	575 V	Article No.	see price list
HP	HP	HP	HP		
3	3	5	7 ½	DIUL00M/11/Z00 X/MV/SM 100473	
3	3	7 ½	10	DIUL00AM/11/Z00 X/MV/SM 100472	
5	7 ½	10	15	DIUL0M/11/Z00 X/MV/SM 100475	
5	7 ½	15	20	DIUL0AM/11/Z00 X/MV/SM 100474	
10	10	20	25	DIUL1M/11/Z1 X/MV/SM 100477	
10	15	25	30	DIUL1AM/11/Z1 X/MV/SM 100476	
15	20	40	40	DIUL2M/11/Z1 X/MV/SM 100480	
20	-	-	50	DIUL2AM/11/Z1 X/MV/SM 100479	
-	25	50	-	DIUL2AM/11/Z1-75/MV/SM <sup>3)</sup> 100478	

**Notes:**

- <sup>1)</sup> For coil voltages other than 120V, refer to page 03/065.
- <sup>2)</sup> Select required overload relay from page 03/023 and add price to starter price as shown in the price list.
- <sup>3)</sup> Overload relay included in price.

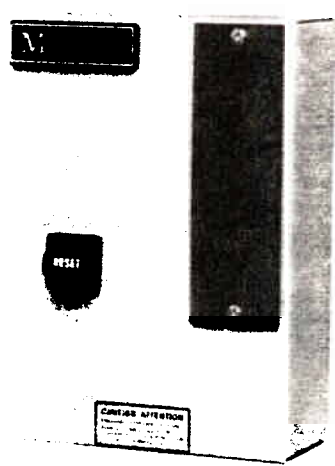
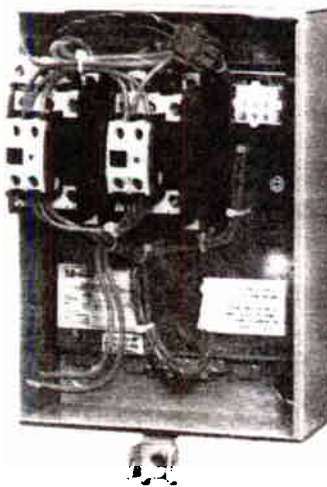

# SYSTM Starters

## Field Modification Kits

Illustration	Symbols and Legend Plates	Description	English version	French version	List Price see price list
			Type Article No.	Type Article No.	
English / French text					
<b>Pushbuttons</b>					
		Double pushbutton mounted in single hole	<b>SYSTM-SSQ</b> 101219	<b>SYSTM-SSQ-F</b> 101220	
		2 individually mounted pushbuttons START flush green STOP raised red	<b>SYSTM-SS</b> 101207	<b>SYSTM-SS-F</b> 101208	
<b>STOP-START Pushbuttons</b>					
		STOP-START pushbuttons and red pilot light c/w LED element with 85 - 264V AC operating range	<b>SYSTM-SS/PL</b> 101209	<b>SYSTM-SS/PL-F</b> 101210	
		Red pilot light c/w LED element with 85 - 264V AC operating range	<b>SYSTM-PL</b> 101200	<b>SYSTM-PL-F</b> 101201	
<b>2 position selector switches</b>					
		2 position selector switch, thumb-grip handle	<b>SYSTM-OO</b> 101188	<b>SYSTM-OO-F</b> 101189	
		2 position selector switch and red pilot light c/w LED element with 85 - 264V AC operating range	<b>SYSTM-OO/PL</b> 101190	<b>SYSTM-OO/PL-F</b> 101191	
<b>3 position selector switches</b>					
		3 position selector switch, thumb-grip handle	<b>SYSTM-HOA</b> 101176	<b>SYSTM-HOA-F</b> 101177	
		3 position selector switch and red pilot light c/w LED element with 85 - 264V AC operating range	<b>SYSTM-HOA/PL</b> 101178	<b>SYSTM-HOA/PL-F</b> 101179	

# SYSTM Starters

## Field Modification Kits

Magnetic Contactors  
Magnetic Starters

Illustration	Symbols and Legend Plates	Description	English version	French version	List Price
			Type	Type	
English / French text			Article No.	Article No.	see price list
<b>Pushbuttons</b>					
		3 individually mounted pushbuttons FORWARD and REVERSE flush black, STOP raised profile red	<b>SYSTM-SFR</b> 101205	<b>SYSTM-SFR-F</b> 101206	
		2 illuminated pushbuttons and 1 non-illuminated pushbutton FORWARD and REVERSE flush, white lens, c/w LED element with 85 - 264V AC operating range, STOP raised profile red	<b>SYSTM-S/F-PL/R-PL</b> 101203	<b>SYSTM-S/F-PL/R-PL-F</b> 101204	
<b>3 position selector switches</b>					
		3 position selector switch, thumb-grip handle	<b>SYSTM-FOR</b> 101172	<b>SYSTM-FOR-F</b> 101173	
		3 position selector switch, thumb-grip handle and 2 red pilot lights c/w LED element with 85 - 264V AC operating range	<b>SYSTM-FOR/PL/PL</b> 101174	<b>SYSTM-FOR/PL/PL-F</b> 101175	

**Accessories**

**Remote control adapter**

	5 wire plug-in adapter. For use when a starter is controlled from a remote location only	<b>SYSTM-RA</b> 101202
--	---	---------------------------

VA Rating	Secondary fuse	Contactor Size	Type	List Price
50	0.5	DIL00M, DIL00AM DIL0M, DIL0AM DIL1M, DIL1AM	<b>SYSTM-T50-600/120</b> 101224	
			<b>SYSTM-T50-480/120</b> 101223	
			<b>SYSTM-T50-240/120</b> 101222	
			<b>SYSTM-T50-208/120</b> 101221	
75	0.75	DIL2M, DIL2AM	<b>SYSTM-T75-600/120</b> 101228	
			<b>SYSTM-T75-480/120</b> 101227	
			<b>SYSTM-T75-240/120</b> 101226	
			<b>SYSTM-T75-208/120</b> 101225	

**Control transformers including fuse block and fuse**



# AC Magnetic Two-speed Starters

Magnetic Contactors, Magnetic Starters

UL/CSA max. Hp rating  
50/60Hz  
3 phase

200 V 230 V 460 V 575 V  
HP HP HP HP

Constant or variable torque

3	3	5	5
-	-	7 1/2	10
7 1/2	7 1/2	10	15
-	-	15	20
-	10	-	-
10	-	20	25
-	15	25	30
-	-	30	40
15	20	40	-
20	25	50	50
25	30	60	75
40	50	100	125
50	60	125	150
60	75	150	200
75	100	200	250
100	125	250	300
125	150	300	400
150	200	400	500

Constant horsepower

2	2	3	3
-	-	5	7 1/2
5	5	7 1/2	10
-	7 1/2	10	15
7 1/2	-	15	20
-	10	20	25
10	15	30	-
15	20	40	40
25	25	50	60
30	40	75	75
50	60	100	125
60	75	150	200

## 2 speed, 2 winding

### Type

Specify coil voltage and frequency → page 03/065

Specify overload relay rated current see below

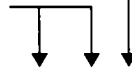

## Enclosed<sup>2)</sup> Y-Y<sup>1)</sup>

List Price includes 2 3-phase bimetallic overload relays

see price list

## 2 speed, 1 winding

### Type

Specify coil voltage and frequency → page 03/065

Specify overload relay rated current see below

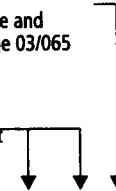

## Enclosed<sup>2)</sup>

List Price includes 2 3-phase bimetallic overload relays

see price list

2S2W00M/11/Z00-.../Z00-.../S(...)
2S2W00AM/11/Z00-.../Z00-.../S(...)
2S2W0M/11/Z00-.../Z00-.../S(...)
2S2W0AM/11/Z00-.../Z00-.../S(...)
2S2W0AM/11/Z1-.../Z00-.../S(...)
2S2W1M/11/Z1-.../Z00-.../S(...)
2S2W1AM/11/Z1-.../Z00-.../S(...)
2S2W2M/11/Z1-.../Z1-.../S(...)
2S2W2M/11/Z1-.../Z1-.../S(...)
2S2W2AM/11/Z1-.../Z1-.../S(...)
2S2W3M80/11/Z5-.../Z5-.../S(...)
2S2W4M115/11/Z5-.../Z5-.../S(...)
2S2WM185/11/Z5-.../Z5-.../S(...)
2S2WM225/11/Z5-.../Z5-.../S(...)
2S2WM250/11/Z5-.../Z5-.../S(...)
2S2WM300/11/ZW7-.../ZW7-.../S(...)
2S2WM400/11/ZW7-.../ZW7-.../S(...)
2S2WM500/11/ZW7-.../ZW7-.../S(...)

2S1W00M/11/Z00-.../Z00-.../S(...)
2S1W00AM/11/Z00-.../Z00-.../S(...)
2S1W0M/11/Z00-.../Z00-.../S(...)
2S1W0AM/11/Z00-.../Z00-.../S(...)
2S1W0AM/11/Z1-.../Z00-.../S(...)
2S1W1M/11/Z1-.../Z00-.../S(...)
2S1W1AM/11/Z1-.../Z00-.../S(...)
2S1W2M/11/Z1-.../Z1-.../S(...)
2S1W2M/11/Z1-.../Z1-.../S(...)
2S1W2AM/11/Z1-.../Z1-.../S(...)
2S1W3M80/11/Z5-.../Z5-.../S(...)
2S1W4M115/11/Z5-.../Z5-.../S(...)
2S1WM185/11/Z5-.../Z5-.../S(...)
2S1WM225/11/Z5-.../Z5-.../S(...)
2S1WM250/11/Z5-.../Z5-.../S(...)
2S1WM300/11/ZW7-.../ZW7-.../S(...)
2S1WM400/11/ZW7-.../ZW7-.../S(...)
2S1WM500/11/ZW7-.../ZW7-.../S(...)



Notes:

- <sup>1)</sup> Starters are for Y-Y motors. For other winding configurations, refer to Moeller Electric.
- <sup>2)</sup> General purpose enclosure Type 1. For other special purpose enclosures, consult Moeller Electric.
- <sup>3)</sup> For factory modifications, see page 03/046.

### Setting range of adjustable thermal overload relays

Type	Setting range from ... to ... A (when ordering state bold figure)
Z00-	0.1-0.16, 0.16-0.24, 0.4-0.6, 0.6-1, 1.0-1.6, 1.6-2.4, 2.4-4, 4-6, 6-10, 10-16, 16-24
Z1-	6-10, 10-16, 16-24, 24-40, 40-57, 50-63, 63-75
Z5-	25-35, 35-50, 50-70, 70-100, 95-125, 120-150
ZW7-	42-63, 60-90, 85-125, 110-160, 160-240, 190-290, 270-400, 360-540

### To order specify:

- Type number, coil voltage
- Line voltage, HP, phase
- Motor speeds
- Motor full load currents at each speed
- Constant or variable torque, or constant horsepower

### Example:

2S2W1AM/11/Z1-40/Z00-24/S, 120V coil - 575V, 30Hp, 3ph., 1800/1200 RPM, 29.2/20.6A constant torque

# Self-protected Combination Starters System PKZ 2-SP

**Type PKZ 2/ZM/S-SP motor starters: a higher level of protection and versatility**

## General:

The PKZ 2/ZM/S-SP is a self-protected starter, the first motor controller to be UL listed and CSA certified under Type E, the category for self-protected control devices. In other words, it is a combination motor controller featuring main disconnect, overcurrent, overload and motor switching functions in one compact unit.

In addition, the PKZ2/ZM/S-SP incorporates the latest technological advances in current limitation to provide a high short-circuit interrupting rating and continuity of service capability.

The PKZ2/ZM/S-SP is a stand-alone device which does not require any backup protection up to its maximum interrupting rating! It is available in both, full voltage non-reversing and full voltage reversing versions.

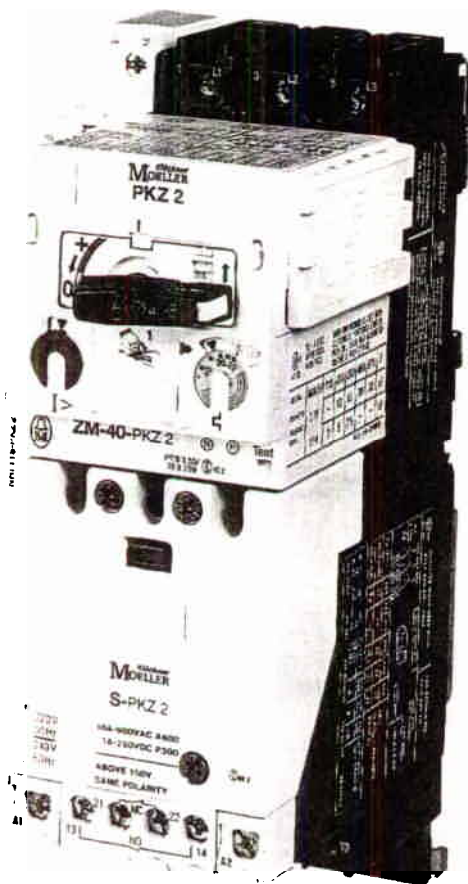

## Features

- UL listed, CSA certified self-protected combination motor controller UL 508 / CSA 22.2 No. 14, Category E.
- Fuseless, high fault interrupting current-limiting design, with separate main contacts for disconnect and contactor.
- The modular construction integrates both thermal and magnetic trips.
- Controls and protects motors up to 30 HP at 460V, 25 HP at 575V
- One basic device accommodates up to 11 different plug-in modules, simplifying engineering and reducing stocking costs.
- Suitable for PLC controlled, fully automated operation.
- Differentiated overload and short-circuit trip indication.
- A wide range of accessories.



	Page
Application notes	03/032
Features and benefits	03/032
Full voltage, non-reversing basic starter	03/033
Full voltage, reversing basic starter	03/033
Trip modules	03/033
Combination starters with trip modules	03/034, 03/035
Accessories	08/048
Technical data	08/060
Dimensions	08/070

# System PKZ 2-SP Self-protected Combination Starters

Magnetic Contactors,  
Magnetic Starters

## All-in-one starter eliminates upstream circuit breaker or fuses

As per the intent of NEC article 430 and CEC Rule 28, the self-protected control device will perform the functions of motor disconnecting means (part H), motor branch circuit, short circuit and ground fault protection (part D), motor controller (part G) and motor overload protection (part C).

Up to the maximum rated short-circuit current available, no upstream circuit breaker or set of fuses is required.

The PKZ 2/ZM-.../S-SP has two sets of main contacts, both current-limiting in design. This provides it with a high interrupting rating and the capability to protect itself against damage under fault conditions. No contact welding can ensue thus providing for continuity of service.

Each unit consists of a basic frame (disconnect switch and contactor) rated to switch a motor load of 30Hp at 460V, 25 Hp at 575V AC. Eleven plug-in trip modules are available to cover motor loads ranging from fractional Hp sizes through 30 Hp at 460V and 25 Hp at 575V AC. As a result, stocking of parts is minimized and use of the starter for other motor loads may be as simple as plugging-in a new trip module and setting the trip module response dials.

## Choose the PKZ2/ZM-.../S-SP starter for maximum protection and flexibility

- UL listed for use on circuits capable of delivering 65kA RMS sym. at 480Y/277V AC and 42kA RMS sym. at 600Y/347V AC.
- No backup short-circuit protection required (replaces fuses or circuit breakers required by other conventional starters).
- Plug-in trip modules can be removed/installed without disturbing power wiring.
- Field-adjustable, coordinated and sealable settings for motor overload and short-circuit trip response.
- Compact design allows installation in hard-to-fit areas.
- Exceeds IEC "Type 2" coordination without the need for additional fuses or circuit breakers.
- Removal of trip block (for maintenance or servicing) provides visible electrical isolation gap between line disconnecting and contactor portions.
- All live parts (including terminals) are shrouded against accidental contact ("finger-proof" per IEC 536), even with the plug-in trip module removed.
- Maximum continuity of service (protects itself against damage from fault currents).

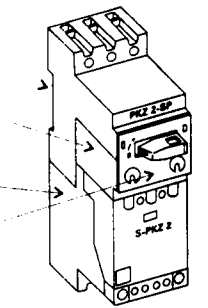
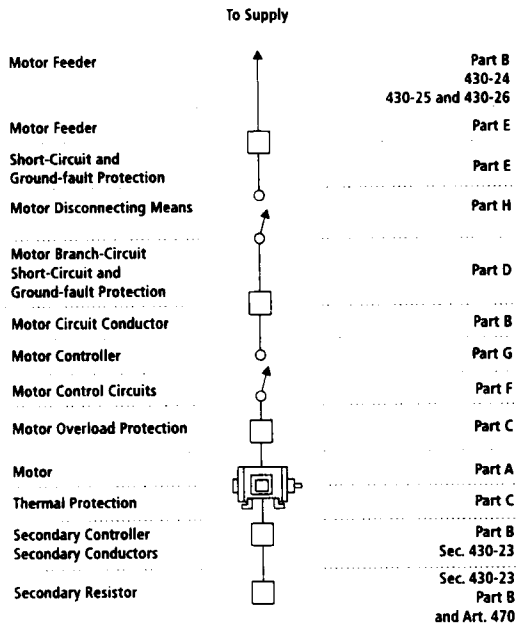

PKZ2/ZM-...S-SP Self-protected Combination Motor Controller

Diagram 430-1 from NEC Article 430

The PKZ2/ZM-.../S-SP self-protected starter comes standard as a one piece construction featuring a main disconnect and a contactor. The unit can be either panel or rail mounted. Integral power takeoffs are provided between the disconnect and contactor for control circuit feed. Adjustable motor protective thermal-magnetic trip modules are set in accordance with the motor full load current and plugged directly into the base of the disconnect.

Trip modules and accessories can be field installed for maximum versatility. The main disconnect and contactor modules can also be separately mounted. This is particularly suitable for full voltage reversing applications which combine the PKZ2-SP disconnect switch and two mechanically interlocked S-PKZ2 contactors. (a page 08/024)

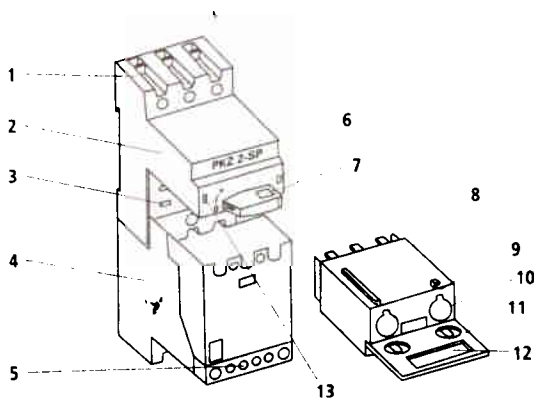

- 1 Both field wiring terminals on the line side (disconnect) and load side (contactor) have large service entrance spacings typical of molded case circuit breakers.
- 2 The main disconnect isolating contacts are current limiting in design.
- 3 Visible "finger-touch-proof" open circuit power path when trip module is removed.
- 4 The contactor main switching contacts are also current limiting in design and significantly enhance the device's overall interrupting ability.
- 5 The contactor comes standard with 1 N.O. and 1 N.C. auxiliary contacts. 2 N.O. contacts are also available.
- 6 The trip module can be set and then sealed with a wire lock.
- 7 Padlockable handle with ON, OFF and + (tripped) indication.
- 8 Field-interchangeable plug-in motor protective trip modules with coordinated overload and short-circuit protection built in.
- 9 Adjustable magnetic trip dial, range 8.5 - 14 x trip module rating.
- 10 Adjustable thermal trip dial, range 0.6 - 1 x trip module rating (set to motor FLC.)
- 11 Test-to-trip slot.
- 12 Coding feature to differentiate trip modules.
- 13 Short-circuit trip indicator K-AGM-PKZ2 provides visual indication of short circuit trip condition and differentiation between short-circuit and general trip due to overload and/or voltage trips.



## System PKZ 2-SP

### Self-protected Combination Starters - FVNR, FVR, Open Type

Max. HP rating, 3 phase				Type	List Price	Notes:
200 V	230 V	480 V	575 V	Specify coil voltage and frequency, → page 03/034	see price list	
HP	HP	HP	HP			
<b>Full voltage, non-reversing starter</b>						Ready to be mounted and wired in its own enclosure. Trip modules shown below can be selected later according to desired motor HP and FLC and plugged into the disconnect to complete the starter.
without trip module						
10	15	30	25	<b>PKZ2/S-SP (...)</b>		
<b>Full voltage, reversing starter</b>						Supplied with factory mounted and wired disconnect and mechanically interlocked contactors. Trip modules shown below can be selected later according to desired motor HP and FLC and plugged into the disconnect to complete the starter.
without trip module						
10	15	30	25	<b>PKZ2/S-SP-FVR (...)</b>		

Trip modules				with overload function					
Max. HP rating 3 phase				Adjustable thermal current range	Adjustable magnetic current range	Type	List Price	Type	List Price
200V	230V	460V	575V	A <sup>1)</sup>	A	Article No.	see price list	Article No.	see price list
HP	HP	HP	HP						
Trip modules are added to above devices to complete starter									
In this range select devices in accordance with motor FLC				0.4 - 0.6	5 - 8	<b>ZM-0.6-PKZ2</b> 024232		<b>ZMR-0.6-PKZ2</b> 033943	
		1/2	1/2	0.6 - 1	8 - 14	<b>ZM-1-PKZ2</b> 028979		<b>ZMR-1-PKZ2</b> 033950	
	1/3	3/4	1	1.0 - 1.6	14 - 22	<b>ZM-1.6-PKZ2</b> 031352		<b>ZMR-1.6-PKZ2</b> 033952	
1/2	1/2	1	1 1/2	1.6 - 2.4	20 - 35	<b>ZM-2.4-PKZ2</b> 033725		<b>ZMR-2.4-PKZ2</b> 033955	
1	1	2	3	2.4 - 4.0	35 - 55	<b>ZM-4-PKZ2</b> 036098		<b>ZMR-4-PKZ2</b> 033957	
1 1/2	1 1/2	3	5	4.0 - 6.0	50 - 80	<b>ZM-6-PKZ2</b> 038471		<b>ZMR-6-PKZ2</b> 033966	
2	3	5	7 1/2	6 - 10	80 - 140	<b>ZM-10-PKZ2</b> 040844		<b>ZMR-10-PKZ2</b> 033967	
3	5	10	10	10 - 16	130 - 220	<b>ZM-16-PKZ2</b> 043217		<b>ZMR-16-PKZ2</b> 033968	
5	7 1/2	20	25	16 - 27	200 - 350	<b>ZM-25-PKZ2</b> 045590		<b>ZMR-25-PKZ2</b> 033969	
10	10	20	-	24 - 32	275 - 425	<b>ZM-32-PKZ2</b> 047963		<b>ZMR-32-PKZ2</b> 033973	
10	15	30	-	32 - 42	350 - 500	<b>ZM-40-PKZ2</b> 050336		<b>ZMR-40-PKZ2</b> 033975	

Notes:

- <sup>1)</sup> Set bimetal trips (yellow dial) to motor FLC
  - Tripping current = 125% of setting
  - For motors of service factor 1.0, set dial to 0.9 of motor FLC setting
  - Ambient compensated
  - Phase failure sensitive

#### UL listed / CSA certified

##### Maximum interrupting ratings

240 V AC	100 kA RMS sym.
480 Y / 277 V AC	65 kA RMS sym.
600 Y / 347 V AC	42 kA RMS sym.
up to 27 A	Suitable for maximum 600 V AC power distribution system when the voltage between any phase to ground does not exceed 347 V
up to 42 A	Suitable for maximum 480 V AC power distribution system when the voltage between any phase to ground does not exceed 277 V



# System PKZ2-SP

## Combination Starters - Self-protected FVNR

Magnetic Contactors,  
Magnetic Starters

Rating data				Adjustable current range		with ZM trip module		List Price	
UL/CSA maximum Horsepower rating (HP) 50/60Hz 3 phase				Thermal setting (set to motor FLC) <sup>1)</sup>		Type		see price list	
				Magnetic trip		Specify coil voltage and frequency, → see below		Enclosed	
								General purpose Type 1	
								Industrial use Type 12 dusttight	
								Insulating material Type 12 corrosion-resistant dusttight	
								Open without enclosure	
								Delete <input type="checkbox"/> in type	
								Replace <input type="checkbox"/> with suffix /S	
								Type 3R weather-proof	
								Replace <input type="checkbox"/> with suffix /DW	
								Replace <input type="checkbox"/> with suffix /I	

200 V HP	230 V HP	460 V HP	575 V HP	A	A
----------	----------	----------	----------	---	---



In this range, select devices in accordance with motor FLC				Adjustable current range		with ZM trip module		List Price	
				0.4 - 0.6	5 - 8	PKZ2/ZM-0.6/S-SP <input type="checkbox"/> (...)			
	1/2	1/2		0.6 - 1.0	8 - 14	PKZ2/ZM-1/S-SP <input type="checkbox"/> (...)			
	1/3	3/4	1	1.0 - 1.6	14 - 22	PKZ2/ZM-1.6/S-SP <input type="checkbox"/> (...)			
1/2	1/2	1	1 1/2	1.6 - 2.4	20 - 35	PKZ2/ZM-2.4/S-SP <input type="checkbox"/> (...)			
1	1	2	3	2.4 - 4.0	35 - 55	PKZ2/ZM-4/S-SP <input type="checkbox"/> (...)			
1 1/2	1 1/2	3	5	4.0 - 6.0	50 - 80	PKZ2/ZM-6/S-SP <input type="checkbox"/> (...)			
2	3	5	7 1/2	6 - 10	80 - 140	PKZ2/ZM-10/S-SP <input type="checkbox"/> (...)			
3	5	10	10	10 - 16	130 - 220	PKZ2/ZM-16/S-SP <input type="checkbox"/> (...)			
5	7 1/2	20	25	16 - 27	200 - 350	PKZ2/ZM-25/S-SP <input type="checkbox"/> (...)			
10	10	20	-	24 - 32	275 - 425	PKZ2/ZM-32/S-SP <input type="checkbox"/> (...)			
10	15	30	-	32 - 42	350 - 500	PKZ2/ZM-40/S-SP <input type="checkbox"/> (...)			

Notes: <sup>1)</sup> Set bimetal trips (yellow dial) to motor FLC  
 - Tripping current = 125% of setting  
 - For motors of service factor 1.0, set dial to 0.9 of motor FLC setting  
 - Ambient compensated  
 - Phase failure sensitive

**To order specify:**

- Type number
- Enclosure suffix
- Coil voltage
- Accessories

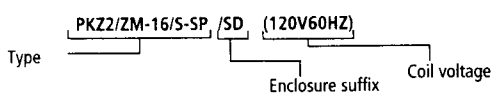

**Available Coil Voltages**

Standard voltages				Special voltages (other than the standard coils listed) <sup>1)</sup>	
24V 50Hz	24V 60Hz	110V 50Hz, 120V 60Hz	380V 50Hz, 440V 60Hz	24V 50/60Hz	...V 50Hz (24 - 600V)
48V 50Hz		190V 50Hz, 220V 60Hz	400V 50Hz, 440V 60Hz	110V 50/60Hz	...V 60Hz (24 - 600V)
240V 50Hz		220V 50Hz, 240V 60Hz	415V 50Hz, 480V 60Hz	230V 50/60Hz	

<sup>1)</sup> when ordering special coils, please state the required actuating voltage from the given range (...-...V).

# System PKZ2-SP

## Combination Starters - Self-protected FVNR

with ZMR trip module

Ty	List Price see price list			Open without enclosure
	Enclosed	Industrial use	Insulating material	
Specify coil voltage and frequency, → see below	General purpose Type 1	Type 12 dusttight	Type 12 corrosion- resistant dusttight	Delete <input type="checkbox"/> in type
	Replace <input type="checkbox"/> with suffix /S	Replace <input type="checkbox"/> with suffix /SD Type 3R weather- proof Replace <input type="checkbox"/> with suffix /DW	Replace <input type="checkbox"/> with suffix /I	

PKZ2/ZMR-0.6/S-SP <input type="checkbox"/> (...)				
PKZ2/ZMR-1/S-SP <input type="checkbox"/> (...)				
PKZ2/ZMR-1.6/S-SP <input type="checkbox"/> (...)				
PKZ2/ZMR-2.4/S-SP <input type="checkbox"/> (...)				
PKZ2/ZMR-4/S-SP <input type="checkbox"/> (...)				
PKZ2/ZMR-6/S-SP <input type="checkbox"/> (...)				
PKZ2/ZMR-10/S-SP <input type="checkbox"/> (...)				
PKZ2/ZMR-16/S-SP <input type="checkbox"/> (...)				
PKZ2/ZMR-25/S-SP <input type="checkbox"/> (...)				
PKZ2/ZMR-32/S-SP <input type="checkbox"/> (...)				
PKZ2/ZMR-40/S-SP <input type="checkbox"/> (...)				

**Notes:**

Standard features:

- UL listed, CSA certified, self-protected combination motor controller. UL 508 / CSA 22.2, No. 14 Type E.
- Factory mounted and labeled contactor and disconnect portion rated max. 42A, 30 HP at 460V; max. 27A, 25 Hp at 575V.
- No backup overcurrent protection required up to its full interrupting rating.
- Continuity of service (protects itself against damage under fault conditions).
- Plug-in trip module, which creates an open circuit path to the motor when removed. For additional safety!
- Adjustable thermal and magnetic trips; built-in phase loss differential trip.
- Built-in 1N.O. and 1 N.C. auxiliary contacts in the contactor portion.
- Electrical life: 1 million operations, AC-3 (25 HP at 575V)
- Adapter plate for rail or panel mounting.
- Control circuit transformer tap-off terminals on load side of disconnect.
- Allows mounting of accessories such as voltage trips, standard and trip indicating auxiliary contacts.
- Enclosed starters provided with door interlocking handle.
- In the event of an overload condition, the N.C. contact in the ZMR...-PKZ2 trip module opens the contactor coil circuit and the N.O. contact may be used to remotely signal an overload condition. On a short circuit, the main disconnect switch opens.

Magnetic Contactors,  
Magnetic Starters



Additional information	Page
Accessories	08/041
Factory modifications	03/046
Other operating voltages	03/034
Technical data	08/060
Dimensions	08/070
Weights	14/020

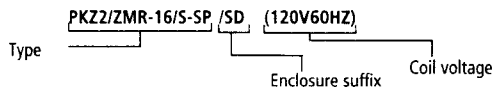

# Combination Starters Breaker Type - FVNR

Magnetic Contactors,  
Magnetic Starters

Rating data  
UL/CSA maximum Horsepower rating (HP)  
50/60Hz  
3 phase

Standard auxiliary  
contacts

Non reversing

Type

Price includes 3-phase bimetal overload relay

List Price  
see price list

Enclosed

General purpose  
Type 1  
Replace   
with suffix /S

Industrial use  
Type 12  
dusttight  
Replace   
with suffix /SD  
Type 3R  
weatherproof  
Replace   
with suffix /  
DW

Insulating  
material  
Type 12  
corrosion-resis-  
tant, dusttight  
Replace  with  
suffix /I

Specify coil voltage and frequency,  
→ page 03/065, 066

Specify overload  
relay suffix,  
→ page 03/023

200 V HP	230 V HP	460 V HP	575 V HP	N.O.	N.C.
-------------	-------------	-------------	-------------	------	------



200 V HP	230 V HP	460 V HP	575 V HP	N.O.	N.C.	Type	General purpose	Industrial use	Insulating material
3	3	5	7 1/2	1	1	M00M/11/ZM/Z00-... <input type="checkbox"/> (...)			
-	-	7 1/2	10	1	1	M00AM/11/ZM/Z00-... <input type="checkbox"/> (...)			
-	7 1/2	10	15	1	1	M0M/11/ZM/Z00-... <input type="checkbox"/> (...)			
7 1/2	10	15	20	1	1	M0AM/11/ZM6/Z...-... <input type="checkbox"/> (...)			
10	-	20	25	1	1	M1M/11/ZM6/Z1-40 <input type="checkbox"/> (...)			
-	15	25	30	1	1	M1AM/11/ZM6/Z1-... <input type="checkbox"/> (...)			
15	20	40	40	1	1	M2M/11/ZM6/Z1-57 <input type="checkbox"/> (...)			
20	25	50	50	1	1	M2AM/11/ZM6/Z1-... <input type="checkbox"/> (...)			
25	30	60	75	1	1	M3M80/11/ZM6/Z5-... <input type="checkbox"/> (...)			
30	-	75	100	2	2	M4M115/22/ZM6/Z5-100 <input type="checkbox"/> (...)			
-	40	-	-	2	2	M4M115/22/ZM6/Z5-125 <input type="checkbox"/> (...)			
40	50	100	125	2	2	M4M115/22/ZM9/Z5-... <input type="checkbox"/> (...)			
50	60	125	150	2	2	MM185/22/ZM9/Z5-160 <input type="checkbox"/> (...)			
60	75	150	200	2	2	MM225/22/ZM9/Z5-220 <input type="checkbox"/> (...)			
75	100	200	250	2	2	MM250/22/ZM10/Z5-... <input type="checkbox"/> (...)			
100	125	250	300	2	2	MM300/22/ZM10/ZW7-... <input type="checkbox"/> (...)			
125	150	250	300	2	2	MM400/22/ZM10/ZW7-400 <input type="checkbox"/> (...)			

To order specify:

- Type number
- Overload relay suffix
- Enclosure suffix
- Coil voltage
- Accessories

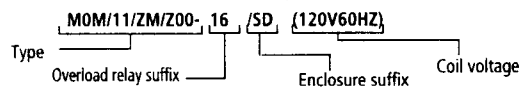

# Combination Reversing Starters

## Breaker Type - FVR

### Reversing

Technical data  
UL/CSA maximum Horsepower rating (HP)  
50/60Hz  
3 phase

Standard auxiliary contacts

Type

Price includes 3-phase bimetal overload relay

List Price  
see price list

### Enclosed

General purpose  
Type 1  
Replace  with suffix /S

Industrial use  
Type 12  
dusttight  
Replace  with suffix /SD  
Type 3R  
weatherproof  
Replace  with suffix /DW

Insulating material  
Type 12  
corrosion-resistant, dusttight  
Replace  with suffix /I

Specify coil voltage and frequency,  
→ page 03/065, 066

Specify overload relay suffix,  
→ page 03/023

200 V HP	230 V HP	460 V HP	575 V HP	N.O.	N.C.
-------------	-------------	-------------	-------------	------	------

200 V HP	230 V HP	460 V HP	575 V HP	N.O.	N.C.	Type	Enclosed	Insulating material
3	3	5	7 1/2	1	1	MW00M/11/ZM/Z00-... <input type="checkbox"/> (...)		
-	-	7 1/2	10	1	1	MW00AM/11/ZM/Z00-... <input type="checkbox"/> (...)		
-	7 1/2	10	15	1	1	MW0M/11/ZM/Z00-... <input type="checkbox"/> (...)		
7 1/2	10	15	20	1	1	MW0AM/11/ZM6/Z...-... <input type="checkbox"/> (...)		
10	-	20	25	1	1	MW1M/11/ZM6/Z1-40 <input type="checkbox"/> (...)		
-	15	25	30	1	1	MW1AM/11/ZM6/Z1-... <input type="checkbox"/> (...)		
15	20	40	40	1	1	MW2M/11/ZM6/Z1-57 <input type="checkbox"/> (...)		
-	25	50	50	1	1	MW2AM/11/ZM6/Z1-... <input type="checkbox"/> (...)		
25	30	60	75	1	1	MW3M80/11/ZM6/Z5-... <input type="checkbox"/> (...)		
30	-	75	100	2	2	MW4M115/22/ZM6/Z5-100 <input type="checkbox"/> (...)		
-	40	-	-	2	2	MW4M115/22/ZM6/Z5-125 <input type="checkbox"/> (...)		
40	50	100	125	2	2	MW4M115/22/ZM9/Z5-... <input type="checkbox"/> (...)		
50	60	125	150	2	2	MWM185/22/ZM9/Z5-160 <input type="checkbox"/> (...)		
60	75	150	200	2	2	MWM225/22/ZM9/Z5-220 <input type="checkbox"/> (...)		
75	100	200	250	2	2	MWM250/22/ZM10/Z5-... <input type="checkbox"/> (...)		
100	125	250	300	2	2	MWM300/22/ZM10/ZW7-... <input type="checkbox"/> (...)		
125	150	250	300	2	2	MWM400/22/ZM10/ZW7-400 <input type="checkbox"/> (...)		

Magnetic Contactors,  
Magnetic Starters



### To order specify:

- Type number
- Overload relay suffix
- Enclosure suffix
- Coil voltage
- Accessories

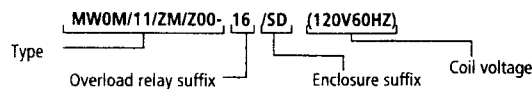

## Combination Starters - Fusible Disconnect Switch Type with fuse holders for HRC I-J fuses

Magnetic Contactors,  
Magnetic Starters

UL/CSA max. Hp rating  
50/60Hz  
3 phase

Discon- Fuse  
nect Clip  
Switch Size <sup>1)</sup>

Standard  
auxiliary  
contacts

**Type**  
Specify coil voltage and frequency  
→ pages 03/065, 066

Specify overload  
relay suffix code  
→ page 03/023

Price includes 3 phase, bimetallic overload relay

**Enclosed**

General  
purpose  
Type 1  
Replace  with suffix /S

Industrial use  
Type 12  
dusttight  
Replace  with  
suffix /SD  
Type 3R  
weatherproof  
Replace  with  
suffix /DW

Insulating  
material  
Type 12  
corrosion-  
resistant  
dusttight  
Replace  with  
suffix /I

200 V 230 V 460 V 575 V

HP HP HP HP A A N.O. N.C.

see price list see price list see price list

200 V	230 V	460 V	575 V	A	A	N.O.	N.C.	Type	...	(...)
3	3	5	7 1/2	30	30	1	1	M00M/11/P2-30FC23/Z00-... <input type="checkbox"/> (...)		
-	-	7 1/2	10	30	30	1	1	M00AM/11/P2-30FC23/Z00-... <input type="checkbox"/> (...)		
5	5	10	15	30	30	1	1	M0M/11/P2-30FC23/Z00-... <input type="checkbox"/> (...)		
7 1/2	7 1/2	-	-	30	60	1	1	M0M/11/P2-30FC26/Z00-... <input type="checkbox"/> (...)		
-	-	15	20	30	30	1	1	M0AM/11/P2-30FC23/Z00-... <input type="checkbox"/> (...)		
-	10	-	-	30	60	1	1	M0AM/11/P2-30FC26/Z1-... <input type="checkbox"/> (...)		
-	-	20	25	30	60	1	1	M1M/11/P2-30FC26/Z1-... <input type="checkbox"/> (...)		
10	-	-	-	60	60	1	1	M1M/11/P2-60FC26/Z1-... <input type="checkbox"/> (...)		
-	15	25	30	60	60	1	1	M1AM/11/P2-60FC26/Z1-... <input type="checkbox"/> (...)		
-	-	30	40	60	60	1	1	M2M/11/P2-60FC26/Z1-... <input type="checkbox"/> (...)		
15	20	40	-	60	100	1	1	M2M/11/P2-60FC110/Z1-... <input type="checkbox"/> (...)		
-	-	-	50	60	100	1	1	M2AM/11/P2-60FC110/Z1-... <input type="checkbox"/> (...)		
20	25	50	-	100	100	1	1	M2AM/11/P2-100FC110/Z1-... <input type="checkbox"/> (...)		
25	-	-	60	100	100	1	1	M3M80/11/P2-100FC110/Z5-100 <input type="checkbox"/> (...)		
-	30	60	75	100	200	1	1	M3M80/11P2-100+62003J/Z5-100 <input type="checkbox"/> (...)		
30	-	75	100	100	200	2	2	M4M115/22/N6-100+62003J/Z5-100 <input type="checkbox"/> (...)		
40	-	-	125	150	200	2	2	M4M115/22/N6-160+62003J/Z5-125 <input type="checkbox"/> (...)		
-	50	100	-	150	200	2	2	M4M115/22/N6-160+62003J/Z5-150 <input type="checkbox"/> (...)		
50	-	-	150	250	200	2	2	MM185/22/N9-250+62003J/Z5-160 <input type="checkbox"/> (...)		
-	60	125	-	250	400	2	2	MM185/22/N9-250+62003J/Z5-160 <input type="checkbox"/> (...)		

Notes:

- 1) Recommended Class J time-delay fuse ampacity.  
Range: 1.25 - 1.5 x motor full load current
- 2) Contact Moeller Electric for larger sizes

**To order specify:**

- Type number
- Overload relay suffix
- Enclosure suffix
- Coil voltage
- Accessories

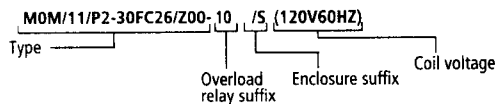

Additional information	Page
Technical data	03/080
Dimensions	03/091
Overload relays	04/004
Accessories	03/053
Factory modifications	03/046
Weights	14/020

# Combination Starters - Fusible Disconnect Switch Type with fuse holders for HRC II-C fuses

UL/CSA max. Hp rating 50/60Hz 3 phase	Discon- nect Switch	Fuse Clip Size	Standard auxiliary contacts	Type Specify coil voltage and frequency → pages 03/065, 066  Specify overload relay suffix code → page 03/023	Price includes 3 phase, bimetallic overload relay Enclosed		
200 V 230 V 460 V 575 V	A	A	N.O. N.C.	... (...)	General purpose Type 1 Replace <input type="checkbox"/> with suffix /S	Industrial use Type 12 dusttight Replace <input type="checkbox"/> with suffix /SD Type 3R weatherproof Replace <input type="checkbox"/> with suffix /DW	Insulating material Type 12 corrosion- resistant dusttight Replace <input type="checkbox"/> with suffix /I

HP	HP	HP	HP	A	A	N.O.	N.C.	Type	...	(...)	see price list	see price list	see price list
3	3	5	7 1/2	30	30	1	1	M00M/11/P2-30F-E/Z00-... <input type="checkbox"/> (...)					
-	-	7 1/2	10	30	30	1	1	M00AM/11/P2-30F-E/Z00-... <input type="checkbox"/> (...)					
5	5	10	15	30	30	1	1	M0M/11/P2-30F-E/Z00-... <input type="checkbox"/> (...)					
7 1/2	7 1/2	-	-	30	60	1	1	M0M/11/P2-30F-E/Z00-... <input type="checkbox"/> (...)					
-	-	15	20	30	60	1	1	M0AM/11/P2-30F-E/Z00-... <input type="checkbox"/> (...)					
-	10	-	-	30	60	1	1	M0AM/11/P2-30F-E/Z1-... <input type="checkbox"/> (...)					
-	-	20	25	30	60	1	1	M1M/11/P2-30F-E/Z1-... <input type="checkbox"/> (...)					
10	-	-	-	60	60	1	1	M1M/11/P2-60F-E/Z1-... <input type="checkbox"/> (...)					
-	15	25	30	60	100	1	1	M1AM/11/P2-60F-E/Z1-... <input type="checkbox"/> (...)					
15	20	40	40	60	100	1	1	M2M/11/P2-60F-E/Z1-... <input type="checkbox"/> (...)					
-	-	-	50	60	100	1	1	M2AM/11/P2-60F-E/Z1-... <input type="checkbox"/> (...)					
20	-	50	-	100	100	1	1	M2AM/11/P2-100F-E/Z1-... <input type="checkbox"/> (...)					
-	25	-	-	100	200	1	1	M2AM/11/P2-100+GS402/Z1-... <input type="checkbox"/> (...)					
-	-	-	60	100	100	1	1	M3M80/11/P2-100F-E/Z5-... <input type="checkbox"/> (...)					
25	30	60	75	100	200	1	1	M3M80/11/P2-100+GS402/Z5-... <input type="checkbox"/> (...)					
30	-	75	100	100	200	2	2	M4M115/22/N6-100+GS402/Z5-100 <input type="checkbox"/> (...)					
40	50	100	125	150	200	2	2	M4M115/22/N6-160+GS402/Z5-... <input type="checkbox"/> (...)					
50	-	-	-	250	200	2	2	MM185/22/N9-GSG203/303/Z5-160 <input type="checkbox"/> (...)					
-	60	125	150	250	400	2	2	MM185/22/N9-GSG203/303/Z5-160 <input type="checkbox"/> (...)					
60	75	150	200	250	400	2	2	MM225/22/N9-GSG203/303/Z5-220 <input type="checkbox"/> (...)					
-	100	200	250	400	400	2	2	MM250/22/NZM10-GSG402/303/Z5-250 <input type="checkbox"/> (...)					

Magnetic Contactors,  
Magnetic Starters



**To order specify:**

- Type number
- Overload relay suffix
- Enclosure suffix
- Coil voltage
- Accessories

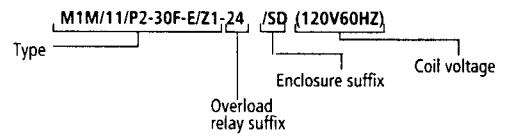

Additional information	Page
Technical data	03/080
Dimensions	03/091
Overload relays	04/004
Accessories	03/053
Factory modifications	03/046
Weights	14/020

## Combination Starters - Fusible Disconnect Switch Type with fuse holders for HRC I-R fuses

UL/CSA max. Hp rating 50/60Hz 3 phase				Discon- nect Switch	Fuse Clip Size <sup>1)</sup>	Standard auxiliary contacts	Type Specify coil voltage and frequency → pages 03/065, 066	Price includes 3 phase, bimetallic overload relay <b>Enclosed</b>				
200 V	230 V	460 V	575 V	A	A	N.O.	N.C.	...	(...)	see price list	see price list	see price list
HP	HP	HP	HP									
3	3	-	-	30	30	1	1	M00M/11/P2-30FC33/Z00-... □ (...)				
-	-	5	7 1/2	30	30	1	1	M00M/11/P2-30FC43/Z00-... □ (...)				
-	-	7 1/2	10	30	30	1	1	M00AM/11/P2-30FC43/Z00-... □ (...)				
7 1/2	7 1/2	-	-	30	30	1	1	M0M/11/P2-30FC33/Z00-... □ (...)				
-	-	10	15	30	30	1	1	M0M/11/P2-30FC43/Z00-... □ (...)				
-	-	-	-	30	60	1	1	M0M/11/P2-30FC43/Z00-... □ (...)				
-	-	-	-	30	60	1	1	M0M/11/P2-30FC46/Z00-... □ (...)				
-	10	-	-	30	60	1	1	M0AM/11/P2-30FC43/Z1-... □ (...)				
-	-	15	20	30	30	1	1	M0AM/11/P2-30FC43/Z00-... □ (...)				
-	-	-	-	30	60	1	1	M0AM/11/P2-30FC46/Z00-... □ (...)				
10	-	-	-	60	60	1	1	M1M/11/P2-60FC43/Z1-... □ (...)				
-	-	20	25	30	60	1	1	M1M/11/P2-30FC46/Z1-... □ (...)				
-	15	-	-	60	60	1	1	M1AM/11/P2-60FC43/Z1-... □ (...)				
-	-	-	-	60	100	1	1	M1AM/11/P2-60FC310/Z1-... □ (...)				
-	-	25	30	60	60	1	1	M1AM/11/P2-60FC46/Z1-... □ (...)				
15	20	-	-	60	60	1	1	M2M/11/P2-60FC43/Z1-... □ (...)				
-	-	-	-	60	100	1	1	M2M/11/P2-60FC310/Z1-... □ (...)				
-	-	40	40	60	60	1	1	M2M/11/P2-60FC46/Z1-... □ (...)				
-	-	-	-	60	100	1	1	M2M/11/P2-60FC310/Z1-... □ (...)				
20	25	50	-	100	100	1	1	M2AM/11/P2-100FC310/Z1-... □ (...)				
-	-	-	-	100	200	1	1	M2AM/11/P2-100+R200/Z1-... □ (...)				
-	-	-	50	60	100	1	1	M2AM/11/P2-60FC310/Z1-... □ (...)				
25	30	60	75	100	100	1	1	M3M80/11/P2-100FC310/Z5-100 □ (...)				
-	-	-	-	100	200	1	1	M3M80/11/P2-100-R200/Z5-100 □ (...)				
30	-	75	100	100	200	2	2	M4M115/22/N6-100-R200/Z5-100 □ (...)				
40	40	100	125	125	200	2	2	M4M115/22/N6-160-R200/Z5-100 □ (...)				
-	50	-	-	250	200	2	2	M4M115/22/N9-R200/Z5-150 □ (...)				
-	-	-	-	250	400	2	2	M4M115/22/N9-R400/Z5-150 □ (...)				

Notes:

- 1) Recommended Class R rejection-time-delay fuse ampacity  
Range: 1.25 - 1.5 x motor full load current
- 2) Contact Moeller Electric for larger sizes

**To order specify:**

- Type number
- Overload relay suffix
- Enclosure suffix
- Coil voltage
- Accessories

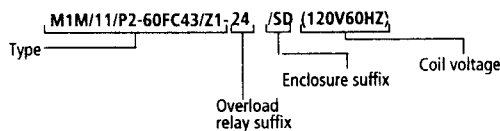

Additional information	Page
Technical data	03/080
Dimensions	03/091
Overload relays	04/004
Accessories	03/053
Factory modifications	03/046
Weights	14/020



# Combination Starters - Non-fusible Disconnect Switch Type

Magnetic Contactors  
Magnetic Starters

UL/CSA max. Hp rating 50/60Hz 3 phase	Disconnect Switch	Standard auxiliary contacts	<b>Type</b> Specify coil voltage and frequency → pages 03/065, 066	Price includes 3 phase, bimetallic overload relay			
			Specify overload relay suffix code → page 03/023	<b>Enclosed</b>	General purpose Type 1 Replace <input type="checkbox"/> with suffix /S	Industrial use Type 12 dusttight Replace <input type="checkbox"/> with suffix /SD Type 3R weatherproof Replace <input type="checkbox"/> with suffix /DW	Insulating material Type 12 corrosion-resistant dusttight Replace <input type="checkbox"/> with suffix /I
200 V   230 V   460 V   575 V	A	N.O.   N.C.	...   (...)	see price list	see price list	see price list	

3	3	5	7 ½	30	1	1	M00M/11/P2-30/Z00-... <input type="checkbox"/> (...)			
-	-	7 ½	10	30	1	1	M00AM/11/P2-30Z00-... <input type="checkbox"/> (...)			
7 ½	7 ½	10	15	30	1	1	M0M/11/P2-30/Z00-... <input type="checkbox"/> (...)			
-	-	15	20	30	1	1	M0AM/11/P2-30/Z00-... <input type="checkbox"/> (...)			
-	10	-	-	30	1	1	M0AM/11/P2-30/Z1-... <input type="checkbox"/> (...)			
-	-	20	25	30	1	1	M1M/11/P2-30/Z1-... <input type="checkbox"/> (...)			
10	-	-	-	60	1	1	M1M/11/P2-60/Z1-... <input type="checkbox"/> (...)			
-	15	25	30	60	1	1	M1AM/11/P2-60/Z1-... <input type="checkbox"/> (...)			
15	20	40	40	60	1	1	M2M/11/P2-60/Z1-... <input type="checkbox"/> (...)			
-	-	-	50	60	1	1	M2AM/11/P2-60/Z1-... <input type="checkbox"/> (...)			
20	25	50	-	100	1	1	M2AM/11/P2-100/Z1-... <input type="checkbox"/> (...)			
25	30	60	75	100	1	1	M3M80/11/P2-100/Z5-... <input type="checkbox"/> (...)			
30	-	75	100	100	2	2	M4M115/22/N6-100/Z5-100 <input type="checkbox"/> (...)			
40	40	100	-	125	2	2	M4M115/22/N6-160/Z5-100 <input type="checkbox"/> (...)			
-	50	-	-	250	2	2	M4M115/22/N9/Z5-150 <input type="checkbox"/> (...)			

- To order specify:**
- Type number
  - Overload relay suffix
  - Enclosure suffix
  - Coil voltage
  - Accessories

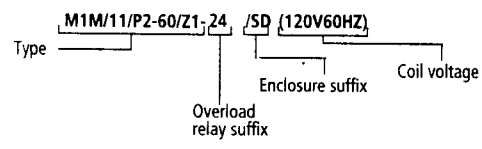

Additional information	Page
Technical data	03/080
Dimensions	03/091
Overload relays	04/004
Accessories	03/053
Factory modifications	03/046
Weights	14/020

## Combination Reversing Starters - Fusible Disconnect Switch Type with fuse holders for HRC I-J fuses

UL/CSA max. Hp rating  
50/60Hz  
3 phase

Discon- Fuse  
nect Clip  
Switch Size <sup>1)</sup>

Standard  
auxiliary  
contacts

**Type**  
Specify coil voltage and frequency  
→ pages 03/065, 066

Specify overload  
relay suffix code  
→ page 03/023

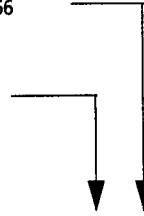

Price includes 3 phase, bimetallic overload relay  
**Enclosed**

General  
purpose  
Type 1  
Replace   
with suffix /S

Industrial use  
Type 12  
dusttight  
Replace  with  
suffix /SD  
Type 3R  
weatherproof  
Replace  with  
suffix /DW

Insulating material  
Type 12  
corrosion-resistant  
dusttight  
Replace  with  
suffix /I

200 V 230 V 460 V 575 V

HP	HP	HP	HP	A	A	N.O.	N.C.	Type	...	(...)	see price list	see price list	see price list
3	3	5	7 1/2	30	30	1	1	MW00M/11/P2-30FC23/Z00-... <input type="checkbox"/> (...)					
-	-	7 1/2	10	30	30	1	1	MW00AM/11/P2-30FC23/Z00-... <input type="checkbox"/> (...)					
5	7 1/2	10	15	30	30	1	1	MW0M/11/P2-30FC23/Z00-... <input type="checkbox"/> (...)					
7 1/2	-	-	-	30	60	1	1	MW0M/11/P2-30FC23/Z00-... <input type="checkbox"/> (...)					
-	-	15	20	30	30	1	1	MW0AM/11/P2-30FC23/Z00-... <input type="checkbox"/> (...)					
-	10	-	-	30	60	1	1	MW0AM/11/P2-30FC26/Z00-... <input type="checkbox"/> (...)					
-	-	20	25	30	60	1	1	MW1M/11/P2-30FC26/Z1-... <input type="checkbox"/> (...)					
10	-	-	-	60	60	1	1	MW1M/11/P2-60FC26/Z1-... <input type="checkbox"/> (...)					
-	15	25	30	60	60	1	1	MW1AM/11/P2-60FC26/Z1-... <input type="checkbox"/> (...)					
-	-	-	40	60	100	1	1	MW1AM/11/P2-60FC110/Z1-... <input type="checkbox"/> (...)					
-	-	-	40	60	60	1	1	MW2M/11/P2-60FC26/Z1-... <input type="checkbox"/> (...)					
15	20	40	-	60	100	1	1	MW2M11/P2-60FC110/Z1-... <input type="checkbox"/> (...)					
-	-	-	50	60	100	1	1	MW2AM/11/P2-60FC110/Z1-... <input type="checkbox"/> (...)					
20	25	50	-	100	100	1	1	MW2AM/11/P2-100FC110/Z1-... <input type="checkbox"/> (...)					
25	-	-	60	100	100	1	1	MW3M80/11/P2-100FC110/Z5-100 <input type="checkbox"/> (...)					
-	30	60	75	100	200	1	1	MW3M80/11/P2-100+62003J/Z5-100 <input type="checkbox"/> (...)					



**Notes:**

- 1) Recommended Class J time-delay fuse ampacity  
Range: 1.25 - 1.5 x motor full load current
- 2) Contact Moeller Electric for larger sizes

**To order specify:**

- Type number
- Overload relay suffix
- Enclosure suffix
- Coil voltage
- Accessories

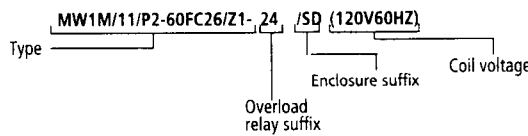

Additional information	Page
Technical data	03/080
Dimensions	03/091
Overload relays	04/004
Accessories	03/053
Factory modifications	03/046
Weights	14/020

# Combination Reversing Starters - Fusible Disconnect Switch Type with fuse holders for HRC II-C fuses

Magnetic Contactors,  
Magnetic Starters

UL/CSA max. Hp rating 50/60Hz 3 phase	Discon- nect Switch	Fuse Clip Size	Standard auxiliary contacts	<b>Type</b> Specify coil voltage and frequency → pages 03/065, 066  Specify overload relay suffix code → page 03/023	Price includes 3 phase, bimetallic overload relay <b>Enclosed</b>  General purpose Type 1 Replace <input type="checkbox"/> with suffix /S  Industrial use Type 12 dusttight Replace <input type="checkbox"/> with suffix /SD Type 3R weatherproof Replace <input type="checkbox"/> with suffix /DW  Insulating material Type 12 corrosion-resistant dusttight Replace <input type="checkbox"/> with suffix /I
---	---------------------------	-------------------	-----------------------------------	--	---

200 V	230 V	460 V	575 V	A	A	N.O.	N.C.	Type	...	(...)	see price list	see price list	see price list
3	3	5	7 1/2	30	30	1	1	MW00M/11/P2-30F-E/Z00-... <input type="checkbox"/> (...)					
-	-	7 1/2	10	30	30	1	1	MW00AM/11/P2-30F-E/Z00-... <input type="checkbox"/> (...)					
5	5	10	15	30	30	1	1	MW0M/11/P2-30F-E/Z00-... <input type="checkbox"/> (...)					
7 1/2	7 1/2	-	-	30	60	1	1	MW0M/11/P2-30F-E/Z00-... <input type="checkbox"/> (...)					
-	-	15	20	30	60	1	1	MW0AM/11/P2-30F-E/Z00-... <input type="checkbox"/> (...)					
-	10	-	-	30	60	1	1	MW0AM/11/P2-30F-E/Z1-... <input type="checkbox"/> (...)					
-	-	20	25	30	60	1	1	MW1M/11/P2-30F-E/Z1-... <input type="checkbox"/> (...)					
10	-	-	-	60	60	1	1	MW1M/11/P2-60F-E/Z1-... <input type="checkbox"/> (...)					
-	15	25	30	60	100	1	1	MW1AM/11/P2-60F-E/Z1-... <input type="checkbox"/> (...)					
15	20	40	40	60	100	1	1	MW2M/11/P2-60F-E/Z1-... <input type="checkbox"/> (...)					
-	-	-	50	60	100	1	1	MW2AM/11/P2-60F-E/Z1-... <input type="checkbox"/> (...)					
20	-	50	-	100	100	1	1	MW2AM/11/P2-100F-E/Z1-... <input type="checkbox"/> (...)					
-	25	-	-	100	200	1	1	MW2AM/11/P2-100+GS402/Z1-... <input type="checkbox"/> (...)					
-	-	-	60	100	100	1	1	MW3M80/11/P2-100F-E/Z5-... <input type="checkbox"/> (...)					
25	30	60	75	100	200	1	1	MW3M80/11/P2-100+GS402/Z5-... <input type="checkbox"/> (...)					



**To order specify:**

- Type number
- Overload relay suffix
- Enclosure suffix
- Coil voltage
- Accessories

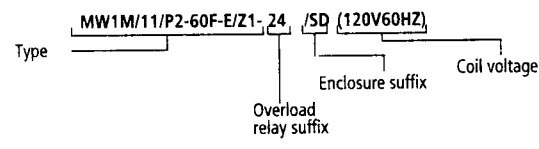

Additional information	Page
Technical data	03/080
Dimensions	03/091
Overload relays	04/004
Accessories	03/053
Factory modifications	03/046
Weights	14/020

# Combination Reversing Starters - Fusible Disconnect Switch Type with fuse holders for HRC I-R fuses

UL/CSA max. Hp rating  
50/60Hz  
3 phase

Discon- Fuse  
nect Clip  
Switch Size <sup>1)</sup>

Standard  
auxiliary  
contacts

**Type**  
Specify coil voltage and frequency  
→ pages 03/065, 066

Specify overload  
relay suffix code  
→ page 03/023

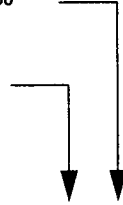

Price includes 3 phase, bimetallic overload relay

**Enclosed**

General  
purpose  
Type 1  
Replace  with  
suffix /S

Industrial use  
Type 12  
dusttight  
Replace  with  
suffix /SD  
Type 3R  
weatherproof  
Replace  with  
suffix /DW

Insulating material  
Type 12  
corrosion-resistant  
dusttight  
Replace  with  
suffix /I

200 V 230 V 460 V 575 V

HP	HP	HP	HP	A	A	N.O.	N.C.	Type	...	(...)	see price list	see price list	see price list
3	3	-	-	30	30	1	1	MW00M/11/P2-30FC33/Z00-... <input type="checkbox"/> (...)					
-	-	5	7 1/2	30	30	1	1	MW00M/11/P2-30FC43/Z00-... <input type="checkbox"/> (...)					
-	-	7 1/2	10	30	30	1	1	MW00AM/11/P2-30FC43/Z00-... <input type="checkbox"/> (...)					
7 1/2	7 1/2	-	-	30	30	1	1	MW0M/11/P2-30FC33/Z00-... <input type="checkbox"/> (...)					
-	-	-	-	30	60	1	1	MW0M/11/P2-30FC43/Z00-... <input type="checkbox"/> (...)					
-	-	10	15	30	30	1	1	MW0M/11/P2-30FC43/Z00-... <input type="checkbox"/> (...)					
-	-	-	-	30	60	1	1	MW0M/11/P2-30FC46/Z00-... <input type="checkbox"/> (...)					
-	10	-	-	30	60	1	1	MW0AM/11/P2-30FC43/Z1-... <input type="checkbox"/> (...)					
-	-	15	20	30	30	1	1	MW0AM/11/P2-30FC43/Z00-... <input type="checkbox"/> (...)					
-	-	-	-	30	60	1	1	MW0AM/11/P2-30FC46/Z00-... <input type="checkbox"/> (...)					
10	-	-	-	60	60	1	1	MW1M/11/P2-60FC43/Z1-... <input type="checkbox"/> (...)					
-	-	20	25	30	60	1	1	MW1M/11/P2-30FC46/Z1-... <input type="checkbox"/> (...)					
-	15	-	-	60	60	1	1	MW1AM/11/P2-60FC43/Z1-... <input type="checkbox"/> (...)					
-	-	-	-	60	100	1	1	MW1AM/11/P2-60FC310/Z1-... <input type="checkbox"/> (...)					
-	-	25	30	60	60	1	1	MW1AM/11/P2-60FC46/Z1-... <input type="checkbox"/> (...)					
15	20	-	-	60	60	1	1	MW2M/11/P2-60FC43/Z1-... <input type="checkbox"/> (...)					
-	-	-	-	60	100	1	1	MW2M/11/P2-60FC310/Z1-... <input type="checkbox"/> (...)					
-	-	40	40	60	60	1	1	MW2M/11/P2-60FC46/Z1-... <input type="checkbox"/> (...)					
-	-	-	-	60	100	1	1	MW2M/11/P2-60FC310/Z1-... <input type="checkbox"/> (...)					
20	25	50	-	100	100	1	1	MW2AM/11/P2-100FC310/Z1-... <input type="checkbox"/> (...)					
-	-	-	-	100	200	1	1	MW2AM/11/P2-100+R200/Z1-... <input type="checkbox"/> (...)					
-	-	-	50	60	100	1	1	MW2AM/11/P2-60FC310/Z1-... <input type="checkbox"/> (...)					
25	30	60	75	100	100	1	1	MW3M80/11/P2-100FC310/Z5-100 <input type="checkbox"/> (...)					
-	-	-	-	100	200	1	1	MW3M80/11/P2-100-R200/Z5-100 <input type="checkbox"/> (...)					
30	-	75	100	100	200	2	2	MW4M115/22/N6-100-R200/Z5-100 <input type="checkbox"/> (...)					
40	40	100	125	125	200	2	2	MW4M115/22/N6-160-R200/Z5-100 <input type="checkbox"/> (...)					
-	50	-	-	250	200	2	2	MW4M115/22/N9-R200/Z5-150 <input type="checkbox"/> (...)					
-	-	-	-	250	400	2	2	MW4M115/22/N9-R400/Z5-150 <input type="checkbox"/> (...)					

Notes: <sup>1)</sup> Recommended Class R rejection-time-delay fuse ampacity  
Range: 1.25 - 1.5 x motor full load current  
<sup>2)</sup> Contact Moeller Electric for larger sizes

**To order specify:**

- Type number
- Overload relay suffix
- Enclosure suffix
- Coil voltage
- Accessories

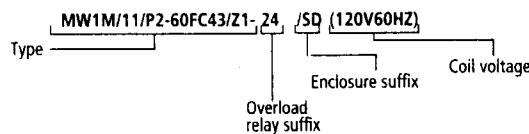

**Additional information**

Additional information	Page
Technical data	03/080
Dimensions	03/091
Overload relays	04/004
Accessories	03/053
Factory modifications	03/046
Weights	14/020

# Combination Reversing Starters - Non-fusible Disconnect Switch Type

UL/CSA max. Hp rating  
50/60Hz  
3 phase

Disconnect  
Switch

Standard  
auxiliary  
contacts

**Type**  
Specify coil voltage and frequency  
→ pages 03/065, 066

Specify overload  
relay suffix code  
→ page 03/023

Price includes 3 phase, bimetallic overload relay

**Enclosed**

General  
purpose  
Type 1

Replace  with  
suffix /S

Industrial use  
Type 12  
dusttight

Replace  with  
suffix /SD

Type 3R  
weatherproof  
Replace  with  
suffix /DW

Insulating material  
Type 12  
corrosion-resistant

dusttight  
Replace  with  
suffix /I

200 V 230 V 460 V 575 V

HP	HP	HP	HP	A	N.O.	N.C.	...	(...)	see price list	see price list	see price list
3	3	5	7 1/2	30	1	1	MW00M/11/P2-30/Z00-... <input type="checkbox"/> (...)				
-	-	7 1/2	10	30	1	1	MW00AM/11/P2-30Z00-... <input type="checkbox"/> (...)				
7 1/2	7 1/2	10	15	30	1	1	MW0M/11/P2-30/Z00-... <input type="checkbox"/> (...)				
-	-	15	20	30	1	1	MW0AM/11/P2-30/Z00-... <input type="checkbox"/> (...)				
-	10	-	-	30	1	1	MW0AM/11/P2-30/Z1-... <input type="checkbox"/> (...)				
-	-	20	25	30	1	1	MW1M/11/P2-30/Z1-... <input type="checkbox"/> (...)				
10	-	-	-	60	1	1	MW1M/11/P2-60/Z1-... <input type="checkbox"/> (...)				
-	15	25	30	60	1	1	MW1AM/11/P2-60/Z1-... <input type="checkbox"/> (...)				
15	20	40	40	60	1	1	MW2M/11/P2-60/Z1-... <input type="checkbox"/> (...)				
-	-	-	50	60	1	1	MW2AM/11/P2-60/Z1-... <input type="checkbox"/> (...)				
20	25	50	-	100	1	1	MW2AM/11/P2-100/Z1-... <input type="checkbox"/> (...)				
25	30	60	75	100	1	1	MW3M80/11/P2-100/Z5-... <input type="checkbox"/> (...)				

Notes: <sup>1)</sup> Contact Moeller Electric for larger sizes

**To order specify:**

- Type number
- Overload relay suffix
- Enclosure suffix
- Coil voltage
- Accessories

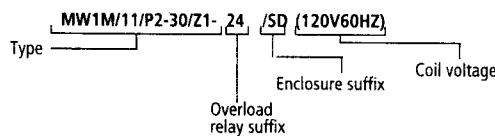

**Additional information**

Additional information	Page
Technical data	03/080
Dimensions	03/091
Overload relays	04/004
Accessories	03/053
Factory modifications	03/046
Weights	14/020

Magnetic Contactors, Magnetic Starters



# Full Voltage Starters

## Factory Modifications

### Ordering information

#### Order by description

The standard modifications shown on this page are those available for factory installation. Prices for these modifications are shown in the alpha-numeric price list XK0211-2001/2002-CDN, under "Full Voltage Starters - Factory Modifications".

The enclosure may or may not change with the addition of any of these items. When accurate dimensions of the enclosure are required, please contact your nearest Moeller Electric branch.

Description	Enclosure type	List Price Adder all sizes see price list
<b>Pilot devices in cover</b>		
<b>Pushbuttons</b>		
"START-STOP" or "ON-OFF" Double pushbutton	1 12, 13, 3R, 4X	
"START-STOP" or "ON-OFF" Double pushbutton with indicating light	1 12, 13, 3R, 4X	
Standard 1-unit pushbutton	all types	
Standard 2-unit pushbutton	all types	
Standard 3-unit pushbutton	all types	
<b>Selector switches</b>		
"HAND-AUTO"	1 12, 13, 3R, 4X	
"HAND-O-AUTO"	1 12, 13, 3R, 4X	
<b>Indicating lights</b>		
Indicating light - specify color	1 12, 13, 3R, 4X	
Push-to-test light or illuminated pushbutton	all types	

Description	List Price Adder all sizes see price list
<b>Added devices</b>	
<b>Electrical interlocks</b>	
For standard auxiliary contacts, supplied with equipment at no extra charge. Additional auxiliary contacts N.O. or N.C.	per contact
<b>Overload relays</b>	
Overload relay, automatic/manual reset and alarm contacts supplied as standard	no charge
P.T.C. thermistor tripping unit	type EMT6
<b>Control circuit</b>	
Separate control circuit	no charge
Fused control circuit	250V, 1 or 2 fuses 600V, 2 fuses
<b>Auxiliary relays</b>	
Control relay, max. of 4 poles	unwired wired
Timing relay	
Terminal block, wired	per pole
<b>Auxiliary relays for multi-speed starters only</b>	
Compelling relay	
Accelerating relay	2 speed
Time decelerating relay	2 speed
Phase reversal and failure relay	
<b>Nameplates</b>	
Special nameplates	3" x 1"

Description	Price Adder for contactor size							
	00M 00AM 0M	0AM 1M 1AM	2M 2AM	3M80	4M115	M185	M250	M300
	see price list	see price list	see price list	see price list	see price list	see price list	see price list	see price list

#### Control circuit transformers

Transformer 60 Hz with fused secondary

Transformer with additional capacity up to 100VA, 60 Hz with fused secondary

#### Overload relay

omit overload relay - deduct

#### Mechanical interlock for contactors

##### Disconnect drive

(multi-speed starters only)

Disconnect switch non-fusible  
fusible

Circuit breaker

#### Enclosures

standard enclosure is gasketed, semi-dusttight

for type 3R weatherproof add to Type 1

Transparent door for steel enclosures

Refer to Moeller Electric

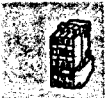

# Magnetic Reduced Voltage Starters

## Engineering Notes

### Application

Reduced voltage starting is required when there are limitations on inrush current or when the load current cannot stand the mechanical shock of starting. Starting current and starting torque can be reduced by reducing the applied voltage to the motor stator terminals. A change in the voltage applied to the stator results in a change of flux proportional to primary voltage.

Stator and rotor currents vary in proportion to applied stator voltage. Since motor torque is proportional to the product of flux and rotor current, torque is proportional to the square of the voltage applied to the stator. The commonly used methods of reduced voltage or current starting are autotransformer type, star-delta type and part-winding type.

### Comparison chart for reduced voltage starters

Criteria	Autotransformer starter Type AT	Star-delta starter Type SD	Part-winding starter Type PW																					
Motor requirements	Can be used with any standard squirrel-cage motor.	Requires a special motor with 6 leads brought out (delta-wound stator).	Requires a special motor in which the stator windings are divided into two or more equal parts with six leads provided. Also dual-voltage motors can be used in the lower range.																					
Description of operation	The motor is connected to the line through the reduced voltage taps of an autotransformer for the starting interval and then directly across the line for running condition.	This method requires two main or line contactors to connect the motor winding in delta connection for running. A third contactor is used to form the star point on the starting step.	Like the star-delta starter, this starter requires no external equipment. One winding is connected to the line for starting. After a time interval, the second or run contactor connects the other motor winding to the line in parallel with the first winding.																					
Starting characteristics in percent of normal	Autotransformer taps at: <table border="1"> <thead> <tr> <th></th> <th>80 %</th> <th>65 %</th> <th>50 %</th> </tr> </thead> <tbody> <tr> <td>current</td> <td>64</td> <td>42</td> <td>25 %</td> </tr> <tr> <td>torque</td> <td>64</td> <td>42</td> <td>25 %</td> </tr> </tbody> </table>		80 %	65 %	50 %	current	64	42	25 %	torque	64	42	25 %	<table border="1"> <thead> <tr> <th>Line voltage</th> <th>100 %</th> <th>100 %</th> </tr> </thead> <tbody> <tr> <td>current</td> <td>33 %</td> <td>60 %</td> </tr> <tr> <td>torque</td> <td>33 %</td> <td>45 %</td> </tr> </tbody> </table>	Line voltage	100 %	100 %	current	33 %	60 %	torque	33 %	45 %	
	80 %	65 %	50 %																					
current	64	42	25 %																					
torque	64	42	25 %																					
Line voltage	100 %	100 %																						
current	33 %	60 %																						
torque	33 %	45 %																						
Advantages	High torque efficiency. All the power taken from the line, except for transformer losses, is transmitted to the motor. The starting current and torque are easily adjusted by changing autotransformer taps. Closed circuit transition.	The star-delta starter provides low inrush current with torque efficiency, without the use of any external equipment. Normally open circuit transition but closed transition can be achieved with the use of resistors.	Part-winding starting provides one-step acceleration at a reduced current. So that the second current inrush is not objectionable. Closed circuit transition.																					
Limitations	Torque remains practically constant for the first step and practically constant at another value for the second step.	Starting characteristics depend on motor design and cannot be adjusted. Requires special delta wound starter.	Requires special motor or dual-voltage motor on low range. Torque efficiency is usually poor for high speed motors.																					
Applications	Applications where there are limitations on starting voltage and current. Most widely used.	Low starting torque applications.	Commercial air conditioning equipment.																					
Approximate price comparison (% of type AT)	100 %	60 %	40 %																					



# Magnetic Reduced Voltage Starters Autotransformer Type

UL/CSA max. Hp rating  
50/60Hz  
3 phase

Standard auxiliary contacts

**Type**  
Specify coil voltage and frequency  
→ pages 03/065, 066

Price includes 3 phase, bimetallic overload relay

**Enclosed**

General purpose Type 1 Replace <input type="checkbox"/> with suffix /S	Industrial use Type 12 dusttight Replace <input type="checkbox"/> with suffix /SD	Type 3R weatherproof Replace <input type="checkbox"/> with suffix /DW
--	--	---

200 V HP	230 V HP	460 V HP	575 V HP
-------------	-------------	-------------	-------------

N.O. N.C.

Specify overload relay suffix code  
→ page 03/023



...    (...)

see price list

see price list

see price list

**Closed transition**

-	-	15	20	2	2	AT0AM/22/Z00-... <input type="checkbox"/> (...)		
-	-	20	25	2	2	AT1AM/22/Z1-40 <input type="checkbox"/> (...)		
-	15	25	30	2	2	AT1AM/22/Z1-... <input type="checkbox"/> (...)		
15	20	40	40	2	2	AT2M/22/Z1-57 <input type="checkbox"/> (...)		
20	25	-	-	2	2	AT2AM/22/Z1-... <input type="checkbox"/> (...)		
-	-	-	50	2	2	AT2AM/22/Z1-57 <input type="checkbox"/> (...)		
25	30	60	75	2	2	AT3M80/22/Z5-... <input type="checkbox"/> (...)		
40	50	100	125	2	2	AT4M115/Z5-... <input type="checkbox"/> (...)		
50	60	125	150	2	2	ATM185/22/Z5-160 <input type="checkbox"/> (...)		
60	75	150	200	2	2	ATM225/22/Z5-220 <input type="checkbox"/> (...)		
75	-	-	-	2	2	ATM250/22/Z5-220 <input type="checkbox"/> (...)		
-	100	200	250	2	2	ATM250/22/Z5-250 <input type="checkbox"/> (...)		
100	125	250	300	2	2	ATM300/22/ZW7-... <input type="checkbox"/> (...)		
125	150	300	400	2	2	ATM400/22/ZW7-... <input type="checkbox"/> (...)		

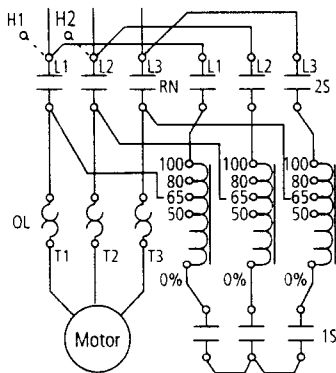

**Autotransformer with thermal protection**

**Standard Features:**

- 3-phase overload protection
- Reset button in cover
- Auxiliary contacts are standard in all starters
- Closed transition, by 3 core dry type autotransformer duty cycle of one 15 second period out of each 4 minutes for one hour followed by a rest period of 2 hours.
- 65% and 80% voltage taps available on all sizes  
Additional 50% tap for 60HP and larger starters
- All starters are normally connected to the 65% tap at the factory
- Autotransformer supplied with thermal protection

**To order specify:**

- Type number
- Overload relay suffix
- Enclosure suffix
- Coil voltage
- Accessories

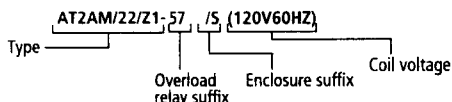

Additional information	Page
Technical data	03/080
Dimensions	03/091
Overload relays	04/004
Accessories	03/053
Factory modifications	03/051
Weights	14/020



# Magnetic Reduced Voltage Starters Automatic Star-Delta Starters

UL/CSA max. Hp rating  
50/60Hz  
3 phase

Standard auxiliary contacts

**Type**  
Specify coil voltage and frequency  
→ pages 03/065, 066

Price includes 3 phase, bimetallic overload relay

**Enclosed**

General purpose  
Type 1  
Replace  with suffix /S

Industrial use  
Type 12 dusttight  
Replace  with suffix /SD

Type 3R weatherproof  
Replace  with suffix /DW

200 V HP    230 V HP    460 V HP    575 V HP

N.O. N.C.

Specify overload relay <sup>1)</sup> suffix code  
→ page 03/023

...    (...)

see price list

see price list

see price list

**Open Transition**

-	-	15	20	2	2	SD0M/22Z00-... <input type="checkbox"/> (...)		
-	-	25	30	2	2	SD0AM/22/Z00-... <input type="checkbox"/> (...)		
-	15	30	40	2	2	SD1M/22/Z1-... <input type="checkbox"/> (...)		
-	25	40	50	2	2	SD1AM/22/Z1-... <input type="checkbox"/> (...)		
25	30	50	60	2	2	SD2M/22/Z1-... <input type="checkbox"/> (...)		
30	40	60	75	2	2	SD2AM/22/Z1-... <input type="checkbox"/> (...)		
40	50	100	125	2	2	SD3M80/22/Z5-... <input type="checkbox"/> (...)		
-	-	-	200	2	2	SD4M115/22/Z5-... <input type="checkbox"/> (...)		
60	75	150	150	2	2	SD4M115/Z5-... <input type="checkbox"/> (...)		
75	100	200	225	2	2	SDM185/22/Z5-... <input type="checkbox"/> (...)		
100	125	250	300	2	2	SDM225/22/Z5-... <input type="checkbox"/> (...)		
125	150	300	400	2	2	SDM250/22/Z5-... <input type="checkbox"/> (...)		

**Closed Transition**

-	-	15	20	2	2	SDCOM/22Z00-... <input type="checkbox"/> (...)		
-	-	25	30	2	2	SDCOAM/22/Z00-... <input type="checkbox"/> (...)		
-	15	30	40	2	2	SDC1M/22/Z1-... <input type="checkbox"/> (...)		
-	25	40	50	2	2	SDC1AM/22/Z1-... <input type="checkbox"/> (...)		
25	30	50	60	2	2	SDC2M/22/Z1-... <input type="checkbox"/> (...)		
30	40	60	75	2	2	SDC2AM/22/Z1-... <input type="checkbox"/> (...)		
40	50	100	125	2	2	SDC3M80/22/Z5-... <input type="checkbox"/> (...)		
-	-	-	200	2	2	SDC4M115/22/Z5-... <input type="checkbox"/> (...)		
60	75	150	150	2	2	SDC4M115/Z5-... <input type="checkbox"/> (...)		
75	100	200	225	2	2	SDCM185/22/Z5-... <input type="checkbox"/> (...)		
100	125	250	300	2	2	SDCM225/22/Z5-... <input type="checkbox"/> (...)		
125	150	300	400	2	2	SDCM250/22/Z5-... <input type="checkbox"/> (...)		

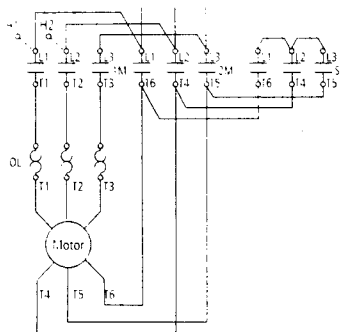

Open transition starter

**Standard Features:**

- 3-phase overload protection
- Reset button in cover
- Auxiliary contacts are standard in all starters

<sup>1)</sup> Select and set overload relay for 58% of motor FLC.

**To order specify:**

- Type number
- Overload relay suffix
- Enclosure suffix
- Coil voltage
- Accessories

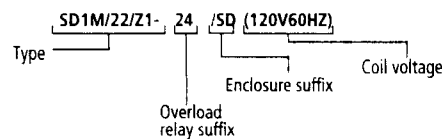

Additional information	Page
Technical data	03/080
Dimensions	03/091
Overload relays	04/004
Accessories	03/053
Factory modifications	03/051
Weights	14/020



# Magnetic Reduced Voltage Starters Part-Winding Starters

Magnetic Contactors,  
Magnetic Starters

UL/CSA max. Hp rating  
50/60Hz  
3 phase

Standard  
auxiliary  
contacts

**Type**  
Specify coil voltage and frequency  
→ pages 03/065, 066

Price includes two 3 phase, bimetallic overload relays

**Enclosed**

General  
purpose  
Type 1  
Replace  with  
suffix /S

Industrial use  
Type 12  
dusttight  
Replace  with  
suffix /SD

Type 3R  
weatherproof  
Replace  with suffix  
/DW

Specify overload  
relay suffix code  
→ page 03/023

200 V HP	230 V HP	460 V HP	575 V HP	N.O.	N.C.	Type	...	(...)	see price list	see price list	see price list
10	10	15	20	1	1	PW0M/11/Z00-... <input type="checkbox"/> (...)					
-	15	20	25	1	1	PW0AM/11/Z00-... <input type="checkbox"/> (...)					
15	-	30	30	1	1	PW1M/11/Z1-... <input type="checkbox"/> (...)					
-	20	-	-	1	1	PW1AM/11/Z1-... <input type="checkbox"/> (...)					
20	25	40	-	1	1	PW2M/11/Z1-... <input type="checkbox"/> (...)					
-	30	60	60	1	1	PW2M/11/Z1-... <input type="checkbox"/> (...)					
30	-	75	75	1	1	PW2AM/11/Z1-... <input type="checkbox"/> (...)					
-	40	-	100	1	1	PW3M80/11/Z5-... <input type="checkbox"/> (...)					
60	75	150	150	2	2	PW4M115/22/Z5-... <input type="checkbox"/> (...)					
75	-	-	200	2	2	PWM185/22/Z5-... <input type="checkbox"/> (...)					
-	100	200	300	2	2	PWM225/22/Z5-... <input type="checkbox"/> (...)					
100	150	300	-	2	2	PWM250/22/Z5-... <input type="checkbox"/> (...)					
150	-	-	400	2	2	PWM300/22/Z5-... <input type="checkbox"/> (...)					

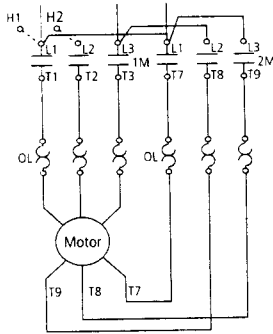

**Standard Features:**

- 2 x 3-phase overload protection
- Reset button in cover
- Auxiliary contacts are standard in all starters

1) Select and set overload relays for 50% of motor FLC.

**To order specify:**

- Type number
- Overload relay suffix
- Enclosure suffix
- Coil voltage
- Accessories

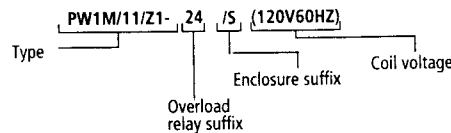

Additional information	Page
Technical data	03/080
Dimensions	03/091
Overload relays	04/004
Accessories	03/053
Factory modifications	03/051
Weights	14/020

# Magnetic Reduced Voltage Starters Factory Modifications

### Order by description

The standard modifications shown on this page are those available for factory installation. Prices for these modifications are shown in the alpha-numeric price list XK0211-2001/2002-CDN, under "Reduced Voltage Starters - Factory Modifications".

The enclosure may or may not change with the addition of any of these items. When accurate dimensions of the enclosure are required, please contact your nearest Moeller Electric branch.

Description	Enclosure type	List Price Adder
		all sizes see price list
<b>Pilot devices in cover</b>		
<b>Pushbuttons</b>		
"START-STOP" or "ON-OFF" Double pushbutton	1 12, 13, 3R, 4X	
"START-STOP" or "ON-OFF" Double pushbutton with indicating light	1 12, 13, 3R, 4X	
Standard 1-unit pushbutton	all types	
Standard 2-unit pushbutton	all types	
Standard 3-unit pushbutton	all types	
<b>Selector switches</b>		
"HAND-AUTO"	1 12, 13, 3R, 4X	
"HAND-O-AUTO"	1 12, 13, 3R, 4X	
<b>Indicating lights</b>		
Indicating light - specify color	1 12, 13, 3R, 4X	
Push-to-test light or illuminated pushbutton	all types	

Description	List Price Adder
	all sizes see price list
<b>Added devices</b>	
<b>Overload relays</b>	
Overload relay, automatic/manual reset and alarm contacts supplied as standard	no charge
P.T.C. thermistor tripping unit,	type EMT6
<b>Control circuit</b>	
Separate control circuit	no charge
Fused control circuit	250V, 1 or 2 fuses 600V, 2 fuses
<b>Auxiliary relays</b>	
Control relay, max. of 4 poles	unwired wired
Timing relay	
Terminal block, wired	per pole
<b>Meters</b>	
Ammeter, max. 3 1/2" panel type	
Current transformer	
Voltmeter, max. 3 1/2" panel type direct reading up to 600V	
3-phase ammeter or voltmeter switch	
Elapsed time meter	
<b>Nameplates</b>	
Special nameplates	3" x 1"





Description	Price Adder to main contactor size								
	00M 00AM 0M	0AM 1M 1AM	2M 2AM	3M80	4M115	M185	M250	M300	
	see price list	see price list	see price list	see price list	see price list	see price list	see price list	see price list	
<b>Control circuit transformers</b>									
Transformer 60 Hz with fused secondary									
Transformer with additional capacity up to 100VA, 60 Hz with fused secondary									
<b>Overload relay</b>									
omit overload relay									- deduct
<b>Mechanical interlock for contactors</b>									
<b>Disconnect drive (multi-speed starters only)</b>									
Disconnect switch		non-fusible							
		fusible							
Circuit breaker									
<b>Reversing starter to change non-reversing to reversing</b>									
<b>Enclosures</b>									
Transparent door for steel enclosures									Consult Moeller Electric

Magnetic Contactors,  
Magnetic Starters

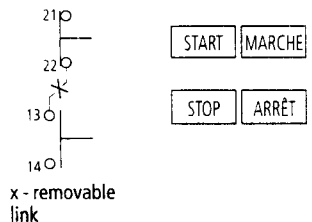
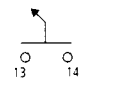

# Magnetic Contactors and Starters Field Modification Kits

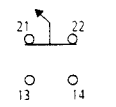
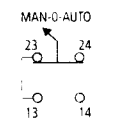
Magnetic Contactors  
Magnetic Starters

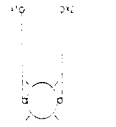
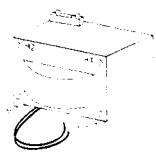







Symbols and Legend Plates English / French text		Description	English version Type Article No.	French version Type Article No.	List Price see price list																																																	
<b>Double pushbutton</b>																																																						
		Double pushbutton mounting in single hole	<b>DDL/K11-CS</b> 110315	<b>DDL/K11-CS-F</b> 110316																																																		
		Double pushbutton mounting in single hole c/w LED element 85-264 V AC operating range	<b>DDL/K11/230-R-CS</b> 110317	<b>DDL/K11/230-R-CS-F</b> 110318																																																		
<b>Selector switches</b>																																																						
		2 position selector switch with legend plate	<b>WKV/K10-CS</b> 110319	<b>WKV/K10-CS-F</b> 110320																																																		
			<b>WKV/K11-CS</b> 110321	<b>WKV/K11-CS-F</b> 110322																																																		
		3 position selector switch with legend plate	<b>WRK3/K20-CS</b> 110323	<b>WRK3/K20-CS-F</b> 110324																																																		
<b>Pilot light</b>																																																						
		Red pilot light, c/w LED element 85 - 264 V AC operating range	<b>L-R/230-R-CS</b> 110325																																																			
<table border="1"> <thead> <tr> <th>VA Rating</th> <th>Secondary fuse</th> <th>Contactor Size</th> <th>T...-600/120 Type</th> <th>List Price</th> <th>T...-480/120 Type</th> <th>List Price</th> </tr> </thead> <tbody> <tr> <td>50</td> <td>0.5</td> <td>DILEM, DIL00(A)M, DIL0(A)M, DIL1(A)M</td> <td><b>T50-600/120</b> 101730</td> <td></td> <td><b>T50-480/120</b> 101729</td> <td></td> </tr> <tr> <td>75</td> <td>0.75</td> <td>DIL2(A)M, DILM185, DILM225, DILM250, PKZ2(-SP)</td> <td><b>T75-600/120</b> 101736</td> <td></td> <td><b>T75-480/120</b> 101735</td> <td></td> </tr> <tr> <td>100</td> <td>1.0</td> <td>DIL3M80, DILM300, DILM400, DILM500</td> <td><b>T100-600/120</b> 101722</td> <td></td> <td><b>T100-480/120</b> 101721</td> <td></td> </tr> <tr> <td>150</td> <td>1.5</td> <td>DIL4M115</td> <td><b>T150-600/120</b> 101724</td> <td></td> <td><b>T150-480/120</b> 101723</td> <td></td> </tr> <tr> <td>250</td> <td>2.5</td> <td>DILM580, DILM650, DILM750, DILM820</td> <td><b>T250-600/120</b> 101726</td> <td></td> <td><b>T250-480/120</b> 101725</td> <td></td> </tr> <tr> <td>500</td> <td>5.0</td> <td></td> <td><b>T500-600/120</b> 101732</td> <td></td> <td><b>T500-480/120</b> 101731</td> <td></td> </tr> </tbody> </table>						VA Rating	Secondary fuse	Contactor Size	T...-600/120 Type	List Price	T...-480/120 Type	List Price	50	0.5	DILEM, DIL00(A)M, DIL0(A)M, DIL1(A)M	<b>T50-600/120</b> 101730		<b>T50-480/120</b> 101729		75	0.75	DIL2(A)M, DILM185, DILM225, DILM250, PKZ2(-SP)	<b>T75-600/120</b> 101736		<b>T75-480/120</b> 101735		100	1.0	DIL3M80, DILM300, DILM400, DILM500	<b>T100-600/120</b> 101722		<b>T100-480/120</b> 101721		150	1.5	DIL4M115	<b>T150-600/120</b> 101724		<b>T150-480/120</b> 101723		250	2.5	DILM580, DILM650, DILM750, DILM820	<b>T250-600/120</b> 101726		<b>T250-480/120</b> 101725		500	5.0		<b>T500-600/120</b> 101732		<b>T500-480/120</b> 101731	
VA Rating	Secondary fuse	Contactor Size	T...-600/120 Type	List Price	T...-480/120 Type	List Price																																																
50	0.5	DILEM, DIL00(A)M, DIL0(A)M, DIL1(A)M	<b>T50-600/120</b> 101730		<b>T50-480/120</b> 101729																																																	
75	0.75	DIL2(A)M, DILM185, DILM225, DILM250, PKZ2(-SP)	<b>T75-600/120</b> 101736		<b>T75-480/120</b> 101735																																																	
100	1.0	DIL3M80, DILM300, DILM400, DILM500	<b>T100-600/120</b> 101722		<b>T100-480/120</b> 101721																																																	
150	1.5	DIL4M115	<b>T150-600/120</b> 101724		<b>T150-480/120</b> 101723																																																	
250	2.5	DILM580, DILM650, DILM750, DILM820	<b>T250-600/120</b> 101726		<b>T250-480/120</b> 101725																																																	
500	5.0		<b>T500-600/120</b> 101732		<b>T500-480/120</b> 101731																																																	
<b>Control transformers <sup>1)</sup> including fuse block and fuse</b>																																																						
																																																						

Note:

<sup>1)</sup> The standard enclosure may or may not have room for the addition of a control transformer.

# Magnetic Contactors and Starters Accessories



Magnetic Contactors  
Magnetic Starters





	Voltage	For use with	Circuit diagram	Type Article No.	List Price see price list	
<b>Suppressors</b>						
<b>RC suppressors</b>						
	24 – 48 110 – 250	DILEM		<b>RCDILE48</b> 044264 <b>RCDILE250</b> 046320	For AC operated contactors, 50 – 60 Hz. Drop-out delay should be taken into consideration.	
	24 – 48 110 – 250 380 – 415	DIL00(A)M, DIL0(A)M, DIL1(A)M, DIL2(A)M		<b>RCBDIL48</b> 067345 <b>RCBDIL250</b> 069718 <b>RCBDIL415</b> 072091		
	24 – 48 110 – 250 380 – 415	DIL3M80 DIL4M115		<b>RCSLIL48</b> 071577 <b>RCSLIL250</b> 071613 <b>RCSLIL415</b> 071614		
<b>Varistor suppressors</b>						
	24 – 48 110 – 250 380 – 415	DILEM		<b>VGDILE48</b> 010320 <b>VGDILE250</b> 010336 <b>VGDILE415</b> 010463		For AC operated contactors, 50 – 60 Hz DC operated contactors (DILEM...-G) have an integrated suppressor circuit as standard
	12 – 24 24 – 48 110 – 250 380 – 415	DIL00(A)M, DIL0(A)M, DIL1(A)M, DIL2(A)M, DIL3M80, DIL4M115		<b>VGBDIL24</b> 076837 <b>VGBDIL48</b> 071609 <b>VGBDIL250</b> 071610 <b>VGBDIL415</b> 071611		
	12 – 24 24 – 48 110 – 250 380 – 415	DIL00(A)M, DIL0(A)M, DIL1(A)M, DIL2(A)M		<b>VGCDIL24</b> 211018 <b>VGCDIL48</b> 211019 <b>VGCDIL250</b> 211020 <b>VGCDIL415</b> 211021		
<b>Free-wheel diode suppressor</b>	12 – 250 DC	DIL00(A)M, DIL0(A)M, DIL1(A)M, DIL2(A)M				<b>FDBDIL</b> 074464

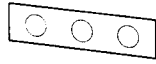

# Magnetic Contactors and Starters Accessories

Magnetic Contactors  
Magnetic Starters



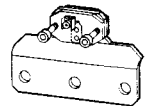

	For use with	Circuit diagram	Type Article No.	List Price see price list	
<b>Star-point bridges</b>					
	DIL00(A)M		<b>S1DIL00M</b> 027130		Finger-safe design in accordance with IEC 536.
	DIL0(A)M		<b>S1DIL0M</b> 029503		
	DIL1(A)M		<b>S1DIL1M</b> 031876		
	DIL2(A)M		<b>S1DIL2M</b> 034249		
	DIL3M80		<b>S1DIL3M</b> 050735		
	DIL4M115		<b>S1DIL4M</b> 071575		
	DILM185 – DILM400		<b>DILM400-XS1</b> 208291		Shroud is included for protection against accidental contact.
	DILM500		<b>DILM500-XS1</b> 208290		

<b>Paralleling bridges</b> (consisting of 2 paralleling links)						
For main contacts						
	4-pole		<b>P1DILEM</b> 019095		4th pole can be broken off  Continuous current carrying capacity (AC-1) of the open contactor increases by a factor of 2,5 P 1 DIL EM to P 1 DIL 4 M have finger-safe design in accordance with IEC 536..	
			DILEM	<b>P1DIL00M</b> 081583		
	3-pole		<b>P1DIL0M</b> 083956		Terminal capacity for P1DIL → page 03/090	
			DIL0(A)M	<b>P1DIL1M</b> 086329		
			DIL1(A)M	<b>P1DIL2M</b> 088702		
			DIL2(A)M	<b>P1DIL3M</b> 050688		
			DIL3M80	<b>P1DIL4M</b> 071576		
			DIL4M115			
	DILM185		<b>DILM185-XP1</b> 208292		For type DILM185-XP1: Shroud is included for protection against accidental contact.	

<b>Reversing wiring kits</b>					
	DILEM(+MVDILEM) DIULEM		<b>MVS-WB-EM</b> 220209		Consisting of one 3-pole paralleling link (top), with control bridge, and reversing link with A2 bridge
	DIL00(A)M DIUL00(A)M		<b>MVS-WB-00M</b> 220210		Consisting of one 3-pole paralleling link (top) and reversing link with A2 bridge (bottom) Overload relay cannot be mounted directly to contactor
	DIL00(A)M+MVDILM DIUL00(A)M/MV		<b>MVS-WB5MV</b> 215512		
	DIL0(A)M+MVDILM DIUL0(A)M/MV		<b>MVS-WB-11MV</b> 216344		
	DIL1(A)M DIUL1(A)M		<b>MVS-WB-1M</b> 220212		

# Magnetic Contactors and Starters

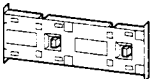
## Accessories

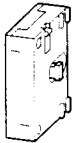





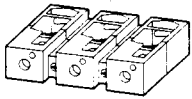

	For use with	Type	List Price
		Article No.	see price list
<b>Paralleling links</b> for auxiliary contacts 	all top-mounting auxiliary contacts	<b>BT480</b> 052785	Not insulated. Standard quantity: 100 <sup>1)</sup>
<b>Adapter set</b> (consisting of 6 adapters) for cable lug connection 	DIL3M80	<b>AKDIL3M</b> 050834	For connecting cables with crimped lugs. Set includes 2 terminal covers.
	DIL4M115	<b>AKDIL4M</b> 071574	
<b>Mechanical interlocks</b> 	DILEM	<b>MVDILE</b> 010113	For contactors with the same or different magnetic systems mounted horizontally or vertically. Distance between contactors 0mm Mechanical lifespan 2,5 x 10 <sup>6</sup> operations Additional auxiliary contacts can be mounted.
	DIL00(A)M, DIL0(A)M, DIL1(A)M, DIL2(A)M	<b>MVDILM</b> 060226	For contactors with the same or different frame sizes, but with the same magnetic system mounted horizontally or vertically. Distance between contactors 15 mm Mechanical lifespan 5 x 10 <sup>6</sup> operations
	DIL3M80, DIL4M115, DILM185, DILM225, DILM250, DILM300, DILM400, DILM500	<b>DILM500-XMV</b> 208289	For contactors with the same or different magnetic systems, mounted horizontally or vertically. Mechanical lifespan 5 x 10 <sup>6</sup> operations No auxiliary contact can be mounted between interlock and contactor. Distance between contactors: DIL3M80 - 4M115 10 mm DILM185 - M820 15 mm
	DILM580, DILM650, DILM750, DILM820	<b>DILM820-XMV</b> 208288	

Notes:

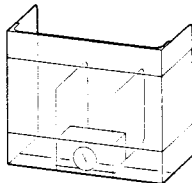
<sup>1)</sup> must be ordered in standard quantity

# Magnetic Contactors and Starters

## Accessories

For use with	Type	List Price	
	Article No.	see price list	
<b>Cable terminal block</b>			
with control circuit terminal			
	DILM185, DILM225	<b>DILM225-XKU-S</b> 208294	For cable connection. Single or double cables may be connected. → page 03/090 for sizes.
	DILM250, DILM300, DILM400	<b>DILM400-XKU-S</b> 208293	
<b>Flat strip conductor terminal kit <sup>1)</sup></b>			
With control circuit terminal (consisting of 3 flat strip conductor terminals)			
	DILM500, DILM580, DILM650	<b>DILM650-XKB-S</b> 208296	For bus and flexibus connection.
	DILM750, DILM820	<b>DILM820-XKB-S</b> 208295	
<b>Control circuit terminals</b>			
	DIL0(A)M	<b>ZKDIL0M</b> 019229	Pressure wire connectors mounted directly to the main terminals for control circuit tap-off. 15A, 600V max., AWG 18 - 14
	DIL1(A)M, DIL2(A)M	<b>ZKDIL1M</b> 021602	
	DIL3M80, DIL4M115	<b>ZKDILM</b> 051138	
<b>Main terminal</b>			
	DIL1(A)M, DIL2(A)M	<b>HKDILM</b> 097762	For connecting large cross-sections, For connection of: up to 50 mm <sup>2</sup> stranded or 35 mm <sup>2</sup> flexible with ferrule
<b>Covers</b>			
Terminal cover			
	DILM185, DILM225, DILM250, DILM300, DILM400	<b>DILM400-XHB</b> 208287	Protection against shock hazards and accidental direct contact.
	DILM500	<b>DILM500-XHB</b> 208286	
	DILM580, DILM650	<b>DILM650-XHB</b> 208285	
	DILM750, DILM820	<b>DILM820-XHB</b> 208284	
<b>Coupling connector</b>			
provides a mechanical link when mounting groups of components together			
	DILEM	<b>VODILE</b> 026634	0 mm distance between contactors
	DIL00(A)M, DIL0(A)M, DIL1(A)M, DIL2(A)M	<b>VODIL</b> 010772	0 mm distance between contactors
		<b>V5/15DIL</b> 013145	5 mm between contactors, for contactors with DC coil 15 mm between contactors, for mechanical interlock between contactors
		<b>V10/A5DIL</b> 015518	10 mm between contactors, for mounting one side mounting auxiliary contact between two contactors 5 mm between contactors for contactors with DC coil without permanent connection
<b>Screw adapter</b>			
	ETS4-VS3	<b>CS-TE</b> 095853	For screw-mounting of ETS4-VS3 interface modules









Notes:

<sup>1)</sup> UL/CSA pending - please inquire

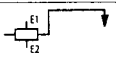
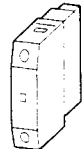

# Magnetic Contactors and Starters



## Accessories

	For use with	Circuit diagram	Type Article No.	List Price see price list
<b>Pneumatic timer modules</b>				
On-delayed 	DIL00M-2AM		<b>TPE11DIL</b> 002279	Switching times are convertible, 0,2 – 30 s or 20 – 180 s  Snap-mounting on contactors
Off-delayed 	DIL00M-2AM		<b>TPD11DIL</b> 002280	
<b>Mechanical latching modules</b>				
	DIL00M		<b>V-GDIL(24VDC)</b> 048562	Pulse duration 200 ms maximum other operating voltages → page 03/066
			<b>V-DIL(120V60HZ)</b> 043822	DF: 100 % other operating voltages → page 03/066
<b>4th pole</b>				
Only for AC-1 load, up to 2 auxiliary contacts can be mounted				
	DIL0M		<b>NDI0M</b> 062006	Continuous current rating open/enclosed 35 A/30 A
	DIL1M		<b>NDI1M</b> 060243	Continuous current rating open/enclosed 55 A/44 A
	DIL2M		<b>NDI2M</b> 060264	Continuous current rating open/enclosed 75 A/60 A
<b>Connection tabs for fast-on connectors</b> 1 x 6,3 x 0,8/2 x 2,8 x 0,8 mm				
 	DILEM, DIL00M to DILM820		<b>BT483</b> <sup>1)</sup> 059904	For auxiliary contact and coil connections. Use connectors with insulated sleeves. Standard quantity: 100
	DIL3M80 to DILM820		<b>BT2571</b> <sup>1)</sup> 062276	

Notes:

<sup>1)</sup> must be ordered in standard quantity

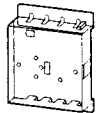

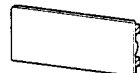
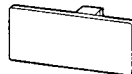
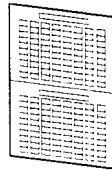
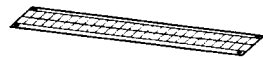
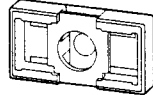

## Magnetic Contactors and Starters Accessories

	Dimensions Width x Height	For use with	Type Article No.	List Price see price list
<b>Sealable shrouds</b>				
Transparent 		DILEM	<b>HDILE</b> 010482	Cover snap-mounts onto the device and can be sealed to prevent tampering
		TPE11DIL TPD11DIL	<b>PL-DILT</b> 036073	Cover is fastened via a screw. Sealable to prevent access.
<b>Component labelling system <sup>1)</sup></b>				
Clip-in label plate 	8 x 10 mm	...DIL	<b>KG10 <sup>1)</sup></b> 022256	Clips into 2-pole auxiliary contact modules Standard quantity: 500
	8 x 20 mm	...DILE, DILER ...DIL, DILR	<b>KG20 <sup>1)</sup></b> 091075	Clips into 4-pole auxiliary contact modules and basic relays Standard quantity: 500
Label plate with mounting stud 	8 x 17,5 mm Color: white	DIL...	<b>XGKS-Z <sup>1)</sup></b> 207508	For use on Moeller devices with matching mounting hole. Standard quantity: 500
Sheet of labels 	7,5 x 17 mm  Color: yellow HKS 3 (≈RAL 1018)	XGKS, XGKS-Z, KG 20  For inscription using laser printer, plotter, marker pen, copier	<b>XGKE-GE <sup>2)</sup></b> 207517	Standard quantity: pad of 25 sheets, 240 labels per sheet, perforated and self-adhesive, for use with label plates. Price per sheet.
<b>Card of label plates</b>				
Can be inscribed by marker pen or plotter by Phoenix Contact or others,				
	8 x 17,5 mm	DIL3M80 to DILM820	<b>XGKS-T <sup>2)</sup></b> 207505	Standard quantity 10 cards, 40 labels per card
<b>Universal mounting adapter</b>				
To secure XGKS on non-Moeller devices, enclosures, mounting plates, wiring, etc. Color: RAL 7035, light grey				
			<b>XGKA-U <sup>1)</sup></b> 207509	Mounting • self-adhesive, • with M3 screw or • cable tie Standard quantity: 250

**Notes:**

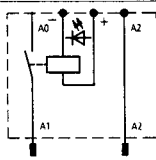
- <sup>1)</sup> Must be ordered in standard quantity.  
<sup>2)</sup> Consult Moeller Electric for inscription software.

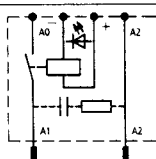
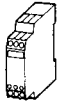
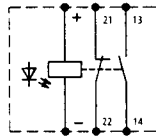
# Magnetic Contactors and Starters Accessories

Output pilot duty rating		Operating voltage / operating current <i>U<sub>v</sub>/I</i> V DC/mA	Circuit diagram	For use with contactors	Type Article No.	List Price see price list	
AC	DC						
<b>Interface modules, plug-in type</b>							
	B300	R300	24/11		DIL00(A)M DIL0(A)M DIL1(A)M DIL2(A)M	<b>VS1DIL</b> 055480	For energizing of contactor low level 24V DC inputs. The VS1 and VS2 plug directly into the DIL coil terminals, whereas the ETS4-VS3 mounts separately on a DIN rail and is suitable for all contactors. In cases where the rated coil current of a device exceeds 2A, use a DILER-G as an interface relay.
	B300	R3000	24/11		DIL00(A)M DIL0(A)M DIL1(A)M DIL2(A)M	<b>VS2DIL</b> 057853	
<b>Interface module for separate mounting</b>							
	B300		24/25		as required	<b>ETS4-VS3</b> 083094	Contactor coils with rated operational currents > 2 A must be energized via the DILER-G mini contactor. Overvoltage limit: the input of the ETS4-VS3 is mounted with an integral suppressor circuit.
<b>Front plates</b>							
					DILR(-G) DIL00(A)M(-G) DIL0(A)M(-G)	<b>HDIL00M</b> 093665 <b>HDIL0M</b> 093664	For blanking off the auxiliary contact module mounting location on basic contactor units, and for component labelling. Minimum order quantity: 10



# Magnetic Contactors and Starters

## Accessories

Magnetic Contactors  
Magnetic Starters

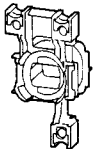
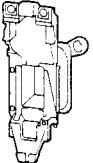
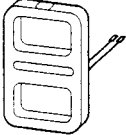
	For use with	AC Type Article No. Coil voltages shown in (...) For other coil voltages, → page 03/071	List Price see price list	DC Type Article No. Coil voltages shown in (...) For other coil voltages, → page 03/071	List Price see price list
<b>Individual coils</b>					
	DIL00(A)M	J-DIL00M(120V60HZ) 043830		G-DIL00M(24VDC) 048557	
	DIL0(A)M	J-DIL0M(120V60HZ) 047437		G-DIL0M(24VDC) 063206	
	DIL1(A)M	J-DIL1M(120V60HZ) 047449		G-DIL1M(24VDC) 063211	
	DIL2(A)M	J-DIL2M(120V60HZ) 048015		G-DIL2M(24VDC) 063216	
	DIL3M80	J-DIL3M(120V60HZ) 048919		G-DIL3M(24VDC) 063221	
	DIL4M115	J-DIL4M(120V60HZ) 048930		G-DIL4M(24VDC) 063226	
<b>Electronic modules including coils</b>					
	DILM185, DILM225, DILM250	DILM250-XSP/E(RA250) 208252		DILM250-XSP/E(RA250) 208252	
	DILM300, DILM400, DILM500	DILM500-XSP/E(RA250) 208256		DILM500-XSP/E(RA250) 208256	
	DILM580, DILM650, DILM750, DILM820	DILM820-XSP/E(RA250) 208259		DILM820-XSP/E(RA250) 208259	

Notes

---

03/06

Magnetic Contactors  
Magnetic Starters



# DIL Contactors Travel Diagrams

## Travel diagrams for contactors

The diagrams show the closing and opening travel of the auxiliary contacts of contactors and modules at no-load. Tolerances are not taken into consideration.

Magnetic Contactors,  
Magnetic Starters

### DILEM...AC

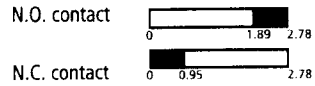

### DIL00(A)M; DIL00(A)M + ...DIL(M)

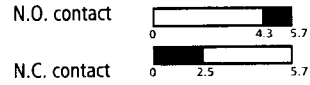

### DIL0(A)M; DIL0(A)M + ...DIL(M)

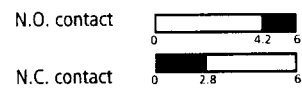

### DIL1(A)M; DIL1(A)M + ...DIL(M)

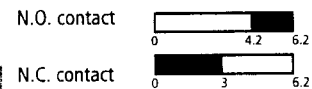

### DIL2(A)M; DIL2(A)M + ...DIL(M)

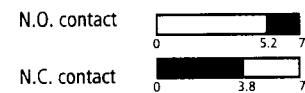

### DIL(E)EM..DC

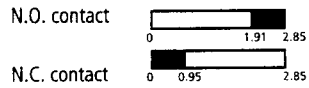

### DIL0(A)M + ...SDILM + DILM820-XHI11-SI

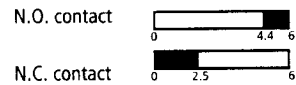

### DIL1(A)M + ...SDILM + DILM820-XHI11-SI

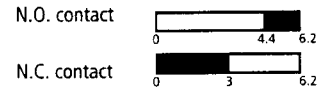

### DIL2(A)M + ...SDILM + DILM820-XHI11-SI

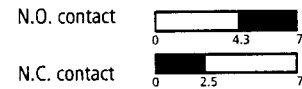

### ..DILE

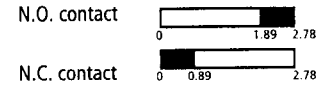

### DIL00(A)M + ...DDILM

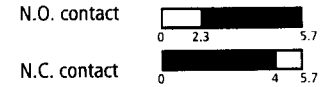

### DIL0(A)M + ...DDILM

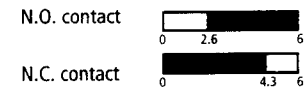

### DIL1(A)M + ...DDILM

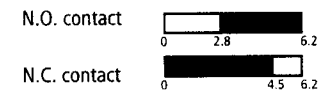

### DIL2(A)M + ...DDILM

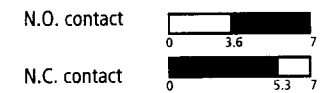

# DIL Contactors

## Travel Diagrams

### Travel diagrams for contactors

The diagrams show the closing and opening travel of the auxiliary contacts of contactors and modules at no-load. Tolerances are not taken into consideration.

#### DIL3M80

N.O. contact

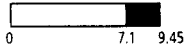

#### DIL3M80 + DILM820-XHI11

N.O. contact

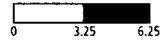

N.C. contact

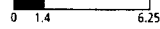

#### DIL3M80 + DILM820-XHI11V-SI

N.O. contact

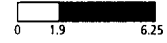

N.C. contact

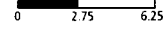

#### DIL4M115

N.O. contact

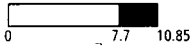

#### DIL4M115 + DILM820-XHI11

N.O. contact

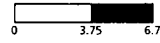

N.C. contact

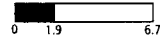

#### DIL4M115 + DILM820-XHI11V-SI

N.O. contact

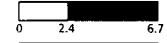

N.C. contact

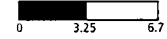

#### DILM185/225/250

N.O. contact

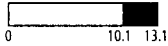

#### DILM185/225/250 + DILM820-XHI11

N.O. contact

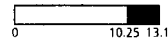

N.C. contact



#### DILM185/225/250 + DILM820-XHI11V-SI

N.O. contact

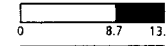

N.C. contact

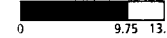

#### DILM300/400/500

N.O. contact

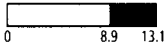

#### DILM300/400/500 + DILM820-XHI11

N.O. contact

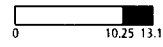

N.C. contact

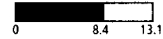

#### DILM300/400/500 + DILM820-XHI11V-SI

N.O. contact

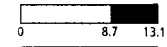

N.C. contact



#### DILM580/650

N.O. contact

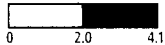

#### DILM580/650 + DILM820-XHI11

N.O. contact

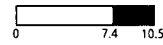

N.C. contact

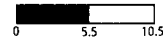

#### DILM580/650 + DILM820-XHI11V-SI

N.O. contact

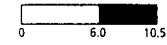

N.C. contact



#### DILM750/820

N.O. contact

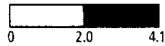

#### DILM750/820 + DILM820-XHI11

N.O. contact

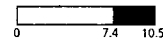

N.C. contact

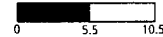

#### DILM750/820 + DILM820-XHI11V-SI

N.O. contact

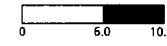

N.C. contact



# DIL EM Mini Contactors

## Coil Voltages

Magnetic Contactors  
Magnetic Starters

AC	DILEM-10(...)	DILEM-01(...)	DILEM4(...)
	Article No. <sup>1)</sup>	Article No. <sup>1)</sup>	Article No. <sup>1)</sup>
Standard voltages	List Price see price list	List Price see price list	List Price see price list
12V 50Hz	068296	068297	079644
24V 50Hz	010005	010086	014754
48V 50Hz	010020	010294	011052
240V 50Hz	010032	010151	014305
24V 60Hz	010006 <sup>2)</sup>	010134 <sup>2)</sup>	014776 <sup>2)</sup>
110V 60Hz	010023	010342	012419
115V 60Hz	010024	010470	012514
208V 60Hz	210256		
600V 60Hz	010197 <sup>2)</sup>	010327 <sup>2)</sup>	100483 <sup>2)</sup>
42V 50Hz, 48V 60Hz	051782 <sup>2)</sup>	051791 <sup>2)</sup>	051800 <sup>2)</sup>
110V 50Hz, 120V 60Hz	051783 <sup>2)</sup>	051792 <sup>2)</sup>	051801 <sup>2)</sup>
190V 50Hz, 220V 60Hz	051784	051793	051802
220V 50Hz, 240V 60Hz	051785	051794	051803
230V 50Hz, 240V 60Hz	051786 <sup>2)</sup>	051795 <sup>2)</sup>	051804 <sup>2)</sup>
380V 50Hz, 440V 60Hz	051787	051796	051805
400V 50Hz, 440V 60Hz	051788	051797	051806
415V 50Hz, 480V 60Hz	051789 <sup>2)</sup>	051798	051807 <sup>2)</sup>
24V 50/60Hz	021417	020402	022044
42V 50/60Hz	032174	033233	031489
110V 50/60Hz	021455	020436	022021
230V 50/60Hz	052302	051114	052506
DC	DILEM-10-G(...)	DILEM-01-G(...)	DILEM4-G(...)
	Article No. <sup>1)</sup>	Article No. <sup>1)</sup>	Article No. <sup>1)</sup>
Standard voltages	List Price see price list	List Price see price list	List Price see price list
12V DC	079594	079642	079680
24V DC	010213 <sup>2)</sup>	010343 <sup>2)</sup>	012701 <sup>2)</sup>
48V DC	010245 <sup>2)</sup>	010496 <sup>2)</sup>	012811 <sup>2)</sup>
60V DC	010293	010040	012844
110V DC	010309 <sup>2)</sup>	010136 <sup>2)</sup>	013166 <sup>2)</sup>
220V DC	010325	010168	013194

**Notes:**

- <sup>1)</sup> To obtain the article number for ordering, read under selected type and coil voltage from the table above. Devices with **dual-voltage coils** must be ordered using **one** article number.
- <sup>2)</sup> Contactors with these coil voltages are normal stock items.



# DIL00M to DIL1AM Contactors

## Coil Voltages



AC	DIL00M (...)	DIL00M4 (...)	DIL00AM (...)	DIL0M (...)	DIL0AM (...)	DIL1M (...)	DIL1AM (...)
	Article No. <sup>1)</sup>	Article No. <sup>1)</sup>	Article No. <sup>1)</sup>	Article No. <sup>1)</sup>	Article No. <sup>1)</sup>	Article No. <sup>1)</sup>	Article No. <sup>1)</sup>
Standard voltages	List Price see price list	List Price see price list	List Price see price list	List Price see price list	List Price see price list	List Price see price list	List Price see price list
24V 50Hz	041764	000104	068921	009506	054590	049856	011886
48V 50Hz	048883	023834	045191	035609	080693	078332	040362
240V 50Hz	058375	095023	078413	002387	047471	045110	007140
500V 50Hz	065494	030953	038072	040355	085439	080705	042735
24V 60Hz	086851 <sup>3)</sup>	099769 <sup>3)</sup>	071294 <sup>3)</sup>	011879 <sup>3)</sup>	056963 <sup>3)</sup>	052229 <sup>3)</sup>	014259 <sup>3)</sup>
115V 60Hz	079732	078412	090278	092560	035606	030872	094940
208V 60Hz	210224 <sup>3)</sup>	210230 <sup>3)</sup>	210218 <sup>3)</sup>	210234 <sup>3)</sup>	210232 <sup>3)</sup>	210238 <sup>3)</sup>	210236 <sup>3)</sup>
600V 60Hz	210225 <sup>3)</sup>	210231 <sup>3)</sup>	210219 <sup>3)</sup>	210235 <sup>3)</sup>	210233 <sup>3)</sup>	210239 <sup>3)</sup>	210237 <sup>3)</sup>
42V 50Hz, 48V 60Hz	060476 <sup>3)</sup>	046933 <sup>3)</sup>	061221 <sup>3)</sup>	061253 <sup>3)</sup>	061261 <sup>3)</sup>	061269 <sup>3)</sup>	061417 <sup>3)</sup>
110V 50Hz, 120V 60Hz	060477 <sup>3)</sup>	046926 <sup>3)</sup>	061222 <sup>3)</sup>	061254 <sup>3)</sup>	061262 <sup>3)</sup>	061270 <sup>3)</sup>	061427 <sup>3)</sup>
190V 50Hz, 220V 60Hz	060478	046927	061223	061255	061263	061271	061437
220V 50Hz, 240V 60Hz	061216	046928	061225	061256	061264	061272	061447
230V 50Hz, 240V 60Hz	061217 <sup>3)</sup>	046929 <sup>3)</sup>	061224 <sup>3)</sup>	061257 <sup>3)</sup>	061265 <sup>3)</sup>	061273 <sup>3)</sup>	061457 <sup>3)</sup>
380V 50Hz, 440V 60Hz	061218	046930	061226	061258	061266	061274	043586
400V 50Hz, 440V 60Hz	061219	046931	061227	061259	061267	061275	043981
415V 50Hz, 480V 60Hz	061220 <sup>3)</sup>	046932 <sup>3)</sup>	061228 <sup>3)</sup>	061260 <sup>3)</sup>	061268 <sup>3)</sup>	061375 <sup>3)</sup>	044266 <sup>3)</sup>
24V 50/60Hz	093970	097396	073667	007133	052217	047483	009513
42V 50/60Hz	088324	083288	088471	023744	068828	064094	026124
110V 50/60Hz	098716	073666	095024	085441	028487	023753	087821
230V 50/60Hz	043380	045969	043237	043665	043527	043695	043666
380V 50/60Hz	013289	007223	064175	016625	061709	056975	019005
Special voltages (i.e. voltages other than the standard voltages listed above) <sup>2)</sup>	List Price see price list	List Price see price list	List Price see price list	List Price see price list	List Price see price list	List Price see price list	List Price see price list
...V 50Hz (12-600V)	100737	100761	100714	100782	100764	-	-
...V 50Hz (24-600V)	-	-	-	-	-	100815	100805
...V 60Hz (12-600V)	100738	100762	100715	100783	100765	-	-
...V 60Hz (24-600V)	-	-	-	-	-	100816	100806
DC	DIL00M-G(...)	DIL00M4-G(...)	DIL00AM-G(...)	DIL0M-G(...)	DIL0AM-G(...)	DIL1M-G(...)	DIL1AM-G(...)
	Article No. <sup>1)</sup>	Article No. <sup>1)</sup>	Article No. <sup>1)</sup>	Article No. <sup>1)</sup>	Article No. <sup>1)</sup>	Article No. <sup>1)</sup>	Article No. <sup>1)</sup>
Standard voltages	List Price see price list	List Price see price list	List Price see price list	List Price see price list	List Price see price list	List Price see price list	List Price see price list
24V DC	048587 <sup>3)</sup>	063171 <sup>3)</sup>	048567 <sup>3)</sup>	048597 <sup>3)</sup>	048592 <sup>3)</sup>	048605 <sup>3)</sup>	048602 <sup>3)</sup>
48V DC	048588 <sup>3)</sup>	063172 <sup>3)</sup>	048568 <sup>3)</sup>	048598 <sup>3)</sup>	048593 <sup>3)</sup>	048606 <sup>3)</sup>	048603 <sup>3)</sup>
60V DC	048589	063173	048569	048599	048594	048607	063229
110V DC	048585	063169	048565	048595	048590	063230	048600
220V DC	048586	063170	048566	048596	048591	048604	048601
Special voltages (i.e. voltages other than the standard voltages listed above) <sup>2)</sup>	List Price see price list	List Price see price list	List Price see price list	List Price see price list	List Price see price list	List Price see price list	List Price see price list
...V DC (12-250V)	100743	100763	100720	100784	100766	100817	100807

## Notes:

<sup>1)</sup> To obtain the article number for ordering, read under selected type and coil voltage from the table above.

Devices with **dual-voltage coils** must be ordered using **one** article number.

<sup>2)</sup> When ordering special voltages, state the operating voltage selected from the range (...-...V) shown.

<sup>3)</sup> Contactors with these coil voltages are normal stock items.

## DIL2M to DIL4M145 Contactors, VDIL Mechanical Latching Module Coil Voltages

Magnetic Contactors,  
Magnetic Starters



AC	DIL2M(...)	DIL2AM(...)	DIL3M80(...)	DIL4M115(...)	VDIL(...)
	Article No. <sup>1)</sup>	Article No. <sup>1)</sup>	Article No. <sup>1)</sup>	Article No. <sup>1)</sup>	Article No. <sup>1)</sup>
Standard voltages	List Price see price list	List Price see price list	List Price see price list	List Price see price list	List Price see price list
24V 50Hz	009525	033253	209681	209743	053536
48V 50Hz	038001	061729	209683	209744	055493
240V 50Hz	004779	028507	209684	209745	053115
500V 50Hz	078341	064102	209685	209746	-
24V 60Hz	011898 <sup>3)</sup>	035626 <sup>3)</sup>	209687 <sup>3)</sup>	209747 <sup>3)</sup>	053659 <sup>3)</sup>
115V 60Hz	092579	014269	209689	209748	052241
208V 60Hz	211211 <sup>3)</sup>	210240 <sup>3)</sup>	100986 <sup>3)</sup>	-	-
600V 60Hz	211212 <sup>3)</sup>	210241 <sup>3)</sup>	100987 <sup>3)</sup>	101006 <sup>3)</sup>	-
42V 50Hz, 48V 60Hz	046562 <sup>3)</sup>	046570 <sup>3)</sup>	209690 <sup>3)</sup>	209749 <sup>3)</sup>	043821 <sup>3)</sup>
110V 50Hz, 120V 60Hz	046563 <sup>3)</sup>	046571 <sup>3)</sup>	209691 <sup>3)</sup>	209750 <sup>3)</sup>	043822 <sup>3)</sup>
190V 50Hz, 220V 60Hz	046564	046572	209692	209751	043823
220V 50Hz, 240V 60Hz	046565	046573	209693	209752	043824
230V 50Hz, 240V 60Hz	046566 <sup>3)</sup>	046574 <sup>3)</sup>	209694 <sup>3)</sup>	209753 <sup>3)</sup>	043825 <sup>3)</sup>
380V 50Hz, 440V 60Hz	046567	046575	209695	209754	-
400V 50Hz, 440V 60Hz	046568	046576	209696	209755	-
415V 50Hz, 480V 60Hz	046569 <sup>3)</sup>	046577 <sup>3)</sup>	209701 <sup>3)</sup>	209756 <sup>3)</sup>	-
24V 50/60Hz	007152	030880	209702	209758	053217
42V 50/60Hz	023763	049864	209703	209759	055218
110V 50/60Hz	085460	007150	209704	209760	051165
230V 50/60Hz	048774	044082	209705	209761	054487
380V 50/60Hz	016644	042745	209706	209762	054695
Special voltages (i.e. voltages other than the standard voltages listed above) <sup>2)</sup>	List Price see price list	List Price see price list	List Price see price list	List Price see price list	List Price see price list
...V 50Hz (12-415V)	-	-	-	-	100295
...V 50Hz (24-600V)	100900	100890	209707	209763	-
...V 60Hz (12-415V)	-	-	-	-	100296
...V 60Hz (24-600V)	100901	100891	209708	209764	-
DC	DIL2M-G(...)	DIL2AM-G(...)	DIL3M80(...)	DIL4M115(...)	V-GDIL(...)
	Article No. <sup>1)</sup>	Article No. <sup>1)</sup>	Article No. <sup>1)</sup>	Article No. <sup>1)</sup>	Article No. <sup>1)</sup>
Standard voltages	List Price see price list	List Price see price list	List Price see price list	List Price see price list	List Price see price list
24V DC	048615 <sup>3)</sup>	048610 <sup>3)</sup>	209709	209765	048562
48V DC	048616 <sup>3)</sup>	048611 <sup>3)</sup>	209710	209766	048563
60V DC	048617	048612	209711	209767	048564
110V DC	048613	048608	209712	209768	048560
220V DC	048614	048609	209713	209769	048561
Special voltages (i.e. voltages other than the standard voltages listed above) <sup>2)</sup>	List Price see price list	List Price see price list	List Price see price list	List Price see price list	List Price see price list
...V DC (12-250V)	100902	100892	-	-	100293
...V DC (24-250V)	-	-	209714	209770	-

**Notes:**

- <sup>1)</sup> To obtain the article number for ordering, read under selected type and coil voltage from the table above. Devices with **dual-voltage coils** must be ordered using **one** article number.
- <sup>2)</sup> When ordering special voltages, state the operating voltage selected from the range (...-...V) shown.
- <sup>3)</sup> Contactors with these coil voltages are normal stock items.

# DIL00M to DIL1AM Complete Units

## Coil Voltages

Magnetic Contactors,  
Magnetic Starters



AC	DIL00M -10(...)	DIL00M -01(...)	DIL00M /11(...)	DIL00M /22(...)	DIL00AM -10(...)	DIL00AM -01(...)	DIL00AM /11(...)	DIL00AM /22(...)	DIL0M /11(...)	DIL0M /22(...)
	Article No. <sup>1)</sup>	Article No. <sup>1)</sup>	Article No. <sup>1)</sup>	Article No. <sup>1)</sup>	Article No. <sup>1)</sup>	Article No. <sup>1)</sup>	Article No. <sup>1)</sup>	Article No. <sup>1)</sup>	Article No. <sup>1)</sup>	Article No. <sup>1)</sup>
Standard voltages	List Price see price list	List Price see price list	List Price see price list	List Price see price list	List Price see price list	List Price see price list	List Price see price list	List Price see price list	List Price see price list	List Price see price list
24V 50Hz	020408	039393	047562	028579	000106	033327	068923	035702	033237	000016
48V 50Hz	027527	046512	059427	040444	078414	057057	092653	011972	061713	026119
240V 50Hz	037019	063123	045189	026206	007225	026208	061804	045194	026118	094935
500V 50Hz	044138	060750	061800	042817	071295	064176	099772	004853	064086	033238
24V 60Hz	048884 <sup>3)</sup>	013290 <sup>3)</sup>	076038 <sup>3)</sup>	057055 <sup>3)</sup>	002479 <sup>3)</sup>	030954 <sup>3)</sup>	066550 <sup>3)</sup>	038075 <sup>3)</sup>	035610 <sup>3)</sup>	002389 <sup>3)</sup>
115V 60Hz	058376	022782	085530	066547	023836	009597	045193	059432	011880	080697
208V 60Hz	210228 <sup>3)</sup>	210226 <sup>3)</sup>	100754 <sup>3)</sup>	100758 <sup>3)</sup>	210222 <sup>3)</sup>	210220 <sup>3)</sup>	100731 <sup>3)</sup>	100735 <sup>3)</sup>	100793 <sup>3)</sup>	100797 <sup>3)</sup>
600V 60Hz	210229 <sup>3)</sup>	210227 <sup>3)</sup>	100755 <sup>3)</sup>	100759 <sup>3)</sup>	210223 <sup>3)</sup>	210221 <sup>3)</sup>	100732 <sup>3)</sup>	100736 <sup>3)</sup>	100794 <sup>3)</sup>	100798 <sup>3)</sup>
42V 50Hz, 48V 60Hz	046642	046650	046658	046666	046674	046682	046690	046698	046706	046714
110V 50Hz, 120V 60Hz	046643 <sup>3)</sup>	046651 <sup>3)</sup>	046659 <sup>3)</sup>	046667 <sup>3)</sup>	046675 <sup>3)</sup>	046683 <sup>3)</sup>	046691 <sup>3)</sup>	046699 <sup>3)</sup>	046707 <sup>3)</sup>	046715 <sup>3)</sup>
190V 50Hz, 220V 60Hz	046644	046652	046660	046668	046676	046684	046692	046700	046708	046716
220V 50Hz, 240V 60Hz	046645	046653	046661	046669	046677	046685	046693	046701	046709	046717
230V 50Hz, 240V 60Hz	046646 <sup>3)</sup>	046654 <sup>3)</sup>	046662 <sup>3)</sup>	046670 <sup>3)</sup>	046678 <sup>3)</sup>	046686 <sup>3)</sup>	046694 <sup>3)</sup>	046702 <sup>3)</sup>	046710 <sup>3)</sup>	046718 <sup>3)</sup>
380V 50Hz, 440V 60Hz	046647	046655	046663	046671	046679	046687	046695	046703	046711	046719
400V 50Hz, 440V 60Hz	046648	046656	046664	046672	046680	046688	046696	046704	046712	046720
415V 50Hz, 480V 60Hz	046649 <sup>3)</sup>	046657 <sup>3)</sup>	046665 <sup>3)</sup>	046673 <sup>3)</sup>	046681 <sup>3)</sup>	046689 <sup>3)</sup>	046697 <sup>3)</sup>	046705 <sup>3)</sup>	046713 <sup>3)</sup>	046721 <sup>3)</sup>
24V 50/60Hz	072614	098717	092649	007222	004852	028581	064177	040448	030864	099681
42V 50/60Hz	034842	088382	088421	088443	088530	088504	088553	088579	047475	014254
110V 50/60Hz	077360	093971	087903	011968	028582	004851	040447	064178	004761	073578
230V 50/60Hz	043526	043444	045663	045815	043305	044083	044190	045181	047934	048051
380V 50/60Hz	082106	089225	095022	004849	097398	038073	073669	030956	040356	007135
Special voltages (i.e. voltages other than the standard voltages listed above) <sup>2)</sup>	List Price see price list	List Price see price list	List Price see price list	List Price see price list	List Price see price list	List Price see price list	List Price see price list	List Price see price list	List Price see price list	List Price see price list
...V 50Hz (12-600V)	100741	100739	100752	100756	100718	100716	100729	100733	100791	100795
...V 60Hz (12-600V)	100742	100740	100753	100757	100719	100717	100730	100734	100792	100796
DC	DIL00M -G-10(...)	DIL00M -G-01(...)	DIL00M -G/11(...)	DIL00M -G/22(...)	DIL00AM -G-10(...)	DIL00AM -G-01(...)	DIL00AM -G/11(...)	DIL00AM -G/22(...)	DIL0M -G/11(...)	DIL0M -G/22(...)
	Article No. <sup>1)</sup>	Article No. <sup>1)</sup>	Article No. <sup>1)</sup>	Article No. <sup>1)</sup>	Article No. <sup>1)</sup>	Article No. <sup>1)</sup>	Article No. <sup>1)</sup>	Article No. <sup>1)</sup>	Article No. <sup>1)</sup>	Article No. <sup>1)</sup>
Standard voltages	List Price see price list	List Price see price list	List Price see price list	List Price see price list	List Price see price list	List Price see price list	List Price see price list	List Price see price list	List Price see price list	List Price see price list
24V DC	048670 <sup>3)</sup>	048665 <sup>3)</sup>	048675 <sup>3)</sup>	048680 <sup>3)</sup>	048650 <sup>3)</sup>	048645 <sup>3)</sup>	048655 <sup>3)</sup>	048660 <sup>3)</sup>	048686 <sup>3)</sup>	048953 <sup>3)</sup>
48V DC	048671 <sup>3)</sup>	048666 <sup>3)</sup>	048676 <sup>3)</sup>	048681 <sup>3)</sup>	048651 <sup>3)</sup>	048646 <sup>3)</sup>	048656 <sup>3)</sup>	048661 <sup>3)</sup>	048687 <sup>3)</sup>	048954 <sup>3)</sup>
60V DC	048672	048667	048677	048682	048652	048647	048657	048662	048688	048955
110V DC	048668	048663	048673	048678	048648	048643	048653	048658	048684	048689
220V DC	048669	048664	048674	048679	048649	048644	048654	048659	048685	048898
Special voltages (i.e. voltages other than the standard voltages listed above) <sup>2)</sup>	List Price see price list	List Price see price list	List Price see price list	List Price see price list	List Price see price list	List Price see price list	List Price see price list	List Price see price list	List Price see price list	List Price see price list
...V DC (12-250V)	100745	100744	100746	100749	100722	100721	100723	100726	100785	100788

**Notes:**

- <sup>1)</sup> To obtain the article number for ordering, read under selected type and coil voltage from the table above. Devices with **dual-voltage coils** must be ordered using **one** article number.
- <sup>2)</sup> When ordering special voltages, state the operating voltage selected from the range (...-...V) shown.
- <sup>3)</sup> Contactors with these coil voltages are normal stock items.

## DIL0AM to DIL4M115 Complete Units Coil Voltages

Magnetic Contactors,  
Magnetic Starters



AC	DIL0AM/ 11(...)	DIL0AM/ 22(...)	DIL1M/22(...)	DIL1AM/ 22(...)	DIL2M/ 22(...)	DIL2AM/ 22(...)	DIL3M80/ 22(...)	DIL4M115/ 22(...)
	Article No. <sup>1)</sup>	Article No. <sup>1)</sup>	Article No. <sup>1)</sup>	Article No. <sup>1)</sup>	Article No. <sup>1)</sup>	Article No. <sup>1)</sup>	Article No. <sup>1)</sup>	Article No. <sup>1)</sup>
Standard voltages	List Price see price list	List Price see price list	List Price see price list	List Price see price list	List Price see price list	List Price see price list	List Price see price list	List Price see price list
24V 50Hz	078321	045100	054603	016633	009526	040373	209858	209913
48V 50Hz	002386	071203	083079	045109	038002	068849	209859	209914
240V 50Hz	071202	037981	049857	011887	004780	035627	209860	209915
500V 50Hz	009505	075949	085452	047482	040375	071222	209861	209916
24V 60Hz	080694 <sup>3)</sup>	047473 <sup>3)</sup>	056976 <sup>3)</sup>	019006 <sup>3)</sup>	011899 <sup>3)</sup>	042746 <sup>3)</sup>	209863 <sup>3)</sup>	209917 <sup>3)</sup>
115V 60Hz	056964	023743	033246	097314	090207	019016	209864	209918
208V 60Hz	100775 <sup>3)</sup>	100779 <sup>3)</sup>	100825 <sup>3)</sup>	100813 <sup>3)</sup>	100908 <sup>3)</sup>	100898 <sup>3)</sup>	100988 <sup>3)</sup>	101007 <sup>3)</sup>
600V 60Hz	100776 <sup>3)</sup>	100780 <sup>3)</sup>	100826 <sup>3)</sup>	100814 <sup>3)</sup>	100909 <sup>3)</sup>	100899 <sup>3)</sup>	100989 <sup>3)</sup>	101008 <sup>3)</sup>
42V 50Hz, 48V 60Hz	046752	046760	046768	046776	046784	046792	209865	209919
110V 50Hz, 120V 60Hz	046753 <sup>3)</sup>	046761 <sup>3)</sup>	046769 <sup>3)</sup>	046777 <sup>3)</sup>	046785 <sup>3)</sup>	046793 <sup>3)</sup>	209866 <sup>3)</sup>	209920 <sup>3)</sup>
190V 50Hz, 220V 60Hz	046754	046762	046770	046778	046786	046794	209867	209921
220V 50Hz, 240V 60Hz	046755	046763	046771	046779	046787	046795	209868	209922
230V 50Hz, 240V 60Hz	046756 <sup>3)</sup>	046764 <sup>3)</sup>	046772 <sup>3)</sup>	046780 <sup>3)</sup>	046788 <sup>3)</sup>	046796 <sup>3)</sup>	209869 <sup>3)</sup>	209923 <sup>3)</sup>
380V 50Hz, 440V 60Hz	046757	046765	046773	046781	046789	046797	209870	209924
400V 50Hz, 440V 60Hz	046758	046766	046774	046782	046790	046798	209871	209925
415V 50Hz, 480V 60Hz	046759 <sup>3)</sup>	046767 <sup>3)</sup>	046775 <sup>3)</sup>	046783 <sup>3)</sup>	046791 <sup>3)</sup>	046799 <sup>3)</sup>	209872 <sup>3)</sup>	209926 <sup>3)</sup>
24V 50/60Hz	075948	042727	052230	014260	007153	038000	209873	209927
42V 50/60Hz	092559	059338	068841	030871	023764	054611	209874	209928
110V 50/60Hz	049845	016624	026127	090195	083088	011897	209875	209929
230V 50/60Hz	047469	047556	048243	048181	049861	048415	209876	209930
380V 50/60Hz	085440	052219	061722	023752	016645	047492	209877	209931
Special voltages (i.e. voltages other than the standard voltages listed above) <sup>2)</sup>	List Price see price list	List Price see price list	List Price see price list	List Price see price list	List Price see price list	List Price see price list	List Price see price list	List Price see price list
...V 50Hz (12-600V)	100773	100777	-	-	-	-	-	-
...V 50Hz (24-600V)	-	-	100823	100811	100906	100896	209878	209932
...V 60Hz (12-600V)	100774	100778	-	-	-	-	-	-
...V 60Hz (24-600V)	-	-	100824	100812	100907	100897	209879	209933
DC	DIL0AM -G/11(...)	DIL0AM -G/22(...)	DIL1M -G/22(...)	DIL1AM -G/22(...)	DIL2M -G/22(...)	DIL2AM -G/22(...)	DIL3M80 /22(...)	DIL4M115 /22(...)
	Article No. <sup>1)</sup>	Article No. <sup>1)</sup>	Article No. <sup>1)</sup>	Article No. <sup>1)</sup>	Article No. <sup>1)</sup>	Article No. <sup>1)</sup>	Article No. <sup>1)</sup>	Article No. <sup>1)</sup>
Standard voltages	List Price see price list	List Price see price list	List Price see price list	List Price see price list	List Price see price list	List Price see price list	List Price see price list	List Price see price list
24V DC	049000 <sup>3)</sup>	049997 <sup>3)</sup>	051692 <sup>3)</sup>	050858 <sup>3)</sup>	051702 <sup>3)</sup>	051697 <sup>3)</sup>	209880 <sup>3)</sup>	209934 <sup>3)</sup>
48V DC	049001 <sup>3)</sup>	050269 <sup>3)</sup>	051693 <sup>3)</sup>	051318 <sup>3)</sup>	051703 <sup>3)</sup>	051698 <sup>3)</sup>	209881 <sup>3)</sup>	209935 <sup>3)</sup>
60V DC	049869	050270	051694	051480	051704	051699	209882	209936
110V DC	048998	049870	051690	050368	051700	051695	209883	209937
220V DC	048999	049871	051691	050546	051701	051696	209884	209938
Special voltages (i.e. voltages other than the standard voltages listed above) <sup>2)</sup>	List Price see price list	List Price see price list	List Price see price list	List Price see price list	List Price see price list	List Price see price list	List Price see price list	List Price see price list
...V DC (12-250V)	100767	100770	100818	100808	100903	100893	-	-
...V DC (24-250V)	-	-	-	-	-	-	209885	209939

### Notes:

<sup>1)</sup> To obtain the article number for ordering, read under selected type and coil voltage from the table above. Devices with **dual-voltage coils** must be ordered using **one** article number.

<sup>2)</sup> When ordering special voltages, state the operating voltage selected from the range (...-...V) shown.

<sup>3)</sup> Contactors with these coil voltages are normal stock items.

# DILM185 to DILM820 Complete Units, Electronic Modules including Coils

## Coil Voltages

Complete Devices	DILM185 /22(...)	DILM225 /22(...)	DILM250 /22(...)	DILM300 /22(...)	DILM400 /22(...)	DILM500 /22(...)	DILM580 /22(...)	DILM650 /22(...)	DILM750 /22(...)	DILM820 /22(...)
	Article No. <sup>1)</sup>	Article No. <sup>1)</sup>	Article No. <sup>1)</sup>	Article No. <sup>1)</sup>	Article No. <sup>1)</sup>	Article No. <sup>1)</sup>	Article No. <sup>1)</sup>	Article No. <sup>1)</sup>	Article No. <sup>1)</sup>	Article No. <sup>1)</sup>
Voltage version	List Price	List Price	List Price	List Price	List Price	List Price	List Price	List Price	List Price	List Price see price list
	see price list	see price list	see price list	see price list	see price list	see price list	see price list	see price list	see price list	see price list
RDC 48 <sup>2)</sup>	208191 <sup>7)</sup>	208195 <sup>7)</sup>	208199 <sup>7)</sup>	208203 <sup>7)</sup>	208207 <sup>7)</sup>	208211 <sup>7)</sup>	–	–	–	–
RA 110 <sup>3)</sup>	208192	208196	208200	208204	208208	208212	208215	208218	208221	–
RA 250 <sup>4)</sup>	208193 <sup>7)</sup>	208197 <sup>7)</sup>	208201 <sup>7)</sup>	208205 <sup>7)</sup>	208209 <sup>7)</sup>	208213 <sup>7)</sup>	208216	208219	208222	208225
RAC 500 <sup>5)</sup>	208194	208198	208202	208206	208210	208214	208217	208220	208223	208226

**Magnetic Contactors,  
Magnetic Starters**

Electronic module including coil	DILM250-XSP/E(...)	DILM500-XSP/E(...)	DILM820-XSP/E(...)
	Article No. <sup>1)</sup>	Article No. <sup>1)</sup>	Article No. <sup>1)</sup>
Voltage version	List Price see price list	List Price see price list	List Price see price list
RDC 48 <sup>2)</sup>	208250	208254	–
RA 110 <sup>3)</sup>	208251	208255	–
RA 250 <sup>4)</sup>	208252	208256	208259
RAC 500 <sup>5) 6)</sup>	208253	208257	208260

**Notes:**

- <sup>1)</sup> To obtain the article number for ordering, read under selected type and voltage version from the table above.
- <sup>2)</sup> 24 – 48 V DC
- <sup>3)</sup> 48 – 110 V 40 – 60 Hz/DC
- <sup>4)</sup> 110 – 250 V 40 – 60 Hz/DC
- <sup>5)</sup> 250 – 500 V 40 – 60 Hz/DC
- <sup>6)</sup> DC on request
- <sup>7)</sup> Contactors with these coil voltages are normal stock items.

## DIULEM to DIUL4M115 Open Contactor Combinations

### Coil Voltages

Magnetic Contactors,  
Magnetic Starters



AC	DIULEM/21 /MV(...)	DIUL 00AM /11/MV(...)	DIUL0M/11/ MV(...)	DIUL0AM/11/ MV(...)	DIUL1AM/11/ MV(...)	DIUL2AM/11/ MV(...)	DIUL3M80/ 11/MV(...)	DIUL4M115/11/ MV(...)
	Article No. <sup>1)</sup>	Article No. <sup>1)</sup>	Article No. <sup>1)</sup>	Article No. <sup>1)</sup>	Article No. <sup>1)</sup>	Article No. <sup>1)</sup>	Article No. <sup>1)</sup>	Article No. <sup>1)</sup>
Standard voltages	List Price see price list	List Price see price list	List Price see price list	List Price see price list	List Price see price list	List Price see price list	List Price see price list	List Price see price list
12V 50Hz	068300	–	–	–	–	–	–	–
24V 50Hz	000073	110189	110206	110223	110238	110254	110269	110287
48V 50Hz	000105	110190	110207	110224	110239	110255	110271	110288
240V 50Hz	000215	110191	110209	110225	110240	110256	110272	110289
24V 60Hz	000074	110192	110210	110226	110241	110257	110273	110290
110V 60Hz	000127	–	–	–	–	–	–	–
115V 60Hz	000128	110193	110211	110227	110242	110258	110274	110291
208V 60Hz	–	110196	110212	110228	110243	110259	110275	110292
600V 60Hz	–	110197	110213	110229	110244	110260	110276	110293
42V 50Hz, 48V 60Hz	051845	110198	110214	110230	110245	110261	110277	110294
110V 50Hz, 120V 60Hz	051846	110199	110215	110231	110246	110262	110278	110295
190V 50Hz, 220V 60Hz	051847	110200	110216	110232	110247	110263	110279	110296
220V 50Hz, 240V 60Hz	051848	110201	110217	110233	110248	110264	110280	110297
230V 50Hz, 240V 60Hz	051849	110202	110218	110234	110249	110265	110281	110298
380V 50Hz, 440V 60Hz	051850	110203	110219	110235	110250	110266	110282	110299
400V 50Hz, 440V 60Hz	051851	110204	110220	110236	110251	110267	110283	110300
415V 50Hz, 480V 60Hz	051852	110205	110221	110237	110252	110268	110284	110301
Special voltages (i.e. voltages other than the standard voltages listed above) <sup>2)</sup>	–	List Price see price list	List Price see price list	List Price see price list	List Price see price list	List Price see price list	List Price see price list	List Price see price list
...V 50Hz (12–600V)	–	110178	110180	110182	–	–	–	–
...V 50Hz (24–600V)	–	–	–	–	110185	110187	110285	110302
...V 60Hz (12–600V)	–	110179	110181	110183	–	–	–	–
...V 60Hz (24–600V)	–	–	–	–	110186	110188	110286	110303

#### Notes:

- <sup>1)</sup> To obtain the article number for ordering, read under selected type and coil voltage from the table above.  
Devices with **dual-voltage coils** must be ordered using **one** article number.
- <sup>2)</sup> When ordering special voltages, state the operating voltage selected from the range (...-...V) shown.

# DIL00M to DIL4M Individual Coils

## Coil Voltages

Magnetic Contactors,  
Magnetic Starters



AC	J-DIL00M(...)	J-DILOM(...)	J-DIL1M(...)	J-DIL2M(...)	J-DIL3M(...)	J-DIL4M(...)
	Article No. <sup>1)</sup>	Article No. <sup>1)</sup>	Article No. <sup>1)</sup>	Article No. <sup>1)</sup>	Article No. <sup>1)</sup>	Article No. <sup>1)</sup>
Standard voltages	List Price see price list	List Price see price list	List Price see price list	List Price see price list	List Price see price list	List Price see price list
24V 50Hz	000079	061777	097373	057034	050843	062815
48V 50Hz	023809	057031	000081	052288	051144	062816
240V 50Hz	066693	093006	097752	005206	052232	062817
500V 50Hz	080760	047539	009573	042796	052504	062818
24V 60Hz	099744 <sup>3)</sup>	064150 <sup>3)</sup>	026184 <sup>3)</sup>	059407 <sup>3)</sup>	053518 <sup>3)</sup>	062819 <sup>3)</sup>
115V 60Hz	043837	047435	047447	047937	053594	062820
208V 60Hz	210267 <sup>3)</sup>	210269 <sup>3)</sup>	210271 <sup>3)</sup>	210273 <sup>3)</sup>	101817 <sup>3)</sup>	101826 <sup>3)</sup>
600V 60Hz	210268 <sup>3)</sup>	210270 <sup>3)</sup>	210272 <sup>3)</sup>	210274 <sup>3)</sup>	101818 <sup>3)</sup>	101827 <sup>3)</sup>
42V 50Hz, 48V 60Hz	043829 <sup>3)</sup>	047436 <sup>3)</sup>	047448 <sup>3)</sup>	048014 <sup>3)</sup>	048918 <sup>3)</sup>	048929 <sup>3)</sup>
110V 50Hz, 120V 60Hz	043830 <sup>3)</sup>	047437 <sup>3)</sup>	047449 <sup>3)</sup>	048015 <sup>3)</sup>	048919 <sup>3)</sup>	048930 <sup>3)</sup>
190V 50Hz, 220V 60Hz	043831	047438	047450	048016	048920	048931
220V 50Hz, 240V 60Hz	043832	047439	047451	048151	048921	048932
230V 50Hz, 240V 60Hz	043833 <sup>3)</sup>	047440 <sup>3)</sup>	047452 <sup>3)</sup>	048233 <sup>3)</sup>	048922 <sup>3)</sup>	048933 <sup>3)</sup>
380V 50Hz, 440V 60Hz	043834	047441	047453	048398	048923	048934
400V 50Hz, 440V 60Hz	043835	047442	047454	048486	048924	048935
415V 50Hz, 480V 60Hz	043836 <sup>3)</sup>	047443 <sup>3)</sup>	047455 <sup>3)</sup>	048772 <sup>3)</sup>	048925 <sup>3)</sup>	048936 <sup>3)</sup>
24V 50/60Hz	002452	030928	028557	090256	055397	062838
42V 50/60Hz	011944	033301	030930	087883	055481	062839
110V 50/60Hz	085506	038047	035676	083137	055568	062841
230V 50/60Hz	051352	050193	050194	050195	050196	050197
380V 50/60Hz	004825	042793	040422	078391	055891	062843
Special voltages (i.e. voltages other than the standard voltages listed above) <sup>2)</sup>	List Price see price list	List Price see price list	List Price see price list	List Price see price list	List Price see price list	List Price see price list
...V 50Hz (12–600V)	101795	101797	–	–	–	–
...V 50Hz (24–600V)	–	–	101806	101808	101815	101824
...V 60Hz (12–600V)	101796	101798	–	–	–	–
...V 60Hz (24–600V)	–	–	101807	101809	101816	101825
DC	G-DIL00M(...)	G-DILOM(...)	G-DIL1M(...)	G-DIL2M(...)	G-DIL3M(...)	G-DIL4M(...)
	Article No. <sup>1)</sup>	Article No. <sup>1)</sup>	Article No. <sup>1)</sup>	Article No. <sup>1)</sup>	Article No. <sup>1)</sup>	Article No. <sup>1)</sup>
Standard voltages	List Price see price list	List Price see price list	List Price see price list	List Price see price list	List Price see price list	List Price see price list
24V DC	048557 <sup>3)</sup>	063206 <sup>3)</sup>	063211 <sup>3)</sup>	063216 <sup>3)</sup>	063221 <sup>3)</sup>	063226 <sup>3)</sup>
48V DC	048558 <sup>3)</sup>	063207 <sup>3)</sup>	063212 <sup>3)</sup>	063217 <sup>3)</sup>	063222 <sup>3)</sup>	063227 <sup>3)</sup>
60V DC	048559	063208	063213	063218	063223	063228
110V DC	048555	063204	063209	063214	063219	063224
220V DC	048556	063205	063210	063215	063220	063225
Special voltages (i.e. voltages other than the standard voltages listed above) <sup>2)</sup>	List Price see price list	List Price see price list	List Price see price list	List Price see price list	List Price see price list	List Price see price list
...V DC (12–250V)	101775	101776	101777	101780	–	–
...V DC (24–250V)	–	–	–	–	101784	101789

### Notes:

- <sup>1)</sup> To obtain the article number for ordering, read under selected type and coil voltage from the table above. Devices with **dual-voltage coils** must be ordered using **one** article number.
- <sup>2)</sup> When ordering special voltages, state the operating voltage selected from the range (...-...V) shown.
- <sup>3)</sup> Coils in these voltages are normal stock items.

## Contactors for DC Loads

### AC or DC operated coil

**Magnetic Contactors,  
Magnetic Starters**

UL/CSA max. DC Hp rating		General use continuous current AC/DC open/ enclosed	AC operated		Open	DC operated		Open
125 V HP	250 V HP		Type	Article No.	List Price	Type	Article No.	List Price
3 pole break			Coil voltages shown in (...) For other voltages, → page 03/065, 066		see price list	Coil voltages shown in (...) For other voltages, → page 03/065, 066		see price list
4 pole								
1	2	20/18	<b>DIL00M4 (120V60HZ)</b> 046926			<b>DIL00M4-G (24VDC)</b> 063171		
3 pole								
1	2	20/18	<b>DIL00M (120V60HZ)</b> 060477			<b>DIL00M-G (24VDC)</b> 048587		
			<b>DIL00M-10 (120V60HZ)</b> 046643			<b>DIL00M-G-10 (24VDC)</b> 048670		
			<b>DIL00M-01 (120V60HZ)</b> 046651			<b>DIL00M-G-01 (24VDC)</b> 048665		
1 ½	3	20/18	<b>DIL00AM (120V60HZ)</b> 061222			<b>DIL00AM-G (24VDC)</b> 048567		
			<b>DIL00AM-10 (120V60HZ)</b> 046675			<b>DIL00AM-G-10 (24VDC)</b> 048650		
			<b>DIL00AM-01 (120V60HZ)</b> 046683			<b>DIL00AM-G-01 (24VDC)</b> 048645		
2	5	35/31	<b>DIL0M (120V60HZ)</b> 061262			<b>DIL0M-G (24VDC)</b> 048592		
5	10	55/50	<b>DIL1M (120V60HZ)</b> 061270			<b>DIL1M-G (24VDC)</b> 048605		
7 ½	15	90/81	<b>DIL2M (120V60HZ)</b> 046563			<b>DIL2M-G (24VDC)</b> 048615		
10	20	90/81	<b>DIL2AM (120V60HZ)</b> 046571			<b>DIL2AM-G (24VDC)</b> 048610		
10	20	100/90	<b>DIL3M80 (120V60HZ)</b> 209691			<b>DIL3M80 (24VDC)</b> 209709		
15	30	160/144	<b>DIL4M115 (120V60HZ)</b> 209750			<b>DIL4M115 (24VDC)</b> 209765		

**To order specify:**

Type number

Coil voltage

Accessories

**DIL00M-G (120V60HZ)**  
 Type ——— Coil voltage

**Additional information**

Technical data

Dimensions

Overload relays

Accessories

Weights

**Page**

03/080

03/091

04/004

03/053

14/020



## DIL Contactors

### Special Purpose - Resistive Heating Contactors

Max. kW rating		No. of poles	Resistive amperes per pole at 600 V AC (open)	Type Article No. <sup>1)</sup> (open)	List Price				
Single phase	Three phase					Open			
115 V	230 V	200 V	230 V	460 V	575 V	Specify coil voltage and frequency → below			
kW	kW	kW	kW	kW	kW	(...)			
4.4	8.6	-	-	-	-	1	37.5	DILH00M4/P1 (...)	see price list
10	20.2	-	-	-	-	1	88	DILH0M/P1 (...)	
15.9	31.7	-	-	-	-	1	138	DILH1M/P1 (...)	
25.9	51.8	-	-	-	-	1	225	DILH2M/P1 (...)	
1.7	3.4	5.2	6	12	15	3	15	DILH00M (...)	
4	8	12	13.9	27.8	34.8	3	35	DILH0M (...)	
6.6	12.7	19	21.9	43.8	55	3	55	DILH1M (...)	
10.4	20.7	31.1	35.8	71.6	90	3	90	DILH2M (...)	

 Magnetic Contactors,  
Magnetic Starters

The above kW ratings are based on a maximum inrush current of 1.4 times the rated current. When selecting contactors, it is necessary to keep in mind that, in contrast to motors, the current in an electric heating application will increase in proportion to a voltage increase. Therefore, unless the supply voltage can be guaranteed not to exceed the 200, 230, 480 or 575 volt values shown above, the contactor should be selected for a current not greater than 90% of their rated current at rated voltage, to take into account normal supply voltage fluctuations. Devices are CSA approved for duct heating - minimum 250,000 cycles of operation.

#### To order specify:

Type number  
Coil voltage  
Accessories

DILH1M, (120V60HZ)

Type      Coil voltage

Additional information	Page
Technical data	03/080
Dimensions	03/091
Accessories	03/053
Weights	14/020

#### Actuating voltages

AC		DILH00M	DILH00M4/P1	DILH0M	DILH0M/P1	DILH1M	DILH1M/P1	DILH2M	DILH2M/P1
		Article No. <sup>1)</sup>	Article No. <sup>1)</sup>	Article No. <sup>1)</sup>	Article No. <sup>1)</sup>	Article No. <sup>1)</sup>	Article No. <sup>1)</sup>	Article No. <sup>1)</sup>	Article No. <sup>1)</sup>
Standard voltages	List Price	see price list	see price list	see price list	see price list	see price list	see price list	see price list	see price list
24V 60Hz		101025	101032	101039	101046	101053	101060	101067	101074
208V 60Hz		101023	101030	101037	101044	101051	101058	101065	101072
600V 60Hz		101027	101034	101041	101048	101055	101062	101069	101076
110V 50Hz, 120V 60Hz		101022	101029	101036	101043	101050	101057	101064	101071
230V 50Hz, 240V 60Hz		101024	101031	101038	101045	101052	101059	101066	101073
415V 50Hz, 480V 60Hz		101026	101033	101040	101047	101054	101061	1101068	101075
Non-standard voltages (i.e. voltages other than the standard voltages listed above <sup>2)</sup> :	List Price	see price list	see price list	see price list	see price list	see price list	see price list	see price list	see price list
...V 50Hz (12 - 600V)		101021	101028	101035	101042	-	-	-	-
...V 50Hz (24 - 600V)		-	-	-	-	101049	101056	101063	101070
...V 60Hz (12 - 600V)		110304	110305	110306	110307	-	-	-	-
...V 60Hz (24 - 600V)		-	-	-	-	110308	110309	110310	110311

Notes:

- <sup>1)</sup> to obtain the article number for ordering, read under selected type and coil voltage from the table above.
- <sup>2)</sup> When ordering non-standard voltages, state the actuating voltage selected from the range (...-...V) shown.

# Contactors Selection Guide

Magnetic Contactors,  
Magnetic Starters

## Contactors

By far the most common application of contactors is the control of electrical motors. As a prime mover, the 3-phase AC motor, in particular the squirrel-cage motor, dominates the field, and most of them are controlled by contactors. Contactors are expected to start, stop, reverse, plug, jog and sequence motors and, in conjunction with overload relays, to protect motors in the event of overloads. The load rating stated in HP is the basic data required to enable the correct selection of contactors to be made, but this figure by itself is not always sufficient. The type of load, its operating cycle, switching frequency and total life required, all influence the overall stress on contactors. The electrical durability tests of contactors, outlined in appendix B of IEC 60 947-4, are used by manufacturers to establish contactor ratings which incorporate a sufficient and verifiable

switching capability to cover a broad range of applications as defined in the IEC utilization categories (e.g. AC-3, AC-4). The IEC 60 947 standard states that, with respect to its resistance to electrical wear, a contactor or starter is by convention characterized by the number of On-load operating cycles corresponding to the different utilization categories which can be made without repair or replacement. The IEC utilization categories AC-3 and AC-4 are most often encountered in contactor applications and are outlined below. See section 14 of this catalog for additional details.

The curves at right provide a reliable guide for selection based on the electrical life desired.

### Normal switching duty AC-3 for squirrel-cage motors

Operating characteristics:	Starting: from rest
	Stopping: after attaining full running speed
Typical applications:	Compressors, Elevators, Mixers, Pumps, Escalators, Agitators, Fans, Conveyors, Centrifuges, Valves Bucket elevators Airconditioning
Electrical characteristics:	Drives in general in manufacturing and processing machines Make: up to 6 x rated motor current Break: 1 x rated motor current
Utilization category:	100% AC-3

### Extreme switching duty AC-4 for squirrel-cage motors

Operating characteristics:	switching, plugging, reversing
Typical applications:	Printing presses, Centrifuges, Wire-drawing machines Special drives for manufacturing and processing machines
Electrical characteristics:	Make: 6 x rated motor current Break: 6 x rated motor current
Utilization category:	100% AC-4



## Determination of the maximum number of operations per hour in relation to rating and utilization category

$P_N$  = Max. motor rating (kW/HP) of the contactor → pages 03/002, 003

S/h = Max. number of operations per hour

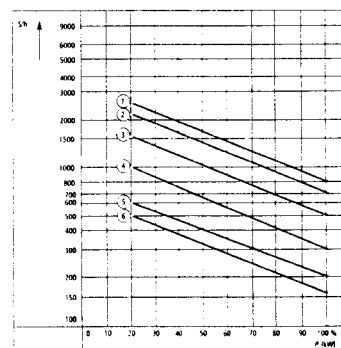
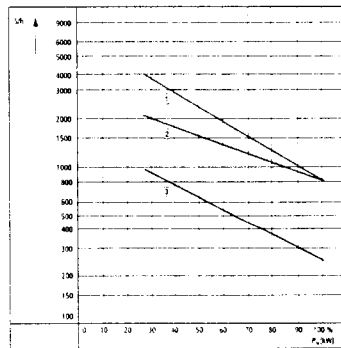

Type	AC-1	AC-3	AC-2 AC-4
DIL EM	2	1	3
DIL 00 M(-G)	2	1	3
DIL 00 AM(-G)	2	1	3
DIL 0 M(-G)	2	1	3
DIL 0 AM(-G)	2	1	3
DIL 1 M(-G)	2	1	3
DIL 1 AM(-G)	2	1	3
DIL 2 M(-G)	2	1	3
DIL 2 AM(-G)	2	1	3

Type	AC-1	AC-3	AC-4
DIL 3M 80	1	1	4
DIL 4M 115	1	1	4
DIL M 185	1	2	5
DIL M 225	1	2	5
DIL M 250	1	2	5
DIL M 300	2	3	6
DIL M 400	2	3	6
DIL M 500	2	3	6
DIL M 650	2	3	6
DIL M 750	2	3	6
DIL M 820	2	3	6

# Contactors

## Utilization Category Selection Guide

Contactor life expectancy based on utilization categories at 460V, 50/60Hz

### AC-3

Electrical characteristics: Make: 6 x motor FLC  
Break: 1 x motor FLC

Normal switching duty: (100% AC-3)

Y axis (ordinate)

Bold numbers (HP): 3 phase motor HP rating at 50 - 60 Hz  
Green numbers (A): 3 phase motor FLC at 50 - 60 Hz

### AC-4

Electrical characteristics: Make: 6 x motor FLC  
Break: 6 x motor FLC

Extreme switching duty: inching, plugging (100% AC-4)

Y axis (ordinate)

Bold numbers (HP): 3 phase motor HP rating at 50 - 60 Hz  
Green numbers (A): 3 phase motor FLC at 50 - 60 Hz

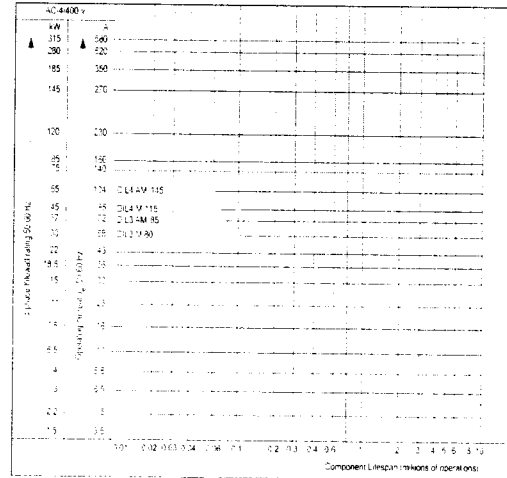
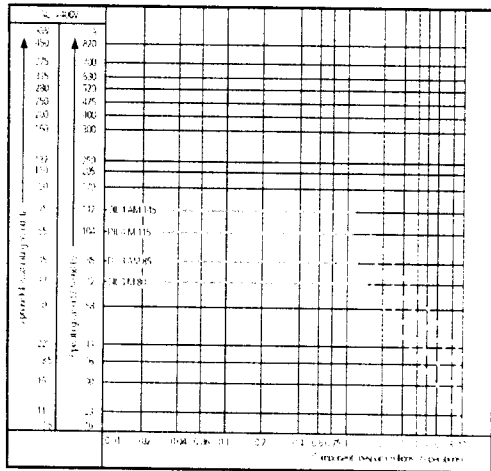
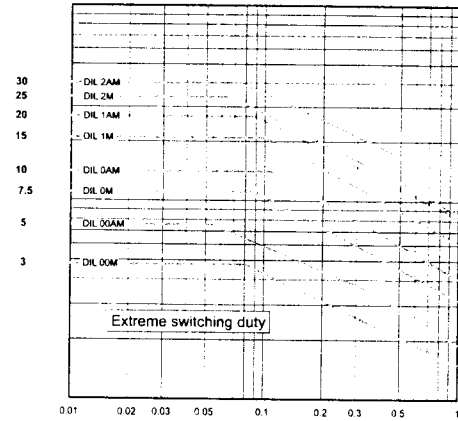
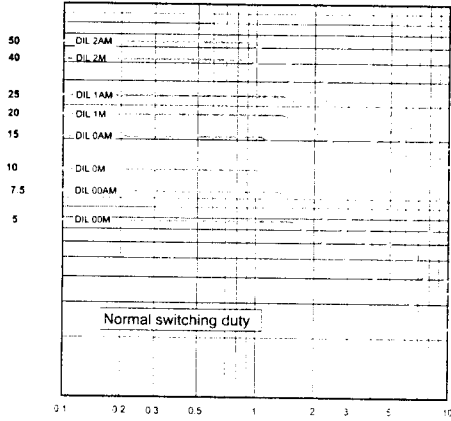

### S-PKZ2

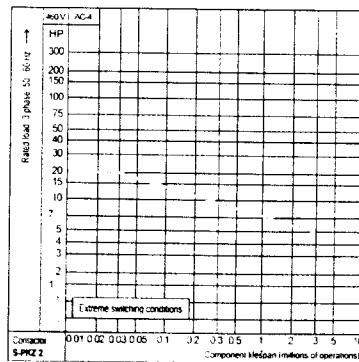
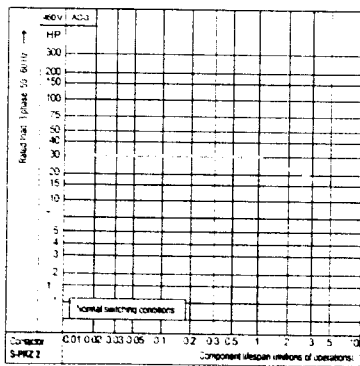

Notes:

- AC-3 and AC-4 lifespan values for DIL3M80 and DIL4M145 are determined at 400V AC. Apply a derating factor of 0.9 (90%) for corresponding 460V AC values.
- For 600V ratings and larger contactors, please contact Moeller Electric

Magnetic Contactors,  
Magnetic Starters



# DILEM Mini Contactors

## Technical Data



General			DIL EM	DIL EM-G	
Standards			UL, CSA, IEC/EN 60 947, VDE 0660,		
Mechanical lifespan	operations × 10 <sup>6</sup>		10	20	
Max. operating frequency	mechanical	ops./h	9000	9000	
	electrical		→ page 03/074		
Climatic proofing			Damp heat, constant to IEC 60 068-2- 3, Damp heat, cyclical to IEC 60 068-2-30		
Ambient temperature	open	min./max.	°C	-25/+50	-25/+50
	enclosed	min./max.	°C	-25/+40	-25/+40
Mounting position			as required, except vertical with terminals A1/A2 at the bottom		
					
Shock resistance (half-sinusoidal shock 10 ms)					
Basic device					
Main contacts	Make contacts	g	10	10	
Auxiliary contacts	Make/break contacts	g	10/8	10/8	
Basic device with auxiliary contact module					
Main contacts	Make contacts	g	10/8	10/8	
Auxiliary contacts	Make/break contacts	g	20	20	
Degree of protection		IP	20	20	
Protection against direct contact from the front when actuated by a perpendicular test finger (IEC 536)			Finger and back-of-hand proof		
Weight		kg	0,2	0,17	
Dimensions			→ page 03/091		
Terminal capacity of auxiliary and main contacts					
Solid		mm <sup>2</sup>	1 × (0,75 – 2,5)	1 × (0,75 – 2,5)	
		mm <sup>2</sup>	2 × (0,75 – 2,5)	2 × (0,75 – 2,5)	
Flexible with ferrule		mm <sup>2</sup>	1 × (0,75 – 1,5)	1 × (0,75 – 1,5)	
		mm <sup>2</sup>	2 × (0,75 – 1,5)	2 × (0,75 – 1,5)	
Solid or stranded	min.	AWG	18	18	
	max.	AWG	14	14	
Terminal screw			M3,5	M3,5	
Pozidriv screwdriver		size	2	2	
Standard screwdriver		mm	0,8 × 5,5	0,8 × 5,5	
		mm	1 × 6	1 × 6	
Max. tightening torque		Nm	1,2	1,2	

# DILEM Mini Contactors

## Technical Data



			DIL EM	DIL EM 4	DIL EM-G	
<b>Main contacts</b>						
Rated impulse withstand voltage $U_{imp}$		V	6000	6000	6000	
Overvoltage category / Pollution degree			III/3	III/3	III/3	
Rated insulation voltage $U_i$		V AC	690	690	690	
Rated operational voltage $U_e$		V AC	690	690	690	
Safe isolation to IEC 536 between coil and contact and between contacts		V AC	300	300	300	
Making capacity ( $\cos \varphi$ to IEC/EN 60 947)		A	110	110	110	
Breaking capacity ( $\cos \varphi$ to IEC/EN 60 947)	220 V/230 V	A	90	90	90	
	380 V/400 V	A	90	90	90	
	500 V	A	64	64	64	
	660 V/690 V	A	54	54	54	
Component lifespan AC-1, AC-3, AC-4	operations		→ page 03/074			
Short-circuit rating maximum fuse <sup>1)</sup>						
Type "2" coordination		A gL/gG	10	10	10	
Type "1" coordination		A gL/gG	20	20	20	
<b>AC</b>						
AC-1	Conv. thermal current $I_{th} \triangleq$ rated operational current $I_e$ 50 – 60 Hz, 3-pole	open at 40 °C	A	22	22	22
		at 50 °C	A	20	20	20
		at 55 °C	A	19	19	19
		enclosed <sup>2)</sup>	A	16	16	16
	1-pole	open <sup>2)</sup>	A	50	60	50
	Three/four main contacts in parallel	enclosed <sup>2)</sup>	A	40	50	40
	AC-3	Rated operational current $I_e$ open <sup>2)</sup> 50 – 60 Hz				
	220 V/230 V	A	8,8	8,8	8,8	
	240 V	A	8,8	8,8	8,8	
	380 V/400 V	A	8,8	8,8	8,8	
	415 V	A	8,8	8,8	8,8	
	440 V	A	8,8	8,8	8,8	
	500 V	A	6,4	6,4	6,4	
	660 V/690 V	A	4,8	4,8	4,8	
	Max. three-phase motor rating					
	220 V/230 V	kW	2,2	2,2	2,2	
	240 V	kW	2,5	2,5	2,5	
	380 V/400 V	kW	4	4	4	
	415 V	kW	4,3	4,3	4,3	
	440 V	kW	4,6	4,6	4,6	
	500 V	kW	4	4	4	
	660 V/690 V	kW	4	4	4	
AC-4	Rated operational current $I_e$ open <sup>2)</sup> 50 – 60 Hz	220 V/230 V	A	6,6	6,6	6,6
		240 V	A	6,6	6,6	6,6
		380 V/400 V	A	6,6	6,6	6,6
		415 V	A	6,6	6,6	6,6
		440 V	A	6,6	6,6	6,6
		500 V	A	5	5	5
		660 V/690 V	A	3,4	3,4	3,4
		Max. three-phase motor rating				
		220 V/230 V	kW	1,5	1,5	1,5
		240 V	kW	1,8	1,8	1,8
		380 V/400 V	kW	3	3	3
		415 V	kW	3,1	3,1	3,1
		440 V	kW	3,3	3,3	3,3
		500 V	kW	3	3	3
	660 V/690 V	kW	3	3	3	

Notes:

- <sup>1)</sup> See overlay "Fuses" for time/current characteristics (please inquire)  
<sup>2)</sup> at maximum admissible ambient temperature

# DILEM Mini Contactors

## Technical Data

 Magnetic Contactors,  
Magnetic Starters

			DIL EM	DIL EM4	DIL EM-G	
<b>DC</b>						
Magnetic Contactors, Magnetic Starters	DC-1	12 V	A	20	–	20
		24 V	A	20	–	20
		60 V	A	20	–	20
		110 V	A	20	–	20
		220 V	A	20	–	20
	DC-3	12 V	A	8	–	8
		24 V	A	8	–	8
		60 V	A	4	–	4
		110 V	A	3	–	3
		220 V	A	–	1	–
	DC-5	12 V	A	2,5	–	2,5
		24 V	A	2,5	–	2,5
		60 V	A	2,5	–	2,5
		110 V	A	1,5	2,5	1,5
		220 V	A	0,3	1	0,3
Current heat loss (3 or 4 pole)						
with conv. thermal current $I_{th}$		W	2	2,7	3,5	
with $I_e$ to AC-3/400 V		W	0,5	–	0,7	
<b>Magnet systems</b>						
Pick-up and drop-out values						
AC operated						
Single-voltage coil 50Hz and dual-voltage coil 50/60Hz		Pick-up	$\times U_c$	0,8 – 1,1	0,8 – 1,1	–
Dual frequency coil ... V, 50/60 Hz		Pick-up	$\times U_c$	0,85 – 1,1	0,85 – 1,1	–
DC operated <sup>2)</sup>						
		Pick-up	$\times U_c$	–	–	0,85 – 1,1
Power consumption of the coil						
AC operated						
Single-voltage coil 50Hz and dual-voltage coil 50/60Hz		Pull-in	VA/W	25/22	25/22	–
		Sealing	VA/W	4,6/1,3	4,6/1,3	–
Dual frequency coil						
... V, 50/60 Hz at 50 Hz		Pick-up	VA/W	30/26	30/26	–
		Sealing	VA/W	5,4/1,6	5,4/1,6	–
... V, 50/60 Hz at 60 Hz		Pick-up	VA/W	29/24	29/24	–
		Sealing	VA/W	3,9/1,1	3,9/1,1	–
DC operated <sup>2)</sup>						
		Pull-in = Sealing	W	–	–	2,6
Duty factor			% DF	100	100	100
Switching times at 100 % $U_c$ (approximate values)						
Make contact						
Closing delay			ms	14 – 21	14 – 21	26 – 35
Opening delay			ms	8 – 18	8 – 18	15 – 25
Closing delay with top mounting auxiliary contact		max.	ms	45	45	70
Reversing contactors						
Changeover time at 110 % $U_c$			ms	16 – 21	16 – 21	40 – 50
Arcing time at 690 V AC			ms	12	12	12
Coil 50/60 Hz						

Notes:

<sup>1)</sup> At max. admissible ambient temperature<sup>2)</sup> Smoothed DC or three-phase bridge rectifier

# DILEM Mini Contactors

## Technical Data



		DIL EM	DIL EM-G	
<b>Auxiliary contacts</b>				
Interlocked opposing contacts to ZH 1/457, including auxiliary contact module		yes	yes	
Rated impulse withstand voltage $U_{mp}$		V	6000	
Overvoltage category / Pollution degree		III/3	III/3	
Rated insulation voltage $U_i$		V AC	690	
Rated operational voltage $U_e$		V AC	600	
Safe isolation to IEC 536 between coil and auxiliary contacts and between auxiliary contacts		V AC	300	
Rated operational current $I_e$				
AC-15	220 V/240 V	A	6	
	380 V/415 V	A	3	
	500 V	A	1,5	
	Top mounting auxiliary contacts	220/240 V	A	4
		380/400 V	A	2
500 V		A	1,5	
DC-13 <sup>1)</sup>				
Above 110V and at $L/R > 15$ ms: it is essential that means of arc suppression (RC circuit) be used in parallel with the contacts. C: 1 $\mu$ F, R: 0,5 $\Omega$ in series				
$L/R \leq 15$ ms: e.g. contactor coils, solenoid valves, DC motors				
Contacts in series				
1	24 V	A	2,5	
2	60 V	A	2,5	
3	100 V	A	1,5	
3	220 V	A	0,5	
Conventional thermal current $I_{th}$		A	10	
Control circuit reliability at $U_e = 24$ V DC, $U_{min} = 17$ V, $I_{min} = 5,4$ mA		Fault probability $H_f$	$< 10^{-8}$ , $< 1$ fault in 100 million operations	
Component lifespan at $U_e = 240$ V				
AC-15		operations $\times 10^6$	0,2	
DC-13 <sup>1)</sup>	at $I_e = 0,5$ A, $L/R = 50$ ms 2 contacts in series	operations $\times 10^6$	0,15	
Short-circuit rating without welding with direct connection to the mains transformer $> 1000$ VA				
Max. overcurrent protective device	220 V/240 V	PKZM 0	4	
	380 V/415 V	PKZM 0	4	
Maximum fuse <sup>2)</sup>	500 V	A gL/gG	6	
	500 V	A fast	10	
Current heat loss at $I_{th}$ per contact		W	0,2	
			0,3	

## Notes:

<sup>1)</sup> Making and breaking currents to DC-13, time constant as stated

<sup>2)</sup> See overlay "Fuses" for time/current characteristics (please inquire)

# DIL Contactors

## Technical Data

**Magnetic Contactors,  
Magnetic Starters**

Contactors			DIL 00 M DIL 00 AM	DIL 0 M DIL 0 AM	DIL 1 M DIL 1 AM	DIL 2 M DIL 2 AM	DIL 3 M <sup>2)</sup>
<b>General</b>							
Standards			UL, CSA, IEC/EN 60 947, VDE 0660				
Mechanical lifespan							
AC operated	operations × 10 <sup>6</sup>		10	10	10	10	10
DC operated	operations × 10 <sup>6</sup>		10	10	10	10	3
Max. operating frequency, mechanical							
AC operated	ops./h		7000	9000	9000 5000	5000	5000
DC operated	ops./h		9000	9000 5000	5000	5000	1000
Max. operating frequency, electrical							
Contactors without overload relay			→ page 03/074				
Climatic proofing			Damp heat, constant to IEC 60 068-2-3 / Damp heat, cyclical to IEC 60 068-2-30				
Ambient temperature							
open	min./max.	°C	-25/+50	-25/+50	-25/+50	-25/+50	-25/+60
enclosed	min./max.	°C	-25/+40	-25/+40	-25/+40	-25/+40	-25/+40
Storage temperature	min./max.	°C	-	-	-	-	-40/+80
Mounting position			a) DIL 00 M to DIL M 500                b) DIL 00 M to DIL 2 AM AC operation                c) DIL 00 M-G to DIL 2AM-G DC operation, DIL 3M 80 – DIL M 820                d) DIL M 580 to DIL M 820				
<b>Mechanical shock resistance (half-sinusoidal shock 20 ms) <sup>1)</sup></b>							
Main contacts							
make contact	AC	g	10	8	8	8	10
Auxiliary contacts							
Make/break contacts	AC	g	10/6	8/6	8/6	8/6	10/8
Degree of protection			IP 20      00      00      00      00				
Protection against direct contact			Finger and back-of-hand proof				
Dimensions			→ page 03/091      → page 03/091      → page 03/091      → page 03/091      → page 03/091				
Weight							
	AC op.	kg	0,32	0,42	0,71	0,95	2,0
	DC op.	kg	0,50	0,77	1,25	1,85	2,0
Terminal capacity (screw terminal, 1 or 2 conductors can be connected)							
Main wire							
Solid <sup>2)</sup>		mm <sup>2</sup>	1×(0,75 – 4)	1×(1 – 6)	1×(2,5 – 10)	1×(2,5 – 16)	1×(6 – 16)
		mm <sup>2</sup>	2×(0,75 – 4)	2×(1 – 6)	2×(2,5 – 10)	2×(2,5 – 16)	2×(6 – 16)
Flexible with ferrule		mm <sup>2</sup>	1×(0,75 – 4)	1×(1 – 6)	1×(2,5 – 16)	1×(2,5 – 25)	1×(4 – 50)
		mm <sup>2</sup>	2×(0,75 – 4)	2×(1 – 6)	2×(2,5 – 10)	2×(2,5 – 10)	2×(4 – 50)
Flexible with cable lug	min.	mm <sup>2</sup>	-	-	-	-	-
	max.	mm <sup>2</sup>	-	-	-	-	-
Stranded		mm <sup>2</sup>	-	-	1×(10 – 25)	1×(10 – 35)	16
		mm <sup>2</sup>	-	-	2×10	2×10	50
Stranded with cable lug	min.	mm <sup>2</sup>	-	-	-	-	-
	max.	mm <sup>2</sup>	-	-	-	-	-
Solid or stranded	min.	AWG	18	16	12	12	10
	max.	AWG	10	10	4	2	2
Flat conductor <sup>3)</sup>		mm	-	-	3×9×0,8	3×9×0,8	2×(6× )
		mm	-	-	2×(3×9×0,8)	2×(3×9×0,8)	-
		mm	-	-	6×9×0,8	6×9×0,8	-
Busbar			mm -				

Notes:

<sup>1)</sup> From DIL 3M 80 half-sinusoidal shock: 10ms<sup>2)</sup> Maximum one size difference admissible when using 2 conductors



# DIL Contactors

## Technical Data

DIL 4M 115	DIL M 185	DIL M 225 DIL M 250	DIL M 300 DIL M 400	DIL M 500	DIL M 580 DIL M 650	DIL M 750 DIL M 820
UL, CSA, IEC/EN 60 947, VDE 0660						
10	10	10	10	10	5	5
3	10	10	10	10	5	5
5000	3000	3000	2000	2000	1000	1000
1000	3000	3000	2000	2000	1000	1000
→ page 03/074						
Damp heat, constant to IEC 60 068-2-3 / Damp heat, cyclical to IEC 60 068-2-30						
-25/+60	-25/+60	-25/+60	-25/+60	-25/+60	-25/+60	-25/+60
-25/+40	-25/+40	-25/+40	-25/+40	-25/+40	-25/+40	-25/+40
-40/+80	-40/+80	-40/+80	-40/+80	-40/+80	-40/+80	-40/+80
10	10	10	10	10	10	10
10/8	10/8	10/8	10/8	10/8	10/8	10/8
00	00	00	00	00	00	00
Finger and back-of-hand proof	finger and back-of-hand proof with terminal cover or terminal block					
→ page 03/091	→ page 03/092	→ page 03/092	→ page 03/092	→ page 03/092	→ page 03/092	→ page 03/092
2,9	6,5	6,5	8,0	8,0	15,0	15,0
2,9	6,5	6,5	8,0	8,0	15,0	15,0
-	-	-	-	-	-	-
-	-	-	-	-	-	-
1×(16 - 70)	-	-	-	-	-	-
2×(16 - 70)	-	-	-	-	-	-
-	35	50	50	50	50	50
-	95	240	240	240	240	240
16	-	-	-	-	-	-
70	-	-	-	-	-	-
-	50	70	70	70	70	70
-	120	240	240	240	240	240
6	1/0	2/0	2/0	2/0	2/0	2/0
2/0	250 MCM	500 MCM	500 MCM	500 MCM	500 MCM	500 MCM
2×(6×16×0,8)	2×(6×16×0,8)	2×(6×16×0,8)	2×(10×16×0,8)	2×(10×16×0,8)	2×(10×16×0,8)	2×(10×16×0,8)
-	-	2×(10×16×0,8)	2×(10×21×1)	2×(10×21×1)	2×(10×21×1)	2×(10×21×1)
-	-	2×(10×21×1)	-	-	-	-
-	20	20/25	25	30	50	60

<sup>3)</sup> From DIL M 185 connection using flat strip conductor terminals or cable terminal block → page 03/056



# DIL Contactors

## Technical Data

Contactors			DIL 00 M DIL 00 AM	DIL 0 M DIL 0 AM	DIL 1 M DIL 1 AM	DIL 2 M DIL 2 AM	DIL 3M 80
<b>Terminal capacity</b>							
Control circuit wires							
Solid	min.	mm <sup>2</sup>	1×(0,75 – 4)	1×(0,75 – 4)	1×(0,75 – 4)	1×(0,75 – 4)	1×(0,75 – 4)
	max.	mm <sup>2</sup>	2×(0,75 – 4)	2×(0,75 – 4)	2×(0,75 – 4)	2×(0,75 – 4)	2×(0,75 – 4)
Flexible with ferrule	min.	mm <sup>2</sup>	1×(0,75 – 2,5)	1×(0,75 – 2,5)	1×(0,75 – 2,5)	1×(0,75 – 2,5)	1×(0,75 – 2,5)
	max.	mm <sup>2</sup>	2×(0,75 – 2,5)	2×(0,75 – 2,5)	2×(0,75 – 2,5)	2×(0,75 – 2,5)	2×(0,75 – 2,5)
Solid or stranded		AWG	18 – 12	18 – 12	18 – 12	18 – 12	2×(18 – 12)
<b>Terminal screw</b>							
Main wire			M3,5	M4	M6	M6	M8 (SW 4)
Control circuit wire			M3,5	M3,5	M3,5	M3,5	M3,5
<b>Tool</b>							
Main wire							
	Pozidriv screwdriver	Größe	2	2	2	2	–
	Hexagon socket-head wrench	mm	–	–	–	–	4
	Open-end spanner	mm	–	–	–	–	–
Control circuit wire							
	Pozidriv screwdriver	Größe	2	2	2	2	2
<b>Tightening torque</b>							
	Main wire	Nm	1,2	1,8	4	4	6
	Control circuit wire	Nm	1,2	1,2	1,2	1,2	1,2
<b>Main contacts</b>							
Rated impulse withstand voltage $U_{imp}$		V	8000	8000	8000	8000	8000
Overvoltage category / degree of pollution			III/3	III/3	III/3	III/3	III/3
Rated insulation voltage $U_i$		V AC	690	690	690	690	1000
Rated operational voltage $U_e$		V AC	690	690	690	690	1000
<b>Safe isolation to IEC 536</b>							
between coils and contacts		V AC	440	440	440	440	500
between contacts		V AC	440	440	440	440	500
<b>Making capacity</b>							
cos φ to IEC/EN 60 947		A	200 200 250	270	730	950	1300
<b>Breaking capacity</b>							
cos φ to IEC/EN 60 947							
220 V/230 V		A	130 130 160	230	380	750	1100
380 V/400 V		A	120 120 160	230	380	600	1100
500 V		A	120 120 160	230	355	600	1100
660 V/690 V		A	100 100 125	210	255	545	650
1000 V		A	–	–	–	–	330
<b>Component lifespan</b>							
AC-3/AC-4			→ page 03/075	→ page 03/075	→ page 03/075	→ page 03/075	→ page 03/075
AC-3		operations	×10 <sup>6</sup>				
<b>Short-circuit rating</b>							
Max. fuse <sup>1)</sup>							
Type „2“ coordination							
400 V		gL/gG 500 V	A	20	35	63	100
690 V		gL/gG 690 V	A	–	–	–	125
1000 V		gL/gG 1000 V	A	–	–	–	80
Type „1“ coordination							
400 V		gL/gG 500 V	A	25	50	100	125
690 V		gL/gG 690 V	A	–	–	–	200
1000 V		gL/gG 1000 V	A	–	–	–	100

Notes:

<sup>1)</sup> See transparent overlay "Fuses" for time/current characteristics (please inquire)

# DIL Contactors

## Technical Data

DIL 4M 115	DIL M 185 DIL M 225 DIL M 250	DIL M 300 DIL M 400 DIL M 500	DIL M 580 DIL M 650	DIL M 750 DIL M 820
1×(0,75 – 4)	1×(0,75 – 2,5)	1×(0,75 – 2,5)	1×(0,75 – 2,5)	1×(0,75 – 2,5)
2×(0,75 – 4)	2×(0,75 – 2,5)	2×(0,75 – 2,5)	2×(0,75 – 2,5)	2×(0,75 – 2,5)
1×(0,75 – 2,5)	1×(0,75 – 2,5)	1×(0,75 – 2,5)	1×(0,75 – 2,5)	1×(0,75 – 2,5)
2×(0,75 – 2,5)	2×(0,75 – 2,5)	2×(0,75 – 2,5)	2×(0,75 – 2,5)	2×(0,75 – 2,5)
2×(18 – 12)	2×(18 – 12)	2×(18 – 12)	2×(18 – 12)	2×(18 – 12)
M10	M10	M10	M10	M10
M3,5	M3,5	M3,5	M3,5	M3,5
–	–	–	–	–
5	–	–	–	–
–	16	16	16	18
2	2	2	2	2
10	24	24	24	24
1,2	1,2	1,2	1,2	1,2
8000	8000	8000	8000	8000
III/3	III/3	III/3	III/3	III/3
1000	1000	1000	1000	1000
1000	1000	1000	1000	1000
500	500	500	500	500
500	500	500	500	500
1800	3000	5500	7800	8200
1800	2500	5000	6500	8200
1800	2500	5000	6500	8200
1800	2500	5000	6500	8200
1200	2500	3600	6500	8200
630	760	950	4350	5800
→ page 03/075	–	–	–	–
	1,3	1,3	0,75	0,75
250	315	500	630	630
160	315	500	630	630
100	160	200	500	630
315	400	500	1000	1200
224	400	630	1000	1200
160	200	250	630	800



# DIL Contactors

## Technical Data

**Magnetic Contactors,  
Magnetic Starters**

Contactors				DIL 00 M DIL 00 AM			DIL 0 M DIL 0 AM		DIL 1 M DIL 1 AM		DIL 2 M DIL 2 AM		DIL 3M 80	
<b>AC</b>														
<b>AC-1</b> Conventional thermal current $I_{th}$ $\Delta$ rated operational current $I_e$ 50 – 60 Hz to 690 V														
3 poles	open	at 40 °C	A	22			38			60		98,5		114
		at 50 °C	A	20			35			55		90		104
		at 55 °C	A	19			33			52		85		100
		at 60 °C	A	–			–			–		–		–
		enclosed <sup>1)</sup>	A	16			30			44		80		90
	1 pole	open <sup>1)</sup>	A	50			85			140		225		250
	enclosed <sup>1)</sup>	A	40			75			110		200		225	
<b>AC-3</b> Rated operational current $I_e$ open <sup>1)</sup>														
50 – 60 Hz	220 V / 230 V	A	8,8	12	15,5	15,5	22,5	30	38	43	62	75	85	
	240 V	A	8,8	12	15,5	15,5	22,5	30	38	43	62	75	85	
	380 V / 400 V	A	8,8	12	15,5	15,5	22,5	30	36	43	58	72	85	
	415 V	A	8,8	12	15,5	15,5	22,5	30	36	43	58	72	85	
	440 V	A	8,8	12	15,5	15,5	22,5	30	36	43	58	72	85	
	500 V	A	9	12	11,5	17	22,5	28	32	43	54	64	78	
	660 V / 690 V	A	6,7	9	9	13	17,5	21	25	33	42	60	82	
	1000 V	A	–	–	–	–	–	–	–	–	–	28	33	
<b>Max. three-phase motor rating</b>														
220 V / 230 V	kW	2,2	3	4	4	5,5	7,5	11	15	18,5	22	25		
240 V	kW	2,5	3,5	4,6	4,6	6,8	9,3	11,5	16	20	25	28		
380 V / 400 V	kW	4	5,5	7,5	7,5	11	15	18,5	22	30	37	45		
415 V	kW	4,3	6,1	8	8	12	16	19	24	33	41	49		
440 V	kW	4,6	6,4	8,4	8,4	13	17	20	25	35	44	52		
500 V	kW	5,5	7,5	11	11	15	18,5	22	30	37	45	55		
660 V / 690 V	kW	5,5	7,5	11	11	15	18,5	22	30	37	55	75		
1000 V	kW	–	–	–	–	–	–	–	–	–	37	45		
<b>AC-4</b> Rated operational current $I_e$ open <sup>1)</sup>														
50 – 60 Hz	220 V / 230 V	A	6,6	8,7	8,7	11,5	15,5	22,5	30	37	49	64	75	
	240 V	A	6,6	8,7	8,7	11,5	15,5	22,5	30	37	49	64	75	
	380 V / 400 V	A	6,6	8,5	8,5	11,5	15,5	22,5	30	36	43	58	72	
	415 V	A	6,6	8,5	8,5	11,5	15,5	22,5	30	36	43	58	72	
	440 V	A	6,6	8,5	8,5	11,5	15,5	22,5	30	36	43	58	72	
	500 V	A	6,4	9	9	11,5	17	22,5	28	32	43	54	64	
	660 V / 690 V	A	4,9	6,7	6,7	9	13	17,5	21	25	33	49	49	
	1000 V	A	–	–	–	–	–	–	–	–	–	28	33	
<b>Max. three-phase motor rating</b>														
220 V / 230 V	kW	1,5	2,2	2,2	3	4	5,5	7,5	11	15	18,5	22		
240 V	kW	1,8	2,5	2,5	3,4	4,6	6,8	9,2	12	16	22	25		
380 V / 400 V	kW	3	4	4	5,5	7,5	11	15	18,5	22	30	37		
415 V	kW	3,1	4,2	4,2	5,8	8	11,8	16	19	24	33	41		
440 V	kW	3,3	4,4	4,4	6,2	8,4	12,5	17	20,5	25,3	35	43		
500 V	kW	4	5,5	5,5	7,5	11	15	18,5	22	30	37	45		
660 V / 690 V	kW	4	5,5	5,5	7,5	11	15	18,5	22	30	45	45		
1000 V	kW	–	–	–	–	–	–	–	–	–	30	37		
<b>Capacitor duty</b>														
Individual compensation														
Rated operational current $I_e$ of three-phase capacitors														
open	525 V	A	6			10,5	18,5	29	37	47	70	–	–	
	690 V	A	7			9,5	18,5	28	34	46	55	–	–	
enclosed	525 V	A	6			10,5	18,5	29	37	47	58	–	–	
	690 V	A	7			9,5	18,5	28	34	46	55	–	–	
Max. inrush current peak				$30 \times I_e$		$30 \times I_e$		$30 \times I_e$		$30 \times I_e$		–	–	
Component lifespan operations			$\times 10^6$	0,1		0,1		0,1		0,1		–	–	
Max. operating frequency			ops/h	200		200		200		200		–	–	

Notes:

<sup>1)</sup> at maximum admissible ambient temperature

# DIL Contactors

## Technical Data

DIL 4M 115		DIL M 185 DIL M 225		DIL M 250 DIL M 300		DIL M 400 DIL M 500		DIL M 580 DIL M 650		DIL M 750 DIL M 820	
182		276	306	367	429	551	674	772	857	980	1041
167		246	274	329	383	493	602	690	767	876	931
160		235	261	313	366	470	574	658	731	836	888
-		225	250	300	350	450	550	630	700	800	850
140		200	200	250	310	400	480	565	620	720	750
400		560	625	750	875	1125	1375	1575	1750	2000	2125
350		500	550	650	770	1000	1200	1400	1550	1800	1875
104	147	185	225	250	300	400	500	580	650	750	820
104	147	185	225	250	300	400	500	580	650	750	820
104	142	185	225	250	300	400	500	580	650	750	820
104	142	185	225	250	300	400	500	580	650	750	820
104	142	185	225	250	300	400	500	580	650	750	820
106	127	185	225	250	300	400	500	580	650	750	820
98	118	185	225	250	300	360	360	580	650	750	820
40	47	76	76	76	95	95	95	435	435	580	580
37	45	55	70	75	90	125	155	185	205	240	260
40	50	62	75	85	100	132	170	200	225	260	285
55	75	90	110	132	160	200	250	315	355	400	450
60	83	110	132	148	180	240	300	348	390	455	500
64	88	115	142	157	190	255	345	370	420	480	525
75	90	132	160	180	215	290	360	420	470	550	600
90	110	175	215	240	286	344	344	560	630	720	750
55	65	108	108	108	132	132	132	600	600	800	800
86	106	136	164	200	240	296	360	456	512	576	656
86	106	136	164	200	240	296	360	456	512	576	656
85	106	136	164	200	240	296	360	456	512	576	656
85	106	136	164	200	240	296	360	456	512	576	656
85	106	136	164	200	240	296	360	456	512	576	656
78	106	136	164	200	240	296	360	456	512	576	656
60	82	136	164	200	240	296	296	456	512	576	656
40	40	76	76	76	95	95	95	348	348	464	464
26	30	41	51	62	75	92	112	143	161	181	209
29	35	45	54	68	82	101	122	156	176	200	228
45	55	75	90	110	132	160	200	250	280	315	355
49	61	80	96	117	142	176	216	274	307	346	394
52	65	85	102	125	140	186	229	290	326	367	418
55	75	96	116	143	172	214	260	330	370	417	474
55	75	127	155	189	229	283	344	440	494	556	633
45	55	108	108	108	108	132	132	509	509	678	678
-		-		-		-		-		-	
-		-		-		-		-		-	
-		-		-		-		-		-	
-		-		-		-		-		-	
-		-		-		-		-		-	
-		-		-		-		-		-	
-		-		-		-		-		-	
-		-		-		-		-		-	
-		-		-		-		-		-	
-		-		-		-		-		-	



# DIL Contactors

## Technical Data

Contactors			DIL 00 M DIL 00 AM	DIL 0 M DIL 0 AM	DIL 1 M DIL 1 AM	DIL 2 M DIL 2 AM	DIL 3 M 80
DC							
Rated operational current $I_e$ open							
DC-1							
to 60 V	A		20 20 -	35	55	90	100
110 V	A		20 20 -	35	55	90	100
220 V	A		12 15 -	20 25	40	80	100
440 V	A		3 3 -	5	7	10	-
DC-3							
to 60 V	A		15 20 -	20 28	28	70	100
110 V	A		15 20 -	20 28	28	70	91
220 V	A		5 8 -	10 12	15	45	91
440 V	A		-	-	-	-	-
DC-5							
to 60 V	A		12 16 -	18 25	25 27	45 48	100
110 V	A		12 16 -	18 25	25 27	45 48	91
220 V	A		-	-	-	-	91
440 V	A		-	-	-	-	-
Current heat loss (3 pole)							
with conv. thermal current $I_{th}$	W		2,3	3,7	12,4	20	21
with $I_e$ AC-3/400 V	W		0,4 0,8 1,4	0,7 1,5	3,8 5,5	4,6 8,4	11 15
Magnet systems							
Pick-up and drop-out values							
AC operated	pick-up	$\times U_c$	0,8 - 1,1	0,8 - 1,1	0,8 - 1,1	0,8 - 1,1	0,8 - 1,1
	drop-out	$\times U_c$	-	-	-	-	-
DC operated <sup>1)</sup>	pick-up	$\times U_c$	0,85 - 1,1	0,85 - 1,1	0,85 - 1,1	0,85 - 1,1	0,8 - 1,1
	drop-out	$\times U_c$	-	-	-	-	-
Power consumption of the coil from cold and at $1,0 \times U_c$							
AC operated	pick-up	VA	67	100	136	185	320
		W	52	72	88	106	150
Single-voltage coil	sealing	VA	8,5	10	14	16	24
...V 50 Hz		W	2,5	3	3,5	4,5	5,5
Dual voltage coil	sealing	VA	8,6	10	15	16,5	26
...V 50 Hz ...60 Hz		W	2,5	3	4	5,8	7
Dual frequency coil							
...V 50/60 Hz at 50 Hz	sealing	VA	10	14	21	25	28
		W	3	4	5	7,5	8
...V 50/60 Hz at 60 Hz	sealing	VA	8,5	10	15	20	23
		W	2,5	3	4	6	6
Multi-voltage coil	sealing	VA	-	-	-	-	-
		W	-	-	-	-	-
DC operated <sup>1)</sup>	pick-up	W	9,5	10	14,5	16	230
	sealing	W	9,5	10	14,5	16	5
Duty factor		% DF	100	100	100	100	100

Notes:

<sup>1)</sup> Smoothed DC or three-phase bridge rectifier, at least two-pulse bridge rectifier

# DIL Contactors

## Technical Data

DIL 4M 115	DIL M 185 DIL M 225	DIL M 250 DIL M 300	DIL M 400 DIL M 500	DIL M 580 DIL M 650	DIL M 750 DIL M 820
160	300	300 400	400	-	-
160	300	300 400	400	-	-
160	300	300 400	400	-	-
-	11	11 11	11	-	-
160	300	300 400	400	-	-
145	300	300 400	400	-	-
145	300	300 400	400	-	-
-	-	-	-	-	-
160	300	300 400	400	-	-
145	300	300 400	400	-	-
145	300	300 400	400	-	-
-	-	-	-	-	-
35	-	-	-	-	-
15 28	36 55	48 69	120 120	135 160	185 210
0,8 - 1,1	0,7 - 1,15	0,7 - 1,15	0,7 - 1,15	0,7 - 1,15	0,7 - 1,15
-	0,2 - 0,6	0,2 - 0,6	0,2 - 0,6	0,2 - 0,6	0,2 - 0,6
0,8 - 1,1	0,7 - 1,15	0,7 - 1,15	0,7 - 1,15	0,7 - 1,15	0,7 - 1,15
-	0,2 - 0,6	0,2 - 0,6	0,2 - 0,6	0,2 - 0,6	0,2 - 0,6
550	250	250 450	450	1200	1200
220	200	200 350	350	1000	1000
38	-	-	-	-	-
10	-	-	-	-	-
40	-	-	-	-	-
10	-	-	-	-	-
43	-	-	-	-	-
11	-	-	-	-	-
37	-	-	-	-	-
10	-	-	-	-	-
-	3,3	3,3	3,3	8,5	8,5
-	4,3	4,3	4,3	9,5	9,5
360	170	170 350	350	900	900
5,7	4,3	4,3	4,3	9,5	9,5
100	100	100	100	100	100



# DIL Contactors

## Technical Data

Contactors	DIL 00 M		DIL 0 M		DIL 1 M		DIL 2 M		DIL 3M 80	
	DIL 00 AM		DIL 0 AM		DIL 1 AM		DIL 2 AM			
Switching times at 100 % $U_c$ (approximate values)										
Main contacts										
AC operated										
Closing delay	ms	14 – 22	9 – 19	11 – 19	14 – 22	20 – 24				
Opening delay	ms	5 – 14	5 – 13	6 – 13	5 – 15	8 – 13				
DC operated <sup>1)</sup>										
Closing delay	ms	35 – 40	40 – 55	68 – 75	75 – 90	27 – 29				
Opening delay	ms	5 – 10	6 – 10	10 – 15	12 – 18	12 – 23				
Reversing contactors, AC operated										
Changeover time at 100 % $U_c$	ms	13 – 21 <sup>2)</sup>	13 – 19 <sup>2)</sup>	12 – 16 <sup>2)</sup>	13 – 19 <sup>2)</sup>	21 – 30				
Arcing time at AC	ms	≅ 10	< 20	< 20	< 20	10 – 20				
Behaviour in marginal and transitional conditions										
Sealing										
Voltage interruptions										
(0 – 0,2 × $U_s$ )	≅ 10 ms	-	-	-	-	-				
(0 – 0,2 × $U_s$ )	> 10 ms	-	-	-	-	-				
Voltage drops										
(0,2 – 0,6 × $U_s$ )	≅ 12 ms	-	-	-	-	-				
(0,2 – 0,6 × $U_s$ )	> 12 ms	-	-	-	-	-				
(0,6 – 0,7 × $U_s$ )		-	-	-	-	-				
Excess voltage										
(1,15 – 1,3 × $U_s$ )		-	-	-	-	-				
(> 1,3 × $U_s$ )	≅ 3 sek.	-	-	-	-	-				
(> 1,3 × $U_s$ )	> 3 sek.	-	-	-	-	-				
Pick-up phase										
(0 – 0,7 × $U_s$ )		-	-	-	-	-				
(0,7 – 1,15 × $U_s$ )		-	-	-	-	-				
(> 1,15 × $U_s$ )		-	-	-	-	-				
Max. admissible transitional contact resistance of the external control circuit device when actuating A11	mΩ	-	-	-	-	-				
Max. admissible residual current when A11 is actuated from the electronics (for 0 signal)	mA	-	-	-	-	-				
PLC signal level (A3 - A4) to IEC/EN 61 131-2 (Type 2)	High	V	-	-	-	-				
	Low	V	-	-	-	-				
Electromagnetic compatibility										

## Notes:

- <sup>1)</sup> Smoothed DC or three-phase bridge rectifier, at least two-pulse bridge rectifier
- <sup>2)</sup> DIL 00 (A)M to DIL 2 (A)M can be reversed at 660/690 V with a zero-current pause of ≅ 25 ms



# DIL Contactors

## Technical Data

DIL 4M 115	DIL M 185 DIL M 225	DIL M 250 DIL M 300	DIL M 400 DIL M 500	DIL M 580 DIL M 650	DIL M 750 DIL M 820
18 - 28	≧ 100	≧ 100 ≧ 80	≧ 80	≧ 60	≧ 60
7 - 11	≧ 80	≧ 80 ≧ 80	≧ 80	≧ 70	≧ 70
28 - 30	≧ 100	≧ 100 ≧ 80	≧ 80	≧ 60	≧ 60
13 - 16	≧ 80	≧ 80 ≧ 80	≧ 80	≧ 70	≧ 70
23 - 30 <sup>4)</sup>	-	-	-	-	-
10 - 25	-	-	-	-	-
-	Time deliberately bridged				
-	Contactor drops out after inherent drop-out delay				
-	Time deliberately bridged				
-	Contactor drops out after inherent drop-out delay				
-	Contactor remains energized				
-	Contactor remains energized				
-	Contactor remains energized				
-	Contactor drops out after inherent drop-out delay <sup>3)</sup>				
-	Contactor does not close				
-	Contactor closes reliably				
-	Contactor does not close				
-	≧ 500				
-	≧ 1				
-	15				
-	5				
This product is designed for industrial operation (environment 2). If it used in residential premises (environment 1), it can cause radio interference, and additional interference suppression measures have to be provided					

<sup>3)</sup> Damage to the contactor magnet system is possible.

<sup>4)</sup> DIL4M115 can be reversed at 1000 V with a zero-current pause of ≧ 25 ms



# Auxiliary Contacts, Accessories

## Technical Data

Auxiliary contacts			..SDILM	..DIL M	DIL M 820-XHI...
Rated impulse withstand voltage $U_{imp}$	V		6000	6000	6000
Overvoltage category / pollution degree			III/3	III/3	III/3
Rated insulation voltage $U_i$	V AC		690	690	690
Rated operational voltage $U_e$	V AC		500	500	500
Safe isolation to IEC 536					
between coil and auxiliary contacts	V AC		440	440	440
between the auxiliary contacts	V AC		440	440	440
Rated operational current $I_e$					
AC-15	200/240 V	A	6	6	6
	380/415 V	A	4	4	4
	500 V	A	1,5	1,5	1,5
DC-13 <sup>1)</sup> L/R ≤ 15ms	24 V	A	10	10	10
	60 V	A	6	6	6
	110 V	A	3	3	3
	220 V	A	1	1	1
Conventional thermal current $I_{th}$	A		16	16	10
Control circuit reliability at $U_e = 24$ V DC, $U_{min} = 17$ V, $I_{min} = 5,4$ mA					
Fault probability $H_f$			< 10 <sup>-8</sup> , < 1 fault in 100 million operations		
Component lifespan					
$U_e = 230$ V, AC-15, 3 A	operations	× 10 <sup>6</sup>	DIL R diagram → page 02/028	DIL R diagram → page 02/028	DIL R diagram → page 02/028
Short-circuit rating without welding Maximum fuse <sup>2)</sup>		A gL/gG	16	16	16
Max. overcurrent protective device	220/230 V	using FAZ-C	-	4	4

Paralleling links	P1 DIL EM P1 DIL 00 M	P1 DIL 0 M	P1 DIL 1 M	P1 DIL 2 M	P1 DIL 3 M	P1 DIL 4 M
-------------------	--------------------------	------------	------------	------------	------------	------------

### Terminal capacity

(1 or 2 conductors can be connected)

Solid	mm <sup>2</sup>	1 – 16	1 – 16	16	16	1 – 16	-
Flexible with ferrule	mm <sup>2</sup>	1 × (0,5 – 25)	1 × (0,5 – 50)	1 × (6 – 95)	1 × (6 – 150)	-	-
	mm <sup>2</sup>	2 × (0,5 – 16)	2 × (0,5 – 16)	2 × (6 – 25)	2 × (6 – 50)	-	-
Stranded	mm <sup>2</sup>	1 × (0,5 – 25)	1 × (0,5 – 50)	1 × (6 – 95)	1 × (6 – 150)	1 × (16 – 185)	1 × (30 – 300)
	mm <sup>2</sup>	2 × (0,5 – 16)	2 × (0,5 – 16)	2 × (6 – 25)	2 × (6 – 50)	2 × (10 – 95)	2 × (70 – 120)
Flat conductor	mm	6 × 9 × 0,8	6 × 9 × 0,8	-	-	2 × (10 × 16 × 0,8)	2 × (11 × 21 × 1)

Cable terminal block	DIL M 225-XKU-S	DIL M 400-XKU-S	DIL M 185-XP1	DIL M 650-XKB-S	DIL M 820-XKB-S
----------------------	-----------------	-----------------	---------------	-----------------	-----------------

### Terminal capacity

Stranded	mm <sup>2</sup>	1 × (16 – 185)	1 × (25 – 300)	-	-	-	
	mm <sup>2</sup>	2 × (16 – 150)	2 × (25 – 240)	-	-	-	
Stranded	AWG	1 × (6 – 350 MCM)	1 × (4 – 600 MCM)	-	-	-	
	AWG	2 × (6 – 300 MCM)	2 × (4 – 500 MCM)	-	-	-	
Flat conductor	min.	mm	1 × (3 × 9 × 0,8)	1 × (6 × 9 × 0,8)	1 × (6 × 16 × 0,8)	1 × (6 × 16 × 0,8)	1 × (6 × 16 × 0,8)
	max.	mm	2 × (10 × 16 × 0,8)	2 × (20 × 24 × 0,5)	2 × (20 × 32 × 0,5)	2 × (20 × 32 × 0,5)	2 × (10 × 40 × 1)
			2 × (11 × 21 × 1)	2 × (11 × 21 × 1)	2 × (11 × 21 × 1)	2 × (20 × 40 × 0,5)	

### Control circuit cables

Solid	mm <sup>2</sup>	1(2) × (0.75 - 4)
Flexible with ferrule	mm <sup>2</sup>	1(2) × (0.75 - 2.5)

### Notes:

<sup>1)</sup> Making and breaking contacts to DC-13, time constant as stated

<sup>2)</sup> See transparent overlay "Fuses" for time/current characteristics (please inquire)

# DIL Contactors

## Dimensions

### Mini contactors

DIL EM-...(-G)

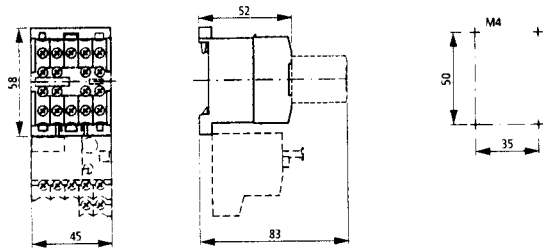

### Contactors

DIL 00 M(-G) to DIL 2 AM(-G)

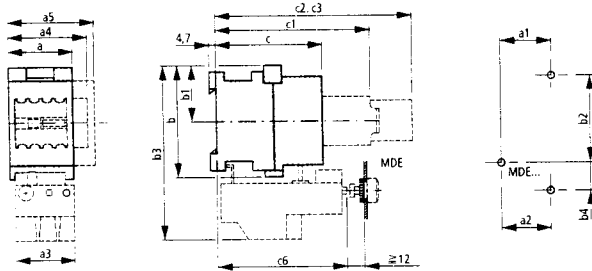

2 M4 × 16	2 M5 × 16
DIL 00 (A)M	DIL 1 (A)M
DIL 0 (A)M	DIL 2 (A)M

DIL	00 M (-G) 00 AM (-G) 00 M 4 (-G)	0 M (-G) 0 AM (-G)	1 M (-G) 1 AM (-G)	2 M (-G) 2 AM (-G)
a	45 (45)	45 (45)	60 (60)	70 (70)
a1	35 (35)	35 (35)	50 (50)	60 (60)
a4	-	55 (55)	70 (70)	80 (80)
a5	-	60 (60)	80 (80)	90 (90)
b	77 (77)	91 (91)	98 (98)	118 (118)
b1	39 (39)	46 (46)	49 (49)	59 (59)
b2	60 (60)	75 (75)	75 (75)	90 (90)
c (without H DIL)	74 (99)	79 (104)	97 (122)	102 (127)
c (with H DIL)	76,5 (101,5)	86,3 (113,3)	-	-
c1	107 (132)	112 (137)	130 (155)	135 (160)
c2	136 (161)	141 (166)	159 (184)	164 (189)
c3	136 (161)	-	-	-

### Overload relays

Z	00	00	1	1
a2	34 (34)	34 (34)	42 (42)	47 (47)
a3	45 (45)	45 (45)	60 (60)	60 (60)
b3	120 (120)	133 (133)	153 (153)	171 (171)
b4	19 (19)	18 (18)	26 (26)	27 (27)
c6	90 (115)	96 (121)	91 (116)	91 (116)

Maintain a minimum spacing of 5 mm between DC operated DIL00M-G to DIL2AM-G contactors mounted side by side.

- a4 = with side mounted auxiliary contact module on DIL 0M to DIL 2 AM,
- a5 = with N DIL...M 4th pole module
- c1 = with ...DIL M auxiliary contact module
- c2 = with TP...11 DIL pneumatic timer module
- c3 = with V(-G) DIL mechanical latching module

DIL 3 M80  
DIL 4 M115

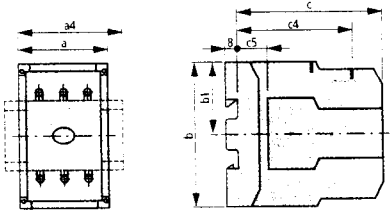

DIL 3 M80 + Z5-.../SK3  
DIL 4 M115 + Z5-.../SK4

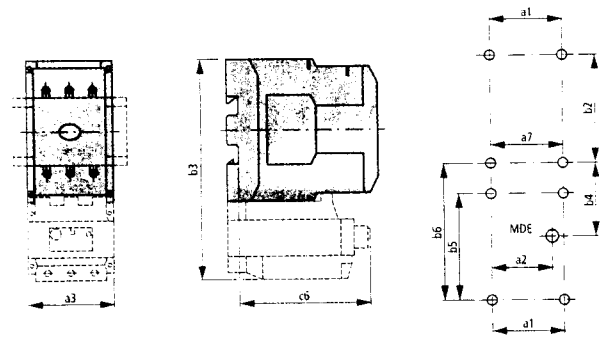

DIL	3 M80	4 M115
DIL 3 M80	2 M5 × 20	
Z 5-.../SK 3	2 M5 × 20	
DIL 4 M115	2 M6 × 20	
Z 5-.../SK 4	2 M6 × 20	

DIL	3 M80	4 M115
a	100	120
a1	80	100
a4	112	130
b	130	150
b1	65	75
b2	110	130
c (without H DIL)	127	137
c4	77	79
c5	20	47

### Overload relay

Z	5-.../SK 3	5-.../SK 4
a2	57	67
a3	100	120
a7	80	80
b3	238	263
b4	51	56
b5	74	74
b6	95	100
c6	125	125

a4 = with second side mounted auxiliary contact module DIL M 820-XH11-SA on DIL3M80 to DIL 4M115

# DIL Contactors

## Dimensions

### Contactors

DIL M 185      DIL M 300  
 DIL M 225      DIL M 400  
 DIL M 250      DIL M 500

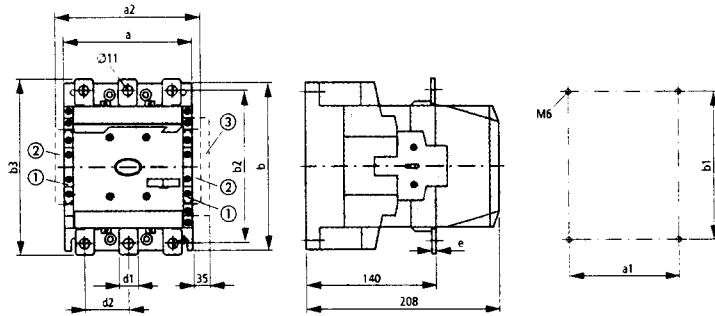

- ① DIL M 820-XHI...-SI
- ② DIL M 820-XHI11-SA
- ③ DIL M ...-XMV

DIL	M 185	M 225	M 250	M 300	M 400	M 500
a	140	140	140	160	160	160
a1	120	120	120	130	130	130
a2	160	160	160	180	180	180
b	180	180	180	200	200	200
b1	160	160	160	180	180	180
b2	164	164	164	184	184	189
b3	189	189	189	209	209	219
d1	20	20	25	25	25	35
d2	48	48	48	48	48	57
e	5	5	5	6	6	6

DIL M 580      DIL M 750  
 DIL M 650      DIL M 820

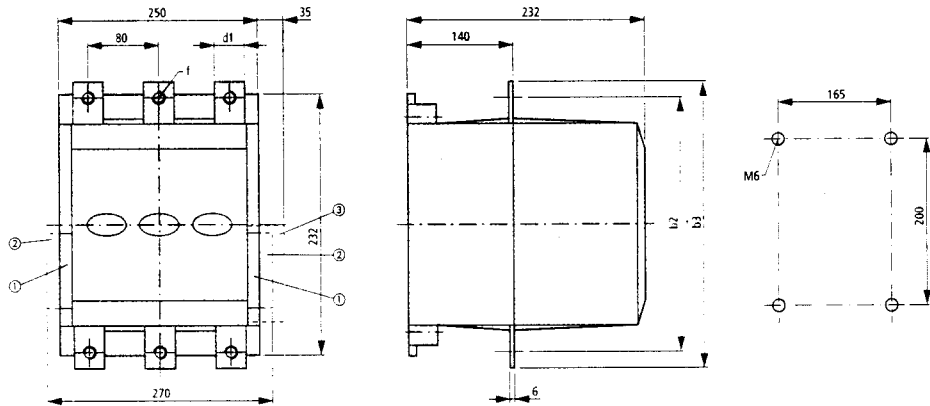

- ① DIL M 820-XHI...-SI
- ② DIL M 820-XHI11-SA
- ③ DIL M ...-XMV

DIL	M 580	M 650	M 750	M 820
b2	256	256	256	256
b3	286	286	296	296
d1	35	35	45	45
f	11	11	13,5	13,5

### Contactors with terminal cover

DIL M 185 to DIL M 820 with DIL M...-XHB

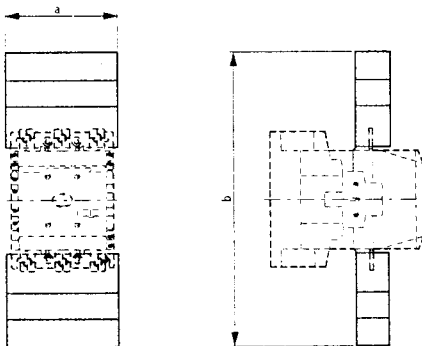

DIL M 185      DIL M 500      DIL M 580  
 DIL M 225           DIL M 650  
 DIL M 250           DIL M 750  
 DIL M 300           DIL M 820  
 DIL M 400  
 DIL M 185-XP1

	150	174	236
a	150	174	236
b	384	369	506

DIL M 185 to DIL M 250 with ZS-.../FF250

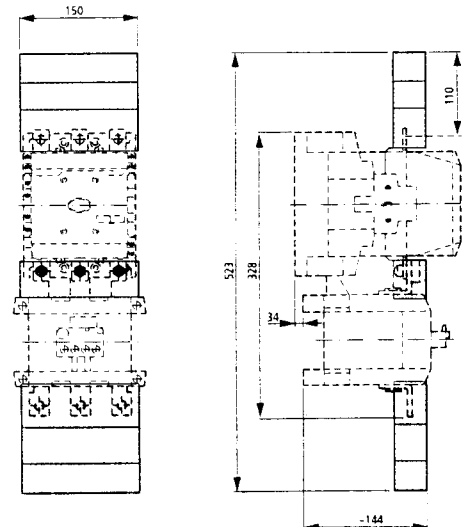

# DIL Contactors

## Dimensions

### Contactors with star-delta bridge + terminal cover

DIL M...-XS1

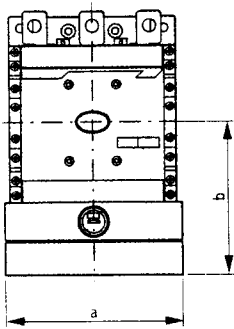

DIL M	185 – 250	300 – 400	500
a	150	150	176
b	127	137	146

### Reversing starters

DIUL EM

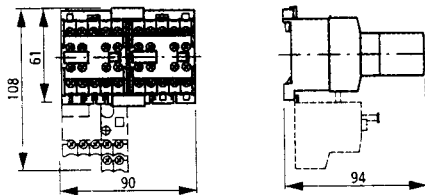

DIUL 00 AM/11 to DIUL 2 AM/11

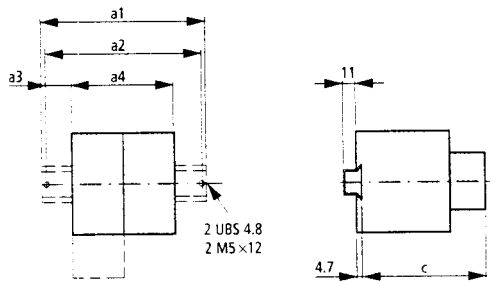

DIUL	00 AM	0 M 0 AM	1 AM	2 M 2 AM
a1	114	114	164	189
a2	100	100	150	175
a3	5	5	15	17,5
a4	90	90	120	140
c	107	112	130	135

Note: Width increases by 15 mm for reversing contactors with mechanical interlock

DIUL 3M80/11 to DIUL 4M115/11

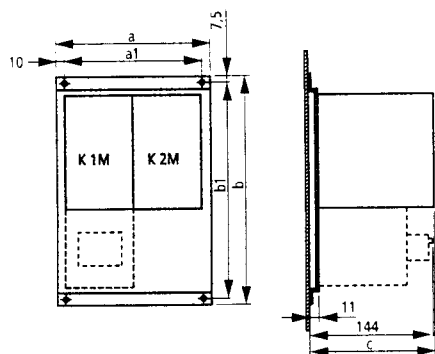

DIUL	3M80	4M115
a	225	265
a1	205	245
b	268	294
b1	253	279
c	146	156

Note: Width increases by 10 mm for reversing contactors with mechanical interlock

# Accessories Dimensions

## Suppressors

RC DIL E  
VG DIL E

RCX DIL...

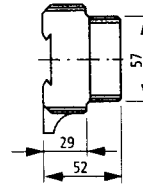
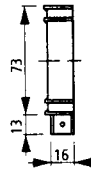
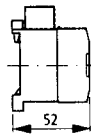
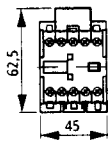

RC B DIL...  
RC S DIL...  
FD B DIL...  
VG B DIL...  
VG C DIL

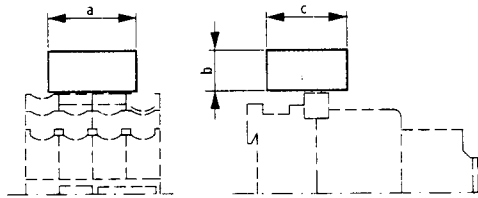

	RC B DIL	RC S DIL	FD B DIL	VG B DIL	VG C DIL
a	33	33	33	33	38
b	15	15	15	15	8
c	30	30	30	30	33

## Interface modules

VS 1 DIL  
VS 2 DIL

ETS 4-VS 3

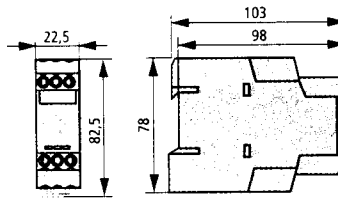
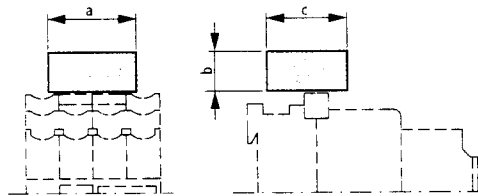

	VS 1 DIL VS 2 DIL
a	45
b	26
c	55

## Star-point bridges

S 1 DIL... M

## Paralleling links

P 1 DIL EM

P1 DIL...M

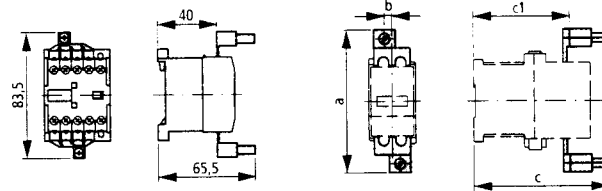
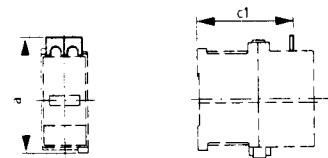

S 1 DIL	00 M	0 M	1 M	2 M	3 M	4 M
a	77	91	106	126	150	169
c1	65	69	79	79	92	93

for DIL	00 (A)M(-G)	0 (A)M(-G)	1 (A)M(-G)	2 (A)M(-G)	3M80	4M115
a	95	114	170	188	195	244
b	5	-	9	12	19	17
c	91 (116)	103 (128)	138 (163)	138 (163)	150	182
c1	65 (90)	69 (94)	79 (101)	79 (101)	88	92

# Accessories Dimensions

## Tamper-proof cover

H DIL E

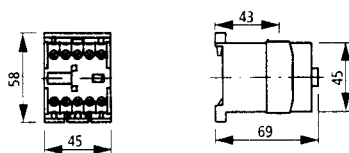

## Adapter

AK DIL... M

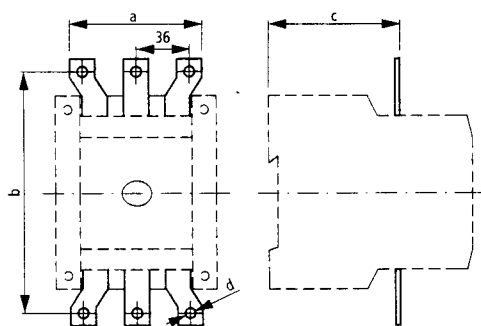

for DIL	AK DIL...	
	3M80	4M115
a	89	94
b	160	190
c	88	91
d	7	8,4

## Extension terminals

ZK DIL 0 M  
ZK DIL M

ZK DIL 1 M  
HK DIL M

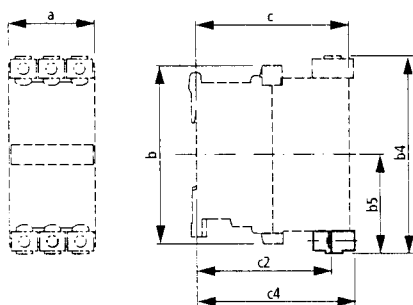

for DIL	ZK DIL 0 M		ZK DIL 1 M		2 (A)M	(-G)	ZK DIL M	
	0 (A)M	(-G)	1 (A)M	(-G)			3M80	4M115
a	45	(45)	60	(60)	70	(70)	100	120
b	91	(91)	98	(98)	118	(118)	-	-
b4	101	(101)	98	(98)	112,5	(112,5)	136	166
b5	50,5	(50,5)	49	(49)	56,3	(56,3)	68	83
c	79	(104)	97	(122)	102	(127)	127	137
c2 (max. with HK DIL M)	69,5	(94,5)	80,5	(105,5)	80,5	(105,5)	102	105
c4 (max. with HK DIL M)	81,5	(106,5)	92,5	(117,5)	92,5	(117,5)	118	121

for DIL	HK DIL M		2(A)M	(-G)
	1(A)M	(-G)		
a	60	(60)	70	(70)
b	98	(98)	118	(118)
b4	104,5	(104,5)	123	(123)
b5	52,3	(52,3)	61,5	(61,5)
c	97	(122)	102	(127)
c2	73,5	(98,5)	74,2	(99,2)
c4	107,4	(132,4)	107,7	(132,7)



# Accessories Dimensions

## Mechanical interlock

MV DIL E

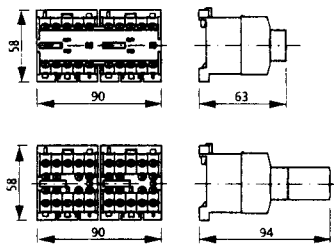

MV DIL M  
DIL M 500-XMV  
DIL M 820-XMV

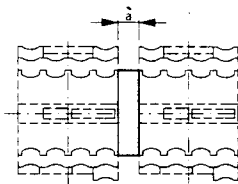

DIL...	3 M80 to 4 M115	DIL M 185 to DIL M 820	
a	15	10	15

## Wire terminal block

DIL M...-XKU-S

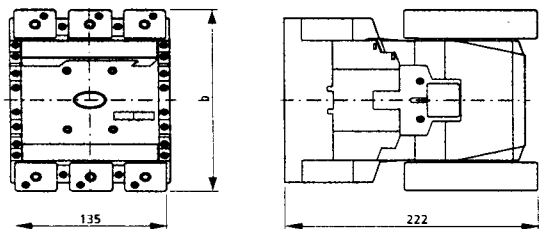

for DIL M	185-225	250	300-400
b	198	198	218

## Flat strip conductor terminals

DIL M...-XKB-S

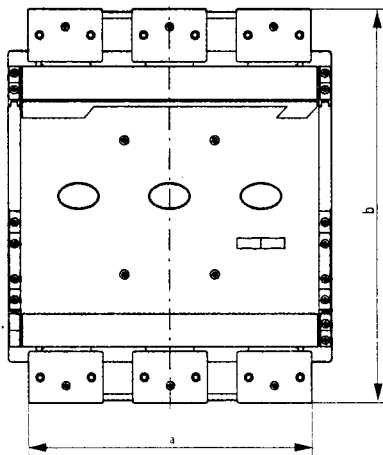

for DIL M	500	580-650	750-820
a	171	218	231
b	232	295	310



# Thermal Overload Relays, Thermistor Tripping Units

## Overview

### Thermal overload relays, thermistor tripping units

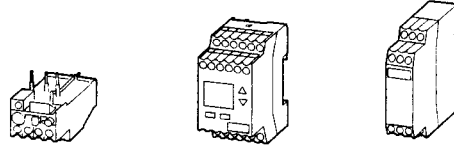







	Page
<b>Technical overview</b>	04/002
<b>Thermal overload relays</b>	04/004
ZE, Z00 overload relays	04/004
Z1, Z5 overload relays	04/006
ZW7 current transformer-operated overload relays	04/008
ZEV electronic overload relays	04/010
SSW core-balance transformers	04/011
<b>Thermistor tripping units</b>	04/014
<b>Accessories</b>	04/011, 04/016
<b>Tripping characteristics</b>	04/018
<b>Technical data</b>	04/019
<b>Dimensions</b>	04/024

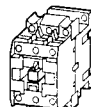
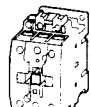
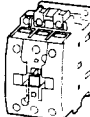

# Thermal Overload Relays, Thermistor Tripping Units Overview

Thermal Overload Relays,  
Thermistor Tripping Units

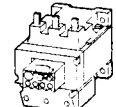
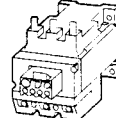
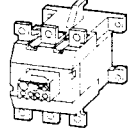
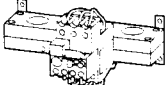
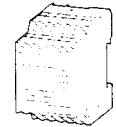
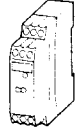
		Setting ranges (A) (note max. current of contactor)					
			DIL EM	00 M 00 AM	0 M 0 AM	1 M 1 AM	2 M 2 AM
<b>Thermal overload relays</b>							
ZE		0,1 – 12	●				
Z 00		0,1 – 24		●	●		
Z 1		6 – 75				●	●
Z 5-.../K3		25 – 100					
Z 5-.../K4		35 – 150					
Z 5-.../FF250		50 – 250					
Current-transformer operated overload relay ZW 7-...		42 – 540					●
Electronic motor- protective relay ZEV		1 - 820	●	●	●	●	●
Thermistor tripping units EMT6 ((DB)K)			●	●	●	●	●

# Thermal Overload Relays, Thermistor Tripping Units Overview

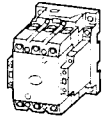

3M 80  
3AM 85

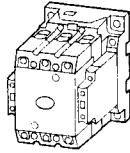

4M 115  
4AM 145

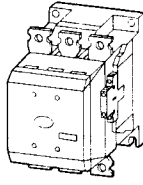

M 185  
M 225  
M 250

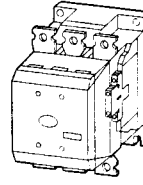

M 300  
M 400  
M 500

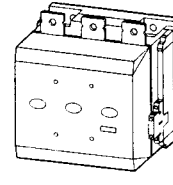

M 580  
M 650

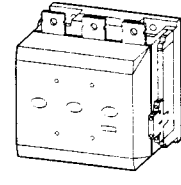

M 750  
M 820

Thermal Overload Relays,  
Thermistor Tripping Units

●					
	●				
		●			
●	●	●	●	● 1)	
●	●	●	●	●	●
●	●	●	●	●	●



Notes:

<sup>1)</sup> up to DIL M 580

**Thermal Overload Relays**  
ZE, Z00 Overload Relays

Thermal Overload Relays, Thermistor Tripping Units

Adjustable setting range  
(motor full load current)

Auxiliary contacts

Short-circuit protection  
by fuses

by circuit breaker

Amps

Circuit diagram

N.O.

N.C.

For use with

max. 600 V AC  
A

max. 600 V AC <sup>2)</sup>  
A

**ZE overload relays**

UL listed File No. E 29184  
CSA certified File No. 45958 + 43359  
Phase-failure sensitivity to IEC/EN 60 947

For direct mounting

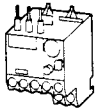

0.1-0.16

0.16 - 0.24

0.24 - 0.4

0.4 - 0.6

0.6 - 1

1 - 1.6

1.6 - 2.4

2.4 - 4

4 - 6

6 - 9

9 - 12

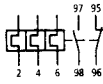

1

1

DILEM <sup>1)</sup>,

1

15

1

15

1

15

1

15

3

15

6

15

6

15

15

15

20

15

35

15

45

-

**Z00 overload relays**

UL listed File No. E 29184  
CSA certified File No. 45958 + 43359  
Phase-failure sensitivity to IEC/EN 60 947

For direct mounting



0.1-0.16

0.16 - 0.24

0.24 - 0.4

0.4 - 0.6

0.6 - 1

1 - 1.6

1.6 - 2.4

2.4 - 4

4 - 6

6 - 10

10 - 16

16 - 24

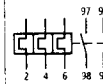

1

1

DILOOM  
DILOOAM  
DILOM  
DIL0AM

1

25

1

25

1

25

1

25

3

25

6

25

6

25

15

25

20

25

40

25

60

25

90

30

# Thermal Overload Relays

## ZE, Z00 Overload Relays

UL / CSA / IEC / CE

Thermal Overload Relays  
Thermistor Tripping Units

pe	Price	Notes
Article no.	See Price List	

<b>ZE-0,16</b>	
014263	
<b>ZE-0,24</b>	
014285	
<b>ZE-0,4</b>	
014300	
<b>ZE-0,6</b>	
014333	
<b>ZE-1,0</b>	
014376	
<b>ZE-1,6</b>	
014432	
<b>ZE-2,4</b>	
014479	
<b>ZE-4</b>	
014518	
<b>ZE-6</b>	
014565	
<b>ZE-9</b>	
014708	
<b>ZE-12<sup>3)</sup></b>	
14752	

- 1) When using DILEM and ZE, a distance of at least 5 mm should be maintained between overload relays mounted side by side
- 2) Max. 480V AC for type ZE
- 3) UL/CSA only

Short-circuit protection:  
The maximum admissible fuse for the contactor must be observed when mounting overload relays directly.

**ZE, Z00:**  
Mounted directly to the contactor

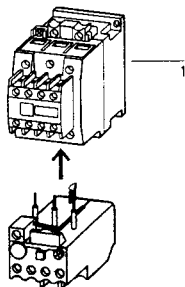

**Z00:**  
Separate mounting

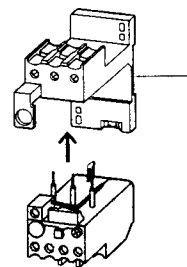

<b>Z00-0,16</b>	
048313	
<b>Z00-0,24</b>	
050686	
<b>Z00-0,4</b>	
053059	
<b>Z00-0,6</b>	
055432	
<b>Z00-1,0</b>	
057805	
<b>Z00-1,6</b>	
060178	
<b>Z00-2,4</b>	
062551	
<b>Z00-4</b>	
064924	
<b>Z00-6</b>	
067297	
<b>Z00-10</b>	
069670	
<b>Z00-16</b>	
072043	
<b>Z00-24</b>	
074416	

Accessories	Page
1 Contactors	03/008
2 Bases	04/016
Accessories	04/016



**Thermal Overload Relays**  
Z1, Z5 Overload Relays

	Adjustable setting range (motor full load current) $I_r$ A	Circuit diagram	Auxiliary contacts		For use with	Short-circuit protection	
			N.O.	N.C.		by fuses max. 600 V AC A	by circuit breaker max. 600 V AC A

**Z1 overload relays**

UL listed File No. E 29184  
CSA certified File No. 45958 + 43359  
Phase-failure sensitivity to IEC/EN 60 947

For direct mounting



6 – 10
10 – 16
16 – 24
24 – 40
40 – 57
50 – 63

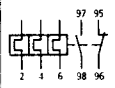

1	1
---	---

DIL1M  
DIL1AM  
DIL2M  
DIL2AM

40	40
60	60
90	90
125	125
200	150
200	150

For separate mounting

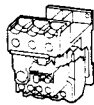

63 – 75
---------

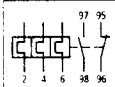

1	1
---	---

250	200
-----	-----

**Z5 overload relays, for direct mounting**

UL listed File No. E 29184  
CSA certified File No. 12528  
Phase-failure sensitivity to IEC/EN 60 947

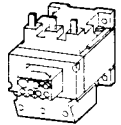

25 – 35
35 – 50
50 – 70
70 – 100

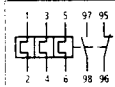

1	1
---	---

DIL3M80  
DIL3AM

125	125
225	200
250	250
400 class J	400

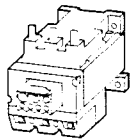

35 – 50
50 – 70
70 – 100
95 – 125
120 – 142

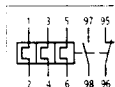

1	1
---	---

DIL4M115  
DIL4AM145

225	200
250	250
400 class J	400
500 class J	500
600 class J	600

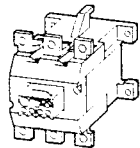

50 – 70
70 – 100
95 – 125
120 – 160
160 – 220
200 – 250

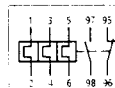

1	1
---	---

DILM185  
DILM225  
DILM250

250	250
400 class J	400
500 class J	500
600 class J	600
800 class L	800
700 class L	600

# Thermal Overload Relays

## Z1, Z5 Overload Relays

UL / CSA / IEC / CE

Thermal Overload Relays, Thermistor Tripping Units

Article no.	Price	Notes
	See Price List	

Z1-10	076789
Z1-16	079162
Z1-24	081535
Z1-40	083908
Z1-57	020257
Z1-63	086281
Z1-75	065598

**Z1:**  
Mounted directly on the contactor

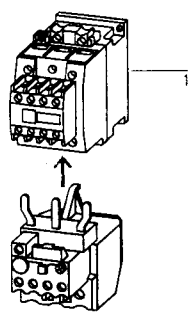

Separate mounting

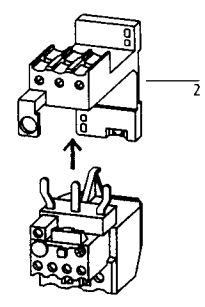

Z5-35/SK3	071573
Z5-50/SK3	071572
Z5-70/SK3	071571
Z5-100/SK3	071570
Z5-50/SK4	071565
Z5-70/SK4	071564
Z5-100/SK4	071563
Z5-125/SK4	071562
Z5-150/SK4	046556
Z5-70/FF250	210070
Z5-100/FF250	210071
Z5-125/FF250	210072
Z5-160/FF250	210073
Z5-220/FF250	210074

Accessories	Page
1 Contactors	03/010
2 Bases	04/016
Accessories	04/016

**Z5/SK:**  
Mounted directly on the contactor

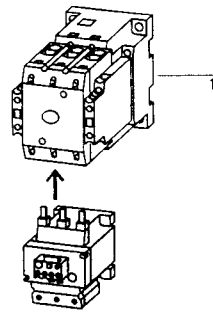

Accessories	Page
1 Contactors	03/010
Accessories	04/016

Z5-250/FF250  
210075



**Thermal Overload Relays**

UL / CSA / IEC / CE

**Z5 Overload Relays, ZW7 Current-Transformer Operated Overload Relays**

Thermal Overload Relays, Thermistor Tripping Units

	Adjustable setting range (motor full load current)	Circuit diagram	Auxiliary contacts		Short-circuit protection	
			N.O.	N.C.	by fuses max 600 V AC A	by circuit breaker max. 600 V AC A

**Z5 overload relays, for separate mounting**

UL listed File No. E 29184  
CSA certified File No. 12528

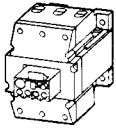
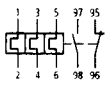
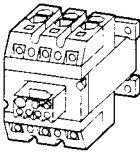
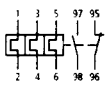
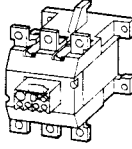
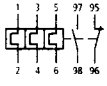
	25 – 35		1	1	125	125
	35 – 50				225	200
	50 – 70				250	250
	70 – 100				400 class J	400
	35 – 50		1	1	225	200
	50 – 70				250	250
	70 – 100				400 class J	400
	95 – 125				500 class J	500
	120 – 150				600 class J	600
	50 – 70		1	1	250	250
	70 – 100				400 class J	400
	95 – 125				500 class J	500
	120 – 160				600 class J	600
	160 – 220				800 class L	800
	200 – 250				700 class L	600

**ZW7 current transformer-operated overload relay, for separate mounting**

UL listed File No. E 29184  
CSA certified File No. 45958 + 43359

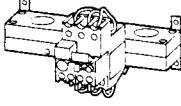
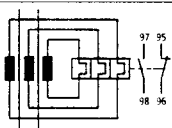
	42 – 63		1	1	as required by associated contactor overload relay is self-protecting	
	60 – 90					
	85 – 125					
	110 – 160					
	160 – 240					
	190 – 290					
	270 – 400					
	360 – 540					



# Thermal Overload Relays

UL / CSA / IEC / CE

## Z5 Overload Relays, ZW7 Current-Transformer Operated Overload Relays

Article no.	Price	Notes
	See Price List	

Z5-35/KK3  
071569

Z5-50/KK3  
071568

Z5-70/KK3  
071567

Z5-100/KK3  
071566

Z5-50/KK4  
071560

Z5-70/KK4  
071559

Z5-100/KK4  
071558

Z5-125/KK4  
071557

Z5-150/KK4  
046555

Z5-70/FF250  
210070

Z5-100/FF250  
210071

Z5-125/FF250  
210072

Z5-160/FF250  
210073

Z5-220/FF250  
210074

Z5-250/FF250  
210075

ZW7-63  
000245

ZW7-90  
002618

ZW7-125  
004991

ZW7-160  
007364

ZW7-240  
009737

ZW7-290  
052448

ZW7-400  
045329

ZW7-540  
047702

Thermal Overload Relays,  
Thermistor Tripping Units



## Electronic Overload Relays

### Description

ZEV – The revolutionary electronic overload relay for motor currents from 1–820 A

Thermal Overload Relays,  
Thermistor Tripping Units

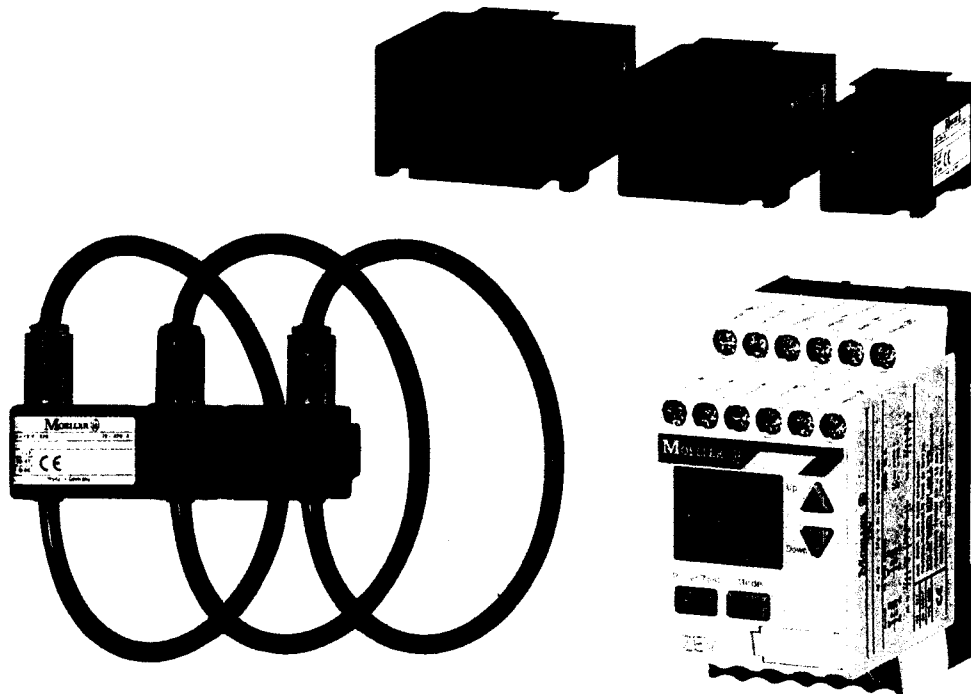

Technological advances require completely new approaches: the application of newly developed sensor systems and tripping units has made motor protection considerably simpler and more economical. All Z overload relays provide the standard functions: protection in the event of phase failure, overload, or current imbalance. The innovative ZEV motor-protective system from Moeller can now do all these things and much more:

#### Severe starting conditions:

Even the most severe starting situations can be dealt with by the ZEV motor-protective system. The enhanced tripping classes (up to Class 40) provide reliable protection for motors with starting times of up to 40 seconds. Protection for any motor starting situation can be optimally set by preselecting one of the eight tripping classes between 5 and 40. A ground fault is quickly detected by the external core-balance transformers. The integrated thermistor connection allows the relay to be upgraded to provide a full motor-protective system.

#### Simple and safe to operate:

The LCD display guides the user through the setting menus and ensures straightforward operation. In the event of a fault, the display shows the origin of the fault and enables rapid fault identification.

Additional signals can be implemented via the freely configurable auxiliary contacts 05-06 and 07-08.

They can each be assigned one of the following functions:

- Early warning of overload
- Ground-fault
- Thermistor tripping
- Internal fault

#### Simple engineering:

The multi-voltage module automatically adapts to different voltages from 24 – 240 V 50/60 Hz and 24 – 240 V DC, thus enabling flexible application with all conventional control voltages.

#### Simple and space-saving mounting:



Ring-type sensors enable the innovative ZEV overload relays to be used even for small motors. With high motor currents and large cable sizes, the sensor cables are simply laid around the supply cables. There is no need for main circuit wiring with complex cable matching to another unit, nor for drilling a mounting plate. Instead, the sensor is simply affixed using a Velcro fastening, saving installation time and expense. The volume of the transformer is reduced by up to 58 times in comparison with conventional transformers, saving valuable space in the control panel.

# Electronic Overload Relays

## Basic Units, Accessories

UL / CSA / IEC / CE

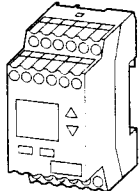
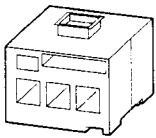
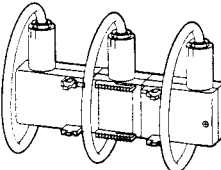
 Thermal Overload Relays,  
 Thermistor Tripping Units

	Setting range of overload trip	For use with	Fault currents	Type	Price
	Amps		A	Article no.	See Price List
<b>ZEV electronic motor-protective relay</b>					
	1 – 820	DILEM to DILM820		ZEV 209634	
<b>Current sensors</b>					
	1 – 25	DILEM, DIL00(A)M, DIL0(A)M		ZEV-XSW-25 209635	
	2–65	DIL1(A)M, DIL2(A)M		ZEV-XSW-65 209636	
	10 – 145	DIL3M80, DIL3AM85, DIL4M115, DIL4AM145		ZEV-XSW-145 209637	
	40 – 820	DILM185 to DILM820		ZEV-XSW-820 209641	
<b>Connecting cables</b>					
Length 200 mm		ZEV-XSW-25, ZEV-XSW-65, ZEV-XSW-145, ZEV-XSW-820		ZEV-XVK-20 209643	
Length 400 mm				ZEV-XVK-40 209644	
Length 800 mm				ZEV-XVK-80 209645	
<b>SSW core-balance transformers</b>					
For ground-leakage monitoring					
	⌀ 40 mm		0.3	SSW40-0,3 028286	
			0.5	SSW40-0,5 028305	
			1	SSW40-1 028306	
⌀ 65 mm			0.5	SSW65-0,5 028307	
			1	SSW65-1 028316	
⌀ 120 mm			0.5	SSW120-0,5 028319	
			1	SSW120-1 028321	

Electronic Overload Relays  
Selection Aids

Thermal Overload Relays,  
Thermistor Tripping Units

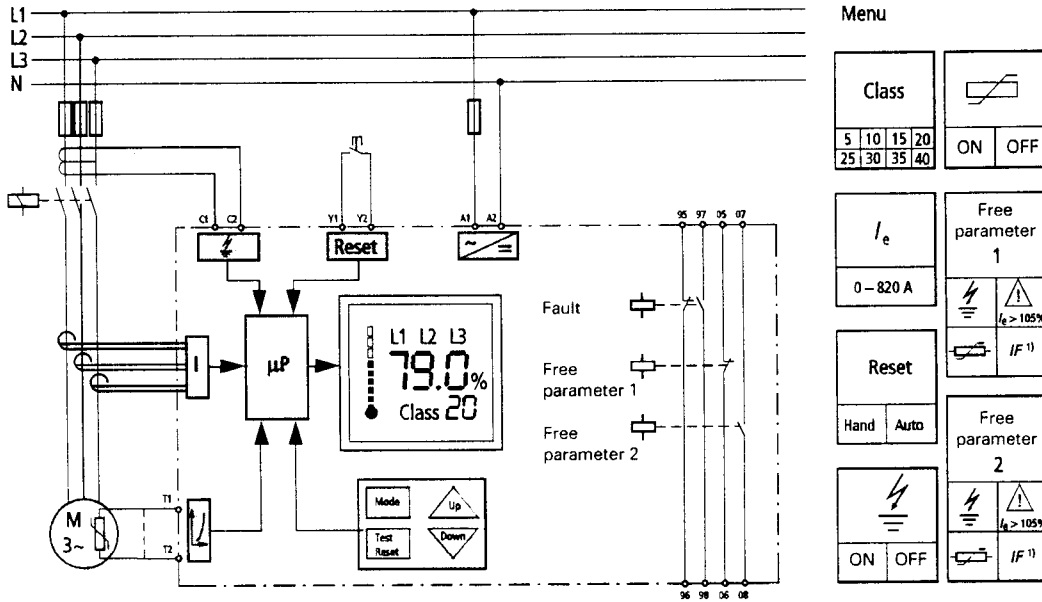

1) IF: Internal fault

Inputs		Outputs	
A1/A2	Rated control voltage	95/96	N.C. contact for overload/thermistor
T1/T2	Thermistor sensor	97/98	N.O. contact for overload/thermistor
C1/C2	SSW core-balance transformers	05/06	N.C. contacts freely assignable
Y1/Y2	Remote reset	07/08	N.O. contacts freely assignable

Tripping limit values for 3-pole balanced overload

Response current:	> 110% of the set current, < 120% of the set current
Tripping time on pressing the Test button:	5 sec
Operational readiness delay after tripping:	5 – 12 min (depending on the tripping class set) with thermistor tripping at 5 K below response temperature

Contactor selection based on starting duty (CLASS)

Contactors for normal and overload operation are designed to CLASS 10. The maximum rated operational current of the contactor must be reduced depending on the CLASS setting on the ZEV so that the contactors are not thermally overloaded if the tripping times are relatively long. The rated operational current  $I_e$  of the contactors can be calculated using the following derating factors:

$$I_{CLASS} = I_{CLASS 10} = I_e \quad I_{CLASS 15} = I_e \cdot 0.82 \quad I_{CLASS 20} = I_e \cdot 0.71 \quad I_{CLASS 25} = I_e \cdot 0.63 \quad I_{CLASS 30} = I_e \cdot 0.58 \quad I_{CLASS 35} = I_e \cdot 0.53 \quad I_{CLASS 40} = I_e \cdot 0.5$$

Tripping units with built-in sensor

With ZEV-XSW-25 to ZEV-XSW-145 ring-type sensors, the motor supply leads are passed through the apertures, one phase at a time. For motor currents of less than 1 A, the motor supply leads have to be looped back through ZEV-XSW-25. The number of loops is governed by the rated motor current.

Number of loops	4	3	2
Rated motor current $I_N$ [A]	0.31 – 0.4	0.41 – 0.62	0.63 – 1.24
Setting current on the relay $I_E$ [A] between the minimum and maximum value	1.24 – 1.6	1.23 – 1.86	1.26 – 2.48

The setting current  $I_E$  for the unit is calculated as:  $I_E = n \cdot I_N$

## Electronic Overload Relay

### Selection Aids

#### Tripping delay for the ZEV electronic motor-protective relay

Tripping class can be selected	CLASS	5	10	15	20	25	30	35	40
Tripping delay in s ( $\pm 10\%$ )	With 3-pole balanced load from cold								
Setting current $I_E$	x 3	11.3	22.6	34	45.3	56.6	67.9	79.2	90.5
	x 4	8	15.9	23.9	31.8	39.8	47.7	55.7	63.6
	x 5	6.1	12.3	18.4	24.6	30.7	36.8	43	49.1
	x 6	5	10	15	20	25	30	35	40
	x 7.2	4.1	8.2	12.3	16.4	20.5	24.5	28.6	32.7
	x 8	3.6	7.3	10.9	14.6	18.2	21.9	25.5	29.2
	x 10	2.9	5.7	8.6	11.5	14.4	17.2	20.1	23

#### Operational readiness delay after overload tripping (Summary of operational readiness delay, in minutes)

	CLASS	5	10	15	20	25	30	35	40
$t_{\text{ready}}$		5	6	7	8	9	10	11	12

Tripping delay in s ( $\pm 10\%$ )		With load imbalance in 2 poles, from cold							
Setting current $I_E$	x 3	8.4	16.5	24.5	32.5	40.6	48.6	56.6	64.6
	x 4	6.1	12.0	17.7	23.5	29.2	35.0	40.7	46.5
	x 5	4.8	9.4	13.9	18.4	22.9	27.4	31.9	36.3
	x 6	4.0	7.8	11.5	15.2	18.8	22.5	26.2	29.9
	x 7.2	3.3	6.5	9.5	12.6	15.6	18.6	21.6	24.7
	x 8	3.1	5.9	8.6	11.3	14.0	16.7	19.4	22.1
	x 10	2.5	4.7	6.9	9.0	11.1	13.3	15.4	17.6

Imbalance > 50 % results in tripping in 2-3 s

Imbalance < 35 % results in tripping according to the 3-phase characteristic



# Thermistor Tripping Units

UL / CSA / IEC / CE

For protection of motors with P.T.C. thermistors embedded in their windings

Thermal Overload Relays  
Thermistor Tripping Units

IEC rated operational current $I_e$ at		UL/CSA Pilot duty rating	Rated operational voltage range $U_s$	Type	Price
AC-15	AC-14			Article no.	See Price List
220 V	380 V				
230 V	400 V				
240 V					
A	A		V		

## Thermistor overload relays for machine protection

for use with P.T.C. (positive temperature coefficient) thermistors

- With automatic reset
- Power ON and fault LED display

3	3	B 300	24 – 240 V 50/60 Hz, 24 – 240 V DC	<b>EMT6</b> 066166
---	---	-------	---------------------------------------	-----------------------

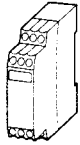

- Selector switch with manual / automatic reset
- For manual or remote resetting
- Test button
- Power ON and fault LED display

3	3	B 300	24 – 240 V 50/60 Hz, 24 – 240 V DC	<b>EMT6-DB</b> 066167
---	---	-------	---------------------------------------	--------------------------

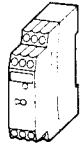

- Multi-function device
- Selector switch with manual / automatic reset
- Short-circuit recognition in the sensor circuit
- Reliable fault signalling even under supply voltage failure (Zero-voltage safety)
- For manual or remote resetting
- Test button
- Short-circuit recognition and zero-voltage safety can be switched off
- Power ON and fault LED display

3	3	B 300	24 – 240 V 50/60 Hz, 24 – 240 V DC	<b>EMT6-DBK</b> 066168
---	---	-------	---------------------------------------	---------------------------

### Accessories

#### Panel mount adapter

- Without the adapter the EMT 6 is suitable for 35 mm DIN rail mounting only. The adapter enables the EMT 6 to become a panel mounted device using conventional screws.

**CS-TE**  
095853



# Thermistor Tripping Units

UL / CSA / IEC / CE

For protection of motors with P.T.C. thermistors embedded in their windings

Terminal marking to EN 50 005

Flow diagrams

LED display

- green - Supply voltage is applied
- yellow - Device has tripped
- red - Device has tripped/short circuit in sensor circuit

Notes

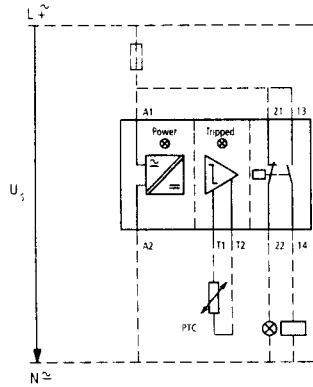

## EMT6, EMT6-DB, EMT6-DBK Auto

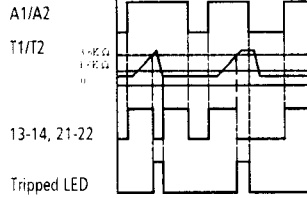

Suitable for the protection of EEx e motors.  
PTB certificate no. 3.53-14606/96

Can be snap mounted on an EN 50 022 top-hat rail

At  $R_K \leq 250 \Omega$  per sensor: 6 sensors,  
at  $R_K \leq 100 \Omega$  per sensor: 9 sensors in the winding  
(to be provided by the user),  
Maximum length of thermistor cable 250 m  
(unscreened); total thermistor resistance  $\Sigma R_K \leq 1500 \Omega$

All the devices are also suitable for monitoring thermal contact sensors.

Characteristic values of sensor circuit at  $U_s$  and  $+20^\circ\text{C}$

$R_{T1-T2}$	EMT6... $U_{T1-T2}$ V DC max.	$I_{T1-T2}$ mA max.
T1, T2 short-circuited	—	1.9
4 k $\Omega$	3	0.8
T1-T2 open	5.1	—

Thermal Overload Relays,  
Thermistor Tripping Units

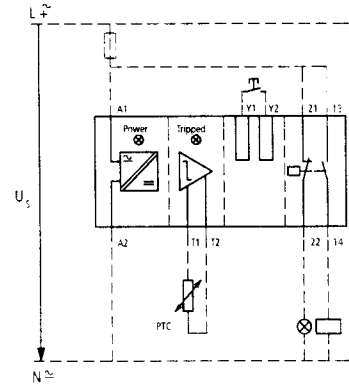

## EMT6-DB, EMT6-DBK Manual

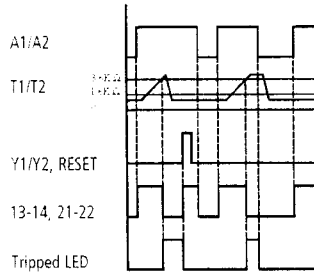

Functions that can be disconnected on EMT6-DBK:

Function	Disconnection via jumper
Short-circuit recognition	$Y_1 - Y_3$
Zero-voltage safety	$Y_1 - Y_4$

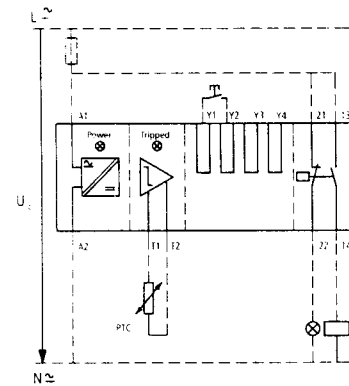

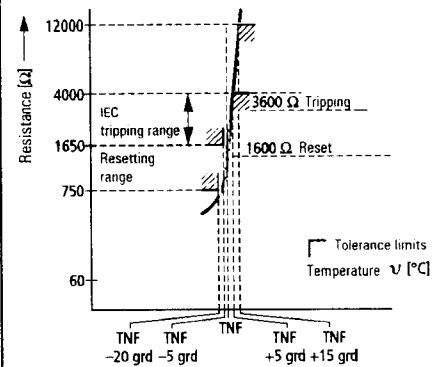
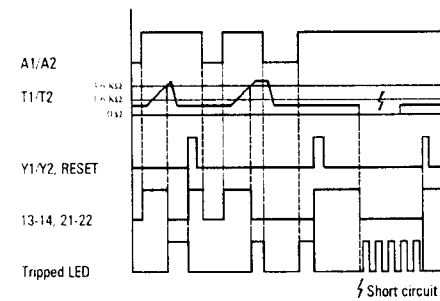

## EMT6-DBK Zero-voltage safe operation



# Thermal Overload Relays

## Accessories

Thermal Overload Relays,  
Thermistor Tripping Units

		For use with	Type	Price
			Article no.	See Price List
<b>Bases</b>				
For separate mounting		Z00	<b>EZ00</b> 022630	For snap mounting on an EN 50 022 top-hat rail or screw mounting
		Z1	<b>EZ1</b> 025003	
<b>Pushbuttons</b>				
For enclosed overload relays Mounting diameter 22.5 mm				
External reset button, IP65				
	Front ring	Matt chromed	<b>MDE-286</b> 208186	Blue button plate: R
		Black	<b>MDE-286-S</b> 208187	
		Matt chromed	<b>MDE-287</b> 012110	Blue button plate: RESET
		Black	<b>MDE-287-S</b> 080098	
Off button, IP65				
	Front ring	Matt chromed	<b>MDA-04</b> 022625	Red button plate
		Black	<b>MDA-04-S</b> 003093	
		Matt chromed	<b>MDA-10</b> 029744	Red button plate with white circle
		Black	<b>MDA-10-S</b> 003094	
		Matt chromed	<b>MDA-110</b> 036863	Red button plate: STOP
		Black	<b>MDA-110-S</b> 080118	





# Thermal Overload Relays Accessories

Thermal Overload Relays,  
Thermistor Tripping Units

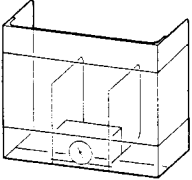
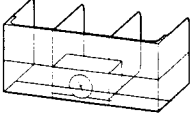
	For use with	Type	Price
		Article no.	See Price List
<b>Shrouds</b>			
	Z5-.../FF250	<b>Z5/FF250-XHB</b> 215217	Overload relay for separate mounting
			<div style="border: 1px solid black; padding: 2px; width: fit-content; margin-bottom: 2px;">Z5/FF250-XHB</div> <div style="border: 1px solid black; padding: 2px; width: fit-content; margin-bottom: 2px;">Z5-.../FF250</div> <div style="border: 1px solid black; padding: 2px; width: fit-content; margin-bottom: 2px;">Z5/FF250-XHB</div>
	Direct mounting of Z5-.../FF250 to DILM185, DILM225, DILM250	<b>Z5/FF250-XHB-Z</b> 215218	Overload relay mounted directly to contactor
			<div style="border: 1px solid black; padding: 2px; width: fit-content; margin-bottom: 2px;">DIL M400-XHB</div> <div style="border: 1px solid black; padding: 2px; width: fit-content; margin-bottom: 2px;">DIL M185/ 225/250</div> <div style="border: 1px solid black; padding: 2px; width: fit-content; margin-bottom: 2px;">Z5/FF250-XHB-Z</div> <div style="border: 1px solid black; padding: 2px; width: fit-content; margin-bottom: 2px;">Z5-.../FF250</div> <div style="border: 1px solid black; padding: 2px; width: fit-content; margin-bottom: 2px;">Z5/FF250-XHB</div>
<b>Terminals</b>			
	Z5-FF250	<b>Z5-FF250-XK-CNA</b> 229314	UL approved /CSA certified. 1 set of 3 terminals. Wire size # 6 AWG - 350 MCM



# Z, ZW and ZEV Overload Relays

## Technical Data

Thermal Overload Relays,  
Thermistor Tripping Units

### Tripping characteristics

These tripping characteristics show mean values of the tolerance range at 20 °C ambient temperature starting from cold. They show the tripping times in relation to the response current. At operational temperature, the tripping time of the overload relay

drops to approximately 25% of that shown. Specific characteristics for each individual setting range are available on request.

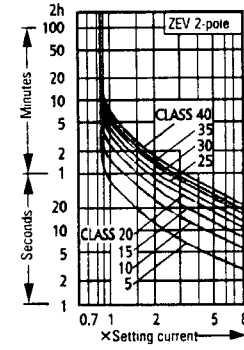
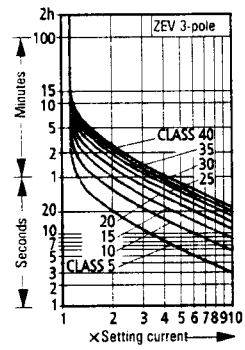
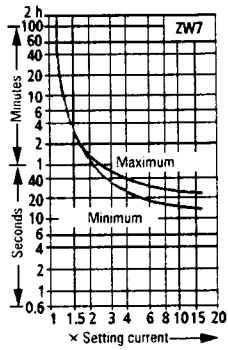
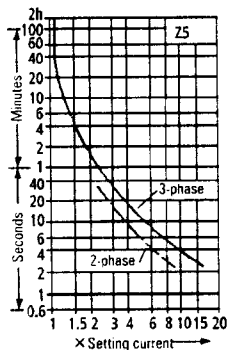
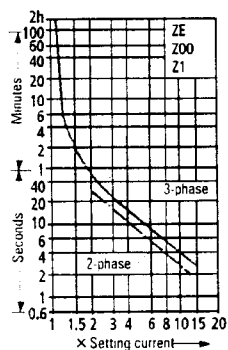

In the event of phase failure or an imbalance > 50 %, the ZEV trips out within 2 – 3 seconds.



ZE		Z00		Z1		ZW7	
Setting range	Tripping characteristics to AWA no.	Setting range	Tripping characteristics to AWA no.	Setting range	Tripping characteristics to AWA no.	Setting range	Tripping characteristics to AWA no.
A		A		A		A	
0.1 – 0.16	23-1036-1	0.1 – 0.16	23-657-10	6 – 10	23-657-40	42 – 63	23-657-60
0.16 – 0.24	23-1036-2	0.16 – 0.24	23-657-12	10 – 16	23-657-42	60 – 90	23-657-62
0.24 – 0.4	23-1036-3	0.24 – 0.4	23-657-14	16 – 24	23-657-44	85 – 125	23-657-64
0.4 – 0.6	23-1036-4	0.4 – 0.6	23-657-16	24 – 40	23-657-46	100 – 160	23-657-66
0.6 – 1.0	23-1036-5	0.6 – 1.0	23-657-18	40 – 57	23-657-48	160 – 240	23-657-68
1.0 – 1.6	23-1036-6	1.0 – 1.6	23-657-20	50 – 63	23-657-49	190 – 290	23-657-70
1.6 – 2.4	23-1036-7	1.6 – 2.4	23-657-22	63 – 75	23-657-51.2	270 – 400	23-657-72
2.4 – 4	23-1036-8	2.4 – 4	23-657-24			360 – 540	23-657-74
4 – 6	23-1036-9	4 – 6	23-657-26			420 – 630	23-657-76
6 – 9	23-1036-10	6 – 10	23-657-28				
		10 – 16	23-657-30				
		16 – 24	23-657-32				

Z5-.../...K ...		ZEV	
Setting range	Tripping characteristics to AWA no.	Load	Tripping characteristics to AWA no.
A			
25 – 30	23-657-80		2321-1888
35 – 50	23-657-82		
50 – 70	23-657-84		
70 – 100	23-657-86		
95 – 125	23-657-88		
120 – 160	23-657-90		
160 – 220	Please enquire		
200 – 350	Please enquire		

**Note:**

<sup>1)</sup> All types have adjustable dial for setting motor full load current. Trip current is 125 % of set value. For motors with a service factor (SF) of 1.0, set dial to 90% of motor full load current.

# Z, ZW and ZEV Overload Relays

## Technical Data

Thermal Overload Relays  
Thermistor Tripping Units

### Features

	ZE	Z00 Z1	Z5	ZW7	ZEV
Phase-failure sensitivity	●	●	●	●	●
Temperature compensation	●	●	●	●	●
Auxiliary contacts 1 N.O. + 1 N.C.	●	●	●	●	●
Test-/Off button	●	●	●	●	●
Reset button Hand/Auto	●	●	●	●	●
Separate mounting	-	●	●	●	●
Protection of EEx e motors (PTB)	●	●	●	●	Please enquire
Protection during severe starting duty	-	-	-	●	●
Trip-free release	●	●	●	●	●
Trip indication	-	●	●	●	●

### PTB certificate no.

ZE	3.53/380.793
Z00	3.53-12759/96
Z1	3.53-12757/96
Z5	3.53-23022/94
ZEV	Please enquire
EMT6	3.53-14606/96

● Standard feature

### Protection of DC motors:

1-pole

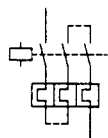

2-pole

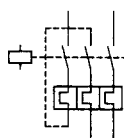

### Mounting position:

ZE

Z00  
Z1  
Z5

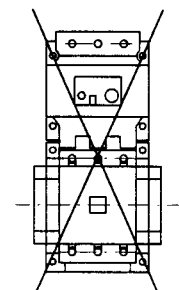

## Z Thermal Overload Relays

## Technical Data

Thermal Overload Relays,  
Thermistor Tripping Units

			ZE	Z00	Z1 (Z1-75)	Z5-.../K3	Z5-.../K4
<b>General technical data</b>							
Standards			UL, CSA, IEC/EN 60 947, VDE 0660				
Climatic proofing			Damp heat, constant, to IEC 60 068-2-3 Damp heat, cyclical, to IEC 60 068-2-30				
Ambient temperature	Open	Min./Max.	°C	-25/50 <sup>1)</sup>	-25/50 <sup>1)</sup>	-25/50 <sup>1)</sup>	-25/50 <sup>1)</sup>
	Enclosed			-25/40 <sup>1)</sup>	-25/40 <sup>1)</sup>	-25/40 <sup>1)</sup>	-25/40 <sup>1)</sup>
Storage temperature			°C	-	-	-	-
Temperature compensation				Continuous			
Dimensions			Page	04/024	04/024	04/024	04/024
Mounting position			Page	04/019	04/019	04/019	04/019
Weight			kg	0.07	0.13	0.21	1.3 (/SK3)
			kg	-	-	(0.34)	1.44 (/KK3)
Mechanical shock resistance (half-sinusoidal shock)			g/ms	10/10	10/10	10/10	10/10
							1.64 (/KK4)
Degree of protection				IP20	IP00	IP00	IP00
Protection against direct contact from the front when actuated by a perpendicular test finger (IEC 536)				Finger and back-of-hand proof			
<b>Main contacts</b>							
Rated impulse withstand voltage $U_{imp}$	V		6000	6000	6000	8000	8000
Overvoltage category/pollution degree			III/3	III/3	III/3	III/3	III/3
Rated insulation voltage $U_i$	V AC		690	690	690	1000	1000
Rated operational voltage $U_e$ / (UL/CSA)	V AC		690/600	690/600	690/600	1000/600	1000/600
Safe isolation to IEC 536							
	Between the main contacts and the auxiliary contacts as well as between the main contacts	V AC	300	440	440	440	440
Current setting	A		0.1 – 12	0.1 – 24	6 – 75	25 – 100	35 – 142
Short-circuit protection							
	Max. fuse	Page	04/004	04/004	04/006	04/006	04/006
<b>Current heat loss (3 current paths)</b>							
Lower value of the setting range	W		2.5	2.5	3 (7)	< 16	< 16
Maximum setting	W		6	6	7.5 (10)	< 28	< 28
<b>Terminal capacity</b>							
Solid	mm <sup>2</sup>		2 × (0.75 – 2.5)	2 × (1 – 6)	2 × (1 – 16) <sup>2)</sup>	16	16
Flexible without ferrule	mm <sup>2</sup>		-	-	-	50	70
Flexible with ferrule	mm <sup>2</sup>		2 × (0.5 – 1.5)	2 × (1 – 6)	1 × 25 2 × (1 – 10) <sup>2)</sup>	50	70
Stranded	mm <sup>2</sup>		-	-	-	50	70
Flexible with cable lug	mm <sup>2</sup>		-	-	-	-	-
Stranded with cable lug	mm <sup>2</sup>		-	-	-	-	-
Solid or stranded	AWG		18 – 14	8–14	14 – 2	2	2/0
Flat conductor <sup>3)</sup>	mm		-	-	-	6 × 9 × 0.8	6 × 16 × 0.8
Busbar	mm		-	-	-	-	-
Terminal screws			M3.5	M4	M6	M8	M10
Pozidriv screwdriver	Size		2	2	2	-	-
Standard screwdriver	mm		0.8 × 5.5	1 × 6	1 × 6	-	-
Hexagon socket head wrench	SW		-	-	-	4	5
Hexagon head wrench	SW		-	-	-	-	-
Tightening torque	Nm		1.2	1.8	3.5	6	10

**Notes** <sup>1)</sup> Operating range to IEC/EN 60 947, PTB: 5 °C to +50 °C

<sup>2)</sup> When using two conductors, use equal cross-sections

<sup>3)</sup> Z5-.../FF250: Secure using box terminal



# Z Thermal Overload Relays

## Technical Data

Z5-.../FF250	ZW7	ZEV	ZEV-XSW-25	ZEV-XSW-65	ZEV-XSW-145	ZEV-XSW-820
UL, CSA, IEC/EN 60 947, VDE 0660						
Damp heat, constant, to IEC 60 068-2-3						
Damp heat, cyclical, to IEC 60 068-2-30						
-25/50 <sup>1)</sup>	-25/50 <sup>1)</sup>	-25/+60 <sup>2)</sup>	-25/+60 <sup>1)</sup>	-25/+60 <sup>1)</sup>	-25/+60 <sup>1)</sup>	-25/+60 <sup>1)</sup>
-25/40 <sup>1)</sup>	-25/40 <sup>1)</sup>	-25/40 <sup>2)</sup>	-25/40 <sup>1)</sup>	-25/40 <sup>1)</sup>	-25/40 <sup>1)</sup>	-25/40 <sup>1)</sup>
-	-	-40/80	-40/80	-40/80	-40/80	-40/80
Continuous						
04/027	04/027	04/026	04/026	04/026	04/026	04/026
04/019	As required	As required	As required	As required	As required	As required
1.55	0.8	0.25	0.2	0.4	0.5	0.3
-	-	-	-	-	-	-
10/10	10/10	15/10	-	-	-	-
IP00	IP00	IP20	-	-	-	-
With terminal cover	Finger and back-of-hand proof					
8000	6000	-	-	-	-	8000
III/3	III/3	-	-	-	-	III/3
1000	690	-	-	-	-	1000
1000/600	690/600	-	-	-	-	1000/600
440	440	500 <sup>3)</sup>	-	-	-	-
50 – 250	40 – 540	1 – 820 <sup>4)</sup>	1 – 25	2–65	10 – 145	40 – 820
04/006	For overload relay in conjunction with transformers As required for contactor					
< 16	3	-	-	-	-	-
< 28	10	-	-	-	-	-
-	∅ 27 mm	-	-	-	-	-
-	-	-	-	-	-	-
-	-	-	-	-	-	-
-	-	-	-	-	-	-
95	-	-	-	-	-	-
120	-	-	-	-	-	-
250 MCM	-	-	-	-	-	-
6 × 16 × 0.8	-	-	-	-	-	-
20 × 3	-	-	-	-	-	-
M8 × 25	-	-	-	-	-	-
-	-	-	-	-	-	-
-	-	-	-	-	-	-
-	-	-	-	-	-	-
13	-	-	-	-	-	-
10 – 14	-	-	-	-	-	-

<sup>1)</sup> Operating range to IEC/EN 60 947,  
PTB: -5 °C to +50 °C

<sup>2)</sup> Limited legibility of the LCD display at < -15 °C

<sup>3)</sup> With ZEV ... between busbar and sensor

<sup>4)</sup> Setting range dependent on current sensor



## Z Thermal Overload Relays

### Technical Data

		ZE	Z00 Z 1 Z 5	ZW7	ZEV
<b>Auxiliary and control circuits</b>					
Rated impulse withstand voltage $U_{imp}$	V	6000	6000	6000	4000
Overtoltage category/pollution degree		III/3	III/3	III/3	III/3
<b>Terminal capacity</b>					
Solid	mm <sup>2</sup>	2 × (0.75 – 2.5)	2 × (0.75 – 4)	2 × (0.75 – 4)	1 × (0.5 – 2.5) 2 × (0.5 – 1.5) <sup>2)</sup>
Flexible with ferrule	mm <sup>2</sup>	2 × (0.5 – 1.5)	2 × (0.75 – 2.5)	2 × (0.75 – 2.5)	1 × (0.5 – 2.5) 2 × (0.5 – 1.5) <sup>2)</sup>
Solid or stranded	AWG	2 × (18 – 12)	2 × (18 – 12)	2 × (18 – 12)	2 × (18 – 12)
Terminal screws		M3.5	M3.5	M3.5	M3.5
Pozidriv screwdriver	Size	2	2	2	1
Standard screwdriver	mm	0.8 × 5.5	1 × 6	1 × 6	0.8 × 5.5
Tightening torque	Nm	0.8 – 1.2	0.8 – 1.2	0.8 – 1.2	0.8
Rated insulation voltage $U_i$	V AC	690	500	500	250
Rated operational voltage $U_e$	V AC	500	500	500	240
Conventional thermal current $I_{th}$	A	6	6	6	6
<b>Rated operational current <math>I_e</math></b>					
AC-15 make/break contacts					
120 V	A	–	–	–	3 <sup>3)</sup>
220/240 V	A	1.5/1.5	1.5/1.5	1.5/1.5	3 <sup>3)</sup>
380/415 V	A	0.5/0.7	0.5/0.9	0.5/0.9	–
500 V	A	0.3/0.5	0.5/0.8	0.5/0.8	–
DC-13 <sup>1)</sup> at L/R ≤ 15 ms make/break contacts					
24 V	A	0.9	0.9	0.9	1
60 V	A	0.75	0.75	0.75	–
110 V	A	0.4	0.4	0.4	–
220 V	A	0.2	0.2	0.2	–
Power consumption	W	–	–	–	2.5
<b>Pick-up and drop-out values</b>					
AC		–	–	–	0.85 – 1.1 $U_s$
DC		–	–	–	0.85 – 1.1 $U_s$
<b>UL/CSA</b>					
Rated voltage	V AC/DC	300/300	600/300	600/300	600/300
Pilot duty rating	AC	D300 <sup>5)</sup>	B 600/B 300 same polarity / opposite polarity		
	DC	R 300	R 300	R 300	R 300
<b>Thermistor protection</b>					
Total resistance (cold)	Ω	–	–	–	1500
Response value	Ω	–	–	–	2700 – 3100
Reset range	Ω	–	–	–	1500 – 1650
<b>Recovery time</b>					
Overload		–	–	–	5 – 12 min <sup>4)</sup>
Thermistor trip		–	–	–	5 K below response temperature
<b>Ground fault protection</b>					
					immediate

#### Notes

- <sup>1)</sup> Making and breaking currents to DC-13, time constant as stated
- <sup>2)</sup> When connecting 2 conductors, only the following combinations are admissible:  
0.5 and 0.75 mm<sup>2</sup>  
0.75 and 1 mm<sup>2</sup>  
1 and 1.5 mm<sup>2</sup>
- <sup>3)</sup> Contacts 95/96 and 97/98 (contactor control) 3 A  
Contacts 05/06 and 07/08 (auxiliary contacts) 1.5 A
- <sup>4)</sup> Dependent on the setting of the tripping class
- <sup>5)</sup> Additional rating of .6A at 600 V AC and 1.5A at 240 V AC



## EMT Thermistor Tripping Units

## Technical Data

				EMT6
<b>General technical data</b>				
Standards				UL, CSA, IEC/EN 60 947, VDE 0660, EN 55 011
Climatic proofing				Damp heat, constant, to IEC 60 068-2-3 Damp heat, cyclical, to IEC 60 068-2-30
Ambient temperature	Open	Min./Max.	°C	-25/+60
	Enclosed	Min./Max.	°C	-25/+45
Mounting position				As required
Weight			kg	0.15
Dimensions				→ Page 04/025
Mechanical shock resistance (half-sinusoidal shock 10 ms)			g	10
Degree of protection			IP	20
Protection against direct contact from the front when actuated by a perpendicular test finger (IEC 536)				Finger and back-of-hand proof
Safe isolation to IEC 536				
Between the contacts			V	250
and between contacts and power supply			V	250
<b>Auxiliary and control circuit</b>				
Rated impulse withstand voltage $U_{imp}$			V	6000
Overvoltage category/pollution degree				III/3
Terminal capacity: auxiliary and control circuit				
Solid			mm <sup>2</sup>	2 × (0.5 – 1.5)
			mm <sup>2</sup>	1 × 2.5
Flexible with ferrule			mm <sup>2</sup>	2 × (0.5 – 1.5)
			mm <sup>2</sup>	1 × 2.5
Solid or stranded			AWG	16 – 14
Terminal screw				M3.5
Pozidriv screwdriver				2
Standard screwdriver				1 × 6
Tightening torque			Nm	0.8 – 1.2
<b>Auxiliary circuit</b>				
Rated insulation voltage $U_i$			V	400
Rated operational voltage $U_e$			V	400
UL/CSA Pilot duty rating			AC	B 300
Rated operational current $I_e$				
AC-14 make and break contacts		380/415 V	A	3/3
AC-15 make and break contacts		240V	A	3
		380/415 V	A	1/1
Short-circuit rating without welding, max. fuse			A gG/gL	6
<b>Control circuit</b>				
Rated insulation voltage $U_i$			V	240
Rated operational voltage $U_e$			V	240
Pick-up and drop-out values,				$0.85 - 1.1 \times U_e$
Power consumption		AC	VA	3.5
		DC	W	2
Tripping at approx.			$\Omega$	$\geq 3600$
Recovery at approx.			$\Omega$	$\leq 1600$

Z Thermal Overload Relays  
Dimensions

Thermal overload relays

ZE

Thermal Overload Relays,  
Thermistor Tripping Units

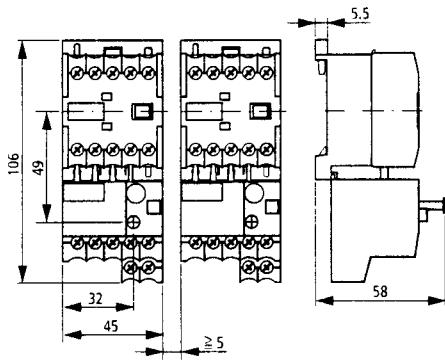

Z00 + EZ00  
Z1 + EZ1

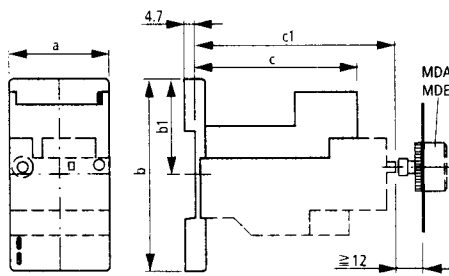

EZ00: 2 M4 × 12  
EZ1: 2 M5 × 15

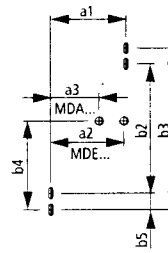

	EZ00	EZ1
a	45	60
a1	35	50
a2	34	41.5
a3	22.5	30
b	85	86
b1	42.5	42.5
b2	60	—
b3	75	75
b4	41	36
b5	7.5	—
c	73	112
c1	90	102



Z5-.../SK

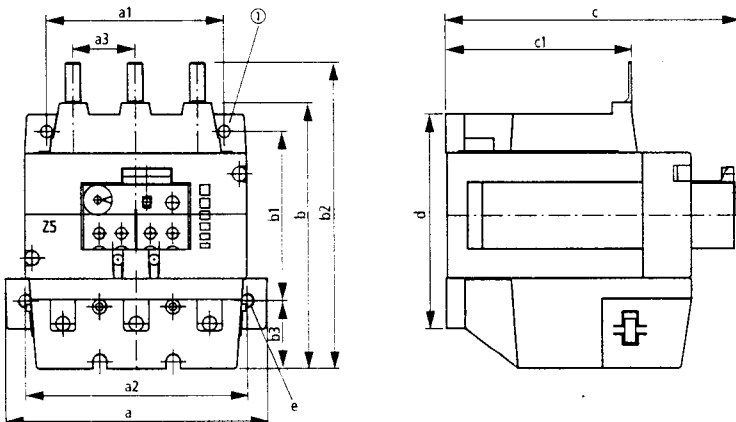

	Z5-.../SK3	Z5-.../SK4
a	100	118
a1	80	80
a2	80	100
a3	28	28
b	117	117
b1	74	74
b2	135	135
b3	22	23
c	133	133
c1	82.5	84
d	94	94
e	∅6	∅7

a = Knockout, supplied closed

Z5-.../KK

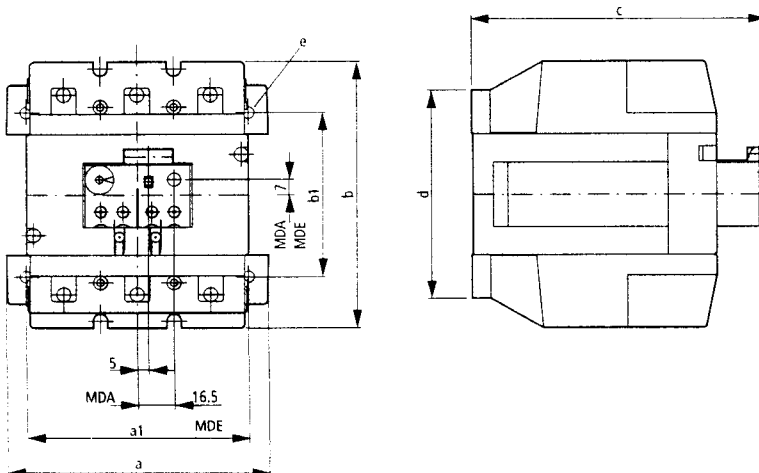

	Z5-.../KK3	Z5-.../KK4
a	100	118
a1	80	100
b	120	120
b1	74	74
c	133	133
d	94	94
e	∅6	∅7



# Z Overload Relays, Current-Transformer Operated Overload Relays, Thermistor Tripping Units

## Dimensions

Thermal Overload Relays,  
Thermistor Tripping Units

### Overload relays

Z5.../FF250

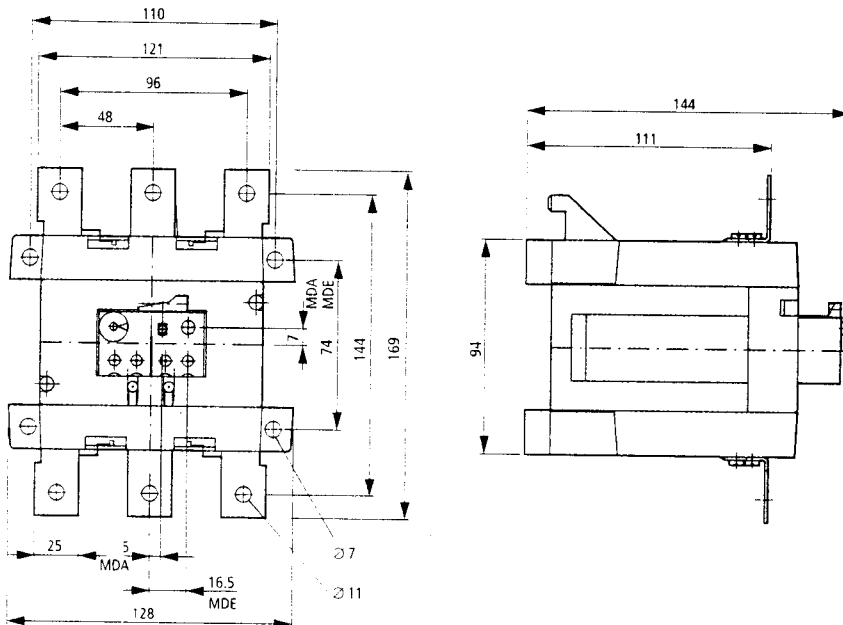

### Current-transformer operated relays

ZW7...

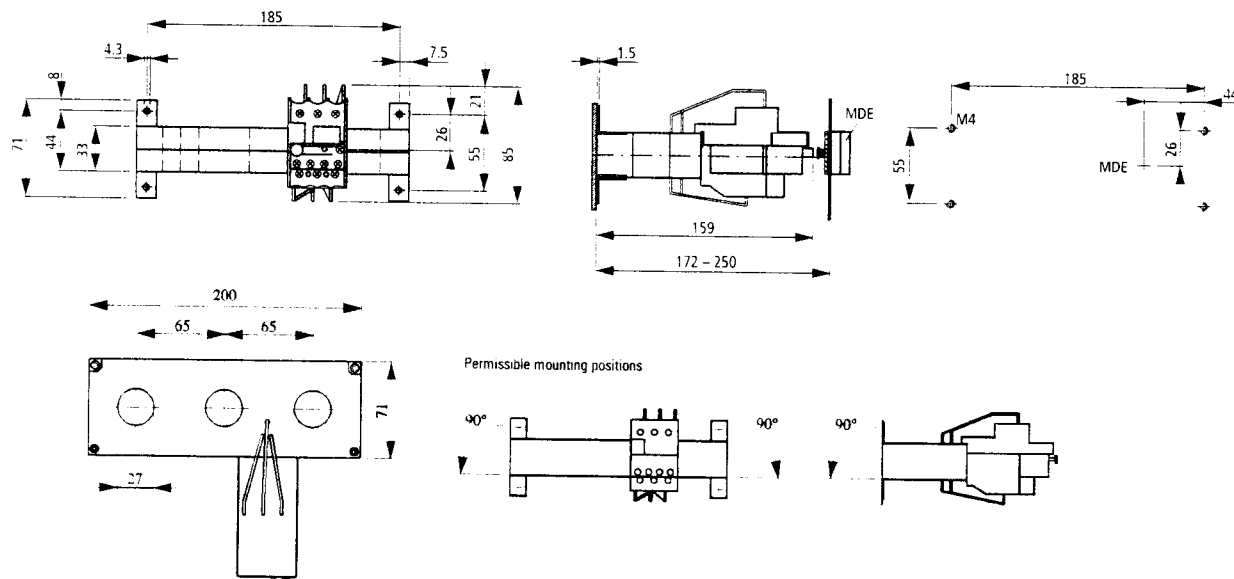

### Thermistor overload relays

EMT6(-DB)  
EMT6-DBK

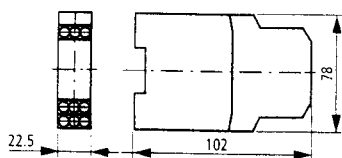

### MDE external reset button MDA Off button

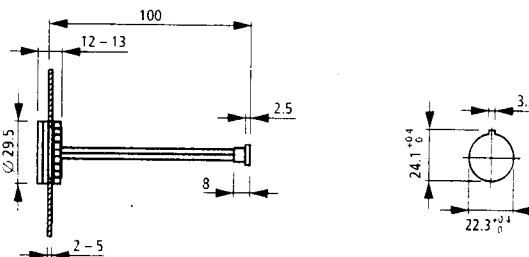

# ZEV Electronic Overload Relays

Electronic overload relay

ZEV

Thermal Overload Relays  
Thermistor Tripping Units

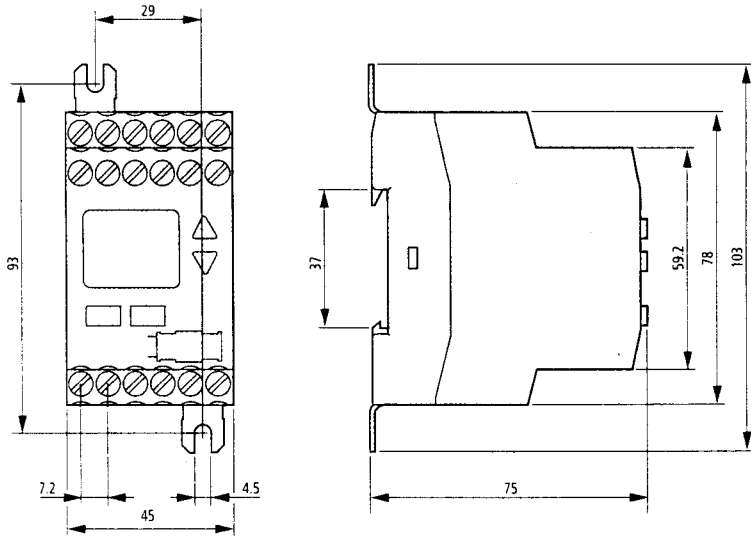

## Current sensors

ZEV-XSW-...

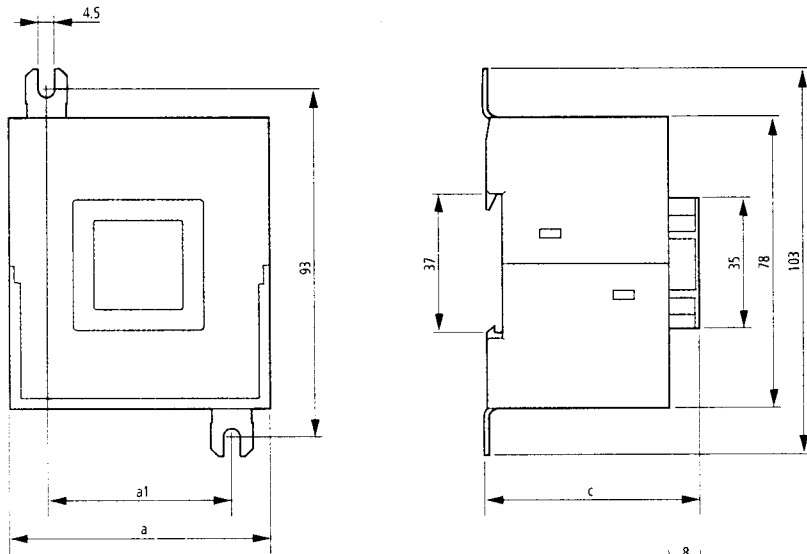

ZEV-XSW-...	25	65	145
a	45	70	90
a1	24	49	68
c	50	58	65
d1	6	13	21
d2	11.2	19	26

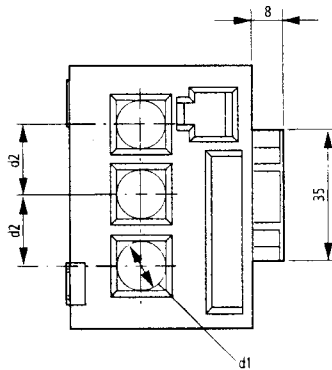

# ZEV Electronic Overload Relays

## Dimensions

Thermal Overload Relays  
Thermistor Tripping Units

Electronic overload relays  
ZEV ZEV-XSW-...

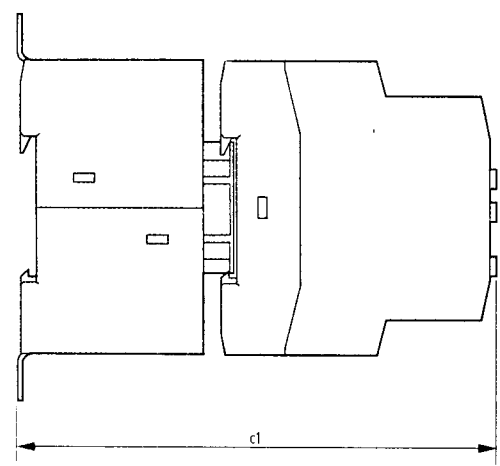

ZEV ZEV-XSW-...	25	65	145
c1	120	128	134

### Current sensors

ZEV-XSW-820

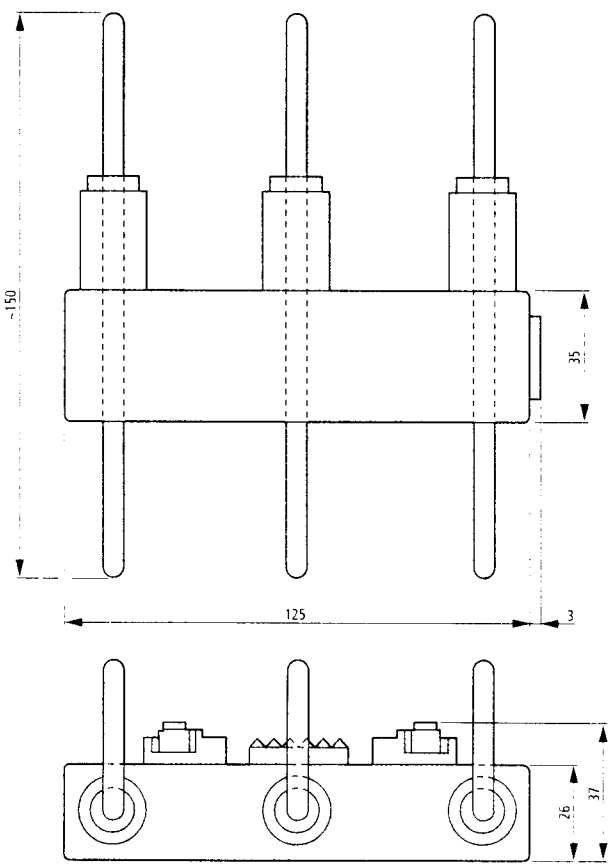

Thermal Overload Relays  
Thermistor Tripping Units

