

Rev1.6MAY15

OWNER & OPERATORS MANUAL HYBRID 1200 LED LIGHT TOWER

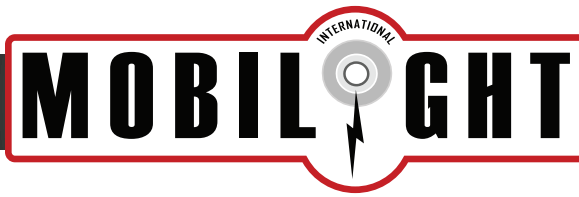

THANK YOU for purchasing the Hybrid 1200 LED Light Tower from Mobilight International, the most innovative light tower on the market. Our intelligent design provides a safe, silent, and dependable source of brilliant LED light with the lowest maintenance demand of any light tower. Standard with 600 watts of ultra-high efficiency lighting, 1200 watts of solar collection and backed by an 18 horsepower Kubota diesel engine and generator; the Hybrid unit will provide 365 days of dusk to dawn operation in even the most demanding conditions. The Hybrid 1200 embraces state-of-the-art performance and safety features such as: remote light tilt and rotation, solar array with a MPPT solar charge controller, a sealed, maintenance-free AGM battery bank, and an optional GPS based performance monitoring system that reports battery voltage, fuel percentage, and the on/off status of lights. The Hybrid 1200 is the ultimate mobile lighting solution for mining operations, oil and gas sites, area lighting for construction activities and special events, and security lighting.



The following Owner and Operator's Manual contains important safety and operational information for the Hybrid 1200 LED Light Tower. The manual must be read and understood prior to operation to ensure the safety of the operator and the integrity of the equipment. Please contact Mobilight International at 801.280.4280 or visit www.mobilight.com for additional information and technical support.

Please take a moment to record information details about your tower.

Unit Model Number	
Unit Serial Number	
Unit Vehicle Identification Number (V.I.N.)	
Solar Panel Serial Numbers	1: 2: 3: 4:
Solar Charge Controller Serial Number	
AC Charger Serial Numbers	1: 2: 3: 4:
Miscellaneous	

READ and SAVE THESE INSTRUCTIONS!

MOBILIGHT INTERNATIONAL

7272 Airport Road
West Jordan, UT 84084
+1 (801) 280-4280
www.mobilight.com

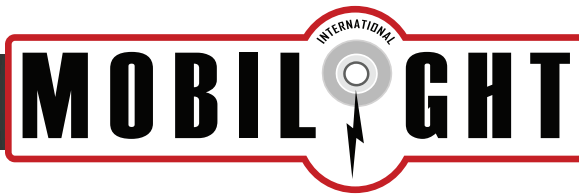
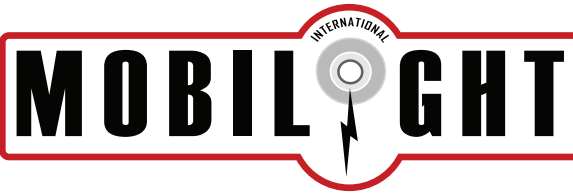

TABLE OF CONTENTS

Introduction	1
Tower Data and Serial Numbers	2
Table of Contents	3
General Systems Information	4
<i>System Specifications</i>	4
Control Panel Layout A	8
Control Panel Layout B	9
Generator Auto-Run Controller	10
AC Power Distribution Breaker Panel Schedule	11
Tire Placard	12
Thermostat Programming	12
Operational Procedures	14
Setup Procedure of the Hybrid 1200 Unit	14
PHASE 1: Position the Unit	14
PHASE 2: Deploy Outriggers	16
PHASE 3: Establish Earth Ground	17
PHASE 4: Raise and Extend Tower Mast	18
PHASE 5: Deploy Solar Panel Array	20
PHASE 6: Deploy LEDs	26
PHASE 7: Lighting Operation	27
PHASE 8: Engine/Generator Operation	29
Teardown Procedure of the Hybrid 1200 Unit	31
PHASE 1: Deactivate Auto-start Mode	31
PHASE 2: Stow Solar Panel Array	31
PHASE 3: Retract and Stow Tower Mast	32
PHASE 4: Stow Outriggers	32
PHASE 5: Disconnect Earth Ground	33
Towing the Hybrid 1200 Unit	33
Daily Inspection	34
Hybrid 1200 Light Tower Schematics	35
Main Power Diagram	35
Toggle Switch Diagram	35
Main Control Panel Diagram	36
Light Contact Control Diagram	37
Hydraulic Toggle Switch Diagram	37
Generator Control Diagram	38
Iota Wiring Diagram	39
Samlex Wiring Diagram	40
Troubleshooting	41



GENERAL SYSTEMS INFORMATION

NOTICE!

The following section contains important information on System Specifications, System Controls, and the Tire Placard of the Hybrid 1200 unit. Please refer to this section for specifications on individual systems of Hybrid 1200 unit, when servicing and/or ordering replacement parts for the unit, and as a guide during setup and operation of the unit.

Systems Specifications

TRAILER	
Number of Axles	2
Type	Solid
Capacity–Axle Rating	3500 lbs (1587.6 kg)
Tire Model	ST225/75R15
Cold Inflate Tire Pressure	60 psi (275.8 kPA)
DIMENSIONS	
Length (mast stowed)	166 in. (421.6 cm)
Length (solar panel deployed)	205 in. (520.7 cm)
Width	90 in. (228.6 cm)
Width (outriggers deployed)	121 in. (307.3)
Height (mast stowed)	79 in. (200.7 cm)
Height (mast deployed)	21 ft. (6.4 m)
Weight	3,840 lbs (1741.8 kg)
SOLAR PANEL	
Open-Circuit Voltage (Voc)	44.90VDC
Optimum Operating Voltage (Vmp)	36.4VDC
Short-Circuit Current (Isc)	8.63A
Optimum Operating Current (Imp)	8.11A
Maximum Power at STC (Pmax)	295W
Operating Temperature	-40°C to +85°C
Maximum System Voltage	1000VDC (IEC) / 600VDC (UL)
Maximum Series Fuse Rating	15A
Power Tolerance	±5%
Solar Cell	Mono/Poly crystalline 125 x 125 mm (5 in.)
No. of Cells	72 (6 x 12)
Dimensions	1854 x 982 x 40mm (76.93 x 38.7 x 1.53 in.)
Front Glass	3.2 mm (0.13in.) tempered glass
Frame	Anodized aluminum alloy

SOLAR PANEL (Cont'd)

Junction box	IP67 rated
Output Cables	H+S RADOX@SMART cable 4.0mm ² (.0006in. ²) Symmetrical length (-) 1000mm (39.4in.) and +1000mm (39.4in.), RADOX@SOLAR integrated twist locking connectors or MC4 connectors
Nominal Operating Cell Temperature (NOCT)	45±2°C
Temperature Coefficient of Pmax	-0.48 %/°C
Temperature Coefficient of Voc	-0.34 %/°C
Temperature Coefficient of Isc	0.037 %/°C

BATTERY

Weight	79 lbs (36 kg)
Cells	3
Volts	6 VDC
Capacity (C / 20)	260 Ah (BATTERY PN-6MLCEA260)
Internal Resistance	1.9 mOhms
Short Circuit (68°F / 20°C)	3700 A
Operating Temperature	-40° F (-40° C) to 140° F (60° C)
Self Discharge	<3 % of capacity @ 68°F / 20°C
Standard Charge	14°F/-10°C to 122°F/50°C
Standard Discharge	-4°F/-20°C to 122°F/50°C
Maximum Discharge	-40°F/-40°C to 140°F/60°C

® classified as "NON-SPILLABLE BATTERY" Not restricted for Air (IATA/IOAO) Provision 67, Surface (DOT-CFR-HMR49) Or Water (Classified as non-hazardous per INDG amendment 27) transportation Quality processes with ISO (4400/992579), QS Certification EMC tested, CE, ETTS Germany (G4M19906-9202-E-16) UL recognized and approved components (MH29050).

OMS LAW FORMULA

Mobi30 LED (14,790 lm) 6.25 amp draw (150 w)

Mobi60 LED (29,580 lm) 12.5 amp draw (300 w)

Figures depend on age of batteries

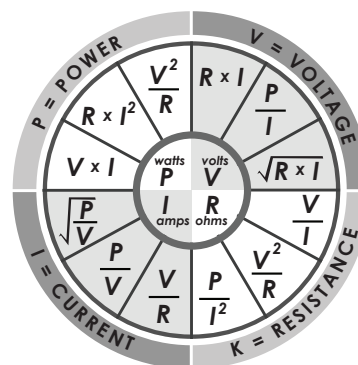

ENGINE

Type	Vertical, water-cooled, 4-cycle diesel engine
Number of Cylinders	4
Bore and Stroke	78 x 78.4 mm (3.07 x 3.09 in.)

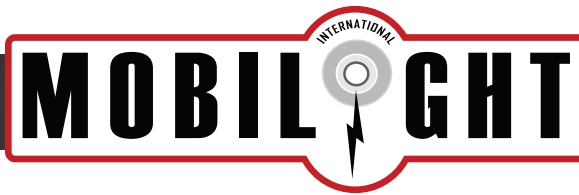

ENGINE (Cont'd)

Total Displacement	1498 cm ³ (91.41 in. ³)
Combustion Chamber	Spherical Type (E-TVCS)
SAE Continuous H.P. (SAEJ1349)	13.4 kW @ 1800 rpm (18 HP @ 1800 rpm)
SAE Stand-by H.P. (SAEJ1349)	15.1 kW @ 1800 rpm (20.2 kW @ 1800 rpm)
Fuel Type	Diesel Fuel No. 2-D (ASTM D975)
Dimension (L x W x H)	634.3 x 396 x 602 mm (25.0 x 15.6 x 23.7 in.)
Dry Weight	127 kg. (280 lb.)
Starting System	Cell Starter (with glow plug)
Starting Motor	12 V, 1.2 kW

LIGHTING

Type	LED
Number of Modules	4
Nominal Voltage	24 VDC
Power	150 W per module
Lumen Output	14,790 lm (per fixture)
Connector	Integrated Deutsch with Plug-and-Play Harness
Housing	Die-cast Aluminum
Lens	Polycarbonate
Vibration Rating	15.6Grms
IP Rating	IP-68
Operating Temperatures	-40° F (-40° C) to 176° F (80° C)
LED Lifespan	50,000 hours

SOLAR CHARGE CONTROLLER

Type	MPPT
Operating Voltage	150VDC
Max Hyper VOC	150 + battery voltage
Battery Charge Volts*	12-93 VDC
Absolute Current Output @ 25°C (77°F)**	94 A at 24 V
De-rate current @ 40° C+ (104°F)	80 A
Temperature Range	-40° F (-40° C) to 104° F (40° C)

*NOTE: Current output ratings were measured with 75% array's VOC (Open Circuit Voltage)

*NOTE: Calculated by adding battery voltage to maximum input operating voltage (48V battery max)

**NOTE: Measurement Accuracies ± 0.12 V, offset calibration adjustment may be necessary

HYDRAULIC SYSTEM

Operating Voltage (motor)	12 VDC/24 V
Pump Displacement	0.125 in ³ / rev (2.13 cm ³ / rev)
Reservoir Capacity (usable)	75.67 in ³ (1.24 l)
Recommended Hydraulic Fluid	ATF Dexron II or equal
Operating Temperature Range	-20° F (-29° C) to 130° F (54° C)

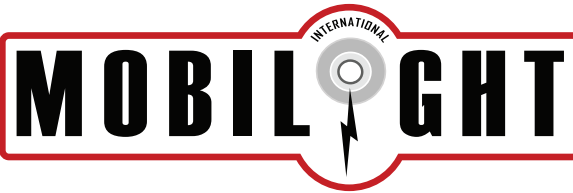

AC CHARGER

Weight	12.1 lb (5.5kg)
Dimensions (L x W x H)	382 x 230 x 108 mm
Nominal Input Voltage (Factory Preset)	120 VAC
International Present	230 VAC
Input Voltage Frequency (auto-ranging)	50-60 Hz
Input Current (@ 120VAC)	17.2 A
Input Current (@ 230VAC)	8.7 A
Output Voltage (Absorption/Boost)	28V/28.8V +/- 0.05V
Output Voltage (Float/Maintenance)	27V +/- 0.05V
Max Bulk Charging Current (Normal Operation)	40A
Max Bulk Charging Current (Half Power Mode)	20A +/- 1A
Cooling	Forced Convection
Overload Protection	Yes
Short Circuit Protection	Yes
Reverse Polarity Protection	Yes
Thermal Overload Protection	Yes
Operating Temperature Range	32° F (0° C) to 104° F(40° C)
120VAC Input Circuit Protection (6mm x 30mm; Slow Blow Fuse)	20 A / 250 V
230VAC Input Circuit Protection (6mm x 30mm; Slow Blow Fuse)	10 A / 250 V

CONTROL COMPARTMENT HEATER (Optional)

Fuel Type	Diesel
Operating Voltage	12 VDC
Heat Output	Boost: 7,500 BTU / hr (2.2 kW) High: 6,500 BTU / hr (1.8 kW) Med: 4,100 BTU / hr (1.2 kW) Low: 2,900 BTU / hr (0.85 kW)
Fuel Consumption	Boost: 0.07 U.S. gal / hr (0.28 l / hr) High: 0.06 U.S. gal / hr (0.23 l / hr) Med: 0.04 U.S. gal / hr (0.15 l / hr) Low: 0.02 U.S. gal / hr (0.10 l / hr)
Electrical Consumption	Boost: 2.8 A High: 1.8 A Med: 1.0 A Low: 0.67 A
Weight	5.9 lbs. (2.7 kg)

*Mobilight International reserves the right to change specifications without notice.

Control Panel Layout A

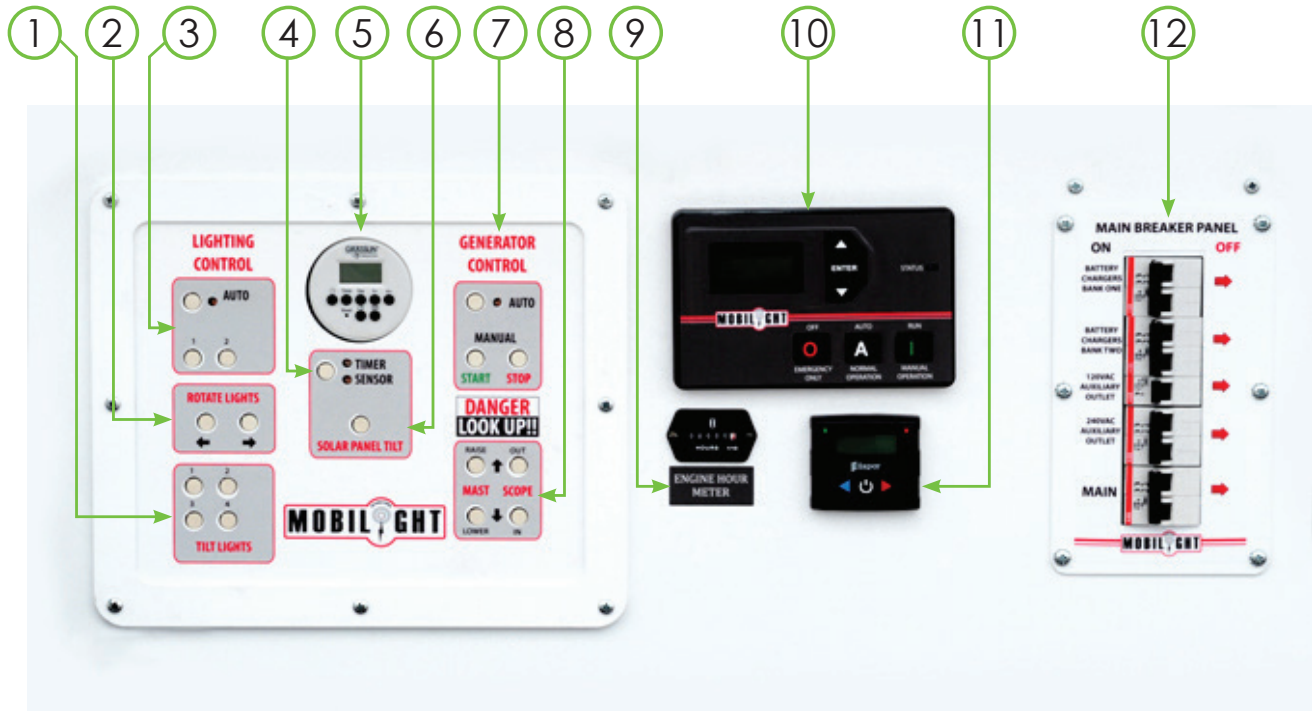

Figure 1: Control Panel A of the Hybrid 1200 unit

- 1. Light Tilt Switches:** (4) Push-button switches for tilt of each LED module, press to tilt down, release and press to tilt up.
- 2. Light Rotation Switches:** Push-button switches for synchronized rotation (1) clockwise and (1) counterclockwise of the bottom tier of LED modules.
- 3. Lighting Control Switches:** (1) Push-button switch toggles between AUTO/MANUAL and (2) push-button switches toggle between Manual ON/OFF for Tier 1 and Tier 2 LED modules.
- 4. Lighting Auto-control Switch:** (1) Push-button switch toggles between SENSOR/TIMER. LED indicator lights illuminate to indicate which type of control is active.
- 5. Programmable Timer:** 24/7 Digital Programmable Timer (see provided product literature for complete details).
- 6. Solar Panel Array Tilt Switch:** (1) Push-button switch, press to decrease angle, release and press to increase angle.
- 7. Generator Control Switches:** (1) Push-button switch toggles between AUTO/MANUAL setting and (2) push-button switches for manual START and STOP. NOTE: UNITS MANUFACTURED AFTER JULY 2013 WILL NO LONGER USE THE GENERATOR CONTROL SWITCHES. ALL CONTROL OF THE ENGINE AND GENERATOR WILL VIA THE GENERATOR AUTO-RUN CONTROLLER.
- 8. Mast Control Switches:** Push-button switches for (1) RAISE, (1) LOWER, (1) EXTEND and (1) RETRACT.
- 9. Engine Hour Meter:** Counts hours of run for the engine only.
- 10. Generator Auto-run Controller:** Runtime, Start Temp, Start Volts, Clock, Quit Time adjustment knobs and LED status indicators (see pages 29 and 30 for complete details).
- 11. Control Compartment Heater Controller (Optional Item):** NOTE: Some controllers are equipped with a Runtime Counter, for instruction on disabling the counter, see page 19.
- 12. Breaker Panel:** See page 11 for complete details.

Control Panel Layout B

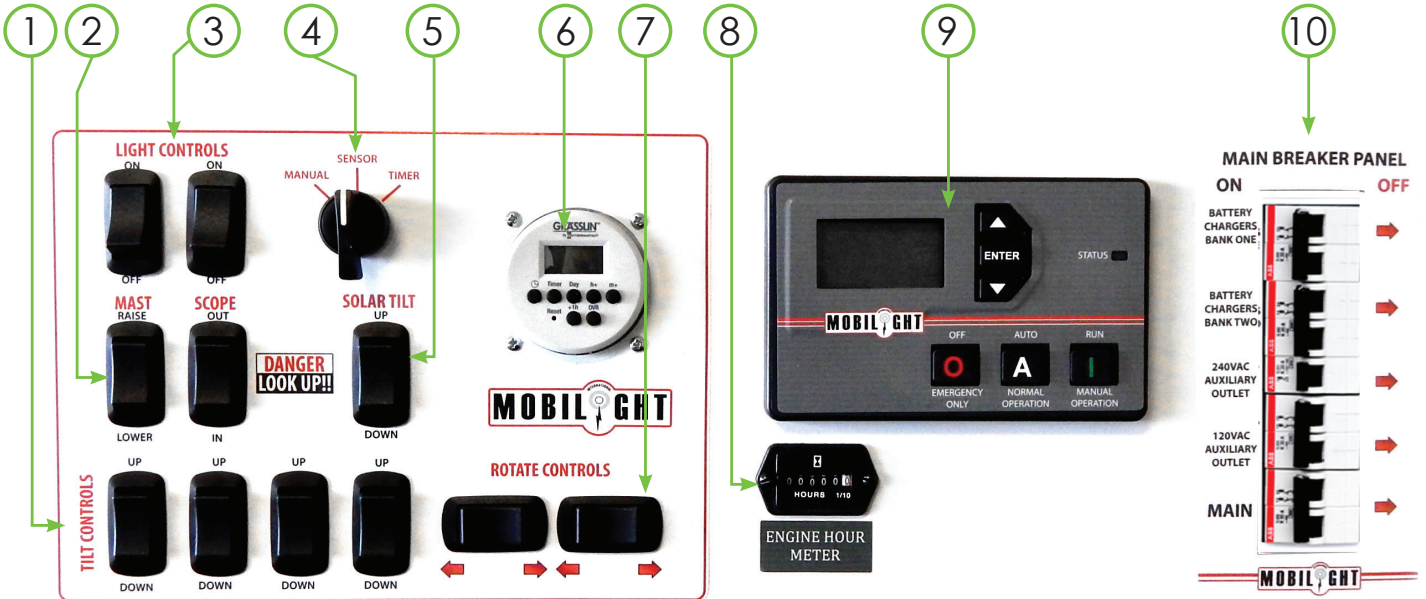

Figure 1b: Control Panel B of the Hybrid 1200 unit

1. **Light Tilt Switches:** (4) Push-button switches for tilt of each LED module.
2. **Mast/Scope Control:**
SETUP: First raise mast, then extend scope out.
TAKE DOWN: First retract scope, then lower mast.
3. **Lighting Control Switches:** When lighting control switch is on manual, press toggle "on," or "off."
4. **Lighting Control Option:** MANUAL, SENSOR, and TIMER.
MANUAL: Manually turn lights on or off.
SENSOR: Lights are automatically controlled by photocell.
TIMER: Lights turn on and off according to user programmed day and time.
5. **Solar Panel Array Tilt Switch:** Press to toggle up or down.
6. **Programmable Timer:** 24/7 Digital Programmable Timer (see provided product literature for complete details).
7. **Rotate LED Switches:** Push toggle switches according to arrows for right or left.
8. **Engine Hour Meter:** Counts hours of run for the engine only.
9. **Generator Controller:** OFF, AUTO, and RUN (see pages 29 and 30 for complete details).
10. **Breaker Panel:** See page 11 for complete details.

Generator Auto-Run Controller

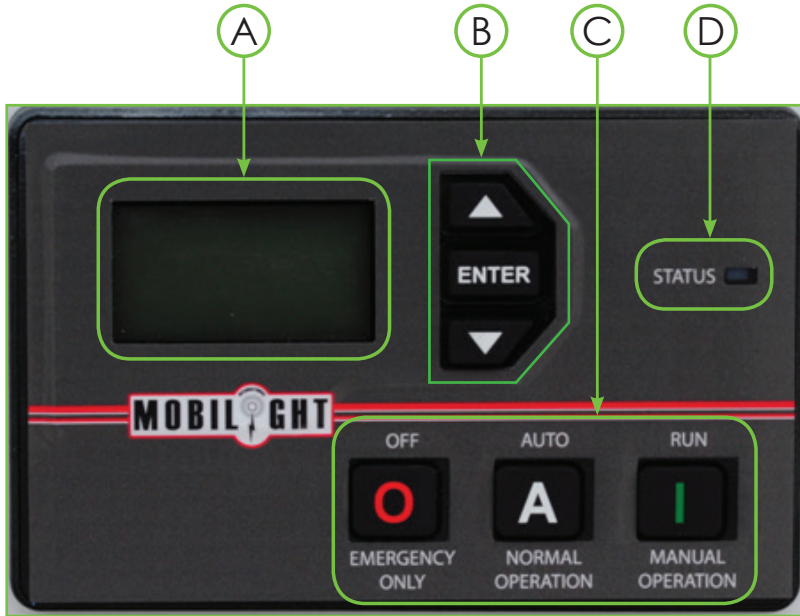
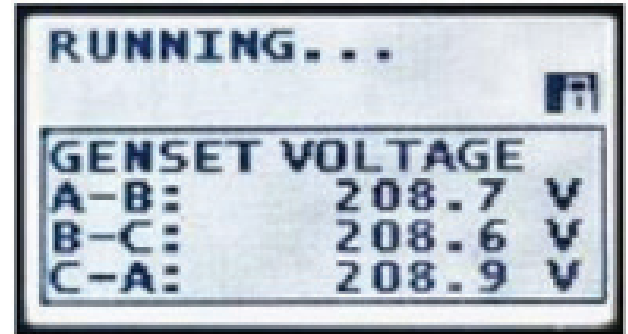

Figure 2: Generator Auto-start Controller

A. LCD Screen

The LCD Screen is the main source of providing information to an operator. From the LCD Screen you can view and navigate the status, engine parameters, settings, and time.



Warnings and failures will appear on the LCD Screen and will be logged into the Events History of the controller.



Example Only

B. Navigation Buttons

The Navigation Buttons are used to move throughout the menu system, change settings and view parameters on the LCD Screen

SYMBOL	FUNCTION	DESCRIPTION
	Up	Used for moving around in the menu, changing a settings value, or changing the currently displayed parameter page.
	Enter	Used for entering the menu system, accepting settings, or locking the LCD screen when viewing parameters.
	Down	Used for moving around in the menu, changing a settings value, or changing the currently displayed parameter page.



C. LED INDICATORS

The LED indicators are used to display the current status of the system. Different versions of the Generator Auto-run Controllers have different LED combinations therefore some symbols may not appear on your controller. The following table shows the meanings of each symbol and LED color.

SYMBOL	FUNCTION	LED STATUS	DESCRIPTION
	Generator Status	Solid Green	Engine Running
		Solid Amber	Warning
		Solid Red	Failure

D. FUNCTIONAL BUTTONS

The following table describes the function of the Functional Buttons. Keep in mind that some buttons may have multiple purposes depending on the status of the controller.

SYMBOL	FUNCTION	DESCRIPTION
	Off	Used for turning off the engine or exiting out of AUTO mode. All automatic methods of starting the engine are disabled.
	Auto	Places the controller in AUTO mode which allows it to start or stop based on conditions (Exerciser, Low Battery Recharge, Failure, Remote Start).
	Run	Starts the engine manually and will continue to run until the off button is pressed, emergency stop input is activated, or a failure occurs.

AC Power Distribution Breaker Panel

The Hybrid 1200 unit is equipped with an AC power distribution breaker panel. The breaker panel is accessed through the control compartment door. The breaker labels and numbering correspond with the list below.

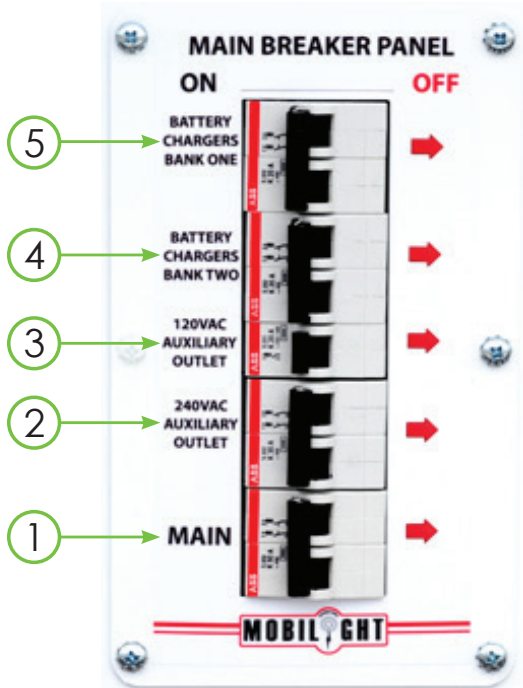

- 1. MAIN:** Double Pole, 50 amp, 240 volt
- 2. BANK ONE BATTERY CHARGER:** Double Pole, 20 amp, 120 volt
- 3. BANK TWO BATTERY CHARGER:** Double Pole, 20 amp, 120 volt
- 4. 120V AUX OUTLET:** Single Pole, 20 amp, 120 volt
- 5. 240V AUX OUTLET:** Double Pole, 30 amp, 240 volt

Figure 3: AC Power Distribution Circuit Breaker Panel

Tire Placard

Refer to Figure 4 for the location of Tire Placard. The vehicle identification number (V.I.N.) and other important information can be found on these tags. Record the information and keep it on file in a safe place in case the tags become damaged or lost. It may be required to provide this information when ordering parts or requesting technical service information.



Figure 4: Tire Placard is located at the front of the unit at the bottom of the mast.

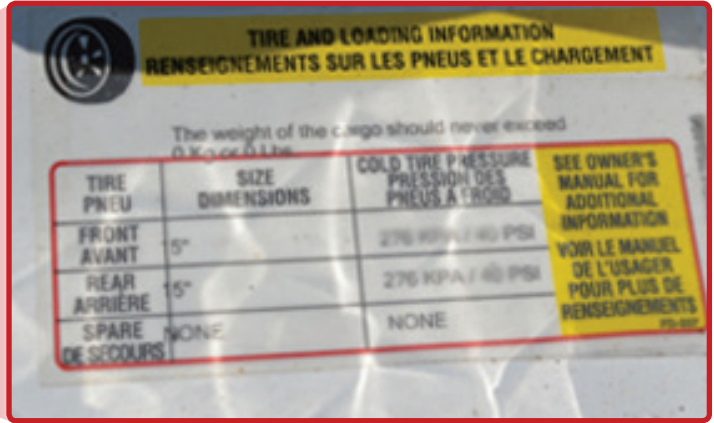

Figure 5: Tire Placard

Thermostat Programming

To enter the Setup/Maintenance/Diagnostics mode, press and hold the left arrow key while connecting power to the module (the 12V disconnect can be used to disconnect and reconnect power).

Once in the Setup Menu, follow the steps below.

SET-UP/DIAGNOSTIC MODE continuation...



SET-UP/DIAGNOSTIC MODE

Controller checks the diagnostic line and displays "DIAG line OK" or "CHECK DIAG line!". If diagnostic line is not OK, diagnostic feature is disabled.

If diagnostic is option selected, fault codes are displayed for 10 seconds, then a prompt for erasing codes appears. If erase option is selected, fault codes will be erased and diagnostic menu appears again, so the codes may be read again or diagnostic skipped.

↓
 RUNTIME: 0:00
 N <CLEAR HRS?> Y



CONFIRM RESET?
 Y <CLEAR HRS?> N

Runtime counter value is saved in memory (power independent). If the value is not equal to zero, an option to reset the runtime is displayed, a confirmation message is displayed if you choose to clear the run time. If the left button (Y) is pressed, counter resets and "0:00" is displayed.

↓
 MAINTENANCE PERD
 500 1000 2000



MAINTENANCE PERD
 EVERY 1000 HOURS

Confirm runtime hours for maintenance period. Selecting one of the buttons (left, middle and right) will confirm the selection (e.g. right – 2000 hrs). Default value is 1000 hrs.

↓
 VOLTAGE 12755 mV
 12V settings

Digi-Max measures system voltage and presets for 12 or 24 Volt systems. (if measured voltage exceeds 16 Volts, then 24 Volt system is assumed).

↓
 UNDERVOLT SHTDWN
 11.4 12 12.2



UNDERVOLT SHTDWN
 12.00 SELECTED

Menu for selecting under voltage shutdown thresholds is displayed. Selecting one of the buttons (left, middle and right) will confirm the selection (e.g. right – 12.2). Default value is 12V.

↓
 MAX RUNTIME HRS.
 LESS 10 MORE



MAX RUNTIME HRS.
 10 HRS. SELECTED

Maximum runtime value can be adjusted by pressing left button (decrease the value by 1) or the right button (increase the value by 1). Default value is 10 hrs. Values are from 1 to 24 hrs – less than 1 or above 24 will change runtime into UNLIMITED (continuous).

↓
 Fahren or Cels?
 F C



Fahren or Cels?
 Fahrenheit

Controller displays "Fahren or Celsius?" message allowing choosing US or Metric options with left and right buttons respectively. If no selection is made, default will be Fahrenheit.

↓
 READY

Once the settings are done, the configurations are then saved in the DIGI-MAX D1000 memory and the message "READY" is displayed for a brief period and the controller enters IDLE mode.

↓
 HEATER STOPPED
 TEMP SET: 69F

Idle mode – controller ready for operation.

If no selection is made, the default settings are applied.

SETUP PROCEDURE

	<p>The following section details the setup of the Hybrid 1200 unit. Please adhere to all of the recommended operational and safety procedures and practices to ensure the safety of the operator and those in the immediate vicinity, and to prevent property damage.</p>
	<p>ELECTRICAL SHOCK HAZARD: Mobilight International strongly recommends that a trained and licensed professional perform all electrical, wiring, and testing procedures. All wiring must be in accordance with the United States National Electric Code (NEC), state and local codes and Occupational Safety and Health Association (OSHA) guidelines.</p>
	<p>DO NOT MODIFY or use the equipment for any application other than which it was designed.</p>
	<p>Please read and understand the following section prior to operating the Hybrid 1200 unit. If at any time there is an uncertainty pertaining to the operation of the unit that cannot be resolved with this manual, please contact your authorized Mobilight International Dealer.</p>

PHASE 1: Position the Unit

	<p>Standard tower extends up to 21 ft. (6.4 m). Make sure the area above the unit is clear of any overhead obstructions such as trees, equipment, and power transmission wires.</p>
	<p>If the Hybrid 1200 unit is deployed North of the equator then the system's solar array must be positioned to face due South; if deployed South of the equator, the solar array must face due North.</p>
	<p>Solar panel array must have an unobstructed path to the sun when deployed. Shadows cast onto the panel array surface from buildings, trees, or equipment will cause a significant reduction in solar energy collection.</p>

STEP 1: Position the unit on a level surface.

The ideal position for the Hybrid 1200 is on a level surface above the area that is being illuminated (see Figure 6). It is necessary for the solar panel array to face due South (Northern Hemisphere).



Figure 6: Hybrid 1200 ready for deployment.

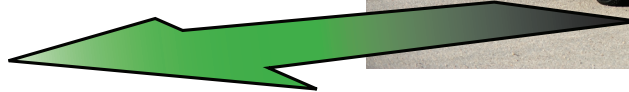

Northern Hemisphere: South Facing
 Southern Hemisphere: North Facing

STEP 2: *Secure the unit.*

The Hybrid 1200 is equipped with a manual handbrake. The Parking Handbrake is located on the trailer tongue. Pull the handle of the handbrake towards the unit to engage the parking brake (see Figure 7).

Figure 7: Parking Handbrake in the engaged position

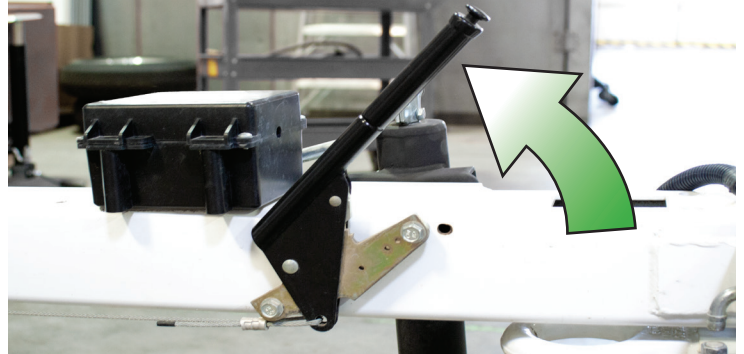

STEP 3: *Unhitch the unit from the towing vehicle.*

Pull the locking-pin on Tongue Jack-Stand and rotate 90° until foot-base is facing the ground. Release the locking-pin to lock the jack-stand in the vertical position (see Figure 8). Turn the jack handle clockwise to raise the trailer tongue off of the towing vehicle.

Figure 8: Tongue Jack-stand in the deployed position

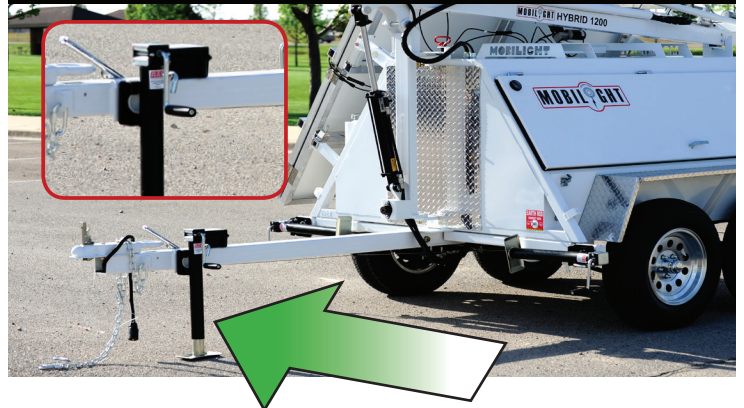

PHASE 2: Deploy Outriggers



The trailer must be level with the outriggers deployed before raising the tower mast or deploying the solar array. The outriggers must remain extended while the tower mast is raised and the solar array is deployed. Failure to level the trailer and/or extend the outriggers will severely reduce the stability of the unit.

When outriggers are deployed, they may become a tripping hazard. Pay particular attention to their location during setup and teardown.

STEP 1: Deploy the outriggers and jack stands.

Release the locking-pin on the outrigger sleeve by pulling down (see Figure 9). Extend the outrigger arm outwards until it locks into place, pull the jackstand locking-pin and rotate the jackstand 90°, turn the jackstand handle clock-wise until the foot makes contact with the ground (see Figure 10).

Figure 9: Outrigger Sleeve Locking Pin



Figure 10: : Outrigger Arm Extended & Jack Stand Deployed



STEP 2: Level and stabilize the unit.

Once all four (4) outriggers have been deployed, return to each of the jack-stands and extend the feet downwards to level the trailer.

NOTE:

The tongue jack may also be used to assist with leveling and stabilization

Figure 11: Hybrid 1200 with Outriggers Deployed



PHASE 3: Establish Earth Ground



Ensure no underground utilities are located where grounding rods will be placed.

Always connect grounding wire prior to operation. Ensure the grounding system is in accordance with the United States National Electric Code (NEC), state and local codes, and Occupational Safety and Health Association (OSHA) guidelines prior to operation.

ELECTRICAL SHOCK HAZARD: Mobilight International strongly recommends that a trained and licensed professional perform all electrical, wiring, and testing functions. All wiring must be in accordance with the United States National Electric Code (NEC), state and local codes, and Occupational Safety and Health Association (OSHA) guidelines.

STEP 1: Locate the Grounding Rod terminal.

The Earth Rod terminal is located on the left-front panel of the Hybrid 1200 unit (see Figure 12) and is used to electrically ground the unit.

STEP 2: Remove the wing nut from the grounding terminal, place the grounding conductor (prepared with eyelet) onto the terminal post.

STEP 3: Tighten the wing nut onto the grounding terminal post until the conductor is securely fastened.

STEP 4: Connect the free end of the grounding cable to the appropriate grounding rod or grounding grid.

Figure 12: Grounding Rod Terminal on the left-front of unit



Figure 13: Grounding Terminal

PHASE 4: Raise and Extend Tower Mast

	Standard mast extends up 21 ft. (6.4 m). Ensure the area above the unit is clear of any overhead obstructions such as trees, equipment, and power transmission wires.
	Always keep the immediate area clear of people while deploying, stowing, extending and retracting the Hybrid 1200 tower mast.
	The trailer must be level with the outriggers deployed before raising the tower mast. The outriggers must remain extended while the tower mast is deployed. Failure to level the trailer or extend the outriggers will severely reduce the stability of the unit.
	Always fully deploy mast BEFORE deploying solar array.

STEP 1: Turn the Main Battery Disconnect ON. The Hybrid 1200 is equipped with a lockable battery disconnect switch that can be used to disconnect power to the engine and hydraulic system. The disconnect switch is located on the front left side of the unit, below the control compartment door (see Figure 14). Before the mast can be deployed, the Main Battery Disconnect must be switched to the ON position (see Figure 15).

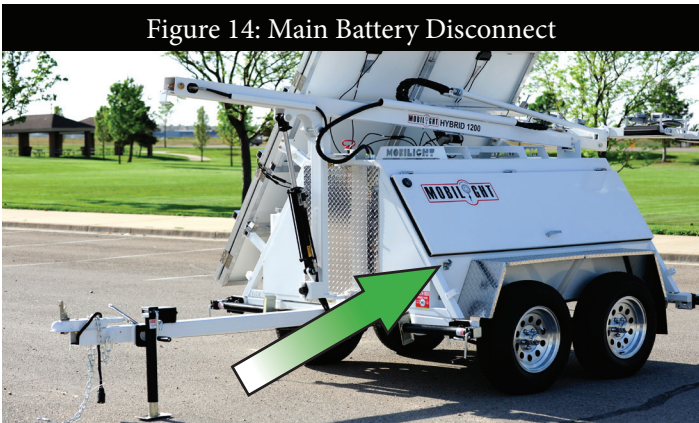

Figure 14: Main Battery Disconnect



Figure 15: Main Battery Disconnect in the OFF position

STEP 2: Locate the Control Panel. The Hybrid 1200 is equipped with a hydraulic mast. The hydraulic mast is controlled from the Control Panel located inside the control compartment (see Figure 16).

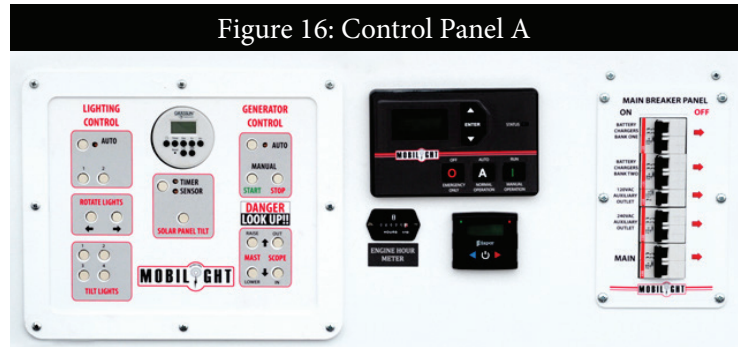

Figure 16: Control Panel A

STEP 3: Locate the Mast Control Switches in the lower-right corner of the Control Panel (see Figure 17).

The left (2) push-button switches control the raising and lowering of the mast. The right (2) push-button switches control the scope, or extension and retraction of the mast.

STEP 4: Raise and Extend the mast.

Press and hold the top-left button labeled “RAISE” to lift the mast to its fully upright position. Press and hold the Scope “OUT” button to extend the mast to the desired height

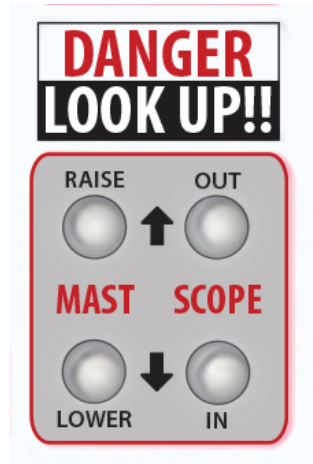

Figure 17:
Mast Control Switches

STEP 5: Ensure that the Mast Extension Lock is enabled.

The Hybrid 1200 is equipped with a mechanical locking mechanism (spring-loaded ‘J’ hook) that is automatically engaged upon extension of the mast. The Mast Extension Lock is located at the bottom of the mast, while upright (see Figure 18). Be sure the lock is engaged once the mast has been extended (see Figure 20).



Figure 18: Mast Extension Lock located at the base of the mast while upright.

Figure 19: Mast Extension Lock in the “unlocked” position

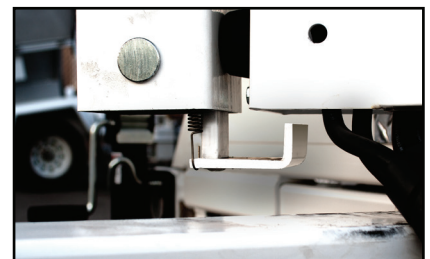
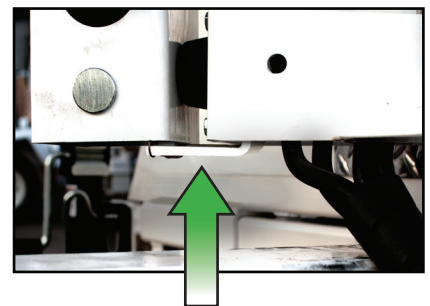

Figure 20: Mast Extension Lock in the “locked” position



PHASE 5: Deploy Solar Panel Array



ELECTRICAL SHOCK HAZARD: Do not attempt to operate or service the unit if the insulation on the electrical cords from the solar panels is cut, worn or showing any signs of damage. Bare wires in contact with solar panel frame or trailer may energize the unit and could cause electrocution! **STOP IMMEDIATELY** and contact your Authorized Mobilight International Dealer.

The Hybrid 1200 is equipped with a twelve hundred (1200) watt solar array and a state-of-the-art Maximum Power Point Tracking (MPPT) solar charge controller. To enable solar collection the solar array must be fully opened, directed appropriately (please refer to **Phase 1: Positioning the Unit** pg. 14), and tilted at the correct angle to maximize solar gain. The Solar Panel Disconnect Switch must be in the ON position, the solar charge controller must be in SOLAR mode, and the

STEP 1: Release the Solar Panel Array Locking Pins.

The solar array is held closed by two spring-loaded pins located at the bottom-center of the array (see Figure 21). Pull the pins down to release.

(older models may be equipped with a latch in the middle of the frame.)

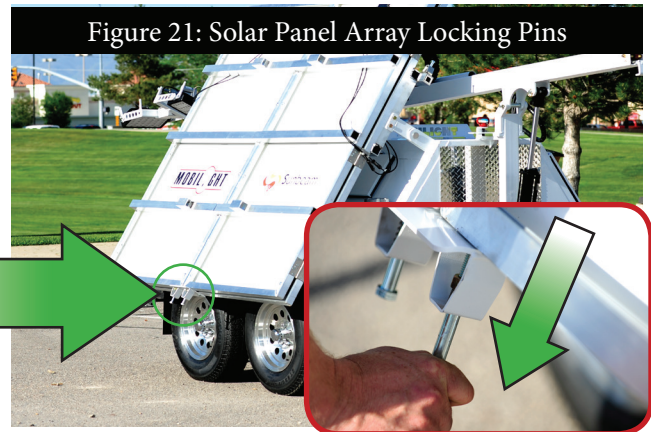

Figure 21: Solar Panel Array Locking Pins

STEP 2: Place the Solar Panel Array Support Arms in their deployed position.

The Panel Array Support Arms are located on the rear of the solar array. Pull the pin upward to release the arm (see Figure 24). Extend the arm completely until it locks into place (see Figure 25). Both sides of the array are equipped with an upper and lower support arm (see Figure 25), be sure to deploy all (4) four arms.

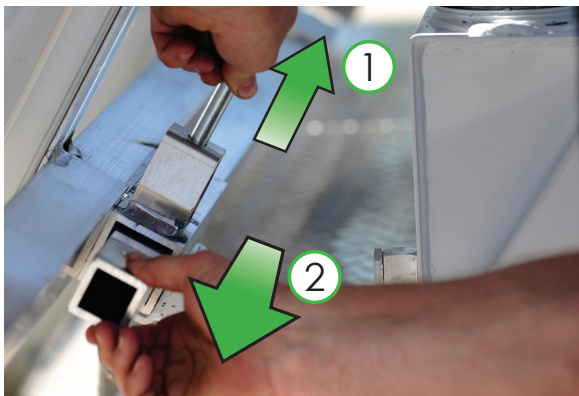

Figure 24: Support Arm in Stowed Position



Figure 25: Support Arm in Deployed Position

Adjusting the Solar Panel Array Angle



The Solar Panel Array will experience interference with the mast when the Solar Tilt is fully raised. Please use caution when adjusting the array.

The Hybrid 1200 unit is equipped with an electric Solar Panel Array Tilt System. The array tilt is controlled via the Solar Tilt Switch located on the Control Panel.

STEP 1: Locate the Control Panel found inside the control compartment.

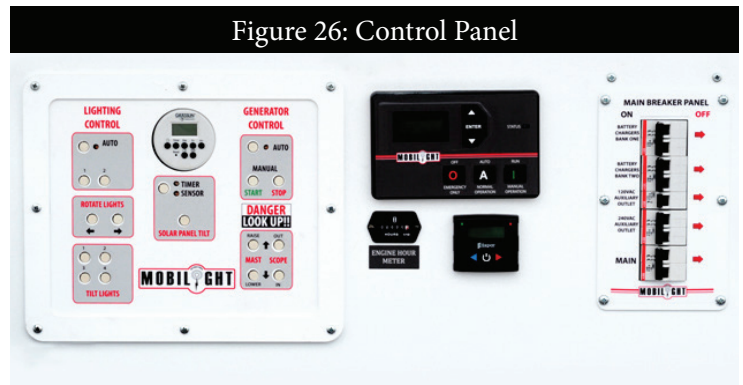

Figure 26: Control Panel

STEP 2: Adjust the angle of the solar array.

The solar array angle is adjusted via the push-button labeled “SOLAR PANEL TILT”, located in the center of the Control Panel (see Figure 27). To adjust the array, press and hold the button to decrease the angle. To increase the angle of the solar array, simply release the button and press again, the panel will now travel in the opposite direction.

NOTICE!

Pay careful attention to the top side of the solar array when approaching the minimum angle of inclination as it will come in contact with the mast.

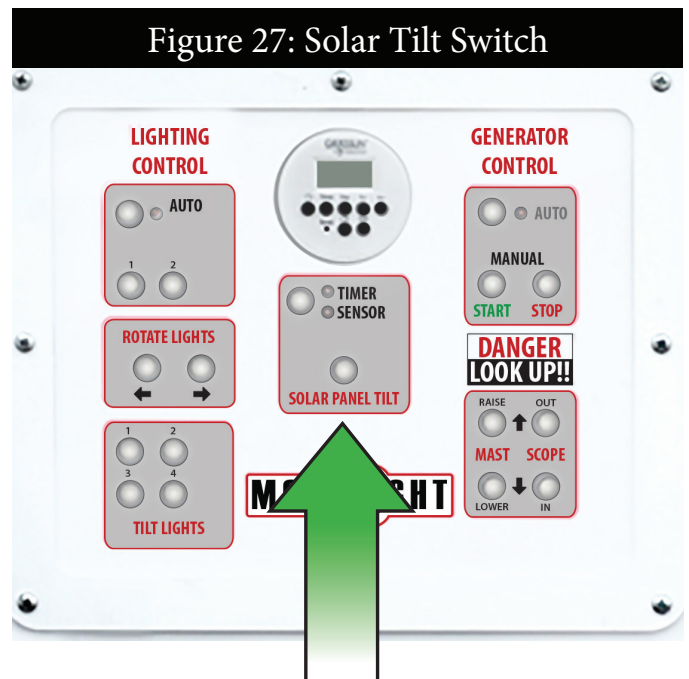

Figure 27: Solar Tilt Switch

Enable Solar Charging

The Hybrid 1200 is equipped with a MPPT solar charge controller. The controller can be disconnected from the battery banks via the Solar Disconnect located adjacent to the solar charge controller (see Figure 28 and Figure 29). Current models now have two Disconnect Switch Sections; 1. Disconnects the Solar. 2. Master Disconnect Switch for the rest of the Unit.

To enable solar charging:

STEP 1: Connect the solar charge controller to the battery bank.

Rotate the Solar Disconnect (see Figure 29) switch clockwise to the ON position to connect the charge controller to the battery bank.



Midnite
Controller



Morningstar
Controller

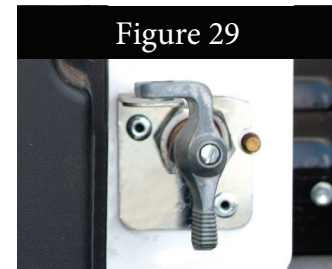

MIDNIGHT CONTROLLER OPTION

STEP 2: Ensure the charge controller is set to "Solar" mode.

To select the mode the controller will run in, follow the steps below.

Step 1: Push the Main Menu button.

Step 2: Scroll left or right until Mode is highlighted and then push the Enter button.

Step 3: Scroll to the right and highlight the current Mode, then use the up and down arrows to set the mode you want.

Step 4: Take note of the Right soft key, most modes have some set points that can be adjusted.

Step 5: Press the Main Menu button until you get back to the Mode Menu.

Step 6: Set the ON/OFF to ON and press Enter.

STEP 3: Ensure the mode is turned ON.

The charge controller used in the Hybrid 1200 is unique; it has multiple charging algorithms for just about any DC input.

Because it supports such a wide variety of DC inputs we have also added a software "ON" and "OFF" feature.

This software “Switch” turns the relay off, effectively disconnecting the input source so the controller will not charge the battery.

If you see “Mode is Off” in the bottom right corner of the display, then the Mode may have been turned off. To turn the mode back “ON” push the Main Menu button several times until “Wizard” is highlighted. Scroll to the right until “Mode” is highlighted and press “Enter”. On this screen “OFF” should be highlighted use the up or down arrow to change it to “ON” and press “Enter”. Press the Status button once to return to the main status screen.

Please refer to the included DC Solar Charge Controller Manual for additional information.

MORNINGSTAR CONTROLLER OPTION

STEP 2: Ensure the charge controller is set to “Solar” mode.

- Step 1:** With the wiring box cover removed, locate the settings switches.
- Step 2:** Set switches accordingly to enable solar charging.
(see diagram pg. 24)
- Step 3:** Replace and secure the wiring box cover.



Morningstar Charger with Wiring Box Cover Removed.

SWITCH SETTINGS

Switch 1: Reserved for Future Use

Settings switch 1 should remain in the “OFF” position.

Switches 2 & 3: System Voltage

The “auto” setting allows the TriStar MPPT 150V to detect the system voltage automatically on start up. The test is only performed at start up and the detected system voltage will never change during operation. Generally, it is best to choose a specific system voltage. The auto detect feature should only be used in situations where the system voltage is unknown ahead of time or in systems where the system voltage may change periodically.

Switches 4, 5, & 6: Battery Charging Settings

It is important to select the battery type that matches the system battery to ensure proper charging and long battery life. Refer to the specifications provided by the battery manufacturer and choose a setting that best fits the recommended charging profile. All settings are for 12 Volt nominal systems. Multiply the charge voltage settings by 2 for 24 Volt systems or by 4 for 48 Volt systems. A description of each setting is provided below. See manufacturer manual for full details on battery charging and a description of each of the settings in the battery charging table.

Battery Type - The most common battery type associated with the specified charging settings.

RECOMMENDED SETTINGS

MODE	SWITCH 1		DIP SWITCHES								EQUALIZE		SWITCH 7	
SOLAR CHARGING	OFF		ON 1	2	3	4	5	6	7	DIP 8	MANUAL	OFF		
FUTURE USE	ON										AUTOMATIC	ON		
SYSTEM VOLTAGE	2	3											CONFIGURATION VIA TCP/IP	SWITCH 8
AUTO	OFF	OFF											AUTO	OFF
12V	OFF	ON											12V	ON
24V	ON	OFF												
48V	ON	ON												

BATTERY TYPE	Absorp. Stage (Volts)	Float Stage (Volts)	Equalize Stage (Volts)	Equalize Interval (Days)	4	5	6
1- GEL	14.00	13.70			OFF	OFF	OFF
2- SEALED*	14.15	13.70	14.40	28	OFF	OFF	ON
3- SEALED*	14.30	13.70	14.60	28	OFF	ON	OFF
4- AGM/Flooded	14.40	13.70	15.10	28	OFF	ON	ON
5- FLOODED	14.60	13.50	15.30	28	ON	OFF	OFF
6- FLOODED	14.70	13.50	15.40	28	ON	OFF	ON
7- L-16	15.40	13.40	16.00	14	ON	ON	OFF
8- CUSTOM	CUSTOM	CUSTOM	CUSTOM	CUSTOM	ON	ON	ON

* "Sealed" battery type includes gel and AGM batteries

Absorption Stage - This stage limits input current so that the Absorption voltage is maintained. As the battery becomes more charged, the charging current continues to taper down until the battery is fully charged.

Float Stage - When the battery is fully charged, the charging voltage will be reduced to the Float voltage setting.

Equalize Stage - During an equalization cycle, the charging voltage will be held constant at the specified voltage setting.

Equalize Interval - The number of days between equalization charges when the controller is configured for automatic equalizations (settings switch 7).

Switch 7: Battery Equalization

Choose between manual and automatic battery equalization charging. In the manual equalization setting, an equalization will only occur when manually started with the push-button or when requested from the equalize menu on the TriStar meter. Automatic equalization will occur according to the battery program specified by settings switches 4, 5, & 6 in the previous step.

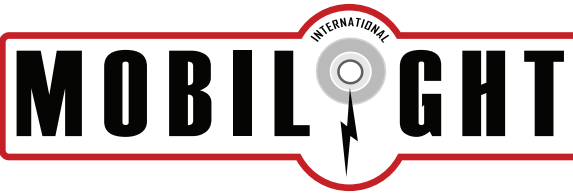

In both settings (auto and manual), the push-button can be used to start and stop battery equalization. If the selected battery charging setting does not have an equalization stage an equalization will never occur, even if requested manually.

Switch 8: Ethernet Security

The Ethernet Security switch enables or disables configuration of the TriStar MPPT 150V settings through the Ethernet connection. When switch eight is set to disabled, write commands to the TriStar MPPT 150V custom memory are not allowed. This a safety feature to prevent unintended changes to custom settings, but it is not a replacement for proper network security.

PHASE 6: Deploy LEDs



Do not position the unit in a location where the lights could aim into the eyes of motorists. The potential glare produced by the LED modules may cause momentary blindness.

Do not look directly into the LED light modules; direct exposure may cause momentary blindness and eye damage.

STEP 1: Position the light carriage.

The Hybrid 1200 is equipped with a 3 stage light aiming system. Prior to deploying the mast, the Light Carriage Pin and Dial system can be adjusted. Located at the top of the mast is a spring-loaded pin and dial system (see Figure 30 and Figure 31). To adjust the position of the light carriage; pull the pin outward and rotate the light carriage to the desired position. Release the pin and the carriage will lock into place.

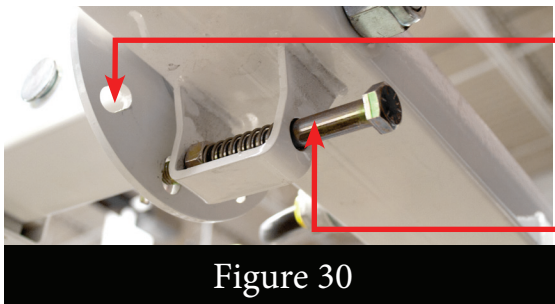

Figure 30

Mast Dial System
Mast Rotation Pin

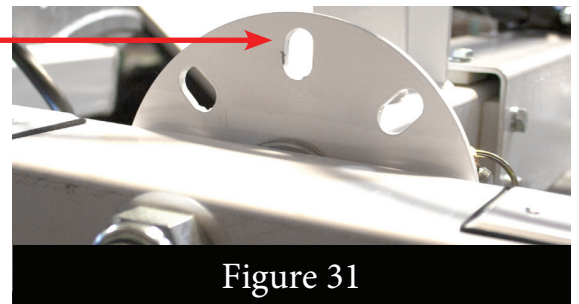

Figure 31

STEP 2: Rotate the mast to aim the LED Array.

A pin-and-dial system is used to rotate and aim the LED Array once the mast has been deployed. The Mast Rotation Pin-and-Dial is located on the drawbar side of the unit, atop the engine/battery compartment (see Figure 32 and Figure 33). The LED Array can be rotated 90 degrees in both the clockwise and counterclockwise direction.

Figure 32: Mast Rotation Pin and Dial



Figure 33: Rotation Pin in Stowed/Travel Position

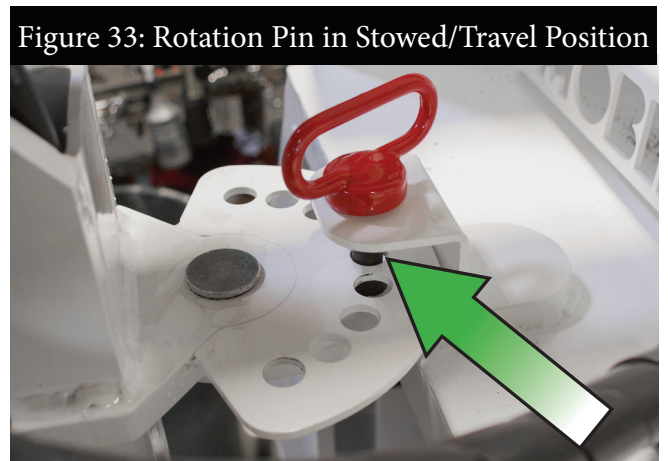
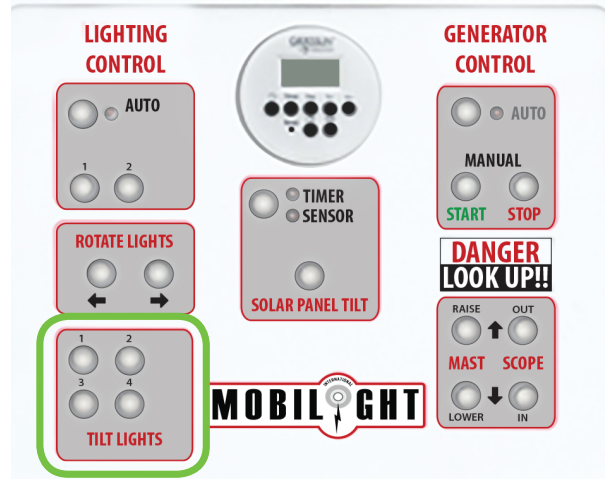

Figure 34: Lighting Controls

STEP 3: Tilt and pan the lights for precise aim.

The Hybrid 1200 unit is equipped with actuator controlled tilt and pan of the LED modules. The actuators are controlled via the Lighting Control switches found on the left side of Control Panel (see Figure 34). Please refer to the Control Compartment section of this manual found on page 10 for detail on switch functions and operation.



PHASE 7: Lighting Operation

The Hybrid 1200 unit is equipped with automatic controls for the LED lighting array; the following section outlines the (3) operating procedures for manual, sensor, and timer.

OPERATING IN MANUAL MODE

STEP 1: Select Manual Mode.

The Lighting Control push-button is used to toggle between Manual and Auto controls. The LED indicator light is used to indicate that the controls are in Auto Mode (see Figure 36).

STEP 2: Activate lights.

The Hybrid 1200 unit is capable of operating manually with one or both tiers of lights active. The manual controls for each tier of lights are located in the Lighting Controls and are labeled “1” and “2” (see Figure 36). Press the button to activate the lights, press the button again to deactivate the lights.

Figure 35: Lighting Control Switches

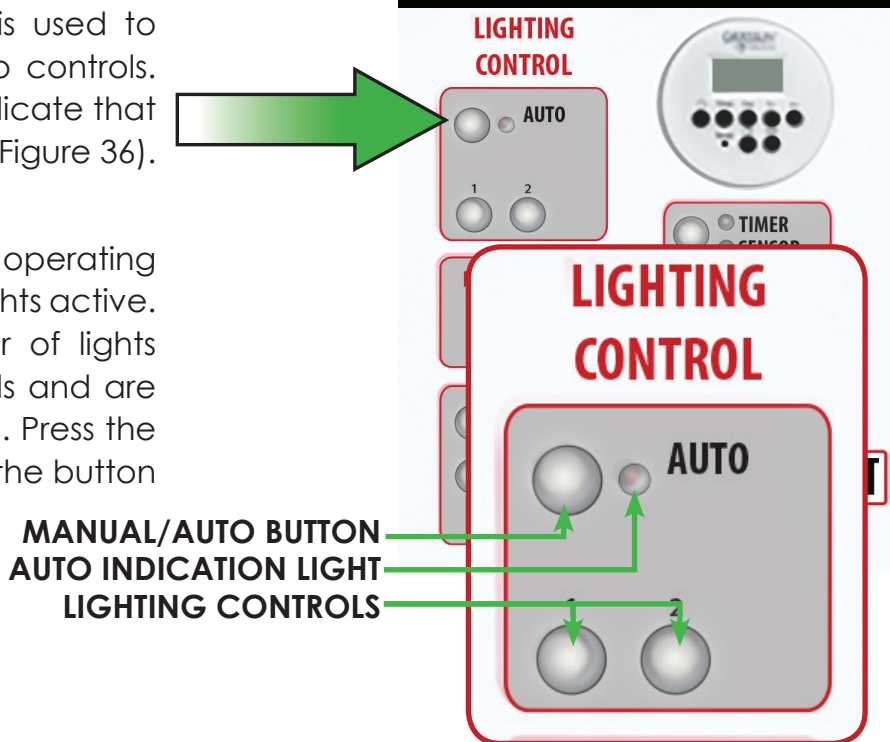

Figure 36

OPERATING IN AUTOMATIC MODE

CONTROL PANEL A

STEP 1: *Select Auto Mode.*

Press the Lighting Control switch to select AUTO mode, check to ensure the unit is properly setup by observing the LED indicator light (see Figure 36). The light will illuminate when the unit is in AUTO mode.

STEP 2: *Select type of Auto Control.*

The Hybrid 1200 unit is equipped with both a digital programmable timer and a photo-eye sensor. The Automatic Lighting Control switch is located in the center of the Control Panel (see Figure 37). LED indicator lights are used to identify which type of auto-control is active. Press the push-button to toggle between TIMER/SENSOR.

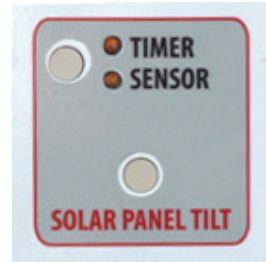

Figure 37

If SENSOR is selected as the desired type of auto-control, be sure the photo-eye has an unobstructed path to the sky. Be sure to prevent any direct light on the photo-eye during hours of operation. The photo-eye sensor is located on the left side, beneath the Main Battery Disconnect Switch, of the Hybrid 1200 unit (see Figure 38). The small metal band can be used to adjust the amount of light the unit receives.



Figure 38: Photo-eye Sensor

NOTE:

For instructions on programming the digital timer please refer to the provided documentation.

CONTROL PANEL B

Manual Mode

When the switch is in manual mode, the user can toggle the switch to manually turn Light Banks A & B to "On" or "OFF."

Sensor Mode

When the switch is in sensor mode, the unit will run using the photo cells. The lights will automatically turn on as the environment darkens; and as the environment lightens, the photo cells will trigger the lights to turn off.

Timer Mode

The control switch can be placed on a timer mode, allowing the user to program lights to a desired duration and day.

PHASE 8: Engine/Generator Operation*

OPERATING IN MANUAL MODE

The Hybrid 1200 unit is equipped with an onboard diesel engine and 13.5 kVA generator. The engine/generator is used to recharge the battery bank as well as provide off-grid AC power. AC power is distributed via the (1) 120VAC duplex outlet and/or the (1) 240VAC outlets. All outlets are protected by their respective circuit breakers (see Breaker Schedule on page 11 for complete details).

	Always ensure that the AC circuit breakers are disconnected prior to attempting any service to the AC distribution system of the Hybrid 1200 unit.
	For use as an off-grid AC power supply, the diesel engine of the Hybrid 1200 unit must be running.
	For maximum power output from the Hybrid 1200, deactivate the AC charging system. Disconnect both breakers 1 and 2 (see page 11).

Select **RUN/MANUAL OPERATION** mode on the **Generator Controller**.

Press the button labeled “RUN” and “MANUAL OPERATION” to initiate the engine starting process.

NOTE: The engine will continue to run until it is deactivated by pressing the “OFF” button.

* OPERATION ASSUMES PROPER POWER IS SUPPLIED.



Figure 39: Generator Auto-Run Controller

OPERATING IN AUTOMATIC START MODE

The Auto-Start system is designed to automatically start to replenish the battery bank capacity that is consumed during operation.

	<p>This unit is equipped with auto-start capabilities; when in Auto Mode, the engine will automatically start without warning. Be sure to stay clear of all moving parts of the engine and electrical distribution circuits.</p>
	<p>The Generator Auto-run Controller comes preset from the factory. The settings have been set such that the unit will run only to replenish what has been consumed by the LEDs. Mobilight International retains no responsibility for the systems operation if the settings on the Generator Auto-run Controller have been altered.</p>
	<p>Never allow the Hybrid 1200 engine to start/run in an enclosed garage or any other type of enclosed structure without proper ventilation. Carbon Monoxide, an odorless, colorless, deadly gas may accumulate and cause serious injury or death.</p>

STEP 1: Check engine fluids including fuel level.

Ensure the fuel level is adequate for the period of time the unit will be left unattended. Check to ensure the engine has the proper amount of coolant and engine oil.

STEP 2: Ensure the Master Disconnect Switch is "ON."

STEP 3: Select AUTO on the Generator Auto-run Controller.

Simply press the button labeled "AUTO NORMAL OPERATION" to initiate automatic engine and generator starting. The control module will monitor the battery banks and automatically start the engine when the low voltage threshold is met. The engine will run for approximately 120 minutes once initiated.

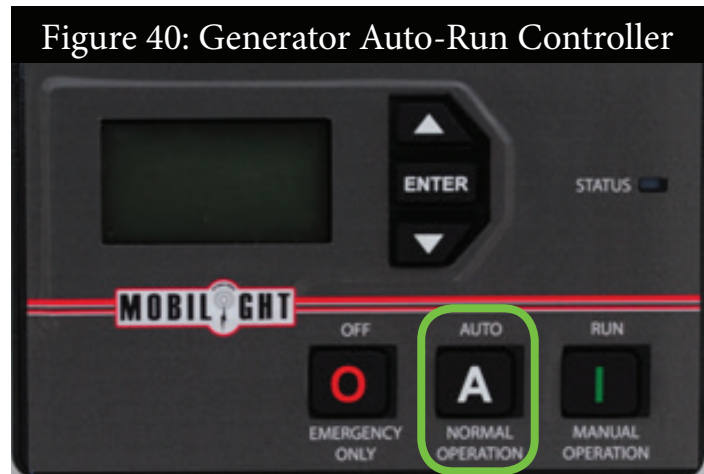

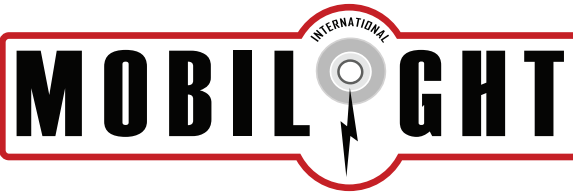

TEARDOWN PROCEDURE



The following section details the teardown of the Mobilight International Hybrid 1200 unit. Please adhere to all of the recommended operational and safety procedures and practices to ensure the safety of the operator and those in the immediate vicinity.

PHASE 1: Deactivate Auto-Start Mode

STEP 1: Deactivate Auto-start Mode. To deactivate the Auto-start mode simply press the button labeled "OFF" on the Generator Auto-run Controller (see Figure 2 and/or Figure 40).

STEP 2: Disconnect power to the engine starter circuit. To prevent any possibility of the engine starting during transportation, disconnect power to the engine starter circuit by rotating the Main Battery Disconnect to the OFF position (see Figure 14).

PHASE 2: Stow Solar Panel Array



Electrical Shock Hazard: Do not attempt to operate or service the unit if the insulation on the electrical cords from the solar panels are cut, worn or showing any signs of damage. Bare wires in contact with solar panel frame or trailer may energize the unit and could cause electrocution! STOP IMMEDIATELY and contact an Authorized Service Center.

When outriggers are deployed, they may become a tripping hazard. Pay particular attention to their placement during setup and teardown.

ALWAYS STOW THE SOLAR ARRAY PANELS BEFORE STOWING THE TOWER MAST!

STEP 1: Return the solar array to the resting position with the Solar Panel Tilt switch located on the Control Panel (see Figure 27).

STEP 2: Place the Solar Panel Array Support Arms in their stowed position (see Figure 24). Ensure the Panel Support Arm pins lock securely into place.

STEP 3: Fold both sides of the array inwards, ensuring the Solar Array Locking Pins are fully engaged (see Figure 21).

PHASE 3: Retract & Stow Tower Mast

	Do not attempt to stow mast without ensuring it is properly aligned and the mast rotational control is in proper position.
	The trailer must remain level with the outriggers deployed while lowering the tower mast. Failure to maintain a level trailer will severely reduce the stability of the unit.
	Always fully retract mast prior to stowing.

STEP 1: Return the mast to the stowed position.

Remove the Mast Rotation Pin and rotate the mast to the stowed/travel position (see Figure 33). Reinsert the Mast Rotation Pin to secure the mast.

STEP 2: Retract and stow the mast using the Mast Control Switches (see Figure 17).

Press and hold the Scope "IN" button to retract the mast completely. Press and hold the bottom-left button labeled "LOWER" to lower the mast to its stowed position, continue to lower the mast until it is properly seated in the mast cradle.

PHASE 4: Stow Outriggers

STEP 1: Raise the outrigger jack feet by rotating the handle counter-clockwise. Repeat for all four outriggers.

STEP 2: Pull the locking pin (see Figure 10) on the outrigger jack and rotate the jack 90° to the horizontal position. The locking pins will automatically lock in place. Repeat for all four outrigger jacks.

STEP 3: Release the locking-pin on the outrigger sleeve (see Figure 9).

STEP 4: Push the outrigger into the outrigger sleeve until the locking pin locks into place. Repeat for all four outriggers.

PHASE 5: Disconnect Earth Ground



Electrical Shock Hazard: Mobilight International strongly recommends that a trained and licensed professional perform all electrical, wiring, and testing functions. All wiring must be in accordance with the United States National Electric Code (NEC), state and local codes and Occupational Safety and Health Association (OSHA) guidelines.

STEP 1: Disconnect the tag end of the grounding cable from the grounding post or grounded grid.

STEP 2: Loosen the grounding lug post (see Figure 13) and remove the cable from the lug.

TOWING THE HYBRID 1200 UNIT



Tandem towing of units on highways is not recommended. Do not exceed 35 mph while towing more than one unit in tandem. Know your local laws concerning tandem towing.

DO NOT MODIFY or use the equipment for any application other than which it was designed.

Make sure slings, chains, hooks, ramps, jacks, and other types of lifting devices are attached securely and have enough weight bearing capacity to lift or hold the equipment safely. Always be aware of the position of other personnel around the unit when lifting the equipment.

Make sure the towing vehicle's hitch ball is appropriately sized (2 in.) for the Hybrid unit's coupler.

Maintain extra distance between other vehicles on the roadway and the towing vehicle. Avoid soft shoulders, curbs and/or sudden lane changes and reduce speed during cornering and/or turning. If you are inexperienced at towing a trailer, take extra time to practice turning, stopping, and backing up in an area away from heavy traffic.

To help extend the life of the coupler and eliminate squeaking, a thin film of grease may be applied. Wipe the coupler clean and apply fresh grease prior to towing the unit.

Once the solar panel array, tower mast, jack stands and outriggers are properly stowed, the trailer can be prepared for transport.

STEP 1: Using the jack on the trailer tongue, raise or lower the trailer hitch onto the ball of the towing vehicle. Lock the hitch coupling and attach the safety chains to the vehicle. Raise the jack completely and remove the locking pin. Rotate the jack into the travel position and replace locking pin.

STEP 2: Remove the wheel chocks from their deployed position (if used).

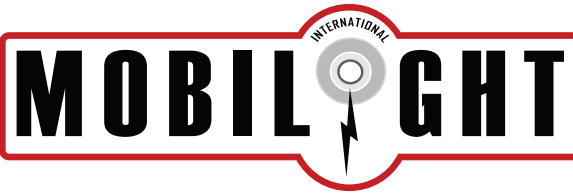

STEP 3: Connect any trailer wiring to tow vehicle and check the operation of brake lights, running lights, and turn signals.

STEP 4: Release the mechanical parking brake.

STEP 5: Check that all locking pins are in place and secure.

STEP 6: Make sure all doors are properly closed and latched.

STEP 7: Check tire pressure of trailer tires. Maximum cold inflation pressure is 60 psi for trailer tires.

DAILY INSPECTION

STEP 1: Inspect the condition of all electrical cords and cables. Do not use the Hybrid unit if insulation is cut or worn on any cable.

STEP 2: Check that all safety locking pins on Outriggers, Jacks, and Solar Panel Array are present and secured.

STEP 3: Check that the solar panel surface is not broken or cracked. Check to make sure solar panel surface is not shaded by major objects.

STEP 4: Check the lenses on all the LED modules for cracks and or knicks. Replace any modules that show signs of damage. Check that pigtails to the LEDs are snugly secured in socket.

REPORTING TRAILER SAFETY DEFECTS

If you believe your trailer has a defect that could cause an accident, personal injury or death, immediately discontinue use and notify your local dealer and/or Mobilight International.

HYBRID 1200 LIGHT TOWER SCHEMATICS

Main Power Diagram

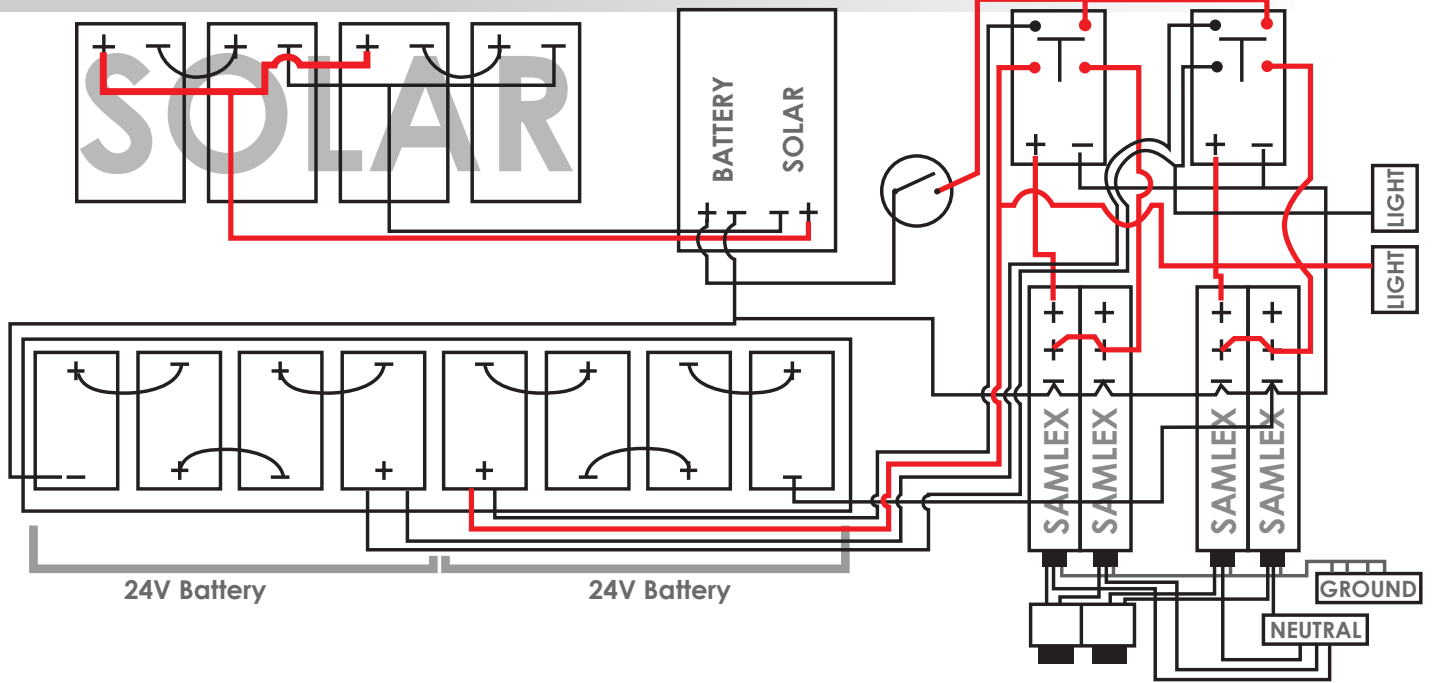

Toggle Switch Diagram

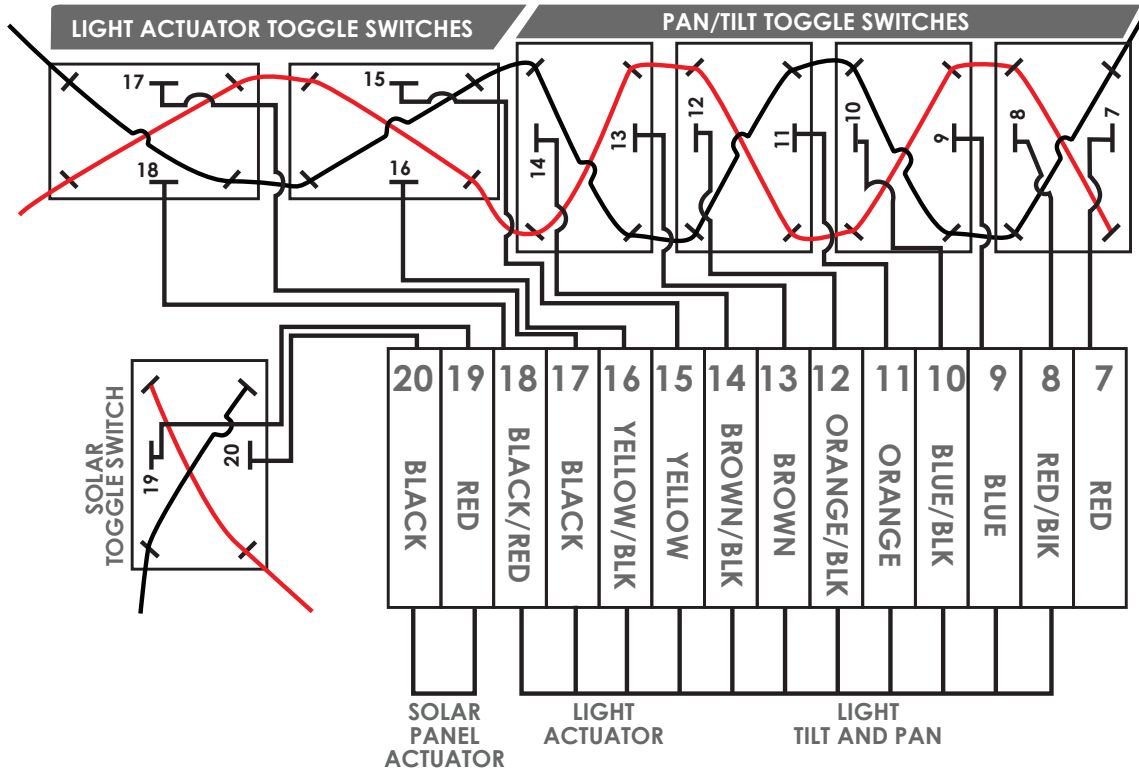

Main Control Panel Diagram

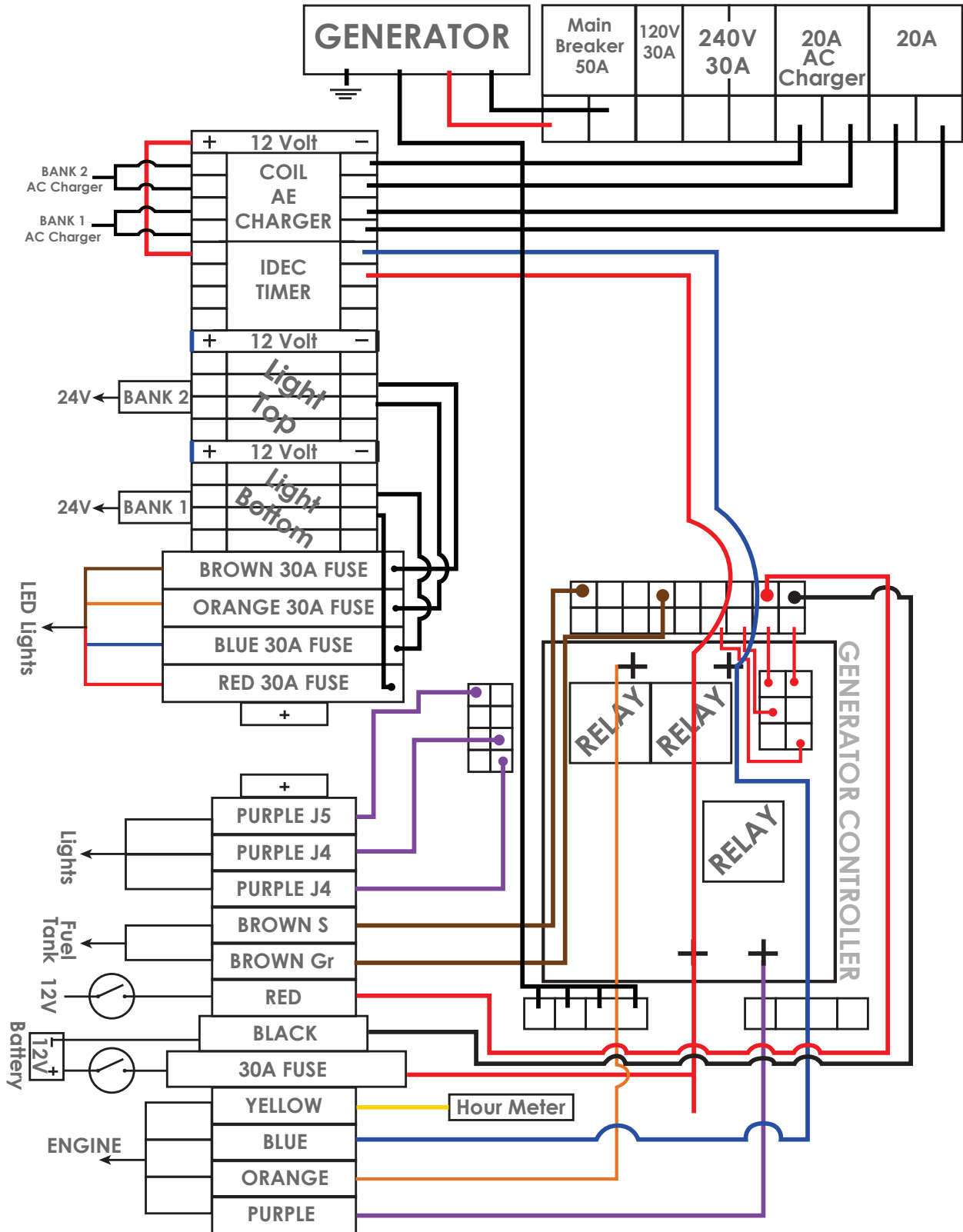

Light Contact Control Diagram

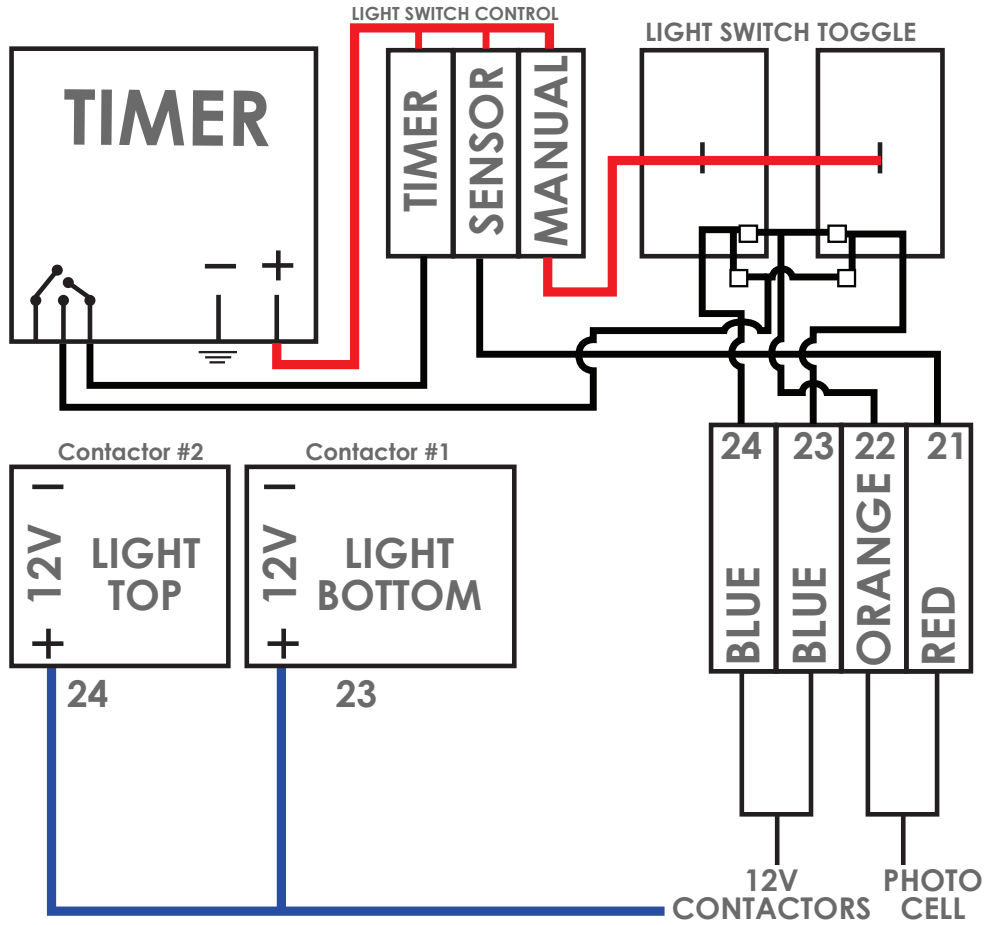

Hydraulic Toggle Switch Diagram

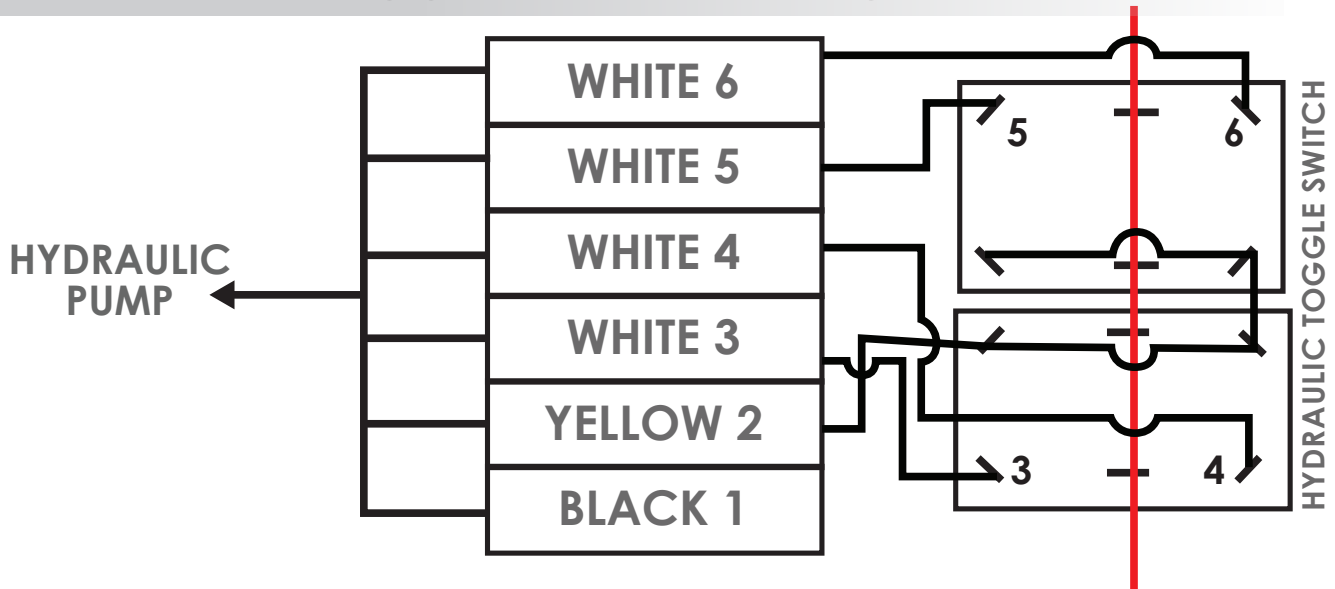

Generator Control Diagram

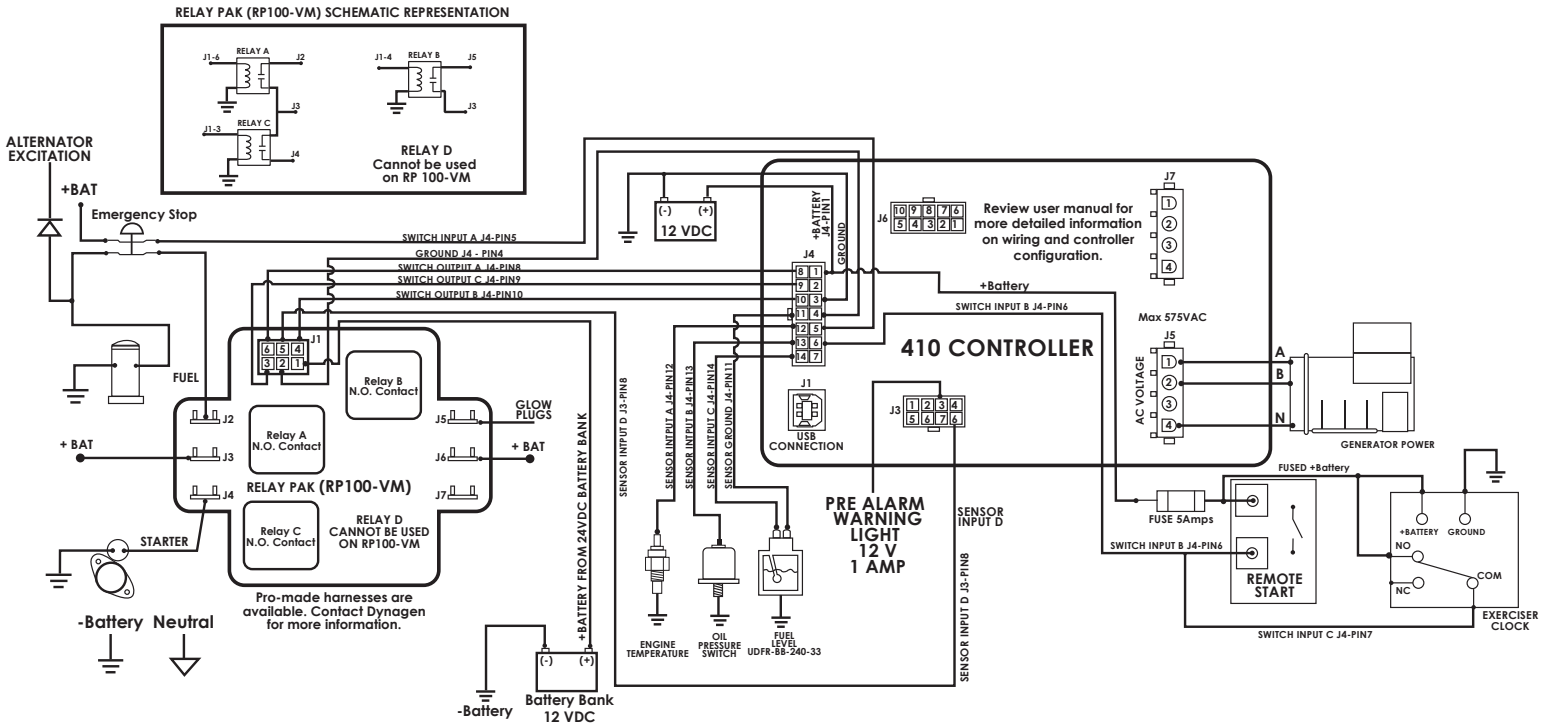

RELAY PAK CONNECTOR	
J1-1	Battery Bank Input
J1-2	-Battery
J1-3	Relay C Coil
J1-4	Relay B Coil
J1-5	Sensor Port D IN TG350
J1-6	Relay A Coil
J2	Relay A Contact
J3	A & C Common
J4	Relay C Contact
J5	Relay B Contact
J6	B & D Common

MAIN CONNECTOR	
J4-1	+Battery
J4-2	+Battery
J4-3	Ground
J4-4	Ground
J4-5	Switch Input A
J4-6	Switch Input B
J4-7	Switch Input C
J4-8	Switch Output A
J4-9	Switch Output B
J4-10	Switch Output C
J4-11	Sensor Ground
J4-12	Sensor Input A
J4-13	Sensor Input B
J4-14	Sensor Input C

EXPANSION CONNECTOR	
J3-1	Switch Input D
J3-2	Switch Input E
J3-3	Switch Output D
J3-4	Switch Output E
J3-5	Switch Output F
J3-7	Sensor Ground

GENERATOR CONNECTOR (V)	
J5-1	Gen. Phase A
J5-2	Gen. Phase B
J5-3	Gen. Phase C
J5-4	Neutral

COMMUNICATION CONNECTOR	
J6-3	
J6-4	CAN High
J6-5	CAN Low
J6-6	CAN Ground
J6-7	Speed Input
J6-8	Speed Reference
J3-9	

THIS DOCUMENT CONTAINS CONFIDENTIAL INFORMATION AND/OR TRADE SECRETS WHICH ARE THE PROPERTY OF MOBILIGHT INTERNATIONAL INC. THIS DOCUMENT MAY NOT BE REPRODUCED OR TRANSMITTED TO OTHERS IN ANY MANNER, NOR MAY ANY USE OF THE INFORMATION ON THIS DOCUMENT BE MADE, EXCEPT FOR THE SPECIFIC PURPOSES FOR WHICH IT IS TRANSMITTED TO THE RECIPIENT, WITHOUT THE PRIOR WRITTEN CONSENT OF DYNAGEN TECHNOLOGIES INC.

IOTA Wiring Diagram

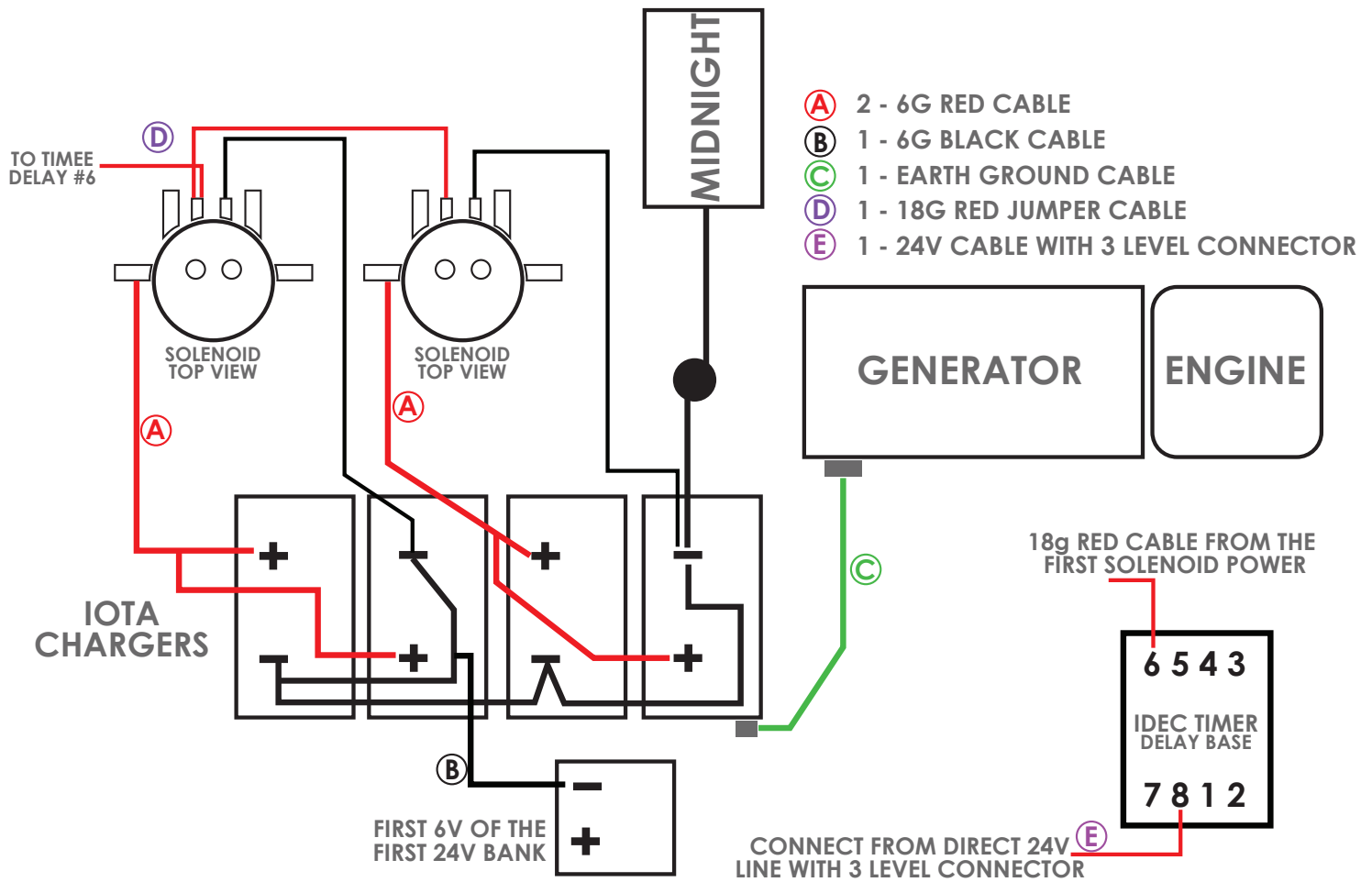

IOTA SINGLE SOLENOID DIAGRAM

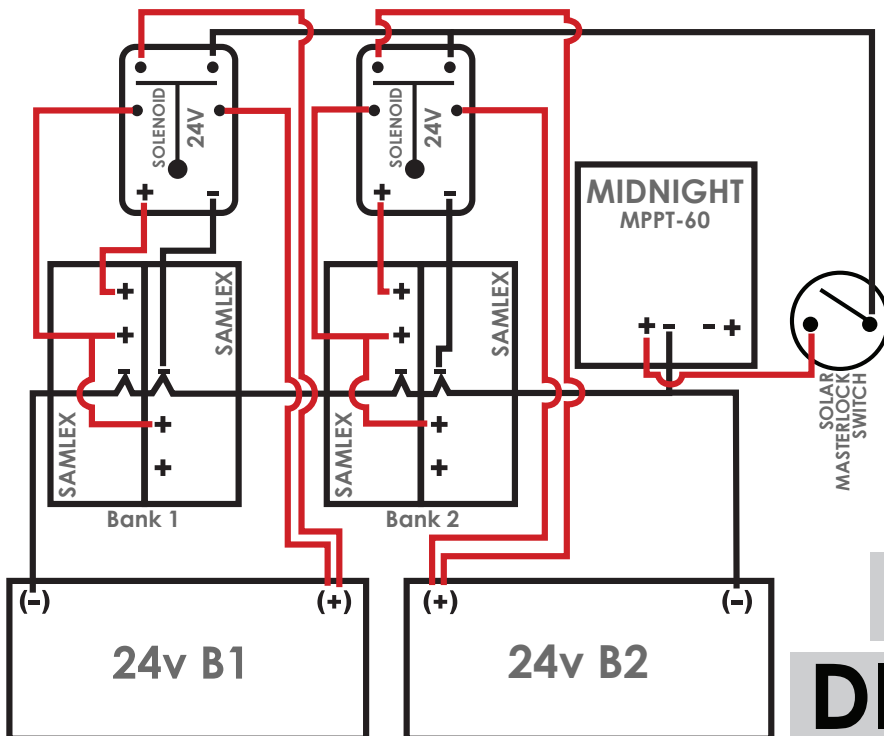
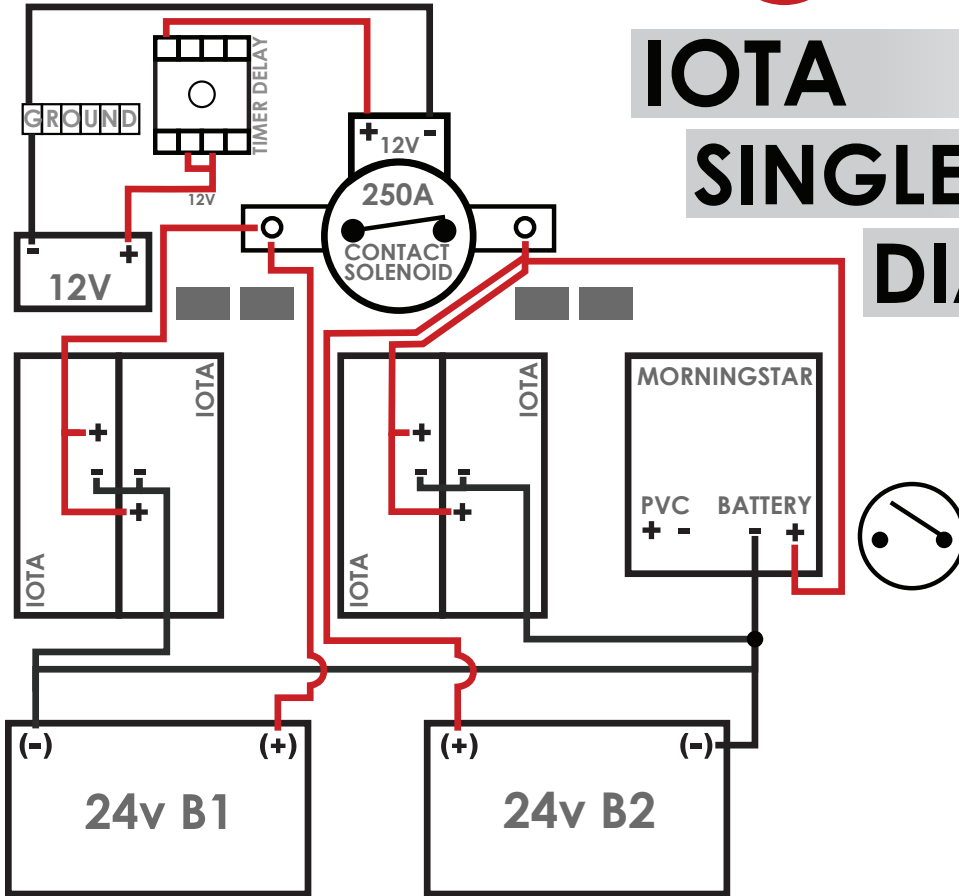

SAMLEX POWER DIAGRAM

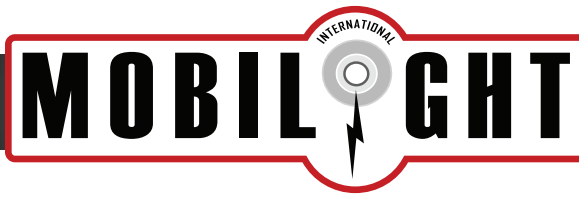

TROUBLESHOOTING



Electrical Shock Hazard: Mobilight International strongly recommends that a trained and licensed professional perform all electrical, wiring, and testing functions. All wiring must be in accordance with the United States National Electric Code (NEC), state and local codes and Occupational Safety and Health Association (OSHA) guidelines.

Mast and Scope	41
Solar Charger	42
LEDs	42
Generator Controller	44
Engine	44
Generator	45
Battery Charger	49
Batteries	51

Mast and Scope

MAST NOT RAISING OR LOWERING	Check master disconnect switch is in "ON" position.
	Check 12v battery is above 11v.
	Check needle valve and ensure knob is not restricting hydraulic fluid flow.
	Ensure that scope has not been extended before mast has been raised, mast will not raise due to weight issue.
	If Mast has a safety pin to lock it in place at the saddle point that the pin has been removed.
	Check din cable is getting power, DIN cable connector will light up.
	If you do not have a din connector that lights up, meter the toggle switch to see that it's receiving and sending power.
	Check that Hydraulic pump motor is function.
	Check for any Hydraulic fluid leakage from hose fitting, hose and or reservoir.
	If mast does not lower, be sure that scope has retracted and that the "J" hook at the base of the mast is not in locked position.

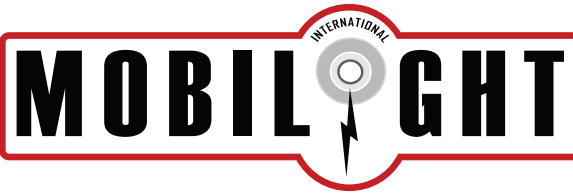

SCOPE DOES NOT RETRACT	If you have a 30' mast make sure the safety latch is disconnected from the scope.
	Go through standard checklist for Mast.
	Do not extend scope before raising mast.

Solar Charger

Please refer to solar charger manufacturer's manual.

SOLAR CHARGER IS NOT CHARGING	Check that solar disconnect switch is in the "ON" position.
	Meter the 24v bank to ensure that the bank is not completely drained.
	Check for any loose wiring leading to the solar charger.
	Check master disconnect switch is in "ON" position.
	Make sure the solar panels are deployed and pointed in the direction of the sun.
	Check solar cables running to charger and ensure they are connected.

LEDs

LEDs ARE FLICKERING	Flickering LEDs usually means the battery bank is low, so meter the banks to see it's state of charge. If it's low then run the engine manually to top up the batteries
	Batteries are low and will not charge, see Battery troubleshoot section.
	Meter voltage in control panel where 24v line comes from battery to contactor then meter where the 24v line leaves the contactor to the LED.
	Check pigtail that connects to back of LED, ensure that it is snug in the socket.
	Remove the pigtail to the LED that is flickering and replace it with another pigtail from a working LED from the same tower.

<p>LEDs ARE FLICKERING (CONT'D)</p>	<p>Check fuse/circuit breaker</p>
	<p>If it's a bank of lights, two LEDs on top or bottom, check contactor inside control panel. Switch the light control to "manual mode" while viewing the contactors, press the toggle switch "ON" then "OFF" and see if the contactors are working properly.</p>
<p>LEDs DO NOT TURN ON</p>	<p>If it's just one LED, check pigtail behind the LED fixture to ensure pigtail is plugged in. Also check inside the control panel that a fuse or breaker did not pop.</p>
	<p>If it's a bank, two LED fixtures either on top or bottom of "T" bar then meter the 24v battery bank. If the banks look good then work your way up to the LEDs. Meter lines coming in and out of the contactor then upward towards the pigtail. See where the 24v drops off. Also look inside the "T" bar to make sure that the wires inside have a good connection.</p>
	<p>Check which light control function it is currently on. Then select the two other options to narrow down the issue.</p>
<p>"Manual"- Press the toggle switch to each bank and see if they work. If they work then all connections are fine and you can move to the next control option. If they do not work then check loose wires or inside control panel and repeat above steps to see where 24v power stops.</p>	
<p>"Sensor"- This works off the photocell, toggle switch is in "OFF" mode, with your hand or glove, cover the eye of the photocell. Within 5 seconds the photocell will trigger the LEDs to come on. If they do not then the photocell has gone bad. Replace the photocell and re-test. If the LEDs do come on then set it to "Timer"</p>	
<p>"Timer"- LEDs run off a set time and day programmed. By programming the LEDs to come on a few minutes and shut off a few minutes after will indicate whether the "Timer" is functioning properly.</p>	

Generator Control

LED DISPLAY DOES NOT COME ON	Check that master disconnect switch is in "ON" position.
	Check 5A fuse inside control panel.
	Check 14 pin connector to generator controller inside control panel is in snug. (This provides power to device.)
	Check 12v line from fuse compartment is connected.
	Meter line up to generator control to ensure power is being received.
IMPROPER PARAMETER READING	Depending which reading is incorrect you may want to call your local dealer.
	If the battery voltage reading differs from what you meter on the bank then you can calibrate the generator control. To do so, please call your local dealer or on the generator controller please follow the instructions: Press the "Off" button > Scroll down to "Sensor">Aux1>Trim offset then press the up or down arrow to change by increments of .1v
	If the voltage reading is incorrect, meter the voltage output starting with the circuit breaker then move your way to the generator. Metering breaker is done with one needle on the circuit breaker screw and the other to ground. Do this for the main and the two to the DC chargers.

Engine

Engine (Refer to engine manufacturer's manual, however, here are some common issues)

ENGINE DOES NOT START MANUALLY	Check fuel level.
	Check fuel line is not blocked or kinked.
	Check electronic fuel pump is ticking during pre-heat.
	If weather is too cold and there is not a diesel heater inside, the diesel may have gelled up. Recommend diesel heater and insulation for cold climate 10 degree or below.
	Check fuel filter or replace if it is clogged.

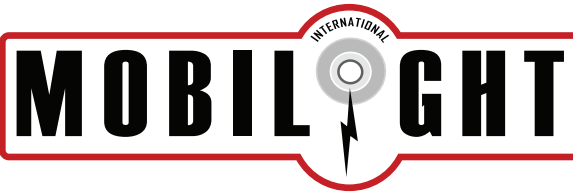

Generator

SETTING THE VOLTAGE TO 240 VOLTS AND ENGINE SPEED TO 50HZ OR 60HZ.

50 HERTZ IS SET BY ADJUSTING THE GOVERNOR BOLTS TO FASTER OR SLOWER. SET THE ENGINE TO RUN AT 1500 rpm. FOR 50HZ (OR 1800RPM FOR 60HZ).

This can be monitored from a good quality meter such as the "FLUKE 87". The meter is capable of reading the volts and hertz on the same screen. For the 50hz generators, the voltage is controlled automatically by the Auto Voltage Regulator "AVR" [2] and at the factory Mobilight have switched the jumper from 60 to 50 or vice versa. There are 50hz and 60hz lugs on the AVR card. For fine adjustment there is a pot with a very sensitive adjustment that can move the voltage up and down (within 20 volts) with a small fine plastic screwdriver [2]. Adjust this to fine tune the voltage to 240 volts. The pot adjustment is quite sensitive.

For 60hz settings, change the jumper on the AVR to 60hz and speed up the engine RPM to 1800 RPM by moving the throttle lever to the left [4]. Use two 10mm wrenches. The electric meter will show 60hz (RMS) and should have a voltage of 240volts also. The pot adjustment may be necessary to find 240volts if the volts are out by more than 3volts.

The Engine governor lever on the Kubota 1505 has a 10mm retainer bolt on both sides of the throttle lever. Loosen one and tighten the other to the rear to speed up or loosen the bolt on the right and tighten the left to slow down the engine. Check every month or two for accuracy of 50 or 60HZ and 240 volts.

Most towers have already been set at the factory and testing and checking may be all that is needed to be done.

GENERATOR PRODUCES LOW VOLTAGE/NO LOAD	Underspeed operation: Check speed using a tachometer or frequency meter.
	Voltmeter off or defective: Check voltage with a separate meter at the generator terminals.
	Incorrect or defective connections: Verify generator connections. See drawings supplied with the generator or lead connection diagrams in this manual. Inspect all wiring for grounds, open circuits and short circuits.
	Loss of regulator power: Check regulator fuse and input power. Input power is produced by the generator's residual voltage or from an optional PMG.

GENERATOR PRODUCES LOW VOLTAGE/NO LOAD (CONT'D)	Regulator adjustment: Adjust regulator settings. Consult regulator manual.
	Regulator incorrectly connected: Review the generator connection diagram or reference the regulator manual.
	R-Defective diodes, suppressor, or windings: Test the generator using the 12 volt battery test as specified in the testing section. If the results indicate generator problems, perform insulation, continuity, and diode tests as specified in the testing section.
	Regulator inoperative. Adjust or replace regulator. Consult regulator manual.
GENERATOR PRODUCES VOLTAGE WHEN LOAD APPLIED	Excessive load Reduce load: The load on each leg should be evenly balanced, and rated current should not be exceeded on any leg.
	Large motor starting or low load power factor: Motor starting currents are too large for the generator. When starting multiple motors, sequence the motors and start the largest motors first. Reduce lagging power factor load.
	Driver speed drop or belt slip: Check driver. If belt driven, check belt tension. Check under frequency setting on regulator. Under frequency voltage roll-off may be activated.
	Reactive drop: If the generator is equipped for parallel operation, some drop is normal as reactive load increases. When operating as a single unit, the parallel CT can be shorted to eliminate this effect. Refer to Regulator manual.
GENERATOR PRODUCES FLUCTUATING VOLTAGE	Line drop: If voltage is proper at generator terminals but low at load terminals, increase external wire size.
	Fluctuating engine speed: Check engine and governor systems for malfunctions. Check load for fluctuation.
	Regulator stability: Adjust Regulator stability. Refer to Regulator manual.
	Regulator external rheostat: Replace defective or worn rheostat. Use shielded cable to minimize electrical noise.

GENERATOR PRODUCES FLUCTUATING VOLTAGE (CONT'D)	Defective rectifier assembly: Check assembly for loose connections. Test the diodes as specified in the test section.
	Loose terminal or load connections: Improve connections both mechanically and electrically.
	Defective regulator: Replace regulator.
GENERATOR PRODUCES HIGH VOLTAGE	Faulty metering: Check voltage with separate meter at generator terminals.
	Incorrect connections: Verify generator connections. Refer to drawings supplied with the generator or connection diagrams in this manual.
	Regulator adjustments: Adjust regulator. Consult regulator manual.
	Leading power factor: Check the power factor of the load. If power factor is leading, change load configuration. Excessive leading power factor (capacitors) can cause voltage to climb out of control.
	Incorrect regulator connection: Verify regulator voltage sensing is connected correctly. Consult regulator manual.
Defective regulator: Replace regulator.	
GENERATOR BUILDS VOLTAGE AT STARTUP, THEN GOES LOW VOLTAGE	Regulator protective circuit operating, check indicators on regulator. Correct problems and adjust regulator as is required. Refer to regulator manual.
GENERATOR IS OVERHEATING	Generator is overloaded: Reduce load. Check with ammeter and compare with nameplate rating.
	Clogged ventilating screens: Clean air passages.
	High room temperature or altitude: Improve ventilation or reduce load.
	Insufficient circulation of cooling air: Generator location and enclosure design must provide adequate airflow and minimize recirculation of hot air.
	Unbalanced load: The load on each leg should be as evenly balanced electrically as possible and should not exceed rated current on any one leg.

GENERATOR PRODUCES MECHANICAL NOISE	Defective bearing: Replace bearing.
	Loose or misaligned coupling: Tighten, realign, or replace coupling.
EQUIPMENT RUNS NORMALLY ON UTILITY POWER, BUT WILL NOT RUN ON GENERATOR SET	Distorted voltage waveform: Analyze load. Excessive SCR (thyristor) loading will cause distortion. Some equipment may be sensitive to distorted waveforms. Refer to Marathon Electric Manual.
	Improper generator voltage or frequency: Check name plates of devices comprising the load. Compare required voltage and frequency with that of the generator. Adjust driver speed and/or generator voltage as necessary to match generator output to load requirements.

MARATHON AVR SYSTEM DOUBLE DELTA - SINGLE PHASE CONNECTION

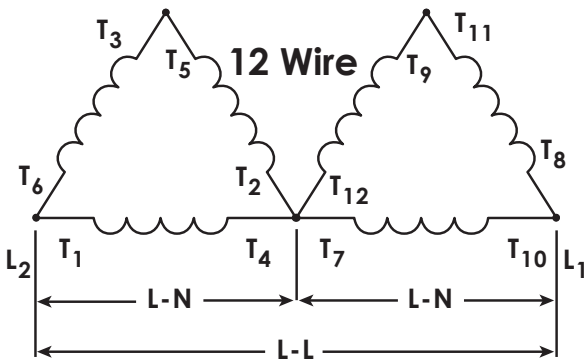

VOLTAGE DOUBLE DELTA		
Hz	L-L	L-N
60	240	120
	220	110
50	220	110

NOTE: Single phase KW/KVA ratings are approximately equal to 50% of the generator's three phase ratings

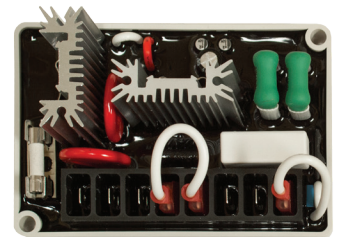
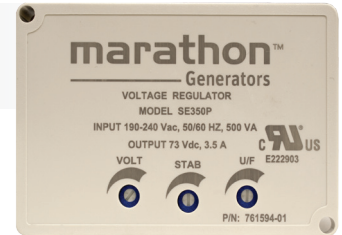

MECC ALTE AVR SYSTEM DEDICATED SINGLE PHASE CONNECTION

HIGH VOLTAGE - SERIES CONNECTED

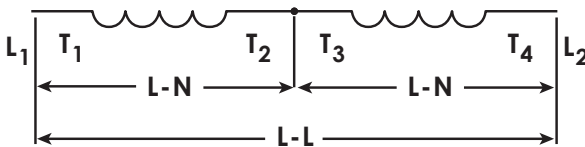

VOLTAGE (DEDICATED)		
Hz	L-L	L-N
60	240	120
	220	110
50	220	110
	200	100

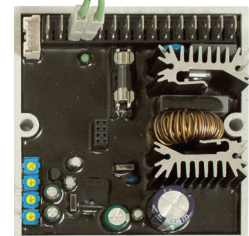
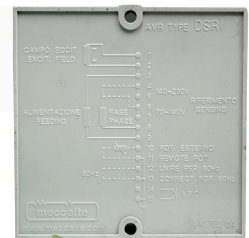

Battery Charger

BATTERIES NOT CHARGING	<p>There are four battery chargers, two are designated for one 24v bank.</p>
	<p>There are two solenoids, one per 24v bank, they are the two closest to front panel.</p>
	<p>Each battery charger is set to output 40A and the four battery chargers are configured as two banks and outputs 80A per bank at 28v charge voltage, although this number will fluctuate depending on how charged the batteries are.</p>
	<p>Some models will only have one solenoid that controls the charge to the batteries. See wire diagram on page 40.</p>
	<p>Batteries are charged via solar or generator. Determine when it is not charging. When it is being charged by the solar the solenoids are in a closed position so the solar charger sees all the batteries as one bank. When the engine is running the solenoids will open and separate the two banks of 8 batteries to charge. If only one bank is charging, then one solenoid could be bad.</p>
	<p>Check all cables and wires that go from batteries to generator and make they are in good working condition.</p>
IF BATTERIES ARE NOT CHARGING VIA SOLAR CHARGER	<p>Check that the solar disconnect switch is in the "ON" position.</p>
	<p>Check that solar panels are deployed, in closed position the solar charger will not display a reading.</p>
	<p>Check cables on the solar modules are connected and are not damaged.</p>
	<p>Check to see that the solar charger LCD display is on and read the display, the proper verbiage will be on the solar charger's ops manual and may differ between chargers.</p>

<p>IF BATTERIES ARE NOT CHARGING VIA SOLAR CHARGER (CONT'D)</p>	<p>Meter the current coming in from the solar panel to determine if the panels are sending the proper Amps; Amp capabilities are shown on the module label.</p> <p>Depending on the solar charger condition, meter the current that is coming out of the solar charger to the batteries.</p> <p>If the solar charger display is not on after the solar disconnect is in "ON" position then test with another charger. Please refer to solar charger ops manual to configure dip switches when replacing solar charger.</p>
<p>IF BATTERIES ARE NOT CHARGING WHEN THE ENGINE IS ON</p>	<p>Meter both banks and determine their voltages. Meter each cell and determine its voltage.</p> <p>If there is daylight and you are running the engine turn solar disconnect switch to "OFF" position and run the engine manually. If your system has a timer delay, it may take up to 2 minutes before the delay trips and sends power to the battery chargers.</p> <p>Check the timer delay first, it's inside the control panel, check the delay time setting.</p> <p>Once the delay timer trips, note the generator voltage output reading on the generator control display. The proper reading should read 240v, 120v, 120v. If you see this reading go to step #1 if you do not see the proper reading then go to step #2.</p> <p>STEP #1 Proper reading is displayed on the generator control 240v, 120v, 120v but batteries are not charging:</p> <p>Check to see that all the battery chargers are on, if they are Samlex chargers, you can push the "Half power" button to see if the green LED comes on. If it does then it is working. If it does not then it may need to be replaced.</p> <p>The Samlex charger has voltage needle that will fluctuate when it's on, if this needle is at "0" then it may need to be replaced.</p> <p>Check the fuses to each charger.</p>

<p>IF BATTERIES ARE NOT CHARGING WHEN THE ENGINE IS ON (CONT'D)</p>	<p>STEP #2: Meter the cable that supplies power to the battery chargers, see that the generator is outputting current.</p> <p>If the battery chargers are "ON" then the next step is to meter the red battery cable that comes from the battery chargers to the solenoid. Meter each bank of the battery charger, each should be sending current 40A or higher if the batteries are not charged and the voltage reading should be at least 27V.</p> <p>If you are still getting these proper readings then the next step is to meter the battery cables that come from the solenoid to the battery bank. See if you are getting the same reading of current and charge voltage.</p> <p>Do this for each solenoid to determine if the solenoids are bad and need to be replaced.</p>
--	--

Batteries

<p>VOLTAGE IS LOW</p>	<p>Check each battery terminal for corrosion or damage.</p> <p>Check each battery for any bulging, cracking, deterioration and any other types of damage that would indicate time for replacement.</p> <p>Meter the battery banks and determine its state of charge, then meter each cell and determine its state of charge.</p> <p>See if solar disconnect is in "ON" position to ensure batteries are being charged from solar.</p> <p>See steps above to troubleshoot and verify if battery chargers are working properly.</p>
------------------------------	---

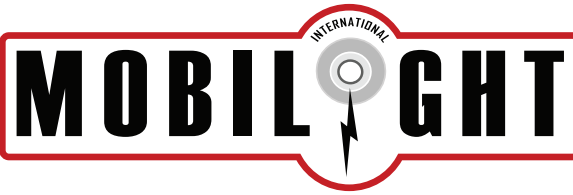

Depending on how drained the batteries are, 24v reading is at 50% depth of discharge, anything lower means batteries are below proper charge and using it can damage the batteries.

We recommend recharging the batteries for at least 2 hours (by manually running engine) depending on the battery voltage level. Once the batteries show a charge, manually turn the lights on for 5-10 minutes and then meter the batteries again, by bank then by cell. This process eliminates the initial surface charge on the batteries after it's been charged and brings it to its current state of charge. The reading will determine if the batteries are holding their charges properly, or if it's time to replace them.

Meter per bank, then per cell.