

METER RUNS

**30" QUADRUPLES SEPARATOR PACKAGE
CORDOVA D-55-A/94-P-10 FACILITY
PENN WEST EXPLORATION
P.O. # PEI-A13370663-01
C/O PIONEER ENGINEERING INC
CADO PROJECT # 2013-070 UNIT 1 OF 2**

CADO INDUSTRIES INC.

7491 – 110 AVENUE SE CALGARY, AB T2C 3B8 TEL 403-279-6662 FAX 403-279-6687



**CADO INDUSTRIES INC
PO 3012-070-8302**

**DANIEL INDUSTRIES CANADA
REF: DC-W-13-7030908**

**Documentation Package For:
Serial# 13300050, 13210332, 13340173,
13250528
DCM 13-01403, 13-01386, 13-01402, 13-
01389**

DANIEL®



INDEX

SECTION 1: INSPECTION REPORT

SECTION 2: MTR'S

SECTION 3: TEST REPORTS

SECTION 4: DRAWINGS

DANIEL®



SECTION 1: INSPECTION REPORTS



Daniel Industries Canada Inc.
P.O. Box 727, Stn T (T2H 2H2)
4215 – 72 Avenue S.E.
Calgary, Alberta T2C 2G5
Canada

T 403-279-1879
F 403-236-1337
www.daniel.com

Meter Tube Nameplate Facsimile

For use with AGA Report 3/API 14.3, Part 2, Third and Fourth Editions

| | | |
|--------------------------|----------------------------|--------------------------|
| DANIEL _____ | Emerson Process Management | Made in Canada |
| DATE: 11/18/13 | AGA FIG: CPA50E 2000 | UL / DL: 53.925"/33.118" |
| TAG: | MAX BETA: .70 | Dr: 3.822" |
| DCM: 13-01403 | MAX ORIFICE: 2.676" | ANSI/DMT: 600 -20°F |
| CRN: OF0634.21 | MIN ORIFICE: .573" | MAWP@TEMP 1480PSI@100°F |
| Daniel Industries Canada | Ph: 403-279-1879 | Fax: 403-236-1337 |

Daniel Canada WO: 7030908

Orifice Fitting S/N: 13300050

Rev 3, 2011-12-13





EMERSON
Process Management

Orifice Meter Inspection Certificate
AGA3/API 14.3, Part 2, 2000 Edition

DANIEL
Daniel Industries Canada Inc.

General Meter Tube Information

Customer Information

Customer: CADO INDUSTRIES INC
Address 1:
Address 2:
Customer P.O.: 2013-070-8302
Customer Job No.: 7030908
Meter Tag No.: N/A

Inspection Number: DCM13-01403
Meter Tube Serial No.:
Manufacturer: Daniel Canada
Inspection Criteria: AGA3/API 14.3, Part 2, 2000 Edition
AGA3 Configuration: CPA 50E
Nominal Line Size: 4"
Pipe Schedule: 80
Published I.D. (in.): 3.826"

Measured Internal Diameter of Meter Tube

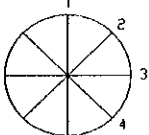
| Position | I.D. Measurements 1" Upstream from the Upstream Face of Orifice Plate (in.) | Calculations | |
|---|---|--------------|--|
|  | 1 | 3.822 | Coefficient of Thermal Expansion, α_2 : 0.00000620 Meter Tube Temperature, T_m (°F): 61.8 Reference Temperature, T_r (°F): 68.0 Measured Meter Tube I.D., D_m (in.): 3.822 Calculated Meter Tube I.D., D_r (in.): 3.822 |
| | 2 | 3.822 | |
| | 3 | 3.822 | |
| | 4 | 3.822 | |

Verification of the Internal Diameter of the Meter Tube

Note: Internal diameter measurements are checked in a minimum of 4 equally spaced planes at various locations along the length of the meter tube. Max./Min. values for various sections of the meter tube are recorded below. Locations of these check measurements include the orifice fitting, welds, adjoining flanges and pipe.

| | Within 1D _m Upstream of Orifice Plate | Downstream | Entire Upstream Section | |
|-----------------------|--|------------|-------------------------|-------|
| Tolerance (in.): | 0.010 | 0.019 | Max. Tolerance (%): | 0.500 |
| Allowable Max. (in.): | 3.832 | 3.841 | Recorded Max. (in.): | 3.835 |
| Allowable Min. (in.): | 3.812 | 3.803 | Recorded Min. (in.): | 3.818 |
| Recorded Max. (in.): | 3.829 | 3.830 | Actual Tolerance (%): | 0.445 |
| Recorded Min. (in.): | 3.827 | 3.820 | Results: | Pass |
| Results: | Pass | Pass | | |

Orifice Plate and Sealing Unit

| | Max. | Min. | Orifice Plate Thickness: | 0.125" | U/S | D/S |
|------------------|-------|-------|-----------------------------|--------|------------------------|-----|
| Beta Ratio: | 0.70 | 0.15 | Orifice Plate Eccentricity: | | Plate Seal Protrusion: | |
| Bore Size (in.): | 2.676 | 0.573 | Orifice Plate Bypass: | | Plate Seal Gap: | |

Internal Surface Roughness

Within 17D U/S of Plate: Pass
Beyond 17D U/S of Plate: Pass
Downstream of Plate: Pass

Meter Tube Configuration and Dimensions

Flow Conditioner or Vane: CPA 50E
1st. Downstream Connection: 3/4" NPT

Note: All dimensions are shown in inches unless specified otherwise.

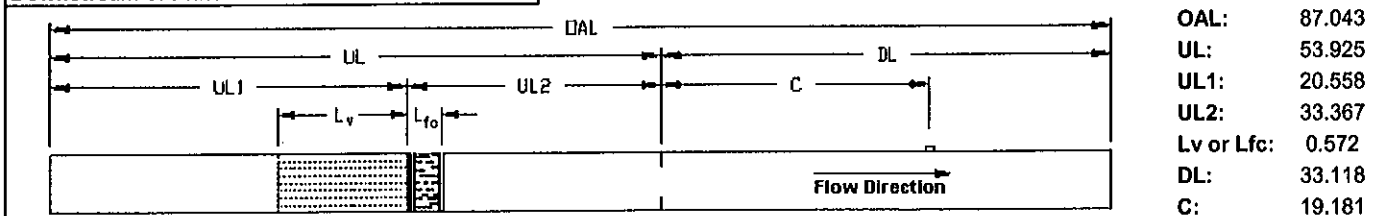

Orifice Fitting Information

Manufacturer: Daniel
Model No.: 015CTT
Serial No.: 13300050
ANSI Class: 600#

Quantity: 4 Sets
Diameter:
Location:
Size: 1/2"

Flange Tap Information

Flange Taps Relative to Center of Meter Tube: Horizontal

No. of DP Sensors: None

| Location | Tee'd |
|-------------------------|-------|
| Static Pressure Sensor: | None |
| | No |

Comments and Notes (indicate if attachments are included)

Inspection Kit No.: FI-2 NOA No: Sen G-0196 This meter DOES NOT correct for temperature or pressure

FLOW CONDITIONER: SN: 2350-066 HT#: 258277

Inspector: Jamie van der Laan
Signed/Dated:  Nov. 18, 2013.
Title: Inspector



Daniel Industries Canada Inc.
P.O. Box 727, Stn T (T2H 2H2)
4215 - 72 Avenue S.E.
Calgary, Alberta T2C 2G5
Canada

T 403-279-1879
F 403-236-1337
www.daniel.com

Meter Tube Nameplate Facsimile

For use with AGA Report 3/API 14.3, Part 2, Third and Fourth Editions

| | | | | | |
|--------------------------|-----------|----------------------------|----------------|-------------------|-----------------|
| DANIEL _____ | | Emerson Process Management | | Made in Canada | |
| DATE: | 11/18/13 | AGA FIG: | CPA50E 2000 | UL / DL: | 53.806"/33.078" |
| TAG: | | MAX BETA: | .70 | Dr: | 3.827" |
| DCM: | 13-01386 | MAX ORIFICE: | 2.679" | ANSI/DMT: | 600 -20°F |
| CRN: | OFO634.21 | MIN ORIFICE: | .574" | MAWP@TEMP | 1480PSI@100°F |
| Daniel Industries Canada | | Ph: 403-279-1879 | | Fax: 403-236-1337 | |

Daniel Canada WO: 7030908

Orifice Fitting S/N: 13210332

Rev 3, 2011-12-13





EMERSON
Process Management

Orifice Meter Inspection Certificate
AGA3/API 14.3, Part 2, 2000 Edition

DANIEL
Daniel Industries Canada Inc.

General Meter Tube Information

Customer Information

Customer: GADO INDUSTRIES INC
Address 1:
Address 2:
Customer P.O.: 2013-070-8302
Customer Job No.: 7030908
Meter Tag No.: N/A

Inspection Number: DCM13-01386
Meter Tube Serial No.:
Manufacturer: Daniel Canada
Inspection Criteria: AGA3/API 14.3, Part 2, 2000 Edition
AGA3 Configuration: CPA 50E
Nominal Line Size: 4"
Pipe Schedule: 80
Published I.D. (in.): 3.826"

Measured Internal Diameter of Meter Tube

| Position | I.D. Measurements 1" Upstream from the Upstream Face of Orifice Plate (in.) | Calculations | |
|----------|---|--------------|--|
| | 1 | 3.826 | Coefficient of Thermal Expansion, α_2 : 0.00000820 Meter Tube Temperature, T_m (°F): 61.8 Reference Temperature, T_r (°F): 68.0 Measured Meter Tube I.D., D_m (in.): 3.827 Calculated Meter Tube I.D., D_r (in.): 3.827 |
| | 2 | 3.827 | |
| | 3 | 3.827 | |
| | 4 | 3.826 | |

Verification of the Internal Diameter of the Meter Tube

Note: Internal diameter measurements are checked in a minimum of 4 equally spaced planes at various locations along the length of the meter tube. Max./Min. values for various sections of the meter tube are recorded below. Locations of these check measurements include the orifice fitting, welds, adjoining flanges and pipe.

| | Within $1D_m$ Upstream of Orifice Plate | Downstream | Entire Upstream Section | |
|-----------------------|---|------------|-------------------------|-------|
| Tolerance (in.): | 0.010 | 0.019 | Max. Tolerance (%): | 0.500 |
| Allowable Max. (in.): | 3.836 | 3.846 | Recorded Max. (in.): | 3.835 |
| Allowable Min. (in.): | 3.817 | 3.807 | Recorded Min. (in.): | 3.820 |
| Recorded Max. (in.): | 3.827 | 3.829 | Actual Tolerance (%): | 0.392 |
| Recorded Min. (in.): | 3.826 | 3.818 | Results: | Pass |
| Results: | Pass | Pass | | |

Orifice Plate and Sealing Unit

| | Max. | Min. | Orifice Plate Thickness: | 0.125" | U/S | D/S |
|------------------|-------|-------|-----------------------------|--------|------------------------|-----|
| Beta Ratio: | 0.70 | 0.15 | Orifice Plate Eccentricity: | | Plate Seal Protrusion: | |
| Bore Size (in.): | 2.679 | 0.574 | Orifice Plate Bypass: | | Plate Seal Gap: | |

Internal Surface Roughness

| | |
|----------------------------|------|
| Within $17D$ U/S of Plate: | Pass |
| Beyond $17D$ U/S of Plate: | Pass |
| Downstream of Plate: | Pass |

Meter Tube Configuration and Dimensions

| | |
|-----------------------------|----------|
| Flow Conditioner or Vane: | CPA 50E |
| 1st. Downstream Connection: | 3/4" NPT |

Note: All dimensions are shown in inches unless specified otherwise.

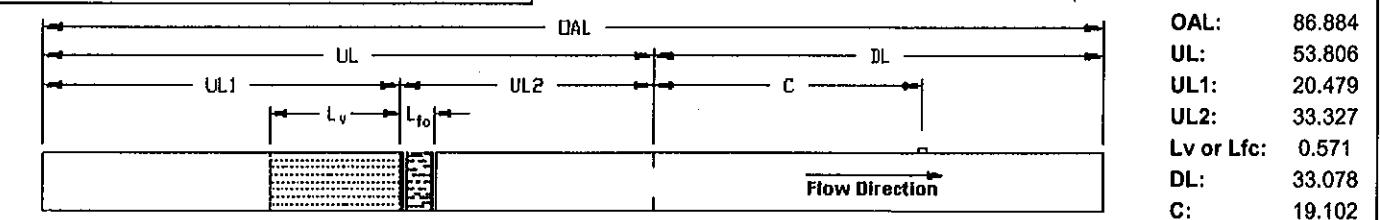

Orifice Fitting Information

Manufacturer: Daniel
Model No.: 015CTT
Serial No.: 13210332
ANSI Class: 600#
Quantity: 4 Sets
Diameter:
Location:
Size: 1/2"

Flange Tap Information

Flange Taps Relative to Center of Meter Tube: Horizontal
No. of DP Sensors: None
Static Pressure Sensor: None

| Location | Tee'd |
|----------|-------|
| None | No |

Comments and Notes (Indicate if attachments are included)

Inspection Kit No.: FI-2 NOA No.: Sen G-0196 This meter DOES NOT correct for temperature or pressure

FLOW CONDITIONER: SN: 2350-061 HT#: 258277

Inspector: Jamle van der Laan
Signed/Dated: *J. van der Laan* Nov. 18, 2013.
Title: Inspector



EMERSON
Process Management

Daniel Industries Canada Inc.
P.O. Box 727, Stn T (T2H 2H2)
4215 - 72 Avenue S.E.
Calgary, Alberta T2C 2G5
Canada

T 403-279-1879
F 403-236-1337
www.daniel.com

Meter Tube Nameplate Facsimile

For use with AGA Report 3/API 14.3, Part 2, Third and Fourth Editions

| | | | | | |
|--------------------------|-----------|----------------------------|----------------|-------------------|-----------------|
| DANIEL _____ | | Emerson Process Management | | Made in Canada | |
| DATE: | 11/18/13 | AGA FIG: | CPA50E 2000 | UL / DL: | 53.896"/33.078" |
| TAG: | | MAX BETA: | .70 | Dr: | 3.829" |
| DCM: | 13-01402 | MAX ORIFICE: | 2.680" | ANSI/DMT: | 600 -20°F |
| CRN: | OFO634.21 | MIN ORIFICE: | .574" | MAWP@TEMP | 1480PSI@100°F |
| Daniel Industries Canada | | Ph: 403-279-1879 | | Fax: 403-236-1337 | |

Daniel Canada WO: 7030908

Orifice Fitting S/N: 13340173

Rev 3, 2011-12-13

DANIEL®



EMERSON
Process Management

Orifice Meter Inspection Certificate
AGA3/API 14.3, Part 2, 2000 Edition

DANIEL
Daniel Industries Canada Inc.

| Customer Information | |
|----------------------|---------------------|
| Customer: | CADO INDUSTRIES INC |
| Address 1: | |
| Address 2: | |
| Customer P.O.: | 2013-070-8302 |
| Customer Job No.: | 7030908 |
| Meter Tag No.: | N/A |

| General Meter Tube Information | |
|--------------------------------|-------------------------------------|
| Inspection Number: | DCM13-01402 |
| Meter Tube Serial No.: | |
| Manufacturer: | Daniel Canada |
| Inspection Criteria: | AGA3/API 14.3, Part 2, 2000 Edition |
| AGA3 Configuration: | CPA 50E |
| Nominal Line Size: | 4" |
| Pipe Schedule: | 80 |
| Published I.D. (in.): | 3.828" |

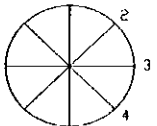
| Measured Internal Diameter of Meter Tube | | | |
|---|---|--------------|---|
| Position | I.D. Measurements 1" Upstream from the Upstream Face of Orifice Plate (in.) | Calculations | |
|  | 1 | 3.829 | Coefficient of Thermal Expansion, α_2 : 0.00000620 |
| | 2 | 3.829 | Meter Tube Temperature, T_m (°F): 61.8 |
| | 3 | 3.829 | Reference Temperature, T_r (°F): 68.0 |
| | 4 | 3.829 | Measured Meter Tube I.D., D_m (in.): 3.829 |
| | | | Calculated Meter Tube I.D., D_r (in.): 3.829 |

Verification of the Internal Diameter of the Meter Tube
Note: Internal diameter measurements are checked in a minimum of 4 equally spaced planes at various locations along the length of the meter tube. Max./Min. values for various sections of the meter tube are recorded below. Locations of these check measurements include the orifice fitting, welds, adjoining flanges and pipe.

| | Within 1D _m Upstream of Orifice Plate | Downstream | Entire Upstream Section | |
|-----------------------|--|------------|-------------------------|-------|
| Tolerance (in.): | 0.010 | 0.019 | Max. Tolerance (%): | 0.500 |
| Allowable Max. (in.): | 3.839 | 3.848 | Recorded Max. (in.): | 3.835 |
| Allowable Min. (in.): | 3.819 | 3.810 | Recorded Min. (in.): | 3.818 |
| Recorded Max. (in.): | 3.829 | 3.830 | Actual Tolerance (%): | 0.444 |
| Recorded Min. (in.): | 3.827 | 3.819 | Results: | Pass |
| Results: | Pass | Pass | | |

| Orifice Plate and Sealing Unit | | | | | |
|--------------------------------|-------|-------|-----------------------------|--------|------------------------|
| | Max. | Min. | Orifice Plate Thickness: | 0.125" | |
| Beta Ratio: | 0.70 | 0.15 | Orifice Plate Eccentricity: | | U/S D/S |
| Bore Size (in.): | 2.680 | 0.574 | Orifice Plate Bypass: | | Plate Seal Protrusion: |
| | | | | | Plate Seal Gap: |

| Internal Surface Roughness | | Meter Tube Configuration and Dimensions | |
|----------------------------|------|--|----------|
| Within 17D U/S of Plate: | Pass | Flow Conditioner or Vane: | CPA 50E |
| Beyond 17D U/S of Plate: | Pass | 1st. Downstream Connection: | 3/4" NPT |
| Downstream of Plate: | Pass | Note: All dimensions are shown in inches unless specified otherwise. | |

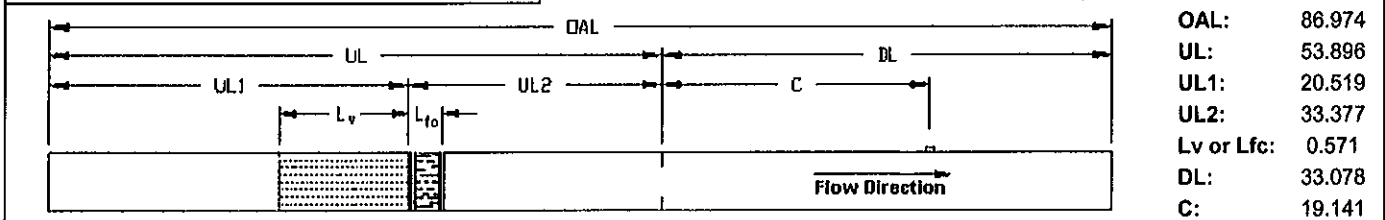

| Orifice Fitting Information | | Flange Tap Information | |
|-----------------------------|----------|---|------------|
| Manufacturer: | Daniel | Quantity: | 4 Sets |
| Model No.: | 015CTT | Flange Taps Relative to Center of Meter Tube: | Horizontal |
| Serial No.: | 13340173 | Diameter: | |
| ANSI Class: | 600# | Location: | |
| | | Size: | 1/2" |
| | | No. of DP Sensors: | None |
| | | Static Pressure Sensor: | None |
| | | Location: | |
| | | Tee'd: | No |

Comments and Notes (indicate if attachments are included)
Inspection Kit No.: FI-2 NOA No: Sen G-0196 This meter DOES NOT correct for temperature or pressure
FLOW CONDITIONER: SN: 2350-059 HT#: 258277

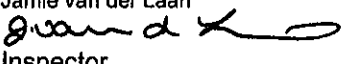
Inspector: **Jamie van der Laan**
Signed/Dated:  Nov. 18, 2013.
Title: Inspector



Daniel Industries Canada Inc.
P.O. Box 727, Stn T (T2H 2H2)
4215 – 72 Avenue S.E.
Calgary, Alberta T2C 2G5
Canada

T 403-279-1879
F 403-236-1337
www.daniel.com

Meter Tube Nameplate Facsimile

For use with AGA Report 3/API 14.3, Part 2, Third and Fourth Editions

| | | |
|--------------------------|----------------------------|--------------------------|
| DANIEL _____ | Emerson Process Management | Made in Canada |
| DATE: 11/18/13 | AGA FIG: CPA50E 2000 | UL / DL: 53.964"/33.078" |
| TAG: | MAX BETA: .70 | Dr: 3.828" |
| DCM: 13-01389 | MAX ORIFICE: 2.679" | ANSI/DMT: 600 -20°F |
| CRN: OFO634.21 | MIN ORIFICE: .574" | MAWP@TEMP 1480PSI@100°F |
| Daniel Industries Canada | Ph: 403-279-1879 | Fax: 403-236-1337 |

Daniel Canada WO: 7030908

Orifice Fitting S/N: 13250528

Rev 3, 2011-12-13

DANIEL®



EMERSON
Process Management

Orifice Meter Inspection Certificate
AGA3/API 14.3, Part 2, 2000 Edition

DANIEL
Daniel Industries Canada Inc.

| Customer Information | | General Meter Tube Information | |
|----------------------|---------------------|--------------------------------|-------------------------------------|
| Customer: | CADO INDUSTRIES INC | Inspection Number: | DCM13-01389 |
| Address 1: | | Meter Tube Serial No.: | |
| Address 2: | | Manufacturer: | Daniel Canada |
| Customer P.O.: | 2013-070-8302 | Inspection Criteria: | AGA3/API 14.3, Part 2, 2000 Edition |
| Customer Job No.: | 7030908 | AGA3 Configuration: | CPA 50E |
| Meter Tag No.: | N/A | Nominal Line Size: | 4" |
| | | Pipe Schedule: | 80 |
| | | Published I.D. (in.): | 3.826" |

| Measured Internal Diameter of Meter Tube | | | | |
|--|---|--------------|--|--|
| Position | I.D. Measurements 1" Upstream from the Upstream Face of Orifice Plate (in.) | Calculations | | |
| | | | | Coefficient of Thermal Expansion, α_2 : |
| | 1 | 3.828 | Meter Tube Temperature, T_m (°F): | 61.8 |
| | 2 | 3.828 | Reference Temperature, T_r (°F): | 68.0 |
| | 3 | 3.827 | Measured Meter Tube I.D., D_m (in.): | 3.828 |
| | 4 | 3.827 | Calculated Meter Tube I.D., D_r (in.): | 3.828 |

| Verification of the Internal Diameter of the Meter Tube | | | | |
|---|--|------------|-------------------------|-------|
| Note: Internal diameter measurements are checked in a minimum of 4 equally spaced planes at various locations along the length of the meter tube. Max./Min. values for various sections of the meter tube are recorded below. Locations of these check measurements include the orifice fitting, welds, adjoining flanges and pipe. | | | | |
| | Within 1D _m Upstream of Orifice Plate | Downstream | Entire Upstream Section | |
| Tolerance (in.): | 0.010 | 0.019 | Max. Tolerance (%): | 0.500 |
| Allowable Max. (in.): | 3.837 | 3.847 | Recorded Max. (in.): | 3.835 |
| Allowable Min. (in.): | 3.818 | 3.808 | Recorded Min. (in.): | 3.818 |
| Recorded Max. (in.): | 3.826 | 3.828 | Actual Tolerance (%): | 0.444 |
| Recorded Min. (in.): | 3.826 | 3.820 | Results: | Pass |
| Results: | Pass | Pass | | |

| Orifice Plate and Sealing Unit | | | | | | |
|--------------------------------|-------|-------|-----------------------------|--------|------------------------|-----|
| | Max. | Min. | Orifice Plate Thickness: | 0.125" | U/S | D/S |
| Beta Ratio: | 0.70 | 0.15 | Orifice Plate Eccentricity: | | Plate Seal Protrusion: | |
| Bore Size (in.): | 2.679 | 0.574 | Orifice Plate Bypass: | | Plate Seal Gap: | |

| Internal Surface Roughness | | Meter Tube Configuration and Dimensions | |
|----------------------------|------|--|----------|
| Within 17D U/S of Plate: | Pass | Flow Conditioner or Vane: | CPA 50E |
| Beyond 17D U/S of Plate: | Pass | 1st. Downstream Connection: | 3/4" NPT |
| Downstream of Plate: | Pass | Note: All dimensions are shown in inches unless specified otherwise. | |
| | | | |
| | | OAL: | 87.042 |
| | | UL: | 53.964 |
| | | UL1: | 20.597 |
| | | UL2: | 33.367 |
| | | Lv or Lfc: | 0.570 |
| | | DL: | 33.078 |
| | | C: | 19.141 |

| Orifice Fitting Information | | Flange Tap Information | |
|-----------------------------|----------|---|------------|
| Manufacturer: | Daniel | Quantity: | 4 Sets |
| Model No.: | 015CTT | Flange Taps Relative to Center of Meter Tube: | Horizontal |
| Serial No.: | 13250528 | No. of DP Sensors: | None |
| ANSI Class: | 600# | Location: | |
| | | Static Pressure Sensor: | None |
| | | Size: | 1/2" |
| | | Tee'd: | No |

Comments and Notes (indicate if attachments are included)

Inspection Kit No.: FI-2 NOA No: Sen G-0196 This meter DOES NOT correct for temperature or pressure

FLOW CONDITIONER: SN: 2350-048 HT#: 258277

Inspector: Jamie van der Laan
Signed/Dated: *J van der Laan* Nov. 18, 2013.
Title: Inspector



SECTION 2:
MTR'S



ANHUI YINGLIU ELECTROMECHANICAL CO.,LTD

INSPECTION CERTIFICATE

ADD:No.96 Pihe Road,Huo shan County,Anhui Province, China
TEL:0086-564-5036508 FAX:0086-564-5036500

Inspection Certificate (EN 10204-3.1)

Certificate-No.: 2013-02-017U

Customer: Daniel Measurement and Control

Date: 2013.02.26

Order-No.:287056-000-1

Pattern No:015-4C

Article:4"600 old SR Body

Part No.:1-601-61-077

Specification: MTL-A216-01 REV.B

Material: ASTM A216 WCB NACE MR0175

Melting process-Heat Treatment:+N 920°C*2.5h

A)Chemical analysis

| Heat No. | Qty. | C % | Mn % | Si % | P % | S % | Cr % | Mo % | NI % | Cu % | V % |
|---------------|------|------|------|------|-------|-------|-------|-------|-------|-------|-------|
| ASTM A216 WCB | | 0.25 | 1.00 | 0.60 | 0.040 | 0.045 | 0.50 | 0.20 | 0.50 | 0.30 | 0.030 |
| E1697 | 1 | 0.23 | 0.95 | 0.48 | 0.023 | 0.014 | 0.093 | 0.030 | 0.058 | 0.032 | 0.006 |
| E1704 | 1 | 0.21 | 0.93 | 0.41 | 0.019 | 0.014 | 0.001 | 0.007 | 0.021 | 0.024 | 0.006 |
| E1714 | 1 | 0.22 | 0.95 | 0.49 | 0.021 | 0.016 | 0.038 | 0.017 | 0.034 | 0.023 | 0.006 |
| E1727 | 1 | 0.23 | 0.92 | 0.44 | 0.021 | 0.014 | 0.004 | 0.009 | 0.058 | 0.026 | 0.011 |
| E1734 | 2 | 0.20 | 0.89 | 0.45 | 0.022 | 0.016 | 0.028 | 0.010 | 0.036 | 0.028 | 0.006 |
| E1749 | 3 | 0.21 | 0.88 | 0.47 | 0.022 | 0.016 | 0.106 | 0.050 | 0.068 | 0.025 | 0.009 |
| E1761 | 1 | 0.20 | 0.88 | 0.40 | 0.022 | 0.017 | 0.077 | 0.001 | 0.024 | 0.020 | 0.004 |
| E1763 | 6 | 0.21 | 0.96 | 0.40 | 0.022 | 0.017 | 0.044 | 0.015 | 0.030 | 0.031 | 0.007 |
| E1767 | 2 | 0.21 | 0.96 | 0.40 | 0.022 | 0.017 | 0.044 | 0.015 | 0.030 | 0.031 | 0.007 |
| E1802 | 1 | 0.23 | 0.95 | 0.48 | 0.023 | 0.014 | 0.093 | 0.030 | 0.058 | 0.032 | 0.006 |
| E1804 | 4 | 0.21 | 0.94 | 0.41 | 0.021 | 0.014 | 0.172 | 0.041 | 0.117 | 0.047 | 0.008 |
| E1814 | 4 | 0.22 | 0.94 | 0.48 | 0.023 | 0.018 | 0.020 | 0.005 | 0.059 | 0.032 | 0.008 |
| E1821 | 3 | 0.21 | 0.88 | 0.47 | 0.022 | 0.016 | 0.106 | 0.050 | 0.068 | 0.025 | 0.009 |
| E1824 | 1 | 0.22 | 0.94 | 0.48 | 0.023 | 0.018 | 0.020 | 0.005 | 0.059 | 0.032 | 0.008 |
| E1827 | 5 | 0.21 | 0.93 | 0.42 | 0.021 | 0.014 | 0.021 | 0.007 | 0.047 | 0.026 | 0.007 |
| E1831 | 1 | 0.23 | 0.92 | 0.44 | 0.023 | 0.015 | 0.082 | 0.005 | 0.061 | 0.022 | 0.006 |
| E1837 | 7 | 0.21 | 0.93 | 0.42 | 0.021 | 0.014 | 0.021 | 0.007 | 0.047 | 0.028 | 0.007 |

B)Mechanical Property

| Heat No. | Test Temp | Pouring Date | Rp 0.2 Proof Strength | Tensile Strength | Elongation | Reduction | Hardness | Energy Charpy Impact | |
|---------------|-----------|--------------|-----------------------|------------------|------------|-----------|----------|----------------------|-----|
| | | | | | | | | Joule | φ |
| ASTM A216 WCB | | | ≥250 | 485-655 | ≥22 | ≥35 | ≤235 | | N/A |
| E1697 | RT | 2013.01.24 | 325 | 530 | 28 | 47 | 159 | | |
| E1704 | RT | 2013.01.17 | 340 | 515 | 28 | 55 | 156 | | |
| E1714 | RT | 2013.01.19 | 320 | 520 | 27 | 47 | 149 | | |
| E1727 | RT | 2013.01.21 | 390 | 570 | 29 | 41 | 156 | | |
| E1734 | RT | 2013.01.23 | 385 | 530 | 30 | 53 | 146 | | |
| E1749 | RT | 2013.01.24 | 325 | 530 | 26 | 47 | 143 | | |
| E1761 | RT | 2013.01.22 | 370 | 520 | 28 | 47 | 159 | | |
| E1763 | RT | 2013.01.23 | 335 | 520 | 26 | 46 | 149 | | |
| E1767 | RT | 2013.01.23 | 310 | 515 | 28 | 42 | 159 | | |
| E1802 | RT | 2013.01.24 | 470 | 575 | 28 | 52 | 152 | | |
| E1804 | RT | 2013.01.26 | 330 | 530 | 26 | 48 | 163 | | |
| E1814 | RT | 2013.01.25 | 310 | 505 | 28 | 50 | 159 | | |
| E1821 | RT | 2013.01.24 | 375 | 555 | 28 | 42 | 159 | | |
| E1824 | RT | 2013.01.25 | 330 | 530 | 27 | 53 | 149 | | |
| E1827 | RT | 2013.01.26 | 355 | 550 | 31 | 58 | 167 | | |
| E1831 | RT | 2013.01.23 | 325 | 505 | 29 | 55 | 149 | | |
| E1837 | RT | 2013.01.26 | 325 | 530 | 28 | 50 | 159 | | |

C) Dimensional check and NDT

| Testing | Details | Result |
|---------------------------|-----------|--------|
| Visual Inspection | MSS-SP-55 | OK |
| Dimension Inspection | DWG | OK |
| Surface crack examination | MSS-SP-53 | OK |

D) Delivery Condition: N

We hereby certify that the material was manufactured, Sampled, tested and inspected in accordance with the material specification and customer requirements and was found to meet the requirement.

Place: *Wuhan*

Date: 2013.02.26

Work Inspector: *Chen Can*

ANHUI YINGLIU ELECTROMECHANICAL CO.,LTD

INSPECTION CERTIFICATE

ADD:No.96 Pihe Road,Huo shan County,Anhui Province, China

TEL:0086-564-5036508 FAX:0086-564-5036500

Inspection Certificate (EN 10204-3.1)

Certificate-No.: 2013-05-037U

Customer: Daniel Measurement and Control

Order-No.:293091-000-1

Date: 2013.05.14

Article:4"600 old SR Body

Pattern No:015-4C

Specification: MTL-A216-01 REV.B

Part No.:1-601-61-077

Material: ASTM A216 WCB NACE MR0175

Melting process-Heat Treatment:+N 920°C*2.5h

A)Chemical analysis

| Heat No. | Qty. | C % | Mn % | Si % | P % | S % | Cr % | Mo % | Ni % | Cu % | V % |
|---------------|------|------|------|------|-------|-------|-------|-------|-------|-------|-------|
| ASTM A216 WCB | | 0.25 | 1.00 | 0.60 | 0.040 | 0.045 | 0.50 | 0.20 | 0.50 | 0.30 | 0.030 |
| E2344 | 5 | 0.21 | 0.95 | 0.45 | 0.020 | 0.015 | 0.024 | 0.006 | 0.061 | 0.027 | 0.005 |
| E2347 | 6 | 0.22 | 0.87 | 0.45 | 0.023 | 0.017 | 0.001 | 0.001 | 0.051 | 0.022 | 0.005 |
| E2352 | 1 | 0.22 | 0.96 | 0.48 | 0.019 | 0.010 | 0.102 | 0.011 | 0.029 | 0.020 | 0.007 |
| E2357 | 7 | 0.20 | 0.91 | 0.46 | 0.019 | 0.012 | 0.016 | 0.009 | 0.066 | 0.024 | 0.004 |
| E2364 | 4 | 0.21 | 0.93 | 0.40 | 0.017 | 0.010 | 0.147 | 0.061 | 0.043 | 0.021 | 0.008 |
| E2371 | 7 | 0.21 | 0.96 | 0.47 | 0.020 | 0.012 | 0.001 | 0.014 | 0.023 | 0.021 | 0.008 |
| E2374 | 8 | 0.21 | 0.98 | 0.55 | 0.024 | 0.013 | 0.024 | 0.014 | 0.049 | 0.026 | 0.007 |
| E2377 | 4 | 0.21 | 0.91 | 0.41 | 0.020 | 0.013 | 0.062 | 0.024 | 0.072 | 0.028 | 0.006 |
| E2387 | 7 | 0.21 | 0.97 | 0.44 | 0.020 | 0.014 | 0.040 | 0.027 | 0.067 | 0.021 | 0.014 |
| E2392 | 1 | 0.22 | 0.94 | 0.44 | 0.024 | 0.014 | 0.063 | 0.017 | 0.041 | 0.029 | 0.007 |
| E2397 | 5 | 0.21 | 0.94 | 0.54 | 0.022 | 0.013 | 0.021 | 0.002 | 0.001 | 0.000 | 0.005 |
| E2404 | 11 | 0.21 | 0.91 | 0.42 | 0.021 | 0.011 | 0.047 | 0.018 | 0.023 | 0.026 | 0.011 |
| E2412 | 1 | 0.22 | 0.96 | 0.46 | 0.021 | 0.010 | 0.065 | 0.009 | 0.022 | 0.021 | 0.011 |
| E2414 | 9 | 0.21 | 0.98 | 0.47 | 0.019 | 0.010 | 0.034 | 0.020 | 0.048 | 0.023 | 0.005 |
| E2417 | 10 | 0.22 | 0.87 | 0.45 | 0.023 | 0.017 | 0.001 | 0.001 | 0.051 | 0.022 | 0.005 |
| E2424 | 9 | 0.22 | 0.97 | 0.47 | 0.020 | 0.011 | 0.055 | 0.013 | 0.074 | 0.020 | 0.007 |

B)Mechanical Property

| Heat No. | Test Temp | Pouring Date | Rp 0.2 Proof Strength | Tensile Strength | Elongation | Reduction | Hardness | Energy Charpy Impact | |
|---------------|-----------|--------------|-----------------------|------------------|------------|-----------|----------|----------------------|---|
| | | | | | | | | Joule | φ |
| | | | MPA | MPA | % | % | HB | | |
| ASTM A216 WCB | | | ≥260 | 485-655 | ≥22 | ≥35 | ≤235 | N/A | |
| E2344 | RT | 2013.04.22 | 360 | 530 | 28 | 46 | 152 | | |
| E2347 | RT | 2013.04.26 | 320 | 530 | 27 | 49 | 159 | | |
| E2352 | RT | 2013.04.21 | 300 | 520 | 27 | 51 | 143 | | |
| E2357 | RT | 2013.04.23 | 330 | 530 | 26 | 50 | 159 | | |
| E2364 | RT | 2013.04.23 | 325 | 620 | 27 | 42 | 156 | | |
| E2371 | RT | 2013.04.27 | 330 | 535 | 25 | 48 | 159 | | |
| E2374 | RT | 2013.04.28 | 325 | 530 | 27 | 50 | 159 | | |
| E2377 | RT | 2013.04.29 | 310 | 515 | 28 | 42 | 156 | | |
| E2387 | RT | 2013.04.30 | 320 | 535 | 25 | 53 | 152 | | |
| E2392 | RT | 2013.05.04 | 325 | 530 | 27 | 53 | 152 | | |
| E2397 | RT | 2013.05.05 | 315 | 490 | 28 | 49 | 159 | | |
| E2404 | RT | 2013.04.26 | 320 | 620 | 27 | 47 | 152 | | |
| E2412 | RT | 2013.04.19 | 320 | 540 | 25 | 46 | 163 | | |
| E2414 | RT | 2013.04.24 | 330 | 540 | 25 | 52 | 163 | | |
| E2417 | RT | 2013.04.25 | 320 | 530 | 28 | 47 | 146 | | |
| E2424 | RT | 2013.04.28 | 315 | 520 | 26 | 47 | 156 | | |

C) Dimensional check and NDT

| Testing | Details | Result |
|---------------------------|-----------|--------|
| Visual inspection | MSS-SP-55 | OK |
| Dimension inspection | DWG | OK |
| Surface crack examination | MSS-SP-53 | OK |

D) Delivery Condition: N

We hereby certify that the material was manufactured. Sampled, tested and inspected in accordance with the material specification and customer requirements and was found to meet the requirement.

Place: *Wuhan*

Date: 2013.05.14

Work Inspector: *Chen Can*

ANHUI YINGLIU ELECTROMECHANICAL CO.,LTD

INSPECTION CERTIFICATE

ADD:No.96 Pihe Road,Huo shan County,Anhui Province, China
 TEL:0086-564-5036508 FAX:0086-564-5036500

Inspection Certificate (EN 10204-3.1)

Certificate-No.: 2013-04-010U

Customer: Daniel Measurement and Control

Order-No.:291097-000-1

Date: 2013.04.08

Article:4"600 old SR Body

Pattern No:015-4C

Specification: MTL-A216-01 REV.B

Part No.:1-801-61-077

Material: ASTM A216 WCB NACE MR0175

Melting process-Heat Treatment:+N 920°C*2.5h

A)Chemical analysis

| Heat No. | Qty. | C % | Mn % | Si % | P % | S % | Cr % | Mo % | Ni % | Cu % | V % |
|---------------|------|--------|------|------|-------|-------|-------|-------|-------|-------|-------|
| ASTM A216 WCB | | ≤ 0.25 | 1.00 | 0.60 | 0.040 | 0.045 | 0.50 | 0.20 | 0.50 | 0.30 | 0.030 |
| E1637 | 1 | 0.22 | 0.89 | 0.45 | 0.023 | 0.015 | 0.075 | 0.027 | 0.076 | 0.025 | 0.006 |
| E1827 | 1 | 0.21 | 0.93 | 0.42 | 0.021 | 0.014 | 0.021 | 0.007 | 0.047 | 0.028 | 0.007 |
| E1864 | 1 | 0.23 | 0.91 | 0.49 | 0.019 | 0.010 | 0.001 | 0.018 | 0.046 | 0.022 | 0.009 |
| E1872 | 1 | 0.22 | 0.99 | 0.48 | 0.023 | 0.015 | 0.001 | 0.010 | 0.044 | 0.022 | 0.007 |
| E1879 | 1 | 0.24 | 0.96 | 0.43 | 0.020 | 0.014 | 0.025 | 0.012 | 0.049 | 0.029 | 0.007 |
| E1892 | 2 | 0.22 | 0.99 | 0.48 | 0.023 | 0.015 | 0.001 | 0.010 | 0.044 | 0.022 | 0.007 |
| E1897 | 3 | 0.21 | 0.90 | 0.42 | 0.020 | 0.012 | 0.047 | 0.012 | 0.039 | 0.029 | 0.009 |
| E1899 | 6 | 0.21 | 0.94 | 0.40 | 0.022 | 0.014 | 0.015 | 0.011 | 0.043 | 0.023 | 0.006 |
| E1902 | 2 | 0.20 | 0.94 | 0.44 | 0.020 | 0.014 | 0.001 | 0.024 | 0.046 | 0.018 | 0.008 |
| E1904 | 1 | 0.21 | 0.96 | 0.45 | 0.022 | 0.014 | 0.042 | 0.020 | 0.039 | 0.022 | 0.009 |
| E1907 | 1 | 0.21 | 0.90 | 0.42 | 0.020 | 0.012 | 0.047 | 0.012 | 0.039 | 0.029 | 0.009 |
| E2001 | 4 | 0.22 | 1.00 | 0.44 | 0.022 | 0.013 | 0.001 | 0.005 | 0.074 | 0.025 | 0.007 |
| E2004 | 5 | 0.21 | 0.95 | 0.40 | 0.021 | 0.014 | 0.052 | 0.008 | 0.122 | 0.029 | 0.006 |
| E2017 | 3 | 0.21 | 0.91 | 0.44 | 0.023 | 0.014 | 0.004 | 0.011 | 0.177 | 0.024 | 0.007 |

B)Mechanical Property

| Heat No. | Test Temp | Pouring Date | Rp 0.2 Proof Strength | Tensile Strength | Elongation | Reduction | Hardness | Energy Charpy Impact | | |
|---------------|-----------|--------------|-----------------------|------------------|------------|-----------|----------|----------------------|--|-----|
| | | | MPA | MPA | % | % | HB | Joule | | φ |
| ASTM A216 WCB | | | ≥250 | 485-655 | ≥22 | ≥35 | ≤235 | | | N/A |
| E1637 | RT | 2013.01.13 | 330 | 530 | 28 | 47 | 152 | | | |
| E1827 | RT | 2013.01.26 | 355 | 550 | 31 | 58 | 167 | | | |
| E1864 | RT | 2013.01.31 | 335 | 520 | 26 | 46 | 156 | | | |
| E1872 | RT | 2013.02.01 | 320 | 530 | 27 | 44 | 143 | | | |
| E1879 | RT | 2013.02.03 | 345 | 530 | 28 | 49 | 156 | | | |
| E1892 | RT | 2013.02.01 | 330 | 520 | 26 | 47 | 143 | | | |
| E1897 | RT | 2013.02.06 | 315 | 490 | 29 | 45 | 152 | | | |
| E1899 | RT | 2013.02.23 | 340 | 550 | 26 | 42 | 156 | | | |
| E1902 | RT | 2013.02.02 | 330 | 535 | 26 | 48 | 163 | | | |
| E1904 | RT | 2013.02.05 | 320 | 530 | 27 | 47 | 143 | | | |
| E1907 | RT | 2013.02.06 | 330 | 535 | 27 | 48 | 159 | | | |
| E2001 | RT | 2013.03.26 | 330 | 535 | 27 | 48 | 156 | | | |
| E2004 | RT | 2013.03.27 | 340 | 530 | 27 | 43 | 159 | | | |
| E2017 | RT | 2013.03.25 | 315 | 530 | 27 | 45 | 159 | | | |

C) Dimensional check and NDT

| Testing | Details | Result |
|---------------------------|-----------|--------|
| Visual inspection | MSS-SP-55 | OK |
| Dimension inspection | DWG | OK |
| Surface crack examination | MSS-SP-53 | OK |

D) Delivery Condition: N

We hereby certify that the material was manufactured. Sampled, tested and inspected in accordance with the material specification and customer requirements and was found to meet the requirement.

Place: *Wuhan*

Date: 2013.04.08

Work Inspector: *Chen Can*

ANHUI YINGLIU ELECTROMECHANICAL CO.,LTD

INSPECTION CERTIFICATE

ADD:No.96 Pihe Road, Huo shan County, Anhui Province, China

TEL:0086-564-5036508 FAX:0086-564-5036500

Inspection Certificate (EN 10204-3.1)

Certificate-No.: 2013-05-075U

Customer: Danlei Measurement and Control

Order-No.:293624-000-1

Date: 2013.05.28

Article:4"150-600 old SR Top

Pattern No:150-600-4T

Specification: MTL-A216-01 REV.B

Part No.:1-601-01-423

Material: ASTM A216 WCB NACE MR0175

Melting process-Heat Treatment:+N 920°C*2.5h

A)Chemical analysis

| Heat No. | Qty. | C % | Mn % | Si % | P % | S % | Cr % | Mo % | Ni % | Cu % | V % |
|---------------|------|--------|------|------|-------|-------|-------|-------|-------|-------|-------|
| ASTM A216 WCB | | ≤ 0.25 | 1.00 | 0.60 | 0.040 | 0.045 | 0.50 | 0.20 | 0.50 | 0.30 | 0.030 |
| E2061 | 1 | 0.21 | 0.97 | 0.46 | 0.025 | 0.014 | 0.052 | 0.008 | 0.125 | 0.028 | 0.007 |
| E2083 | 1 | 0.22 | 0.98 | 0.42 | 0.025 | 0.017 | 0.104 | 0.007 | 0.093 | 0.035 | 0.007 |
| E2104 | 4 | 0.22 | 0.90 | 0.42 | 0.018 | 0.010 | 0.160 | 0.048 | 0.068 | 0.029 | 0.014 |
| E2109 | 4 | 0.23 | 0.90 | 0.38 | 0.023 | 0.016 | 0.082 | 0.005 | 0.020 | 0.042 | 0.005 |
| E2142 | 6 | 0.21 | 0.91 | 0.41 | 0.023 | 0.012 | 0.061 | 0.005 | 0.030 | 0.021 | 0.005 |
| E2147 | 1 | 0.21 | 0.96 | 0.46 | 0.023 | 0.016 | 0.075 | 0.006 | 0.117 | 0.032 | 0.006 |
| E2185 | 3 | 0.22 | 0.93 | 0.39 | 0.022 | 0.012 | 0.050 | 0.004 | 0.014 | 0.022 | 0.006 |
| E2214 | 1 | 0.21 | 0.94 | 0.41 | 0.021 | 0.015 | 0.005 | 0.009 | 0.099 | 0.025 | 0.004 |
| E2216 | 3 | 0.22 | 0.93 | 0.42 | 0.025 | 0.013 | 0.048 | 0.003 | 0.009 | 0.016 | 0.006 |
| E2218 | 4 | 0.22 | 0.96 | 0.42 | 0.021 | 0.013 | 0.056 | 0.007 | 0.015 | 0.018 | 0.004 |
| E2226 | 2 | 0.20 | 0.89 | 0.39 | 0.020 | 0.012 | 0.063 | 0.011 | 0.016 | 0.012 | 0.006 |
| E2232 | 2 | 0.21 | 0.96 | 0.37 | 0.022 | 0.012 | 0.072 | 0.009 | 0.021 | 0.024 | 0.006 |
| E2247 | 2 | 0.22 | 0.94 | 0.42 | 0.024 | 0.013 | 0.054 | 0.009 | 0.015 | 0.013 | 0.007 |
| E2255 | 1 | 0.22 | 0.86 | 0.38 | 0.023 | 0.012 | 0.059 | 0.008 | 0.014 | 0.010 | 0.005 |
| E2323 | 2 | 0.20 | 0.99 | 0.45 | 0.017 | 0.008 | 0.116 | 0.039 | 0.054 | 0.042 | 0.010 |
| E2375 | 1 | 0.23 | 0.92 | 0.43 | 0.021 | 0.011 | 0.081 | 0.008 | 0.025 | 0.015 | 0.005 |
| E2412 | 1 | 0.22 | 0.96 | 0.46 | 0.021 | 0.010 | 0.065 | 0.009 | 0.022 | 0.021 | 0.011 |
| E2459 | 1 | 0.21 | 0.99 | 0.36 | 0.021 | 0.011 | 0.088 | 0.015 | 0.050 | 0.023 | 0.006 |

B)Mechanical Property

| Heat No. | Test Temp | Pouring Date | Rp 0.2 Proof Strength | Tensile Strength | | Elongation | Reduction | Hardness | Energy Charpy Impact | |
|---------------|-----------|--------------|-----------------------|------------------|-----|------------|-----------|----------|----------------------|-----|
| | | | | MPA | MPA | | | | Joule | φ |
| ASTM A216 WCB | | | ≥260 | 485-655 | ≥22 | ≥35 | ≤235 | | | N/A |
| E2061 | RT | 2013.03.24 | 360 | 540 | 26 | 53 | 163 | | | |
| E2083 | RT | 2013.03.27 | 310 | 530 | 28 | 53 | 159 | | | |
| E2104 | RT | 2013.03.29 | 440 | 570 | 32 | 66 | 170 | | | |
| E2109 | RT | 2013.03.30 | 320 | 530 | 26 | 54 | 149 | | | |
| E2142 | RT | 2013.03.29 | 340 | 540 | 26 | 52 | 163 | | | |
| E2147 | RT | 2013.03.27 | 345 | 535 | 27 | 51 | 146 | | | |
| E2185 | RT | 2013.04.05 | 320 | 530 | 27 | 53 | 159 | | | |
| E2214 | RT | 2013.04.12 | 320 | 515 | 26 | 50 | 159 | | | |
| E2216 | RT | 2013.04.05 | 335 | 520 | 29 | 47 | 156 | | | |
| E2218 | RT | 2013.04.08 | 320 | 530 | 26 | 49 | 156 | | | |
| E2226 | RT | 2013.04.10 | 325 | 520 | 26 | 47 | 152 | | | |
| E2232 | RT | 2013.04.10 | 350 | 535 | 25 | 49 | 159 | | | |
| E2247 | RT | 2013.04.09 | 355 | 505 | 32 | 66 | 159 | | | |
| E2255 | RT | 2013.04.09 | 345 | 515 | 32 | 67 | 149 | | | |
| E2323 | RT | 2013.04.13 | 360 | 520 | 27 | 53 | 149 | | | |
| E2375 | RT | 2013.04.20 | 360 | 540 | 25 | 47 | 163 | | | |
| E2412 | RT | 2013.04.19 | 320 | 540 | 25 | 46 | 163 | | | |
| E2459 | RT | 2013.04.25 | 330 | 530 | 26 | 47 | 156 | | | |

C) Dimensional check and NDT

| Testing | Details | Result |
|---------------------------|-----------|--------|
| Visual Inspection | MSS-SP-55 | OK |
| Dimension inspection | DWG | OK |
| Surface crack examination | MSS-SP-53 | OK |

D) Delivery Condition: N

We hereby certify that the material was manufactured. Sampled, tested and inspected in accordance with the material specification and customer requirements and was found to meet the requirement.

Place: *Wang*

Date: 2013.05.28

Work Inspector: *Chen Can*

ANHUI YINGLIU ELECTROMECHANICAL CO.,LTD

INSPECTION CERTIFICATE

ADD:No.96 Pihe Road, Huo shan County,Anhui Province, China
 TEL:0086-564-5036508 FAX:0086-564-5036500

Inspection Certificate (EN 10204-3.1)

Certificate-No.: 2013-04-024U

Customer: Daniel Measurement and Control

Order-No.:291096-000-1

Date: 2013.04.16

Article:4"150-600 old SR Top

Pattern No:150-600-4T

Specification: MTL-A216-01 REV.B

Part No.:1-601-01-423

Material: ASTM A216 WCB NACE MR0175

Melting process-Heat Treatment:+N 920°C*2.5h

A)Chemical analysis

| Heat No. | Qty. | C % | Mn % | Si % | P % | S % | Cr % | Mo % | Ni % | Cu % | V % | |
|---------------|------|------|------|------|-------|-------|-------|-------|-------|-------|-------|-------|
| ASTM A216 WCB | | ≤ | 0.25 | 1.00 | 0.60 | 0.040 | 0.045 | 0.50 | 0.20 | 0.50 | 0.30 | 0.030 |
| E1982 | 4 | 0.21 | 0.97 | 0.46 | 0.018 | 0.013 | 0.016 | 0.006 | 0.071 | 0.030 | 0.004 | |
| E1995 | 1 | 0.22 | 0.93 | 0.41 | 0.023 | 0.014 | 0.085 | 0.019 | 0.024 | 0.021 | 0.012 | |
| E2003 | 1 | 0.22 | 0.88 | 0.36 | 0.022 | 0.014 | 0.046 | 0.004 | 0.010 | 0.014 | 0.005 | |
| E2043 | 9 | 0.20 | 0.93 | 0.39 | 0.023 | 0.011 | 0.064 | 0.007 | 0.020 | 0.019 | 0.006 | |
| E2046 | 2 | 0.21 | 0.89 | 0.36 | 0.018 | 0.011 | 0.049 | 0.006 | 0.018 | 0.017 | 0.011 | |
| E2055 | 4 | 0.21 | 0.97 | 0.46 | 0.025 | 0.014 | 0.052 | 0.008 | 0.125 | 0.028 | 0.007 | |
| E2061 | 1 | 0.21 | 0.97 | 0.46 | 0.025 | 0.014 | 0.052 | 0.008 | 0.125 | 0.028 | 0.007 | |
| E2073 | 4 | 0.21 | 0.93 | 0.47 | 0.023 | 0.016 | 0.001 | 0.007 | 0.001 | 0.027 | 0.007 | |
| E2083 | 5 | 0.22 | 0.98 | 0.42 | 0.025 | 0.017 | 0.104 | 0.007 | 0.093 | 0.035 | 0.007 | |
| E2095 | 4 | 0.22 | 0.93 | 0.41 | 0.022 | 0.015 | 0.012 | 0.008 | 0.079 | 0.026 | 0.011 | |
| E2104 | 3 | 0.22 | 0.90 | 0.42 | 0.018 | 0.010 | 0.150 | 0.048 | 0.068 | 0.029 | 0.014 | |
| E2113 | 3 | 0.21 | 0.93 | 0.47 | 0.023 | 0.016 | 0.001 | 0.007 | 0.001 | 0.027 | 0.007 | |
| E2122 | 4 | 0.22 | 0.98 | 0.42 | 0.025 | 0.017 | 0.104 | 0.007 | 0.093 | 0.035 | 0.007 | |
| E2132 | 2 | 0.21 | 0.97 | 0.46 | 0.025 | 0.014 | 0.052 | 0.008 | 0.125 | 0.028 | 0.007 | |

B)Mechanical Property

| Heat No. | Test Temp | Pouring Date | Rp 0.2 Proof Strength | Tensile Strength | Elongation | Reduction | Hardness | Energy Charpy Impact | |
|---------------|-----------|--------------|-----------------------|------------------|------------|-----------|----------|----------------------|-----|
| | | | | | | | | Joule | φ |
| ASTM A216 WCB | | | ≥250 | 485-655 | ≥22 | ≥35 | ≤235 | | N/A |
| E1982 | RT | 2013.03.21 | 335 | 540 | 28 | 53 | 156 | | |
| E1995 | RT | 2013.03.20 | 310 | 495 | 28 | 53 | 156 | | |
| E2003 | RT | 2013.03.21 | 335 | 530 | 26 | 42 | 159 | | |
| E2043 | RT | 2013.03.23 | 300 | 520 | 26 | 50 | 156 | | |
| E2046 | RT | 2013.03.22 | 340 | 530 | 26 | 50 | 163 | | |
| E2055 | RT | 2013.03.24 | 400 | 520 | 33 | 69 | 156 | | |
| E2061 | RT | 2013.03.24 | 360 | 540 | 26 | 53 | 163 | | |
| E2073 | RT | 2013.03.25 | 320 | 540 | 25 | 44 | 152 | | |
| E2083 | RT | 2013.03.27 | 310 | 530 | 28 | 53 | 159 | | |
| E2095 | RT | 2013.03.23 | 320 | 530 | 27 | 43 | 159 | | |
| E2104 | RT | 2013.03.29 | 440 | 570 | 32 | 66 | 170 | | |
| E2113 | RT | 2013.03.25 | 325 | 520 | 26 | 53 | 146 | | |
| E2122 | RT | 2013.03.27 | 330 | 540 | 25 | 50 | 163 | | |
| E2132 | RT | 2013.03.24 | 375 | 530 | 30 | 64 | 152 | | |

C) Dimensional check and NDT

| Testing | Details | Result |
|---------------------------|-----------|--------|
| Visual inspection | MSS-SP-55 | OK |
| Dimension inspection | DWG | OK |
| Surface crack examination | MSS-SP-53 | OK |

D) Delivery Condition: N

We hereby certify that the material was manufactured, Sampled, tested and inspected in accordance with the material specification and customer requirements and was found to meet the requirement.

Place: *Wang*

Date: 2013.04.16

Work Inspector: *Chen am*

ANHUI YINGLIU ELECTROMECHANICAL CO.,LTD

INSPECTION CERTIFICATE

ADD:No.96 Pihe Road,Huo shan County,Anhui Province, China
TEL:0086-564-5036508 FAX:0086-564-5036500

Inspection Certificate (EN 10204-3.1)

Certificate-No.: 2013-02-017U

Customer: Danial Measurement and Control

Order-No.:287056-000-1

Date: 2013.02.26

Article:4"600 old SR Body

Pattern No:015-4C

Specification: MTL-A216-01 REV.B

Part No.:1-601-61-077

Material: ASTM A216 WCB NACE MR0175

Melting process-Heat Treatment:+N 920°C*2.5h

A)Chemical analysis

| Heat No. | Qty. | C % | Mn % | Si % | P % | S % | Cr % | Mo % | Ni % | Cu % | V % |
|---------------|------|------|------|------|-------|-------|-------|-------|-------|-------|-------|
| ASTM A216 WCB | ≤ | 0.26 | 1.00 | 0.60 | 0.040 | 0.045 | 0.50 | 0.20 | 0.50 | 0.30 | 0.030 |
| E1697 | 1 | 0.23 | 0.95 | 0.48 | 0.023 | 0.014 | 0.093 | 0.030 | 0.058 | 0.032 | 0.006 |
| E1704 | 1 | 0.21 | 0.93 | 0.41 | 0.019 | 0.014 | 0.001 | 0.007 | 0.021 | 0.024 | 0.006 |
| E1714 | 1 | 0.22 | 0.95 | 0.49 | 0.021 | 0.016 | 0.038 | 0.017 | 0.034 | 0.023 | 0.006 |
| E1727 | 1 | 0.23 | 0.92 | 0.44 | 0.021 | 0.014 | 0.004 | 0.009 | 0.058 | 0.028 | 0.011 |
| E1734 | 2 | 0.20 | 0.89 | 0.45 | 0.022 | 0.016 | 0.028 | 0.010 | 0.036 | 0.028 | 0.006 |
| E1749 | 3 | 0.21 | 0.88 | 0.47 | 0.022 | 0.016 | 0.106 | 0.050 | 0.068 | 0.026 | 0.009 |
| E1761 | 1 | 0.20 | 0.88 | 0.40 | 0.022 | 0.017 | 0.077 | 0.001 | 0.024 | 0.020 | 0.004 |
| E1763 | 6 | 0.21 | 0.96 | 0.40 | 0.022 | 0.017 | 0.044 | 0.015 | 0.030 | 0.031 | 0.007 |
| E1767 | 2 | 0.21 | 0.96 | 0.40 | 0.022 | 0.017 | 0.044 | 0.015 | 0.030 | 0.031 | 0.007 |
| E1802 | 1 | 0.23 | 0.95 | 0.48 | 0.023 | 0.014 | 0.093 | 0.030 | 0.058 | 0.032 | 0.006 |
| E1804 | 4 | 0.21 | 0.94 | 0.41 | 0.021 | 0.014 | 0.172 | 0.041 | 0.117 | 0.047 | 0.008 |
| E1814 | 4 | 0.22 | 0.94 | 0.48 | 0.023 | 0.018 | 0.020 | 0.005 | 0.059 | 0.032 | 0.008 |
| E1821 | 3 | 0.21 | 0.88 | 0.47 | 0.022 | 0.016 | 0.106 | 0.050 | 0.068 | 0.026 | 0.009 |
| E1824 | 1 | 0.22 | 0.94 | 0.48 | 0.023 | 0.018 | 0.020 | 0.005 | 0.059 | 0.032 | 0.008 |
| E1827 | 5 | 0.21 | 0.93 | 0.42 | 0.021 | 0.014 | 0.021 | 0.007 | 0.047 | 0.028 | 0.007 |
| E1831 | 1 | 0.23 | 0.92 | 0.44 | 0.023 | 0.015 | 0.082 | 0.005 | 0.061 | 0.022 | 0.006 |
| E1837 | 7 | 0.21 | 0.93 | 0.42 | 0.021 | 0.014 | 0.021 | 0.007 | 0.047 | 0.028 | 0.007 |

B)Mechanical Property

| Heat No. | Test Temp | Pouring Date | Rp 0.2 Proof Strength | Tensile Strength | Elongation | Reduction | Hardness | Energy Charpy Impact | |
|---------------|-----------|--------------|-----------------------|------------------|------------|-----------|----------|----------------------|-----|
| | | | | | | | | Joule | φ |
| ASTM A216 WCB | ℃ | | MPA | MPA | % | % | HB | | N/A |
| | | | ≥260 | 485-655 | ≥22 | ≥35 | ≤235 | | |
| E1697 | RT | 2013.01.24 | 325 | 530 | 28 | 47 | 159 | | |
| E1704 | RT | 2013.01.17 | 340 | 515 | 28 | 55 | 156 | | |
| E1714 | RT | 2013.01.19 | 320 | 520 | 27 | 47 | 149 | | |
| E1727 | RT | 2013.01.21 | 390 | 570 | 29 | 41 | 156 | | |
| E1734 | RT | 2013.01.23 | 385 | 530 | 30 | 53 | 146 | | |
| E1749 | RT | 2013.01.24 | 325 | 530 | 26 | 47 | 143 | | |
| E1761 | RT | 2013.01.22 | 370 | 520 | 28 | 47 | 159 | | |
| E1763 | RT | 2013.01.23 | 335 | 520 | 26 | 46 | 149 | | |
| E1767 | RT | 2013.01.23 | 310 | 515 | 28 | 42 | 159 | | |
| E1802 | RT | 2013.01.24 | 470 | 575 | 28 | 52 | 152 | | |
| E1804 | RT | 2013.01.26 | 330 | 530 | 26 | 48 | 163 | | |
| E1814 | RT | 2013.01.25 | 310 | 505 | 28 | 50 | 159 | | |
| E1821 | RT | 2013.01.24 | 375 | 555 | 28 | 42 | 159 | | |
| E1824 | RT | 2013.01.25 | 330 | 530 | 27 | 53 | 149 | | |
| E1827 | RT | 2013.01.26 | 355 | 550 | 31 | 58 | 167 | | |
| E1831 | RT | 2013.01.23 | 325 | 505 | 29 | 55 | 149 | | |
| E1837 | RT | 2013.01.26 | 325 | 530 | 28 | 50 | 159 | | |

C) Dimensional check and NDT

| Testing | Details | Result |
|---------------------------|-----------|--------|
| Visual Inspection | MSS-SP-55 | OK |
| Dimension Inspection | DWG | OK |
| Surface crack examination | MSS-SP-53 | OK |

D) Delivery Condition: N

We hereby certify that the material was manufactured. Sampled, tested and inspected in accordance with the material specification and customer requirements and was found to meet the requirement.

Place:

Litang

Date: 2013.02.26

Work Inspector:

Chen Can

ANHUI YINGLIU ELECTROMECHANICAL CO.,LTD

INSPECTION CERTIFICATE

ADD:No.96 Pihe Road, Huo shan County,Anhui Province, China
 TEL:0086-564-5036508 FAX:0086-564-5036500

Inspection Certificate (EN 10204-3.1)

Certificate-No.: 2013-05-027U

Customer: Danlei Measurement and Control

Order-No.:292403-000-1

Date: 2013.05.14

Article:4"150-600 old SR Top

Pattern No:150-600-4T

Specification: MTL-A216-01 REV.B

Part No.:1-601-01-423

Material: ASTM A216 WCB NACE MR0175

Melting process-Heat Treatment:+N 920°C*2.5h

A)Chemical analysis

| Heat No. | Qty. | C % | Mn % | Si % | P % | S % | Cr % | Mo % | Ni % | Cu % | V % | |
|---------------|------|------|------|------|-------|-------|-------|-------|-------|-------|-------|-------|
| ASTM A216 WCB | | ≤ | 0.25 | 1.00 | 0.60 | 0.040 | 0.045 | 0.50 | 0.20 | 0.50 | 0.30 | 0.030 |
| E2226 | 1 | 0.20 | 0.89 | 0.39 | 0.020 | 0.012 | 0.063 | 0.011 | 0.016 | 0.012 | 0.006 | |
| E2245 | 1 | 0.21 | 0.95 | 0.45 | 0.021 | 0.013 | 0.001 | 0.011 | 0.055 | 0.017 | 0.007 | |
| E2247 | 1 | 0.22 | 0.94 | 0.42 | 0.024 | 0.013 | 0.054 | 0.009 | 0.016 | 0.013 | 0.007 | |
| E2253 | 2 | 0.21 | 0.96 | 0.40 | 0.026 | 0.017 | 0.001 | 0.013 | 0.060 | 0.022 | 0.006 | |
| E2255 | 4 | 0.22 | 0.86 | 0.38 | 0.023 | 0.012 | 0.059 | 0.008 | 0.014 | 0.010 | 0.005 | |
| E2272 | 3 | 0.21 | 0.92 | 0.41 | 0.021 | 0.012 | 0.089 | 0.020 | 0.014 | 0.020 | 0.014 | |
| E2285 | 3 | 0.23 | 0.96 | 0.41 | 0.020 | 0.013 | 0.064 | 0.023 | 0.090 | 0.020 | 0.005 | |
| E2289 | 8 | 0.24 | 0.91 | 0.41 | 0.021 | 0.012 | 0.062 | 0.006 | 0.016 | 0.015 | 0.004 | |
| E2293 | 1 | 0.22 | 0.91 | 0.41 | 0.024 | 0.013 | 0.066 | 0.008 | 0.016 | 0.015 | 0.006 | |
| E2300 | 1 | 0.21 | 0.94 | 0.41 | 0.021 | 0.015 | 0.005 | 0.009 | 0.099 | 0.026 | 0.004 | |
| E2305 | 2 | 0.20 | 0.93 | 0.40 | 0.022 | 0.013 | 0.066 | 0.005 | 0.012 | 0.018 | 0.007 | |
| E2315 | 3 | 0.22 | 0.97 | 0.43 | 0.023 | 0.013 | 0.065 | 0.022 | 0.107 | 0.023 | 0.005 | |
| E2323 | 2 | 0.20 | 0.99 | 0.45 | 0.017 | 0.008 | 0.116 | 0.039 | 0.064 | 0.042 | 0.010 | |
| E2330 | 7 | 0.22 | 0.92 | 0.39 | 0.023 | 0.012 | 0.066 | 0.006 | 0.016 | 0.015 | 0.005 | |

B)Mechanical Property

| Heat No. | Test Temp | Pouring Date | Rp 0.2 Proof Strength | Tensile Strength | Elongation | Reduction | Hardness | Energy Charpy Impact | | |
|---------------|-----------|--------------|-----------------------|------------------|------------|-----------|----------|----------------------|-----|-----|
| | | | | | | | | °C | MPA | % |
| ASTM A216 WCB | | | ≥260 | 485-655 | ≥22 | ≥35 | ≤235 | | | N/A |
| E2226 | RT | 2013.04.10 | 325 | 520 | 26 | 47 | 152 | | | |
| E2245 | RT | 2013.04.11 | 310 | 515 | 27 | 47 | 146 | | | |
| E2247 | RT | 2013.04.09 | 355 | 505 | 32 | 66 | 159 | | | |
| E2253 | RT | 2013.04.09 | 320 | 530 | 26 | 47 | 152 | | | |
| E2255 | RT | 2013.04.09 | 345 | 515 | 32 | 67 | 149 | | | |
| E2272 | RT | 2013.04.13 | 325 | 520 | 26 | 45 | 156 | | | |
| E2285 | RT | 2013.04.14 | 320 | 520 | 26 | 47 | 159 | | | |
| E2289 | RT | 2013.04.16 | 310 | 505 | 28 | 51 | 156 | | | |
| E2293 | RT | 2013.04.11 | 350 | 535 | 26 | 53 | 159 | | | |
| E2300 | RT | 2013.04.12 | 315 | 520 | 26 | 50 | 146 | | | |
| E2305 | RT | 2013.04.12 | 325 | 540 | 23 | 43 | 156 | | | |
| E2315 | RT | 2013.04.14 | 320 | 540 | 25 | 41 | 156 | | | |
| E2323 | RT | 2013.04.13 | 360 | 620 | 27 | 53 | 149 | | | |
| E2330 | RT | 2013.04.14 | 320 | 515 | 26 | 42 | 159 | | | |

C) Dimensional check and NDT

| Testing | Details | Result |
|---------------------------|-----------|--------|
| Visual Inspection | MSS-SP-55 | OK |
| Dimension Inspection | DWG | OK |
| Surface crack examination | MSS-SP-53 | OK |

D) Delivery Condition: N

We hereby certify that the material was manufactured. Sampled, tested and inspected in accordance with the material specification and customer requirements and was found to meet the requirement.

Place: *Wang*

Date: 2013.05.14

Work inspector: *Chen Can*

ANHUI YINGLIU ELECTROMECHANICAL CO.,LTD

INSPECTION CERTIFICATE

ADD:No.96 Pih Road,Huo shan County,Anhui Province, China
 TEL:0086-564-5036508 FAX:0086-564-5036500

Inspection Certificate (EN 10204-3.1)

Certificate-No.: 2013-01-029U

Customer: Danlei Measurement and Control

Order-No.:285964-000-1

Date: 2013.01.29

Article:4"600 old SR Body

Pattern No:015-4C

Specification: MTL-A216-01 REV.B

Part No.:1-601-61-077

Material: ASTM A216 WCB NACE MR0175

Melting process-Heat Treatment:+N 920°C*2.5h

A)Chemical analysis

| Heat No. | Qty. | C % | Mn % | Si % | P % | S % | Cr % | Mo % | Ni % | Cu % | V % |
|---------------|------|------|------|------|-------|-------|-------|-------|-------|-------|-------|
| ASTM A216 WCB | | 0.25 | 1.00 | 0.60 | 0.040 | 0.045 | 0.50 | 0.20 | 0.50 | 0.30 | 0.030 |
| E1612 | 1 | 0.21 | 0.97 | 0.45 | 0.023 | 0.020 | 0.054 | 0.009 | 0.019 | 0.022 | 0.005 |
| E1624 | 1 | 0.22 | 0.92 | 0.45 | 0.020 | 0.012 | 0.001 | 0.002 | 0.014 | 0.019 | 0.006 |
| E1627 | 1 | 0.21 | 0.94 | 0.44 | 0.022 | 0.018 | 0.018 | 0.006 | 0.025 | 0.028 | 0.007 |
| E1630 | 1 | 0.22 | 0.97 | 0.45 | 0.020 | 0.012 | 0.058 | 0.005 | 0.011 | 0.020 | 0.005 |
| E1634 | 6 | 0.21 | 0.96 | 0.44 | 0.022 | 0.015 | 0.015 | 0.003 | 0.025 | 0.025 | 0.007 |
| E1642 | 3 | 0.21 | 0.96 | 0.47 | 0.021 | 0.011 | 0.056 | 0.006 | 0.002 | 0.011 | 0.003 |
| E1645 | 3 | 0.22 | 0.88 | 0.41 | 0.020 | 0.008 | 0.063 | 0.005 | 0.012 | 0.014 | 0.007 |
| E1657 | 1 | 0.22 | 0.89 | 0.45 | 0.023 | 0.015 | 0.075 | 0.027 | 0.076 | 0.025 | 0.006 |
| E1662 | 5 | 0.21 | 0.99 | 0.44 | 0.021 | 0.015 | 0.007 | 0.010 | 0.035 | 0.023 | 0.006 |
| E1664 | 4 | 0.21 | 0.95 | 0.43 | 0.022 | 0.015 | 0.038 | 0.013 | 0.035 | 0.022 | 0.007 |
| E1667 | 3 | 0.23 | 0.95 | 0.47 | 0.017 | 0.013 | 0.001 | 0.008 | 0.011 | 0.050 | 0.011 |
| E1671 | 2 | 0.22 | 0.94 | 0.43 | 0.021 | 0.012 | 0.061 | 0.005 | 0.014 | 0.018 | 0.005 |
| E1677 | 11 | 0.22 | 0.97 | 0.44 | 0.019 | 0.013 | 0.116 | 0.073 | 0.045 | 0.025 | 0.006 |
| E1723 | 8 | 0.22 | 0.95 | 0.52 | 0.022 | 0.015 | 0.008 | 0.010 | 0.028 | 0.024 | 0.007 |

B)Mechanical Property

| Heat No. | Test Temp | Pouring Date | Rp 0.2 Proof Strength | Tensile Strength | Elongation | Reduction | Hardness | Energy Charpy Impact | |
|---------------|-----------|--------------|-----------------------|------------------|------------|-----------|----------|----------------------|-----|
| | | | MPA | MPA | % | % | HB | Joule | φ |
| ASTM A216 WCB | | | ≥250 | 485-655 | ≥22 | ≥35 | ≤235 | | N/A |
| E1612 | RT | 2013.01.03 | 315 | 505 | 29 | 52 | 159 | | |
| E1624 | RT | 2013.01.06 | 325 | 520 | 26 | 50 | 156 | | |
| E1627 | RT | 2013.01.11 | 320 | 530 | 27 | 47 | 159 | | |
| E1630 | RT | 2013.01.11 | 315 | 530 | 26 | 47 | 159 | | |
| E1634 | RT | 2013.01.08 | 415 | 590 | 33 | 59 | 159 | | |
| E1642 | RT | 2013.01.13 | 315 | 515 | 27 | 47 | 149 | | |
| E1645 | RT | 2013.01.13 | 325 | 515 | 29 | 53 | 156 | | |
| E1657 | RT | 2013.01.13 | 315 | 515 | 28 | 48 | 156 | | |
| E1662 | RT | 2013.01.17 | 335 | 545 | 25 | 47 | 156 | | |
| E1664 | RT | 2013.01.19 | 330 | 540 | 25 | 49 | 149 | | |
| E1667 | RT | 2013.01.18 | 335 | 530 | 26 | 47 | 156 | | |
| E1671 | RT | 2013.01.11 | 360 | 555 | 30 | 59 | 167 | | |
| E1677 | RT | 2013.01.14 | 330 | 515 | 28 | 52 | 149 | | |
| E1723 | RT | 2013.01.21 | 375 | 540 | 27 | 47 | 152 | | |

C) Dimensional check and NDT

| Testing | Details | Result |
|---------------------------|-----------|--------|
| Visual Inspection | MSS-SP-55 | OK |
| Dimension Inspection | DWG | OK |
| Surface crack examination | MSS-SP-53 | OK |

D) Delivery Condition: N

We hereby certify that the material was manufactured, Sampled, tested and inspected in accordance with the material specification and customer requirements and was found to meet the requirement.

Place:

Li Tang

Date: 2013.01.29

Work Inspector:

Chen Can



Manufacturers of Piping and Pressure Vessel Components

4407 Haygood St - Houston, TX 77032
 Phone: 713-695-3633 Fax: 713-695-3528
 A Newway Forge Company

Sold To: TRANS AM PIPING PRODUCTS LTD
 9335 ENDEAVOR DRIVE S.E.
 CALGARY AB T3S 0A1

Mtr #: 193,917

PO #: CI-10-355

Sales Order #: C001008457

Date: 08/20/2010

This product has not come in direct contact with mercury or any of its compounds, nor with any mercury-containing device employing a single boundary of containment. No welding performed.

We certify that the contents of this report are correct and accurate, and that all test results and operations performed by WFI or its subcontractors are in compliance with the material specification and requirements of the referenced code or standard, and that the material conforms to the dimensional requirements of the order. This document is in accordance with EN10204 3.1.

Certified Material Test Report

Heat Code: 58067

Material: A/SA105N 09

| Item | Quantity | Description |
|------|----------|-------------------------------------|
| 19 | | 36 - 3 X 1 3M THP A/SA105N |
| 32 | | 36 - 1 1/2 X 3/4 6M THP A/SA105N |

Chemical Composition

| Grade | C | CR | CU | NI | MO | NI | P | S |
|---------------------|-------|-------|-------|------|-------|------|-------|-------|
| | 0.200 | 0.06 | 0.170 | 1.07 | 0.010 | 0.05 | 0.014 | 0.018 |
| | SI | V | | | | | | |
| | 0.19 | 0.005 | | | | | | |
| Carbon Equivalency: | Grade | | 0.41 | | | | | |

| Product | Tensile PSI | Yield PSI | Elong % | RA % | Hardness | |
|---------|-------------|-----------|---------|-------|----------|-------|
| | 72,500 | 48,750 | 32.45 | 64.90 | 130 BHN | 0 BHN |

Normalized

1. IN ACCORDANCE WITH NACE SPEC MR0175-2002

Marie Dehmer
 Quality Assurance Representative



Manufacturer of Piping and Pressure Vessel Components
 4407 Haygood St - Houston, TX 77022
 Phone: 713-695-3633 Fax: 713-695-3528
 A Bonsey Forge Company

Sold To: TRANS AM PIPING PRODUCTS
 LTD
 9335 ENDEAVOR DRIVE S.E.
 CALGARY AB T3S 0A1

MTR #: 210,679

PO #: CI-11-420

Sales Order #: C001107401

Date: 07/08/2011

Certified Material Test Report

Heat Code: 58378

This product has not come in direct contact with mercury or any of its compounds, nor with any mercury-containing device employing a single boundary of containment. No welding performed.

We certify that the contents of this report are correct and accurate, and that all test results and operations performed by WFI or its subcontractors are in compliance with the material specification and requirements of the referenced code or standard, and that the material conforms to the dimensional requirements of the order. This document is in accordance with EN10204 3.1.

Material: A/SA105N 09

| Item | Description |
|------|-------------------------------------|
| 21 | 36 - 1 1/2 X 3/4 6M THP A/SA105N |

Chemical Composition

| Ladle | C | CR | CU | MN | MO | NB | NI | P |
|---------------------|-------|------|-------|------|-------|-------|------|-------|
| | 0.210 | 0.03 | 0.080 | 1.04 | 0.000 | 0.000 | 0.02 | 0.006 |
| | S | SI | V | | | | | |
| | 0.018 | 0.25 | 0.003 | | | | | |
| Carbon Equivalency: | Ladle | | 0.40 | | | | | |

| Product | Tensile PSI | Yield PSI | Elong % | RA % | Hardness |
|---------|-------------|-----------|---------|-------|-----------------|
| | 73,750 | 50,625 | 34.10 | 66.75 | 137 BHN 139 BHN |

Normalized

IAW NACE MR0175/ISO 15156-2009

*3/4 GOOD APPROX
 100%
 HTI 58378*

Marie Dehmer
 Quality Assurance Representative



Manufacturers of Flange and Pressure Vessel Components
 4404 Haygood St - Houston, TX 77022
 Phone: 713-693-3633 Fax: 713-693-3528
 A Bonney Forge Company

Sold To: TRANS AM PIPING PRODUCTS
 LTD
 9335 ENDEAVOR DRIVE S.E.
 CALGARY AB T3S 0A1

MTR #: 241,007

PO #: CI-12-586

Sales Order #: C001215632

Date: 10/29/2012

Certified Material Test Report

Heat Code: 58711

This product has not come in direct contact with mercury or any of its compounds, nor with any mercury-containing device employing a single boundary of containment. No welding performed.

We certify that the contents of this report are correct and accurate, and that all test results and operations performed by WFI or its subcontractors are in compliance with the material specification and requirements of the referenced code or standard, and that the material conforms to the dimensional requirements of the order. This document is in accordance with EN10204 3.1.

Material: A/SA105N 09

| Item | Quantity | Description |
|------|----------|-------------------------------|
| 11 | 100 | 36 - 3 X 1 6M THP A/SA105N |

Chemical Composition

| Ladle | C | CR | CU | MN | MO | NI | NI | P |
|-------|-------|------|-------|------|-------|-------|------|-------|
| | 0.207 | 0.03 | 0.070 | 1.01 | 0.004 | 0.014 | 0.02 | 0.006 |

| S | SI | V |
|-------|------|-------|
| 0.020 | 0.20 | 0.003 |

Carbon Equivalency: Ladle 0.39

| Product | C | CR | CU | MN | MO | NI | P | S |
|---------|-------|------|-------|------|-------|------|-------|-------|
| | 0.000 | 0.00 | 0.000 | 0.00 | 0.000 | 0.00 | 0.000 | 0.000 |

| SI | V |
|------|-------|
| 0.00 | 0.000 |

| Product | Tensile PSI | Yield PSI | Elong % | RA % | Hardness |
|---------|-------------|-----------|---------|-------|----------|
| | 74,356 | 49,567 | 34.90 | 62.56 | 130 BHN |

Normalized

IAW NACE MR0175/ ISO 15156- 2009

*1" 6000 A105N
 TOL
 HT: 58711*

Marie Dehmer
 Quality Assurance Representative

10128784

HT 2202317

From: American Piping
POJ: SEE BELOW

Date: 1/14/2013 To: SCOT-BROOKSHIRE Qty: 102
Part: 4600437GR0

SO#: 9238599 Ltr#: 3
Head: 2202317

178-13
08

113-18960

JINDAL SAW LTD.



WORK / MILL TEST CERTIFICATE

D/Q/V/21800

T.O. NO. JSL/Q/4111000159/D
P.O. NO. P18026
R.O. NO. 0111000459
D.T. NO. 0111002361

DATE: 01.09.2013
DATE: 23.07.2013
DATE: 28.07.2013
DATE: 01.02.2013

QUALITY CONTROL AMERICAN PIPING PRODUCTS, NON-FERROUS METALS DIVISION, JINDAL SAW LTD., PUNE, INDIA

PIPE IDENTIFICATION

1. NOT TREATED & NON-SALINATED CARBON STEEL GRADES LISTED
1. ASTM A 333 GR. 6 ENR. 2010 / ASME SA 333 GR. 6 ENR. 2010 SECTION PART A ADD. 2011 / ASTM A 333 GR. 6 / ASME SA 333 GR. 6 /
ASTM A 106 GR. B / Q ENR. 2010 / ASME SA 106 GR. B / Q ENR. 2010 SECTION PART A ADD. 2011 / API 5L GR. B X 42 FLS
40" ENR. 2007 / NACE MR 0175 / NACE MR 0103

4.50 X 3.626

| PIPE DIMENSIONS | LENGTH (FEET) | END CONDITIONS | FITTINGS/ENDS | TEST NO. | QUANTITY | | |
|-----------------|---------------|----------------|----------------|------------|----------|-----|----------|
| | | | | | NO. | WT. | |
| 4.50" OD | 0.437" WT | 65' ± 2' | Butt Weld Ends | Subfactory | 2002017 | 30 | 1219.878 |
| TOTAL | | | | | | 30 | 1219.878 |

CHEMICAL COMPOSITION

| Heat No. | Analyt. | % C | % Mn | % Si | % S | % P | % Cr | % Ni | % Cu | % Mo | % V | % Nb | % Ti |
|----------|---------|------|-------------|------|-------|-------|-------|-------|-------|-------|--------|--------|-------|
| | | | | | | | | | | | | | |
| 2002017 | Min. | 0.20 | 0.29 - 1.06 | 0.19 | 0.010 | 0.020 | 0.40 | 0.40 | 0.50 | 0.15 | 0.08 | 0.08 | 0.43 |
| | Product | 0.20 | 1.15 | 0.31 | 0.005 | 0.017 | 0.011 | 0.004 | 0.006 | - | - | - | 0.991 |
| | Product | 0.19 | 1.13 | 0.29 | 0.004 | 0.016 | 0.011 | 0.004 | 0.006 | 0.003 | 0.0004 | 0.0003 | 0.970 |

* Min. to max. % Ni up to 1.65 % Ni per Class specified in ASTM / ASME / API SL Specifications.

MCHANICAL TESTS

| Heat No. | Y.S. | TENSILE TEST | | | OTHER TESTS | | | |
|----------|----------------|--------------|---------------------|---------------|-----------------|-------------------------------------|----------------------------|--|
| | | U.T.S. | % Elong. 50.80 Min. | HAZINESS TEST | FLATTENING TEST | HYDROSTATIC TEST (100%) | Impact Test | |
| 2002017 | 41100 PSI Min. | 76200 PSI | 24.90% | 300 BHN Max. | As Per Spc. | 3000 PSI for 3 seconds @ 100psi/min | L-10-10 (1(-45°C)) | |
| | 51599.77 | 76200.07 | 36.18 | 151 - 133 | Satisfactory | Satisfactory | 110, 114, 93 - Avg. 106.66 | |

Remarks:

1. Good Milling Process
2. Visual Inspection
3. Heat Treatment
4. Product is free from Slag
5. No Rippled Ends by Rolling
6. Edgy Condition Test Satisfactory

1. CAP-IR-VD-CCM, PDU, XMM, Satisfactory Normalized at 800°C.

Stock 4" 900 S&S GR 6
HT: 2002317
HARD

T.GAS PER HOUR = 0.1

The heat treatment of this material has been completed in accordance with the standard and test procedure as specified in the specification.

Authorized Signatory

[Signature]



VALBRUNA
 SLATER STAINLESS, INC.
 2400 TAYLOR STREET WEST - PO BOX 690
 FORT WAYNE IN 46804 USA
 PHONE 260.434.2200 - FAX 260.434.2201

258277

Product Certification Report

Report Number: 4870420

Certified on Mar 19, 2013 Page 1 of 1

| | | | | | |
|--|----------------|-----------------------|--------------------------------------|-----------------------------|---|
| Order I.D. 1300538 001 | | Order Date 3/04/13 | | Commodity Code SSRD00372 | |
| Dim 1 6.2500 | Dim 2 .0000 | Dim 3 .0000 | Heat I.D. 258277 | Customer I.D. 002720 | Customer Purchase Order 5400174878-R05 |
| Product Shape Rounds | | | Product Surface HR & Rough Turned | | Customer Grade 316/316L |
| Length (Inches) 120.000 Min. 168.000 Max. | | | Bill of Lading # 419164 | Weight | |

Ship To
 TKM/COPPER AND BRASS SALES
 10648 WEST LITTE YORK
 SUITE 400
 HOUSTON, TX 77041

Sold To
 VALBRUNA STAINLESS, INC.
 2400 TAYLOR STREET WEST
 FORT WAYNE, IN 46802

Lifts: 0007 0008

NACE MR0175-10 ISO 15156-3 ASTM 182-11a Chem Only ASTM 276-10
 ASTMA 479-12 AMS 5648L AMS 5653H

CHEMICAL ANALYSIS

| C | Mn | P | S | Si | Cr | Ni | Mo | Cu | Co | N |
|------|------|------|------|-----|-------|-------|------|-----|-----|-----|
| .023 | 1.68 | .030 | .027 | .39 | 16.85 | 10.01 | 2.03 | .54 | .16 | .06 |

BRINELL HARDNESS ASTM E10-12

HBW
165

TENSILE PROPERTIES ASTM E8-11

| TS (PSI) | .2%YS (PSI) | %EL(2') | %RA |
|----------|-------------|---------|------|
| 81900 | 36200 | 72.2 | 80.3 |

MACRO ASTM E340-00/E381-01

MACRO
OK

GRAIN SIZE ASTM E112-10

| GRAIN SIZE | Etchant | Magnification X |
|------------|---------|-----------------|
| 6 | Oxalic | 100 |

ASTM A262-10 PR E(A Utilized)

| OXALIC | Etchant | Magnification X |
|--------|---------|-----------------|
| OK | Oxalic | 500 |

No mercury or low melting alloy contamination. Continuous carbide and intergranular corrosion test OK.
 Material is RoHS compliant.

Chemical testing to one or more of the listed ASTM methods:
 E415-08, E572-02a, E1019-11, E1085-95, E1086-08.

Location of tensile fracture: inside middle of gage length.

Chemical Analysis performed at Acciaierie Valbruna, Italy.

No mercury or low melting alloy contamination. No weld repair.

Material melted in Italy, manufactured in the United States.

Material conforms to listed specifications and is DFARS compliant.

Quality system is compliant with ISO 9001:2008. Produced in accordance with EN 10204 3.1.

Results relate only to the items tested. Certification shall not be reproduced except in full, without written approval of Valbruna Stainless Inc. The recording of false, fictitious, or fraudulent statements on this document may be punished as a felony under federal statutes, including Federal law, Title 18, Chapter 47. Consult material safety data sheet (MSDS) for hazard info.

I hereby certify that the reported figures are correct as contained in the records of the corporation.

Manager Laboratory Services *Dennis Hackett*

From: *DHackett@valbruna.us* Dennis Hackett
 Copper and Brass Sales CA

Cust. M2M MACHINING Del.: 2402640839

CstAr CstOr 2012-344

Wgt.: 880.000 LB Date 08/16/2013

John J. Zambetti



SECTION 3: TEST REPORTS

Daniel Industries Canada
 4215 - 72 Avenue S.E.
 Calgary, AB T2C 2G5
 Tel: (403) 279-1879 Fax: (403) 236-1337

Job Number: 7030908
 PO Number: P30908X

Date of Exam: Tuesday, Nov 12 2013
 Job Location: Western's Shop
 Technicians: Brandon Upstone CEDO-NBC Reg #12830; SNT LV. I

Acc Codes: ASME B31.3 Normal
 Inspected: Pre Heat Treat
 Material: Carbon Steel
 Isotope: IR 192
 Focal Spot: 2x3 mm
 Curies: 74
 Degree: 100%
 Processing: Automatic
 Units: in

Legend:
 * (Loading)
 # (Result)
 @ (Degree)

S = Single
 D = Double
 T = Triple
 ACC = Accept
 REJ = Reject
 RETEST = Retest
 1 = Acceptable
 2 = Slight
 3 = Reject

Note: SFD Does not include reinforcement

| Comp# | Test# | Tech | IQI | Wldr | Dia | Test Information | | | SFD | Sch | Len | * Films | Type | Result Information | |
|-------|-------|------|-----|------|-----|------------------|-----|-----|-----|-----|----------|---------|------|--------------------|---------------|
| | | | | | | Thk | Len | Thk | | | | | | # | Discontinuity |
| 1 | X1 | RT1 | 1B | X | 4 | 0.337 | XH | 4.5 | S | 3 | D4-GEV-I | ACC | | | |
| 2 | X2 | RT1 | 1B | X | 4 | 0.337 | XH | 4.5 | S | 3 | D4-GEV-I | ACC | | | |
| 3 | X3 | RT1 | 1B | X | 4 | 0.337 | XH | 4.5 | S | 3 | D4-GEV-I | ACC | | | |
| 4 | X4 | RT1 | 1B | X | 4 | 0.337 | XH | 4.5 | S | 3 | D4-GEV-I | ACC | | | |
| 5 | X5 | RT1 | 1B | X | 4 | 0.337 | XH | 4.5 | S | 3 | D4-GEV-I | ACC | | | |
| 6 | X6 | RT1 | 1B | X | 4 | 0.337 | XH | 4.5 | S | 3 | D4-GEV-I | ACC | | | |
| 7 | X7 | RT1 | 1B | X | 4 | 0.337 | XH | 4.5 | S | 3 | D4-GEV-I | ACC | | | |
| 8 | X8 | RT1 | 1B | X | 4 | 0.337 | XH | 4.5 | S | 3 | D4-GEV-I | ACC | | | |
| 9 | X9 | RT1 | 1B | X | 4 | 0.337 | XH | 4.5 | S | 3 | D4-GEV-I | ACC | | | |
| 10 | X10 | RT1 | 1B | X | 4 | 0.337 | XH | 4.5 | S | 3 | D4-GEV-I | ACC | | | |
| 11 | X11 | RT1 | 1B | X | 4 | 0.337 | XH | 4.5 | S | 3 | D4-GEV-I | ACC | | | |
| 12 | X12 | RT1 | 1B | X | 4 | 0.337 | XH | 4.5 | S | 3 | D4-GEV-I | ACC | | | |
| 13 | X13 | RT1 | 1B | X | 4 | 0.337 | XH | 4.5 | S | 3 | D4-GEV-I | ACC | | | |
| 14 | X14 | RT1 | 1B | X | 4 | 0.337 | XH | 4.5 | S | 3 | D4-GEV-I | ACC | | | |
| 15 | X15 | RT1 | 1B | X | 4 | 0.337 | XH | 4.5 | S | 3 | D4-GEV-I | ACC | | | |
| 16 | X16 | RT1 | 1B | X | 4 | 0.337 | XH | 4.5 | S | 3 | D4-GEV-I | ACC | | | |

RT 1: T.291 g) S.O.D., Nominal Wall Thickness Plus Inside Diameter of Pipe T.291 h) S.S.O.F.D., Wall Thickness Plus Allowable Weld Reinforcement (Both Sides).



WESTERN INSPECTION LTD.
 3231 - 58th AVENUE, S.E., CALGARY
 ALBERTA T2C 0B4
 TEL: (403) 279-4540
 FAX: (403) 236-3043

Daniel Industries Canada
 4215 - 72 Avenue S.E.
 Calgary, AB T2C 2G5
 Tel: (403) 279-1879 Fax: (403) 236-1337

Job Number: 7030908
 PO Number: P30908X

Date of Exam: Tuesday, Nov 12 2013
 Job Location: Western's Shop
 Technicians: Brandon Upstone CEDO-NRC Reg #12830; SNT LV. I

Legend:
 * (Loading)
 # (Result)
 @ (Degree)

ASME B31.3 Normal
 Pre Heat Treat
 Material: Carbon Steel
 Isotope: IR 192
 Focal Spot: 2x3 mm
 Curies: 74
 Degree: 100%
 Processing: Automatic
 Units: in

S = Single
 D = Double
 I = Triple
 AC = Accept
 REJ = Reject
 RETEST = Retest
 1 = Acceptable
 2 = Slight
 3 = Reject

Note: SFD Does not include reinforcement

| Comp# | Test# | Tech | IQI | Wldr | Dia | Thk | Len | Sch | SFD | Film | Type | Result Information | From - To |
|-------|-------|------|-----|------|-----|-----|-----|-----|-----|------|------|--------------------|-----------|
| | | | | | | | | | | | | | |

Units:
 Qty 16
 Code 4/XH/00

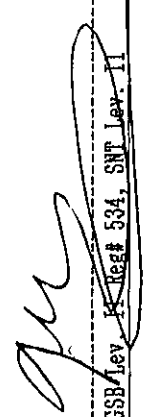
Sign Here: 
 Donald Mitchell CGSB Lev. II Reg# 534, SNT Lev. II

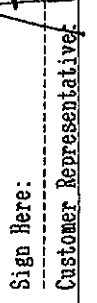
Sign Here: 
 Customer Representative:



WESTERN INSPECTION LTD.
 3231 - 58th AVENUE, S.E., CALGARY
 ALBERTA T2C 0B4
 TEL: (403) 279-4540
 FAX: (403) 236-3043

Daniel Industries Canada
 4215 - 72 Avenue S.E.
 Calgary, AB T2C 2G5
 Tel: (403) 279-1879 Fax: (403) 236-1337

Job Number: 7030908
 PO Number: P30908X

RADIOGRAPHIC EXAMINATION REPORT WY-441016

Date of Exam: Tuesday, Nov 12 2013
 Job Location: Western's Shop
 Technicians: Kendall Ready NRC Reg #15237, CEDO

Acc Codes: ASME B31.3 Normal
 Inspected: Pre Heat Treat
 Material: Carbon Steel
 Isotope: IR 192
 Focal Spot: 2x3 mm
 Curies: 37
 Degree: 100%
 Processing: Automatic
 Units: 10

Legend:
 * (Loading)
 # (Result)
 @ (Degree)

S = Single
 D = Double
 T = Triple
 ACC = Accept
 REJ = Reject
 RETEST = Retest
 1 = Acceptable
 2 = Slight
 3 = Reject

Note: SFD Does not include reinforcement

| Comp# | Test# | Feb# | IQI | Hdr | Dia | Fwk | Lev | Sch | SFD | Films | Type | Result Information |
|-------|-------|------|-----|-----|-----|-------|-----|-----|-----|-------|------|--------------------|
| 1 | X17 | RT1 | 1B | *X | 4 | 0.337 | 80 | 80 | 4.5 | S | 3 | D4-GBV-I ACC |
| 2 | X18 | RT1 | 1B | *X | 4 | 0.337 | 80 | 80 | 4.5 | S | 3 | D4-GBV-I ACC |
| 3 | X19 | RT1 | 1B | X | 4 | 0.337 | 80 | 80 | 4.5 | S | 3 | D4-GBV-I ACC |
| 4 | X20 | RT1 | 1B | X | 4 | 0.337 | 80 | 80 | 4.5 | S | 3 | D4-GBV-I ACC |
| 5 | X21 | RT1 | 1B | C | 4 | 0.337 | 80 | 80 | 4.5 | S | 3 | D4-GBV-I ACC |
| 6 | X22 | RT1 | 1B | C | 4 | 0.337 | 80 | 80 | 4.5 | S | 3 | D4-GBV-I ACC |
| 7 | X23 | RT1 | 1B | C | 4 | 0.337 | 80 | 80 | 4.5 | S | 3 | D4-GBV-I ACC |
| 8 | X24 | RT1 | 1B | C | 4 | 0.337 | 80 | 80 | 4.5 | S | 3 | D4-GBV-I ACC |

RT 1: T.291 g) S.O.D., Nominal Wall Thickness Plus Inside Diameter of Pipe T.291 b) S.S.O.F.D., Wall Thickness Plus Allowable Weld Reinforcement (Both Sides).

Units:
 Qty 8
 Code 4/80/00

Sign Here:
 Donald Mitchell, Reg# 534, SNT Lev. II

Sign Here:
 Customer Representative:

IMPORTANT: Please Sign And Return the Yellow Copy to Western Inspection Ltd. A.S.A.P.
 This Report and all associated material remain the sole property of Western Inspection Ltd. until such time as they are paid for in full.

11/13/2013 8:02:17 AM
 #REV-AR1818 Doc# 1



**INTEGRATED
METALLURGICAL SERVICES LTD.**

5110A - 77 Avenue S.E., Calgary, Alberta T2C 2Z2

Phone: 403-279-2666 Fax: 236-3677, e-mail: cpryde@nucleus.com/dolsen@nucleus.com

HEAT TREATING REQUIREMENTS

CUSTOMER : DANIEL INDUSTRIES CANADA

P.O. #: P30908P

MATERIAL : SA-106-B/SA-105N

DESCRIPTION:

12 - 4" SCH.80 SENIOR METER RUN
JOB #7030908, DWG. #DC-W-13-7030908

CADO INDUSTRIES

JOB NO: 7030908

LENGTH: 20-1/2", 33" O/L MAX.

WEIGHT: 2,200#'s TOTAL

DIA.: 4" O/D MAX.

WALL THK: .337" MAX.

PROCEDURE

1. Furnace Temperature shall not exceed: 425 °C on loading.
2. Heat Rate: 150 °C per hour.
3. Holding Temperature: 621 ±10 or ±14 or +10\ -0 °C
4. Holding Time: 60 Minutes Minimum
5. Cooling Rate: 150 °C/Hr. Max. to 425 °C

Issued to furnace #: 3

Furnace heat number: 3-13-134

Date: November 13, 2013

Issued by: C. Pryde

HEAT TREATMENT REQUIREMENTS

HyperLink back to Table of Contents

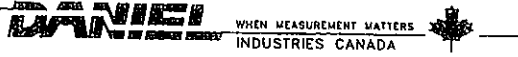

4215 - 72 AVENUE S.E.
CALGARY, AB.
T2C 2G5
TEL: 403-279-1879
FAX: 403-236-1337

DATE Nov 13/13

WORK ORDER # 7030908

P.O. # P30908P

CUSTOMER: Cado Ind.

DRAWING # DC-W-13-7030908 REV.#

DIAMETER: 4" LENGTH 20 1/2 + 33 + 33 WEIGHT: 2200 lbs PIECES: 12

PIPE THICKNESS .337 MATERIAL SA106/SA105N

TYPE OF HEAT TREATMENT Stress relieve

INSTRUCTIONS:

1. Temperature to be raised from 800° F to 1100-1200° F at a maximum rate of 400° F per hour. Note: Must not exceed 400° F per hour.
2. Temperature to be held at 1100-1200° for 60 minutes.
3. Temperature to be lowered from 1100-1200° F to 800° F at a rate of 500° F per hour. NOTE: Must not exceed a drop of 500° F per hour.
4. Additional Requirements:

SIGNATURE: [Signature]

#3-13-134
FURNACE HEAT #

[Signature]
OPERATORS SIGNATURE

NOVEMBER 13, 2013
DATE



Daniel Industries Canada Inc.
P.O. Box 727, Stn T (T2H 2H2)
4215-72 Avenue S.E.
Calgary, Alberta T2C 2G5
Canada
T 403-279-1879
F 403-236-1337

Date: Nov 21, 2013

Affidavit of Hydrostatic Test

Customer: Cado Industries

Daniel Work Order # 7030908

Daniel Industries Canada hereby certifies that these goods were hydrostatically tested and meet the Leak Test requirements of:

ASME B31.3 (✓) ASME B31.1 ()

Senior (✓) Simplex () OFU () Spools () Air Test () Chart ()

Size /ANSI: 4" 600#

Pressure: 2225 PSI (✓) KPA ()

Hour(s): 1 (✓), 2 (), 4 (), other () Hours

Serial#: 13340173

Serial#: 13210332

Serial#:

Serial#:

Serial#: 13300050

Serial#:

Serial#:

Serial#:

Serial#: 13250528

Serial#:

Serial#:

Serial#:

Verified By

Sign J. Becker

Print J. Becker

**Certificate of Calibration
Temperature Recorder**

Company: Integrated Metallurgical Services Ltd.
Address: 5110A 77th Avenue S.E.
Calgary, Alberta T2C 2Z2

Date: September 12, 2013
Due: December 12, 2013
Tech: H Reding

Description: Furnace # 3 Temperature Recorder, Type K Thermocouple
Make: Honeywell
Model: 15303816-24-43-2-000-002-10-002-C300

Serial #: 8926-5115378001
Range: 0 - 1200 °C

Calibration Data

| Input Value °C | As Found °C | As Found Error °C | As Left °C | As Left Error °C | Allowable Error °C |
|----------------|-------------|-------------------|------------|------------------|--------------------|
| 50.0 | 50 | 0 | 50 | 0 | ±14 |
| 300.0 | 300 | 0 | 300 | 0 | ±14 |
| 600.0 | 600 | 0 | 600 | 0 | ±14 |
| 900.0 | 900 | 0 | 900 | 0 | ±14 |
| 1150.0 | 1150 | 0 | 1150 | 0 | ±14 |

Comments: Recorder is within customer specification of ±14°C.

The test accuracy ratio of this calibration is at least 4:1 unless otherwise indicated. This unit has been calibrated using equipment and standards traceable to the National Research Council of Canada (NRC), the National Institute of Standards and Technology (NIST), or derived from accepted values of natural physical constants. This Certificate of Calibration applies only to the item described and shall not be reproduced, other than in full, without approval from Reding Instrument Services Ltd.

Calibration Standard(s) Used

| Asset Used | Model Number | Serial Number | Asset Due Date |
|------------|--------------|---------------|-----------------|
| Fluke | 725 | 1407008 | August 16, 2014 |



Technician

SEP 12 2013

Date



Sign Off (Customer)

SEPTEMBER 12, 2013

Date



**INTEGRATED
METALLURGICAL SERVICES LTD.**
5110A - 77 Avenue S.E., Calgary, Alberta T2C 2Z2

| | | |
|-----------------------------|--|-----------------|
| DATE: | NOVEMBER 13, 2013 | |
| CUSTOMER: | DANIEL INDUSTRIES CANADA | |
| ORDER NO: | P.O. #P30908P | |
| JOB NO: | 7030908 | |
| PROCEDURE: | P.W.H.T. | |
| HEAT TREATING PER: | A.S.M.E. | |
| RATE OF RISE: | MOD. To 425°C to 621°C at 150°C/Hr. | |
| HOLDING TEMP.: | 621°C ±14° C | |
| HOLDING TIME: | 60 Min. Minimum | |
| COOLING RATE: | 621°C to 425°C at 150°C | |
| MATERIAL: | SA-106-B/SA-105N | |
| NOTES: | 12 PCS. 4"Sch/80 SENIOR MEYER RUN 4"O/Dx20-1/2", 33"O/Lx.337"wall MAX. 2,200#'s TOTAL JOB #7030908, DWG. #DC-W-13-7030908 CADO INDUSTRIES | |
| OPERATOR: | Collin Pryde | Heat: #3-13-134 |
| SIGNING FOR I.M.S. LTD.: | | |

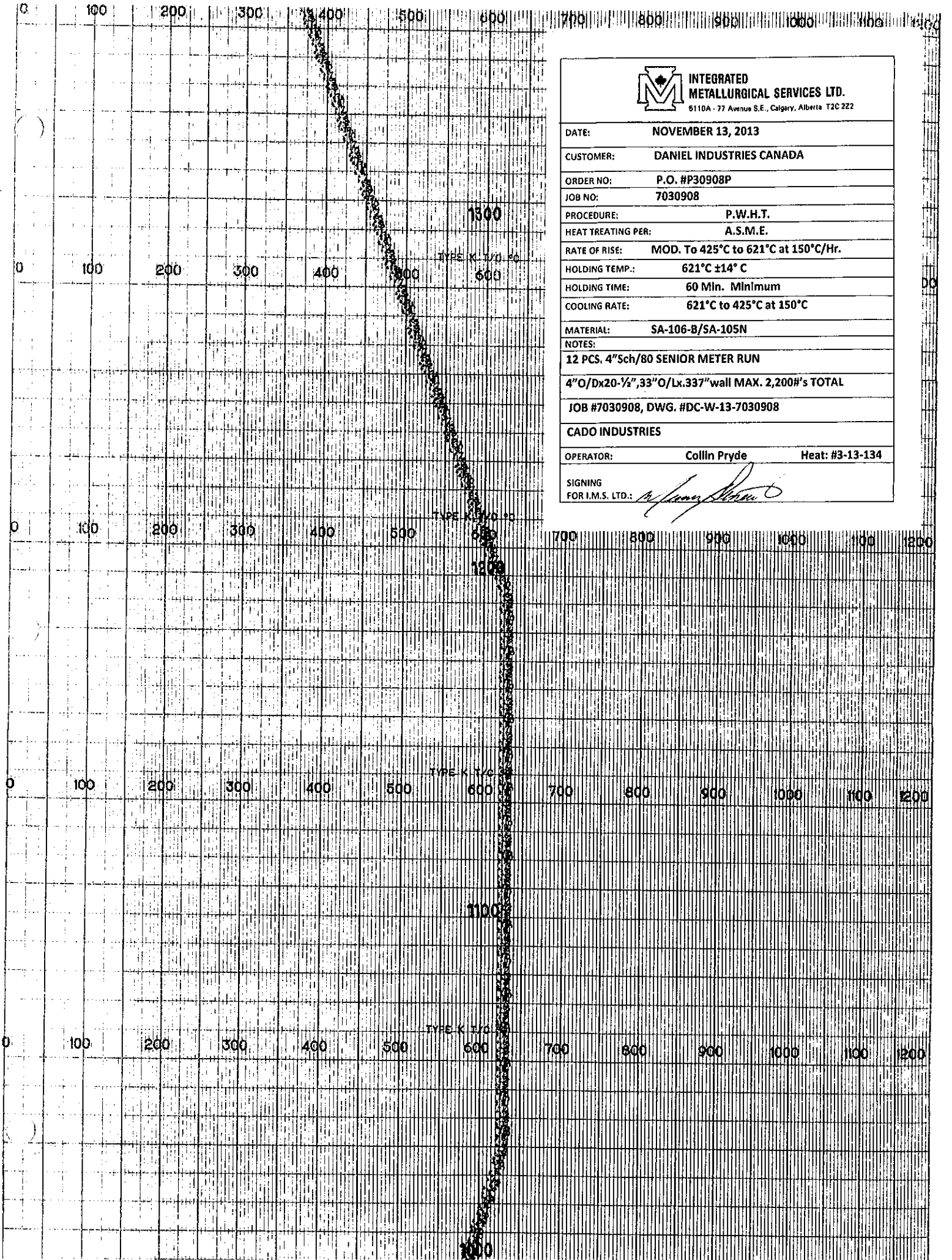



SECTION 4:
DRAWINGS



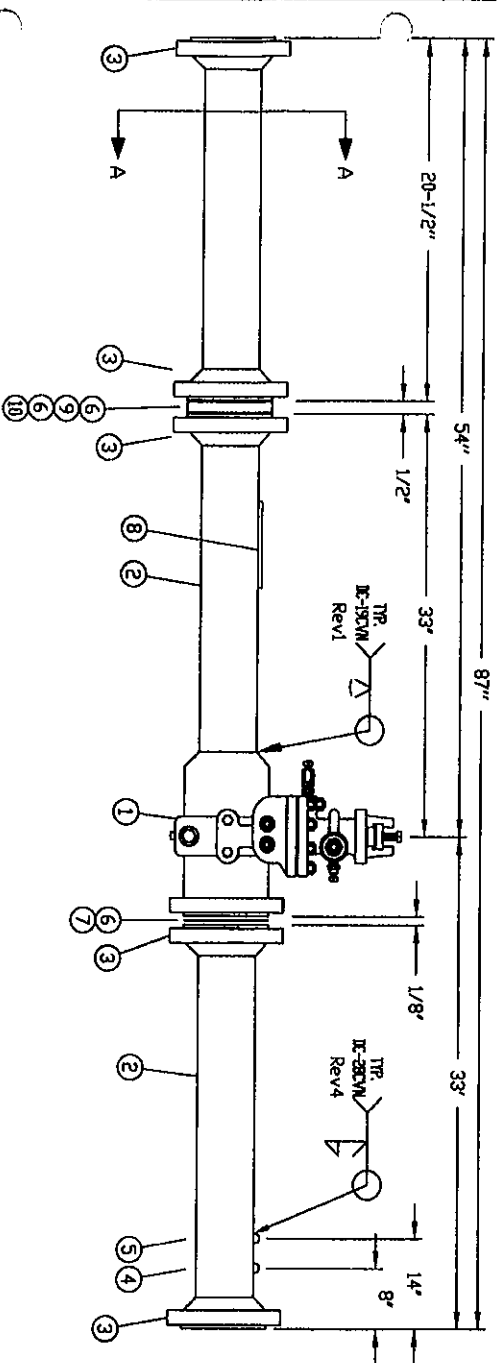
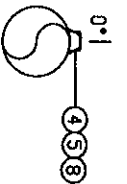
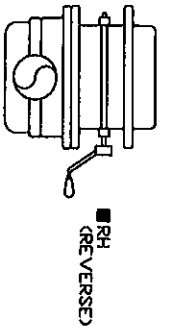

NOTES & TAGGING

- 1) MANUFACTURED IN ACCORDANCE WITH ASME B31.3.2010
- 2) MANUFACTURED IN ACCORDANCE WITH AGA REPORT 3, 4TH EDITION (2000)
- 3) DIMENSIONS AS PER CPA RECOMMENDATIONS.
- 4) PART INCLUDED

SPECIFICATIONS

| | |
|-------------|-------------------------|
| QUANTITY: | 4 |
| LINE SIZE: | 4" SCH. 80 |
| RATING: | 600#, -20 DEGREE F |
| MODEL: | DISC/DISC, WCB |
| TYPE: | FLANGEX SENDER |
| TRIM: | STD |
| AGA FIG/BR: | AGA2000/ BETA 0.75 |
| CRN: | 06093921 06063421 |
| MAWP: | 1480 PSI @ 100 DEGREE F |

APPROVED FOR CONSTRUCTION
 Valdivia Duarte Vargas
 Oct 11, 2013

| | | |
|-----|----------|-----|
| REV | yy/mm/dd | INT |
| 1 | - | - |
| 2 | - | - |
| 3 | - | - |
| 4 | - | - |

| | | | |
|-----------|-----------------------|-----------|-----------------|
| P.I.#: | 2013-070-8302 | DATE: | 25-09-20 |
| CUSTOMER: | CADD INDUSTRIES | LOCATION: | CALGARY-ALBERTA |
| END USER: | PENW WEST EXPLORATION | REV: | 00 |
| DRAWN BY: | YD | DWG#: | DC-V-13-7030908 |



NDT REQUIREMENTS

| | |
|-----------------------|-------------------------------------|
| RADIOGRAPHY: | B31.3N ASNT II 100Z - ALL WELDS |
| HYDROTEST: | YES, 1 HOUR AT 1.5X DESIGN PRESSURE |
| STRESS RELIEF: | YES |
| HARDNESS TEST: | NO |
| MAGNETIC PARTICLE: | NO |
| LIQUID DYE PENETRANT: | NO |

INSPECTION

| | | |
|--|-----|----|
| DANIEL INSPECTION | YES | NO |
| INDUSTRY CANADA INSPECTION (QUAL & EXISTE PLATE) | X | |
| FULL API 14.3 INSPECTION | X | |
| SELECT CHEMISTRY: | X | |

BILL OF MATERIAL (ONE RUN ONLY)

| ITEM | QTY | DESCRIPTION |
|------|-----|---|
| 1 | 1 | 4" S/80 600# RF, MODEL DISC, STD TRIM |
| 2 | 1 | NAME SENDER FITTING |
| 3 | 1 | 4" S/80 SA-106 GRB COLD DRAWN/HOTD SMLS PIP |
| 4 | 1 | 4" S/80 600# RF W/ SA-105N FLANGE |
| 5 | 1 | 1" 6000# SA-105N TIE |
| 6 | 1 | 3/4" 6000# SA-105N TIE |
| 7 | 1 | 4" 600# 316SS FLEX GASKET |
| 8 | 1 | 7/8" X 5-3/4" B7M STUD V/ (2) 2HM NUTS EA. |
| 9 | 1 | DANIEL NAMEPLATE V/ METER RUN SN & TAGGING SA-36 DR EQUAL |
| 10 | 1 | CPA SOE FLOW CONDITIONING PLATE - 316SS |
| 11 | 1 | 7/8" X 6-1/4" B7M STUD V/ (2) 2HM NUTS EA. |
| 12 | 1 | DAN TAN PRIMER |
| 13 | 1 | DWNER OPERATOR SPECS APPL'Y NO |