

Hydrogen Sulfide Analyzer Model 330 & 331

User's Manual



Table of Content

INTRODUCTION	1
Contacting Envent Engineering Ltd.....	1
Canada Office: (Main)	1
USA Office:	1
China Office:.....	1
Warranty & Liability Statements	2
Limitation of Warranty	2
Disclaimer	2
Warnings & Cautions.....	3
Warning & Cautions for 330 & 331 H ₂ S Analyzers.....	3
Warning & Cautions for 330 Analyzer Only.....	4
Warning & Cautions for 331 H ₂ S Analyzer Only	4
Analyzer Certifications: Area Classification	5
Certification under CSA Standards Mark# MC 235646.....	5
Products.....	5
Applicable Requirements.....	6
Certification under CSA Standards ETL Mark# 4002458.....	7
Products.....	7
Applicable Requirements.....	8
Analyzer Specifications	9
Key Symbols.....	10
PRINCIPLE OF OPERATION.....	11
Physical Reaction.....	11
Analysis Cycles.....	12
ANALYZER COMPONENTS.....	15
Controller Board	15
Power Connection.....	15
Solenoid Output Drivers & Furnace Output.....	15
Dry Contact Relays.....	16
Analog Outputs	16
Digital Inputs	17
Serial Ports & I2C.....	17
LCD Display Board	18
Sample Chamber.....	19
Sensor Block.....	19
Window & Gasket.....	19
Aperture Strip.....	19
Trigger Slide	20
Sample flow Components.....	21
Flowmeter	21
Humidifier Unit.....	21
Eductor Block	23
Sample Conditioning System.....	25
Filter Housing, Pressure Regulator & Pressure Gauge (Conventional).....	26
Filter Housing	26

Pressure Regulator	26
Pressure Gauge.....	26
Three-way valve.....	26
Sweep Needle Valve.....	26
Envent IFR Filter Housing, Regulator & Pressure Gauge (Alternative)	27
Pressure Regulator and Filter Housing	27
Pressure Gauge.....	27
Three-way valve.....	28
Sweep Needle Valve	28
Optional Components	28
Low H ₂ S sensing Tape Sensor.....	28
Low Pressure Switch.....	29
Power AO Boards	30
Ethernet Communication Card	30
INSTALLATION	31
Installation Requirements	31
Electrical Requirements.....	31
Location for the System.....	31
Space Requirements.....	32
Sample Point Selection	33
Sample inlet & sample sweep.....	33
Vent line.....	33
Sample Volume & Flow Rate.....	34
Receiving the Analyzer.....	35
Unpacking the Analyzer	35
Standard spare parts for 330 H ₂ S analyzers:.....	35
Standard spare parts for 331 H ₂ S analyzers:.....	36
Installation procedure & Start-up.....	36
OPERATION & CONFIGURATION.....	38
Analyzer Display Interface	38
Analyzer Software Interface	39
Introduction to the 330/331 H ₂ S Software.....	39
Using the H ₂ S Software	40
Scan IO Tab	45
Application Tab	45
Stream Setup Tab.....	46
Stream#1 & #2	46
Alarm Tab	51
Configuration Tab.....	52
LCD Setup	57
Archive Setup.....	58
Archive View	59
Modbus	60
CALIBRATION PROCEDURES	61
H ₂ S Gas Calibration.....	61
Re-zero Sensor Procedure.....	62

MAINTENANCE	64
H ₂ S Sensing Tape Change Procedure	64
Sample Conditioning System Cleaning Procedure	65
Material List.....	65
Procedure	65
TROUBLESHOOTING.....	67
APPENDICES	77
Modbus Registry.....	77
Recommended Spare Parts List	78
Chico A Sealing Compound: For sealing fittings in Hazardous Locations	78
Safety Data Sheet for H ₂ S Sensing Tape	79

List of Figures

Figure 1. H ₂ S Analyzer Principle of Operation Diagram	12
Figure 2. H ₂ S Analysis Cycle	13
Figure 3. H ₂ S Controller Board Front View (Customer Connections).....	15
Figure 4. Relay & Solenoid Outputs.....	16
Figure 5. AO 4-20 mA Output Wiring Options.....	17
Figure 6. RS-232 Serial Port wired to a DB9 Female Connector	18
Figure 7. 330 & 331 H ₂ S Analyzer Bare Two-Line Display	18
Figure 8. Sample Chamber (Exploded View).....	19
Figure 9. Trigger Slide Installed on a 330 H ₂ S Analyzer (Applicable for 331 Analyzers)	21
Figure 10. Envent's Humidifier Unit.....	22
Figure 11. Humidifier Unit Installed in a 331 H ₂ S Analyzer	23
Figure 12. Eductor Block (Venturi Effect)	24
Figure 13. PI&D Diagram of Standard Sample System for 330 & 331 H ₂ S Analyzers.....	25
Figure 14. Conventional Standard Sample System.....	27
Figure 15. Alternative Standard Sample System	28
Figure 16. Low H ₂ S Sensing Tape Sensor.....	29
Figure 17. Internal & External Pressure Switches	29
Figure 18. Analog Output Board	30
Figure 19. Ethernet Communication Card.....	30
Figure 20. Space Requirements for the 330 & 331 H ₂ S Analyzers	32
Figure 21. 331 Recommended Venting for 331 (Same as the 330 H ₂ S Analyzer).....	34
Figure 22. 330 Display (left) & 331 Display (right).....	38
Figure 23. H ₂ S Software: Enable Communication	40
Figure 24. H ₂ S Software: Analyzer Connection Failed.....	41
Figure 25. H ₂ S Software: Uploading & Save As Button.....	42
Figure 26. H ₂ S Software: User View	43
Figure 27. H ₂ S Software: Active Data Polling in User View	44
Figure 28. H ₂ S Software: Change from User to Factory View.....	44
Figure 29. H ₂ S Software: Scan IO Tab.....	45
Figure 30. H ₂ S Software: Application Tab.....	46
Figure 31. H ₂ S Software: Stream Setup Tab: Stream 1 & 2 Tab.....	46
Figure 32. H ₂ S Software: Stream Setup Tab: Cal. Stream 1 & 2.....	49

Figure 33. H ₂ S Software: Alarm Tab: Alarm 1 to 8 Tabs	51
Figure 34. H ₂ S Software: Configuration Tab: Analog Input 1 & 2 Tabs	53
Figure 35. H ₂ S Software: Configuration Tab: Analog Outputs 1 & 2 Tabs	54
Figure 36. H ₂ S Software: Configuration Tab: Discrete Input Tab	55
Figure 37. H ₂ S Software: Configuration Tab: Discrete Output Tab.....	56
Figure 38. H ₂ S Software: LCD Setup Tab.....	57
Figure 39. H ₂ S Software: Archive Setup Tab.....	58
Figure 40. H ₂ S Software: Archive View Tab	59
Figure 41. H ₂ S Software: Modbus Tab.....	60
Figure 42. 331 H ₂ S Sensing Tape Change Procedure (Applicable for 330 Analyzers)	64

List of Tables

Table 1. 330/331 H ₂ S Analyzer Specifications	9
Table 2. Aperture Strips & Ranges	20
Table 3. Sample Volume and & Flow Rate	34
Table 4. Display Button Description/Function	38
Table 5. Display LED Description/Function	39

INTRODUCTION

This manual provides all the necessary information to install, operate and maintain the 330 and 331 H₂S Analyzer units. This manual is intended for technicians and operators.

The Envent's 330/331 H₂S Analyzer is a uniquely rugged and simple design that utilizes lead acetate based detection which provides a linear and interference-free output of H₂S concentration. This analyzer can measure a wide range of hydrogen sulfide concentrations from parts per billion (ppb) concentrations to parts per million (ppm) concentrations. With the addition of a dilution sample system, it can read in high concentrations in percentage up to 100%.

There are other options available such as the sample system for H₂S analysis in liquids or the addition of a hydrogen reaction furnace for total sulfur measurements.

Contacting Envent Engineering Ltd

This manual covers most of the important information the user is going to need to install, operate and maintain the 330/331 H₂S Analyzers. If more information is required, you can contact us at:

Canada Office: (Main)

Toll Free: 1 (877) 936 - 8368

Tel: (403) 253 - 4012

Fax: (403) 253 - 4016

Email: info@envent-eng.com

Hours of operation: Monday to Friday – From 8:00 am to 4:30 pm (Mountain Time Zone). Offices closed on statutory holidays.

USA Office:

Tel: 1 (713) 567 - 4421

China Office:

Tel: (86) 138 - 0119 - 1148

For further information on our products and most updated manuals/product catalog please visit: www.envent-eng.com

Warranty & Liability Statements

Products manufactured and supplied by Envent Engineering Ltd unless otherwise stated are warranted against defects in materials and workmanship for 18 months from the date of shipment or 12 months from date of start-up, whichever occurs first. During the warranty period the manufacturer will, as its option, either repair or replace products, which prove to be defective.

The manufacturer or its representative can provide warranty service at the buyer's facility only upon prior agreement. In all cases the buyer has the option of returning the product for warranty service to a facility designated by the manufacturer or its representatives. The buyer shall prepay shipping charges for products returned to a service facility, and the manufacturer or its representatives shall pay for return of the products to the buyer. The buyer may also be required to pay round-trip travel expenses and labour charges at prevailing labour rates if warranty is disqualified for reasons listed below.

Limitation of Warranty

The foregoing warranty shall not apply to defects arising from:

- Improper or inadequate maintenance by the user,
- Improper or inadequate unpacking or site preparation/installation,
- Unauthorized modification or misuse,
- Operation of the product in unfavorable environments, especially high temperature, high humidity,
- Corrosive or other damaging atmospheres or otherwise outside published specifications of analyzer.

Envent Engineering Ltd carries no responsibility for damage cause by transportation or unpacking, unless otherwise specified in the incoterms.

Extended warranty may be available with certified start-up. Contact Envent Engineering Ltd for details.

Envent Engineering Ltd reserves the right to change the product design and specifications at any time without prior notice.

Disclaimer

No other warranty is expressed or implied. The manufacturer specially disclaims the implied warranties of merchantability and fitness for a particular purpose.

The sole remedy of the buyer shall in no case exceed the purchase price of the analyzer.

The manufacturer shall not be liable for personal injury or property damage suffered in servicing the product. The product should not be modified or repaired in a manner at variance with procedures established by the manufacturer.

Warnings & Cautions

This section covers all warnings and cautions for the 330 and 331 H₂S analyzers. They are divided into warnings and cautions applicable to both 330 and 331, only 330 and only 331 H₂S analyzers. Please read and understand all statements as they are for your own safety when installing, operating and maintaining the analyzer(s). These statements will also be noted throughout the manual when relevant.

Warning & Cautions for 330 & 331 H₂S Analyzers



Do not disconnect equipment unless power has been switched off or area is known to be non-hazardous.



Turn off power before servicing. Ensure breakers are off before connecting or disconnecting power supply.



The analyzer should be mounted in an area in which it is not exposed to vibration, excessive pressure, temperature and/or environmental variations.



Disassembly of the pressure regulator and solenoids in the field is not advised. Consult the factory if the regulator or solenoid appears contaminated.



Before resuming line pressure, be sure that all port connections, sample sweep and sample conditioning system are securely installed.



All connections must be leaktight to ensure the effectiveness of the analyzer as well as safety. The user is solely responsible for the product selection, safety and warning requirements for the application. If the equipment is used in a manner not specified by Envent Engineering Ltd, the protection provided by the equipment may be impaired.



Do not use solvents, brake cleaners, soaps, detergents or rubbing alcohol to clean up analyzer or sample system.



This unit may require a disconnect device rated 24 VDC and 5A max. It must be protected by a circuit breaker rated 24 VDC and 5A max, and it is to be installed in accordance with local electrical codes.



This unit may require a disconnect device rated 240 VDC and 5A max. It must be protected by a circuit breaker rated 240 VDC and 5A max, and it is to be installed in accordance with local electrical codes.



Incorrect configuration of the analyzer may cause incorrect operation. Injury and/or damage to facilities may occur. Check analyzer's functionality after configuration changes have been made.



Envent Engineering H₂S Sensing Tapes are suitable for use, if stored in the original sealed package, for 10 years from date of manufacture. Tapes should be stored in a cool dry location. If the seal on the package has been broken in storage, the H₂S Sensing Tape should be discarded.

Warning & Cautions for 330 Analyzer Only



Substitution of components may impair intrinsic safety.



Open circuit before removing cover.



Ensure that the analyzer received is suitable for the electrical classification of the installation site.

- The 330 is designed for Class I, division 1 Groups C&D or Groups B, C&D (Check Analyzer Nameplate)



The glass window on the XP enclosure must remain installed in order to maintain area classification.



Seals not poured. Pour seals before energizing the circuit (See "Chico A Sealing Compound: For sealing fittings in Hazardous Locations" on page 78 for further details).



Analyzer may utilize an optional CCS, Model 646 Series pressure switch located on the side of the XP enclosure:

- Dual seal, MWP 500psi
- Annunciation is visible leakage from the pressure adjustment cover (flow from this cover can indicate the possibility that a failed primary seal condition could exist in the pressure switch).

Warning & Cautions for 331 H₂S Analyzer Only



Substitution of components may impair suitability for Class I, Division 2.



The eductor is required with this model in order to maintain electrical safety and certification in division 2 areas.

Analyzer Certifications: Area Classification



All H₂S analyzers sold until Feb 29th, 2016 are Certified under CSA standards
CSA Mark # MC 235646

All H₂S analyzers sold from March 01st, 2016 are certified to CSA standards
under the ETL Mark #4002458

Certification under CSA Standards Mark# MC 235646

Products

CLASS 2258-02 – PROCESS CONTROL EQUIPMENT – For Hazardous Locations

Class I, Division 1, Group B, C & D:

Model 330, 330S and 330SDS H₂S Analyzer, rated 12-24 VDC or 100-240 VAC 50/60Hz, 5A Max. Temperature Code T3C; Ambient Temperature Range 0°C + 50°C. Dual Seal MWP 2 PSI.

Class I, Division 1, Group B, C & D:

Model 330, 330S, 330SDS Total Sulfur Analyzer, rated 12-24 VDC or 100-240 VAC 50/60Hz, 5 A Max. Temperature Code T3C; Ambient Temperature 0°C + 50°C. Dual Seal MWP 2 PSI.

Class I, Division 2, Group A, B, C & D:

Model 331, 331S and 331SDS H₂S Analyzer, rated 12-24 VDC or 100-240 VAC 50/60Hz, 5A Max. Temperature Code T3C; Ambient Temperature Range 0°C + 50°C.

Class I, Division 2, Group B, C & D:

Model 331, 331S, 331SDS Total Sulfur Analyzer, rated 12-24 VDC or 100-240 VAC 50/60Hz, 5 A Max. Temperature Code T3C; Ambient Temperature 0°C + 50°C.

CLASS 2258-82 – PROCESS CONTROL EQUIPMENT – For Hazardous Locations – Certified to US Standards

Class I, Division 1, Group B, C & D:

Model 330, 330S and 330SDS H₂S Analyzer, rated 12-24 VDC or 100-240 VAC 50/60Hz, 5A Max. Temperature Code T3C; Ambient Temperature Range 0°C + 50°C.

Class I, Division 1, Group B, C & D:

Model 330, 330S, 330SDS Total Sulfur Analyzer, rated 12-24 VDC or 100-240 VAC 50/60Hz, 5 A Max. Temperature Code T3C; Ambient Temperature 0°C + 50°C.

Class I, Division 2, Group A, B, C & D:

Model 331, 331S and 331SDS H₂S Analyzer, rated 12-24 VDC or 100-240 VAC 50/60Hz, 5A Max. Temperature Code T3C; Ambient Temperature Range 0°C + 50°C.

Class I, Division 2, Group B, C & D:

Model 331, 331S, 331SDS Total Sulfur Analyzer, rated 12-24 VDC or 100-240 VAC 50/60Hz, 5 A Max. Temperature Code T3C; Ambient Temperature 0°C + 50°C.

Applicable Requirements

CSA Standard C22.2 No. 0-10 – General Requirements Canadian Electrical Code Part II.

CSA Standard C22.2 No.0.4-M2004 – Bonding of Electrical Equipment.

CSA Standard C22.2 No.30-M1986 – Explosion-Proof Enclosure for Use in Class I Hazardous Locations.

CSA Standard C22.2 No.142-M1987 – Process Control Equipment.

CSA Standard C22.2 No.157-M1992 – Intrinsically Safe and Non-Incendive Equipment for Use in Hazardous Locations.

CSA Standard C22.2 No. 213-M1987 – Non-Incendive Electrical Equipment for Use in Class I, Division 2 Hazardous Locations.

ANSI-ISA 12.27.01-2011 – Requirements for Process Sealing Between Electrical Systems and Flammable or Combustible Process Fluids.

UL Standard 508, Seventeenth Edition – Industrial Control Equipment.

UL Standard 913, Seventh Edition – Intrinsically Safe Apparatus and Associated Apparatus for use in Class I, II, III, Division 1, Hazardous (Classified) Locations.

ANSI-ISA 12.12.01-2011 – Non-Incendive Electrical Equipment for Use in Class I and II, Division 2 and Class III, Divisions 1 and 2 Hazardous (Classified) Locations.

UL Standard 1203, Fourth Edition – Explosion-Proof and Dust-Ignition-Proof Electrical Equipment for Use in Hazardous (Classified) Locations.

Certification under CSA Standards ETL Mark# 4002458

Products

Process Gas Analyzer certified for Canadian Standards:

330, 330S, and 330SDS - H₂S Analyzer, Class I, Division 1, Groups BCD. Dual Seal, MWP 2 PSI.

Notes: 1) Equipment is only acceptable for use in Class I, Division 1, Groups C and D when provisioned with Model XFA2 Pressure Switch.

2) The Dual Seal MWP rating is applicable to the Sample Gas pressure present at the Heating Chamber Assembly. Models may have an optional pressure sensor installed which is separately identified as being Dual Seal, MWP 500 PSI.

330, 330S, and 330SDS - Total Sulphur Analyzer, Class I, Division 1, Groups BCD. Dual Seal, MWP 2 PSI.

Note: The Dual Seal MWP rating is applicable to the Sample Gas pressure present at the Heating Chamber Assembly. Models may have an optional pressure sensor installed which is separately identified as being Dual Seal, MWP 500 PSI.

331, 331S and 331SDS H₂S Analyzer, Class I, Division 2, Groups A, B, C and D.
331, 331S and 331SDS Total Sulphur Analyzer, Class I, Division 2, Groups A, B, C and D.

Process Gas Analyzer certified for US Standards:

330, 330S, and 330SDS - H₂S Analyzer, Class I, Division 1, Groups BCD.

Note: Equipment is only acceptable for use in Class I, Division 1, Groups C and D when provisioned with Model XFA2 Pressure Switch.

330, 330S, and 330SDS - Total Sulphur Analyzer, Class I, Division 1, Groups BCD.

331, 331S, and 331SDS - H₂S Analyzer, Class I, Division 2, Groups ABCD.

331, 331S, and 331SDS - Total Sulphur Analyzer, Class I, Division 2, Groups BCD

Temperature code (all products): T3C

Ambient Temperature Range (all products): 0°C to 50 °C

Applicable Requirements

CSA C22.2 No.142–Issued:1987/05/01 Process Control Equipment General Instruction No 1-5 (R2009): 2009/08/18

CSA C22.2 No. 157– Issued: 1993/10/01 (R2012) Intrinsically Safe and Non-Incendive Equipment for Use in Hazardous Locations; Gen. Inst. No. 1: 1993, Gen. Inst. No. 2: 2003

CSA C22.2 No. 213– Issued: 2015/08/21 Nonincendive Electrical Equipment for Use in Class I and II, Division 2 and Class III, Divisions 1 and 2 Hazardous (Classified) Locations

CSA C22.2 No. 30 –Issued: 1986/11/01 (R2012) Explosion-Proof Enclosures for Use in Class I Hazardous Locations General Instruction No. 1, 1986, General Instruction No. 2, 1988

ANSI/ISA 12.27.01– Issued: 2011/01/01 Requirements for Process Sealing Between Electrical Systems and Flammable or Combustible Process Fluids

UL 508– Issued: 1999/01/18 Ed: 17 Rev: 2013/10/16 Industrial Control Equipment

UL 913– Issued: 2006/07/31 Ed: 7 Rev: 2011/09/23 Intrinsically Safe Apparatus and Associated Apparatus for Use in Class I, II, and III, Division I, Hazardous (Classified) Locations

ANSI/ISA 12.12.01–Issued: 2015/08/21 Nonincendive Electrical Equipment for Use in Class I and II, Division 2 and Class III, Divisions 1 and 2 Hazardous (Classified) Locations

UL1203– Issued: 2013/11/22 Ed: 5 Explosion-Proof & Dust-Ignition-Proof Electrical Equipment for Use in Hazardous (Classified) Locations.

Analyzer Specifications

Analyzer Specification	
Measurement Method	ASTM D4084 - 07: Standard Test Method for Analysis of Hydrogen Sulfide in Gaseous Fuels (Lead Acetate Reaction Rate Method)
Ambient Temperature	0-50 °C (standard) consult factory for other requirements, 0 to 90% humidity (non-condensing)
Power	12-24 VDC @ less than 3W
	Or, 100-240 VAC 50/60 Hz, 5W, (300W when total sulfur option is included)
Electrical Certification	330 Class I, Division 1 Groups B,C&D
	331 Class I, Division 2 Groups A,B,C&D
	Certified to CSA standards under the CSA Mark # MC 235646 (H ₂ S Analyzers sold up to Feb 29, 2016) Certified to CSA standards under the ETL Mark #4002458 (H ₂ S Analyzers sold from March 01, 2016 and on)
Output Ranges	Standard ranges are between 10-100 ppb and 0-100 ppm
Response Time	20 seconds to 90% of step change
Accuracy	±1.5% of full range
Display	2 x 16 character LCD with back lighting; menu is scrolled by internal button or magnetic wand (330)
Outputs	Two 4-20mA outputs (loop power required), optional 4-20mA powered output boards are available
	Serial (1) RS-232 Modbus protocol (1) RS-485 Modbus protocol
	Two additional serial ports plus Ethernet as an option
	4 SPDT relays (120 VAC 5A maximum) 4 solid state solenoid drivers
Optional Equipment	
Total Sulfur	Utilized when all sulfur compounds need to be measured. A Total sulfur reaction furnace is added which allows the analyzer to measure total sulfur
Dilution Sample System	Utilized when the analyzer needs to measure ranges above 100 ppm. A permeable membrane dilution system
Liquid Sampling	Utilized when a liquid sample conditioning system is required to measure hydrogen sulfide in Liquids
Parts Per Billion	Utilized when analyzer requires to read in parts per billion (<1 ppm)
Low Tape Sensor	Utilized when an alarms is required when the H ₂ S sensing tape needs to be changed
Low Pressure Switch	Utilized for alarming when sample pressure drops below 10 PSI
AO Powered Boards	Utilized for loop-powered analog outputs
Stream Switching	Switches between two sample streams or between hydrogen sulfide and total sulfur measurement
Ethernet Port	Utilized for TCP/IP communication capabilities
Auto Calibration	Utilized to initiate a calibration based on time of day or manually

Table 1. 330/331 H₂S Analyzer Specifications

Key Symbols

The following symbols are used throughout this manual. They are intended to draw attention to important information.



Description of hazards that could result in mayor injury or death.



Description of hazards that could result in minor injury or property damage.



Description of important information regarding safety of personal and/or property.



Description of useful information to help understand a concept.

PRINCIPLE OF OPERATION

Physical Reaction

Envent's models 330 and 331 H₂S analyzers use ASTM D4084 – 07: Standard Test Method for analysis of hydrogen sulfide in gaseous fuels (Lead Acetate reaction rate method). This method uses lead acetate impregnated paper. Throughout this document the term lead acetate tape will be written as "H₂S sensing tape". Refer to "Safety Data Sheet for H₂S Sensing Tape" on page 79 for safety information on the H₂S sensing tape.

The H₂S sensing tape reacts when in contact with hydrogen sulfide by the compound relationship shown below. This tape does not react to any other sulfur compound in the gas stream. This makes it free from interference when more than one sulfur compound is present in the sample stream. The H₂S reaction is visibly evident by a brown stain directly on the H₂S sensing tape.

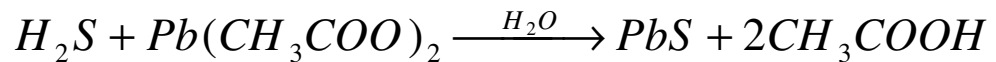

The electronics built into the models 330 and 331 have been programmed to measure the rate of darkening over time which, in turn, gives the hydrogen sulfide concentration. When no H₂S is in contact with the H₂S sensing tape, the analyzer sensor reads 1000 mV (+/- 100 mV).

The sensor block has a LED and a photodiode detector. The LED emits a red beam of light which is reflected off of the H₂S sensing tape to the photodiode which detects the light intensity. The darker the H₂S sensing tape becomes when in contact to H₂S, the less light the photodiode detector receives reducing the millivolt value, which in turn, increases the H₂S Value.

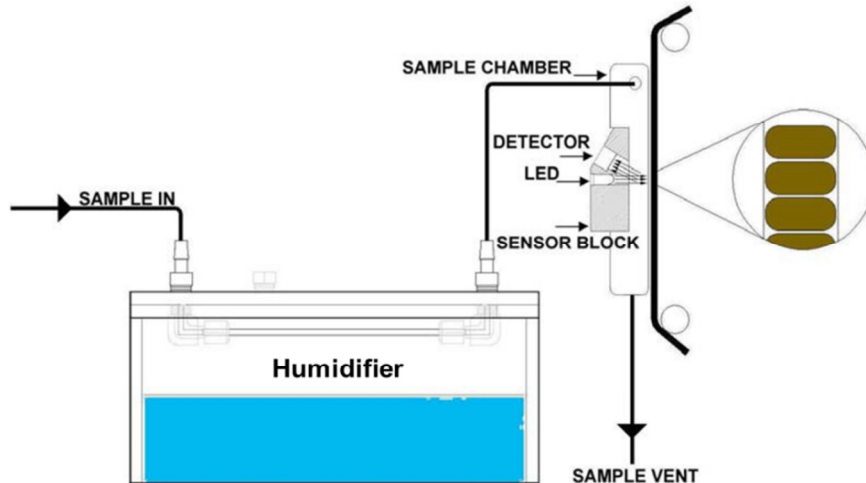

Figure 1. H₂S Analyzer Principle of Operation Diagram

Figure 1 above shows a flow and pressure regulated of a filtered sample gas passing through the humidifier into the sample chamber. An aperture in the sample chamber, which differs in sizes depending on the application, allows the gas to come in contact with the H₂S sensing tape creating a brown stain.



Flow and pressure are the most important variables when measuring H₂S and must be kept at a constant state for the analyzer to measure H₂S properly. Pressure should be kept at a constant 15 psig. The lowest pressure found to be tolerable for proper H₂S measurement is 0.5 psig. Flow must be kept at a constant flow of 2 cm (between 100-200 cc/min). A change in flow of +/- 1 cm affects the reading by 10% of full range.

Analysis Cycles

The analysis of the color rate of change on the H₂S sensing tape is measured in analysis cycles. An analysis Cycle lasts up to a maximum of 360 seconds (6 minutes). For some applications, such as parts per billion, the maximum analysis cycle is increased more than 360 seconds.



Do not change the Maximum Analysis Time, consult Envent Engineering Ltd.

Once an analysis cycle is complete, the motor moves the H₂S sensing tape giving the sensor block new tape surface area to start the analysis again. In normal operation, if the analyzer is being exposed to H₂S within its range, the analysis cycle should last between 170 to 220 seconds; the cycle lasts 360 seconds if no H₂S is present.

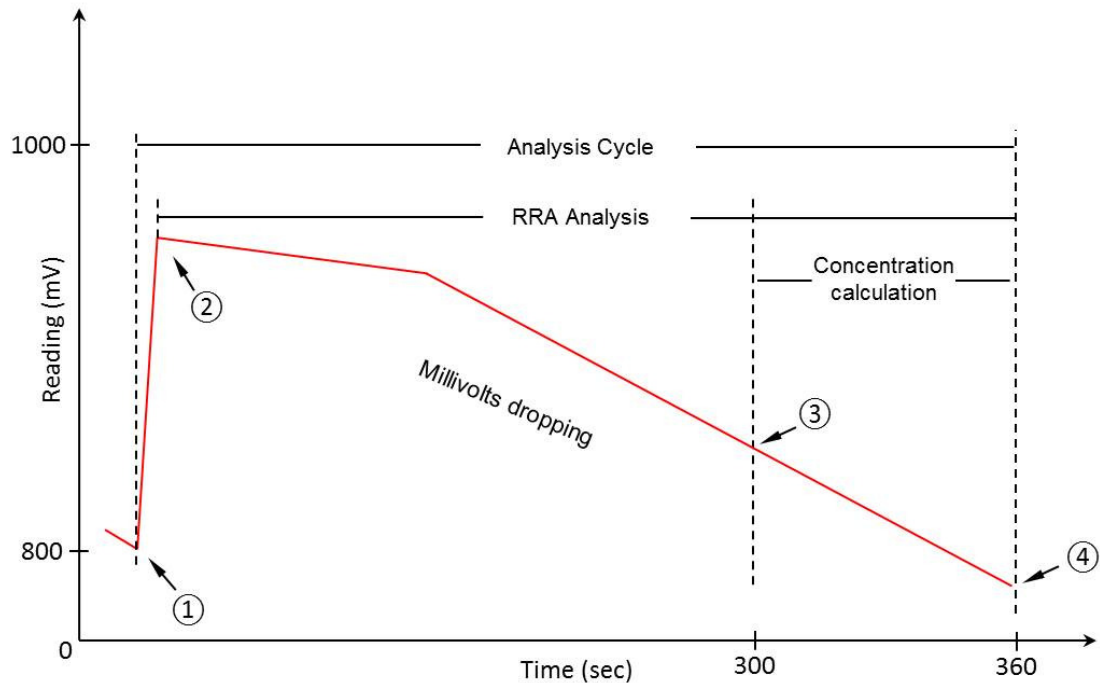

Figure 2. H₂S Analysis Cycle

Figure 2 shows a complete analysis cycle from when the motor has advanced the H₂S sensing tape from a previous analysis (1), to the end of the current analysis (4). Once the H₂S sensing tape has finished moving and new tape surface area is exposed, the reflection of light from the LED to the photodiode detector is at its maximum and results in a voltage output from the sensor block of 1000 mV (+/- 100 mV). This voltage is captured by the analyzer and it is referred to as the "Zero Voltage". The zero voltage will vary for each surface area of the H₂S sensing tape and will represent the starting point for the H₂S reading for that cycle.

From stage (2) to (4) the H₂S value starts increasing as the millivolt value drops from exposure to H₂S. This stage is called "RRA Analysis". The RRA stands for Rapid Response Algorithm and it is the instantaneous H₂S readings calculated over the previous 10 seconds. The RRA new readings are calculated every 67 ms. As the H₂S sensing tape darkens, the RRA value starts going up every second. Although the RRA is almost instantaneous, it is not as accurate as the final reading obtained at the "Concentration Calculation" stage (3) to (4). RRA can be used as a trigger alarms setpoint in case the application requires a rapid response time (less than 2.5 to 3.5 minutes).

From stage (3) to (4) is when the H₂S slope is optimal for calculating the final H₂S value for that Cycle. Algorithms are used by the controller board to calculate as accurately as possible the H₂S final value. Once the final value is obtained, it

will stay at that value (shown in the display and 4-20 mA analog outputs) until the next cycle has finished and updates the H₂S current reading.



It is important that the analyzer is used for its calibrated H₂S range. Do not use this unit for an application that will require readings outside of its calibrated range. This will cause the H₂S sensing tape to run out faster and will cause less accurate readings. The range is determined by the aperture strip in the sample chamber. For more information analyzer ranges, refer to "Aperture Strip" on page 19.

ANALYZER COMPONENTS

In this section, the main components of the 330/331 H₂S analyzer will be covered as well as the optional components added to the system at customer request. A brief explanation of type, functionality, set up and options will be described.



Total Sulfur and Dilution system options will not be covered in this section. Please refer to Total Sulfur and Dilution manuals.

Controller Board

The H₂S controller board is the most important electronic component of the analyzer. It is a printed circuit board that holds all of the customer's connections such as, communication ports, digital inputs, analog outputs, relay outputs solenoid outputs, and AC or DC power input. Refer to Figure 3.

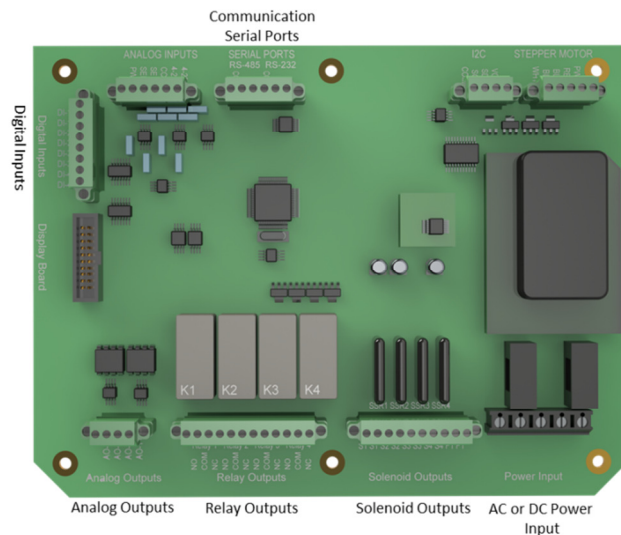

Figure 3. H₂S Controller Board Front View (Customer Connections)

Power Connection

There are AC or DC H₂S controller boards and will be specified by customer request. The controller boards with AC power supplies have an input voltage range from 110 to 240 VAC (50-60 Hz). The DC controller board has an input voltage range from 10 to 32 VDC. Refer to Figure 3.

Solenoid Output Drivers & Furnace Output

The H₂S controller board has four solenoid driver outputs. They output the same voltage used to power up the controller board and are used to directly drive

solenoids for shutdown, auto-calibration, stream switching, etc. The connection F1-F1 is used to power up the furnace for Total Sulfur applications (Refer to Figure 4).



Do not supply external power to solenoid drivers in the controller board.

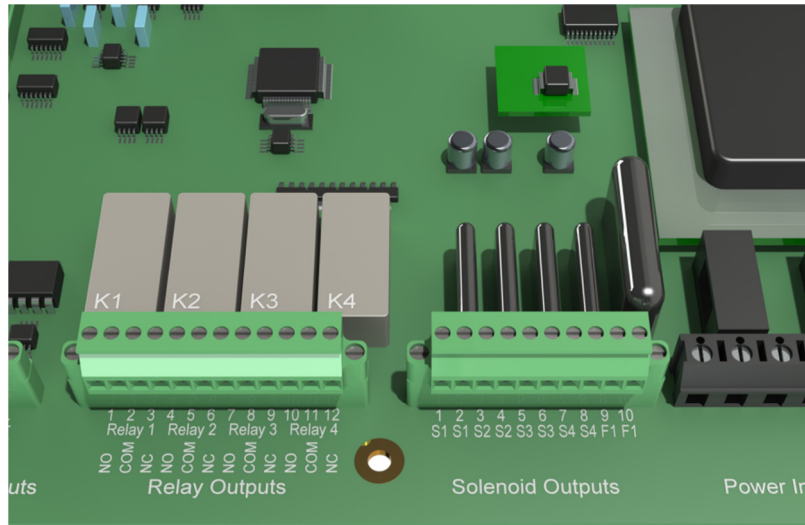

Figure 4. Relay & Solenoid Outputs

Dry Contact Relays

The H₂S controller board has four dry contact relays used as status outputs, to drive external relays or solenoids. They are rated for a maximum of 120 VAC 5 Amp (Refer to Figure 4).

Analog Outputs

The H₂S controller board has two isolated loop power 4-20mA outputs which can be set up for different variable outputs. Loop power (10-32 Volts) sourced from the end device (PLC) is required for the analog to output. Figure 5 shows the different wiring set ups for the analog outputs.

The third wiring option shown in Figure 5 uses Envent's powered AO board(s) to provide self-powered analog outputs. These boards are available at Envent Engineering Ltd. Refer to "Power AO Boards" on page 30.



The factory default variable for the two analog outputs is the current H₂S reading on Stream 1, labeled in the software as "Process Stream#1: Current Value".

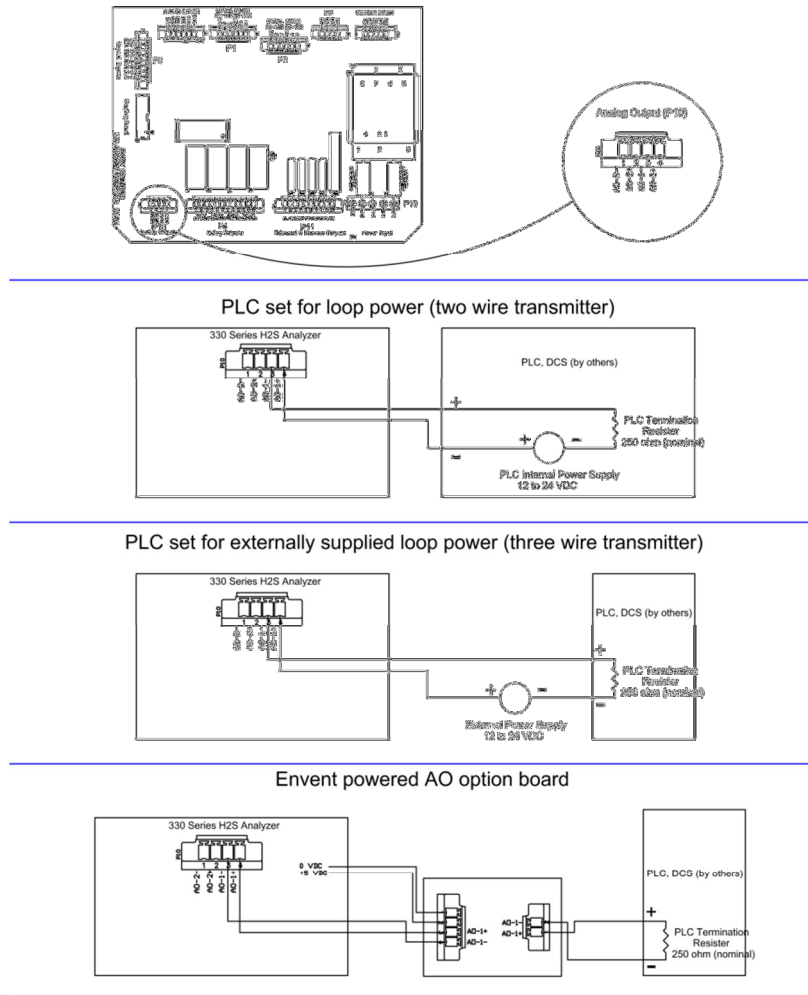

Figure 5. AO 4-20 mA Output Wiring Options

Digital Inputs

The H₂S controller board has four digital inputs use to signal the analyzer of a change of state from an external device, refer to Figure 3. As factory default, DI#1 is used for low H₂S sensing tape sensor and DI#2 is used for low pressure switch, if applicable. These two devices are installed to the analyzer only by customer request. To know more about these two options, please refer to "Optional Components" on page 28.

Serial Ports & I2C

The H₂S controller board has the communication capabilities for RS-232, RS-485 and Ethernet (Optional). The RS-232 Serial port is wired to a DB9 Female connector for easy access with a DB9M/F Extension cable (provided with analyzer) refer to Figure 6.

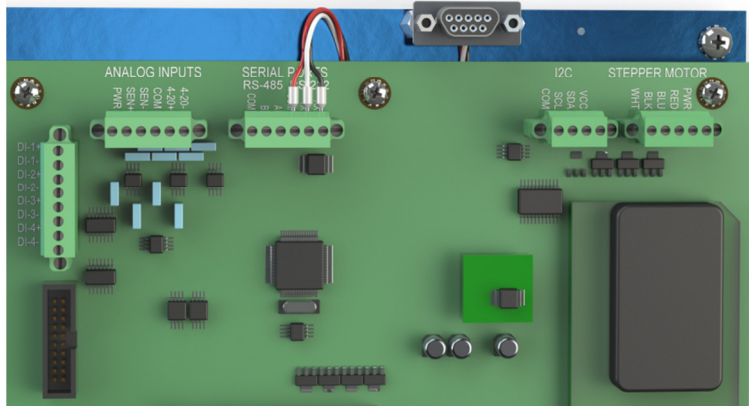

Figure 6. RS-232 Serial Port wired to a DB9 Female Connector

The TCP/IP communication is achieved via a communication electronics card which is connected to the I2C terminal block on the controller board. It does not come with the analyzer unless otherwise requested by the customer. For more information on the Ethernet communication card refer to "Ethernet Communication Card" on page 30.

LCD Display Board

The LCD display board used for the H₂S 330/331 models is a 2-line backlit display with a direct tactile or magnetic interface, refer to Figure 7. The magnetic interface is only used for our 330 H₂S analyzers which are for Class I, Division 1 areas. The LCD display connects to the controller board with an IDC ribbon cable.

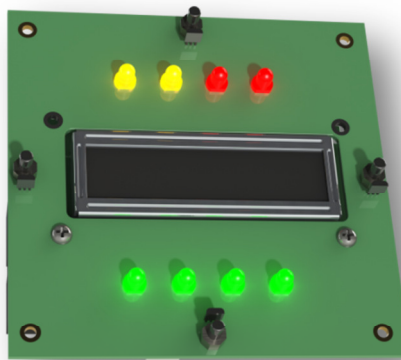

Figure 7. 330 & 331 H₂S Analyzer Bare Two-Line Display

Sample Chamber

The sample chamber is the component that allows the H₂S sample to come in contact to the H₂S sensing tape which in turn is read by the sensor block. The sample chamber is made of the following components:

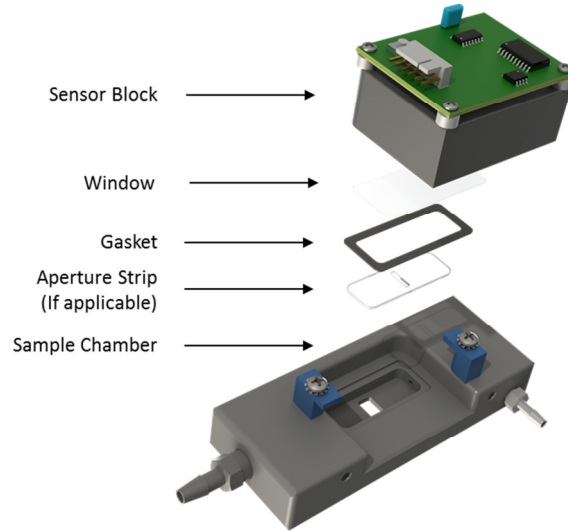

Figure 8. Sample Chamber (Exploded View)

Sensor Block

The sensor block measures the intensity of the LED light reflected off of the H₂S sensing tape. It is composed of an electronic board, a red light emitting diode and a photodiode, refer to Figure 8. As the tape gets darker due to exposure to H₂S, the photodiode receives less light. Less light means more H₂S.

Window & Gasket

These two components seal the small compartment where the H₂S comes inside the sample chamber, refer to Figure 8. The window keeps a clear view for the LED and the photodiode to work properly and isolates them from the sample gas. The rubber gasket seals the Sample Chamber compartment preventing any leaks.

Aperture Strip

The sample chamber has a fixed size aperture of ¼ inch which is useful for concentrations in between 1 ppm to 16 ppm.

For concentration applications below 1 ppm or above 16 ppm an aperture strip is installed behind the window in the Sample Chamber, refer to Figure 8. This

aperture strips keep the analysis time to be approximately the same regardless of the range.

Various sizes of apertures match different measurement ranges. The following table shows the aperture size according to its range. Refer to Table 2.

H ₂ S Range	Aperture Strip	Event PN
50 ppb to 1 ppm	ppb style	330110
1 ppm to 16 ppm	None (1/4" fixed aperture size)	N/A
16 ppm to 30 ppm	1/16"	330103
30 ppm to 50 ppm	1/32"	330102
50 ppm to 100 ppm	Pin Holes	330100
100 ppm to 500 ppm	Laser Dot	330109
Over 500 ppm	Addition of a dilution panel. Consult Factory.	

Table 2. Aperture Strips & Ranges

Aperture strips can be changed to accommodate for a different range application. Refer to the table shown above to select the best option on the new concentration application. Contact Envent Engineering Ltd to purchase an aperture strip.



Remember: gain and span values on analog outputs will have to change based on new range application. Please re-calibrate analyzer. Refer to "H₂S Gas Calibration" on page 61.

The adhesive used to glue the aperture strip in its place is RTV108 Translucent Adhesive. RTV102, RTV103, and RTV109 could also be used.

Trigger Slide

The trigger slide is the device that seals the H₂S sensing tape against the sample chamber. The pressure created by the two springs is enough to seal the sample chamber (4 – 5 W.C). The head of the trigger slide is low-friction which ensures the H₂S sensing tape to move smoothly preventing the tape to break. It also ensures that the stain on the tape has even and sharp edges. Refer to Figure 9.

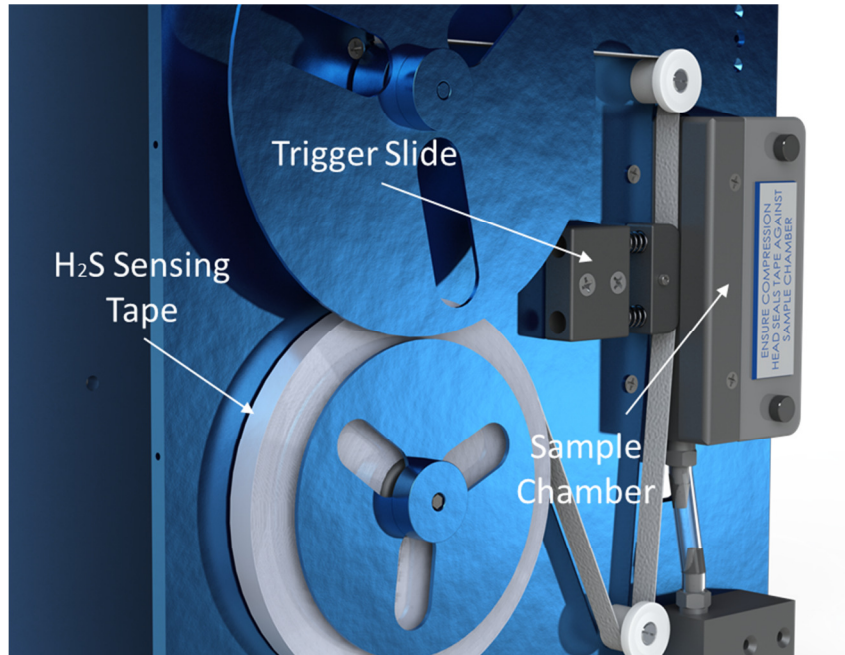

Figure 9. Trigger Slide Installed on a 330 H₂S Analyzer (Applicable for 331 Analyzers)

Sample flow Components

The analyzer should have components that control and prepare the gas sample for proper H₂S readings. These components are: flowmeter, humidifier, and eductor block.

Flowmeter

This component comes with all 330/331 H₂S analyzer. The flowmeter is a F65-65mm forged aluminum body with a standard cartridge control valve*. Flow must be kept at a constant flow of 2 cm (between 100-200 cc/min). A change in flow of +/- 1 cm affects the reading by 10% of full range.



*The flowmeter is changed to a "No Knob" for 330/331 H₂S analyzers with total sulfur or dilution systems. The flow is controlled using a critical orifice set to a flow 100-200 cc/min and flowmeters located in the sample conditioning system.

Humidifier Unit

For the H₂S to adhere to the surface of the H₂S Sensing tape, it needs to be humidified. The humidifier unit helps having constant moisture content in the sample which increases the chemical reaction on the H₂S Sensing tape. Envent

Engineering Ltd offers a unique design of humidifiers meant to meet the requirements for humidification of the sample before it gets into contact with the H₂S sensing tape; refer to Figure 10 .

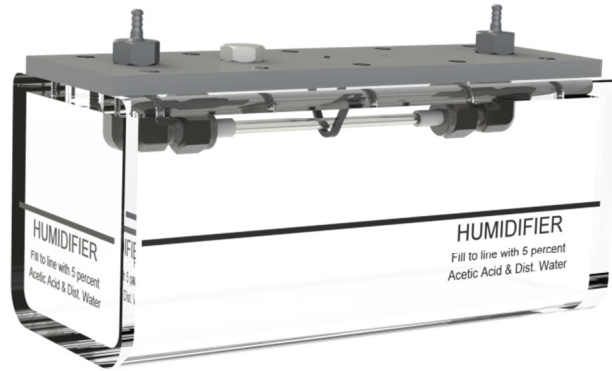

Figure 10. Envent's Humidifier Unit

The humidifier works by using Nafion Tubing. This material has the capability to transports water vapor from the most humidified medium to the driest medium. The sample gas traveling inside the Nafion tube is dryer than the outside of the tube which is being saturated with water, thus, humidifying the gas sample. It is important to have a constant flow to create a constant humidification of the sample gas.

The humidifier unit can be filled with distilled water or 5% Acetic Acid up to where the line indicates on the unit. Acetic acid is preferable over distilled water since it prevents the liquid to create mold and fungus overtime. Also the freezing point for water is 0 °C and for 5% Acetic Acid is -2 °C making it more reliable under freezing temperatures.



NOTICE

The analyzer should not be exposed to ambient temperatures lower than 0 °C. By default, all 330/331 H₂S analyzers have a temperature alarm set to 0 °C descending.



CAUTION

The analyzer should be mounted in an area in which it is not exposed to vibration, excessive pressure, temperature and/or environmental variations.

Figure 11 shows how to install the humidifier unit in a model 331 H₂S analyzer. Same principle applies for the model 330 H₂S analyzer.

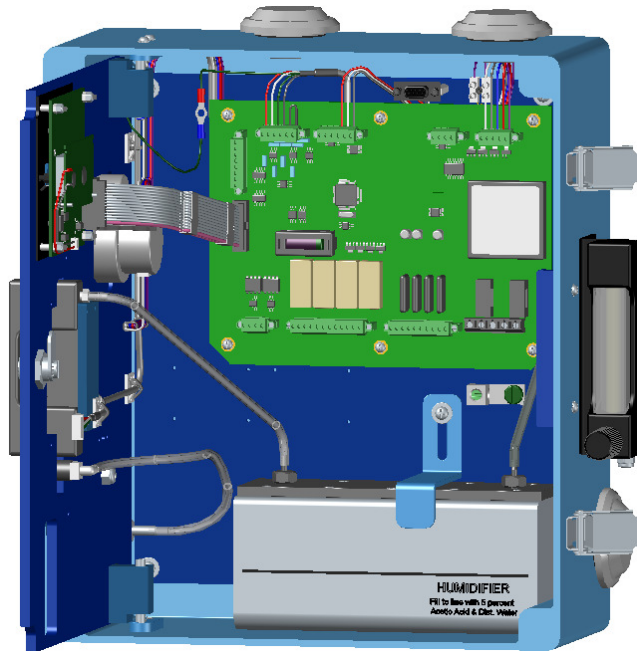

Figure 11. Humidifier Unit Installed in a 331 H₂S Analyzer

Eductor Block

The analyzer reading can be affected by positive or negative pressure on the sample vent line. This can be caused by strong winds blowing across or directly into the vent; or by mechanical venting (exhaust fan). The eductor will eliminate any influence on the analyzer reading; refer to Figure 12 .

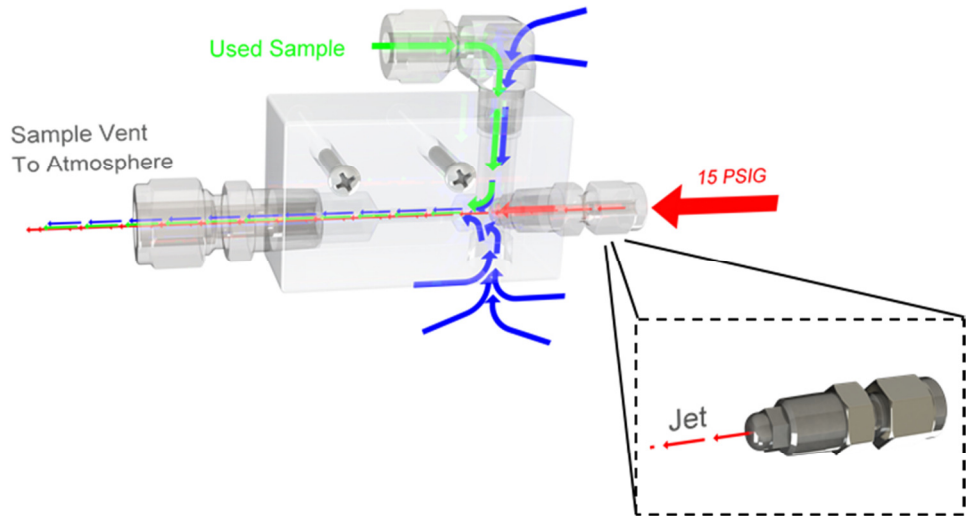

Figure 12. Eductor Block (Venturi Effect)



The eductor is required with this model in order to maintain electrical safety and certification in division 2 areas

In cold climates, since the analyzer is venting a moist sample, freezing can occur. The eductor will help reduce freezing problems in the vent line due to the increased velocity and drying effect of the sweep gas. The eductor vent can be retrofitted to existing analyzers.



In normal conditions, the eductor makes a noise similar to a gas leak. This noise is normal and it is due to the 15 psig pressure being expelled through the restricted fitting creating suction from the gas vent line (Venturi Effect). DO NOT block the opening at the bottom of the eductor or the modified elbow fitting.

Sample Conditioning System

The function of the optional sample conditioning system is to regulate and filter particulates of free liquids from the sample, refer to Figure 13. Consideration must be taken from all potential conditions when designing the sample conditioning system. This section will only cover the 330/331 *standard* conditioning system which can be divided into conventional (Refer to Figure 14) or alternative (Refer to Figure 15).

331 Flow Diagram

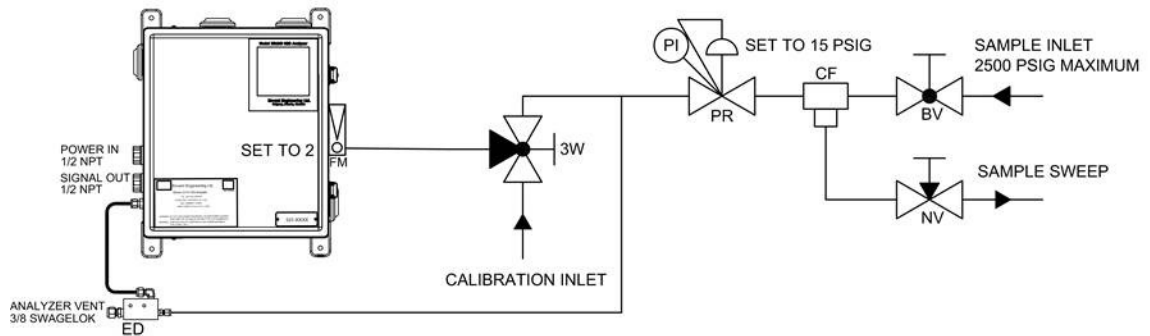

330 Flow Diagram

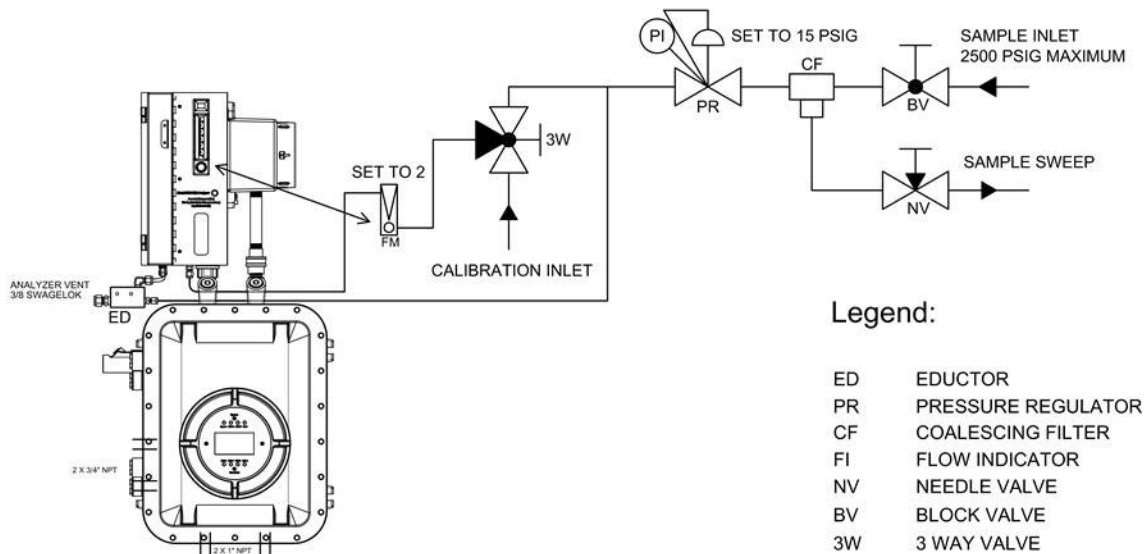

Figure 13. PI&D Diagram of Standard Sample System for 330 & 331 H₂S Analyzers

For *special* sample systems, refer to drawing package in the analyzer binder or USB flash drive provided with the analyzer.

The *standard* sample conditioning system consists of:

Filter Housing, Pressure Regulator & Pressure Gauge (Conventional)

Filter Housing

The filter housing is capable of withstanding up to 5000 psig. This filter is set as "Particulate" to better remove solid particles from the gas sample. For wet/dirty systems, the filter is set as "Coalescent". The bonded microfiber filter element located inside the filter housing should be changed at least every 3 months or as required depending on the application.



Please contact Envent Engineering Ltd to order more bonded microfiber filters.
(Part No. 330406)

Pressure Regulator

The pressure regulator is a Swagelok 316SS 0-3600 psig Inlet and 0-25psig outlet Series KPR.

Pressure Gauge

The Pressure gauge has a range of 0-30 psig. The pressure should be maintained at 15 psig for normal operation. The lowest pressure found to be acceptable for proper H₂S measurement is 0.5 psig; however, it is not recommended to have a lower pressure than 10 psig.

Three-way valve

It allows the user to manually switch from sample gas to calibration gas.

Sweep Needle Valve

This needle valve works by draining any liquids that may collect from the filter. It also reduces lag time in the sample piping.

To learn more about lag time in the sample inlet please go to "Sample Volume & Flow Rate" on page 34.

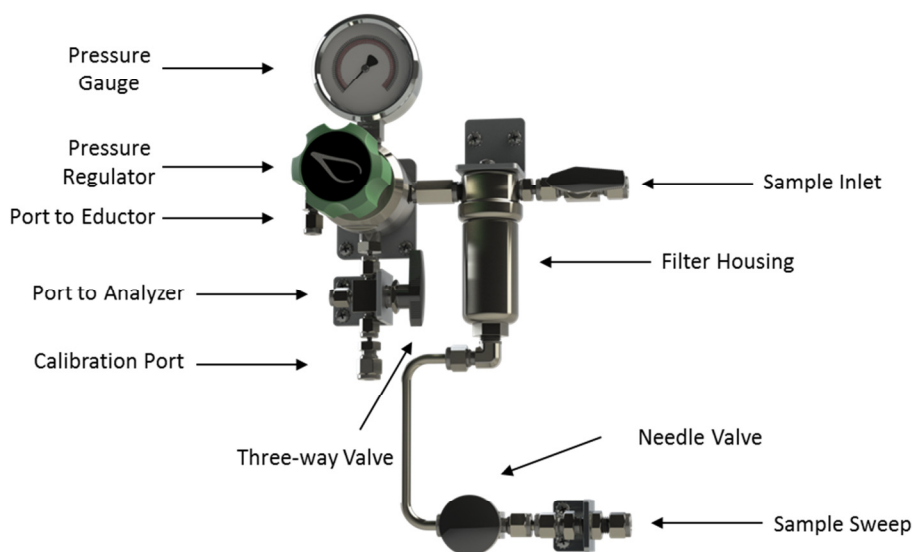

Figure 14. Conventional Standard Sample System

Envent IFR Filter Housing, Regulator & Pressure Gauge (Alternative)

Pressure Regulator and Filter Housing

The sample conditioning system comes with the Envent's IFR regulator and filter housing unit. The maximum inlet pressure is 3600 psig and outlet is 0-25 psig. Pressure gauge used is the same as the conventional sample system. Refer to Figure 15. The filter housing contains a bonded microfiber filter element that should be changed at least every 3 months or as required depending on the application.



Please contact Envent Engineering Ltd to order more bonded microfiber filters.
(Part No. 330406)

Pressure Gauge

The Pressure gauge has a range of 0-30 psig. The pressure should be maintained at 15 psig for normal operation. The lowest pressure found to be acceptable for proper H₂S measurement is 0.5 psig; however, it is not recommended to have a lower pressure than 10 psig.

Three-way valve

It allows the user to manually switch from sample gas to calibration gas.

Sweep Needle Valve

This needle valve works by draining any liquids that may collect from the filter. It also reduces lag time in the sample piping.

To learn more about lag time in the sample inlet please go to "Sample Volume & Flow Rate" on page 34.

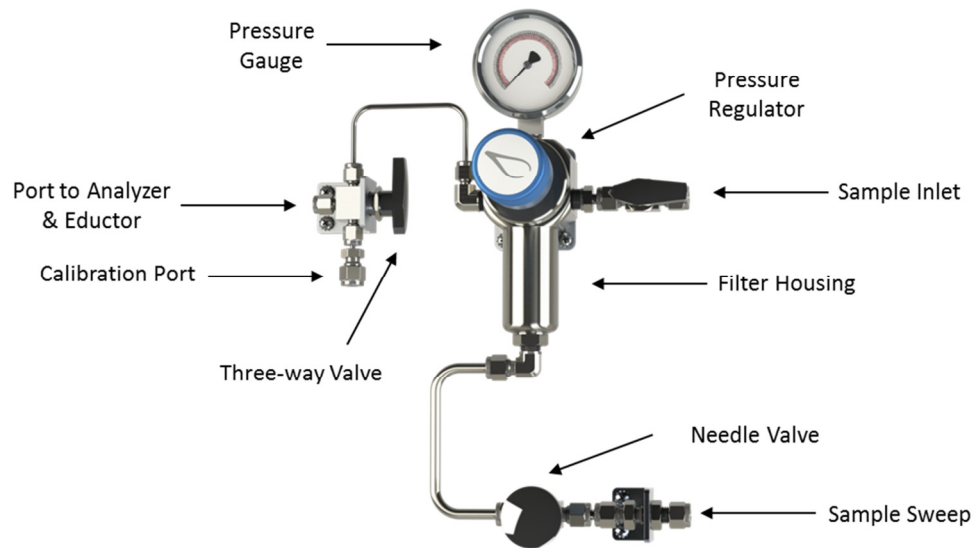

Figure 15. Alternative Standard Sample System

Optional Components

Event Engineering Ltd offers optional components that could be required for certain applications. These components are:

Low H₂S sensing Tape Sensor

Analyzers can automatically alarm when the H₂S sensing tape is almost fully used and needs to be changed. It alarms when the tape has 2 – 5 days left remaining on the roll. This sensor is installed at customer request or it can be obtained after purchase. Refer to Figure 16.

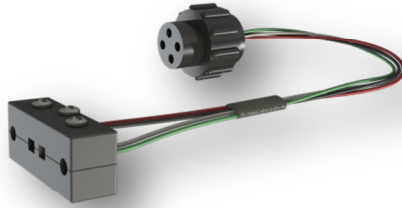

Figure 16. Low H₂S Sensing Tape Sensor



Please contact Envent Engineering Ltd to order a low H₂S sensing tape sensor.
(Part No. 33046A)

The low H₂S sensing tape sensor is wired to DI#1 in the controller board by default. Low tape alarm is configured to change state of Relay#4, Fault LED, and Virtual#1 for standard configurations.

Low Pressure Switch

Analyzer with low pressure switch(es) alarm when the Sample inlet pressure drops below 10 psig. Pressure switch(es) are installed at customer request. It is wired to DI#2 by default in a Fail Safe configuration. Low Pressure alarm is configured to change state of Relay#4, and Fault LED for standard configurations.

Internal Pressure Switch

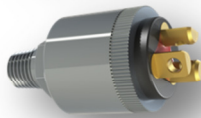

External Pressure Switch

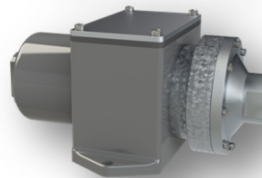

Figure 17. Internal & External Pressure Switches

There are two types of pressure switches available. Internal pressure switch and external pressure switch; refer to Figure 17. Both styles can be used for both the 330 and 331 H₂S analyzers. If the internal switch is used on the 330 H₂S analyzer (division 1), a flame arrestor is used to comply with regulation standards.

Power AO Boards

The 330/331 H₂S analyzers have two isolated loop power 4-20mA Outputs. For self-powered AO, power AO boards can be implemented at customer request; refer to Figure 18.

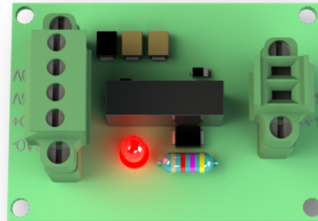

Figure 18. Analog Output Board

Ethernet Communication Card

The 330/331 H₂S analyzer has the capability to communicate through RS-232 and RS-485. For Ethernet (TCP/IP Protocol), a communication card is implemented to the analyzer at customer request, refer to Figure 19 .

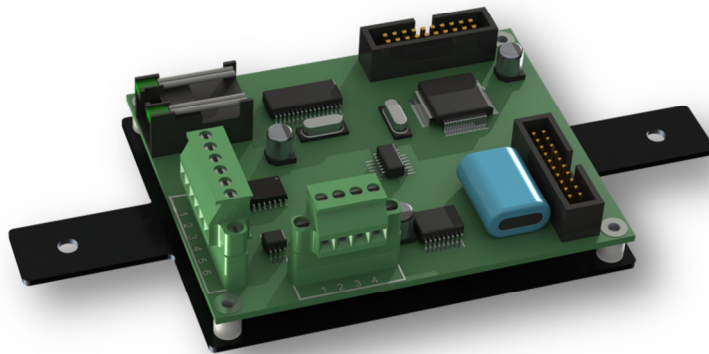

Figure 19. Ethernet Communication Card

INSTALLATION

Installation Requirements

Electrical Requirements

The 330/331 H₂S analyzer's controller board can either be 110-240VAC or 10-32VDC. Consult the analyzer nameplate attached to it or factory calibration certificate for more information.



If the analyzer comes with an external solenoid(s) for auto calibration, stream switching, etc., please check the Factory Calibration Certificate to confirm the solenoid(s) voltage requirement. The motherboard can withstand a voltage range but the solenoid(s) cannot. For instance, for application where the power supply changes from 110 VAC to 240 VAC, the solenoid(s) will need to be changed to a 240 VAC solenoid.

The power consumption for a VDC analyzer is 3 Watts and for a VAC is 5 Watts. For the total sulfur option the power consumption 300 Watts.

Location for the System

First to be considered is the electrical area classification the analyzer will be installed in. Make sure the analyzer meets the requirements for the Division area to be mounted. The 330 H₂S analyzer is suitable for Class I, Division 1 Group CD (Customer can request for Group BCD). The 331 H₂S analyzer is suitable for Class I, Division 2 Group ABCD.

When total sulfur option is used, the 330 is for Class I, Division 1 Group BCD and the 331 is for Class I, Division 2 Group BCD.

The 330/331 H₂S analyzer should be mounted in an area in which it is not exposed to vibration, excessive pressure, temperature and/or environmental variations. The ambient temperature range for the 330/331 H₂S analyzers is 0 to 50 Degree Celsius. If the analyzer is installed in an area where temperatures go out of this range or it varies abruptly, Envent Engineering Ltd has options such as cabinets or shelters; consult Envent Engineering Ltd.

Space Requirements

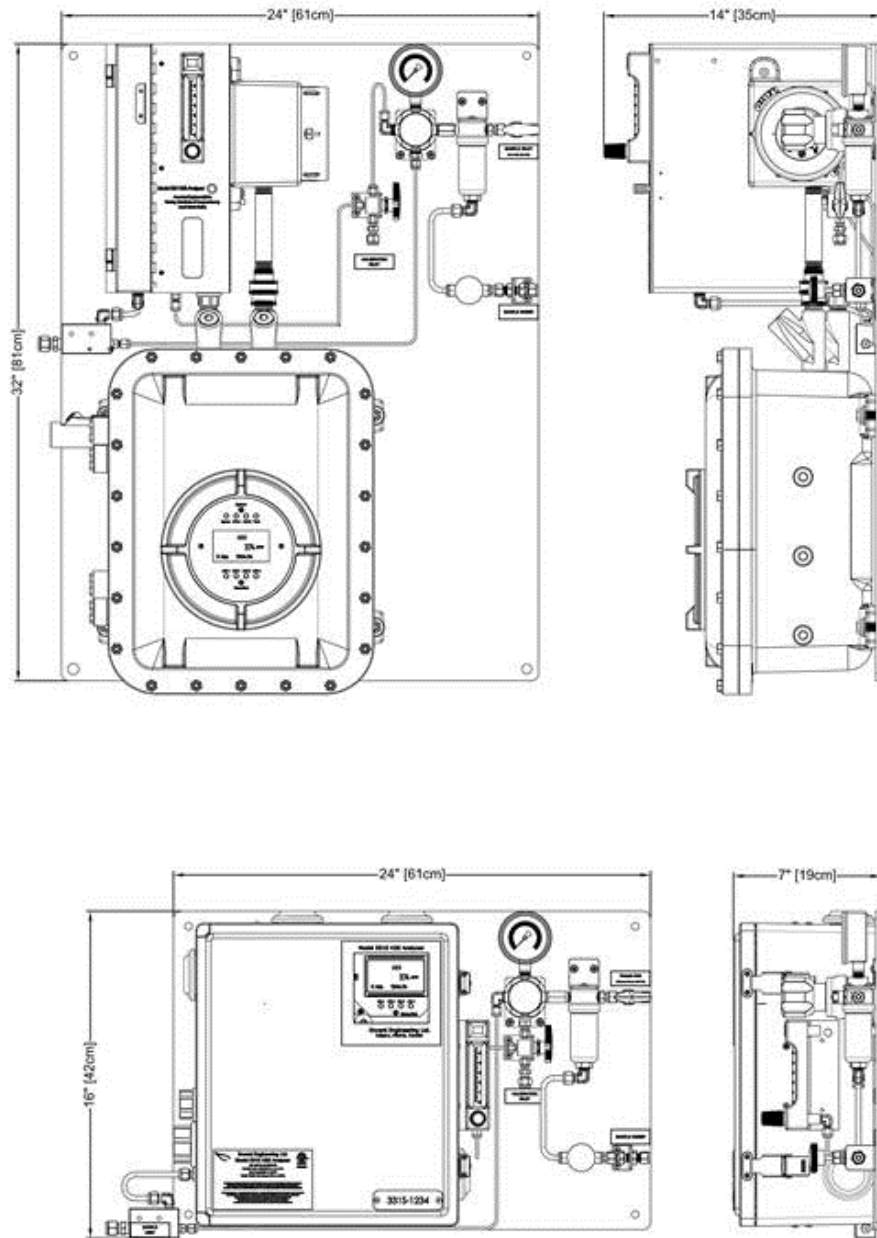

Figure 20. Space Requirements for the 330 & 331 H₂S Analyzers



Make sure to leave at least 1 feet of extra space on the left side of the 330 H₂S analyzer. This will allow proper opening of the side door located at the upper blue chassis where the H₂S sensing tape is located.

Sample Point Selection

The sample to the 330/331 H₂S analyzer must be representative of the process stream and should be taken from a point as close as possible to the analyzer to avoid lag times and sample degradation in the tubing. A probe must be installed vertically on a horizontal section of pipe ensuring that the sample is drawn from the middle third of the pipeline.

An optional Genie GPR Probe regulator may be used. The function of this probe is to ensure a clean dry sample to the analyzer and to reduce the pressure of the sample. The lower pressure will improve the response time of the analyzer. Refer to Figure 21.



It is advisable that the probe not be installed on a vertical pipe.

Sample inlet & sample sweep

1/4 inch 316 stainless steel tubing and fittings are recommended for the sample inlet and sample sweep tubing. Sample sweep can be connected to a flare line if available. Refer to Figure 21.



1/8 inch 316 stainless steel tubing can also be used if the response time of the analyzer is of particular concern.

Vent line

3/8 inch stainless steel tubing and fittings are recommended for the vent line to a maximum of 6 feet in length. 1/2 inch stainless steel tubing should be used for vent lines exceeding 6 feet. The tubing should be installed with a slight downward slope and should be as short as possible. Refer to Figure 21.



The sample vent line must be tubed to atmospheric pressure outside and cannot be connected to a flare line or header.

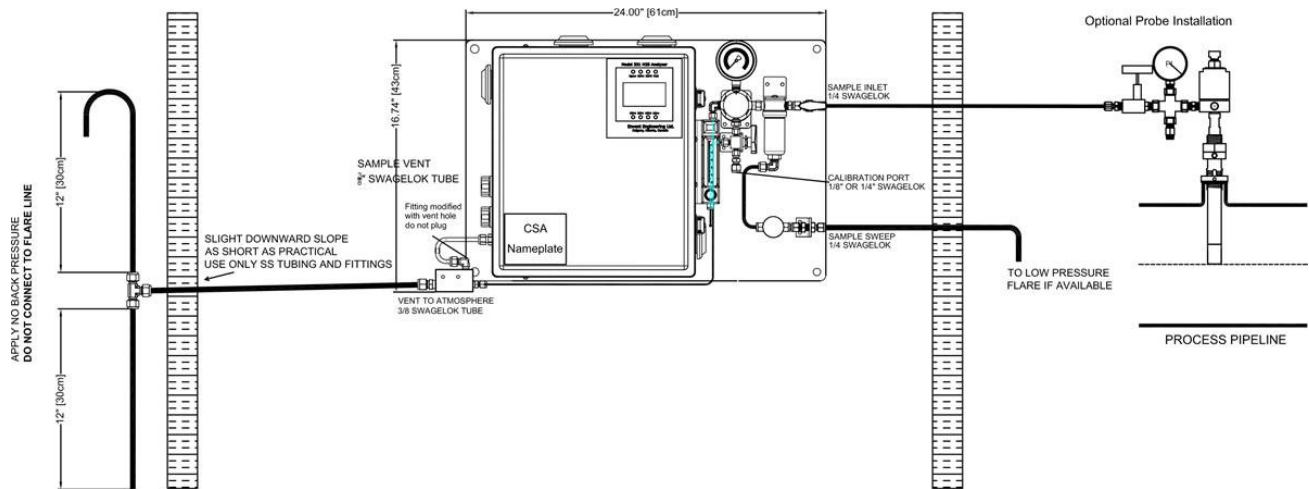

Figure 21. 331 Recommended Venting for 331 (Same as the 330 H₂S Analyzer)

Sample Volume & Flow Rate

The sample should be supplied to the 330/331 H₂S analyzer at 10-15 psig and at a flow between 100-200 cc/min (set flowmeter at 2.0). A bypass sweep is recommended to reduce sample lag time in the sample line if it is at high pressure or it is longer than 15 feet (The Standard H₂S conditioning sample system has a bypass sweep). The standard sample tubing material is 1/4" 316 stainless steel; however, 1/8" stainless steel tubing can be used if the response time is critical (refer to Table 3).

Tube Size (")	Tube Gauge	ID (")	ID (cm)	Flow (SCFH)	Flow Std. (cc/min)	Pressure (PSIA)	Lag Time per 100' (min)	Lag Time per 100' (sec)
3/8	20	0.319	0.810	5	2359	800	36.30	2178
3/8	20	0.319	0.810	5	2359	200	9.07	544
3/8	20	0.319	0.810	5	2359	50	2.27	136
1/4	20	0.181	0.459	5	2359	800	11.69	701
1/4	20	0.181	0.459	5	2359	200	2.92	175
1/4	20	0.181	0.459	5	2359	50	0.73	44
1/8	20	0.081	0.205	5	2359	800	2.34	140
1/8	20	0.081	0.205	5	2359	200	0.59	35
1/8	20	0.081	0.205	5	2359	50	0.15	9

Table 3. Sample Volume and & Flow Rate



Carbon steel sample line and/or fittings are not acceptable.

Receiving the Analyzer

Inspect the packaging for external damage right after it is received. If there is any physical damage, please contact Envent Engineering Ltd and request that the carrier's agent be present when the analyzer is unpacked. If a disagreement arises the incoterms agreed by the seller and the customer will overrule any dispute.

Unpacking the Analyzer



If damage is found in the shipping container see previous section "Receiving the Analyzer".

1. Open the shipping container and remove the foam packing or other packing materials from the shipping box.
2. Take out the analyzer and the start-up kit.



The 330 H₂S analyzer with a standard Sample conditioning system weights approximately 105 lb. Unpacking and transporting requires a minimum of two persons.

3. Make sure the start-up kit is complete (refer to list below). For some special and more complex analyzers, there might be extra parts in the start-up kit.

Standard spare parts for 330 H₂S analyzers:

1. 330 Customer Binder
 - Customer Manual(s)
 - Factory Calibration Certificate
 - Factory Configuration
 - Drawing Package
2. USB flash drive (containing all documentation)
3. 300' H₂S Sensing Tape. Part No. 330133XS
4. 1 Liter Analyzer Fluid. Part No. 330129
5. Funnel
6. 330 Serial Comm. External Cable. Part No. 330418
7. Humidifier (uninstalled). Part No. 330061
8. Bolts For explosion proof enclosure (x22)

Standard spare parts for 331 H₂S analyzers:

1. 331 Customer Binder
 - Customer Manual(s)
 - Factory Calibration Certificate
 - Factory Configuration
 - Drawing Package
2. USB flash drive (containing all documentation)
3. 300' H₂S Sensing Tape. Part No. 330133XS
4. 1 Liter Analyzer Fluid. Part No. 330129
5. Funnel
6. 331 Serial Comm. External Cable. Part No. 330417
7. Humidifier (uninstalled). Part No. 330061
8. Configuration Software key (USB Flash Drive)

Installation procedure & Start-up

The following steps should be followed for proper installation and start-up of the analyzer.

1. Unpack the analyzer and check for damage. Refer to "Receiving the Analyzer" on page 35 for more information.
2. Ensure the analyzer power supply and range are suitable for the installation location. Refer to "Electrical Requirements" on page 31 for more information.
3. Check that the hazardous location rating is suitable for the installation location. Refer to "Location for the System" on page 31 for more information.
4. Ensure that the selected installation site provides adequate room for maintenance and repair. Refer to "Space Requirements" on page 32 for more information.
5. Select an installation location close to the sample point. Refer to "Sample Point Selection", "Sample inlet & sample sweep", and "Vent line" sections on page 33.
6. Bolt the analyzer to the wall with the H₂S sensing tape drive at approximately eye level.
7. Wire the power, analog outputs and discrete outputs from the analyzer.
8. Tube the Sample inlet, sample sweep, and sample vent lines from the analyzer.

9. Ensure there is enough H₂S Sensing tape. To install H₂S sensing tape refer to "H₂S Sensing Tape Change Procedure" on page 64.
10. Install the Humidifier, if applicable. Ensure there is enough 5% acetic acid or distilled water in the humidifier. Refer to "Humidifier Unit" on page 21 for more information
11. Apply power to the analyzer. The display will illuminate and the H₂S sensing tape will advance for a few seconds.
12. Press the menu button until mV is displayed. Check that the mV reading is 1000 mV (± 100 mV).



There are two mV values shown in the display, the "mV Zero" and the "mV" Values. Check for the "mV" Values.

13. Make sure the sample inlet valve, sample sweep valve, and pressure regulator are completely closed. The pressure regulator is completely closed when the knob handle is counter clock wise.
14. Turn on the sample gas flow to the conditioning sample system and then open the sample inlet valve.
15. Open the sweep valve slightly and adjust pressure regulator to 15 psig and the flow meter to 2.0.
16. Allow twenty minutes for the analyzer to stabilize. The analyzer calibration can be verified if calibration gas is available, refer to "H₂S Gas Calibration" on page 61. If no calibration gas is available, the analyzer may be operated using the factory calibration settings until calibration gas is available.

OPERATION & CONFIGURATION

The 330/331 H₂S analyzer can be configured by using the display-button function or by connecting the analyzer to a computer through RS-232 or RS-485.

Analyzer Display Interface

By using the analyzer's display, the user can only view and/or change certain parameters set at the factory. For advance changes refer to "Analyzer Software Interface" on page 39. The display is made up of a 2-line LCD, four (4) push-buttons and (8) LED's. Refer to Figure 22



Figure 22. 330 Display (left) & 331 Display (right)

The Descriptions and Function of the display buttons and LED's are described in table Table 4 & Table 5.

Button	Description/Function
Bypass	Used to inhibit all analyzer alarms to a non-alarm state and sets the analog 4-40 mA output to 2 mA. The Bypass LED illuminates when Bypass mode is enabled.
Scroll Right [→]	Used to move the cursor to the right. Also used to SAVE configuration adjustments when moved all the way to the right of the screen.
Scroll Left [←]	Used to move the cursor to the left. Also used to CANCEL configuration adjustments when moved all the way to the left of the screen.
Menu/Set	Used to cycle through the menu options. Also used to increase numerical values when making configuration adjustments.

Table 4. Display Button Description/Function

LED	Description/Function
Bypass	Illuminates when the analyzer is in bypass mode.
Alm 1 & Alm 2	Can be used for any alarm designation. By default, "Alm 1" is used for "H Alarm" and "Alm 2" is used for "HH Alarm".
Fault	Illuminates when there is a fault in the Analyzer. Fault is used for Board temperature, Sensor High/Low, Low H ₂ S sensing tape sensor, Pressure switch, etc.
Stm-1 & Stm-2	When stream 1 is being analyzed, "Stm-1" LED illuminates, when Stream-2 is being analyzed, "Stm-2" LED illuminates.
Cal-1 & Cal-2	Illuminates when the analyzer is Calibrating.

Table 5. Display LED Description/Function

Analyzer Software Interface

Introduction to the 330/331 H₂S Software

The 330/331 H₂S analyzer has a software application for retrieving archives and for more advanced changes on the analyzer's configuration. The Software comes in a USB flash drive with the analyzer (Check Start-up kit box). It is also available at

www.envent-eng.com

The analyzer is configured at the factory according to the information provided by the customer at the time of purchase. If no information is provided by the customer, Envent Engineering Ltd will assign a standard configuration.

The software can be used to change the range*, the operation of the relays, solenoids, LED's, virtual outputs, alarms, among other changes.



Incorrect configuration of the analyzer may cause incorrect operation. Injury and/or damage to facilities may occur. Check analyzer functionality after configuration changes have been made.

The software application is not required for normal calibration and maintenance operation.

* Please keep in mind that when changing the range of the analyzer, the aperture strip in the sample chamber might also have to change. Please consult the factory before attempting this change.

Using the H₂S Software

This section covers an overview on the 330/331 Software application. It shows how to connect, configure and change the factory configuration to accommodate for different applications in a step by step manner.

Connect the analyzer to the computer using a 330 or 331 Serial Comm. External Cable provided with the analyzer.



A USB to Serial Converter might be needed (Not included).

Open the Software application. There are two views: the User view and the Factory view. When opening the software, the User view loads by default. Enable communication between the analyzer and the computer by clicking on the downward facing flashlight. Refer to Figure 23.

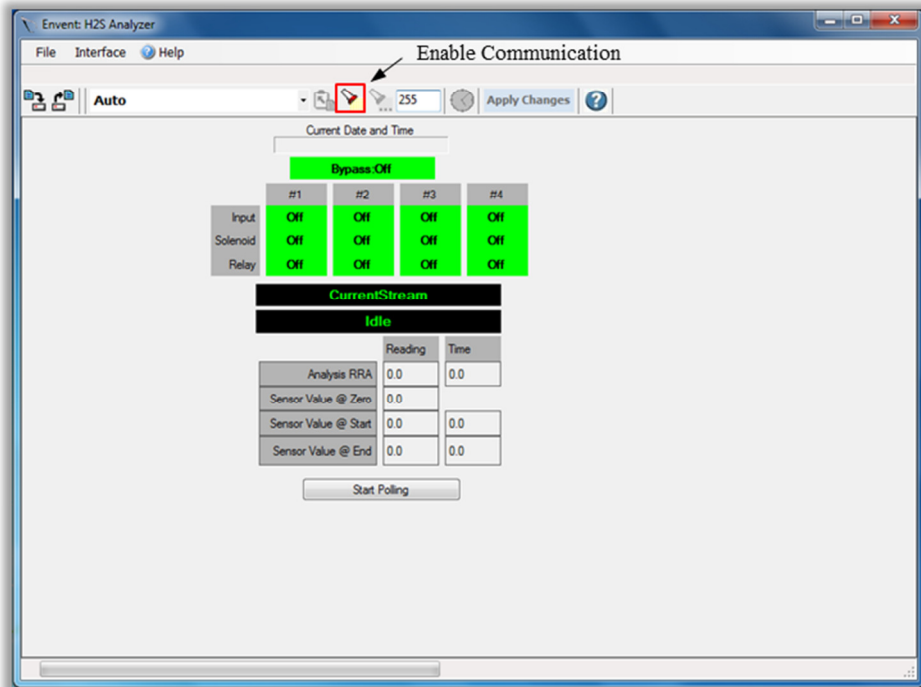

Figure 23. H₂S Software: Enable Communication

An "Analyzer Connection Failed" message might appear on the screen, refer to Figure 24

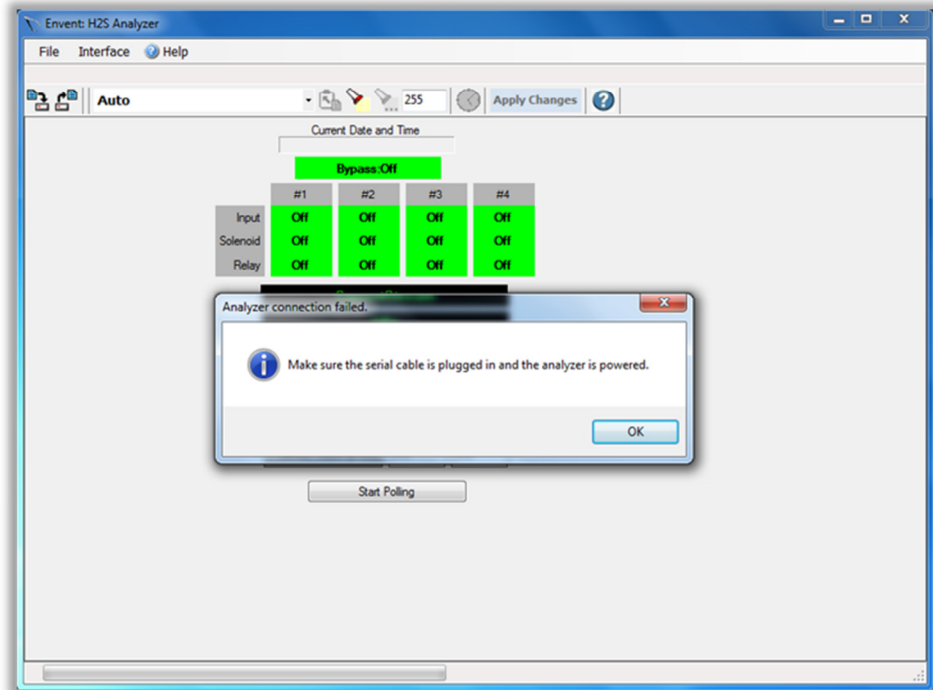

Figure 24. H₂S Software: Analyzer Connection Failed

Troubleshooting communication problems:

1. Check that the analyzer is ON.
2. Check that the communication cable is properly connected
3. Check that the computer recognizes and installs successfully the USB to Serial converter (if applicable).
4. If the software application was open before connecting the communication cable from the analyzer to the computer, close the software and re-open it. Try again and enable communication.

Correct uploading is indicated by a green progress bar at the bottom left of the application window. Refer to Figure 25.

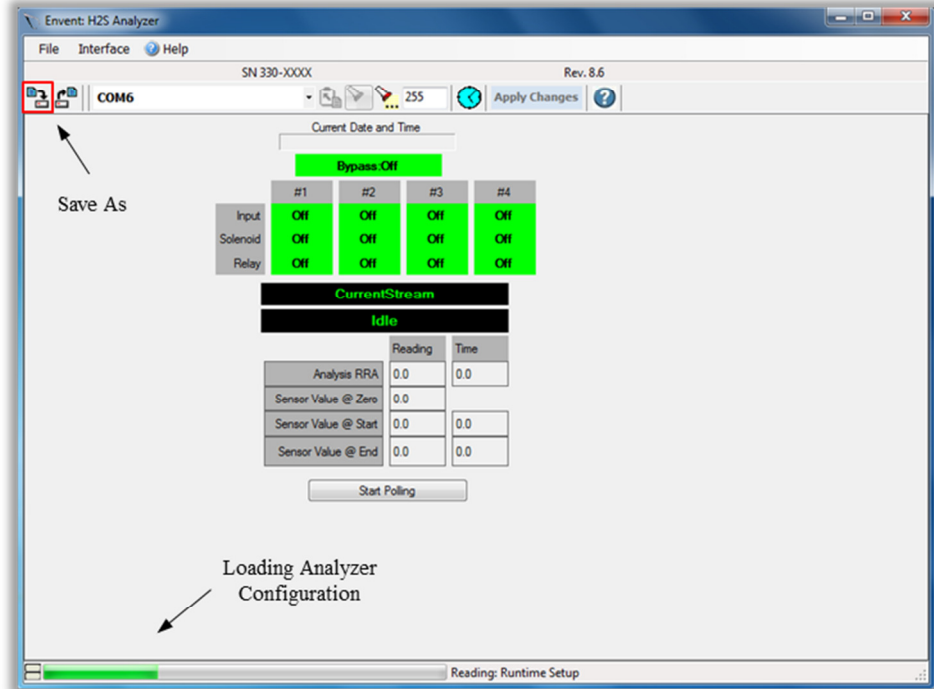

Figure 25. H₂S Software: Uploading & Save As Button

Once the uploading is complete, it is recommended to save the configuration file to your local drive before making any changes. To save the current factory configuration, go to File/Save As and save file to your local hard drive or use the save as button as shown in Figure 25.



If the factory configuration file is lost or changed without saving it first, there are two ways to retrieve it. A copy of the factory configuration file is placed in the Customer USB giving with the analyzer or you can contact Envent Engineering Ltd to obtain a copy of the file.

Once the communication is complete and the analyzer configuration is uploaded successfully, changes can be made to the analyzer configuration.

For live readings click on the "start polling" button, refer to Figure 26. Live readings show the current date and time, the status of digital inputs, solenoids, and relays, values and variables available on the analyzer display and the status of the analysis cycle.

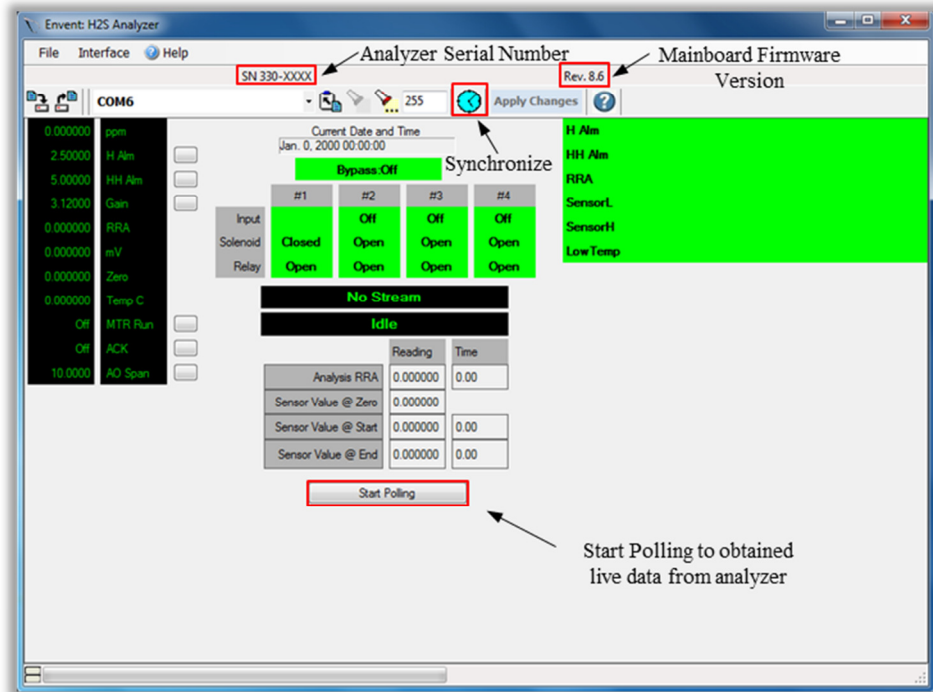

Figure 26. H₂S Software: User View

If the "Current Date and Time" are not correct, click the clock button shown in Figure 26 (Synchronize). This will synchronize the analyzer with the time and date on the computer connected to the analyzer.

The User View shows the current status of the analyzer when the "start polling" button is pressed. The only changes that can be performed in this view are the setpoint values of the alarms that appear in the analyzer display. Refer to Figure 27 .

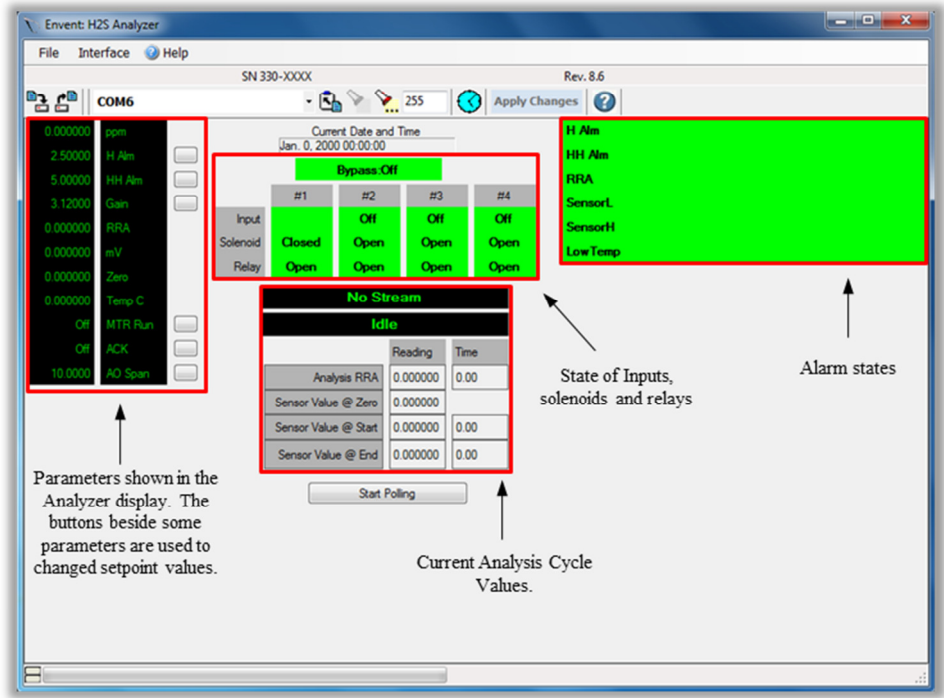

Figure 27. H₂S Software: Active Data Polling in User View

To make advance changes to the analyzer configuration, change from User View to Advance View. Go to Interface/Factory View. Refer to Figure 28

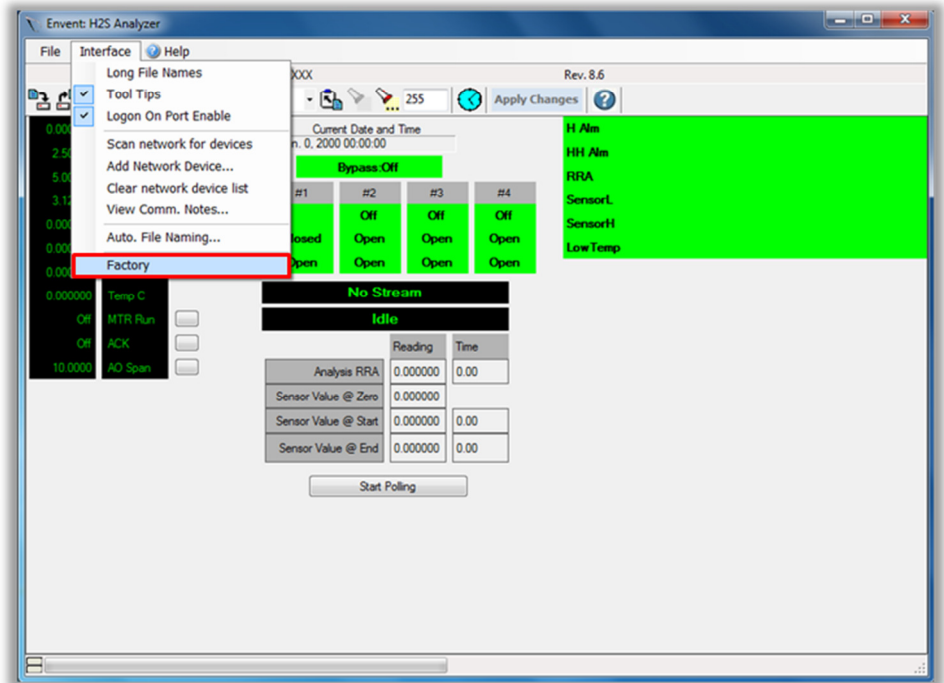

Figure 28. H₂S Software: Change from User to Factory View

Scan IO Tab

A side menu appears in the Factory View. First tab in the side menu is the Scan I/O and it is an expanded version of the User view. In this view, values such as raw, linear, polynomial and logarithm of the analog inputs and outputs are shown.

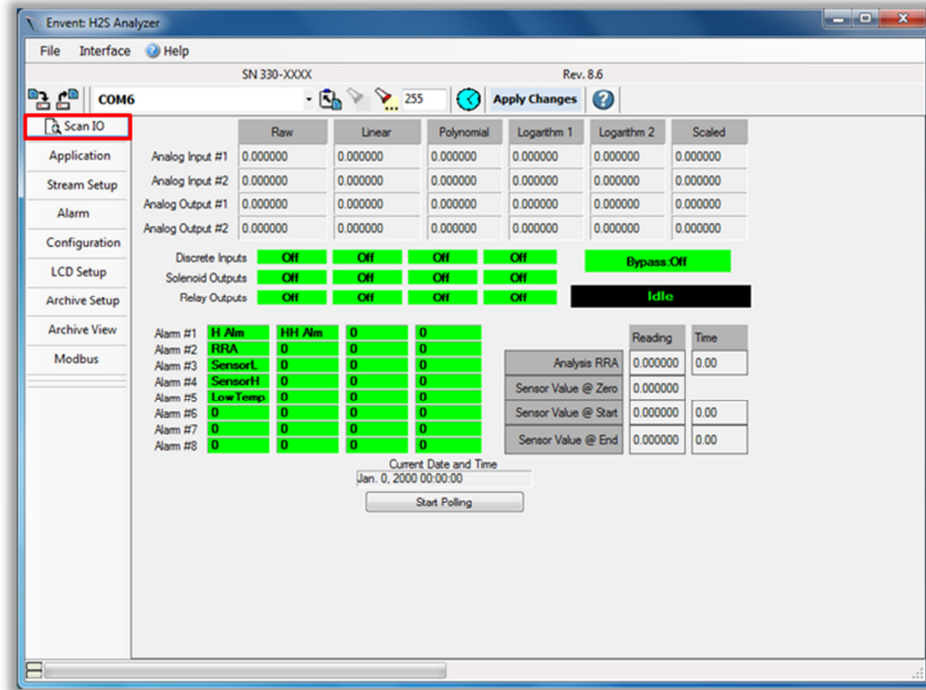

Figure 29. H₂S Software: Scan IO Tab

Application Tab

The variables from the application section are critical for the proper operation of the analyzer. These values must not be changed after the analyzer has left the factory, refer to Figure 29.



Do not change any variables on the application tab. Changing any variables may impair the analyzer. The only scenario where the user would need to change any variable in the application tab is if a Total Sulfur analyzer 120VAC needs to be powered using 240VAC. In this case, please change the PWM Speed from 12,500 to $\frac{1}{4}$ of that value (3,125). If this value is not changed the furnace will be damaged and there is the possibility of a fire ignition.

Consult Factory before proceeding with this change.

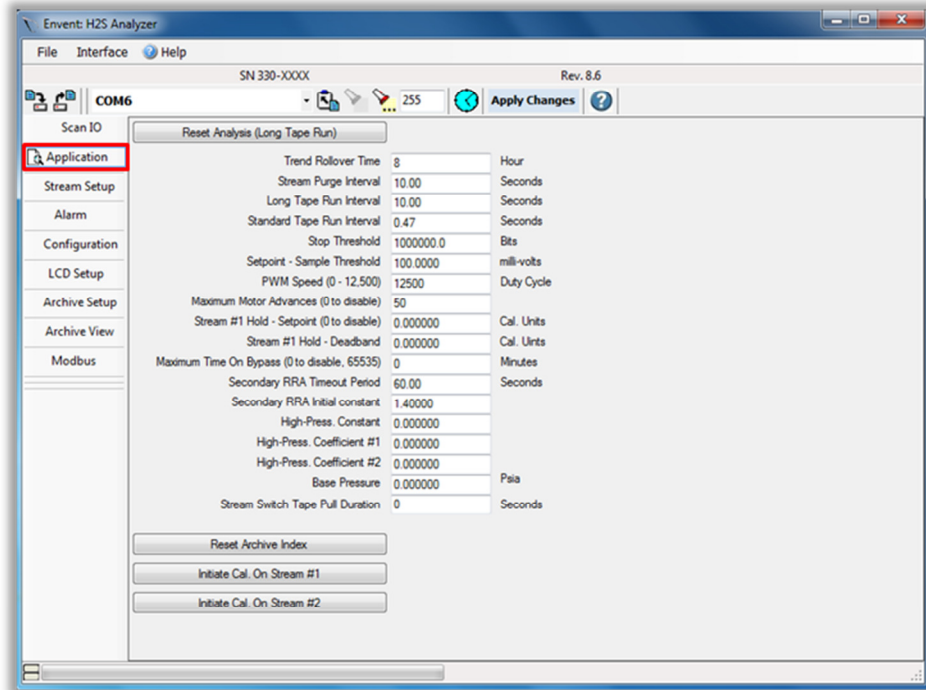

Figure 30. H₂S Software: Application Tab

Stream Setup Tab

The stream setup section is sub-divided into Stream #1 & #2 set-ups and Calibration Stream #1 & #2 set-ups.

Stream#1 & #2

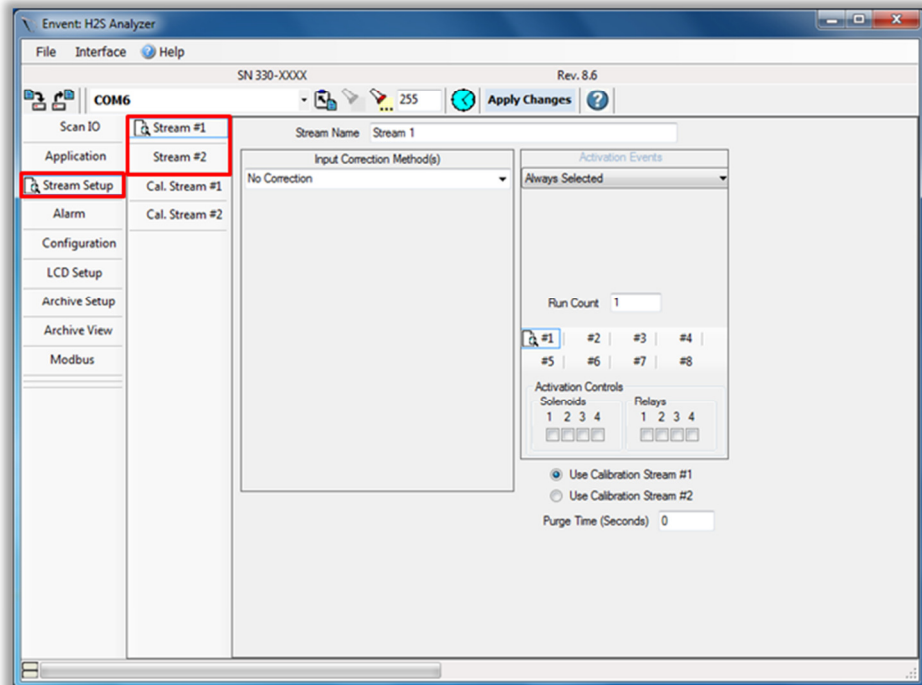

Figure 31. H₂S Software: Stream Setup Tab: Stream 1 & 2 Tab

Stream Name: Used to identify the name of the stream.

Input Correction Method: By default, "No correction" method is used. Do not change.

Activation Event: Events are specific actions the analyzer will perform and depending on the event, it can be automatically activated at a certain time or it can be activated by a change in state of a digital input (e.g. a switch).

The options for activation event are:

User Select from Screen: This option is selected when an event wants to be activated through the display. If this option is selected, the system variable needs to be added to the Display as well. Go to "LCD Setup" Tab in the side menu and add a system variable (E.g. Process Stream #2 – Initiate Run) in one of the available spots.

Always Selected: Streams with this option will always be active until another activation event happens. This option is always used for stream 1 by default.

DI Active One Shot: Used when an activation event is triggered by a normally open pushbutton or external device connected to a selected digital input. This event for the stream will be active until the "Run Count" is over and then it goes back to normal operation (e.g. going back to the other stream). To activate the stream for another run count, the state of the pushbutton or external device will have to change again.

DI Idle One Shot: Used when an activation event is triggered by a normally closed pushbutton (Fail Safe) or external device connected to a selected digital input. This event for the stream will be active until the "Run Count" is over and then it goes back to normal operation (e.g. going back to reading the other stream). To activate the stream for another run count, the state of the pushbutton or external device will have to change again.

DI Active Maintain: Used when an activation event is triggered by change of state of a toggle switch or external device connected to a selected digital input. As long as the switch is in a closed state, the stream will always complete the "Run Count". Depending on what the other stream is selected as, once that stream has completed its "Run Count", it will go back to the stream with the DI Active Maintain. This stream will not be active as long as the external toggle switch or external device used is open.

DI Idle Maintain: Used when an activation event is triggered by change of state of a toggle switch or external device connected to a selected digital input. As long as the switch is in an open state, the stream will always complete the "Run Count". Depending on what the other stream is selected as, once that

stream has completed its "Run Count", it will go back to the stream with the DI Active Maintain. This stream will not be active as long as the external toggle switch or external device used is closed.

Schedule hourly, daily, weekly & monthly: It used when an activation event is triggered automatically at a certain time and/or frequency.



For the next options to work properly, make sure to synchronize the analyzer's clock with your computer's clock. For more information on this, refer to Figure 26

Schedule Hourly: This option is selected when an event wants to be activated hourly. The activation will happen at the beginning of each hour.

Schedule Daily: This option is selected when an event wants to be activated once a day. The activation will happen at the hour selected in the "Hour of day" drop-down list.

Schedule Weekly: This option is selected when an event wants to be activated once a week. The activation will happen at the day and hour selected in the "Day of Week" and "Hour of day" drop-down lists.

Schedule Monthly: This option is selected when an event wants to be activated once a Month. The activation will happen at the day of the month and hour selected in the "Day of Month" and "Hour of day" drop-down lists.

Events: Each stream can have up to eight (8) events.

Note: Events happen in a timeline manner. If there is an ongoing event on stream 1 with a certain amount of "Run Count" left, the new event activation for stream 2 will wait until the run count is over. If the second stream is scheduled for 12:00 pm but the first stream is half way through a run count, the analyzer will wait until stream one has finished the run count. This means that the second stream does not necessarily start at 12:00 pm.

Run Count: They are Analysis Cycles. For more information on Analysis Cycle refer to "Analysis Cycles" on page 12.

Activation Controls: They are relays or solenoids drivers which change states when an event happens. Commonly used for auto calibration of the streams. To activate a relay or solenoid through an even, click on their respective check box in the Activation Controls section.

Use Calibration Stream #1 & #2: When auto-calibrating the analyzer, if both streams have the same range, only one gain is needed for both streams, thus only one calibration is needed. In this case, on the "Stream 2" tab, select Use Calibration Stream #1.

If each stream has different ranges, then each stream has to have its own calibration gas run. In this case, select for each stream their respective calibration stream number.

Purge Time (Seconds): The amount of time the analyzer stays idle after a switch from one stream to the other or after an event happens. While purging, the analyzer will not activate any alarms, or change any state from relays, solenoids, etc. Purge is timed in seconds and it happens after the "Run Count" is done for the respective stream.

Cal. Stream#1 & #2

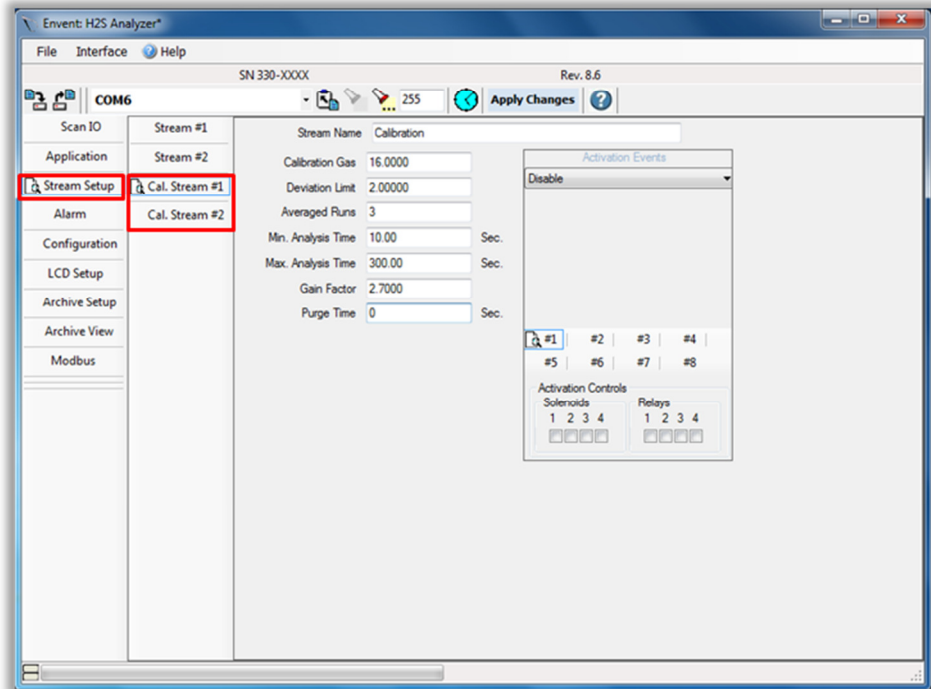

Figure 32. H2S Software: Stream Setup Tab: Cal. Stream 1 & 2

This section does not cover Activation Events. For more information on this topic, refer to "Stream Setup Tab" on page 46 .

Stream Name: Used to identify the name of the Calibration stream.

Calibration Gas: Only used when auto-calibration is performed. Add the H₂S concentration from the calibration gas bottle tag in this section for proper calibration.

Deviation Limit: if the final calibration value is \pm greater than the deviation value, the calibration gas would be considered a fail and the gain is not changed.

Average Runs: The last amounts of "Run Count" taken into account in the Gain calculation. The total Run Counts are designated in the Activation Event section and should always be a greater number than the average runs.

E.g. If the total amount of run count used for the Calibration of a stream is 10 runs, the average run needs to be 10 or less. It is recommended that the first 3 runs are not taken into account. The best set-up for this scenario would be 10 run counts and 7 average runs which mean the first 3 runs will not be counted into the calculation of the Gain.

Minimal & Maximum Analyzer Time: The minimal time determines the minimum amount of time the analyzer awaits to move the tape if there has been a drop of 100 mV in less than 10 seconds. The maximum time determines the maximum amount of time the analyzer will await before moving the tape to start a new analysis time.



These values must not be changed.

Gain Factor: The Gain Factor is the parameter that relates the rate of stain on the H₂S Sensing tape to the actual concentration. This value is determined during calibration with a known H₂S concentration.

Purge Time (Seconds): Purge is timed in seconds and it happens after the "Run Count" is done for the respective stream.

Alarm Tab

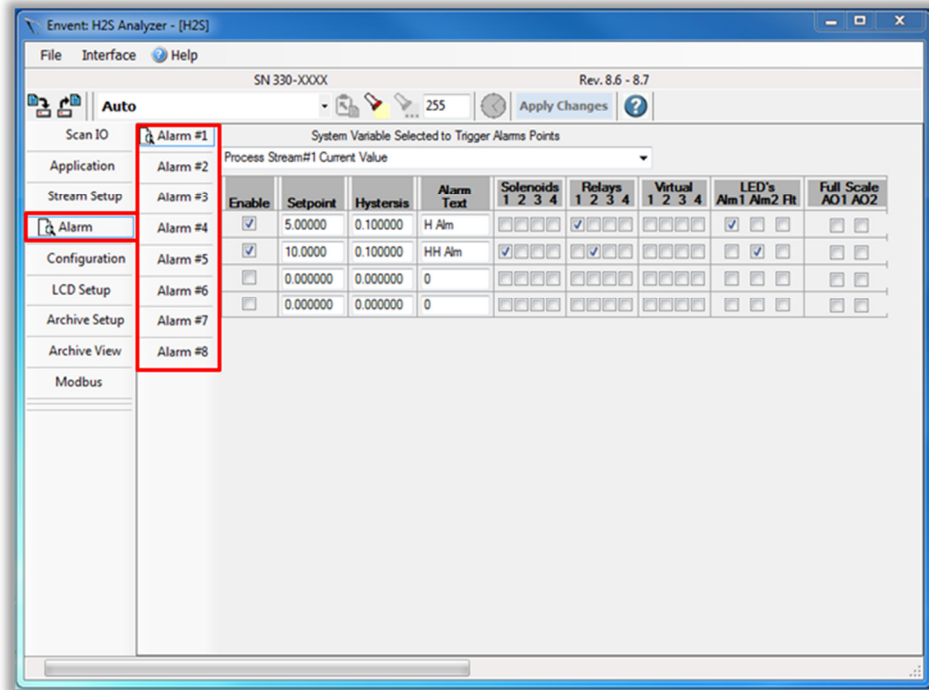

Figure 33. H₂S Software: Alarm Tab: Alarm 1 to 8 Tabs

The total alarms that can be set up are a total of 32. They are organized in 8 different sub-tabs. In each sub-tab 4 alarms can be selected and they will be based on the same "System Variable Selected to Trigger Alarm Points".

System Variable Selected to Trigger Alarm Points: Alarms are linked to available variables in the system. When the value of the variable linked to that alarm reaches the alarm setpoint value or goes above it (or below it), it triggers the alarm.

Enable: Allows the alarm to be enabled or disabled without having to delete the alarm itself.

Setpoint: Point at which the alarm is triggered. All alarms in this software are ascending. Only the system variable Board Temperature (Llm) is descending.

Exception: If the analyzer is battery powered and there is the need to know the battery level and set up an alarm for low battery, there is an advance method to achieve this configuration. Consult Factory.

Hysteresis: when the variable is equal or above the alarm setpoint, it triggers an alarm. In order to go out of alarm, the variable has to go lower than the setpoint minus the hysteresis value. The hysteresis value avoids an alarm to go

on and off repeatedly when the variable is constantly close to the setpoint value.

Alarm Text: It is the name giving to the alarm. The name appears in the analyzer's display when the alarm is triggered. The total amount of characters that the LCD display can take is 8 characters.

Solenoids & Relays: The analyzer outputs that change states when an alarm is triggered. To select which solenoids or relays will be used for an alarm, click on their respective checkboxes. To set up the state of this outputs when in alarm, go "Configuration Tab" on page 52. For more information on the solenoids and relays on the analyzer controller board, please refer to "Controller Board" on page 15.

Virtual: Virtual Outputs are digital outputs which are transmitted through Modbus (not physically wired). For instance, the Fault condition in the analyzer can mean different conditions such as low H₂S sensing tape, low pressure, sensor low, sensor high, low temperature, etc. These conditions can be identified by adding a virtual output to each of them. Through Modbus communication, the fault condition can be identified as to what specifically is causing it.

LED's Alm1, Alm2 & Fault: The LED's that will illuminate when a selected alarm is triggered. These LED's are located in the top of the analyzer's display. Click on the checkboxes for LED's Alm1, Alm2 & Fault to link them to alarms.



By default, LED's for Alm1 is used for a High alarm and LED's for Alm2 is used for High High Alarm.

LED's for Fault is triggered by the following conditions: Sensor Low, Sensor High, Low Temperature, Low H₂S sensing Tape and Low pressure.

Full Scale AO1 & AO2: It forces the Analog Outputs to full scale when a condition is met. For instance, if the RRA alarm setpoint is set to 20 ppm with a Full scale AO1 option checked (Checkbox), AO1 will immediately go to 20 mA or Full scale when the analyzer reads 20 ppm or more. This would happen before the actual analysis time is done (2-3 mins) which makes it ideal for immediate shutdown. It is important to clarify that this option is only useful for RRA readings.

Configuration Tab

Analog Input #1 & #2: These are the values the Controller board receives from the sensor block. These values are must not be changed under any circumstances.



Do not change any of the values in the Analog Input sub-section.

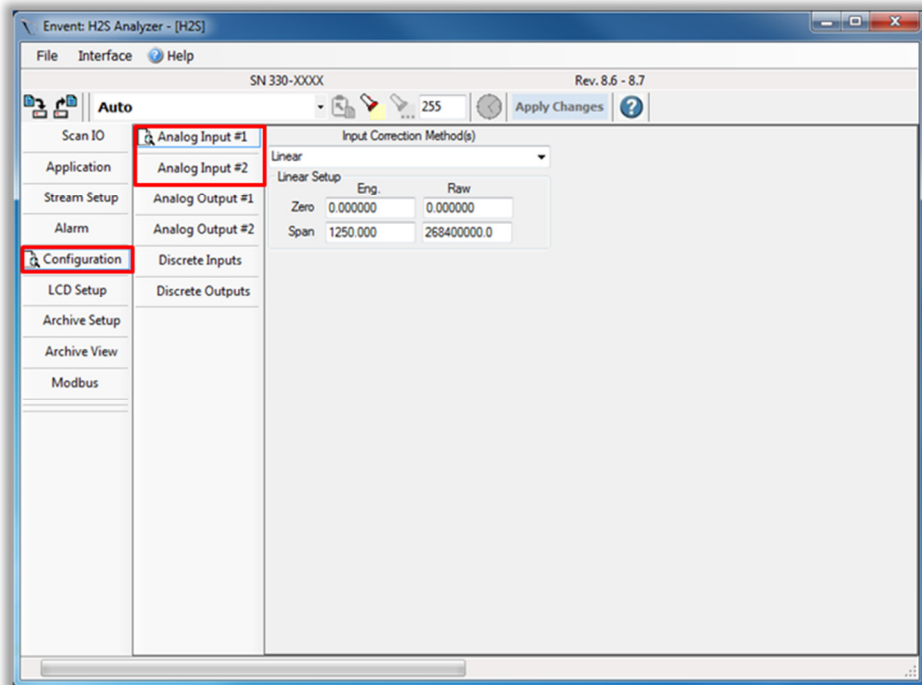

Figure 34. H₂S Software: Configuration Tab: Analog Input 1 & 2 Tabs

Analog Output #1 & #2: The controller board is capable of outputting two loop 4-20mA based on any system variable selected. By default, the system variable selected in the factory for both Analog outputs is “Process Stream#1 Current Value” which is the H₂S current value the analyzer is reading after every analysis cycle.

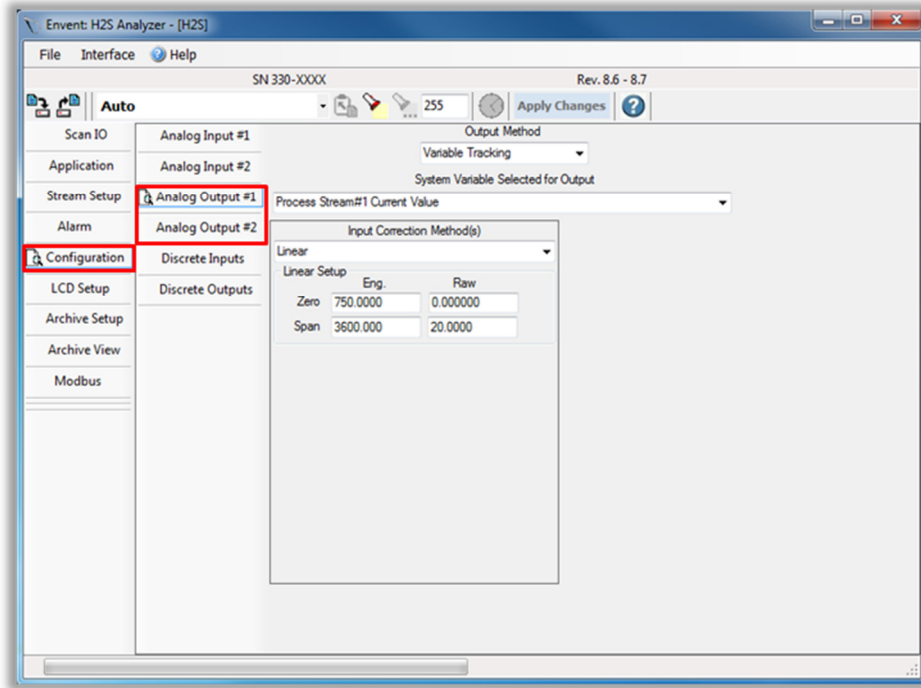

Figure 35. H₂S Software: Configuration Tab: Analog Outputs 1 & 2 Tabs

The Output method and Input correction method(s) must not be changed.



NOTICE

The engineering values for zero and span must not be changed; they were calibrated in the factory.

The raw values are basically the analyzer H₂S full scale. Please consult factory before changing these values.

Discrete Inputs: Used as an on/off input to the controller board. There are 4 discrete inputs in the controller board and they are commonly used for options such as low H₂S sensing tape alarm and low pressure alarm.

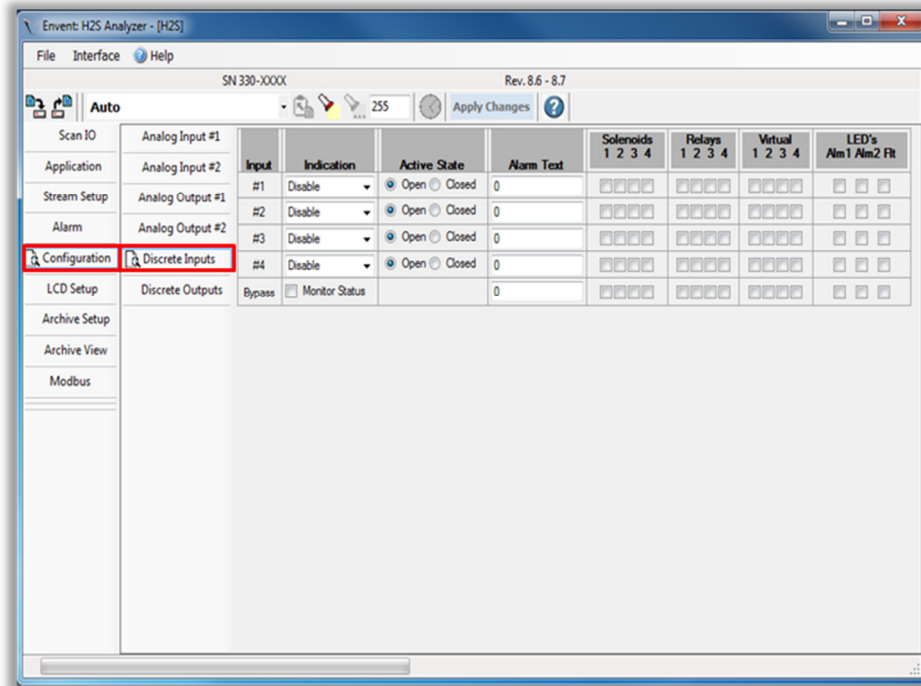

Figure 36. H₂S Software: Configuration Tab: Discrete Input Tab

Indication: The options in the indication section are disable, alarm, bypass and acknowledge alarm. The disable option can be used if an already existing discrete input wants to be disabled but not deleted all together. The alarm option can be used for alarm conditions triggered by an external source such as a low H₂S sensing tape sensor, or a low pressure switch. The bypass option is used when the bypass wants to be activated by an external/remote switch. The acknowledge alarm option is used when a latched alarm wants to be acknowledged remotely by a switch; it is possible to acknowledge a latched alarm locally through the display.

Active State: The "active state" is the alarm state for the discrete input. An open active state means that the controller board will be seeing a zero value when in alarm. If a fail-safe is required, the discrete input's active state should be closed.

Alarm Text: It is the name giving to the DI alarm. The name appears in the analyzer's display when the alarm is triggered. The total amount of characters that the LCD display can take is 8 characters.

Bypass to monitor status: It is an option to remotely know whether the analyzer is in bypass mode or not. When selecting this option (checkbox), a digital output (solenoid, relay, virtual or LED) needs to be selected. The selected digital output will disregard the bypass condition (to be in a "Non-alarm state) and it will change states only when the bypass change conditions from ON/OFF and vice versa.

Discrete Outputs: In this subsection in the software, solenoids, relays, virtual, and LED's "states" are selected when in normal and when in alarm. The "active state" is the alarm state for the discrete output. An open active state means that the controller board will be seeing a zero value when in alarm. If a fail-safe is required, the discrete output's active state should be closed. Latching is also selected in this subsection. Acknowledging can be achieved locally through the display or remotely through a switch (Discrete Input).

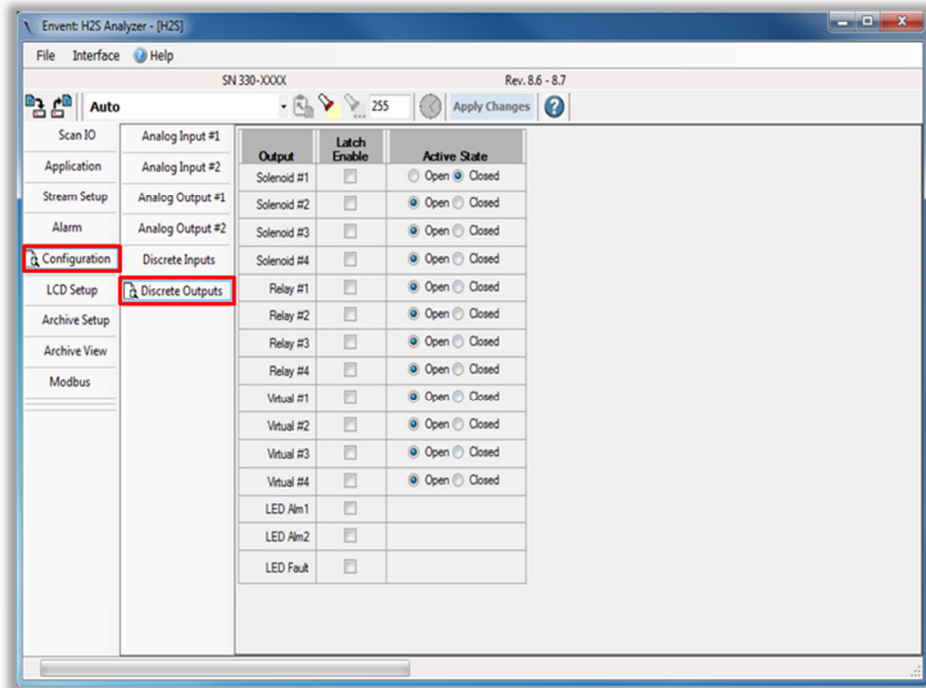

Figure 37. H₂S Software: Configuration Tab: Discrete Output Tab

LCD Setup

In this section, system variables can be selected to be shown in the analyzer's LCD display. This allows the user to be able to see a current value or reading or to be able to change an alarm setpoint locally.

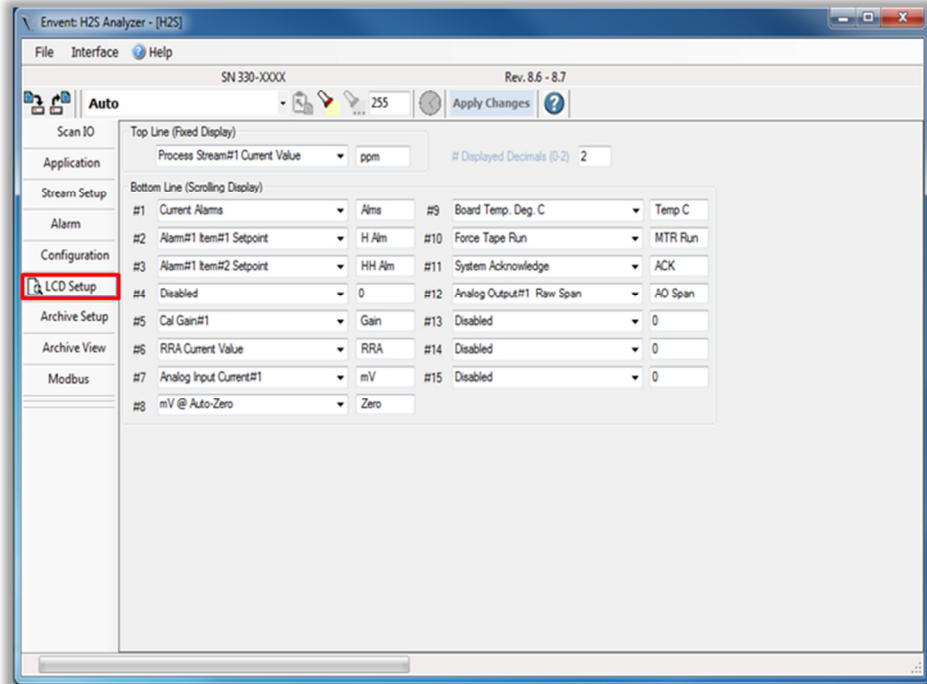

Figure 38. H₂S Software: LCD Setup Tab

In the software, one variable can be selected in the Top line of the display, usually the H₂S current value is selected by default. For the bottom line, a total of 15 variables can be selected. A blank section next to each variable drop down menu is used for text to name the variable implemented. A total of 8 characters maximum can be used. The number of decimal for the variables can be from none to up to 2 decimals.

Archive Setup

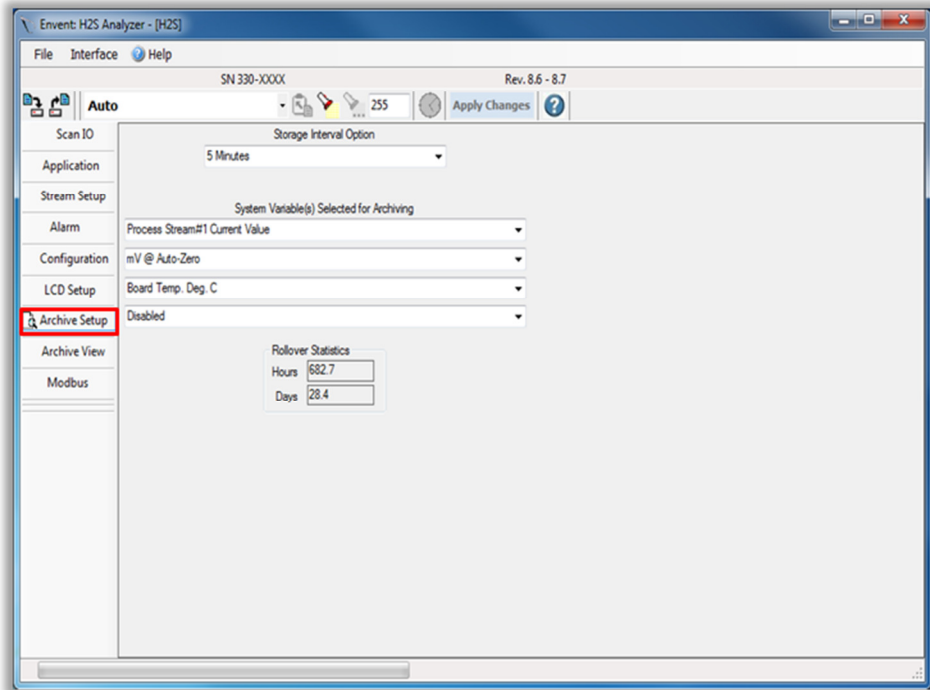

Figure 39. H₂S Software: Archive Setup Tab

Archive setup allows the user to select up to 4 system variables for archiving their values obtained for a certain interval of time. The Storage Interval Option drop down box has different time intervals for archiving the variables, from every one minute to once a day. The Rollover Statistics allows the user to see how many days or how many hours the controller board memory has to store the archived data before it becomes full. The longer the time interval the variable is stored, the longer it takes for the memory to be full. By default, all 330/331 H₂S analyzers are set to 5 minutes.

Archive View

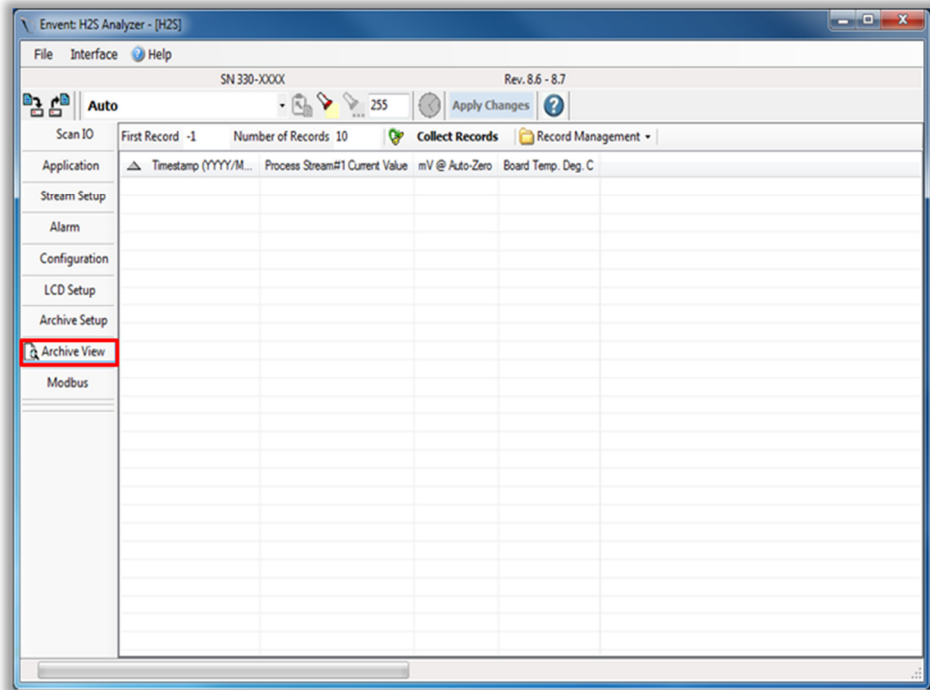

Figure 40. H₂S Software: Archive View Tab

Archive View allows the user to retrieve all records for archived variables (only the ones selected in the Archive Setup Section).

In the box "Number of Records", the user can select the amount of records it wants to retrieve. By default, the top records are the most recent ones. Once a number is selected, click on "Collect Records" to obtain the records.

To copy these records, click on the "Record Management" and copy to clipboard.



When the memory is full, the oldest archived values will be deleted and replaced by new archived values.

Modbus

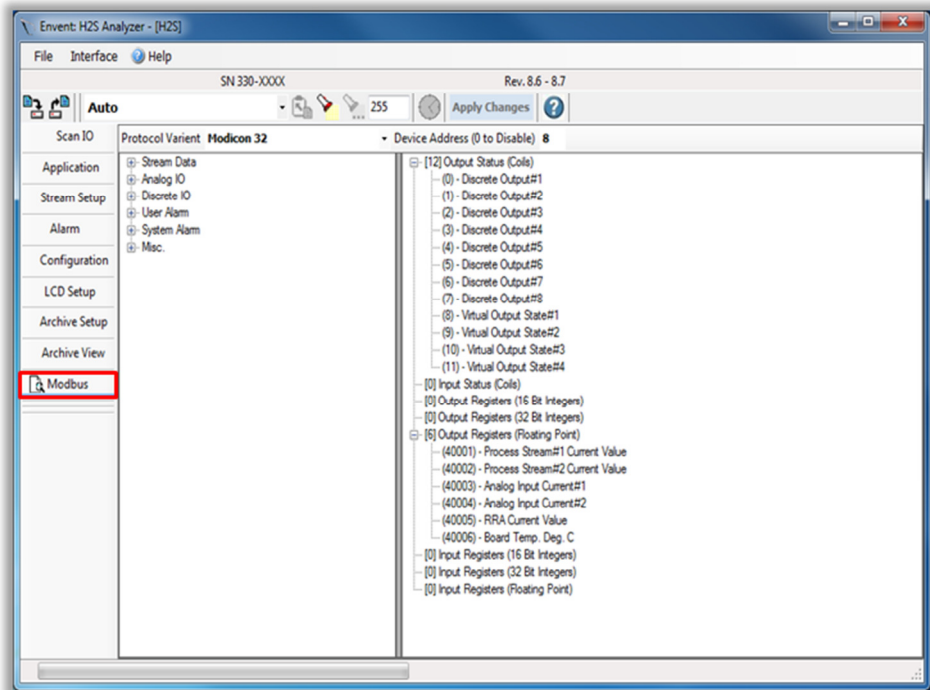

Figure 41. H₂S Software: Modbus Tab

Modbus Registry" on page 77 for more information on the default registry.

To remove a Modbus registry in the right side window, simply select the registry and delete. To add a Modbus registry look in the left side menu and once found, drag into the right side Modbus registry. To move Modbus registries up and down in the list, click on the registry, hold down the control key and click on the up and down arrow in your keyboard.

CALIBRATION PROCEDURES

H₂S Gas Calibration

Depending on the application, the 330/331 H₂S analyzer will require more or fewer periodic calibrations. There is no specific time as to how often the H₂S analyzer should be calibrated. It will depend on the application, importance of accuracy for the application, and how dirty or clean the environment and sample are. The following is the calibration procedure for the 330/331 H₂S analyzer:

1. Source a calibration gas of H₂S in balance of N₂ regulated to 15 psi (check expiry date). H₂S concentration to be approximately 2/3 of full scale range or close to the H₂S alarm set point.
2. Press the bypass button and verify the "Bypass" LED illuminates (alarms will be held in the non- alarm state).
3. Turn off all gas supplies to the analyzer and check that a sufficient amount of H₂S sensing tape is installed.
4. Press the "Menu/Set" button until "Mtr Run" is displayed. Press the right arrow [→], the H₂S sensing tape will advance for approximately 10 seconds.
5. Press the "Menu/Set" button until "mV" is displayed ("###mV"). If the mV reading is 1000mV (± 100 mV), proceed to the next step, otherwise re-zero sensor (Refer to "Re-zero Sensor Procedure" on page 62).
6. Connect calibration gas to calibration port and turn 3 way calibration valve 180°. The valve handle should be pointing towards where the gas bottle tubing is connected to.
7. Turn on sample inlet valve, ensure that the sample regulator is supplying 15psig to the eductor (make sure there is suction from the eductor block). Adjust the flow meter to 2.0. Wait until the H₂S reading has stabilized (10 to 15 minutes).
8. With calibration gas applied, if H₂S reading is satisfactory ($\pm 2\%$ of analyzer full range) skip to step 16, if H₂S reading is not satisfactory a gain adjustment is required, continue to step 9.
9. Press the "Menu/Set" button until the gain setting is displayed ("### Gain").
10. Calculate the new gain. New gain value should be within approximately 25% of the gain installed at the factory.

$$\left[\frac{\text{Cal Gas Concentration}}{\text{Current Readings}} \right] \times (\text{Current Gain}) = (\text{New Gain})$$

11. To adjust the gain setting such that the analyzer displays the correct H₂S concentration, press the right [→] and / or left [←] arrows until the cursor is underneath the number you wish to change.
12. Adjust the number using the "Menu/Set" button (it will increase until "9" then will cycle back through "0").
13. Save the new gain value by pressing the right arrow [→] until "Saved" appears or discard by pressing the left [←] arrow until "Cancel" appears.
14. Allow the analyzer to complete two cycles using the new gain value. The H₂S reading should match the calibration gas concentration. Repeat step 10 if necessary.
15. Return to sample gas flow using the 3 way calibration valve.
16. Set the sample gas pressure to 15 psig and set the flow meter to 2.0.
17. Disconnect the calibration gas supply.
18. After waiting 10 to 15 minutes confirm the analyzer reads below the H₂S alarm set points.
Remove the analyzer from bypass mode by pressing the bypass button. Verify the "Bypass" LED turns off.



Alarms are armed after removing the bypass mode.

Re-zero Sensor Procedure

1. Press the bypass button and verify that the "Bypass" LED illuminates.
2. Turn off sample gas flow using sample inlet valve.
3. Press the "Menu/Set" button until "Mtr Run" is displayed. Press the right arrow [→], the H₂S sensing tape will advance for approximately 10 seconds.
4. Remove the sensor cover.
5. Press the small pushbutton on the sensor block located on the lower left side next to the wire connector.
 - The sensor block will implement a "re-zero" procedure, indicated by a lit, red LED.

- When the "re-zero" procedure is complete the LED light will turn green.
6. Initiate another motor run (Step 3).
 7. Press the "Menu/Set" button until "### mV" is displayed.
 - Value should be 1000mV (\pm 100mV)
 8. Put on sensor cover.
 9. Turn on sample gas flow using sample inlet valve.
 10. Set the gas pressure to 15 psig and the flow meter to 2.0.
 11. Confirm the analyzer reads below the H₂S alarm set points.
 12. Remove the analyzer from bypass mode by pressing the bypass button.
Verify the "Bypass" LED turns off.



Alarms are armed after removing the bypass mode.

MAINTENANCE

The 330/331 H₂S analyzer will provide reliable service with very little attention. If the analyzer is kept clean there should be no requirement to recalibrate from factory gain settings. However, regular check-up (at least every three months) will ensure that the analyzer is operating to specifications.

- Ensure that the H₂S sensing tape take-up and feed reels are tight
- Ensure that the flow meters, humidifier tubing and sample chamber tubing are free of liquid or particulate contamination. If the sample conditioning system is flooded with liquid, refer to "Sample Conditioning System Cleaning Procedure" on page 65.
- Ensure there is enough H₂S sensing tape, especially if a low H₂S sensing tape sensor is not installed. Refer to "H₂S Sensing Tape Change Procedure" on page 64.
- Check the sample conditioning filter(s) every time the H₂S sensing tape is replaced. Replace the filter(s) as required.

H₂S Sensing Tape Change Procedure

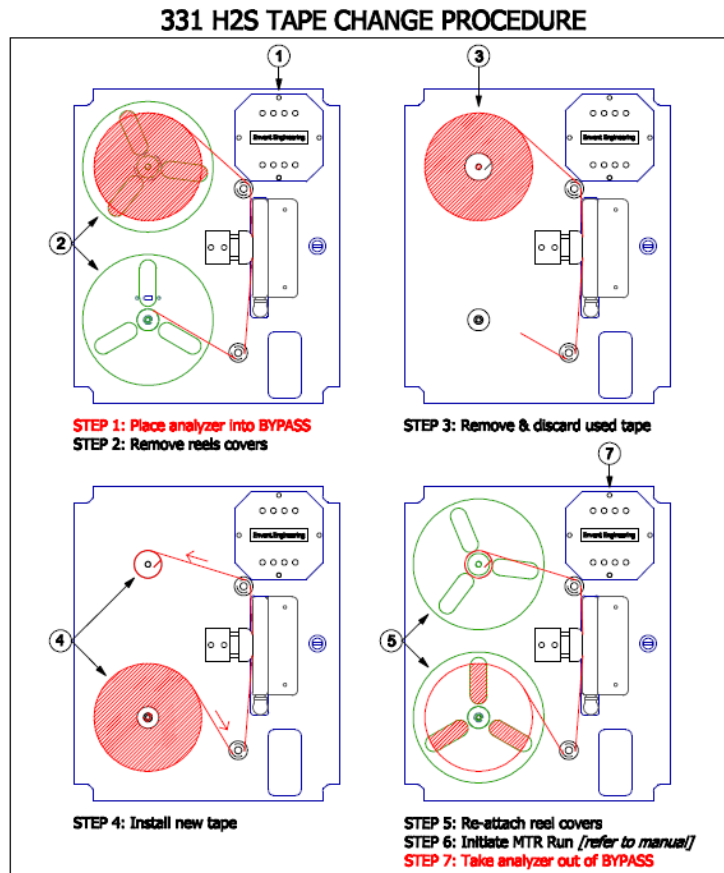

Figure 42. 331 H₂S Sensing Tape Change Procedure (Applicable for 330 Analyzers)

Sample Conditioning System Cleaning Procedure

During start-up or plant upset situations, the 330/331 H₂S analyzer may become contaminated with amine or hydrogen sulfide scavenger solution. This may cause the analyzer to read low (this can be determined at calibration). If the analyzer reads low, it will require incremental increases in the gain to maintain calibration. Please refer to factory calibration sheet for factory set gain factor. The scavenger solution is water soluble and therefore is relatively easy to clean.

Material List

Cleaning Kit Part Number: 330900

- Alconox laboratory cleaner or equivalent residue free cleaning agent
- Fresh water
- 100% Isopropyl Alcohol
- Large bucket to mix cleaning product
- Rinse bottle



Do not use solvents, brake cleaners, soaps, detergents or rubbing alcohol to clean up analyzer or sample system.

Procedure

1. Mix a 1% (2-1/2 tbsp per gallon) of Alconox in warm water
2. Sample line tubing
 - Shut off flow at the sample point prior to sample conditioning system
 - Flush the sample line and components with cleaning solution
 - Rinse with fresh water
 - Flush with isopropyl alcohol
 - Dry with clean, dry instrument air or gas
3. Sample conditioning system – Take pictures of SCS before disassembling
 - Remove filter elements from filter housings and discard
 - Remove all sample conditioning system components and soak in cleaning solution
 - Ensure valves are fully open when cleaning
 - Flush sample components with fresh water
 - Rinse with isopropyl alcohol
 - Blow dry with clean compressed air or fuel gas
 - If the clear vinyl tubing appears discolored, replace the tubing.
 - Nafion tubing on humidifier should be replaced if it appears contaminated



Disassembly of the pressure regulator and solenoids in the field is not advised. Consult the factory if the regulator or solenoid appears contaminated.

4. Re-assemble Stainless Steel Tubing to analyzer according to analyzer drawing, refer to pictures taken before disassembling or refer to drawing package.
5. Once sample conditioning system has been re-assembled, apply calibration gas to the analyzer. Refer to "H₂S Gas Calibration" on page 61.

TROUBLESHOOTING

H₂S Readings Issues		
Problems	Possible Reasons	Possible Solutions
Erratic H ₂ S Readings	Trigger slide and H ₂ S sensing tape not seated properly	Ensure trigger slide and H ₂ S sensing tape are seated in the groove of the sample chamber.
	Pressure in building moving up and down from fan, exhaust or wind	The eductor should counteract this effect, however, the eductor may be plugged or vent blocked. Check there is no blockage and that all vent tubing and fitting are 316 stainless steel, sized 3/8" or larger on a downward slope.
	Sample vent/Eductor either blocked or frozen	Check there is no blockage on the vent and/or eductor. Check for vacuum in Eductor block. Vent tubing and fittings should be 316 stainless steel 3/8" or larger on a downward slope. Possible heat trace required.
	Analog input 2 jumper removed	Re-install jumper in Analog Input across (+4-20 & -4-20) on the controller board.
	Sensor block fault	Re-zero sensor block. Refer to "Re-zero Sensor Procedure" on page 62. Check for green status led on sensor block once procedure is done & proper mV on white H ₂ S sensing tape.
	Sensor did not zero on white H ₂ S sensing tape	Check the H ₂ S Sensing tape, if not properly installed, refer to "H ₂ S Sensing Tape Change Procedure" on page 64 or on sticker in the analyzer's door. Perform a motor Run: Display>Press Menu Button until "MTR Run">Press right button. This will activate the motor and move the H ₂ S Sensing tape for a few seconds. Re-zero sensor block if necessary. Refer to "Re-zero Sensor Procedure" on page 62.
	Regulator not maintaining 15 psig (Changing flow rate to analyzer)	Replace Regulator, Consult Envent Engineering Ltd.
<i>Continued on next page</i>		

H₂S Readings Issues (Cont'd)		
Problems	Possible Reasons	Possible Solutions
	Contaminants in sample chamber	Clean sample chamber, aperture and window; replace if required. Contact Envent Engineering Ltd for replacement assistance.
	Contaminants or liquid carry over in sample conditioning system	If contaminants or liquid has carried over the sample system, refer to "Sample Conditioning System Cleaning Procedure" on page 65.
	Humidifier leaking	Humidifier needs to either be repaired or replaced. Consult Envent Engineering Ltd.
	Possible high pressure in flare line (Dilution option only)	Install a higher rated check valve.
Slow response	Aperture in chamber not optimized for required range	Consult "Aperture Strip" on page 19 for aperture size and contact Envent Engineering Ltd to order aperture and for assistance to install new aperture and re-calibrate analyzer. Refer to "H ₂ S Gas Calibration" on page 61
	Contaminants or liquid carry over in sample conditioning system	If contaminants or liquid has carried over the sample system, refer to "Sample Conditioning System Cleaning Procedure" on page 65.
Higher than Expected Readings	Sample vent/Eductor either blocked or frozen	Check there is no blockage on the vent and/or eductor. Check for vacuum in Eductor block Vent tubing and fittings should be 316 stainless steel 3/8" or larger on a downward slope. Possible heat trace required.
	Contaminants in sample chamber	Clean sample chamber, aperture and window; replace if required. Contact Envent Engineering Ltd for replacement assistance.
	Aperture out of place or not optimized for required range	Remove the sample chamber, unscrew the sensor block and check that the aperture is not out of place. Consult "Aperture Strip" on page 19 for aperture size and "H ₂ S Gas Calibration" on page 61. Contact Envent Engineering Ltd to order aperture (if applicable) and for assistance to install new aperture and re-calibrate analyzer.
<i>Continued on next page</i>		

H₂S Readings Issues (Cont'd)		
Problems	Possible Reasons	Possible Solutions
	Sensor/ sensor wire failure	Re-zero the sensor block. Refer to "Re-zero Sensor Procedure" on page 62. If procedure fails, sensor or sensor wire may require replacement.
	Gain set too high	Gain is too high for the current setup. Re-calibrate analyzer and refer to current gain (from factory). The difference between factory gain and new gain should not be greater than +/- 2%
	Higher than required pressure/flow	Adjust pressure regulator to 15psig and flow meter to "2"
	Dilution canister tubing loose (Dilution option only)	Tubing inside the canister leaking. Open canister (follow all safety procedures to bleed out all high H ₂ S level concentrations) and re-connect the tubing to the fittings on canister lid. Contact Envent engineering Ltd for replacement if required.
	Total Sulfur's Hydrogen flow was decreased at the flow meter (Total Sulfur option only)	The flow of hydrogen being mixed with sample gas has been decreased. Either the hydrogen bottle is empty, or the flow was decreased through the flow meter knob. Adjust back to appropriate flow rate.
Lower than Expected Readings	Leaks in the sample system causing lower readings	Do a leak check on the sample system and humidifier. Use Snoop to detect the possible leaks in the system.
	Flow is too low	Make sure that the flow of sample gas coming into the analyzer is set to "2" (100 - 200 cc/min) at the flow meter.
	Gain set too low	Gain is too low for the current setup. Re-calibrate analyzer and refer to current gain (from factory). The difference between factory gain and new gain should not be greater than +/- 2%
<i>Continued on next page</i>		

H₂S Readings Issues (Cont'd)		
Problems	Possible Reasons	Possible Solutions
	Not using the humidifier or humidifier leaking	A humidifier is not necessary if the sample gas inlet is already humidified. If the sample gas inlet is dry, a humidifier must be used. Make sure the humidifier unit is placed and installed correctly. Please refer to "Humidifier Unit" on page 21. Humidifier Leaking: it needs to either be repaired or replaced. Consult Envent Engineering Ltd.
	Sensor/ sensor wire failure	Re-zero the sensor block. Refer to "Re-zero Sensor Procedure" on page 62. If procedure fails, sensor or sensor wire may require replacement.
	Dilution Instrument air or carrier gas flow was increased (Dilution option only)	If the instrument air or the carrier gas is increased in flow, the readings will be lower. Make sure to keep a constant flow and pressure for the instrument or carrier gas.
	Hydrogen flow has been increased (Total Sulfur option only)	Lower the hydrogen flow to the specified on the flow meter.

H₂S Sensing Tape Issues		
Problems	Possible Reasons	Possible Solutions
Tape does not advance	No tension on take up reel	Check setscrew in take up reel collars, if loose; tighten up with a 1/16" hex key. Do a manual advance on H ₂ S sensing tape. To do a motor run: Display>Press Menu Button until "MTR Run">Press right button. This will activate the motor and move the H ₂ S Sensing tape for a few seconds.
Tape breaking	High liquid content in sample gas	Genie probe and additional filtration may be required in sample conditioning system.
	Feed wheel not spinning freely	Dust and refuse build up between feed wheel and chassis. Requires removal and cleaning of chassis.
	Tape cover wheels pressing against H ₂ S sensing tape	H ₂ S sensing tape cover wheel became warped. Needs to be flattened to not contact tape when on feed wheel bolt. If replacement needed, consult Envent Engineering Ltd.
	Trigger slide not seated properly	Ensure trigger slide is seated in groove of sample chamber.
Overlapping Stains	This is normal in the 1st 1/4 of a new H ₂ S sensing tape. It should not cause any reading problems.	If it is causing reading problems, the "stop threshold" can be modified from 1,000,000 to 500,000. Please consult Envent Engineering Ltd before proceeding with this change.
Excessive H ₂ S sensing Tape consumption	Sample vent either blocked or frozen	Check there is no blockage on the vent and/or eductor. Vent tubing and fittings should be 316 stainless steel 3/8" or larger on a downward slope. Possible heat trace required.
	Contaminants in sample chamber	Clean sample chamber. Replace aperture and window if required. Contact Envent Engineering Ltd for replacement and assistance.
	H ₂ S Sample inlet constantly being out of range from original analyzer intent	If the H ₂ S sample inlet is greater than the range of the analyzer, the tape will be consumed after than in normal operation.
	Aperture out of place	Take out the sample chamber, unscrew the sensor block and check that the aperture is not out of place. If so, refer to "Aperture Strip" on page 19 for aperture size and "H ₂ S Gas Calibration" on page 61.
<i>Continued on next page</i>		

H₂S Sensing Tape Issues (Cont'd)		
	Sensor/ sensor wire failure	Try re-zeroing the sensor. Refer to "Re-zero Sensor Procedure" on page 62. If procedure fails, Sensor or sensor wire may require replacement.
H ₂ S sensing Tape coming out of sample chamber/trigger slide	Trigger slide not seated properly	Ensure trigger slide is seated in groove of sample chamber
	Old Sample chamber style	Due to problems with the H ₂ S sensing tape coming off, we designed a better sample chamber to compensate for this. Consult Envent Engineering Ltd for a replacement if your sample chamber is the old style and you are having problems with the H ₂ S sensing tape. Implementation of change January 2012.

Electronics Issues		
Problems	Possible Reasons	Possible Solutions
Fault LED (Sensor High)	Incorrect zeroing	Make sure the H ₂ S Sensing tape is installed properly and do a motor run. To do a motor run: Display>Press Menu Button until "MTR Run">Press right button. This will activate the motor and move the H ₂ S Sensing tape for a few seconds. The alarm should clear.
	Faulty Sensor	Sensor needs to be replaced. Contact Envent Engineering Ltd for replacement.
Fault LED (Sensor Low)	Sensor did not zero on white H ₂ S sensing tape because H ₂ S sensing tape came out of sample chamber slot	Re-install H ₂ S Sensing tape. Refer to "H ₂ S Sensing Tape Change Procedure" on page 64 or on sticker in the analyzers door. Re-zero sensor block. Refer to Refer to "Re-zero Sensor Procedure" on page 62.
	Sensor/ sensor wire failure	Re-zero the sensor block. Refer to "Re-zero Sensor Procedure" on page 62. If procedure fails, sensor or sensor wire may require replacement.
<i>Continued on next page</i>		

Electronics Issues (Cont'd)		
Problems	Possible Reasons	Possible Solutions
	IS Barrier failure (For 330 analyzer series only)	IS Barrier may need replacement. Consult Envent Engineering Ltd.
	Contaminants in sample chamber	Clean sample chamber. Replace aperture and window if required. Contact Envent Engineering Ltd for replacement and assistance.
Fault LED (Low H ₂ S sensing Tape)	New H ₂ S sensing tape is required	H ₂ S Sensing tape requires change (Average of 2 to 3 days left, from the moment alarm goes off, for the tape to be completely used up). Refer to "H ₂ S Sensing Tape Change Procedure" on page 64 or on sticker in the analyzers door.
	Low H ₂ S sensing tape sensor failure	If the alarm does not clear once a new H ₂ S sensing tape is installed, the low H ₂ S sensing tape sensor or its wires have failed and need to be replaced. Consult Envent Engineering Ltd to order a replacement. Low H ₂ S sensing Tape Sensor Part #: 33046A
Fault LED (Low Pressure)	Pressure of sample gas is lower than setpoint of pressure switch (factory set to 10 psi descending)	Inspect the sample inlet upstream to troubleshoot the problem.
	Pressure switch failed	If pressure is above 10 psi and alarm continuous, the pressure switch setpoint might have changed. Set back to 10 psi descending. Also, check pressure switch wiring If the problem persists, pressure switch might need replacement. Contact Envent Engineering Ltd.
	Pressure regulator failed	The problem might be coming from the pressure regulator. Troubleshoot and consult Envent Engineering Ltd.
Fault LED (Oven Fail)	Fuse not installed.	Fuse for furnace does not come installed in the controller board. Please check spare fuse bag and install fuse.
	Oven not working properly	Oven failed and temperature has dropped below the optimal temperature. Please consult Envent Engineering Ltd.
Blank Display	Contrast needs adjustment	Change contrast by turning the potentiometer in the display board.
<i>Continued on next page</i>		

Electronics Issues (Cont'd)		
Problems	Possible Reasons	Possible Solutions
Analyzer not communicating with PC	Multiple reasons could be causing the analyzer to not communicate properly with the PC.	<p>Check that the analyzer is ON.</p> <p>Check that the communication cable is properly connected.</p> <p>Check that the computer recognizes and installs successfully the USB to Serial converter (if applicable).</p> <p>If the software application was open before connecting the communication cable from the analyzer to the computer, close the software and re-open it. Try again and enable communication.</p>
Analyzer not turning ON	Blown fuse	Check fuse in the controller board. Replace if required.
	Controller board Malfunction	Consult Envent Engineering Ltd for a controller board replacement.
	Not using the appropriate voltage rating	Make sure to use the appropriate voltage to power the analyzer. DC controller boards can be powered with 12 - 24 VDC and AC controller boards can be powered with 110 to 240 VAC. Keep in mind that if solenoids are controlled by the controller board, the voltage must match the solenoids voltage rating.
Red LED on Sensor Block	Sensor block fault	<p>Re-zero sensor block. Refer to "Re-zero Sensor Procedure" on page 62.</p> <p>Check for green status led on sensor block once procedure is done. If sensor LED stays red, consult Envent Engineering Ltd for a replacement.</p>
	Wiring not done properly	Make sure the wiring is done correctly.
Analog Outputs (4-20 mA) not working	Not using an external power supply	The Analog outputs in the controller board are loop powered and not self-powered unless <u>AO boards</u> were installed as per customer request. If AO boards were not requested, an external power supply must be used. Refer to "Analog Outputs" on page 16 to see different wiring options.
<i>Continued on next page</i>		

Electronics Issues (Cont'd)		
Problems	Possible Reasons	Possible Solutions
	The system variable for output has been modified.	By factory configuration, the Analog outputs (1 & 2) are configured to output based on the Process stream: current value of stream 1 and, if applicable, stream 2. Make sure that if they are modified, that the right system variables are selected.
Not coming out of alarm	Alarms are latched	If alarms are latched, they need to be acknowledged. Go to the display> cycle through until "ACK" is reached> press the right button to acknowledge all latched alarms. To deactivate the latching on any alarm, use the H ₂ S software, and connect to the analyzer and de-select latching on any alarm that is latched. Refer to "Configuration Tab" on page 52.
	The analyzer is actually in alarm	Make sure the alarm setpoint values are as desired and that the analyzer is below (or above – like temperature setpoint) those setpoint values.

Sample Conditioning System Issues		
Problems	Possible Reasons	Possible Solutions
Liquid Carried over in SCS	Sample too wet for current conditioning sample system.	If a one-time occurrence: Cleaning required for sample system, refer to "Sample Conditioning System Cleaning Procedure" on page 65. If more than one time occurrence: Sample conditioning system may need a system for wet/dirty sample gas (extra filters set as coalescing, add liquid float stops, etc.). Consult Envent Engineering Ltd.
Regulator not maintaining 15 psi (erratic H ₂ S readings)	Problems with the Regulator (over pressured)	Replace Regulator, Consult Envent Engineering Ltd.
	Liquid carried over into regulator	Consult Envent Engineering Ltd.
	Problems with the (50 psi) sample pre-regulator at the sample point.	Heated regulator may be required if liquid hydrocarbon carry over is present at the pre-regulation sample.
<i>Continued on next page</i>		

Sample Conditioning System Issues (cont'd)		
Problems	Possible Reasons	Possible Solutions
Pressure gauge not working	Over pressured gauge	Replacement is required. Consult Envent Engineering Ltd for replacement.
Flowmeter not working	Liquid carried over into flowmeter	Consult Envent Engineering Ltd.
Frozen humidifier	Analyzer is being exposed to temperatures below 0 degrees C (or - 2 degrees C if 5% acetic acid is used)	Do not expose analyzer to temperatures below 0 degrees C or - 2 degrees C
Humidifier leaking liquid	The humidifier body cracked - Could be due to extreme temperature changes.	A replacement may be required. Consult Envent Engineering Ltd for a replacement.

Calibration Issues		
Problems	Possible Reasons	Possible Solutions
Change gain more than +/- 25% from original gain after calibration	Not using the right calibration bottle	Make sure the calibration bottle is within analyzer range. It is recommended that calibration gas used is close in value to where the alarm setpoint values need to be (for more accuracy).

APPENDICES

Modbus Registry



NOTE

Please note that due to differences in PLC's, these registries may be shifted by one value. These can be modified if necessary using the H₂S software.

Coils		MODICON 32-bit Standard protocol	Enron Protocol
Discrete Output 1	Solenoid 1	0000	1001
Discrete Output 2	Solenoid 2	0001	1002
Discrete Output 3	Solenoid 3	0002	1003
Discrete Output 4	Solenoid 4	0003	1004
Discrete Output 5	Relay 1	0004	1005
Discrete Output 6	Relay 2	0005	1006
Discrete Output 7	Relay 3	0006	1007
Discrete Output 8	Relay 4	0007	1008
Virtual Output 1	DI-1 (Low Tape)	0008	1009
Virtual Output 2	Sensor Low	0009	1010
Virtual Output 3	Sensor High	0010	1011
Virtual Output 4	Low Temp	0011	1012
Floating Point		MODICON 32-bit Standard protocol	Enron Protocol
Process Stream 1 (H ₂ S)		40001	7001
Process Stream 2 (H ₂ S)		40002	7002
Analog Input Current 1 (Raw mV)		40003	7003
Analog Input Current 2 (Temp F)		40004	7004
RRA Current Value (H ₂ S)		40005	7005
Board Temperature (C°)		40006	7006

Recommended Spare Parts List

Part Number	Quantity	Description
330063	1	Humidifier Rebuild kit c/w Elbows, Nafion Tube, ftg
330079	2	Rear Window & Gasket
330100-330110	1	Aperture Strip (Associated to measurement range)
330130	1	4 liter Containers of Acetic Acid
330133XS	12	300' Lead Acetate Tape (H ₂ S Sensing Tape)
330406	1	Box of 10 Micro Filter Glass Fiber Element 12/19-57-50CSK
330423	2	13" Chubby Quartz Tube (Total Sulfur option only)
330431	4	Kalrez O-rings (Total Sulfur option only)
330900	1	Tubing, Cleaner, Fittings Maintenance Kit
330429	1	TS Ceramic Heater (Total Sulfur option only)

Chico A Sealing Compound: For sealing fittings in Hazardous Locations

INSTALLATION

DAM:

Using "Chico X" Fiber, make a dam in each conduit hub (except the one extending upward) so that the "Chico A" sealing compound, while fluid, cannot leak out of the sealing chamber.

Use the EYS-TOOL-KIT to pack a proper fiber dam (do not use metal tools). Proceed as follows:

1. Force the conductors forward.
2. Pack fiber into each conduit hub behind the conductors.
3. Push the conductors backward and force them apart.
4. Pack fiber between and around the conductors in each conduit hub. It is important that the conductors be permanently separated from each other, so that the sealing compound will surround each conductor.
5. Pack fiber into each conduit hub in front of the conductors.

⚠ CAUTION:

Do not leave shreds of fiber clinging to side walls of sealing chamber or to the conductors. Such shreds when imbedded in the compound may form leakage channels. The completed dam should be even with the conduit stop.

6. If the Condulet is of a type or size that has a separate work opening, this should be closed by its cover before pouring the seal.

COMPOUND:

Follow these instructions carefully:

Use a CLEAN mixing vessel for every batch. Particles of previous

batches or dirt may spoil the seal. The recommended proportions are, by VOLUME– 2 parts of Chico A compound to 1 part of clean water. Do not mix more than can be poured in 15 minutes after water is added. Use cold water. Warm water increases speed of setting. Stir immediately and thoroughly.

⚠ CAUTION:

If a batch has started to set, do not attempt to thin it by adding water or by stirring. Such a procedure may spoil the seal. Discard partially set material and make up fresh batch. After pouring, immediately close the pouring opening.

FOR APPLICATIONS INVOLVING GROUPS C AND D

⚠ CAUTION:

Sealing compound to be mixed ONLY at temperatures above 35°F (2°C) and ONLY poured into fittings that have been brought to a temperature above 35°F (2°C). Seals must NOT be exposed to temperatures below 35°F (2°C) for at least 8 hours.

FOR GROUP B APPLICATIONS

⚠ CAUTION:

Sealing compound to be mixed ONLY at temperatures above 40°F (4.4°C) and ONLY poured into fittings that have been brought to a temperature above 40°F (4.4°C). Seals must NOT be exposed to temperatures below 40°F (4.4°C) for at least 72 hours.

KEEP compound dry by having container cover tightly closed when not in use.

NOTE: For additional details see IF 287 packed with sealing fitting.

Safety Data Sheet for H₂S Sensing Tape



SAFETY DATA SHEET (SDS) Global Harmonization System

SECTION 1: CHEMICAL PRODUCT AND COMPANY IDENTIFICATION

1.1 Product Identifier / Product Name

REF (Product Code) 90746
Product Name Lead Acetate Impregnated Paper Tape
1 x roll Lead acetate paper

1.2 Relevant identified uses of the substance or mixture and uses advised against

Relevant identified uses
Product for Analytical Use.
The Exposure scenario is integrated into sections 1-16.
Uses advised against
not described

1.3 Details of the supplier and of the safety data sheet

Manufactured by:

Envent Engineering Ltd.
7060 Farrell Road SE
Calgary, AB, CANADA
Tel.: 1-403-253-4012

E-mail: info@envent-eng.com

1.4 Emergency telephone number

For Chemical Emergency
Spill, Leak, Fire, Exposure, or Accident
Call Envent Engineering 1-403-253-4012
Toll Free: 1-877-936-8368

SECTION 2: HAZARDS IDENTIFICATION

2.1 Classification of the substance(s) or mixture(s)

Lead acetate paper

EU Directive 1999/45/EC
Hazard Symbols

R 33-61



GHS Directive
Hazard Symbols

T



GHS08

Signal Word

DANGER

Hazard Identification

Hazard Classes/Categories

H360Df
H412

Reproductive Toxicity cat. 1B
Hazardous to the aquatic environment - chronic cat. 3

2.2 Safety, health and environmental regulations/legislation specific for the substance or mixture

According GHS inner packages must be only labelled with symbol(s) and product identifier.

Lead acetate paper

EU Directive 1999/45/E
Hazard Symbols:



T

R 33-61

Danger of cumulative effects. May cause harm to the unborn child.

S 53

Avoid exposure — obtain special instructions before use.

GHS Directive

Revision 1

1

SAFETY DATA SHEET (SDS) Global Harmonization System

Hazard Symbols:



GHS08

Signal Word: DANGER

H360Df

May damage the unborn child. Suspected of damaging fertility.

P202, P280sh, P308+313, P405

Do not handle until all safety precautions have been read and understood. Wear protective gloves/eye protection. IF exposed or concerned: Get medical advice/attention. Store locked up.

2.3 Other hazards

Possible Hazards from physicochemical Properties

Information pertaining to particular Risks to Human and possible Symptoms

Can accumulate within the body.

Information pertaining to particular Risks to the Environment

Other Hazards

SECTION 3: COMPOSITION/INFORMATION ON INGREDIENTS

3.1 Substances or 3.2 Mixtures

Lead acetate paper tape

Chemical: lead(II) acetate (trihydrate)

Correlation Factor: x 0.546 (-%Pb)

Weight Percent: 10%

Chemical Formula: C4 H6 O4 Pb .3H2 O

Toxic Substance Control Act (TSCA) Inventory: not listed

Registry of Toxic Effects of Chemical Substances (RTECS): OF8050000

EC No.: 206-104-4

Index No: 082-005-00-8

acc. 1999/45/EC: R33-52-53-61

acc. GHS: H360Df, H412

Chemical : filter paper (cellulose CAS 9004-34-6)

Weight Percent: 80-100%

Chemical Formula: (C6 H10 O5)n

Toxic Substance Control Act TSCA Inventory: listed

Registry of Toxic Effects of Chemical Substances (RTECS): FJ5691460

EC No.: 232-674-9

acc. 1999/45/EC: -

acc. GHS: not necessary

3.3 Remarks

List of R and H phrases: see section

SECTION 4: FIRST AID MEASURES

4.1 Description of First aid measures

Place insured person out of danger zone to fresh air immediately. Ensure quiet, warmth, and provide resuscitation if necessary. If necessary contact medical advice.

4.1.1 After SKIN Contact

Remove dust with wetted tissue. Remove contaminated clothing. Rinse the affected skin or mucous membrane thoroughly under running water.

4.1.2 After EYE Contact

Rub dust with teardrops from eyes or: After contact with the eyes rinse thoroughly under running water with the eyelid wide open with eye washing bottle, eye douche or running water (protect intact eye).

4.1.3 After INHALATION of Vapors

After inhalation of dust fresh air should be inhaled.

4.1.4 After ORAL Intake

After oral intake lots of water should be drunk after it has been ingested.

4.2 Most important symptoms and effects, both acute and delayed

4.3 Indication of any immediate medical attention and special treatment needed

SECTION 5: FIREFIGHTING MEASURES

- 5.1 Extinguishable Media**
 Fire extinguishers appropriate to the fire classification, and, if applicable, a fire blanket must be available in a prominent location in the work area. All extinguishers like WATER FOG, WATER SPRAY, alcohol-resistant FOAM, DRY CHEMICAL, CARBON DIOXIDE can be used.
- 5.2 Special hazards arising from the substance or mixture**
- 5.3 Advice for firefighters**
 No, for listed product. Product package burns like paper or plastic.
- 5.4 Additional Information**
 --

SECTION 6: ACCIDENTAL RELEASE MEASURES

- 6.1 Personal Precautions, Protective equipment and Emergency procedure**
 Regular staff training is necessary.
- 6.2 Environmental precautions**
 --
- 6.3 Methods and material for containment and cleaning up**
- 6.4 Reference to other sections**
 --

SECTION 7: HANDLING AND STORAGE

- 7.1 Precautions for safe handling**
 Handling in accordance with the test instruction, that comes with the product.
- 7.2 Conditions for safe storage, including any incompatibilities**
 The original product package of Envent Engineering allows a safe storage.
 Storage class: see section 12.1
- 7.2.1 Conditions for safe storage, including any incompatibilities**
 Keep original product packages tightly closed during handling and storage.
- 7.3 Specific end use(s)**
 --

SECTION 8: EXPOSURE CONTROLS / PERSONAL PROTECTION

- 8.1 Control parameters**

Lead acetate paper		CAS No.: 6080-56-4
Chemical:	<i>lead(II) acetate (trihydrate)</i>	
Canada CEPA 1999:	not listed	
TSCA Inventory:	not listed	California Prop. 65 List: listed cancer
NIOSH:	NTP Report on Carcinogens (RoC) List Yes (Lead compound - Reasonably anticipated to be a human carcinogen)	
OSHA:	not listed	
EU carcinogen:	Re 1, Rf 3	
EU value:	0.15 Pb mg/m³	
filter paper (cellulose CAS 9004-34-6)		CAS No.: -
Canada CEPA 1999:	DSL yes	
TSCA Inventory:	listed	California Prop. 65 List: not listed
NIOSH:	not listed	
OSHA:	not listed	

- 8.2 Exposure controls**
 The highest level of cleanliness must be maintained at the workplace.
- 8.2.1 Respiratory Protection**
 Only if additional recommendations in test instruction or packing insert.
- 8.2.2 Hand Protection**
 Yes, gloves (permeation time >30 min - level 2), consist of PVC, Natural latex, Neopren, or Nitril. Use for short times chemical resistant Latex gloves f.ex. with code EN 374-3 level 1.
- 8.2.3 Eye/face Protection**
 Yes, Splash Goggles.
- 8.2.4 Skin Protection**
 Recommended.
- 8.2.5 Hygiene measures**
 Eating, drinking, smoking, taking snuff and storage of food in work areas and at outdoor workplaces is prohibited. Avoid contact with the skin, eyes and clothing. Rinse any clothing on which the substance has been spilled, and soak it in water. Wash hands thoroughly with soap and water when stopping work and before eating, and then apply protective skin cream.



SAFETY DATA SHEET (SDS) Global Harmonization System

SECTION 13: DISPOSAL CONSIDERATIONS

Please observe local regulations for collection and disposal of hazardous waste and contact waste disposal company, where you will obtain information on laboratory waste disposal (RCRA Code D002/D003, EU waste code number 16 05 06).

13.1 Waste treatment methods

SECTION 14: TRANSPORT INFORMATION

No dangerous goods according the Transport regulations

14.5 Environmental hazards

low, small amounts

14.6 Special precautions for user

not necessary

14.7 Transport in bulk according to Annex II of MARPOL73/78 and the IBC Code

not applicable

SECTION 15: REGULATORY INFORMATION

15.1 Safety, health and environmental regulations/legislation specific for the substance or mixture

U.S. Federal Regulations

OSHA "A Guide to The Globally Harmonized System of Classification and Labelling of Chemicals (GHS)"

<https://www.osha.gov/dsg/hazcom/ghs.html>

29 CFR 1910.1200 Hazard communication.

NIOSH Workplace Safety & Health Topics

TSCA Inventory

U.S. State Regulations

California Prop 65, Safe Drinking Water and Toxic Enforcement Act of 1986

Canada

Canada CEPA 1999 - Domestic Substances List (DSL), List of Toxic Substances (Schedule 1)

15.2 Chemical safety assessment

--not necessary for these small amounts

SECTION 16: OTHER INFORMATION

16.1 List of R and H Phrases

16.1.1 List of relevant R Phrases

R33

Danger of cumulative effects.

R52/53

Harmful to aquatic organisms, may cause long-term adverse effects in the aquatic environment.

R61

May cause harm to the unborn child.

16.1.2 List of relevant H Phrases

H360Df

May damage the unborn child. Suspected of damaging fertility.

H412

Harmful to aquatic life with long lasting effects.

16.2 Training Advice

Multiple safety training of staffs about danger and protection by using hazards in working area.

16.3 Recommended Restriction on Use

Only for Professional User.

An individual package of this product or test kit has a moderate hazardous potential.

16.4 Further Information

Envent Engineering Ltd. provides the information contained herein in good faith being up-to-date of own realizations at revision time.

This document is intended only as a guide to the appropriate precautionary handling of the material by a properly trained person using this product. Individuals receiving the information must exercise their independent judgement in determining its appropriateness for a particular purpose.

Envent Engineering Ltd. makes NO REPRESENTATIONS or WARRANTIES, either expressed or implied, including without limitation any warranties of merchantability, fitness for a particular purpose with respect to the information set forth herein or the product to which the information refers. Accordingly Envent Engineering Ltd. will not be responsible for damages resulting from use of or reliance upon this information. See terms and conditions at the end of our price lists for additional information.

16.5 Sources of Key Data

GHS: EU Regulation 1272/2008/EC on Classification, Labelling and Packaging of Substances and Mixtures, amending and repealing

EU Directives 67/548/EEC and 1999/45/EC, and amending EU Regulation 1907/2006/EC

MSDS: EU Regulation 453/2010/EU REACH - Requirements for the Compilation of Safety Data Sheets

KÖHN, BIRETT (German), Data Sheets of Hazardous Substances

Prepared: June 2015
Expiry Date: June 2018

Revision 1

5

This document has been continuously improved and revised over time; see the table below for revision (rev) information.

Revision No.	Revision Date	Revision Description
0	Nov 2011	Combined 330 & 331 Operator's Manual into one
1	Jan 2012	Edited sensing tape reaction formula and appendix drawings for clarity
2	Oct 2012	Added electrical rating for group B on 330
3	May 2014	Edited, formatted, changed drawings, calibration procedure
4	March 2016	Change CSA File for Intertek File
5	April 2016	New layout for entire Manual

For further information, or a copy of our most recent operating manual, please visit us at www.envent-eng.com. Envent Engineering Ltd reserves the right to change product design and specifications at any time without prior notice

