



NETZSCH

Proven Excellence.



NEMO[®] Progressing Cavity Pumps

Comprehensive and uncompromising solutions for all industries

Pumps & Systems

For more than six decades and at five sites all over the world, NETZSCH has been developing and producing high-quality, innovative pump systems supported by a large number of patents.

Good reasons

for choosing NEMO[®] Progressing Cavity Pumps

Benefit to the customer

Always focused on benefit to the customer, the NETZSCH product range covers everything from the smallest dosing pumps with flow rates of a few ml to high-performance pumps that pump up to 1000 m³/h. We also supply grinders and a comprehensive range of accessories. We supply everything in and around the pump to suit your application perfectly, because we understand and know your process.

Proximity to our customers

We guarantee proximity to our customers with 30 branches and more than 200 agencies around the world. Our application-oriented organisational structure across six business fields ensures that each of your contacts at NETZSCH[®] has detailed knowledge of the application, that national and international standards are complied with, and that contact routes are short, delivery is fast and on-site service is competent.

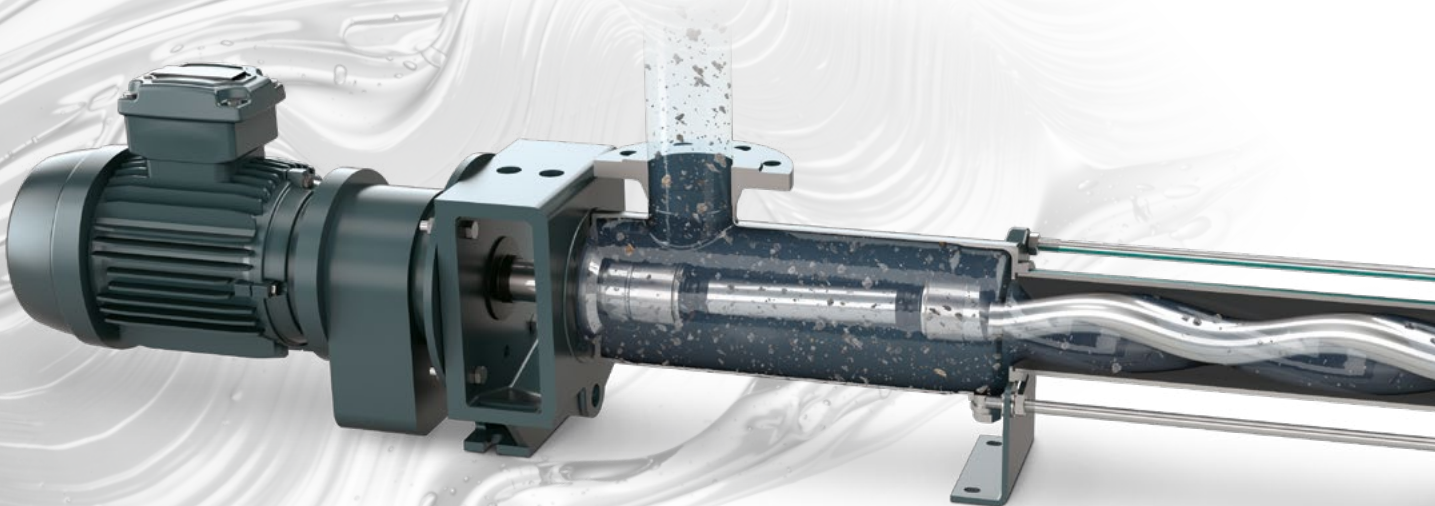

Individual pump selection

Each individual pump is precisely tuned to the requirements of the application to deliver optimum performance, service life and reliability.

The pumps are available with conveying elements in four different rotor/stator geometries, so that the right solution can always be found for your application.

Another benefit from our continued investment in product development is a range of gear joints selected to suit each and every application no matter how demanding.

And last but not least, we supply a comprehensive range of options and accessories, as well as expert service, as we want you to stay in close contact with NETZSCH even after your pump has been commissioned.

Please see for yourself and contact us.

Large capacity and pressure range

- Flow rates from just a few ml/h up to 1000 m³/h
- Number of stages ranging from 1 to 8 for pressures from 6 to 48 bar (standard) or up to 240 bar (high pressure)

Broad range of applications

The pumps are primarily used with media that have the following features:

- Containing solids (max. solid size up to 150 mm) and free of solids
- Low to high viscosity (1 mPas – 3 millions mPas)
- Thixotropic and dilatant
- Shear sensitive
- Abrasive
- Non-lubricating and lubricating
- Aggressive (pH 0 – 14)
- Adhesive
- Toxic

Wide range of materials

Our range of metallic materials extends from simple grey cast iron and chrome-nickel steel to highly acid-resistant materials such as Duplex, Hastelloy and titanium to suit different conveying tasks. Ceramics and plastics round off the list for aggressive and abrasive applications. Our elastomers range from highly abrasion-resistant natural rubber, to oil-, acid- and alkali-resistant elastomers and finally Aflas and Viton. For products in which elastomers cannot be used because of high temperatures or for reasons of durability, a large number of solid-based stators made from plastics or metallic materials is available.

(See pages 20 to 23)

Various conveying elements

Four different rotor/stator geometries are available to ensure the design is optimally adapted to the specific task.

(See page 18 and 19)

Large variety of shaft seals

The range of mechanical shaft seals includes simple seals with and without quench, double-acting seals arranged back to back or in tandem, and cartridge seals. For specific applications, stuffing-box packing, lip seals and special seals are available. A pump with magnetic coupling is available for use with toxic media – to guarantee 100% that there are no leaks.

(See pages 24 and 25)

Additional features

- High suction capacity - up to 9 mH₂O
- Direction of rotation and flow can be reversed
- Can be installed in any position
- Quiet, smooth running
- Temperatures from - 20 °C to + 200 °C



Design of the NEMO[®] Pump

1 Rotor

From wear- and corrosion-resistant metal designs to the wear-free ceramic rotor NEMO CERATEC[®].

2 Stator

We manufacture stators to the latest standards. Minimised tolerance ranges thereby optimise the performance of the pump. Our unique, fully networked production and process data monitoring system, developed in-house, is backed up by consistent quality testing.

2.1 Stator with conventional technology

The stator inlet is vulcanised into the tubes with integrated seals on both ends. The inlets are available in a wide variety of NEMOLAST[®] elastomers, plastics and metals. Stator inlet with cone-shaped opening to improve product feeding into the conveying chamber.

(see pages 20 and 21)

2.2 Stator with iFD technology

The iFD-Stator[®] consists of a two-part reusable housing with a polygonal profile and the NEMOLAST[®] elastomer housed within. The advantages of this new technology include a lower breakaway torque, higher efficiency, increased service life, simple and quick replacement, and environmentally friendly.

(See brochure NPS · 344)



3 Drive train

The drive and connecting shaft with coupling rod and two universal joints provide the power transmission from the drive to the rotor.

4 Shaft sealing

Standard design with single-acting, wear-resistant, bi-directional mechanical seals. On request, single-/double-acting mechanical seals from a range of manufacturers, as well as cartridge and special seals and stuffing-box packing.

5 Suction and pressure housing

Hydrodynamic design with flange or thread connections in accordance with DIN and international standards. Grey cast iron, chromium-nickel-molybdenum steel, rubber-lined or Halar[®]-coated cast iron and special materials as per requirements.

Halar[®] is a registered trademark of Solvay Solexis



NEMO® industrial block pump

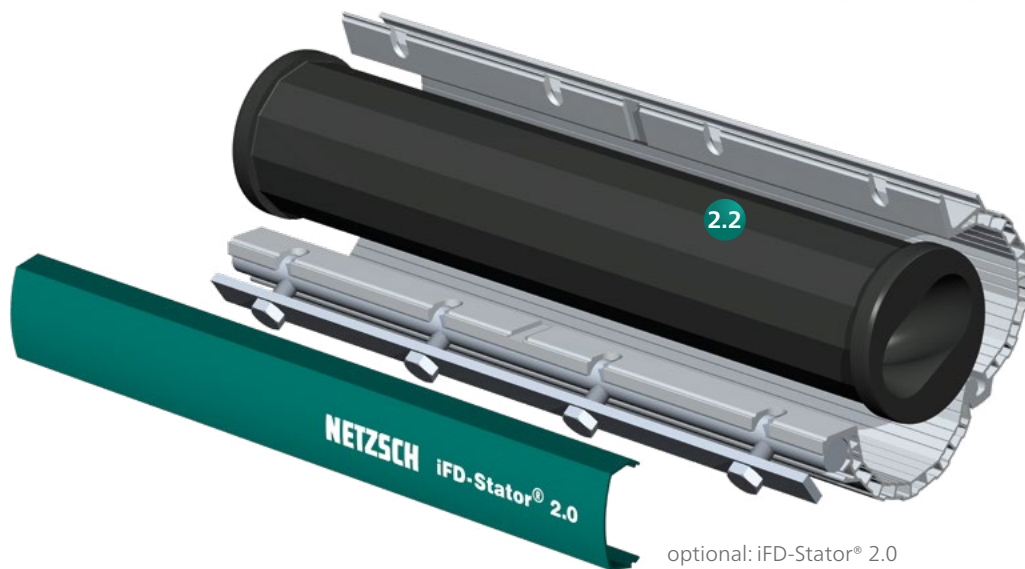

optional: iFD-Stator® 2.0

6 Block design

As the drive is directly flanged onto the pump's lantern, the dimensions are compact, the overall weight is low, the shaft heights are constant irrespective of the design and size of the drive – the pump requires low maintenance, is easy to maintain and economical.

„Full Service in Place“

Pump service without removing the pump from the system

The NEMO® Progressing Cavity Pump in FSIP® design is available...

- in the sizes NM 045 to NM 105 for flow rates from 2 to 200 m³/h
- for differential pressures from 6 bar (1 stage) up to 12 bar (2 stages)
- in various materials, from steel to chrome-nickel-steel, various other materials on request
- with various stator elastomers, from highly abrasion-resistant natural rubber, to oil-, acid-, and alkali-resistant elastomers, to Aflas and Viton
- in all 4 geometries, S, L, D, and P to be customized optimally to your application

...and conveys

- substances with consistencies from runny to pasty, with or without solid content.



1 Housing in FSIP® design with inspection cover

The FSIP® design of the suction housing mainly differs from the standard design when you look at the new large inspection cover, but the housing dimensions remain unchanged. All installed NEMO® BY/SY pumps in the sizes mentioned above can be upgraded without any problem. After this upgrade you can fully service the pump while it is installed. All wetted parts are immediately accessible. All wearing parts can be replaced in less than half the time.

2 Inspection cover

The inspection cover is fixed by only 5 screws which can be easily removed without special tool.

3 Stator with iFD® technology

The stator consists of a reusable two-part stator housing and an exchangeable elastomer part. The benefits of the new technology are a reduced starting torques, higher degree of efficiency, prolonged lifetime, easier and faster change of the wear part and environmentally friendly disposal. In combination with the suction housing in FSIP® design there is the additional benefit that the rotor/stator can be changed simply and quickly outside the pump and without pre-tensioning, once the stator housing has been opened. The rotating unit can simply be lifted out and leaves the pump open from flange to flange. The formerly needed „service length“ is no longer required, giving the pump a much shorter footprint – a strong argument for the installation of the relatively long progressing cavity pumps. This is also valid when a standard stator is being used.



4 Rotor

In wear- and corrosion-resistant designs, various materials on request.

5 5a Drive train and sleeve coupling

Removing the inspection cover from the FSIP® pump you gain access to a sleeve coupling which joins the rotor to the coupling rod. Here only one screw has to be removed to split both elements from each other.

6 Shaft sealing

Standard for the FSIP concept is a MG 1 single acting mechanical seal in cartridge design, which can be easily removed through the large inspection opening. Other options upon request.

7 xLC® stator adjustment unit

The xLC® unit is attached to the flange of the elastomer part of the stator and can compress or stretch it. In the case of wear the elastomer part of the stator can be compressed to restore the pretension between the rotor and stator ensuring an efficient sealing line.

NEMO® Industrial Pumps

NEMO® progressing cavity pumps are used in all sectors of industries to convey almost all types of media continuously, smoothly, with low pulsation and dosing in proportion to speed.

NEMO® BY

in block design



Performance

Flow rates up to 400 m³/h at pressures up to 24 bar.

Fields of application

Industrial applications in environmental technology and in the food, oil and chemical industries for fluid to viscous media with and without solids.

Features

Compact design with directly flanged drive. Its low investment, operating and maintenance costs really make it stand out. Four rotor/stator geometries for optimum performance with every kind of application.

NEMO® SY

with bearing housing and drive shaft



Performance

Flow rates up to 500 m³/h at pressures up to 48 bar (standard) or up to 240 bar (special applications).

Fields of application

Industrial applications in environmental technology and in the food, oil and chemical industries for fluid to viscous media with and without solids.

Features

Design with bearing housing and two-part shaft allows all types of drive to be used universally and makes servicing the rotating parts simple and fast. Four rotor/stator geometries for optimum performance with every kind of application.

NEMO® Progressing Cavity Pump in FSIP® design

FSIP.ready, FSIP.advanced and FSIP.pro

Technique

The FSIP® design is fully compatible to the existing BY and SY series. The concept consists of three stages, FSIP.ready, FSIP.advanced and FSIP.pro, which are designed to upgrade already installed pumps step by step, or which are available for new installations according to the individual needs of our customers.



FSIP.ready

Basic BY/SY pump including revised housing design with large inspection cover, with standard drive train and various seal arrangements.

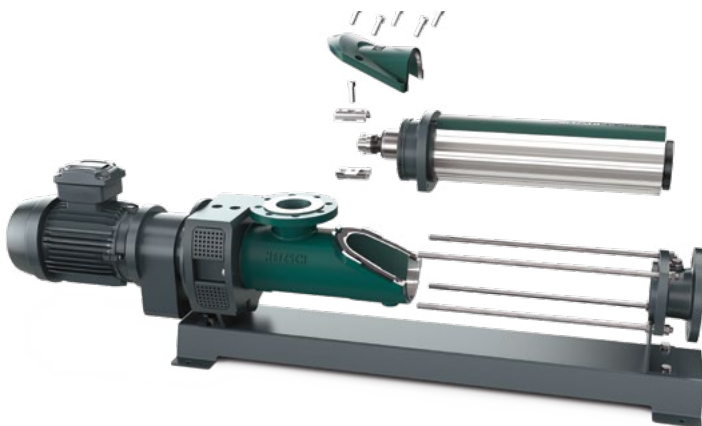

FSIP.advanced

BY/SY pump with new housing design and large inspection cover, split coupling rod and various seal arrangements. Rotor and stator can be serviced in place.

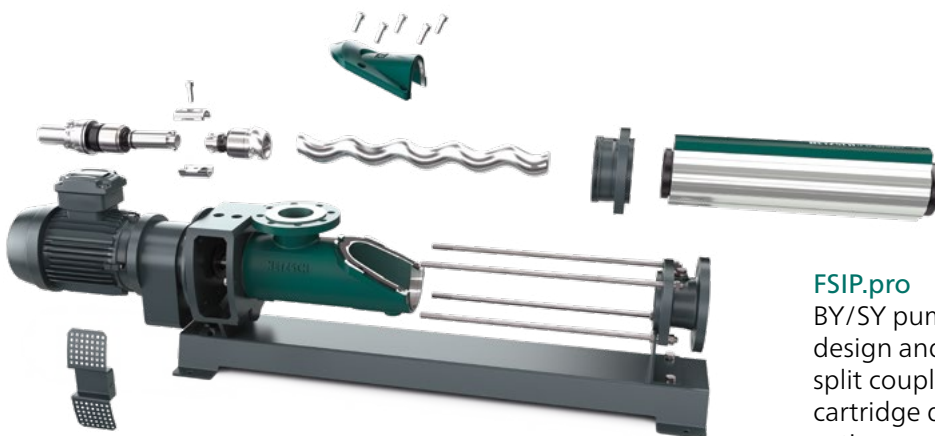

FSIP.pro

BY/SY pump with new housing design and large inspection cover, split coupling rod and 2 joints in cartridge design and MG 1 single acting mechanical seal for „Full Service in Place“.

NEMO® C.Pro®

Mini dosing pump in plastic design

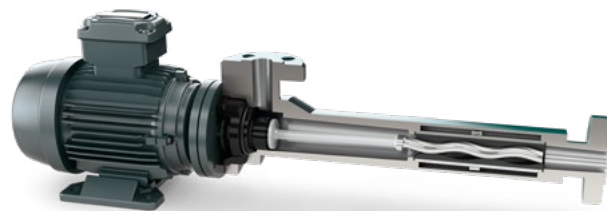

Performance

Flow rates from 0.5 up to 1,500 l/h at pressures up to 20 bar.

Fields of application

Industrial applications in environmental and chemical technology to convey and dose low- to moderately viscous media with and without solids.

Features

High dosing accuracy (deviation of < 1%). Compact design with directly flanged drive.

Further information

NEMO® C.Pro®
Brochure NPS · 313

NEMO® Hygienic Pumps

The pumps are designed and manufactured in accordance with hygienic guidelines, are CIP/SIP-capable and comply with the US 3-A Sanitary Standards. Two rotor/stator geometries are available to ensure optimum performance*.

These pumps are suited for hygienic applications in the foodstuff, pharmaceutical, cosmetic and biotechnology industries for low and highly viscous media with and without solids.

*excluding NEMO® Mini BH

NEMO® BH

Hygienic pump

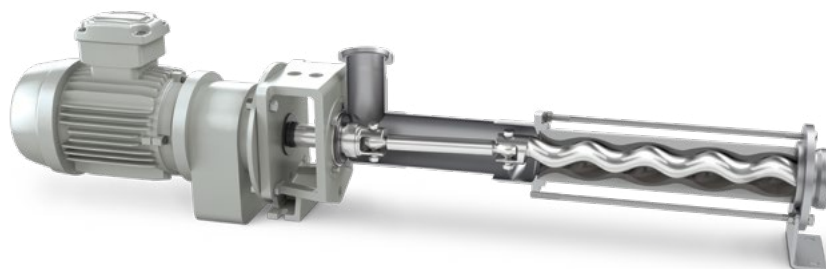

Performance

Flow rates up to 140 m³/h at pressures up to 24 bar.

Features

Compact design with directly flanged drive. Its low investment, operating and maintenance costs really make it stand out.

NEMO® BH

Hygienic Plus Pumpe with heating jacket

Performance

Flow rates up to 40 m³/h at pressures up to 12 bar.

Features

This pump is suitable for all hygienic applications in the foodstuff, pharmaceutical, cosmetic and biotechnology industries, especially for viscous media which have to be heated or cooled. The pump operates reliably and guarantees your process because the specially designed mechanical seals are arranged with no dead spaces, the housing and stator are heated, the products are conveyed smoothly and it can be cleaned to standard. It can also be taken apart easily for maintenance thanks to quick-fit connections. It is available with various rotor/stator geometries and has open hygienic pin joints, exposed housing seals, mixing elements on the coupling rod and a heating jacket over the entire length of the stator and pump housing. All surfaces that come into contact with the product are polished. This prevents medium deposits forming and facilitates cleaning.

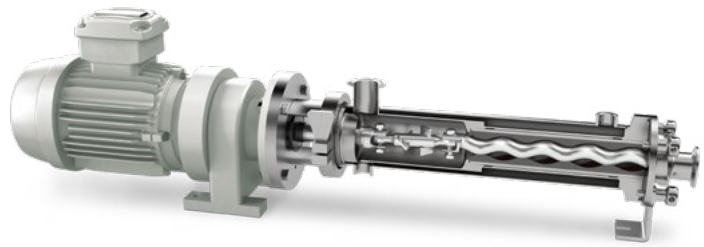

NEMO® MINI BH

Hygienic Mini Plus Pump

Performance

Flow rates from 0.1 up to 500 l/h
at pressures up to 36 bar.

Features

The flexible rod is free of dead space and is wear- and maintenance-free so that it can be used even with highly sensitive and abrasive products. High dosing accuracy (deviation of < 1%). Compact design with directly flanged drive gives you low investment, operating and maintenance costs.

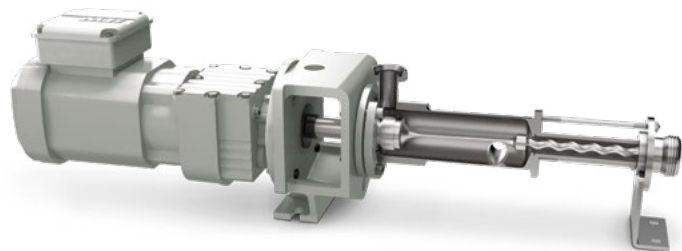

NEMO® SH

Hygienic Plus Pump



Performance

Flow rates up to 140 m³/h at pressures up to 24 bar.

Features

The flexible rod is free of dead space and is wear- and maintenance-free so that it can be used even with highly sensitive and abrasive products. The design with bearing housing and drive shaft means it can be used with all types of drives.

NEMO® SA

Aseptic pump



Performance

Flow rates up to 140 m³/h at pressures up to 24 bar.

Features

The flexible rod is free of dead space and is wear- and maintenance-free so that it can be used even with highly sensitive and abrasive products. The pump housing has a reduced diameter and a product inlet displaced towards the shaft sealing (outlet in vertical installation). The pump chamber is therefore completely free of dead space and the flow of the product through the pump is also optimised. The cleaning ports are arranged tangentially and pressure port eccentrically for residue-free self-emptying. All sealing points are designed for steam or sterile condensate and the pipe work is installed ready for use to prevent contamination from the environment. As standard, the stator is supplied with reduced elastomer wall thickness for use at varying product temperatures and with a stator protector to prevent dry running and overheating. The design with bearing housing and drive shaft means it can be used with all types of drives.

Further information

Business Field
Food & Pharmaceutical
Brochure NPS · 308

NEMO® Hopper Pumps

We provide you NEMO® progressing cavity pumps in diverse designs and materials, designed according to the location of use. Low viscosity and also abrasive sludge is reliably conveyed using our pumps with flanged connections.

For media with a high dry material content, such as de-watered sludge are available either for different designs of the NEMO® hopperpumps with screw conveyors or also with our aBP Module® to prevent bridging.

* Technical notes: the hopper dimensions can be adjusted to suit the specific application.

NEMO® BO/BS

in block design with directly flanged drive or as NEMO® SO/SS with bearing housing and drive shaft



Performance

Flow rates up to 200 m³/h at pressures up to 24 bar.

Fields of application

Industrial applications in environmental technology, the food industry and the chemical industry for viscous to non-free flowing media with and without solids.

Features

Housing with rectangular/quadratic feed hopper and coupling rod with conveying screw with compression chamber for improved product feeding into the conveying elements.

NEMO® B.Max®

in block design with directly flanged drive or
with bearing housing and drive shaft

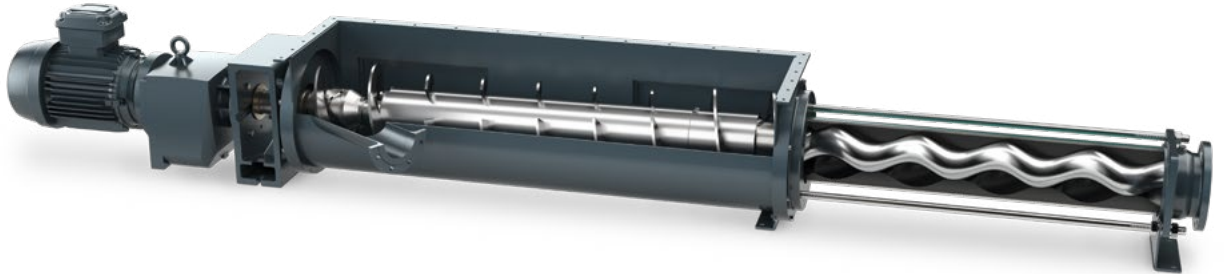

Performance

Flow rates up to 70 m³/h at pressures up to 48 bar.

Fields of application

Industrial applications in biogas and environmental technology for viscous to non-free flowing media with and without solids.

Features

Housing with large, rectangular feed hopper, coupling rod with patented, horizontally positioned conveying screw for optimum product feeding into the conveying elements. The additional, hydrodynamically designed flushing stud installed on the hopper housing ensures the substrates are fed and mixed optimally into the biomass.

Further information

Pulp Feeding
Brochure NPS · 061

NEMO® BF optional with aBP-Module®

in block design with directly flanged drive or NEMO® SF with bearing housing and drive shaft

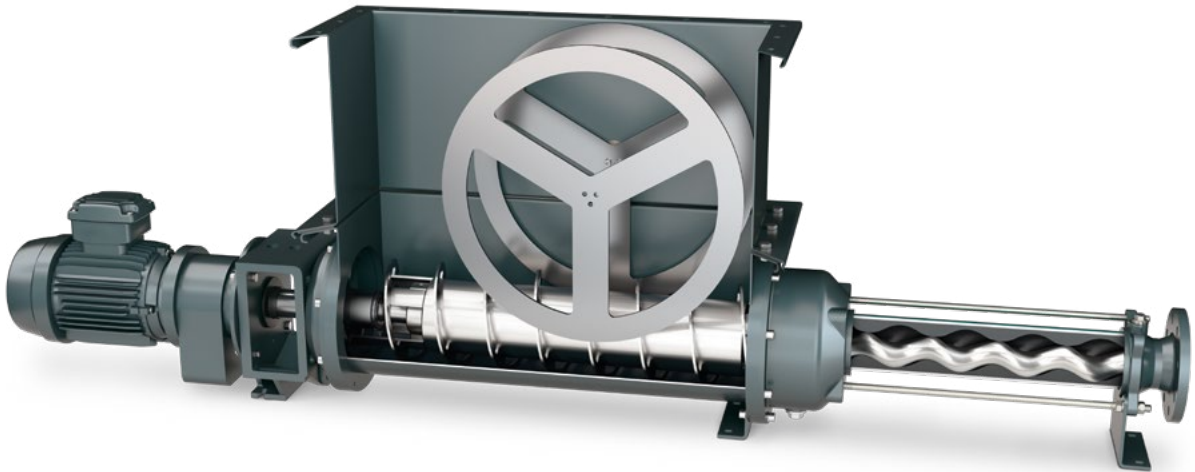

Performance

Flow rates up to 200 m³/h at pressures up to 48 bar.

NEMO® BF/SF with aBP-Module® available from size NM045 to NM090.

Fields of application

Industrial applications in environmental technology, the food industry and the chemical industry for highly viscous, compacted and crumbly media. For media that tend to bridge, the pump is fitted with the optional aBP-Module®.

Features

Housing with enlarged, rectangular feed hopper and with removable, cone-shaped compression chamber, coupling rod with patented, horizontally positioned conveying screw for optimum product feeding into the conveying elements.

Further information

aBP-Module®
Brochure NPS · 070

NEMO[®] Immersible Pumps

NEMO[®] Immersible Pumps are used to empty barrels, containers, tanks, sedimentation tanks, pits etc. and where space is restricted, there is a risk of cavitation or there is very low NPSH. The pumps are also used to empty containers holding materials that are hazardous to water or the environment for which standard emptying via a flange on the bottom of the container is not permitted.

NEMO[®] Immersible Pump BT

with suspension bracket

This pump is used to empty open barrels and containers. It is fitted with a clamp to be suspended from a crane. Immersion depth up to 3 m.

Performance

Flow rates up to 140 m³/h at pressures up to 24 bar. Depending on the specific application, various models/immersion variants are available. The immersion depth is adapted specifically to the application.

Features

Compact design with directly flanged drive. Four rotor/stator geometries for optimum performance with every kind of application. Immersion depths up to 10m. The immersion tube length can be modified by extending the pump housing, adding a suction pipe or by a combination of the two.



NEMO® Immersible Pump BT

with integral mounting plate

Depending on pump size, speed and immersion depth up to 10 m, an additional support guide is available to secure the pump to the bottom or to the wall near the bottom. Removal of the pump from a full tank is possible because the guide units are self-centering and secure the pump suction without fixings. In the variant with discharge connection below the mounting position the discharge connection of the pump is below the tank lid. The product is either piped to the outside vertically through the lid via a 90 ° elbow or horizontally through the tank wall. This minimises the dead space in the pump housing thus reducing the overall height of the pump above the tank lid.

Performance

Flow rates up to 140 m³/h at pressures up to 24 bar. Depending on the specific application, various models/immersion variants are available. The immersion depth is adapted specifically to the application.

Features

Compact design with directly flanged drive. Four rotor/stator geometries for optimum performance with every kind of application. Immersion depths up to 10m. The immersion tube length can be modified by extending the pump housing, adding a suction pipe or by a combination of the two.

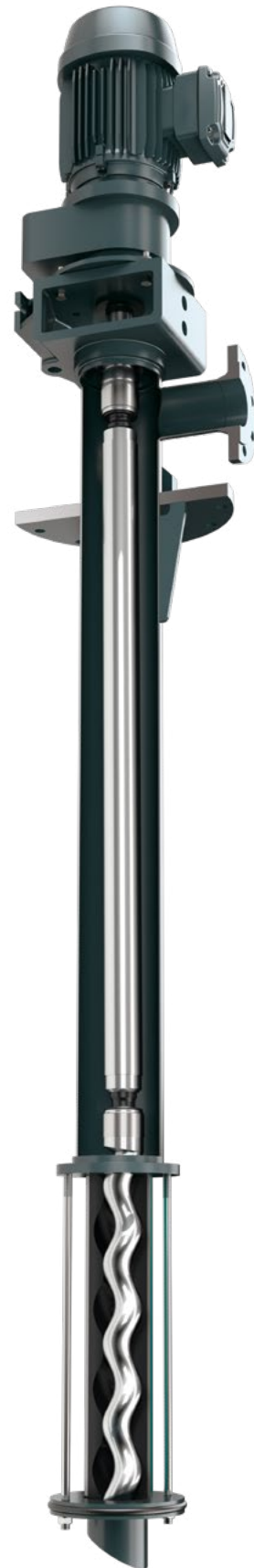

Operating method and conveying principle in NEMO PUMPS® with different rotor/stator geometries

Modular system

NEMO® Pumps belong to the group of rotary positive displacement pumps. The two conveying elements are the rotor and the fixed stator, in which the rotor eccentrically turns.

As all four pump geometries have the same outer dimensions. We have a modular design where – apart from rotor and stator – all other components are identical. When a change in flow rate or pressure is required, installed NEMO® Pumps can be adapted to the new operating conditions by simply changing rotor and stator.



S Geometry

- Very smooth pumping
- Compact dimensions despite large number of stages
- Large rotor inlet cross-sections
- Low flow velocity/NPSH
- Pumps compacted products
- Pumps large solid particles

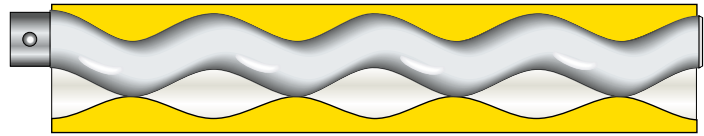
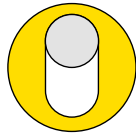

- 1/2 lobe
- Double stage
- Flow rate: 100%
- Differential pressure: 12 bar

L Geometry

- Good volumetric efficiency/long service life thanks to long seal line between rotor and stator
- Compact dimensions with high flow rates



- 1/2 lobe
- Single stage
- Flow rate: 200%
- Differential pressure: 6 bar

D Geometry

- Very compact dimensions despite high pressures and flow rates
- Almost pulsation-free pumping
- High dosing accuracy



- 2/3 lobe
- Double stage
- Flow rate: 150%
- Differential pressure: 12 bar

P Geometry

- Compact dimensions in conjunction with very high flow rates
- Almost pulsation-free pumping
- High dosing accuracy
- Good volumetric efficiency/long service life thanks to long seal line between rotor and stator



- 2/3 lobe
- Single stage
- Flow rate: 300%
- Differential pressure: 6 bar

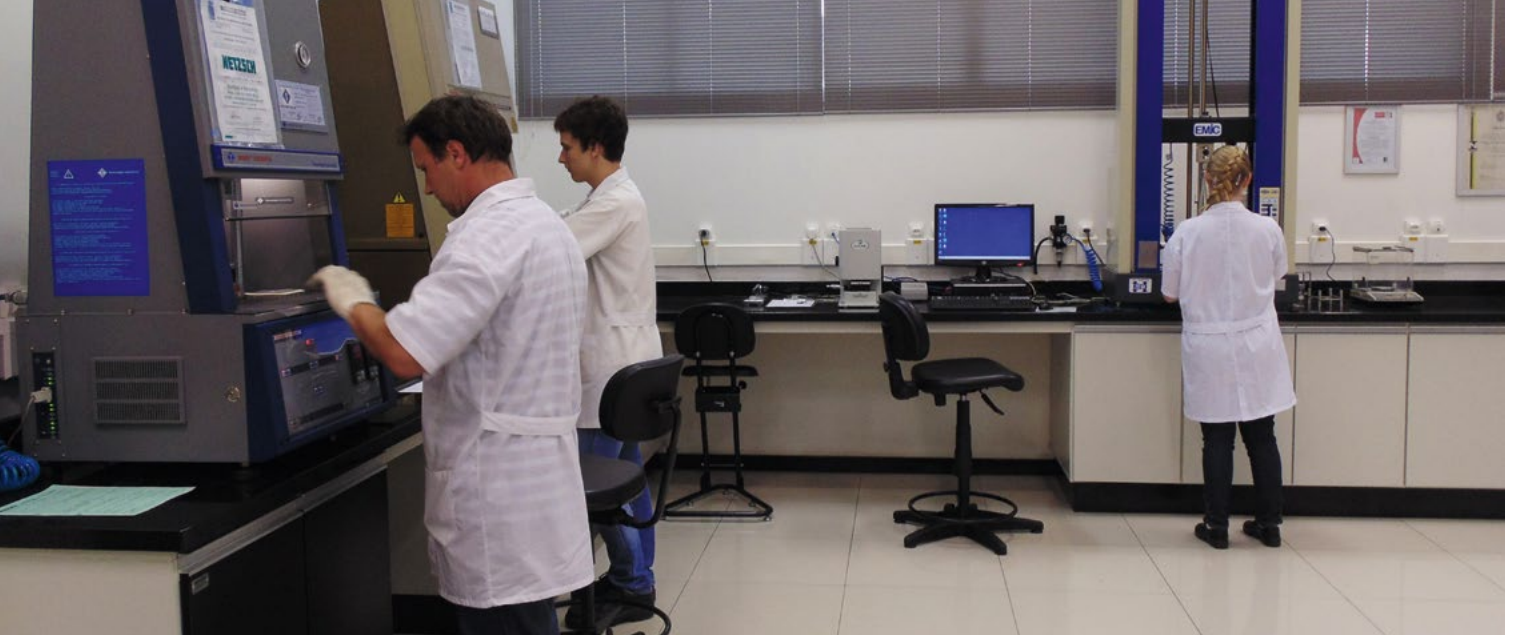

Testing properties and quality

NEMOLAST®

elastomer quality developed,
continuously tested and
optimised at NETZSCH



Developing new blends



Manufacturing blends

Development

Elastomer research & development is in-house at NETZSCH. At its in-house laboratory and in close collaboration with selected materials suppliers established over many years, NETZSCH develops and tests elastomer blends and optimises them for the specific requirements of customers.

We therefore offer each customer the optimum quality of elastomer for the media to be conveyed in terms of abrasion resistance, temperature range, dynamic load and chemical resistance – something other suppliers cannot offer. Only using original NETZSCH spare parts guarantees our pumps remain reliable.

Production

60 years of experience in a wide range of industries and processes and 40 years of experience developing and manufacturing elastomers for NEMO® pumps led up to the development of complex bonded parts made of glass fibre, metal and elastomer for the casing liners of our new generation of TORNADO® T2 rotary lobe pumps.

To meet the constantly growing demand for our pumps and the associated demand for spare parts, NETZSCH invested in a new 4000 m² production hall in Waldkraiburg to produce elastomer parts using the latest production methods and the latest product standards. Alongside five extruder sets to manufacture conventional tube stators, injection moulding machines and presses were also acquired to manufacture iFD-stators®, lobes and casing liners for rotary lobe pumps.

Specific requirements in oil production and transfer

This applies in particular to the difficult operating conditions in oil production. NETZSCH stators stand out with their long service life, leading to a significant reduction in operating costs.

Both for elastomer development as well as for optimal material selection the specific bore hole and fluid conditions have to be considered. NETZSCH pumps are used as multiphase pumps, which means that gas-oil-water mixtures and various solids are conveyed simultaneously or alternately.

Therefore, we have developed special elastomer mixtures, for conveying these phases in changing and variable concentrations. Additional challenges to the material are the fluctuating and sometimes very high temperatures and the high differential pressure up to 300 bar between the suction and pressure side. Very aggressive gases (such as H₂S and CO₂) or oils (with high aromatic content) can also be present.



Extruder with stator for oil production



Press with casing liners for TORNADO® T2



Injection moulding machine for iFD-stators®

	NEMOLAST® – stator qualities for industrial applications				
Material description/ NEMOLAST® Code	11	31	43	46*2)	61T
Colour	black	black	white	black	black
Base polymer	Natural rubber/ butadiene rubber (NR/BR)	Chlorinated polyethylene (CM)	Ethylene propylene diene rubber (EPDM)	Ethylene propylene diene rubber (EPDM)	Hydrogenated acrylonitrile butadiene rubber (HNBR)
Ageing resistance	0	++	+	+	++
Ozone resistance	–	++	+	++	++
Petrol resistance	--	--	--	--	0
Oil and fat resistance	--	–	--	--	++
Acid resistance	0	++	0	+	0
Alkali resistance	0	++	0	+	0
Hot water	0	+	+	+	0
Min. operating temperature	-20	-10	-20	-25	-5
Max. operating temperature	+90	+110	+100	+130	+140
Abrasion resistance mm ³	<40	<90	<320	<130	<40
Abrasion resistance	++	++	0	+	++
Hardness range (shore)	64 ± 5	73 ± 5	70 ± 5	70 ± 5	73 ± 5
FDA	no	no	no	yes	no
Nitrosamine-free	no	no	no	yes	no

NEMOLAST® stator qualities for oil production and transfer

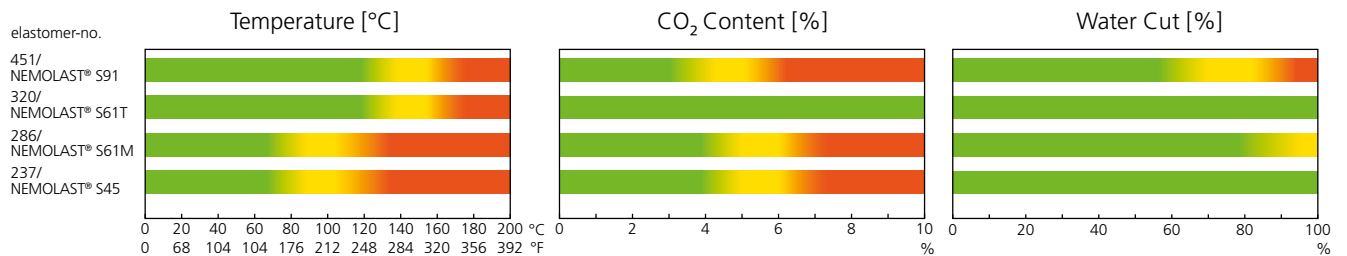

					Solid Stators	
62L* ²⁾	65L* ¹⁾	66L	85	91* ²⁾	teflon	cast iron** ³⁾
black	black	black	opaque	black	white	grey
Acrylonitrile butadiene rubber (NBR)	Acrylonitrile butadiene rubber (NBR)	Acrylonitrile butadiene rubber (NBR)	Silicone rubber (SI)	Fluororubber (FKM FPM)	Polytetrafluoroethylene	Grey cast iron
0	0	0	+	++	++	For neutral media
-	-	-	+	++	++	
0	0	0	--	++	++	
+	+	+	+	++	++	
0	0	0	--	++	++	
0	0	0	+	++	++	
0	0	0	+	++	++	
-5	-5	-5	-40	-5	-20	-20
+100	+100	+100	+150	+160* ²⁾ /+200	+160	+200
<60	<70	<130	<60	<90	-	-
++	++	+	++	+	-	-
73 ± 5	70 ± 5	68 ± 5	65 ± 5	73 ± 5	-	-
no	yes	yes	yes	no	yes	-
yes	yes	yes	yes	yes	-	-

*¹⁾ only for TORNADO® T2 rotary lobe pumps
*²⁾ also for TORNADO® T2 rotary lobe pumps
*³⁾ different solid stator materials on request

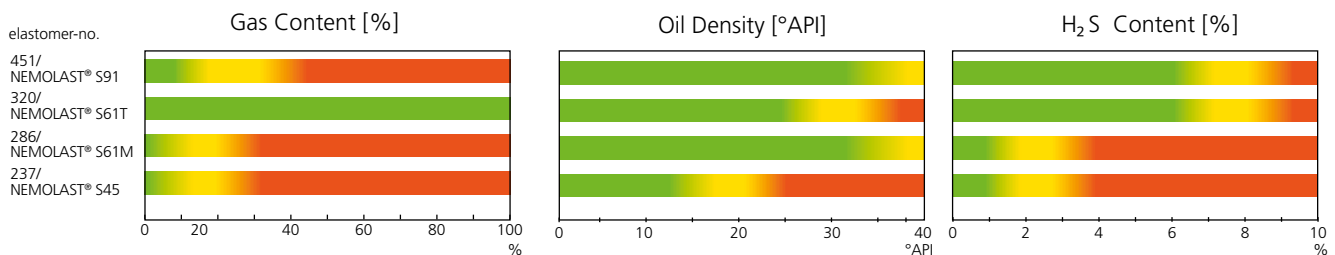

Please take into consideration that the given material limits are a guideline.
The final selection has to be based on a detailed analysis (e.g. swelling test).

■ recommended range
■ caution range
■ not recommended

Having the right joint in your NEMO® pump has a decisive impact on operational reliability and life-cycle costs. The optimum joint is selected on the basis of the application, the operating conditions and the conveyed media. To achieve the optimum performance of a NEMO® pump, joints at NETZSCH also be further developed and adapted to the individual conditions.

The right NEMO® joint

FOR EVERY APPLICATION

B Universal Pin Joint

The NEMO® universal pin joint is the standard joint for NEMO® industrial pumps thanks to its simple design and outstanding degree of reliability. The joint has a very long service life, as it is oil-filled and sealed using a NEMO® SM® seal. The joint can also be used without a seal at extremely high temperatures and flow rates where elastomers are not suitable. The joint, has just a small number of components and can therefore be easily dismantled for maintenance.

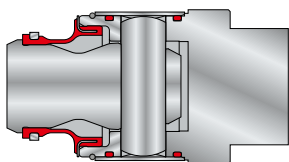

V Pin Joint

The NEMO® V pin joint functions in the same way as the B pin joint, but has a longer service life under tough operating conditions thanks to hardened bushings, which are fitted into boreholes in the coupling rod and the rotor/drive shaft head and can be replaced easily during maintenance.

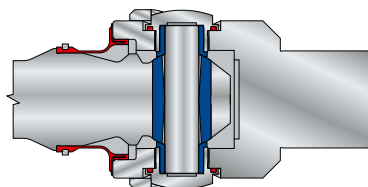

H Hygienic Pin Joint

This open, patented pin joint has been developed specifically for use in NEMO® hygienic pumps. The joint has no crevices or dead space and is polished, so is easy to clean. The hygienic pin joint meets the requirements of the US 3-A Sanitary Standards.

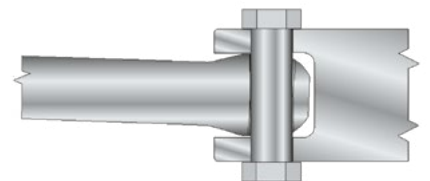

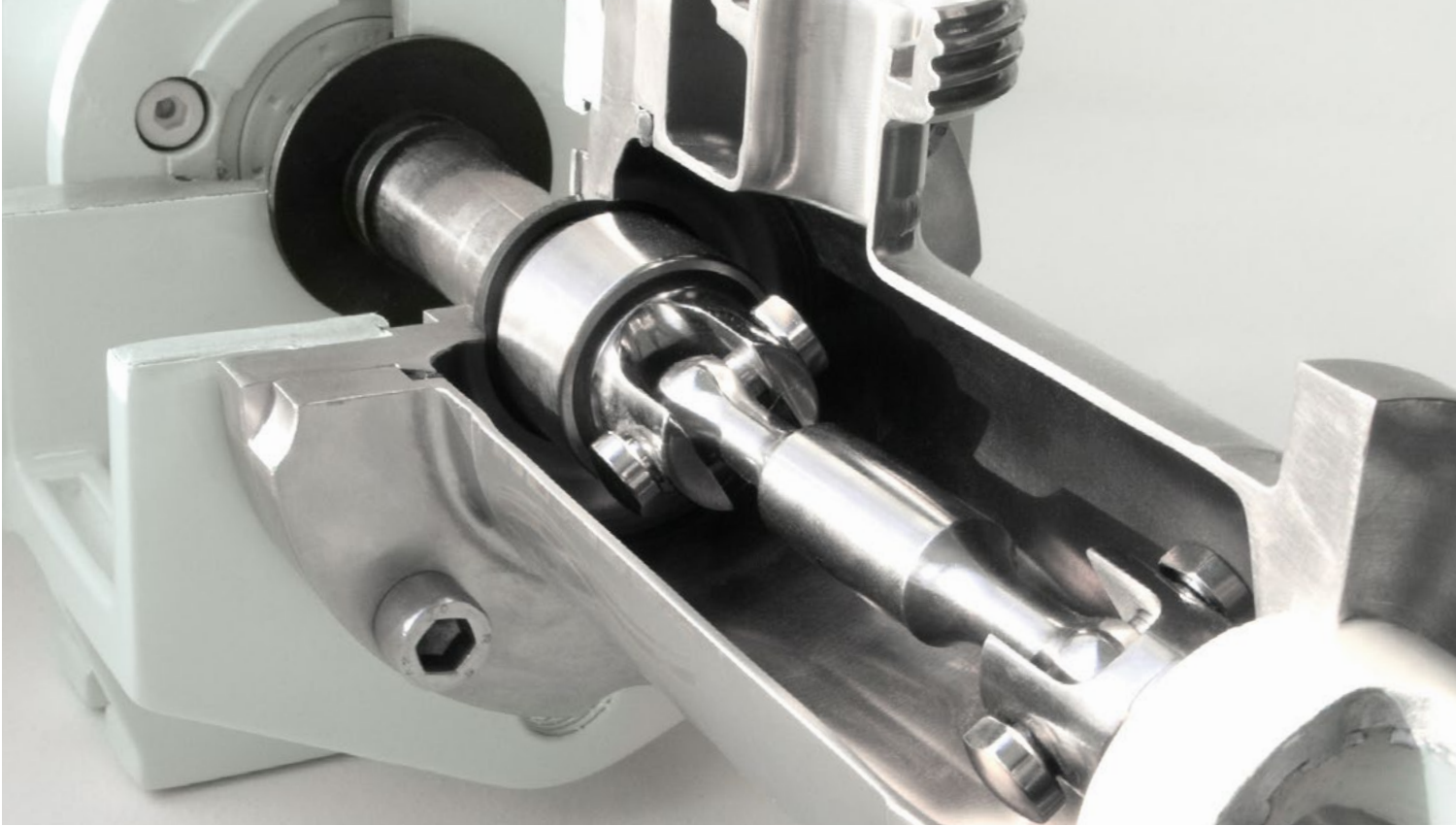

Flextec Flexible Rod

This flexible rod is wear- and maintenance-free, because no parts move against each other as in other joint types. It also does not require lubricants or seals, so that it can be used at the extremely high ambient pressures and temperatures. As it is free of crevices and dead space, the flexible rod is also used to convey highly sensitive products in aseptic conditions. The flexible rod meets the requirements of the US 3-A Sanitary Standards.

K Joint

The patented K joint was designed for highly demanding industrial applications. It is kinematically designed so that the torque and axial loads are shared by separate elements within the joint. The joint is oil lubricated and sealed hermetically by two joint seals that are resistant to/compatible with the lubricant and the pumped product. Filling the space between the two joint seals additionally with oil means that the joint can be used at ambient pressures of up to 12 bar.

Z Double Seal Pivot Joint

For large flows and/or pressures (from bearing block size NM125Y upward), NEMO® industrial pumps are equipped with kinematic precision cartridge type double seal pivot joints, which have been designed with extremely high permanent loads, torques and axial forces in mind. The joint is oil lubricated and sealed hermetically by two joint seals that are resistant to/compatible with the lubricant and the pumped product.

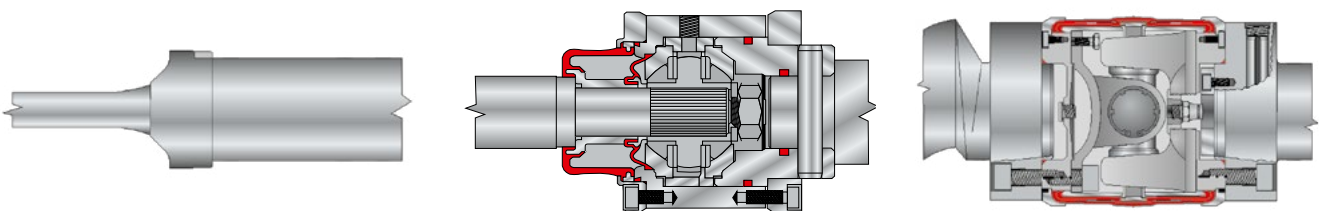

FROM A TO Z

Accessories & Service

Accessories to increase the operational safety of both pump and plant to prevent downtimes

Process monitoring

Dry running protectors safeguard elastomer parts of the pump against thermal damage and protect the pump.

- Dry running protection (STPA2A, STP2D)
- Flow sensors for solid stators
- Speed monitoring device

Overpressure and underpressure protectors safeguard the pump and protect downstream aggregates and valves against overpressure and underpressure.

- Diaphragm Pressure Gauge
- Pressure control device DTSL 3
- Multi-function pressure instrument
- By-pass line

Seal Support Systems

Additional flushing, quench or pressurised flushing systems that flush or close the seals with clean conveyed medium are often required to ensure shaft seals function correctly and reliably.

- Quench pot
- Permanent lubricator
- Pressurised flush for double mechanical seals

Tools and additional equipment

A large number of useful equipment is available to correctly maintain and smoothly operate your pumps.

- Gear joint filling unit
- Ring dosing nozzle
- Chemical anchor
- Stator removal tool

Protection Units and Trolleys

In all areas of production within the food, pharmaceutical and cosmetic industries, a range of optional parts are available to ensure uncompromising hygiene and to enable mobile use.

- Covers for drives
- Transport devices
- Machine feet - flexible, rigid

Further information

NETZSCH Customer Service
Brochure NPS · 400



NETZSCH Service

The benefit to you

Advice, service and quality are our strengths. Strict quality standards, test procedures and certification in accordance with DIN EN ISO 9001 guarantee that you receive the very highest quality without exception. To maintain the performance and quality of your pump, we continue to provide support after delivery in all aspects of your pump to ensure it operates reliably in your system. We have experience over 60 years with more than 500,000 installed pumps behind us.

Spare Parts and Service

In your area welltrained service partners are available for quick and economic service of the pumps at your premises. Here you will find your personal service partner on our website:

<https://pumps-systems.netzsch.com/en/consulting-technical-service>





The NETZSCH Group is an owner-managed, international technology company with headquarters in Germany. The Business Units Analyzing & Testing, Grinding & Dispersing and Pumps & Systems represent customized solutions at the highest level. More than 4.000 employees in 36 countries and a world-wide sales and service network ensure customer proximity and competent service.

Our performance standards are high. We promise our customers Proven Excellence – exceptional performance in everything we do, proven time and again since 1873.

The NETZSCH Business Unit Pumps & Systems offers with NEMO® progressing cavity pumps, TORNADO® rotary lobe pumps, NOTOS® multi screw pumps, PERIPRO peristaltic pumps, macerators/grinders, dosing technology and equipment custom built and challenging solutions for different applications on a global basis.

Proven Excellence.

BLUECOMPETENCE

Alliance Member

Partner der Nachhaltigkeitsinitiative
des Maschinen- und Anlagenbaus

NETZSCH Pumpen & Systeme GmbH
Geretsrieder Straße 1
84478 Waldkraiburg
Germany
Phone: +49 8638 63-0
info.nps@netzsch.com
www.pumps-systems.netzsch.com

NETZSCH®

www.netzsch.com