

**APACHE CANADA
LIMITED**

**HAMBURG 2-6
COMPRESSOR STATION**

SO# 99404

LSD: 02-06-097-11 W6M

SEPTEMBER, 2000

OPERATING MANUAL

VOLUME 4

**PROPAK COPY
PLEASE DO NOT REMOVE**

APACHE CANADA LIMITED

LSD: 02-06-097-11 W6M

2-6 Hamburg 1478 hp Compressor Package

Propak Systems Unit #99404

**Waukesha L7042GL / Dresser-Rand 6HOS-3
Operations and Maintenance Manual**

TABLE OF CONTENTS

(INDEXED IN ALPHABETICAL ORDER BY TAG NUMBER)

<u>SECTION</u>	<u>TITLE</u>
VOLUME 1	
1.	HAZARD WARNING
2.	PRODUCT AND SERVICE BULLITIN
3.	BASIS OF DESIGN
4.	DESIGN DESCRIPTION
5.	STANDARD WRITE-UPS: DESCRIPTION
6.	PROCESS
7.	EQUIPMENT
VOLUME 2	
7.	EQUIPMENT - CONTINUED
8.	INSTRUMENTATION
VOLUME 3	
8.	INSTRUMENTATION - CONTINUED
VOLUME 4	
9.	ELECTRICAL
10.	DRAWINGS:
	- MECHANICAL FLOWSHEET
	- GENERAL ASSEMBLY

TABLE OF CONTENTS

- 1 ALLEN BRADLEY MODULAR CHASSIS
- 2 ALLEN BRADLEY POWER SUPPLIES
- 3 ALLEN BRADLEY SLC 5/03/04/05 MODULAR PROCESSORS

- 4 ALLEN BRADLEY 1746 DISCRETE I/O MODULES
- 5 ALLEN BRADLEY 1746-NI8 ANALOG INPUT MODULES
- 6 ALLEN BRADLEY 1746 ANALOG I/O MODULES
- 7 ALLEN BRADLEY 1746-NT8 THERMOCOUPLE INPUT MODULES
- 8
- 9
- 10 TOTAL CONTROL QUICKPANEL JUNIOR



Discrete I/O Modules

(Catalog Number 1746 Series)

Installation Instructions

Input Module Catalog Numbers:

1746-IA4, -IA8, -IA16, -IB8, -IB16, -IC16, -IG16, -IH16, -IM4,
-IM8, -IM16, -IN16, -ITB16, -ITV16, -IV8, -IV16

Output Module Catalog Numbers:

1746-OA8, -OA16, -OAP12, -OB8, -OB16, -OB16E, -OBP8,
-OBP16, -OG16, -OV8, -OV16, -OVP16, -OW4, -OW8, -OW16,
-OX8

Combination Input/Output Module Catalog Numbers:

1746-IO4, -IO8, -IO12

Important User Information

Because of the variety of uses for the products described in this publication, those responsible for the application and use of this control equipment must satisfy themselves that all necessary steps have been taken to assure that each application and use meets all performance and safety requirements, including any applicable laws, regulations, codes and standards.

The illustrations, charts, sample programs and layout examples shown in this guide are intended solely for purposes of example. Since there are many variables and requirements associated with any particular installation, Allen-Bradley does not assume responsibility or liability (to include intellectual property liability) for actual use based upon the examples shown in this publication.

Allen-Bradley publication SGI-1.1, *Safety Guidelines for the Application, Installation, and Maintenance of Solid-State Control* (available from your local Allen-Bradley office), describes some important differences between solid-state equipment and electromechanical devices that should be taken into consideration when applying products such as those described in this publication.

Reproduction of the contents of this copyrighted publication, in whole or in part, without written permission of Allen-Bradley Company, Inc., is prohibited.

Throughout these installation instructions we use notes to make you aware of safety considerations:



ATTENTION: Identifies information about practices or circumstances that can lead to personal injury or death, property damage or economic loss.

Attention statements help you to:

- identify a hazard
- avoid the hazard
- recognize the consequences

Important: Identifies information that is critical for successful application and understanding of the product.

Table of Contents

Overview	5
Installation	5
Specifications	6
General I/O	6
Heat Dissipation	7
Input Modules – ac	9
Input Modules – dc	11
Output Modules – ac	16
Output Modules – dc	17
Relay Contact Output Modules	24
Relay Contact Ratings	25
Input/Output Combination Modules	26
Octal Label Kit Installation (for PLC Processors Only)	27
Applying the Octal Filter Label	27
Applying the Octal Door Label	27
Removable Terminal Blocks	28
Fuse Protection and Blown Fuse Diagnostics	29
Fuse Protection (1746-OBP16 and 1746-OVP16)	29
Fuse Protection (1746-OAP12)	29
Blown Fuse Diagnostics	29
Processor Operation in Case of Blown Fuse – Processor Continues	32
Processor Operation in Case of Blown Fuse – Processor Faults	33
Recovery From Blown Fuse/Processor Fault/Processor Shutdown	35
Replacement Fuse Recommendations	35
Fuse Replacement Procedure	36
Electronically Protected Modules (1746-OB16E)	37
Short Circuit/Overload Current Diagnostics	37
Recovery From Channel Shutdown	37
Wiring Diagrams	38
Labeling for SLC/PLC Systems	38
Input Modules – ac	39
Input Modules – dc	41
Output Modules – ac	43
Output Modules – dc	45
Relay Contact Output Modules	48
Input/Output Combination Modules	50

Overview

In addition to providing the module's electrical specifications, this document tells you how to:

- install the module into a chassis
- wire the module's terminal block
- install the Octal Filter Label

Installation

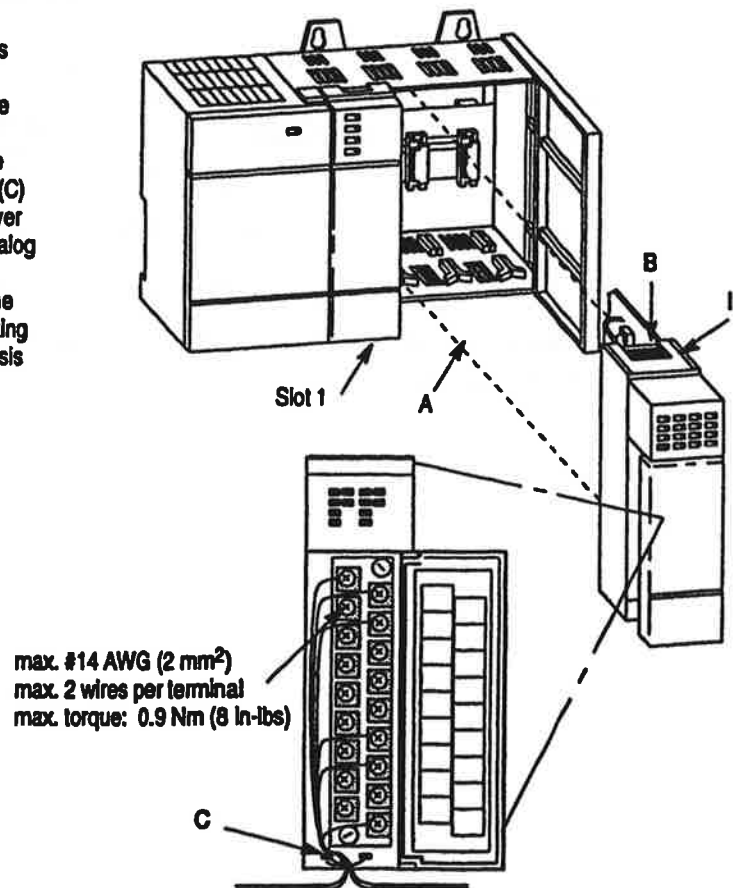


ATTENTION: Never install, remove, or wire modules with power applied to chassis.

Important: The first slot of the chassis is reserved for the processor or the 1747-ASB module.

1. Disconnect power.
2. Align circuit board of module with chassis card guide. (A)
3. Slide the module into the chassis until the bottom tabs lock into place. (B)
4. Route the wires down and away from the module, securing them with the wire tie. (C)
5. To keep the chassis free from debris, cover all unused slots with Card Slot Filler, Catalog Number 1746-N2.

To remove the module, press and hold the module release located on each self-locking tab, and slide the module out of the chassis slot. (D)



Specifications

General I/O

Table 1
Specifications for All Discrete Modules

Operating Temperature	0°C to 60°C (32°F to 140°F) ^①
Storage Temperature	-40°C to 85°C (-40°F to 185°F)
Operating Humidity	5% to 95% (noncondensing)
Noise Immunity	NEMA standard ICS 2-230
Vibration (Operating)	Displacement 0.015 in peak at 5-57 Hz Acceleration 2.5Gs at 57-2000 Hz
Shock (Operating)	30Gs (all modules except relay contact) 10Gs (relay contact modules, -OW, -OX, I/O combo)
Isolation ^②	1500V
Agency Certification	<ul style="list-style-type: none"> • UL listed • CSA certified • CE compliant for all applicable directives when product or packaging is marked
Hazardous Environment Class ^③	Class I, Division 2 Hazardous Environment UL-A196, CSA

① Exceptions are indicated with certain modules.

② Electro-optical isolation between I/O terminals and control logic.

③ Some modules are classified Class I, Division 2 by CSA only as shown in the specification table for the respective module.

Specifications

Heat Dissipation

The following tables contain values for the heat dissipated by each I/O module. Use them to calculate the total amount of heat dissipated by your SLC 500™ control system. For details on how to calculate total heat dissipation, refer to the *SLC 500 Modular and/or Fixed Hardware Style Installation and Operation Manual* (Publication Number 1747-6.2 or 1747-6.21). Please note the following definitions:

- *Watts per Point* – the heat dissipation that can occur in each field wiring point when energized at nominal voltage.
- *Minimum Watts* – the amount of heat dissipation that can occur when there is no field power present.
- *Total Watts* – the watts per point plus the minimum watts (with all points energized).

Table 2
Input Module Heat Dissipation

Catalog Numbers	Watts per Point	Minimum Watts	Total Watts
1747-IA4	0.27	0.175	1.30
1746-IA8	0.27	0.250	2.40
1746-IA16	0.27	0.425	4.80
1746-IB8	0.20	0.250	1.90
1746-IB16	0.20	0.425	3.60
1746-IC16	0.22	0.425	3.95
1746-IG16	0.02	0.700	1.00
1746-IH16	0.32	0.217	5.17
1746-IM4	0.35	0.175	1.60
1746-IM8	0.35	0.250	3.10
1746-IM16	0.35	0.425	6.00
1746-IN16	0.35	0.425	6.00
1746-ITB16	0.20	0.425	3.60
1746-ITV16	0.20	0.425	3.60
1746-IV8	0.20	0.250	1.90
1746-IV16	0.20	0.425	3.60

Specifications

Heat Dissipation (continued)

Table 3
Output Module Heat Dissipation

Catalog Numbers	Watts per Point	Minimum Watts	Total Watts
1746-OA8	1.000	0.925	9.00
1746-OA16	0.462	1.850	9.30
1746-OAP12	1.000	1.850	10.85
1746-OB8	0.775	0.675	6.90
1746-OB16	0.388	1.400	7.60
1746-OB16E	0.150	0.675	3.07
1746-OBP8	0.300	0.675	3.08
1746-OBP16	0.310	1.250	6.26
1746-OG16	0.033	0.900	1.50
1746-OV8	0.775	0.675	6.90
1746-OV16	0.388	1.400	7.60
1746-OVP16	0.310	1.250	6.26
1746-OW4	0.133	1.310	1.90
1746-OW8	0.138	2.590	3.70
1746-OW16	0.033	5.170	5.70
1746-OX8	0.825	2.590	8.60

Table 4
Combination Input/Output Module Heat Dissipation

Catalog Numbers	Watts per Point	Minimum Watts	Total Watts
1746-IO4	0.27 per input point 0.133 per output point	0.75	1.60
1746-IO8	0.27 per input point 0.133 per output point	1.38	3.00
1746-IO12	0.27 per input point 0.133 per output point	2.13	4.60

Specifications

Input Modules – ac

Table 5
Specifications for Discrete Input Modules 1746-IA4, -IA8, and -IA16

Description:		Specification: 1746-		
		IA4	IA8	IA16 ^①
Voltage Category		100/120V ac Signal Input		
Number of Inputs		4	8	16
Points per Common		4	8	16
Operating Voltage		85–132V ac at 47–63 Hz		
Backplane Current Consumption	5V	0.035A	0.050A	0.085A
	24V	0.0A		
Signal Delay (max.)		on = 35 ms off = 45 ms		
Off State Voltage (max.)		30V ac		
Off State Current (max.)		2 mA		
Nominal Input Current at 120V ac		12 mA		
Inrush Current (max.) ^②		0.8A		
Inrush Current Time Duration (max.)		0.5 ms		

① Removable Terminal Block.

② An ac input device must be compatible with SLC 500 input circuit inrush current. A current limiting resistor can be used to limit inrush current; however, the operating characteristics of the ac input circuit will be affected.

Specifications

Input Modules – ac (continued)

Table 6
Specifications for Input Modules 1746-IM4, -IM8, and -IM16

Description:		Specification: 1746-		
		IM4	IM8	IM16 ^①
Voltage Category		200/240V ac Signal Input		
Number of Inputs		4	8	16
Points per Common		4	8	16
Operating Voltage		170–265V ac at 47–63 Hz		
Backplane Current Consumption	5V	0.035A	0.050A	0.085A
	24V	0.0A		
Signal Delay (max.)		on = 35 ms off = 45 ms		
Off State Voltage (max.)		50V ac		
Off State Current (max.)		2 mA		
Nominal Input Current at 240V ac		12 mA		
Inrush Current (max.) ^②		1.6A		
Inrush Current Time Duration (max.)		0.5 ms		

① Removable Terminal Block.

② An ac input device must be compatible with SLC 500 input circuit inrush current. A current limiting resistor can be used to limit inrush current; however, the operating characteristics of the ac input circuit will be affected.

Specifications

Input Modules – dc

Table 7
Specifications for Input Modules 1746-IB8, -IB16, -ITB16, and -IC16

Description:		Specification: 1746-			
		IB8	IB16 ^①	ITB16 ^①	IC16 ^{①③}
Voltage Category		24V dc Signal Input (sinking)			48V dc Signal Input (sinking)
Number of Inputs		8	16	16	16
Points per Common		8	16	16	16
Operating Voltage		10–30V dc (sinking)			30–60V dc at 55°C 30–55V dc at 60°C (sinking)
Backplane Current Consumption	5V	0.050A			
	24V	0.0A			
Signal Delay (max.)		on = 8 ms off = 8 ms	on = 8 ms off = 8 ms	on = 0.3 ms off = 0.5 ms ^②	on = 4 ms off = 4 ms
Off State Voltage (max.)		5.0V dc			10.0V dc
Off State Current (max.)		1 mA	1 mA	1.5 mA	1.5 mA
Nominal Input Current		8 mA @24 V dc			4.1 mA @48 V dc

① Removable Terminal Block.

② Typical signal delay for these modules: ON = 0.1 ms, OFF = 0.25 ms at 24V dc.

③ Use ID Code 0509 when configuring your system with programming software or the HHT.

Specifications

Input Modules – dc (continued)

Table 8
Specifications for Input Modules 1746-IV8, -IV16, and -ITV16

Description:		Specification: 1746-		
		IV8	IV16 ^①	ITV16 ^①
Voltage Category		24V dc Signal Input (sourcing)		
Number of Inputs		8	16	16
Points per Common		8	16	16
Operating Voltage		10–30V dc (sourcing)		
Backplane Current Consumption	5V	0.050A	0.085A	0.085A
	24V	0.0A		
Signal Delay (max.)		on = 8 ms off = 8 ms	on = 8 ms off = 8 ms	on = 0.3 ms off = 0.5 ms ^②
Off State Voltage (max.)		5.0V dc		
Off State Current (max.)		1 mA	1 mA	1.5 mA
Nominal Input Current at 24V dc		8 mA		

① Removable Terminal Block.

② Typical signal delay for these modules: ON = 0.1 ms, OFF = 0.25 ms at 24V dc.

Specifications

Input Modules – dc (continued)

Table 9
Specifications for Input Modules 1746-IG16

Description:		1746-IG16 ^①
Voltage Category		5V dc TTL Signal Input (sourcing)
Number of Inputs		16
Points per Common		16
Operating Voltage		4.5–5.5V dc (sourcing) 50mV peak to peak ripple (max.)
Backplane Current Consumption	5V	0.140A
	24V	0.0A
Signal Delay (max.)		on = 0.25 ms off = 0.50 ms
Off State Voltage (max.)		2.0V dc ^②
Off State Current (max.)		4.1 mA
Nominal Input Current at 5V dc		3.7 mA

^① Removable Terminal Block.

^② TTL inputs are inverted (–0.2 to +0.8V dc = low voltage = True = ON). Use a NOT instruction in your ladder program to convert to traditional True = High logic.

Specifications

Input Modules – dc (continued)

Table 10
Specifications for Input Modules 1746-IN16

Description:		1746-IN16 ^①
Voltage Category		24V ac/dc Signal Input
Number of Inputs		16
Points per Common		16
Operating Voltage	dc	10–30V dc (sinking)
	ac	10–30V ac
Backplane Current Consumption	5V	0.085A
	24V	0.0A
Signal Delay (max.)	dc	on = 15 ms off = 15 ms
	ac	on = 25 ms off = 25 ms
Off State Voltage (max.)	dc	3.0V dc
	ac	3.0V ac
Off State Current (max.)	dc	1 mA
	ac	1 mA
Nominal Input Current	dc	8 mA at 24V dc
	ac	8 mA at 24V ac
Inrush Current (max.)		0.02A (ac only)

^① Removable Terminal Block.

Specifications

Input Modules – dc (continued)

Table 11
Specifications for Input Modules 1746-IH16

Description:		1746-IH16 ^{①②③}	
Voltage Category		125V dc Signal Input (sinking)	
Number of Inputs		16	
Points per Common		16	
Operating Voltage		Range: 90–146V dc	Max. Points ON Simultaneously: 16 @ 146V dc and 30°C 12 @ 146V dc and 50°C 14 @ 132V dc and 55°C 16 @ 125V dc and 60°C
Backplane Current Consumption	5V	0.085A	
	24V	0.0A	
Signal Delay (max.)		on = 9 ms off = 9 ms	
Off State Voltage (max.)		20.0V dc	
Off State Current (max.)		0.8 mA	
Nominal Input Current		2.15 mA @ 125V dc	
		2.25 mA @ 132V dc	

① Removable Terminal Block.

② Use ID code 0507 when configuring your system with programming software or the HHT.

③ If the input module is connected in parallel with an inductive load, use surge suppression across the load to protect the input module from damage caused by reverse voltage. Refer to the SLC 500 Modular Hardware Style Installation and Operation Manual, publication 1747-6.2, for more information on surge suppression.

Specifications

Output Modules – ac

Table 12
Specifications for Output Modules 1746-OA8, -OA16, -OAP12

Description:		Specification: 1746-		
		OA8	OA16 ^①	OAP12 ^{①②③④}
Voltage Category		120/240V ac Signal Input		
Number of Outputs		8	16	12
Points per Common		4	8	6
Operating Voltage		85–265V ac at 47–63 Hz		
Backplane Current Consumption	5V	0.185A	0.370A	0.370A
	24V	0.0A		
Max. Signal Delay, Resistive Load. ^⑤		on = 1 ms / off = 11.0 ms		
Off State Leakage (max.) ^⑥		2 mA		
Load Current (min.)		10 mA		
Continuous Current per Point ^⑦		1.0A at 30°C 0.50A at 60°C	0.50A at 30°C 0.25A at 60°C	2.0A at 30°C 1.25A at 55°C 1.0A at 60°C
Continuous Current per Module (max.)		8.0A at 30°C 4.0A at 60°C	8.0A at 30°C 4.0A at 60°C	9.0A at 30°C 6.0A at 60°C
On State Voltage Drop (max.)		1.50V at 1.0A	1.50V at 0.50A	1.2V at 2.0A
Surge Current per Point ^⑧ (max.)		10.0A for 25 ms	10.0A for 25 ms	17.0A for 25 ms ^⑨

① Removable Terminal Block.

② A fused common and blown fuse LED are provided on this module. See pages 29 through 36 for blown fuse diagnostics and replacement.

③ Use I.D. code 2803 when configuring your system with programming software or the HHT.

④ Certified for Class I, Division 2 hazardous location by CSA.

⑤ Triac outputs turn on at any point in the ac line cycle and turn off at ac line zero cross.

⑥ To limit the effects of leakage current thru solid state outputs, a loading resistor can be connected in parallel with your load. For 120V ac operation use a 15K Ω , 2W resistor. For 240V ac operation use a 15K Ω , 5W resistor.

⑦ *Recommended surge suppression:* For triac outputs when switching 120V ac inductive loads use Harris Metal-Oxide Varistor, model number V220MA2A. Refer to the SLC 500 Modular Hardware Style Installation and Operation Manual, publication 1747-8.2, for more information on surge suppression.

⑧ Repeatability is once every 1s at 30°C. Repeatability is once every 2s at 60°C.

⑨ Surge current = 35A per common for 10 ms.

Specifications

Output Modules – dc

Table 13
Specifications for Output Modules 1746-OB8, -OB16, and OB16E

Description:		Specification: 1746-		
		OB8	OB16 ^①	OB16E ^{①②}
Number of Outputs		8	16	16
Points per Common		8	16	16
Voltage Category		24V dc Signal Output		
Operating Voltage (V dc)		10–50 (source)		10–30 (source)
Backplane Current Consumption	5V	0.135A	0.280A	0.135A
	24V	0.0A		
Signal Delay (max.). Resistive Load.		on = 0.1 ms off = 1.0 ms	on = 0.1 ms off = 1.0 ms	on = 1.0 ms off = 1.0 ms
Off State Leakage (max.) ^③		1 mA		
Load Current (min.)		1 mA		
Continuous Current per Point ^④		1.0A at 30°C 0.50A at 60°C	0.50A at 30°C 0.25A at 60°C	1.0A at 30°C 0.50A at 60°C
Continuous Current per Module		8.0A at 30°C 4.0A at 60°C	8.0A at 30°C 4.0A at 60°C	8.0A at 0° to 60°C
On State Voltage Drop (max.)		1.2V at 1.0A	1.2V at 0.50A	1.0V at 0.50A
Surge Current per Point ^⑤		3.0A for 10 ms	3.0A for 10 ms	2.0A for 10 ms ^⑥

① Removable Terminal Block.

② Use the following I.D. code when configuring your system with programming software or the HHT:
 1746-OB16E = 2920.

③ To limit the effects of leakage current thru solid state outputs, a loading resistor can be connected in parallel with your load. For transistor outputs, 24V dc operation, use a 5.6K ohm, 1/2 watt resistor.

④ *Recommended surge suppression:* For transistor outputs when switching 24V dc inductive loads use a 1N4004 diode reverse-wired across the load. Refer to the SLC 500 Modular Hardware Style Installation and Operation Manual, publication 1747-6.2, for more information on surge suppression.

Continued on following page.

- ⑤ Repeatability is once every 1s at 30°C. Repeatability is once every 2s at 60°C.
- ⑥ Surge current = 32A per module for 10 ms.



ATTENTION: A transient pulse occurs in transistor outputs when the external dc supply voltage is applied to the output common terminals (e.g., via the master control relay). This can occur regardless of the processor having power or not. For most applications, the energy of this pulse is not sufficient to energize the load. Refer to the *SLC 500 Modular and/or Fixed Hardware Style Installation and Operation Manual* (Publication Number 1747-6.2 or 1747-6.21) for more information on transient pulses and guidelines to reduce inadvertent processor operation.

Specifications

Output Modules – dc (continued)

Table 14
Specifications for Output Modules 1746-OBP8, and -OBP16

Description:		Specification: 1746-	
		OBP8 ^{①④⑤}	OBP16 ^{①③⑤⑥}
Number of Outputs		8	16
Points per Common		4	16
Voltage Category		24V dc Signal Output	
Operating Voltage (V dc)		20.4–26.4 (source)	
Backplane Current Consumption	5V	0.135A	0.250A
	24V	0.0A	
Signal Delay (max.). Resistive Load.		on = 1.0 ms off = 2.0 ms	on = 0.1 ms ^② off = 1.0 ms
Off State Leakage (max.) ^⑦		1 mA	
Load Current (min.)		1 mA	
Continuous Current per Point ^⑧		2.0A at 60°C	1.5A at 30°C ^⑨ 1.0A at 60°C
Continuous Current per Module		8.0A at 60°C	6.4A at 0° to 60°C
On State Voltage Drop (max.)		1.0V at 2.0A	1.0V at 1.0A
Surge Current per Point ^⑩		4.0A for 10 ms	4.0A for 10 ms ^⑪

① Removable Terminal Block.

② This module provides fast OFF delay for inductive loads. Comparative OFF delay times for 1746-OB8/-OV8 and 1746-OBP16/-OVP16, when switching Bulletin 100-B110 (24 watts sealed) contactor, are:
 1746-OB8/-OV8 OFF delay = 152 ms; 1746-OBP16/-OVP16 OFF delay = 47 ms

③ A fused common and blown fuse LED are provided on this module. See pages 29 through 36 for fuse blown diagnostics and replacement.

④ An external fuse can be used to protect this module from short circuits. Recommended fuse is SANO MQ4-3.15A, 5x20 mm.

⑤ Use the following I.D. code when configuring your system with programming software or the HHT:
 1746-OBP8 = 2721 and 1746-OBP16 = 2921.

Continued on following page.

- ⑥ Certified for Class I, Division 2 hazardous location by CSA.
- ⑦ To limit the effects of leakage current thru solid state outputs, a loading resistor can be connected in parallel with your load. For transistor outputs, 24V dc operation, use a 5.6K ohm, 1/2 watt resistor.
- ⑧ **Recommended surge suppression:** For transistor outputs when switching 24V dc inductive loads use a 1N4004 diode reverse-wired across the load (also see footnote 9). Refer to the SLC 500 Modular Hardware Style Installation and Operation Manual, publication 1747-6.2, for more information on surge suppression.
- ⑨ Fast off delay for inductive loads is accomplished with surge suppressors on the 1746-OBP16 and -OVP16 modules. A suppressor at the load is not needed unless another contact is connected in series. If this is the case, a 1N4004 diode should be reverse wired across the load. This defeats the fast turn off feature.
- ⑩ Repeatability is once every 1s at 30°C. Repeatability is once every 2s at 60°C.
- ⑪ Surge current = 32A per module for 10 ms.



ATTENTION: A transient pulse occurs in transistor outputs when the external dc supply voltage is applied to the output common terminals (e.g., via the master control relay). This can occur regardless of the processor having power or not. For most applications, the energy of this pulse is not sufficient to energize the load. Refer to the *SLC 500 Modular and/or Fixed Hardware Style Installation and Operation Manual* (Publication Number 1747-6.2 or 1747-6.21) for more information on transient pulses and guidelines to reduce inadvertent processor operation.

Specifications

Output Modules – dc (continued)

Table 15
Specifications for Output Modules 1746-OV8, -OV16, -OVP16

Description:		Specification: 1746-		
		OV8	OV16 ^①	OVP16 ^{①③④⑤}
Number of Outputs		8	16	16
Points per Common		8	16	16
Voltage Category		24V dc Signal Output		
Operating Voltage (V dc)		10–50 (sink)		20.4–26.4 (sink)
Backplane Current Consumption	5V	0.135A	0.270A	0.250A
	24V	0.0A		
Signal Delay (max.). Resistive Load.		on = 0.1 ms off = 1.0 ms		on = 0.1 ms ^② off = 1.0 ms
Off State Leakage (max.) ^⑥		1 mA		
Load Current (min.)		1 mA		
Continuous Current per Point ^⑦		1.0A at 30°C 0.50A at 60°C	0.50A at 30°C 0.25A at 60°C	1.5A at 30°C ^⑧ 1.0A at 60°C
Continuous Current per Module		8.0A at 30°C 4.0A at 60°C		6.4A at 0° to 60°C
On State Voltage Drop (max.)		1.2V at 1.0A	1.2V at 0.5A	1.0V at 1.0A
Surge Current per Point ^⑨		3.0A for 10 ms		4.0A for 10 ms ^⑩

① Removable Terminal Block.

② This module provides fast OFF delay for inductive loads. Comparative OFF delay times for 1746-OB8/-OV8 and 1746-OBP16/-OVP16 when switching Bulletin 100-B110 (24W) contactor are: 1746-OB8/-OV8 OFF delay = 152 ms. 1746-OBP16/-OVP16 OFF delay = 47 ms.

③ A fused common and blown fuse LED are provided on this module. See pages 29 through 36 for blown fuse diagnostics and replacement.

④ Use the following I.D. code when configuring your system with programming software or the HHT:
1746-OVP16 = 2922.

⑤ Certified for Class I, Division 2 hazardous location by CSA.

Continued on following page.

-
- ⑥ To limit the effects of leakage current thru solid state outputs, a loading resistor can be connected in parallel with your load. For transistor outputs, 24V dc operation, use a 5.6K Ω , 1/2W resistor.
 - ⑦ *Recommended surge suppression:* For transistor outputs when switching 24V dc inductive loads use a 1N4004 diode reverse-wired across the load. (also see footnote 8.) Refer to the SLC 500 Modular Hardware Style Installation and Operation Manual, publication 1747-6.2, for more information on surge suppression.
 - ⑧ Fast off delay for inductive loads is accomplished with surge suppressors on the 1746-OBP16 and -OVP16 modules. A suppressor at the load is not needed unless another contact is connected in series. If this is the case, a 1N4004 diode should be reverse wired across the load. This defeats the fast turn off feature.
 - ⑨ Repeatability is once every 1s at 30°C. Repeatability is once every 2s at 60°C.
 - ⑩ Surge current = 32A per module for 10 ms.
-



ATTENTION: A transient pulse occurs in transistor outputs when the external dc supply voltage is applied to the output common terminals (e.g., via the master control relay). This can occur regardless of the processor having power or not. For most applications, the energy of this pulse is not sufficient to energize the load. Refer to the *SLC 500 Modular and/or Fixed Hardware Style Installation and Operation Manual* (Publication Number 1747-6.2 or 1747-6.21) for more information on transient pulses and guidelines to reduce inadvertent processor operation.

Specifications

Output Modules – dc (continued)

Table 16
Specifications for Output Modules 1746-OG16

Description:		Specification: 1746-OG16 ^①
Number of Outputs		16
Points per Common		16
Voltage Category		5V dc TTL Signal Input (sinking)
Operating Voltage		4.5–5.5V dc ^② 50mV peak to peak ripple (max.)
Backplane Current Consumption	5V	0.180A
	24V	0.0A
Signal Delay (max.). Resistive Load.		on=0.25 ms off=0.50 ms
Off State Leakage (max.)		0.1 mA
Load Current (min.)		0.15 mA
Continuous Current per Point		24 mA

① Removable Terminal Block.

② TTL outputs are inverted (0 to 0.4V dc = low voltage = True = ON). Use a NOT instruction in your ladder program to convert to traditional True = High logic.

Specifications

Relay Contact Output Modules

Table 17
Specifications for Output Modules 1746-OW4, -OW8, -OW16, -OX8

Description:		Specification: 1746-			
		OW4 ^①	OW8 ^①	OW16 ^{①②}	OX8 ^{①②}
Number of Outputs		4	8	16	8
Points per Common		4	4	8	Individually Isolated
Voltage Category		ac/dc Relay			
Operating Voltage	V dc	5-125			
	V ac	5-265			
Backplane Current Consumption	5V	0.045A	0.085A	0.170A	0.085A
	24V	0.045A	0.090A	0.180A	0.090A
Signal Delay (max.). Resistive Load.		on = 10.0 ms off = 10.0 ms			
Off State Leakage (max.)		0 mA			
Load Current (min.)		10mA at 5V dc			
Continuous Current per Point ^③		See relay contact rating tables (Table 18 and Table 19).			
Continuous Current per Module		8.0A ac 8.0A /Common	16.0A ac 8.0A /Common	16.0A ac 8.0A /Common	④

① Certified for Class I, Division 2 hazardous location by CSA.

② Removable Terminal Block.

③ *Recommended surge suppression:* For relay contact outputs consult the SLC 500 Installation and Operation Manual (Publication Number 1747-6.2). Connecting surge suppressors across your external inductive load will extend the life of SLC 500 relay contacts.

④ The continuous current per module must be limited so the module power does not exceed 1440 VA.

Specifications

Relay Contact Ratings

Table 18
Relay Contact Rating Table for Output Modules 1746-OW4, -OW8, -OW16

Voltages:		Amperes ^①		Amperes Continuous ^②	Volt-Amperes	
		Make	Break		Make	Break
Maximum Volts (ac)	120	15	1.5	2.5	1800	180
	240	7.5	0.75			
Maximum Volts (dc)	125	0.22 ^③		1.0	28	
	24	1.2 ^③		2.0	28	

Table 19
Relay Contact Rating Table for Output Module 1746-OX8

Voltages:		Amperes ^①		Amperes Continuous ^②	Volt-Amperes	
		Make	Break		Make	Break
Maximum Volts (ac)	120	30	3.0	5.0	3600	360
	240	15	1.5			
Maximum Volts (dc)	125	0.22 ^③		1.0	28	
	24	1.2 ^③		2.0	28	

① *Recommended surge suppression:* For relay contact outputs consult the SLC 500 Installation and Operation Manual (Publication Number 1747-6.2). Connecting surge suppressors across your external inductive load will extend the life of SLC 500 relay contacts.

② The continuous current per module must be limited so the module power does not exceed 1440 VA.

③ For dc voltage applications, the make/break ampere rating for relay contacts can be determined by dividing 28 VA by the applied dc voltage. For example, 28 VA ÷ 48V dc = 0.58A. For dc voltage applications less than 14V, the make/break ratings for relay contacts cannot exceed 2A.

Specifications

Input/Output Combination Modules

Table 20
Specifications for Combination Module 1746-IO4, -IO8, -IO12

Description:		Specifications: 1746-		
		IO4 ^{①②}	IO8 ^{①②}	IO12 ^{①③④}
Points per Module		2 inputs 2 outputs	4 inputs 4 outputs	6 inputs 6 outputs
Points per Common		2	4	6
Voltage Category (Inputs)		120V ac		
Operating Voltage (Inputs)		85-132V ac		
Voltage Category (Outputs)		100/120V ac Relay contact output		
Operating Voltage (Outputs)		5-265V ac 5-125V dc		
Backplane Current Consumption	5V	0.030A	0.060A	0.090A
	24V	0.025A	0.045A	0.070A

- ① Certified for Class I, Division 2 hazardous location by CSA.
- ② See specifications for Catalog Numbers 1746-IA4 and 1746-OW4. Continuous Current per 1746-IO4 Module is 4.0A. Continuous Current per 1746-IO8 Module is 8.0A.
- ③ Removable Terminal Block.
- ④ See specifications for Catalog Numbers 1746-IA16 and 1746-OW16. Continuous Current per 1746-IO12 Module is 8.0A.

Octal Label Kit Installation (for PLC Processors Only)

The octal label kit consists of an octal filter label and a door label. Use these octal labels to replace the decimal labels that are attached to the I/O modules. Octal label kit is included with the I/O modules and can also be obtained through your Allen-Bradley distributor.



ATTENTION: Do not touch or remove the terminal block when the SLC 500 system is powered. Contact with ac line potential may cause injury to personnel.

Applying the Octal Filter Label

1. Remove the octal filter label from its paper carrier.
2. Align the octal filter label numbers horizontally to the module color bar and over the decimal filter numbers.
3. Apply the octal label to the filter.
4. Press firmly to ensure proper adhesion of the label.

Applying the Octal Door Label

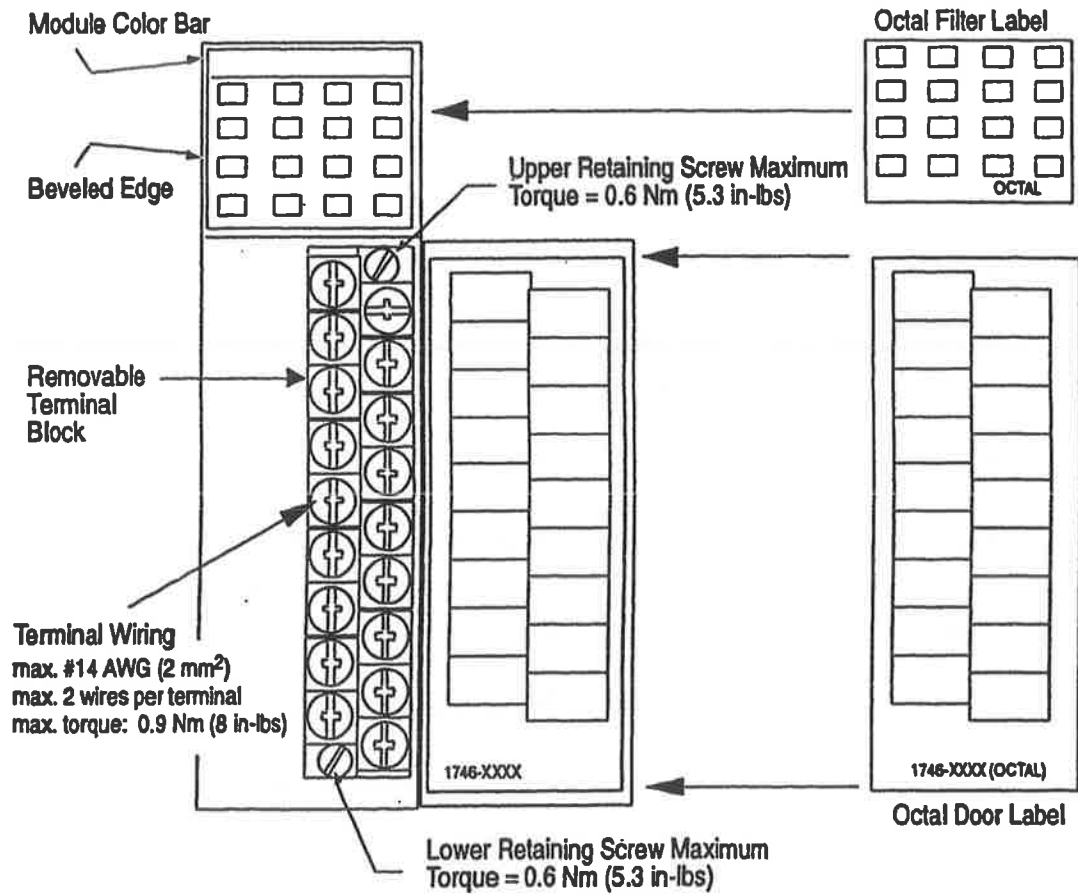
1. Remove the octal door label from its paper carrier.
2. Align the octal label directly over the decimal door label on the inside of the door.
3. Press firmly to ensure proper adhesion of the label.

Octal Label Kit Installation (for PLC Processors Only)

Removable Terminal Blocks

Colored terminal blocks are removable by loosening the upper and lower retaining screws. Black terminal blocks are not removable.

Figure 1
Installing Octal Labels



Fuse Protection and Blown Fuse Diagnostics

This section describes fusing characteristics for the following modules:

- Catalog 1746-OBP16
- Catalog 1746-OVP16
- Catalog 1746-OAP12

Fuse Protection (1746-OBP16 and 1746-OVP16)

The fuse on the 1746-OBP16 and 1746-OVP16 modules (shown on page 30) has been designed to provide short circuit protection for wiring only (16 AWG or larger) to external loads. In the event of a short circuit on an output channel, it is likely that the transistor associated with that channel will be damaged and the module should be replaced or a spare output channel used for the load. The fuse does not provide overload protection. In the event of an overload on an output channel, it is likely that the fuse will not blow and the transistor associated with that channel will be damaged. To provide overload protection for your application, user supplied fuses should be installed externally and properly sized to match your individual load characteristics.

Fuse Protection (1746-OAP12)

A fuse is provided on each common of the 1746-OAP12 module (shown on page 31) for a total of 2 fuses. The fuses are designed to protect the module from short circuit conditions. The fuse does not provide overload protection. In the event of an overload on an output channel, it is likely that the fuse will not blow and the output device associated with that channel will be damaged. To provide overload protection for your application, user supplied fuses should be installed externally. Recommended fuse for overload protection is SAN-O HT. Select the fuse rating according to your load. Do not use HT fuses rated higher than 2.0 amps.

Blown Fuse Diagnostics

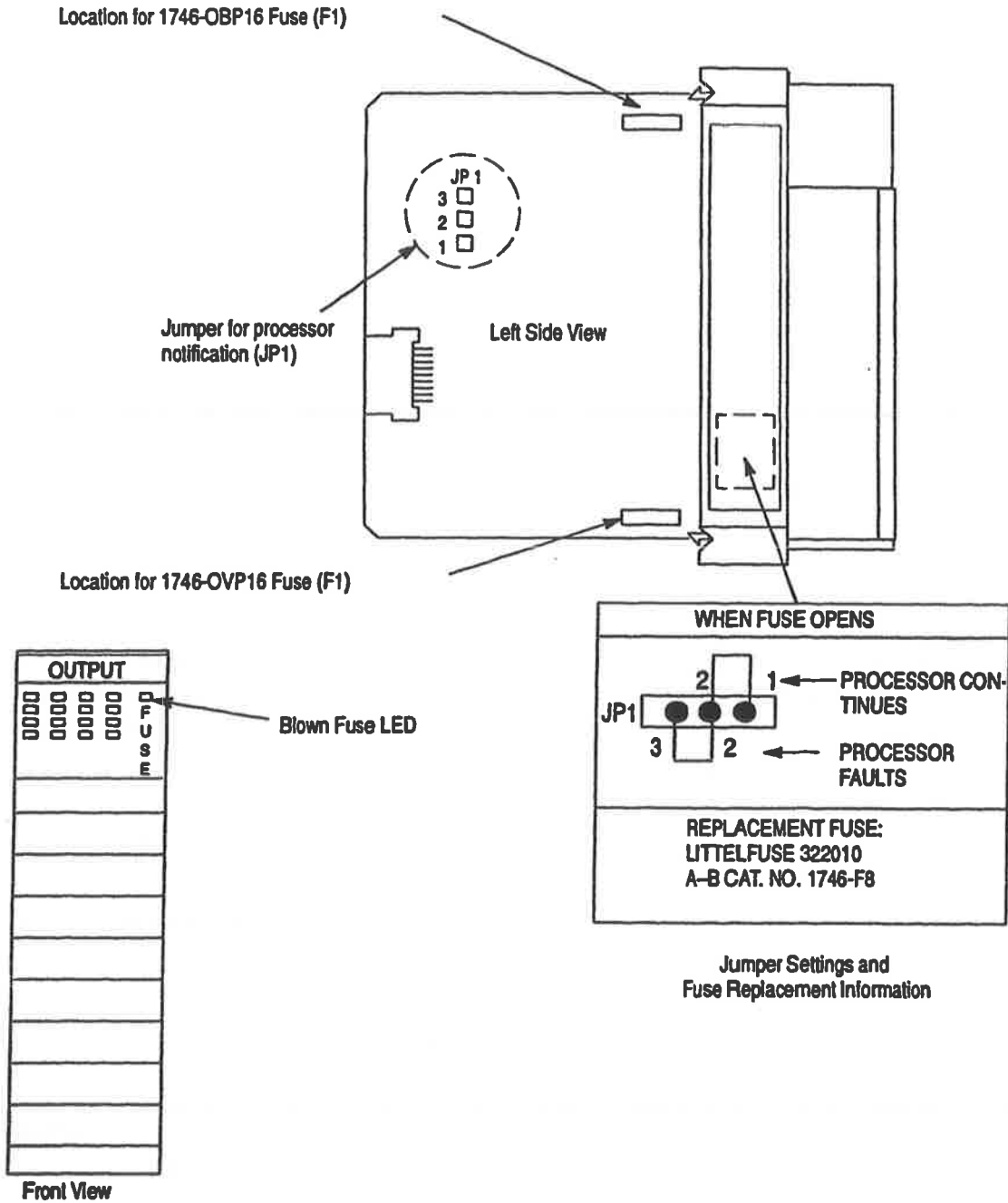
If the fuse blows on the 1746-OBP16, -OVP16 or -OAP12, the following occurs:

1. The blown fuse LED will illuminate provided power (5V dc via backplane and load power via external supply) is applied to the module.
2. A processor error will occur if JP1 connects pins 2 and 3. (See Figure 2 on page 30 and Figure 3 on page 31.)

Fuse Protection and Blown Fuse Diagnostics

Blown Fuse Diagnostics (continued)

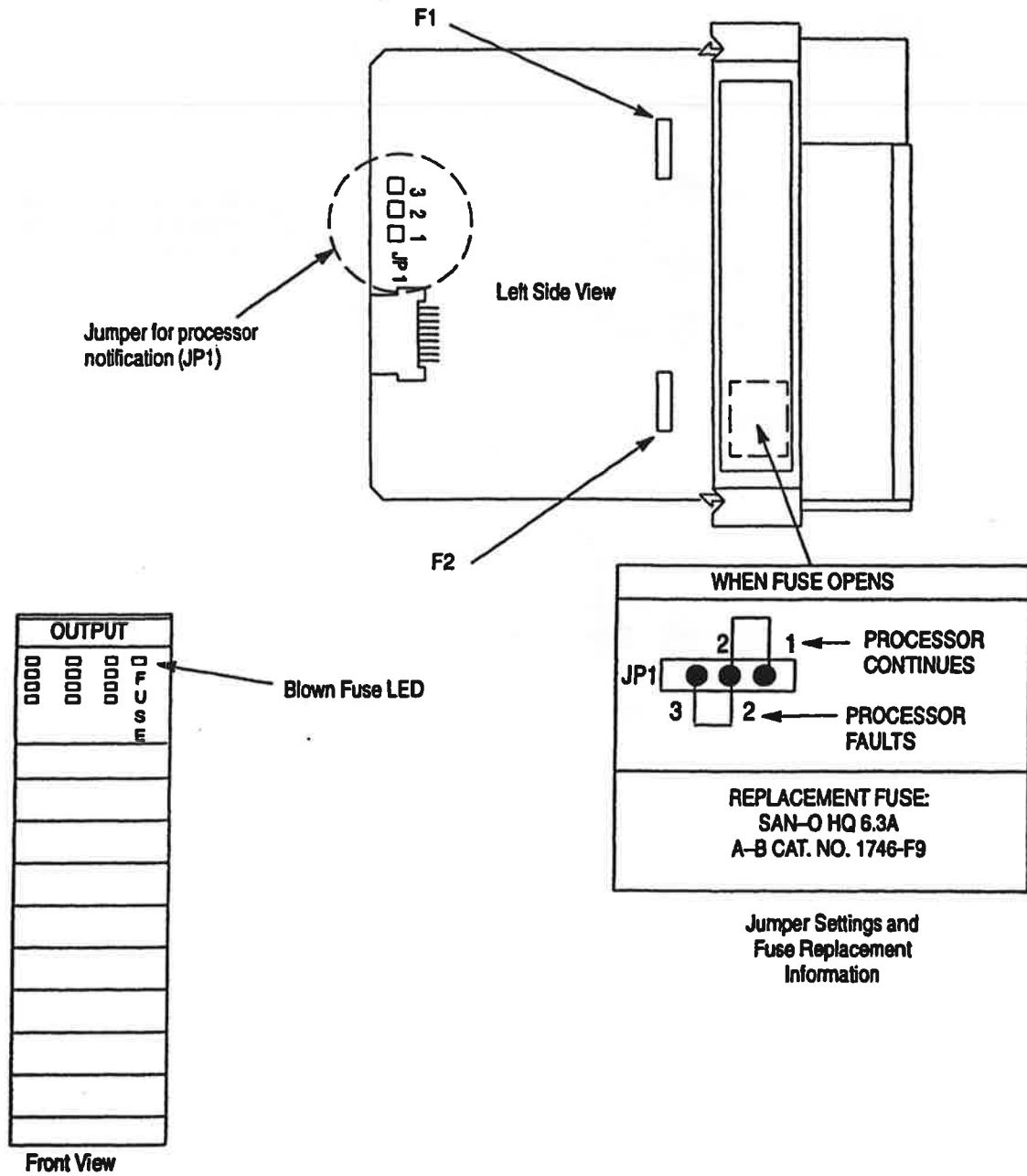
Figure 2
Location of Jumpers and Fuses for 1746-OBP16 and -OVP16



Fuse Protection and Blown Fuse Diagnostics

Blown Fuse Diagnostics (continued)

Figure 3
Location of Jumpers and Fuses for 1746-OAP12

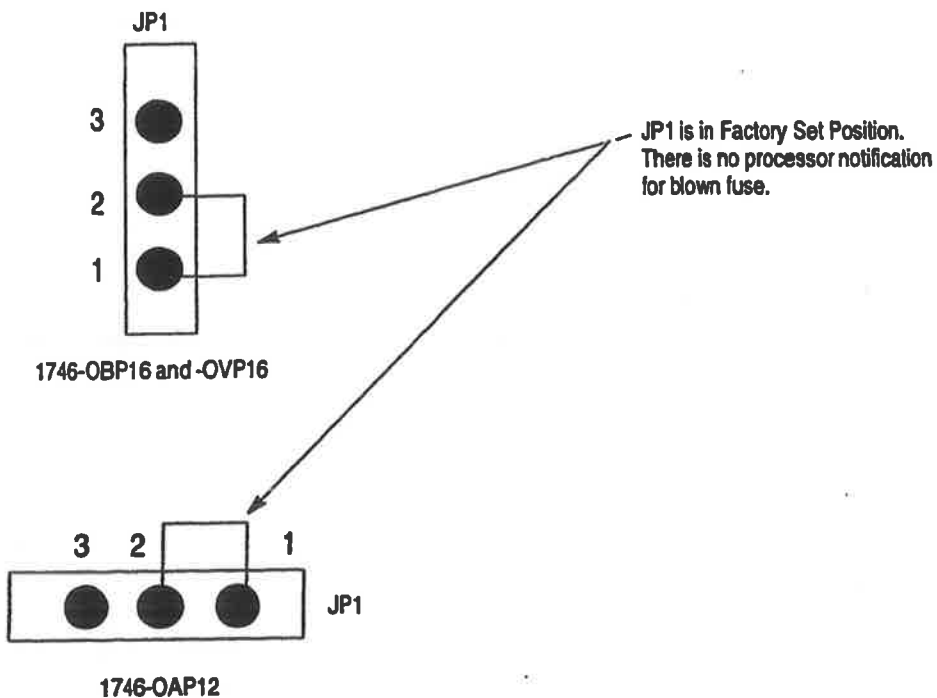


Fuse Protection and Blown Fuse Diagnostics

Processor Operation in Case of Blown Fuse – Processor Continues

The factory set position for JP1 is shown in Figure 4. For this JP1 configuration, the processor operation will continue if the module fuse blows.

Figure 4
JP1 Factory Set Position (No Processor Notification)



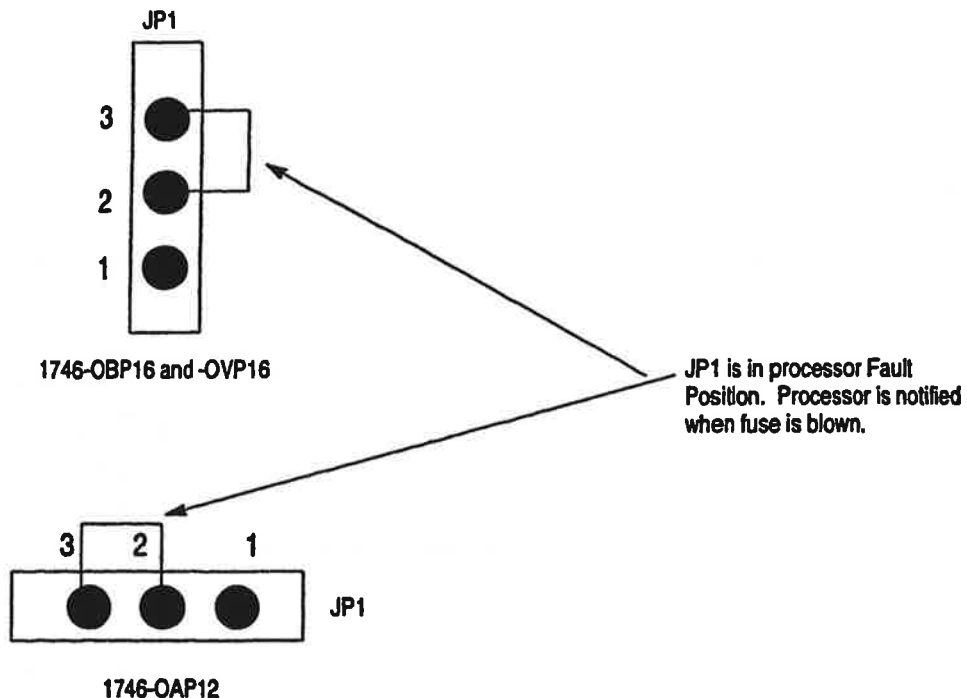
Fuse Protection and Blown Fuse Diagnostics

Processor Operation in Case of Blown Fuse – Processor Faults

The Processor Fault position for JP1 is shown in Figure 5. For this JP1 configuration, the processor generates a Non-Recoverable Error for all SLC 500 processors (Fixed and Modular). For a non-recoverable error, note the following:

- Processor operation halts and the processor fault light flashes.
- All outputs are reset to OFF.
- The processor major fault bit S:1/13 is set.
- Monitor processor status file word S:6 for error code xx58 for SLC 500 and 5/01™ processors, and error code xx60 for SLC 5/02™, SLC 5/03™, and SLC 5/04™ processors.

Figure 5
JP1 in Processor Fault Notification Position



Important: When using SLC 5/02, SLC 5/03, and SLC 5/04 processors, a user fault routine cannot be used to clear the major fault bit.

Fuse Protection and Blown Fuse Diagnostics

Processor Operation in Case of Blown Fuse – Processor Faults (continued)



ATTENTION: For 1746-OBP16/-OVP16, all outputs on the module are OFF if the fuse blows. For 1746-OAP12, all outputs on the same common as the blown fuse are OFF if the fuse blows. If processor operation is allowed to continue after a blown fuse, extreme care should be taken to ensure the safety of personnel and guard against equipment damage.

For additional information on processor fault codes and user fault routines refer to the following user manuals:

- Your programming device's reference manual
- HHT User Manual (Publication 1747-NP002) –
 - (a) Chapter 28, Troubleshooting Faults
 - (b) Chapter 29, Understanding the Fault Routine

Table 21 defines operation of SLC 500 processors in the case of a blown fuse in a 1746-OBP16, -OVP16 and -OAP12:

Table 21
Processor Operation After A Blown Fuse (1746-OBP16, -OVP16 and -OAP12)

Processor	JP1 Set to Processor Continues	JP1 Set to Processor Faults
SLC 500 Fixed, SLC 5/01, SLC 5/02, SLC 5/03, and SLC 5/04	No error. Processor continues with 1746-OBP16/-OVP16 outputs de-energized. 1746-OAP12 outputs, on the same common as the blown fuse, are de-energized.	Non-recoverable error. Processor operations stops and all outputs reset to OFF.

Fuse Protection and Blown Fuse Diagnostics

Recovery From Blown Fuse/Processor Fault/Processor Shutdown

Processor operation will stop under the following conditions:

- The output module fuse blows due to a short circuit.
- JP1 is set to the *Processor Faults* position (pins 2 and 3 connected).

If the above conditions occur, the following procedures should be used for recovery:

1. Follow fuse replacement procedures shown on page 36.
2. Clear the processor major fault bit S:1/13.
3. Clear processor status file S:6 major error code (optional).
4. Return processor to Run Mode.

For additional information on processor fault codes and clearing processor fault bits, refer to the following user manuals:

- Your programming device's reference manual
- HHT User Manual (Publication 1747-NP002) –
 - (a) Chapter 28, Troubleshooting Faults
 - (b) Chapter 29, Understanding the Fault Routine

Replacement Fuse Recommendations

Use the following replacement fuses –

- 1746-OBP16/-OVP16 –Littelfuse #322010,10A. This fuse is required to maintain UL/CSA rating. Replacement Fuse Kit is catalog number 1746-F8. (5 fuses per kit).
- 1746-OAP12 –Use SAN–O HQ 6.3A for replacement. This fuse is required to maintain UL/CSA rating. Replacement Fuse Kit is catalog number 1746-F9 (5 fuses per kit).

Fuse Protection and Blown Fuse Diagnostics

Fuse Replacement Procedure

To replace a blown fuse:



ATTENTION: Never install, remove, or wire modules with power applied to chassis.

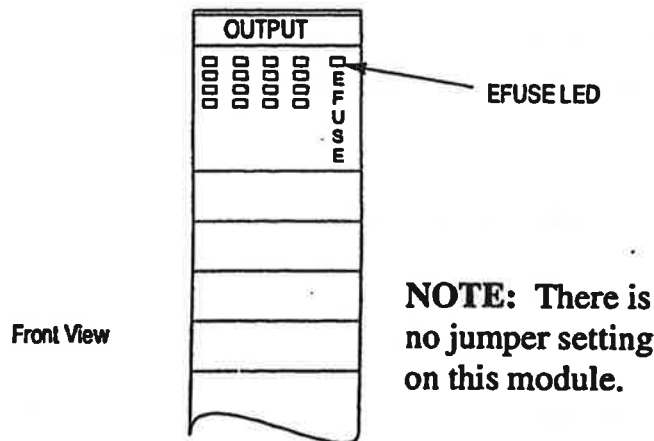
1. Remove SLC 500 system power and correct the conditions causing the short circuit.
2. Remove the output module from the chassis.
3. Remove the fuse.
 - 1746-OBP16/-OVP16: Use a wide tipped, slotted head screw driver to remove the blown fuse. Slide the screw driver tip under the fuse and use a twisting motion to pry the fuse from the fuse clip. Use care so that the printed circuit board and surrounding electronics are not damaged.
 - 1746-OAP12: A fuse holder is provided with each fuse. Simply grasp the fuse holder with needle-nose pliers, or your fingers, and pull it out.
3. Replace the fuse.
 - 1746-OBP16/OVP16: Center the replacement fuse over the fuse clip and press down. If a tool is used to press the fuse in place, apply pressure to the metal end caps only, not the center of the fuse.
 - 1746-OAP12: Insert a new fuse into the fuse holder, align fuse holder on fuse clips and press down.
4. Replace the output module in the chassis.
5. Restore SLC 500 system power. Clear processor fault bits as indicated in the steps provided on page 35.

Electronically Protected Modules (1746-OB16E)

Electronic Protection

The electronic protection of the 1746-OB16E has been designed to provide protection for the module from short circuit and from overload current conditions. The protection is based on a thermal cut-out principle. In the event of a short circuit or overload current condition on an output channel, that channel will limit current within milliseconds after its thermal cut-out temperature has been reached. All other channels will continue to operate as directed by the CPU (processor) module.

Important: The module does not provide protection against reverse polarity wiring or wiring to AC power sources. Electronic protection is not intended to replace fuses, circuit breakers, or other code-required wiring protection devices.



Short Circuit/Overload Current Diagnostics

If a short circuit or overload current condition occurs on an output channel:

1. The E-Fuse LED will illuminate provided that power is applied to the module. (power required: 5V dc via backplane and load power via an external supply)
2. All other channels will continue to operate as directed by the CPU (processor) module.

Recovery From Channel Shutdown

1. Remove the SLC 500 system power and correct the conditions causing the short circuit or overload current condition.
2. Restore the SLC 500 system power. The module will automatically reset and resume control of the output channel and associated load.

Wiring Diagrams

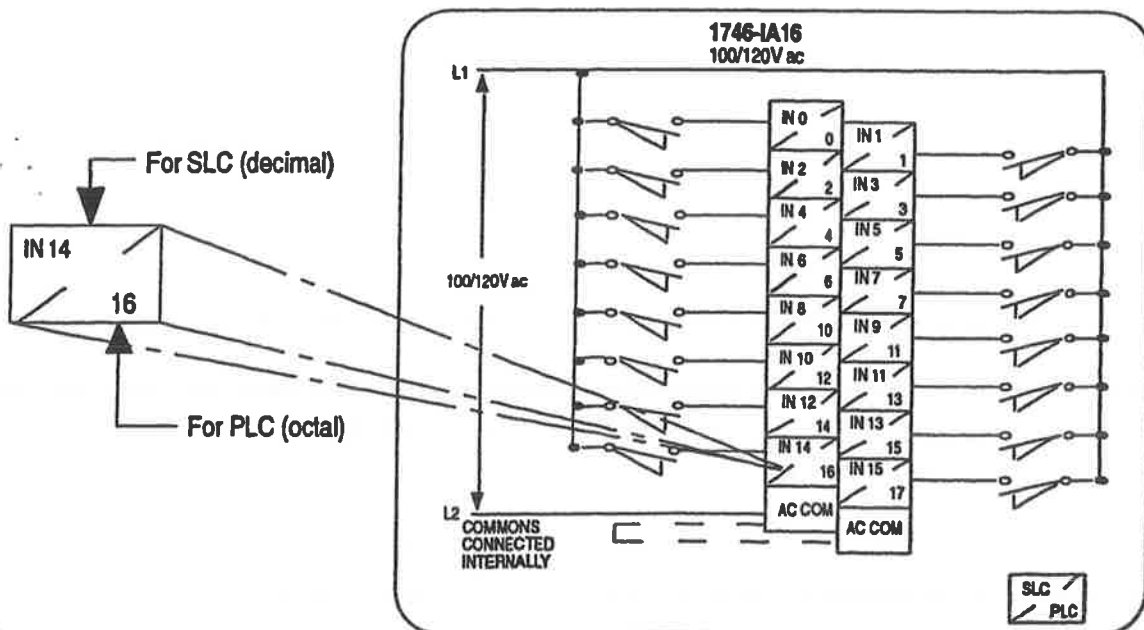
The wiring diagrams in these installation instructions are examples only. It is not necessary to connect an I/O device to each and every I/O module terminal.

Labeling for SLC/PLC® Systems

In this document, 16 point I/O module wiring diagrams include both decimal and octal numbers for I/O addressing and wire identification (Figure 6 on page 38). To wire your 16 point I/O module when used in a SLC system, use the decimal numbers in the upper left portion of each box. When used in a PLC system, use the octal numbers in the lower right portion of the box. *As shipped from the factory, the I/O module has a decimal address label on the inside of its door.* An octal label kit should be included with your 16 point I/O modules, or a separate octal conversion kit can be ordered, to allow you to convert your module to the octal system.

Important: Ensure the octal labels are used with your PLC system. Directions on how to install the labels are included with the kit and on page 27 of this document.

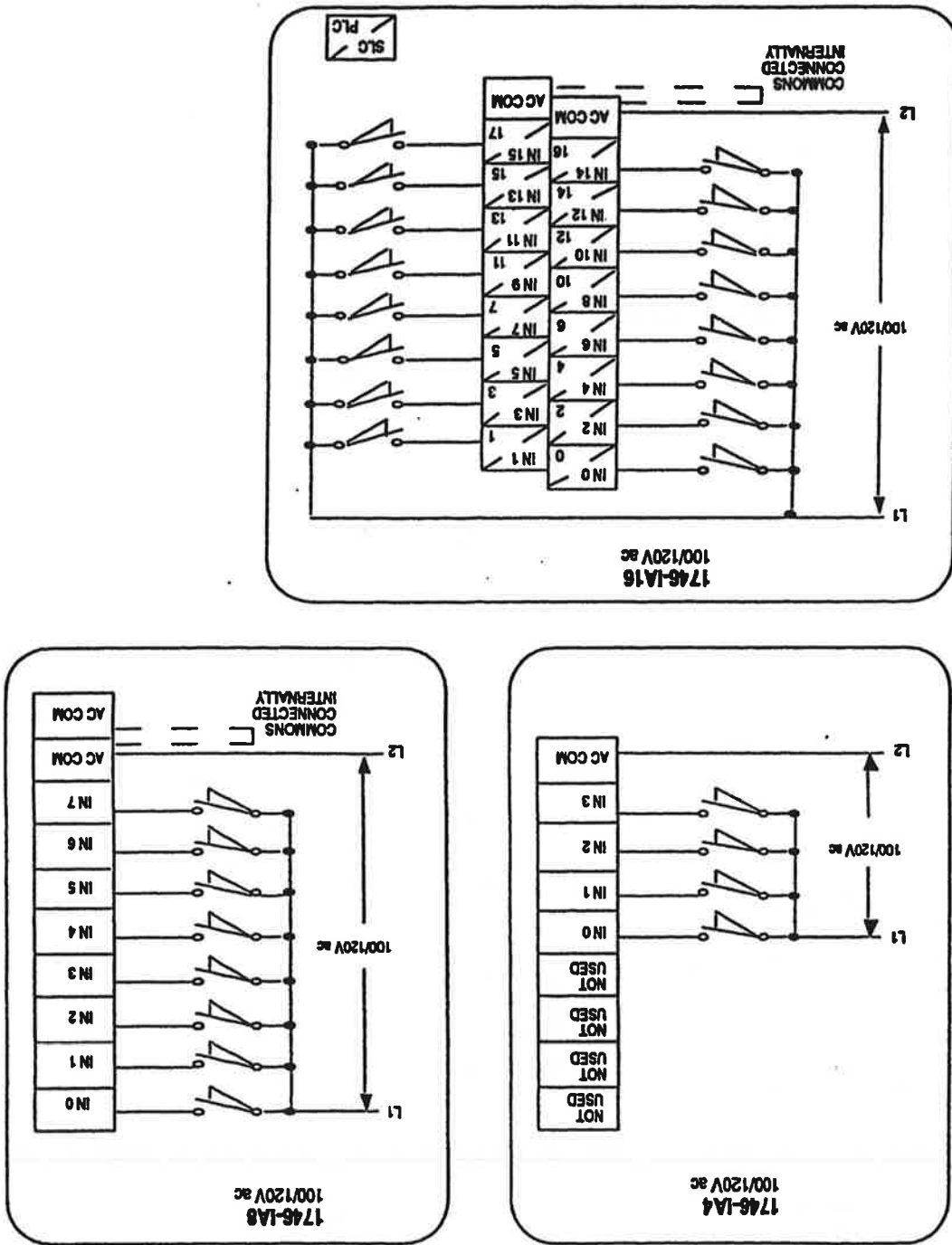
Figure 6
Decimal and Octal Labeling for 16 Point I/O



Wiring Diagrams

Input Modules - ac

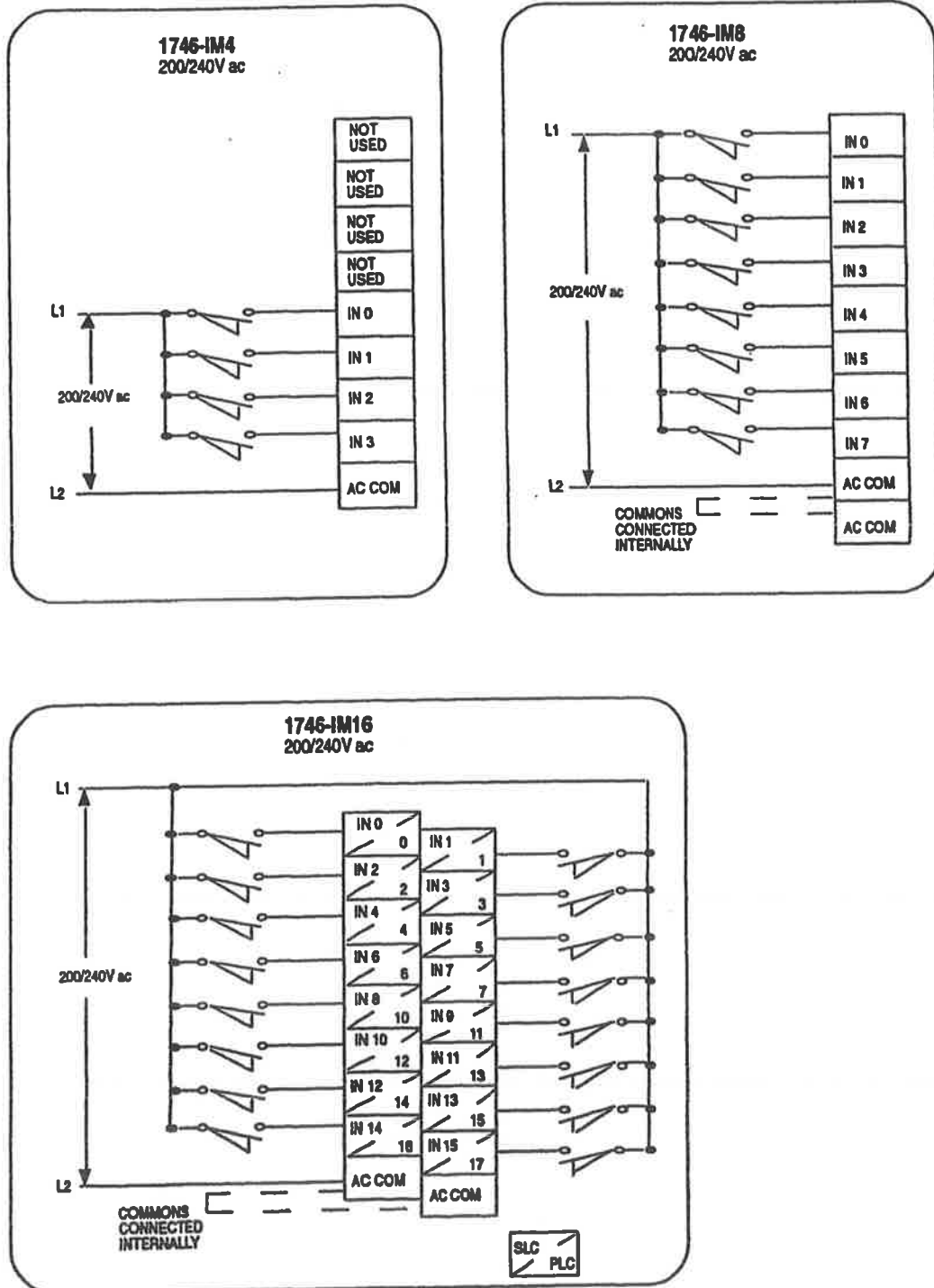
Figure 7
Wiring Diagrams (1746-IA4, -IA8, -IA16)



Wiring Diagrams

Input Modules – ac (continued)

Figure 8
Wiring Diagrams (1746-IM4, -IM8, -IM16)



Wiring Diagrams

Input Modules – dc

Figure 9
Wiring Diagram (1746-IN16)

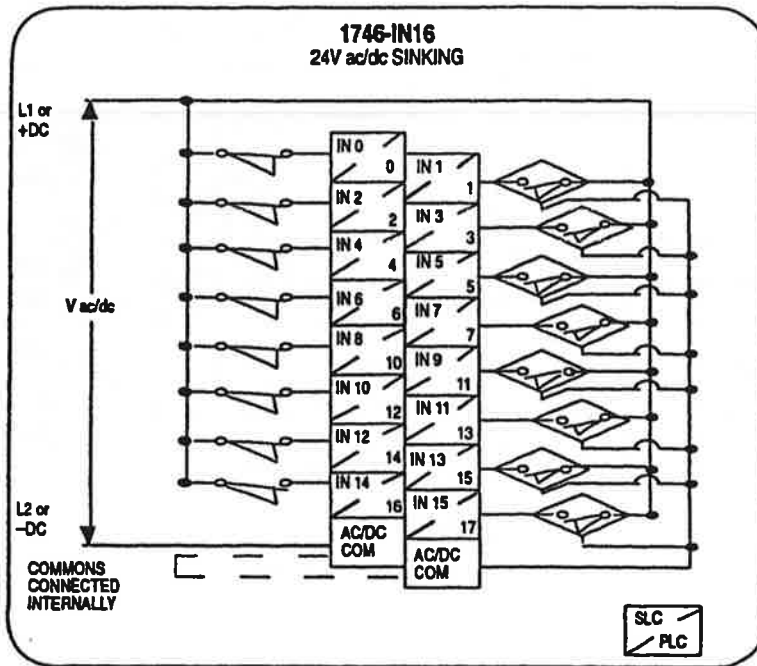
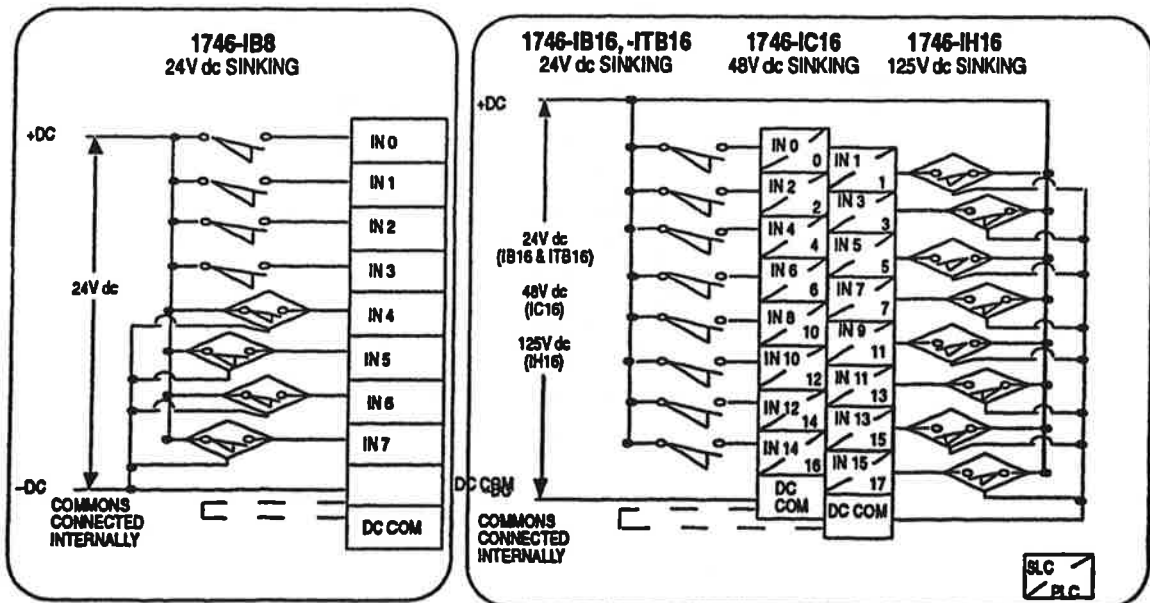


Figure 10
Wiring Diagram (1746-IB8, -IB16, -ITB16, -IC16, -IH16)



Wiring Diagrams

Input Modules – dc (continued)

Figure 11
Wiring Diagram (1746-IV8, -IV16, -ITV16)

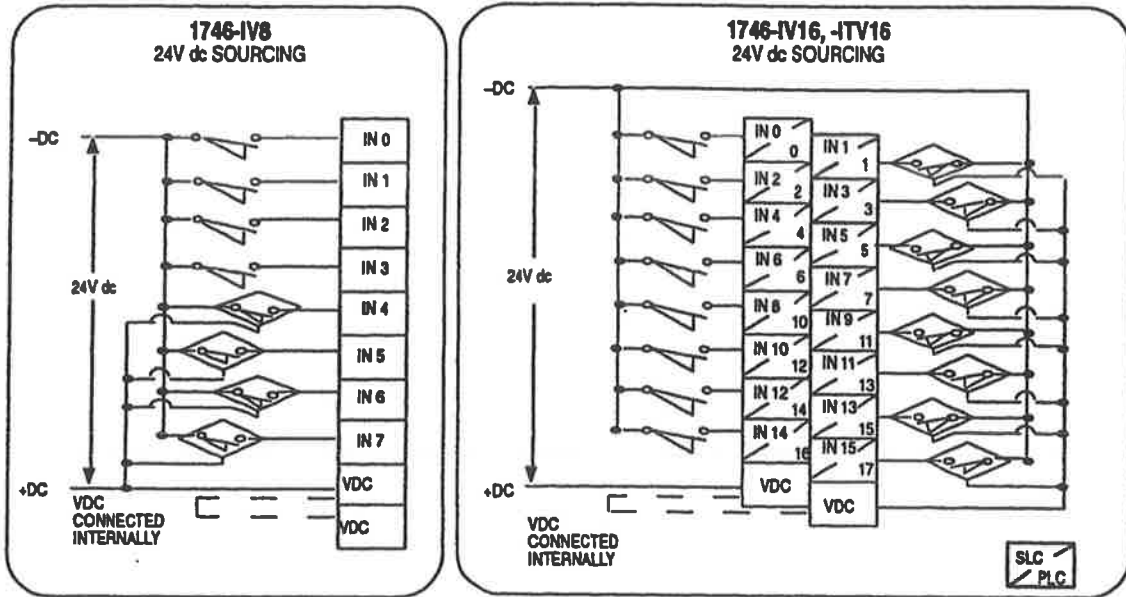
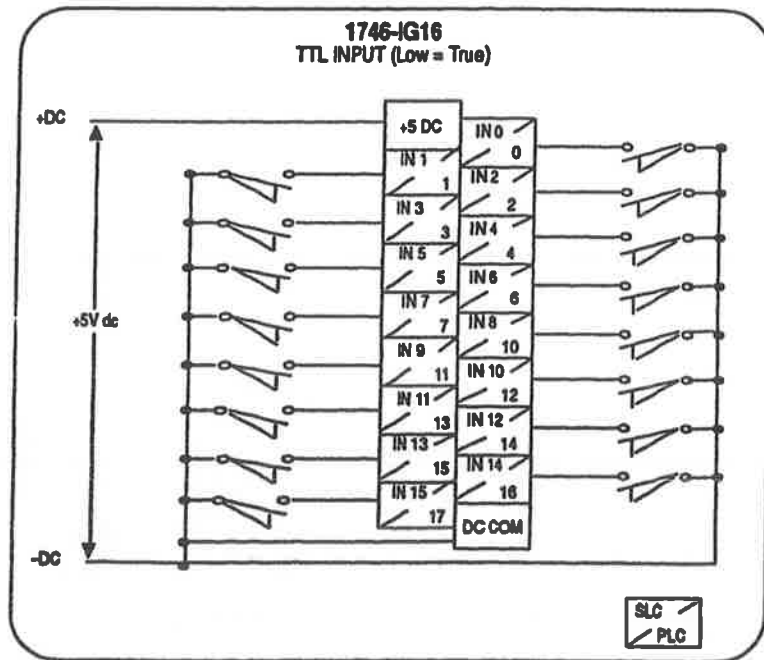


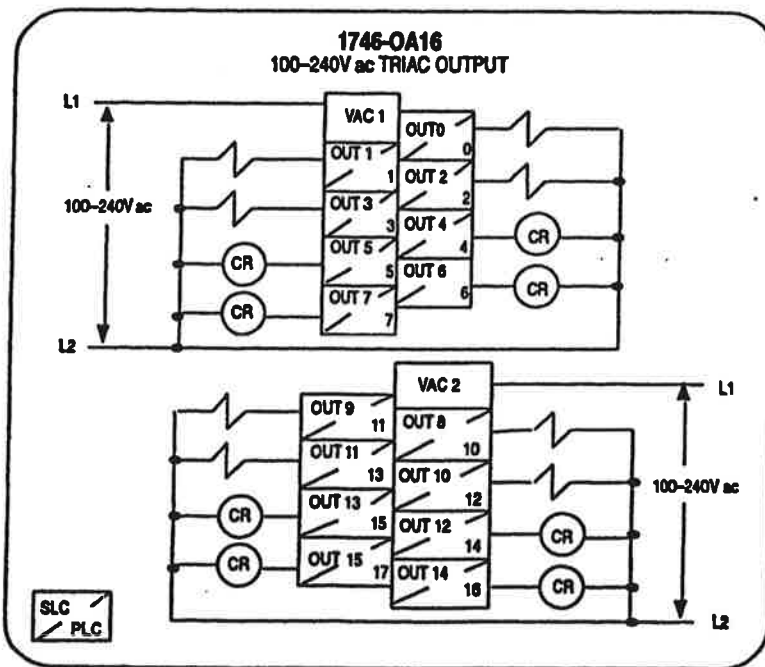
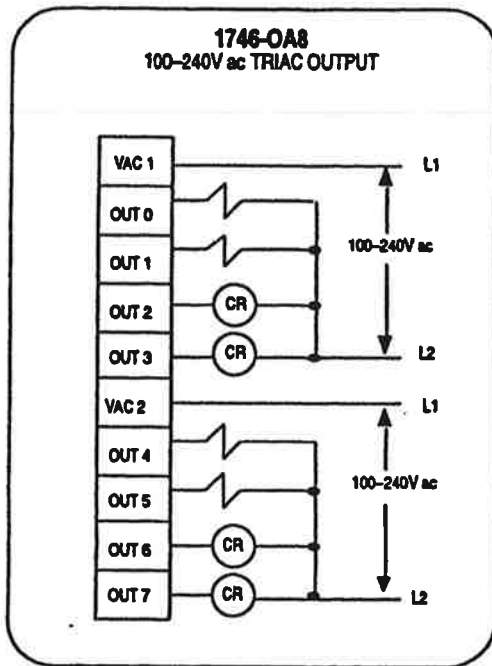
Figure 12
Wiring Diagram (1746-IG16)



Wiring Diagrams

Output Modules – ac

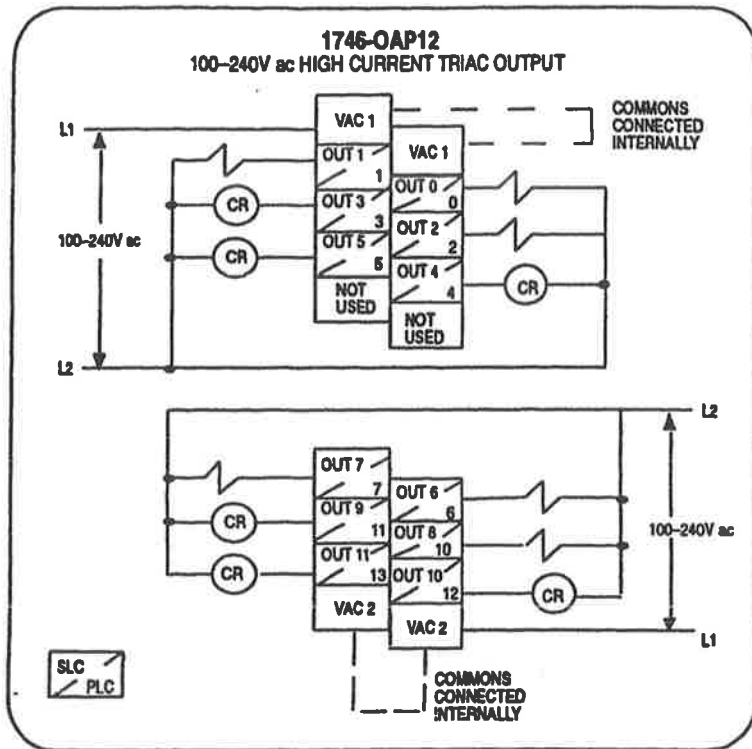
Figure 13
Wiring Diagrams (1746-OA8, -OA16)



Wiring Diagrams

Output Modules – ac (continued)

Figure 14
Wiring Diagram (1746-OAP12)



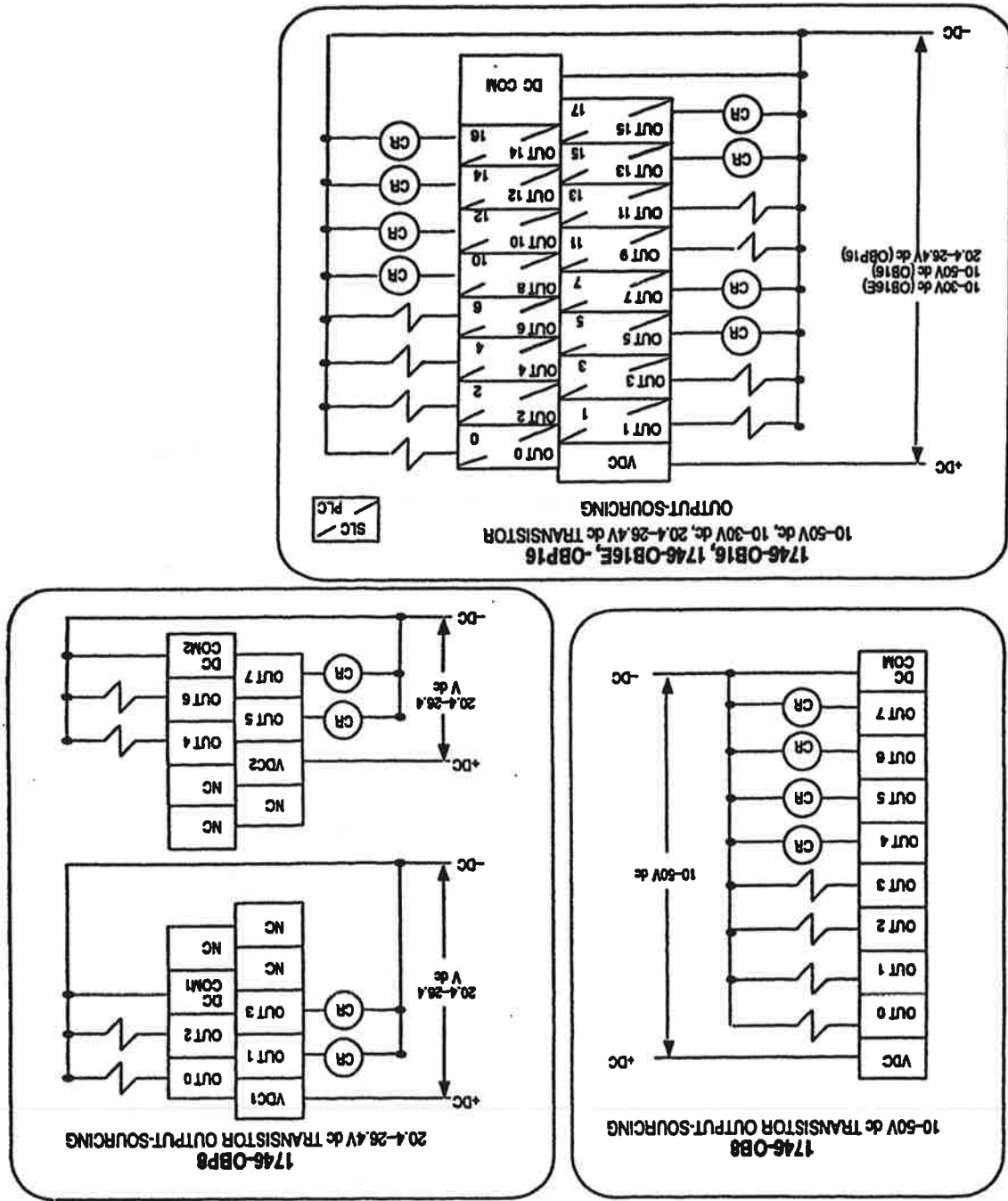


Figure 15
Wiring Diagrams (1746-OB8, -OBP8, -OB16, -OB16E, -OBP16)

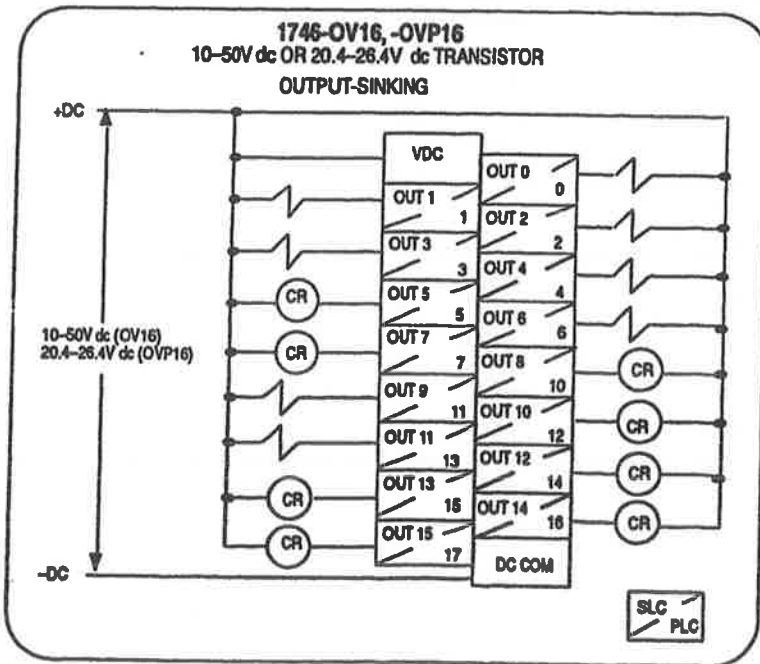
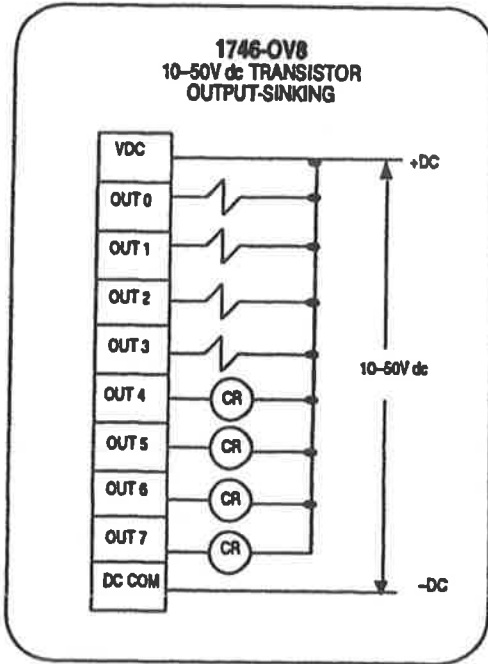
Output Modules – dc

Wiring Diagrams

Wiring Diagrams

Output Modules – dc (continued)

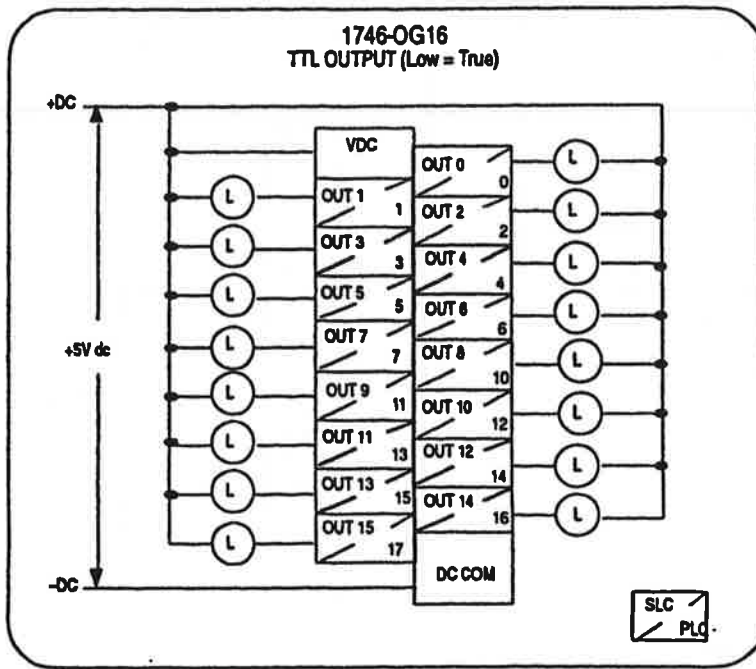
Figure 16
Wiring Diagrams (1746-OV8, -OV16, -OVP16)



Wiring Diagrams

Output Modules – dc (continued)

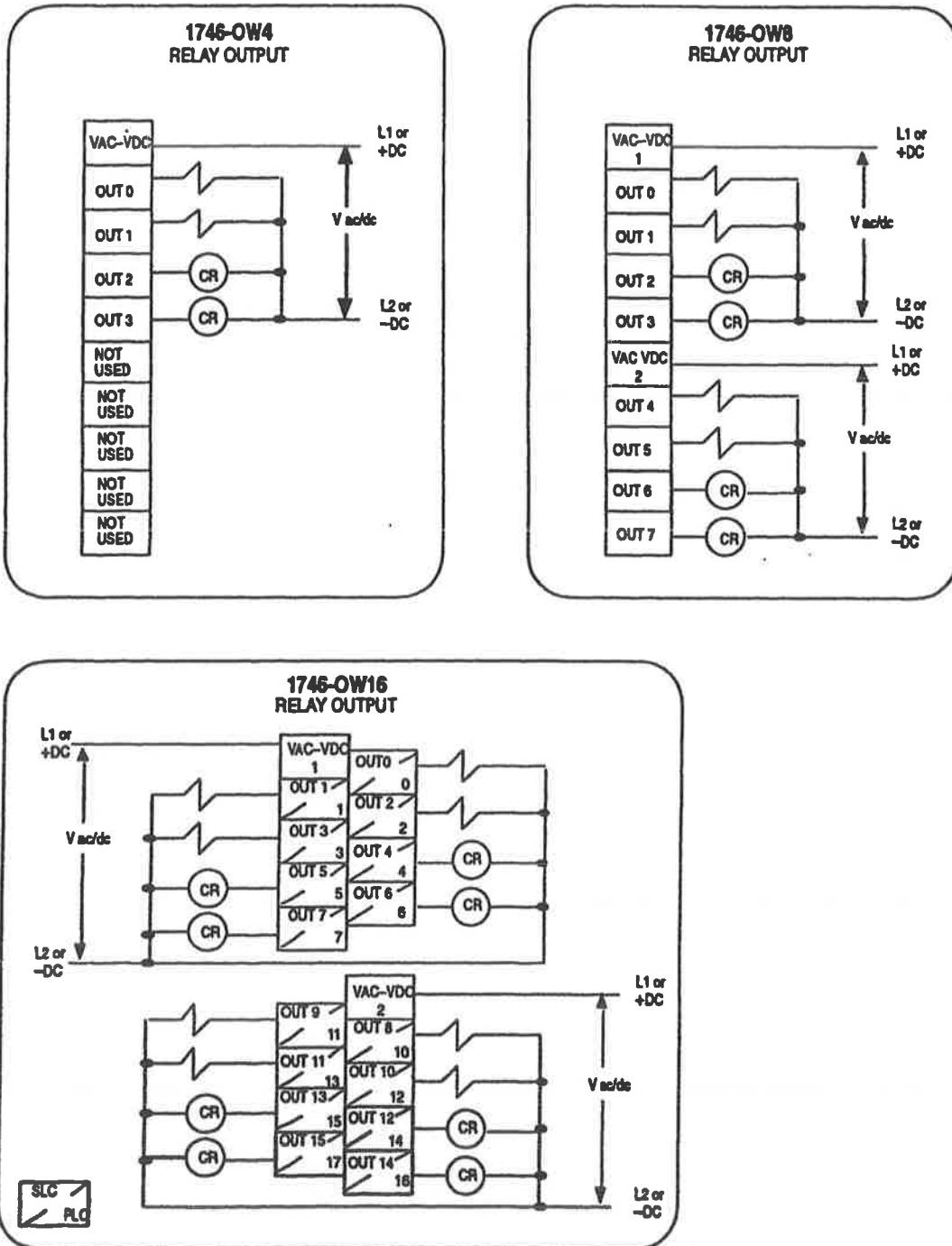
Figure 17
Wiring Diagrams (1746-OG16)



Wiring Diagrams

Relay Contact Output Modules

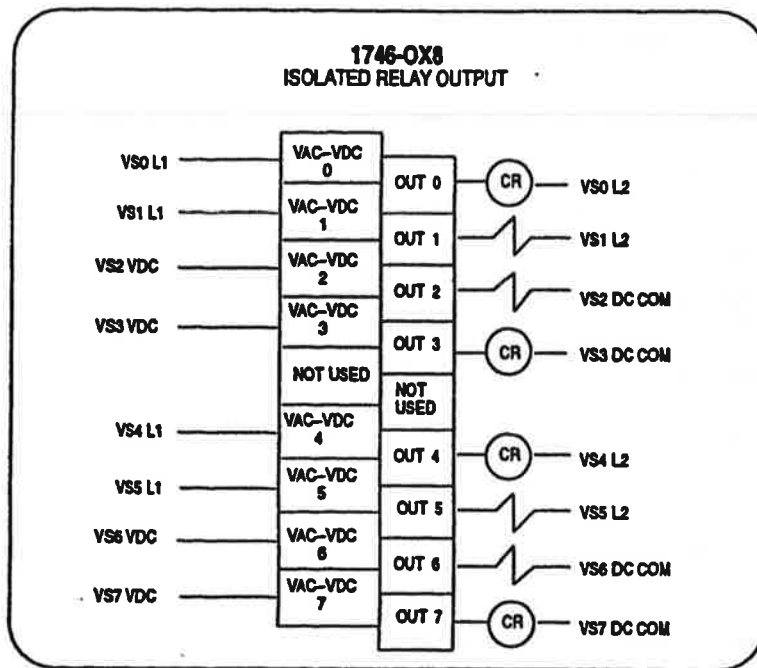
Figure 18
Wiring Diagrams (1746-OW4, -OW8, -OW16)



Wiring Diagrams

Relay Contact Output Modules (continued)

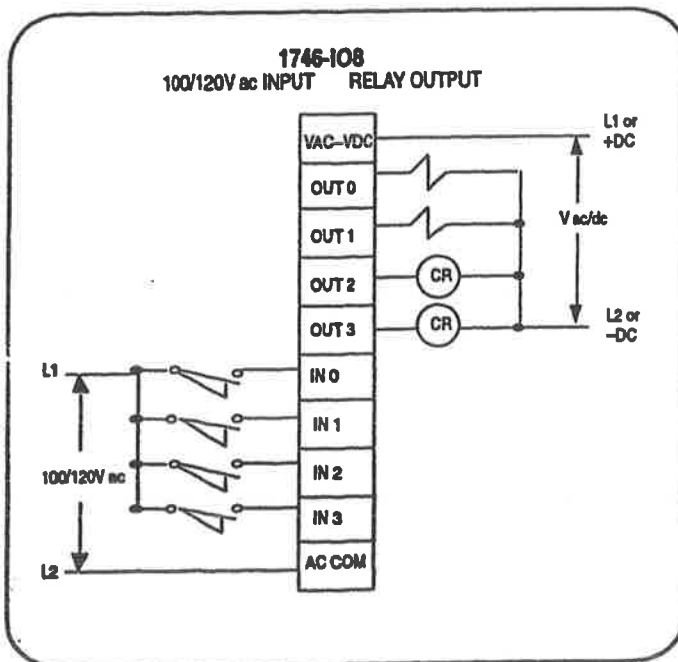
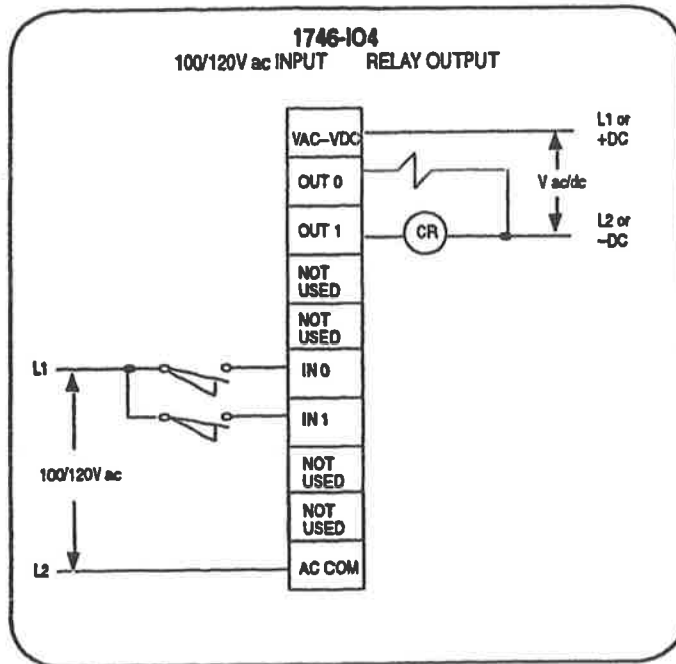
Figure 19
Wiring Diagram (1746-OX8)



Wiring Diagrams

Input/Output Combination Modules

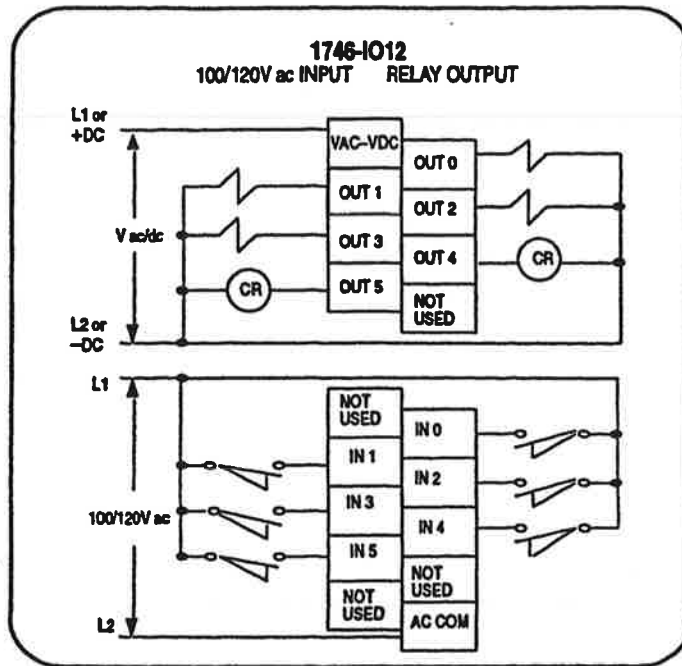
Figure 20
Wiring Diagram (1746-IO4, -IO8)



Wiring Diagrams

Input/Output Combination Modules (continued)

Figure 21
Wiring Diagram (1746-IO12)



PLC is a registered trademark of Rockwell Automation.
SLC 500, SLC 5/01, SLC 5/02, SLC 5/03, and SLC 5/04 are trademarks of Rockwell Automation.

 **Rockwell Automation**

Allen-Bradley

Worldwide representation.



Argentina • Australia • Austria • Bahrain • Belgium • Brazil • Bulgaria • Canada • Chile • China, PRC • Colombia • Costa Rica • Croatia • Cyprus • Czech Republic • Denmark • Ecuador • Egypt • El Salvador • Finland • France • Germany • Greece • Guatemala • Honduras • Hong Kong • Hungary • Iceland • India • Indonesia • Ireland • Israel • Italy • Jamaica • Japan • Jordan • Korea • Kuwait • Lebanon • Malaysia • Mexico • Netherlands • New Zealand • Norway • Pakistan • Peru • Philippines • Poland • Portugal • Puerto Rico • Qatar • Romania • Russia-CIS • Saudi Arabia • Singapore • Slovakia • Slovenia • South Africa, Republic • Spain • Sweden • Switzerland • Taiwan • Thailand • Turkey • United Arab Emirates • United Kingdom • United States • Uruguay • Venezuela • Yugoslavia

Allen-Bradley Headquarters, 1201 South Second Street, Milwaukee, WI 53204 USA
Tel: (1) 414 382-2000 Fax: (1) 414 382-4444



 **Rockwell** Automation

Allen-Bradley

SLC 500™ Modular Chassis

(Cat. No. 1746-A4, -A7, -A10, and -A13 Series B)



Installation Instructions

Inside ...	page
English Section	1

Important User Information

Because of the variety of uses for the products described in this publication, those responsible for the application and use of this control equipment must satisfy themselves that all necessary steps have been taken to assure that each application and use meets all performance and safety requirements, including any applicable laws, regulations, codes and standards.

The illustrations, charts, sample programs and layout examples shown in this guide are intended solely for purposes of example. Since there are many variables and requirements associated with any particular installation, Allen-Bradley does not assume responsibility or liability (to include intellectual property liability) for actual use based upon the examples shown in this publication.

Allen-Bradley publication SGI-1.1, *Safety Guidelines for the Application, Installation, and Maintenance of Solid-State Control* (available from your local Allen-Bradley office), describes some important differences between solid-state equipment and electromechanical devices that should be taken into consideration when applying products such as those described in this publication.

Reproduction of the contents of this publication, in whole or in part, without written permission of the Allen-Bradley Company is prohibited.

Throughout these installation instructions we use notes to make you aware of safety considerations:



ATTENTION: Identifies information about practices or circumstances that can lead to personal injury or death, property damage, or economic loss.

Attention statements help you to:

- identify a hazard
- avoid the hazard
- recognize the consequences

Important: Identifies information that is critical for successful application and understanding of the product.



Supplemental Product Information

CSA Hazardous Location Approval

CSA certifies products for general use as well as for use in hazardous locations. **Actual CSA certification is indicated by the product label as shown below, and not by statements in any user documentation.**

Example of the CSA certification product label



To comply with CSA certification for use in hazardous locations, the following information becomes a part of the product literature for CSA-certified Allen-Bradley industrial control products.

- This equipment is suitable for use in Class I, Division 2, Groups A, B, C, D, or non-hazardous locations only.
- The products having the appropriate CSA markings (that is, Class I Division 2, Groups A, B, C, D), are certified for use in other equipment where the suitability of combination (that is, application or use) is determined by the CSA or the local inspection office having jurisdiction.

Important: Due to the modular nature of a PLC® control system, the product with the highest temperature rating determines the overall temperature code rating of a PLC control system in a Class I, Division 2 location. The temperature code rating is marked on the product label as shown.

Temperature code rating



The following warnings apply to products having CSA certification for use in hazardous locations.



ATTENTION: Explosion hazard —

- Substitution of components may impair suitability for Class I, Division 2.
- Do not replace components unless power has been switched off or the area is known to be non-hazardous.
- Do not disconnect equipment unless power has been switched off or the area is known to be non-hazardous.
- Do not disconnect connectors unless power has been switched off or the area is known to be non-hazardous. Secure any user-supplied connectors that mate to external circuits on an Allen-Bradley product using screws, sliding latches, threaded connectors, or other means such that any connection can withstand a 15 Newton (3.4 lb.) separating force applied for a minimum of one minute.

PLC is a registered trademark of Allen-Bradley Company, Inc.

CSA logo is a registered trademark of the Canadian Standards Association.



SLC 500 Modular Chassis

(Cat. No. 1746-A4, -A7, -A10, and -A13 Series B)

Installation Instructions

What's in this Publication

Use this publication as a guide when installing a SLC 500™ modular chassis (1746-A4, -A7, -A10, or -A13 series B).

Installation

To:	See page:
↓ prepare for installation	2
↓ allow sufficient mounting space	3
↓ install your chassis	4
↓ ground your chassis	6
↓ install the chassis interconnect cable (optional)	9
↓ install your I/O modules and attach your power supply	9

Reference

For this information:	See page:
➡ mounting dimensions	10
➡ specifications	12

For additional installation information, see the *SLC 500 Modular Style Installation and Operation Manual*, publication 1747-6.2.

Prepare for Installation

Make sure you have these items.

M4 or M5 (#10 or #12) Hardware

- phillips screw and star washer (or SEM screw — phillips screw with attached star washer) for chassis mounting tabs

This chassis:	Has:
1746-A4	4 mounting tabs
1746-A7	4 mounting tabs
1746-A10	6 mounting tabs
1746-A13	8 mounting tabs

- phillips screwdriver
- drill

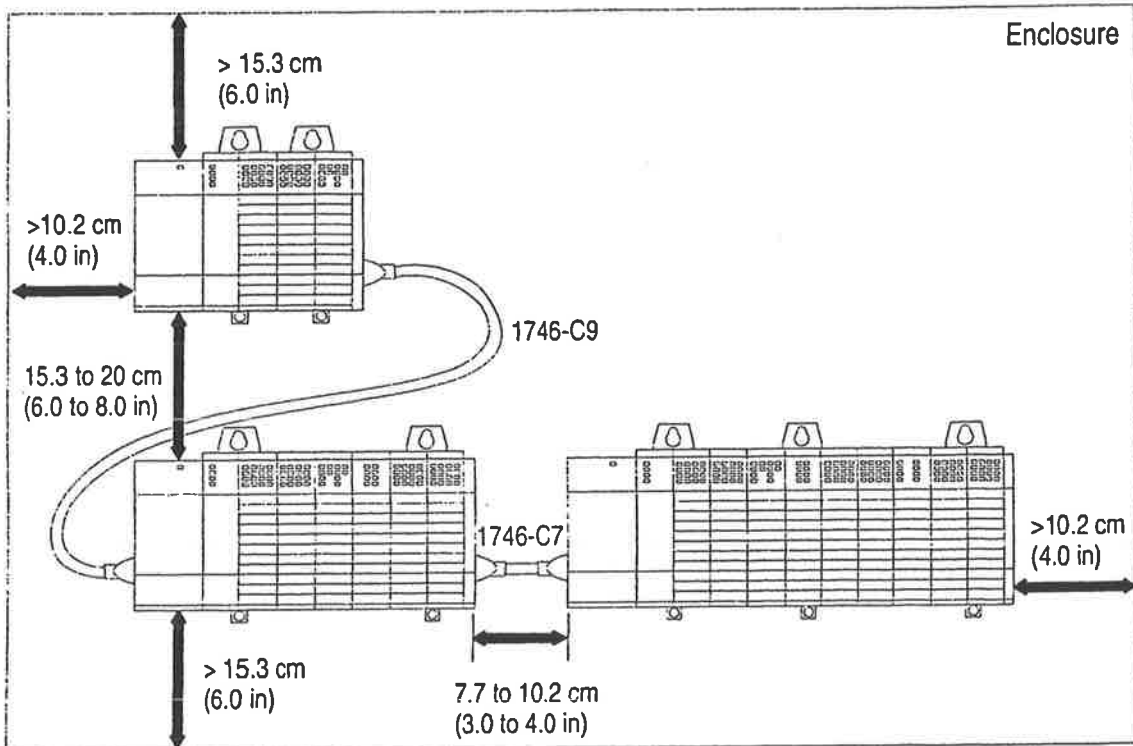
Documentation

For your:

- processor or I/O adapter module
- power supply
- communication modules and/or I/O modules

Allow Sufficient Mounting Space

Important: Make sure you meet these **minimum** spacing requirements. Up to three SLC chassis can be connected (for a maximum of 30 I/O slots).



20230

Important: When vertically connecting two 1746-A13 chassis with a 1746-C9 cable, the space cannot be greater than 15.3 cm (6.0 in) for the cable to reach from chassis to chassis.

For dimensions of:	See page:
left side of all chassis	10
1746-A4, -A7	10
1746-A10, -A13	11

Installation Instructions
SLC 500 Modular Chassis
1746-A4, -A7, -A10, -A13 Series B

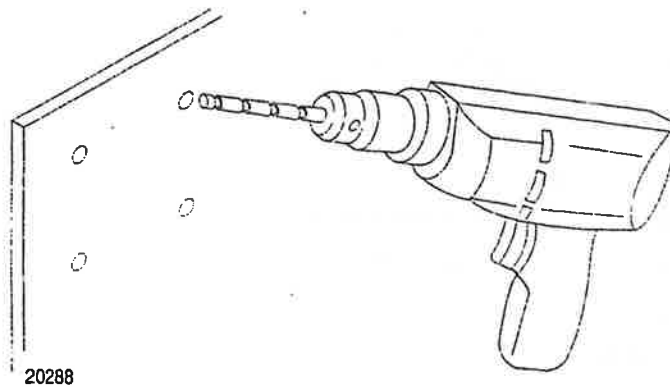
Install Your Chassis

1



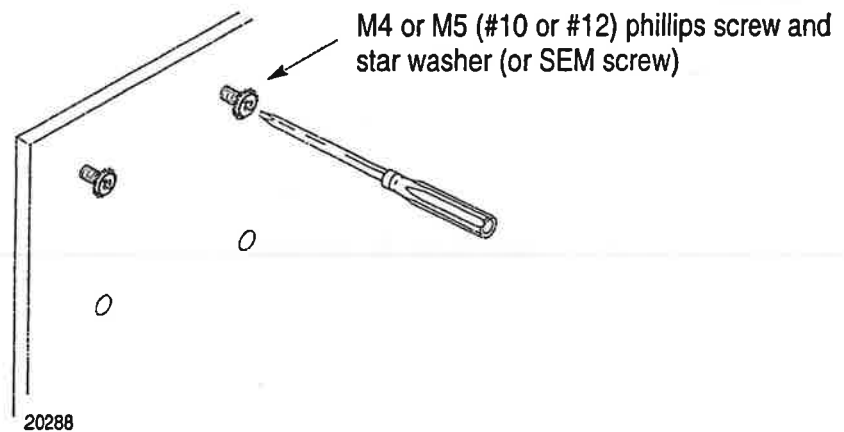
ATTENTION: Be careful of metal chips when drilling mounting holes for the SLC chassis. Do not drill holes above an SLC chassis if a processor and I/O modules are installed.

Drill holes in the back panel of the enclosure for chassis mounting tabs.



2

Install the hardware for the top mounting tabs.



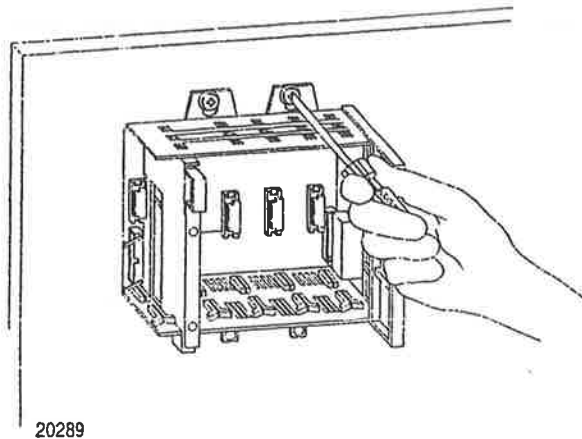
Note: Scrape paint off the back panel for an electrical connection between the chassis and back panel.

3



ATTENTION: If the chassis mounting tabs do not lay flat before the screws are tightened, use additional washers as shims so that the chassis will not be warped by tightening the screws. Warping a chassis could damage the backplane and cause poor connections.

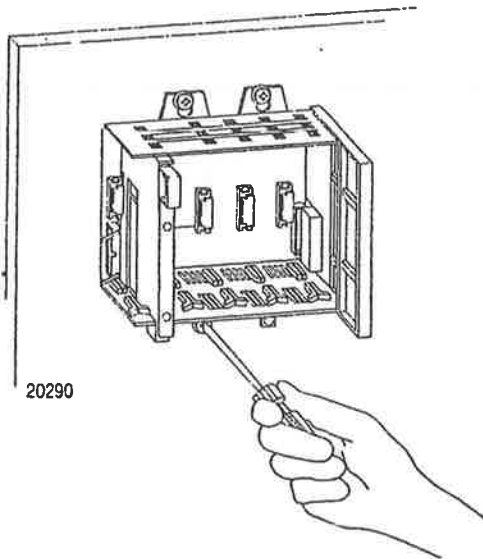
Slide the chassis over the installed hardware and tighten the screws.



20289

4

Leaving far-left and far-right tabs open for grounding, install the remaining tab hardware (for a four-slot chassis, leave both tabs open).



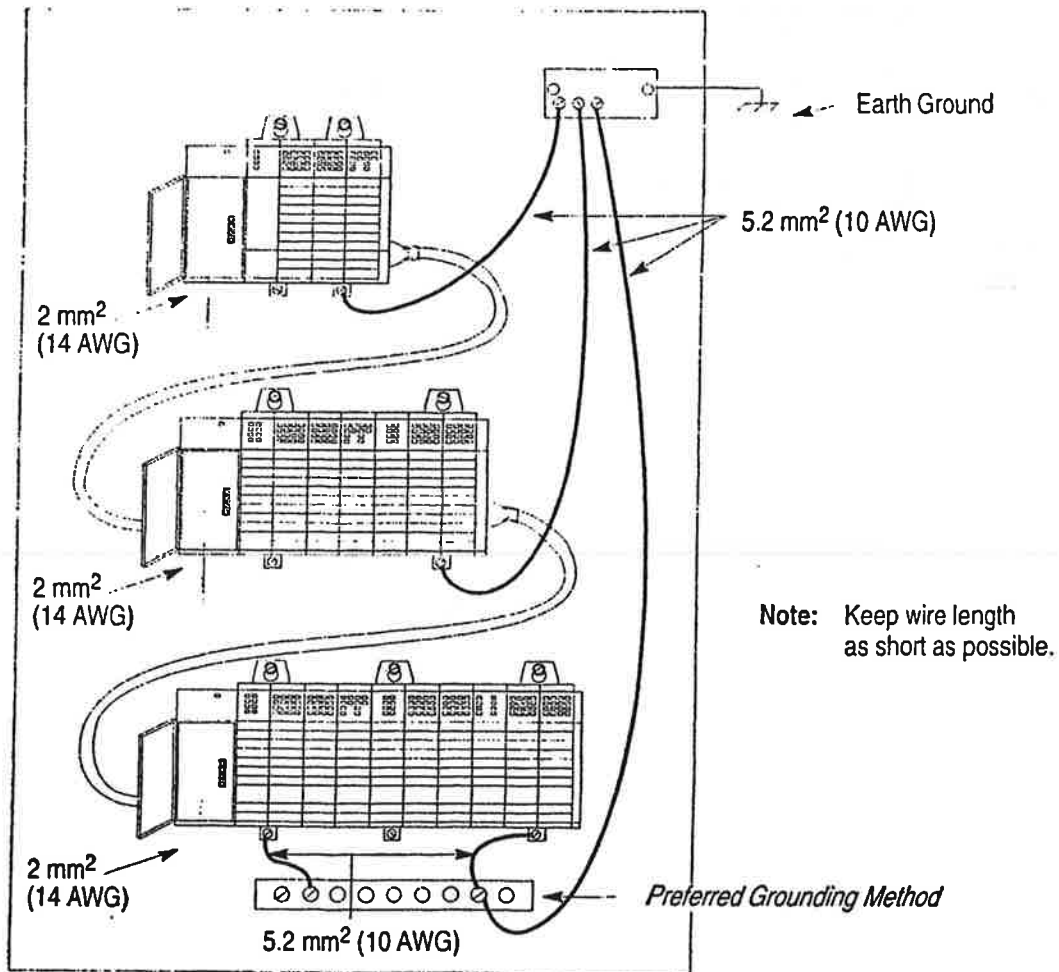
20290

Ground Your Chassis

To properly ground your I/O chassis:	See page:
verify grounding configuration	6
install a central ground bus	7
connect equipment grounding conductor	7
connect equipment grounding conductor to ground bus	8
connect ground bus to grounding-electrode system	8

Verify Grounding Configuration

This figure shows you how to run ground connections from the chassis to the ground bus. Two acceptable grounding methods are shown; we recommend using a ground bus because it reduces the electrical resistance at the connection.

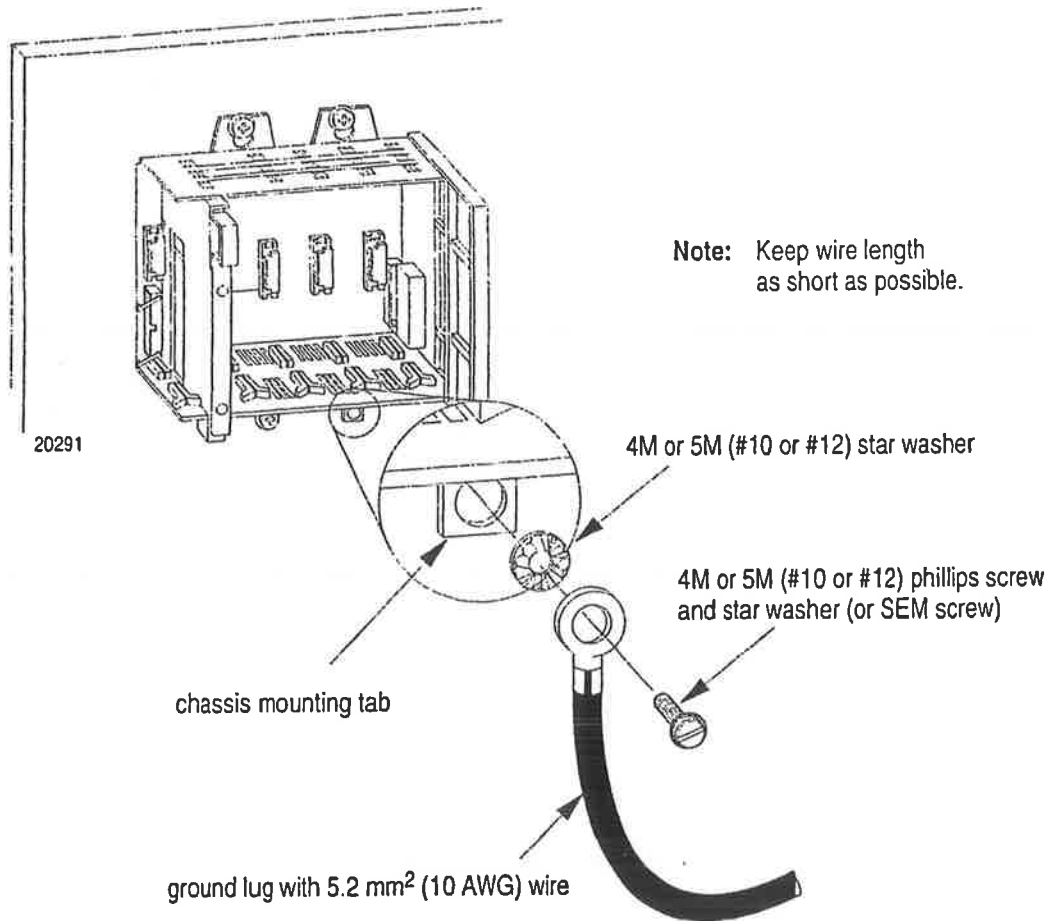


Install a Central Ground Bus

Each enclosure must contain a central ground bus. The ground bus is the common connection for each chassis within the enclosure and the enclosure itself. If you have not already installed a central ground bus, see the *Industrial Automation Wiring and Grounding Guidelines*, publication 1770-4.1.

Connect Equipment Grounding Conductor

Important: Use the following information, along with the installation manual for your programmable controller, to ground the chassis and your I/O modules.



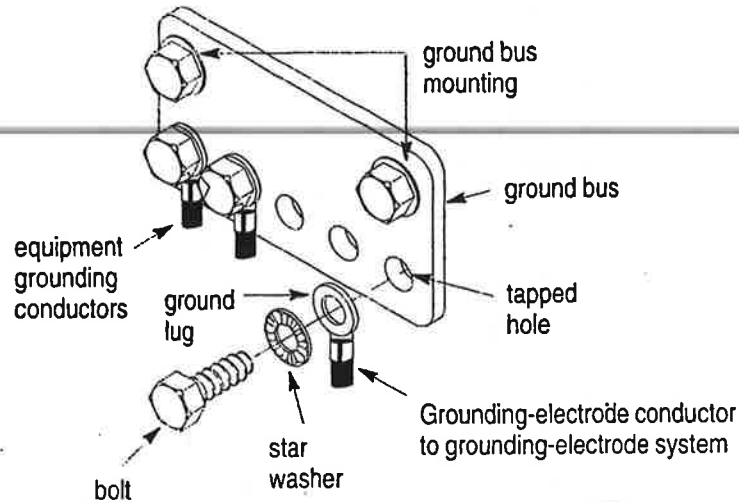
Installation Instructions

SLC 500 Modular Chassis

1746-A4, -A7, -A10, -A13 Series B

Connect Equipment Grounding Conductor to Ground Bus

Connect an equipment grounding conductor directly from each chassis to an individual bolt on the ground bus.



- use 2.54 cm (1 in) copper braid or **5.2 mm² (10 AWG)** copper wire to connect each chassis, the enclosure, and a central ground bus mounted on the back-panel
- use a steel enclosure to guard against electromagnetic interference (EMI)
- make sure the enclosure door viewing window is a laminated screen or a conductive optical substrate (to block EMI)
- install a bonding wire for electrical contact between the door and the enclosure; do not rely on the hinge

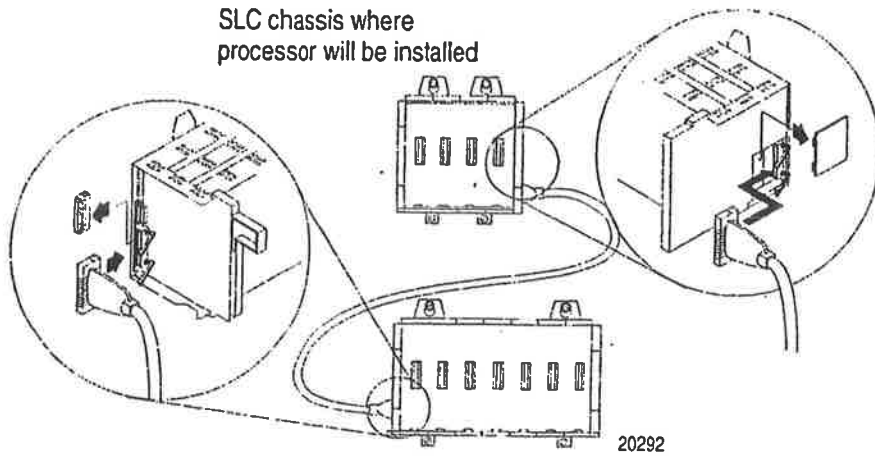
Important: Do not lay one ground lug directly on top of the other; this type of connection can become loose **due to compression** of the metal lugs. Place the first lug between a star washer and a nut with a captive star washer. After tightening the nut, place the second lug between the first nut and a second nut with a captive star washer.

Connect Ground Bus to Grounding-Electrode System

The grounding-electrode system is at earth-ground potential and is the central ground for all electrical equipment and ac power within any facility. Use a grounding-electrode conductor to connect the ground bus to the grounding-electrode system. Use at **minimum 8.3 mm² (8 AWG)** copper wire for the grounding-electrode conductor to guard against EMI. The National Electrical Code specifies safety requirements for the grounding-electrode conductor.

Install the Chassis Interconnect Cable (optional)

To connect up to three chassis together (for a maximum of 30 I/O slots), install the chassis interconnect cable before attaching your power supply.



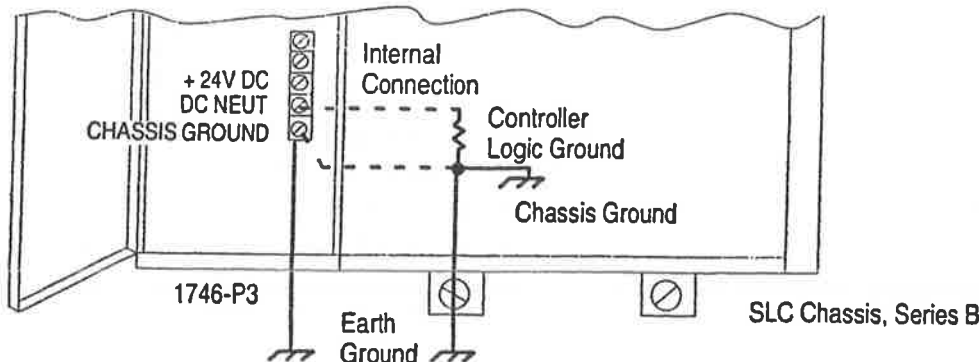
Install Your I/O Modules and Attach Your Power Supply

Use the installation instructions/user manuals for your modules to install them into the chassis. Use the installation instructions for your power supply (1746-P1, -P2, -P3, -P4, or -P5) to attach it to your chassis.



- ATTENTION:**
- Keep the connector plug on the left side-connector of the chassis if you are not connecting chassis together.
 - Remove the protective label from the top of the power supply before applying power.

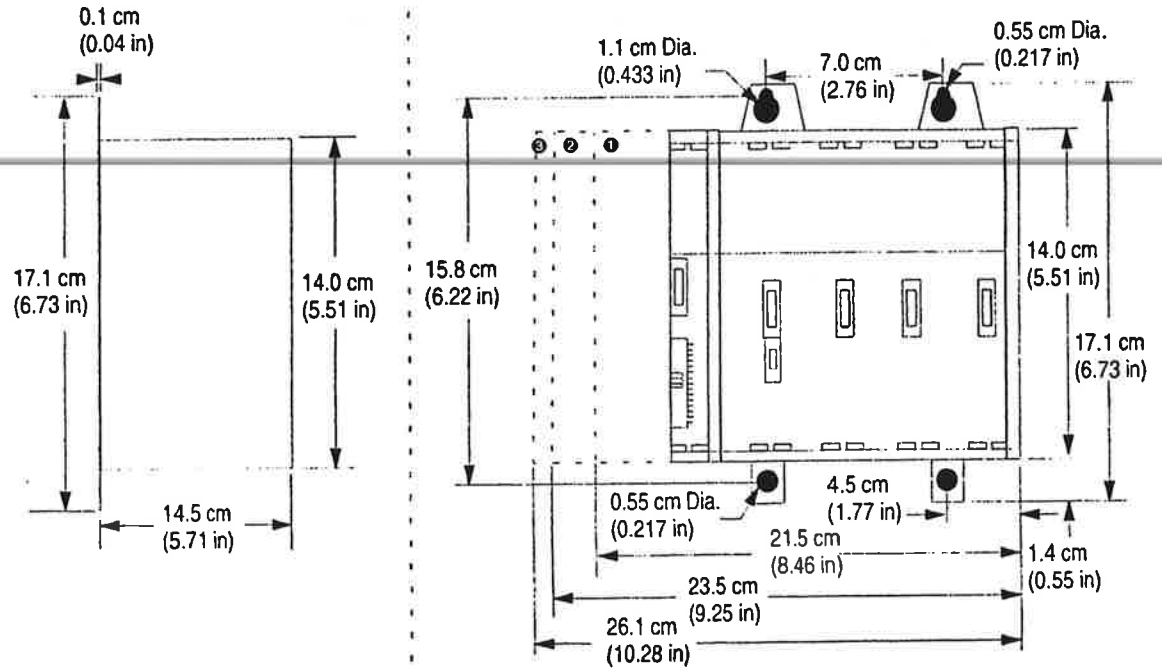
Important: Series B chassis have a $1M\Omega$ resistor between logic ground and chassis ground. When using a 1746-P3 dc power supply, follow the grounding instructions provided with the power supply to avoid unwanted potentials across the logic ground of the SLC processor.



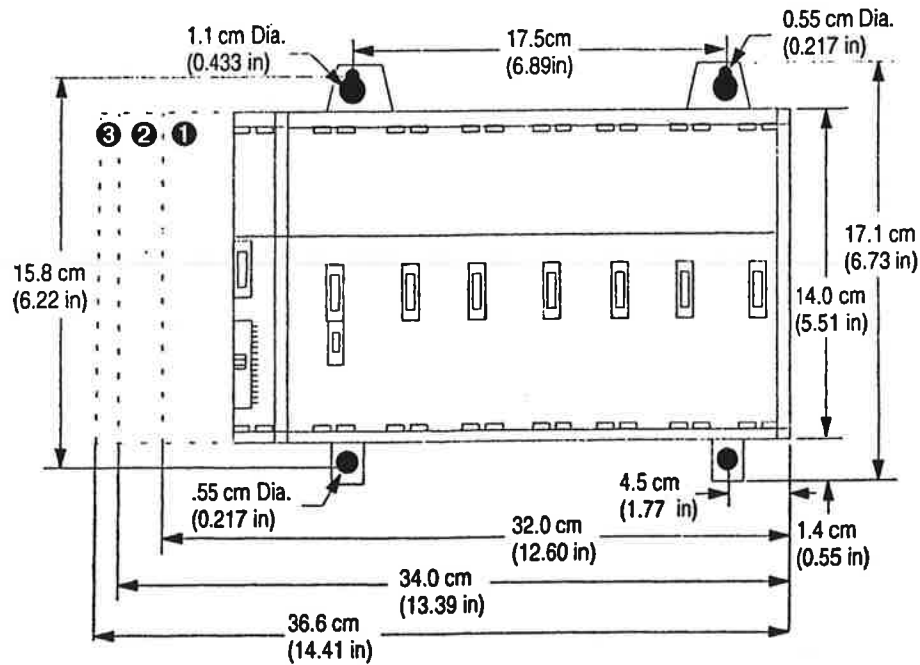
Installation Instructions
SLC 500 Modular Chassis
1746-A4, -A7, -A10, -A13 Series B

Mounting Dimensions

Left-side View (all chassis) 1746-A4



1746-A7



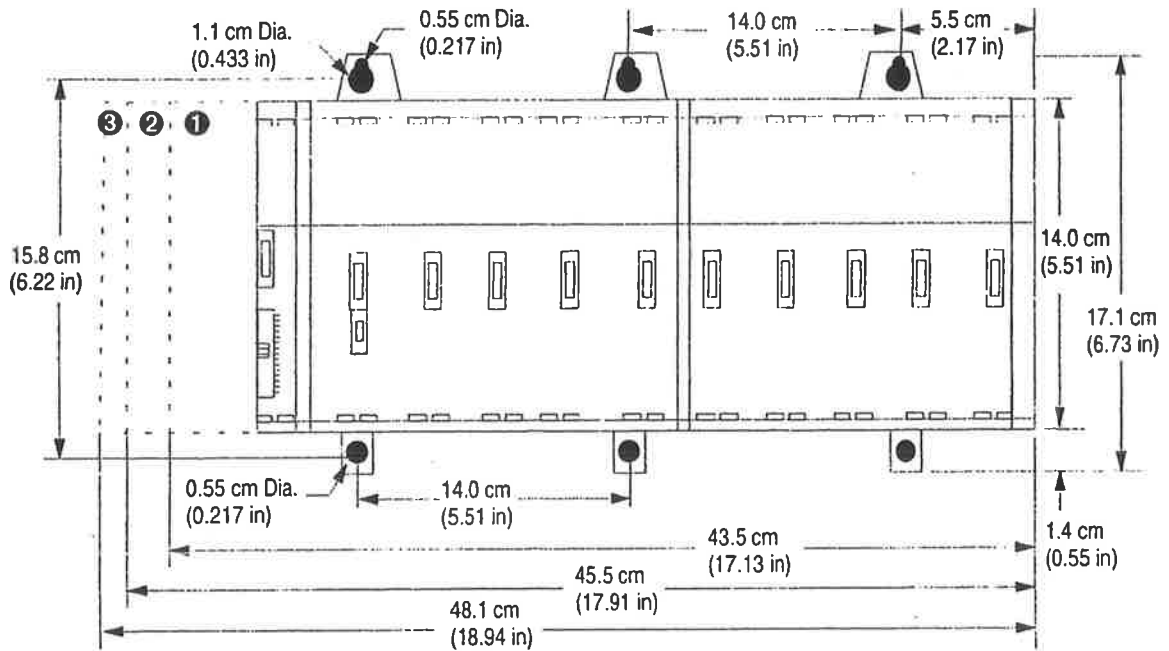
- ① Dimensions with 1746-P1 power supply.
- ② Dimensions with 1746-P2, 1746-P3, or 1746-P5 power supply.
- ③ Dimensions with 1746-P4 power supply.

Installation Instructions

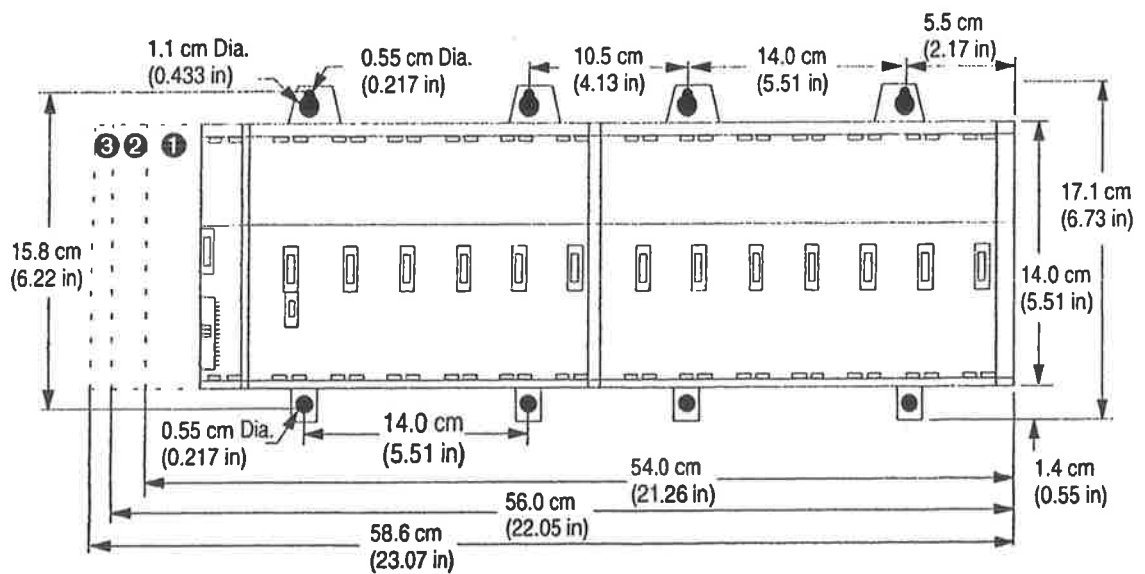
SLC 500 AC Power Supply

1746-A4, -A7, -A10, -A13 Series B

1746-A10



1746-A13



- ① Dimensions with 1746-P1 power supply.
- ② Dimensions with 1746-P2, 1746-P3, or 1746-P5 power supply.
- ③ Dimensions with 1746-P4 power supply.

Installation Instructions

SLC 500 Modular Chassis

1746-A4, -A7, -A10, -A13 Series B

Specifications

SLC Chassis, Series B

1746-A4

1746-A7

1746-A10

1746-A13

dimensions (with tabs)— W x H x D

17.7 x 17.1 x 14.5 cm
(7.1 x 6.8 x 5.8 in)

28.2 x 17.1 x 14.5 cm
(11.3 x 6.8 x 5.8 in)

39.7 x 17.1 x 14.5 cm
(15.9 x 6.8 x 5.8 in)

50.2 x 17.1 x 14.5 cm
(20.1 x 6.8 x 5.8 in)

approximate weight (without modules)

0.75 kg (1.7 lbs)

1.1 kg (2.4 lbs)

1.45 kg (3.2 lbs)

1.9 kg (4.2 lbs)

maximum backplane current

5.1V dc @ 10A;
24V dc @ 2.88A

5.1V dc @ 10A;
24V dc @ 2.88A

5.1V dc @ 10A;
24V dc @ 2.88A

5.1V dc @ 10A;
24V dc @ 2.88A

module slots

4

7

10

13

type of mount

panel mount

panel mount

panel mount

panel mount

operating conditions

operating temperature:

0° to 60°C (32° to 140°F)

storage temperature:

-40° to 85°C (-40° to 185°F)

relative humidity:

5 to 95% (without condensation)

certification



LISTED IND. CONT. EQ.
FOR HAZ. LOC A196



OPERATING
TEMPERATURE
CODE T3C



CE compliant for all
applicable directives

CLASS I, GROUPS A, B, C, AND D, DIV. 2





SLC 5/03™, 5/04™, and 5/05™ Modular Processors

(Catalog Numbers 1747-L531, 1747-L532, 1747-L541, 1747-L542,
1747-L543, 1747-551, 1747-552, 1747-553)

Installation Instructions

To	Use Publication
Install your chassis Installation du châssis Installation des Chassis Installazione dello chassis Instalar el chasis Instalar o chassi	1746-5.8
Install your power supply Installation de l'alimentation Installation des Netzteils Installazione dell'alimentatore Instalar la fuente de alimentación eléctrica Instalar a fonte de energia	1746-5.1
Install your processor Installation du processeur Installation des Prozessors Installazione del processore Instalar el procesador Instalar o processador	1747-5.27



English Section

SLC 5/03™, 5/04™, and 5/05™ Modular Processors

(Catalog Numbers 1747-L531, 1747-L532, 1747-L541,
1747-L542, 1747-L543, 1747-L551, 1747-L552, 1747-L553)

Installation Instructions

Inside ...	page
Important User Information	2
For More Information	3
Required Tools and Equipment	4
Safety Considerations	4
Installation Procedure	5
Troubleshooting	9
Specifications	9
Battery Handling, Storing, and Transporting	11

Important User Information

Because of the variety of uses for the products described in this publication, those responsible for the application and use of this control equipment must satisfy themselves that all necessary steps have been taken to assure that each application and use meets all performance and safety requirements, including any applicable laws, regulations, codes and standards.

The illustrations, charts, sample programs and layout examples shown in this guide are intended solely for purposes of example. Since there are many variables and requirements associated with any particular installation, Allen-Bradley does not assume responsibility or liability (to include intellectual property liability) for actual use based upon the examples shown in this publication.

Allen-Bradley publication SGI-1.1, *Safety Guidelines for the Application, Installation, and Maintenance of Solid-State Control* (available from your local Allen-Bradley office), describes some important differences between solid-state equipment and electromechanical devices that should be taken into consideration when applying products such as those described in this publication.

Reproduction of the contents of this copyrighted publication, in whole or in part, without written permission of Allen-Bradley Company, Inc., is prohibited.

Throughout these installation instructions we use notes to make you aware of safety considerations:



ATTENTION: Identifies information about practices or circumstances that can lead to personal injury or death, property damage or economic loss.

Attention statements help you to:

- identify a hazard
- avoid the hazard
- recognize the consequences

Important: Identifies information that is critical for successful application and understanding of the product.



For More Information

As part of our effort to preserve, protect, and improve our environment, Allen-Bradley is reducing the amount of paper we use. Less paper means more options for you. In addition to traditional printed publications and CD-ROM versions, we now offer on-line manuals with the most up-to-date information you can get. We recommend that you read the related publications listed below before starting up your control system.

Related Publications

For	Refer to this Document	Pub. No.
A more detailed description on how to install and use your modular SLC 500 system.	SLC 500 Modular Hardware Style Installation and Operation Manual	1747-6.2
A reference manual that contains status file data, instruction set, and troubleshooting information.	SLC 500 and MicroLogix 1000 Instruction Set Reference Manual	1747-6.15
A CD-ROM containing both of the manuals listed above, plus the: <ul style="list-style-type: none"> • SLC 500 Analog I/O Modules User Manual • Discrete I/O Modules Installation Instructions • Discrete I/O Modules Product Data 	SLC 500 Literature Collection on CD-ROM	1747-CD1-1

How to Get More Information

For	Obtain Information By
Fast response to a specific question	<ul style="list-style-type: none"> • Visiting the Automation Bookstore at http://www.theautomationbookstore.com — Electronic versions of our manuals are available for you to search and download. • Calling (440) 646-5436 for the Allen-Bradley Fax Back service. You will be faxed information on the topic you request.
Publications in printed or CD-ROM format	Ordering a manual or CD-ROM using one of the following methods: <ul style="list-style-type: none"> • Fill out and return the User Manual Request Card that was shipped with the processor. • Visiting the Automation Bookstore at http://www.theautomationbookstore.com
Multiple copies of a manual	<ul style="list-style-type: none"> • Visiting the Automation Bookstore at http://www.theautomationbookstore.com

Required Tools and Equipment

- medium blade screwdriver
- programming equipment
- a 1747-PIC, 1784-KTX, or 1784-PCMK communication interface (or standard Ethernet PC board – SLC 5/05 only)

Safety Considerations



ATTENTION: Never install, remove, or wire any module while power is applied. Also, do not expose processor modules to surfaces or other areas that may typically hold an electrostatic charge. Electrostatic charges can alter or destroy memory.

For general recommendations concerning installation safety requirements and safety related work practices, refer to the requirements specific to your region.

- *Europe:* Reference the standards found in EN 60204 and your national regulations.
- *United States:* refer to NFPA 70E, *Electrical Safety Requirements for Employee Workplaces*.

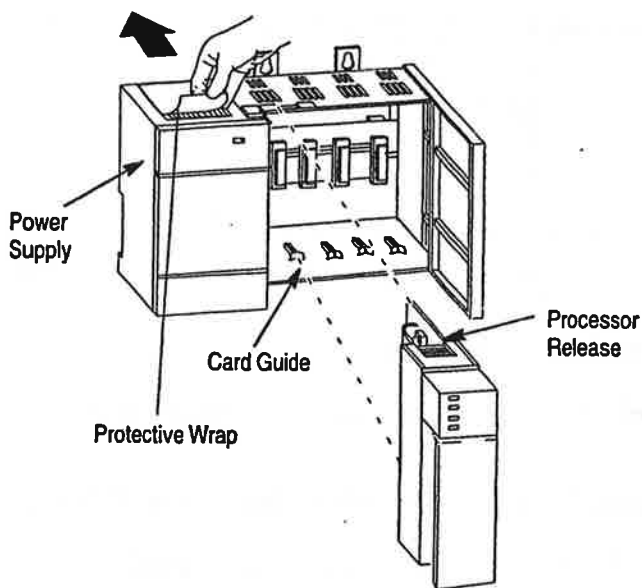
Important: See page 11 for information on proper battery handling, storage, and transporting.

Installation Procedure

Install the Processor

Make sure system power is off; then insert the processor into slot 0 of the 1746 chassis.

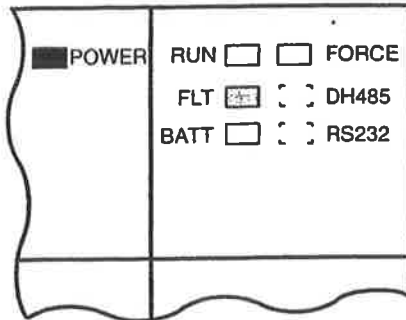
Important: The SLC 500 modular processors must be inserted into the left slot (slot 0), as shown below. In addition, remove the protective wrap after installing the processor.



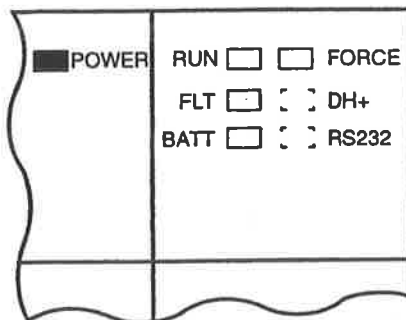
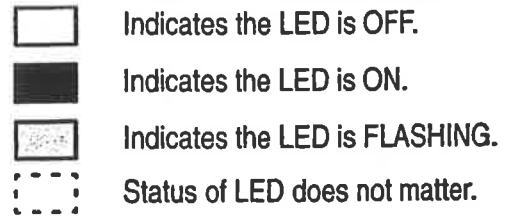
Apply Power to the Processor

1. Energize the chassis power supply.
2. Check the chassis power supply and processor LEDs. The power LED on the power supply should be on and the fault LED on the processor should be flashing. See the figure on page 6 for location of the power supply and processor LEDs.

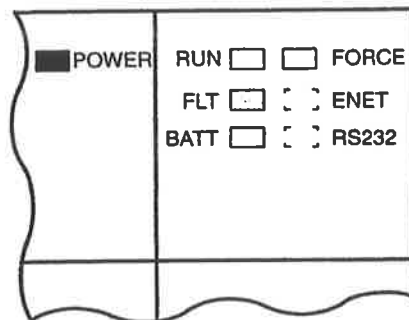
Power supply and LED Indicators



SLC 5/03



SLC 5/04



SLC 5/05

Load Your Software

Refer to your programming software documentation.

Establish Communication to the Processor

1. Refer to the following table to establish communication between the processor and your personal computer.

Processor	Procedure
SLC 5/03	Connect 1747-PIC from the processor to your personal computer or a 1747-CP3 cable from channel 0 of the processor to the personal computer serial port.
SLC 5/04	Connect a 1747-CP3 cable from channel 0 of the processor to the personal computer serial port or use a 1784-KT, 1784-KTX, 1784-KT2, or 1784-PCMCK card.
SLC 5/05	Connect a 1747-CP3 cable from channel 0 of the processor to the personal computer serial port or use a 1784-KT, 1784-KTX, 1784-KT2, or -PCMCK card. For Ethernet connection, connect channel 1 of the processor and the PC Ethernet Card (or 1784-PCMCK) to an Ethernet hub using 10Base-T cable.

2. Set the communication parameters of the software to match the default parameters of the processor:

Channel 0 Configuration	Channel 1 Configuration		
SLC 5/03, 5/04, 5/05	SLC 5/03	SLC 5/04	SLC 5/05
DF1 Full-Duplex: no handshaking 1200 baud (SLC 5/05 – 19.2K) CRC Error Check duplicate detect on no parity	DH-485: 19.2K baud node address = 1	DH+™: 57.6K baud node address = 1	Ethernet

Replacing the Battery

Your SLC processor provides back-up power for RAM through a replaceable lithium battery. This battery provides back-up for approximately 2 years. The BATT LED on the front of the processor alerts you when the battery voltage has fallen below a threshold level.

To replace the lithium battery follow these steps:



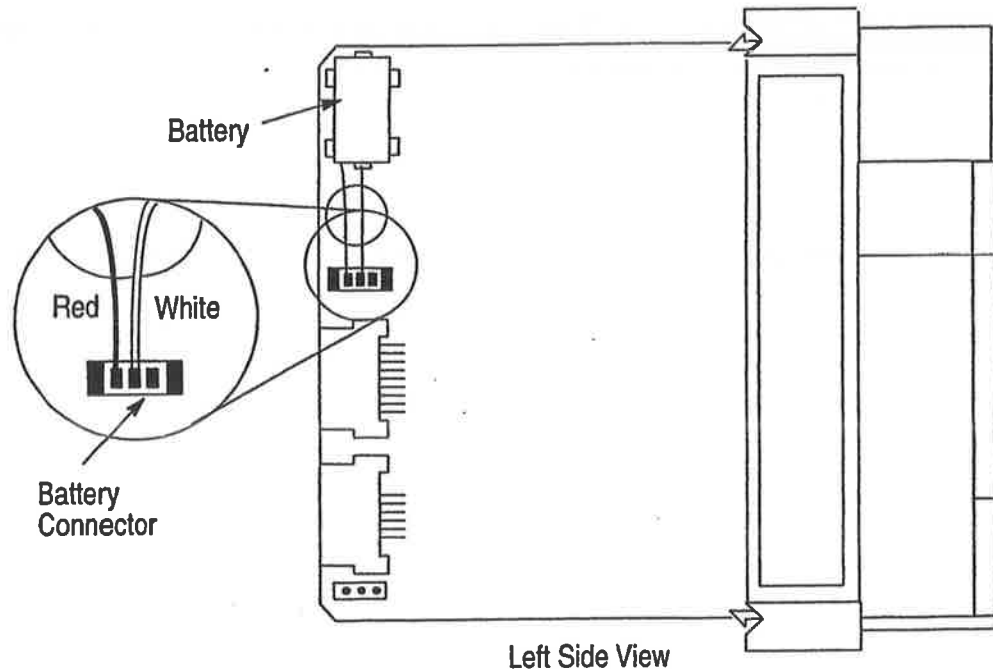
ATTENTION: Do not remove the processor from the SLC 500 chassis until all power is removed from the SLC 500 power supply.

1. Remove power from the SLC 500 power supply.
2. Remove the processor from the chassis by pressing the retainer clips at both the top and bottom of the module and slide it out.



ATTENTION: Do not expose the processor to surfaces or other areas that may typically hold an electrostatic charge. Electrostatic charges can alter or destroy memory.

3. Unplug the battery connector. Refer to the figure on page 8 for battery connector location.



Important: The SLC 5/03, 5/04, and 5/05 processors have a capacitor that provides at least 30 minutes of battery back-up while the battery is disconnected. Data in RAM is not lost if the battery is replaced within 30 minutes.

4. Remove the battery from the retaining clips.
5. Insert a new battery into the battery retaining clips.
6. Plug the battery connector into the socket as shown above.
7. Re-insert the module into the SLC 500 chassis.
8. Restore power to the SLC 500 power supply.
9. Close the processor door.

Important: See page 11 for information on proper battery handling, storage, and transporting.

Troubleshooting

Before troubleshooting your SLC 500 system, please obtain an SLC 500 Modular Hardware Style Installation and Operation Manual (1747-6.2) from one of the sources listed on page 3. Refer to the chapter on Troubleshooting.

In addition to the SLC 500 Modular Hardware Style Installation and Operation Manual, the SLC 500 and MicroLogix 1000 Instruction Set Reference Manual (1747-6.15) may also be obtained from the sources listed on page 3. This manual contains explanations and examples for the entire instruction set as well as for all status words and bits. It also contains explanations for all possible fault codes found in status word S:6.

Specifications

Operating Specifications

Specification for 1747-	SLC 5/03		SLC 5/04			SLC 5/05		
	L531	L532	L541	L542	L543	L551	L552	L553
Memory (words)	8K	16K	16K	32K	64K	16K	32K	64K
Maximum I/O Capacity	4096 discrete inputs / 4096 discrete outputs							
Max. Local System	3 chassis / 30 slots							
Programming Instructions	99							
Typical Scan Time ^①	1 ms/K		0.9 ms/K					
Bit Execution (XIC)	0.44 μs		0.37 μs					
Programming Software	SLC 5/03s and SLC 5/04s: RSLogix 500™, PLC-500 A.I. Series™ SLC 5/05s: RSLogix 500™							

① The scan times are typical for a 1K ladder logic program consisting of simple ladder logic and communication servicing. Actual scan times depend on your program size, instructions used, and the communication protocol.

Communication

Communication options for the SLC 5/03, 5/04, and 5/05 processors are as follows:

- DH-485
- RS-232 protocols (DF1 Full-Duplex, DF1 Half-Duplex “master/slave”, DH-485, or ASCII)
- Data Highway Plus™ (A 1785-KA5 is required for the SLC 5/03 and SLC 5/05 processors.)
- Ethernet TCP/IP (SLC 5/05 only)

General Specifications

Description	Specification
Power Supply Loading at 5V dc	500 mA for the SLC 5/03 processor
	1.0 A for the SLC 5/04 and 5/05 processors
Power Supply Loading at 24V dc	175 mA for the SLC 5/03 processor
	200 mA for the SLC 5/04 and 5/05 processors
Program Scan Hold-up Time after Loss of Power	20 ms to 3 s (dependent on power supply loading)
Noise Immunity	NEMA Standard ICS 2-230
Vibration	Displacement: 0.015 inch, peak-to-peak at 5-57 Hz
	Acceleration: 2.5Gs at 57-2000 Hz
Shock (operating)	30Gs
Ambient Temperature Rating	Operating: 0 to +60°C (+32°F to +140°F) Storage: -40°C to +85°C (-40°F to +185°F)
Humidity	5 to 95% without condensation
Agency Certification	UL listed CSA approved Class 1, Groups A, B, C or D, Division 2 CE compliant for all applicable directives

Memory Back Up

The following table shows the memory back up options for the SLC 5/03, 5/04, and 5/05 processors. Flash EPROMs (Flash Erasable Programmable Read Only Memory) combine the versatility of EEPROMs (Electrically-Erasable Programmable Read Only Memory) with the security of UVEPROMs (UV-Erasable PROM).

Memory Back Up Option	SLC 5/03 (1747-L531, -L532)	SLC 5/04 (1747-L541, -542, -543)	SLC 5/05 (1747-L551, -552, -553)
Flash EPROM	1747-M11 1747-M12 (OS302 only)	1747-M11 1747-M12 (OS401 only)	1747-M11 1747-M12

Battery Handling, Storing, and Transporting (Cat. No. 1747-BA)

Handling



ATTENTION: Do not charge the batteries. An explosion could result or the cells could overheat causing burns.

Do not open, puncture, crush, or otherwise mutilate the batteries. An explosion may result and/or toxic, corrosive, and flammable liquids would be exposed.

Do not incinerate or expose the batteries to high temperatures. An explosion could result.

Do not short positive and negative terminals. Excessive heat can build up causing severe burns.

Storing

Store the lithium batteries in a cool, dry environment, typically +20°C to +25°C (+68°F to +77°F) and 40% to 60% relative humidity.

Transporting

One or Two Batteries — Up to two batteries can be shipped together within the United States without restriction. Regulations governing shipment to or within other countries may differ.

Three or More Batteries — Procedures for the transportation of three or more batteries shipped together within the United States are specified by the Department of Transportation (DOT) in the Code of Federal Regulations, CFR49, "Transportation." An exemption to these regulations, DOT - E7052, covers the transport of certain hazardous materials classified as flammable solids. This exemption authorizes transport of lithium batteries by motor

vehicle, rail freight, cargo vessel, and cargo-only aircraft, providing certain conditions are met. Transport by passenger aircraft is not permitted.

Shipment of depleted batteries for disposal may be subject to specific regulation of the countries involved or to regulations endorsed by those countries, such as the IATA Restricted Articles Regulations of the International Air Transport Association, Geneva, Switzerland.

Important: Regulations for transportation of lithium batteries are periodically revised.



ATTENTION: Do not incinerate or dispose of lithium batteries in general trash collection. Explosion or violent rupture is possible. Batteries should be collected for disposal in a manner to prevent against short circuiting, compacting, or destruction of case integrity and hermetic seal.

For disposal, batteries must be packaged and shipped in accordance with transportation regulations, to a proper disposal site. The U.S. Department of Transportation authorizes shipment of "Lithium batteries for disposal" by motor vehicle only in regulation 173.1015 of CFR 49 (effective January 5, 1983). For additional information contact:

U.S. Department of Transportation
Research and Special Programs Administration
400 Seventh Street, S.W.
Washington, D.C. 20590

Although the Environmental Protection Agency at this time has no regulations specific to lithium batteries, the material contained may be considered toxic, reactive, or corrosive. The person disposing of the material is responsible for any hazard created in doing so. State and local regulations may exist regarding the disposal of these materials.

For a lithium battery material safety data sheet, contact the manufacturer:

Sanyo Energy Corporation
600 Supreme Drive
Bensenville, IL 60106

SLC 500, SLC 5/03, SLC 5/04, SLC 5/05 and Data Highway Plus are trademarks of Rockwell Automation.
RSLogix 500 and PLC-500 A.I. Series are trademarks of Rockwell Software, Inc.
Ethernet is a registered trademark of Digital Equipment Corporation, Intel, and Xerox Corporation.

 **Rockwell Automation**

Allen-Bradley

Worldwide representation.



Argentina • Australia • Austria • Bahrain • Belgium • Brazil • Bulgaria • Canada • Chile • China, PRC • Colombia • Costa Rica • Croatia • Cyprus • Czech Republic • Denmark • Ecuador • Egypt • El Salvador • Finland • France • Germany • Greece • Guatemala • Honduras • Hong Kong • Hungary • Iceland • India • Indonesia • Ireland • Israel • Italy • Jamaica • Japan • Jordan • Korea • Kuwait • Lebanon • Malaysia • Mexico • Netherlands • New Zealand • Norway • Pakistan • Peru • Philippines • Poland • Portugal • Puerto Rico • Qatar • Romania • Russia-CIS • Saudi Arabia • Singapore • Slovakia • Slovenia • South Africa, Republic • Spain • Sweden • Switzerland • Taiwan • Thailand • Turkey • United Arab Emirates • United Kingdom • United States • Uruguay • Venezuela • Yugoslavia

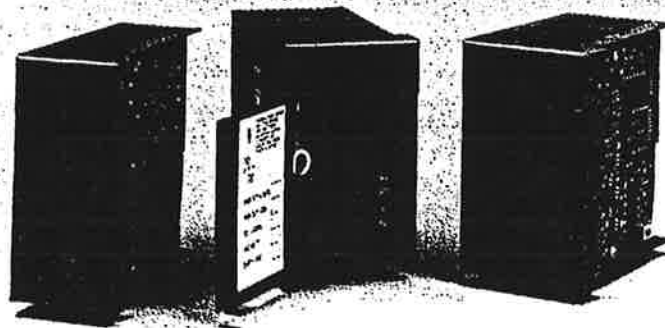
Allen-Bradley Headquarters, 1201 South Second Street, Milwaukee, WI 53204 USA
Tel: (1) 414 382-2000 Fax: (1) 414 382-4444



SLC 500™ Power Supplies

(Catalog Numbers 1746-P1, 1746-P2, 1746-P3, 1746-P4,
1746-P5 and 1746-P6)

Installation Instructions



91-071-3

Inside ...	page
English Section	1

5

Important User Information

Because of the variety of uses for the products described in this publication, those responsible for the application and use of this control equipment must satisfy themselves that all necessary steps have been taken to assure that each application and use meets all performance and safety requirements, including any applicable laws, regulations, codes and standards.

The illustrations, charts, sample programs and layout examples shown in this guide are intended solely for purposes of example. Since there are many variables and requirements associated with any particular installation, Allen-Bradley does not assume responsibility or liability (to include intellectual property liability) for actual use based upon the examples shown in this publication.

Allen-Bradley publication SGI-1.1, *Safety Guidelines for the Application, Installation, and Maintenance of Solid-State Control* (available from your local Allen-Bradley office), describes some important differences between solid-state equipment and electromechanical devices that should be taken into consideration when applying products such as those described in this publication.

Reproduction of the contents of this publication, in whole or in part, without written permission of the Allen-Bradley Company is prohibited.

Throughout these installation instructions we use notes to make you aware of safety considerations:



ATTENTION: Identifies information about practices or circumstances that can lead to personal injury or death, property damage, or economic loss.

Attention statements help you to:

- identify a hazard
- avoid the hazard
- recognize the consequences

Important: Identifies information that is critical for successful application and understanding of the product.



SLC 500™ Power Supplies

(Catalog Numbers 1746-P1, 1746-P2, 1746-P3, 1746-P4,
1746-P5 and 1746-P6)

Installation Instructions

Overview

Install your power supply using these installation instructions. The only tools you require are a Flat head (1/8") and a Phillips head (1/4", #2) screwdriver.



ATTENTION: Electrostatic discharge can damage integrated circuits or semiconductors if you touch backplane connector pins. Follow these guidelines when you handle the power supplies.

- Touch a grounded object to discharge static potential.
- Do not touch the backplane connector or connector pins.
- Do not touch circuit components inside the power supply.
- If available, use a static-safe work station.
- When not in use, keep the power supplies in their static-shield packaging.

Safety Considerations

This equipment is suitable for use in Class I, Division 2, Groups A, B, C, D or non-hazardous locations only.

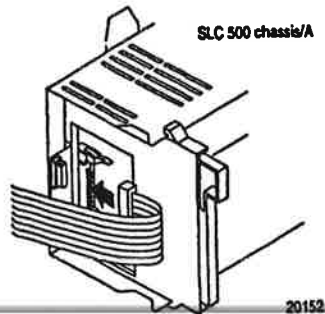


ATTENTION – Explosion Hazard:

- Substitution of components may impair suitability for Class I, Division 2.
- Do not replace components or disconnect equipment unless power has been switched off and the area is known to be non-hazardous.
- Do not connect or disconnect connectors while circuit is live unless area is known to be non-hazardous.

Install the Chassis Interconnect Cable (Optional)

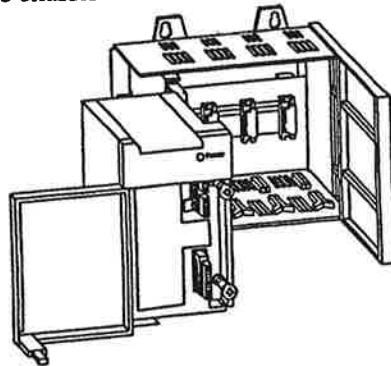
To connect up to three SLC 500™ chassis together, install the chassis interconnect cable before installing the 1746-P1, -P2, -P3, -P4, -P5 and -P6 power supplies.



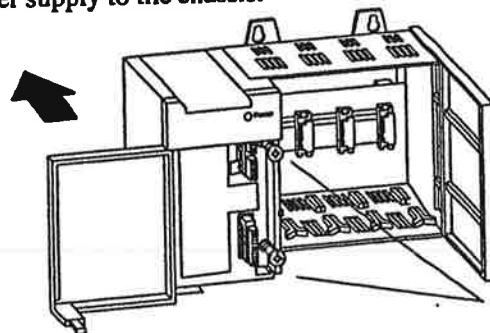
For more information, see the
*SLC 500 Modular Style
Installation and Operation Manual*
(publication 1747-6.2).

Power Supply Installation

1. Align the circuit board of the power supply with the card guides on the left side of the chassis.



2. Slide the power supply in until it is flush with the chassis. Then fasten the power supply to the chassis.



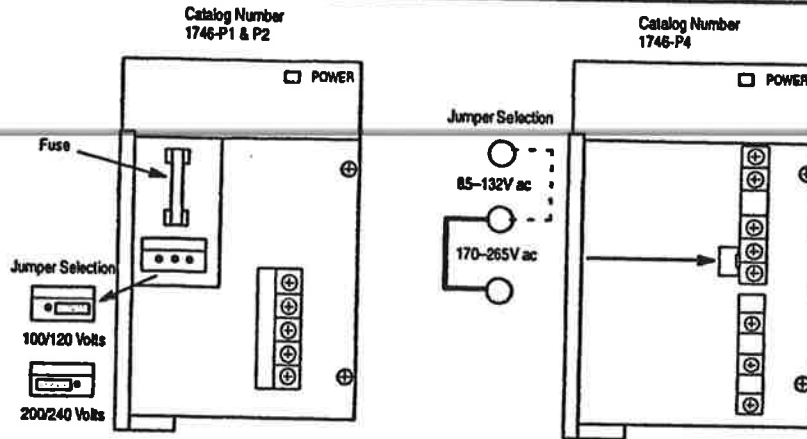
Use these screws to fasten the
power supply to the chassis.

Power Supply Wiring

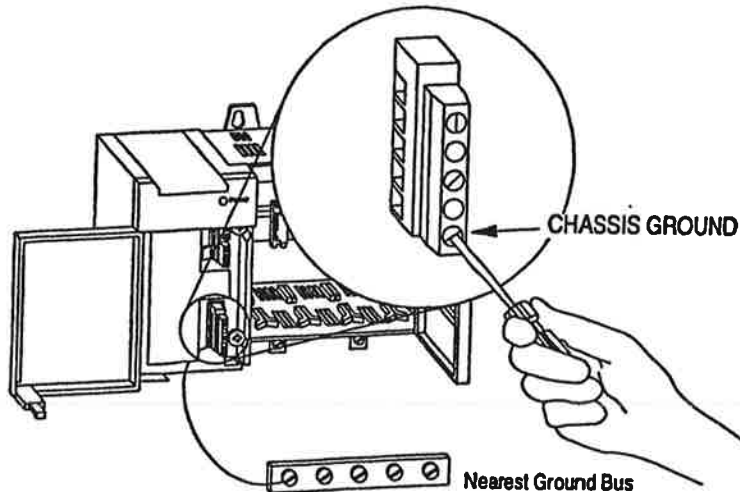
1. Place the input voltage jumper to match the input voltage. (This does not apply to the 1746-P3, -P5 and -P6 power supplies which do not have a jumper.)



ATTENTION: Set the input voltage jumper before applying power. Hazardous voltage is present on exposed pins when power is applied; contact with the pin may cause injury to personnel.



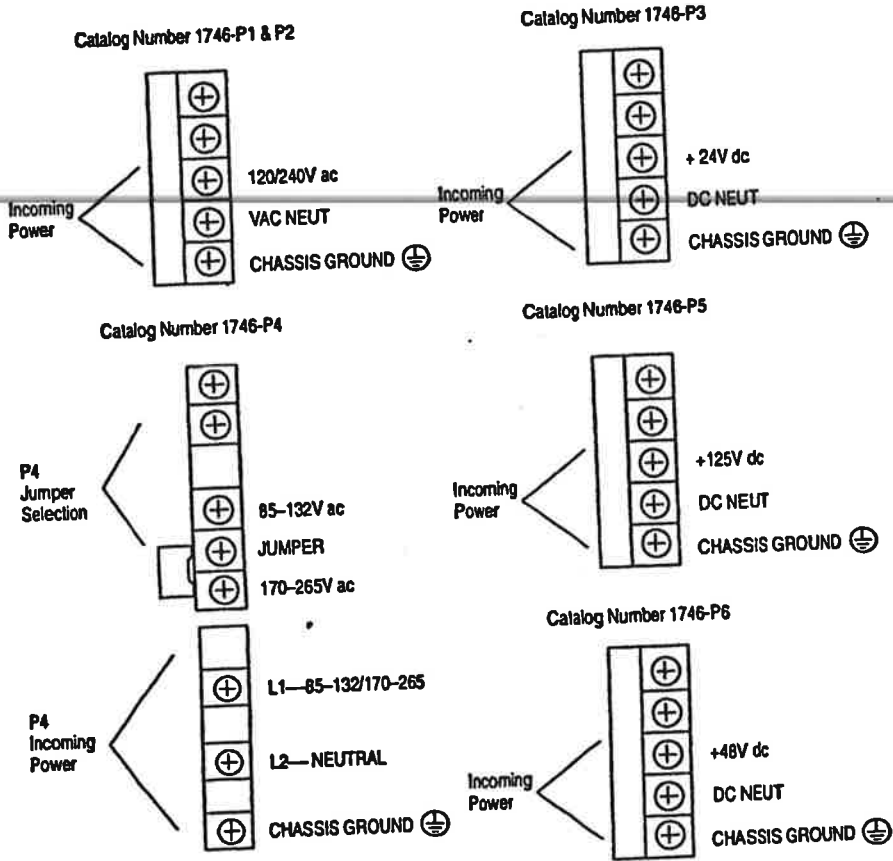
2. Connect the ground screw of the power supply to the nearest ground or ground bus. Use a #14 AWG wire and keep the leads as short as possible. The 1746-P4 is shown below. Refer to page 6 for special wiring considerations for the 1746-P3.



3. Connect incoming power.

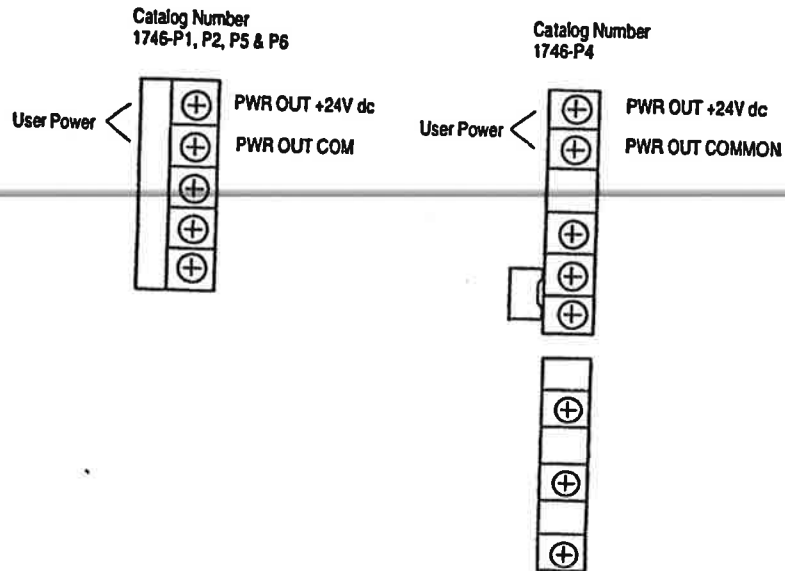


ATTENTION: Turn off incoming power before connecting wires; failure to do so could cause injury to personnel and/or equipment.



ATTENTION: Your SLC 500 power supply can be damaged by voltage surges when switching inductive loads such as motors, motor starters, solenoids, and relays. To avoid damage to your SLC 500 power supply in these applications, it is strongly recommended that an isolation transformer be used to isolate the power supply from harmful voltage surges.

4. (Optional) For the 1746-P1, -P2, -P4, -P5 and -P6 power supplies, use PWR OUT +24V dc and PWR OUT COM terminals to power 24V dc sensors and loads. The terminals on the 1746-P1 and 1746-P2 provide an isolated, nonfused 200 mA, 24V dc power supply. The terminals on the 1746-P4 provide an isolated, nonfused 1A, 24V dc power supply. (The 1746-P3 power supply does not provide for an external power source.)



SLC 500 Operation with 24V dc User Power Overcurrent Condition

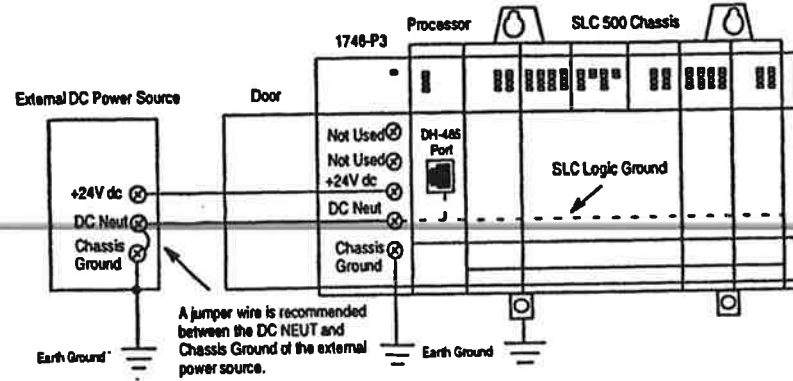
Catalog No.	SLC Operation	Recovery Procedure
1746-P1 Series A	P/S shutdown, CPU Fault	Reload user program
1746-P2 Series A, B	P/S shutdown, CPU Fault	Reload user program
1746-P2 Series C	24V dc user shutdown, CPU continues	Correct overcurrent condition
1746-P4 Series A	P/S shutdown, CPU Fault	Reload user program
1746-P5 Series A	24V dc user shutdown, CPU continues	Correct overcurrent condition
1746-P6 Series A	24V dc user shutdown, CPU continues	Correct overcurrent condition



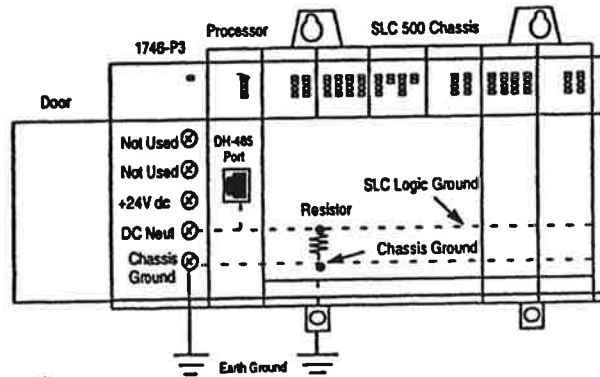
ATTENTION: For 1746-P2 Series C, 1746-P5 Series A and 1746-P6 Series A to avoid unexpected operation due to 24V dc user power shutdown, monitor the 24V dc user output with a 24V dc input channel.



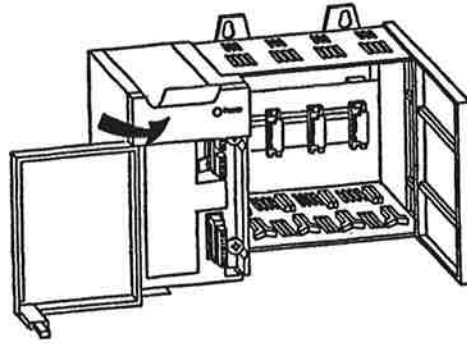
ATTENTION: Any voltage applied to the 1746-P3 DC NEUT terminal will be present at the SLC logic ground and the processor DH-485 port. To prevent unwanted potentials across the logic ground of the controller and/or damage to the SLC chassis, the DC NEUTRAL of the external DC power source must be either isolated from the SLC chassis ground, or connected to earth ground.



Important: SLC 500 Series A chassis (1746-A4, -A7, -A10, and -A13) manufactured *before* November 1992 have a resistor between the logic ground and chassis ground. This resistor could be damaged if the wiring recommendation described within the attention box above is not followed. See the figure below for the location of the resistor. SLC 500 Series A chassis (1746-A4, -A7, -A10, and -A13) with a manufacture date of November 1992 or later do not have this resistor. SLC 500 Series B chassis have a $1M\Omega$ resistor that limits the current between logic ground and chassis ground.



5. Remove the protective label.



20152

Physical Dimensions

Controller: 1746-	Length: mm (in.)	Depth: mm (in.)	Height: mm (in.)
P1	65 (2.56)	140 (5.51)	140 (5.51)
P2	85 (3.35)		
P3			
P4	110 (4.33)	145 (5.70)	
P5	85 (3.35)	140 (5.51)	
P6			

General Specifications

Description:	Specification: 1746-					
	P1	P2	P3	P4	P5	P6
Line Voltage	85-132/ 170-265V ac 47-63 Hz	85-132/ 170-265V ac 47-63 Hz	19.2-28.8V dc	85-132/ 170-265V ac 47-63 Hz	90-146V dc	30-60V dc
Typical Line Power Requirement	135 VA	180 VA	90 VA	240 VA	85 VA	100 VA
Maximum Inrush Current	20A	20A	20A	45A	20A	20A
Internal Current Capacity	2A at 5V dc 0.46A at 24V dc	5A at 5V dc 0.96A at 24V dc	3.6A at 5V dc 0.87A at 24V dc	10.0A at 5V dc 2.88A at 24V dc ^①	5A at 5V dc 0.96A at 24V dc	5A at 5V dc 0.96A at 24V dc
Fuse Protection ^②	1746-F1 or equivalent ^③	1746-F2 or equivalent ^④	1746-F3 or equivalent ^⑤	Fuse is soldered in place.		
24V dc User Power Current Capacity	200 mA	200 mA	Not Applicable	1A ^①	200 mA	200 mA
24V dc User Power Voltage Range	18-30V dc	18-30V dc	Not Applicable	20.4-27.6V dc	18-30V dc	18-30V dc
Ambient Operating Temperature	0°C to 60°C (32°F to 140°F) ^⑥			0°C to 60°C (32°F to 140°F) no derating	0°C to 60°C (32°F to 140°F) ^⑥	0°C to 60°C (32°F to 140°F) ^⑥
Certification	UL listed C-UL or CSA certified (as indicated by product or packaging markings) CE compliant for all applicable directives					
Hazardous Environment Certification	Class I Division 2					

- ① The combination of all output power (5 volt backplane, 24 volt backplane, and 24 volt user source) cannot exceed 70 Watts.
- ② Power supply fuse is intended to guard against fire hazard due to short circuit conditions. This fuse may not protect the supply from miswiring or excessive transient in the power line.
- ③ Equivalent fuses: 250V-3A Fuse, Nagasawa ULCS-61ML-3, or BUSSMAN AGC 3
- ④ Equivalent fuses: 250V-3A Fuse, SANO SOC SD4, or BUSSMAN AGC 3
- ⑤ Equivalent fuses: 125V-5A Fuse, Nagasawa ULCS-61ML-5, or BUSSMAN AGC 5
- ⑥ Current capacity derated 5% above 55°C



SLC 500™ Modular Chassis

(Cat. No. 1746-A4, -A7, -A10, and -A13 Series B)



Installation Instructions

Inside ...	page
English Section	1

Important User Information

Because of the variety of uses for the products described in this publication, those responsible for the application and use of this control equipment must satisfy themselves that all necessary steps have been taken to assure that each application and use meets all performance and safety requirements, including any applicable laws, regulations, codes and standards.

The illustrations, charts, sample programs and layout examples shown in this guide are intended solely for purposes of example. Since there are many variables and requirements associated with any particular installation, Allen-Bradley does not assume responsibility or liability (to include intellectual property liability) for actual use based upon the examples shown in this publication.

Allen-Bradley publication SGI-1.1, *Safety Guidelines for the Application, Installation, and Maintenance of Solid-State Control* (available from your local Allen-Bradley office), describes some important differences between solid-state equipment and electromechanical devices that should be taken into consideration when applying products such as those described in this publication.

Reproduction of the contents of this publication, in whole or in part, without written permission of the Allen-Bradley Company is prohibited.

Throughout these installation instructions we use notes to make you aware of safety considerations:



ATTENTION: Identifies information about practices or circumstances that can lead to personal injury or death, property damage, or economic loss.

Attention statements help you to:

- identify a hazard
- avoid the hazard
- recognize the consequences

Important: Identifies information that is critical for successful application and understanding of the product.



Supplemental Product Information

CSA Hazardous Location Approval

CSA certifies products for general use as well as for use in hazardous locations. **Actual CSA certification is indicated by the product label as shown below, and not by statements in any user documentation.**

Example of the CSA certification product label



CL 1 DIV 2
GP A,B,C,D
TEMP

To comply with CSA certification for use in hazardous locations, the following information becomes a part of the product literature for CSA-certified Allen-Bradley industrial control products.

- This equipment is suitable for use in Class I, Division 2, Groups A, B, C, D, or non-hazardous locations only.
- The products having the appropriate CSA markings (that is, Class I Division 2, Groups A, B, C, D), are certified for use in other equipment where the suitability of combination (that is, application or use) is determined by the CSA or the local inspection office having jurisdiction.

Important: Due to the modular nature of a PLC® control system, the product with the highest temperature rating determines the overall temperature code rating of a PLC control system in a Class I, Division 2 location. The temperature code rating is marked on the product label as shown.

Temperature code rating



CL 1 DIV 2
GP A,B,C,D
TEMP

← Look for temperature code rating here

The following warnings apply to products having CSA certification for use in hazardous locations.



ATTENTION: Explosion hazard —

- Substitution of components may impair suitability for Class I, Division 2.
- Do not replace components unless power has been switched off or the area is known to be non-hazardous.
- Do not disconnect equipment unless power has been switched off or the area is known to be non-hazardous.
- Do not disconnect connectors unless power has been switched off or the area is known to be non-hazardous. Secure any user-supplied connectors that mate to external circuits on an Allen-Bradley product using screws, sliding latches, threaded connectors, or other means such that any connection can withstand a 15 Newton (3.4 lb.) separating force applied for a minimum of one minute.

PLC is a registered trademark of Allen-Bradley Company, Inc.
CSA logo is a registered trademark of the Canadian Standards Association.



SLC 500 Modular Chassis

(Cat. No. 1746-A4, -A7, -A10, and -A13 Series B)

Installation Instructions

What's in this Publication

Use this publication as a guide when installing a SLC 500™ modular chassis (1746-A4, -A7, -A10, or -A13 series B).

Installation

To:	See page:
↓ prepare for installation	2
↓ allow sufficient mounting space	3
↓ install your chassis	4
↓ ground your chassis	6
↓ install the chassis interconnect cable (optional)	9
↓ install your I/O modules and attach your power supply	9

Reference

For this information:	See page:
➡ mounting dimensions	10
➡ specifications	12

For additional installation information, see the *SLC 500 Modular Style Installation and Operation Manual*, publication 1747-6.2.

Installation Instructions
SLC 500 Modular Chassis
1746-A4, -A7, -A10, -A13 Series B

Prepare for Installation

Make sure you have these items.

M4 or M5 (#10 or #12) Hardware

- phillips screw and star washer (or SEM screw — phillips screw with attached star washer) for chassis mounting tabs

This chassis:	Has:
1746-A4	4 mounting tabs
1746-A7	4 mounting tabs
1746-A10	6 mounting tabs
1746-A13	8 mounting tabs

- phillips screwdriver
- drill

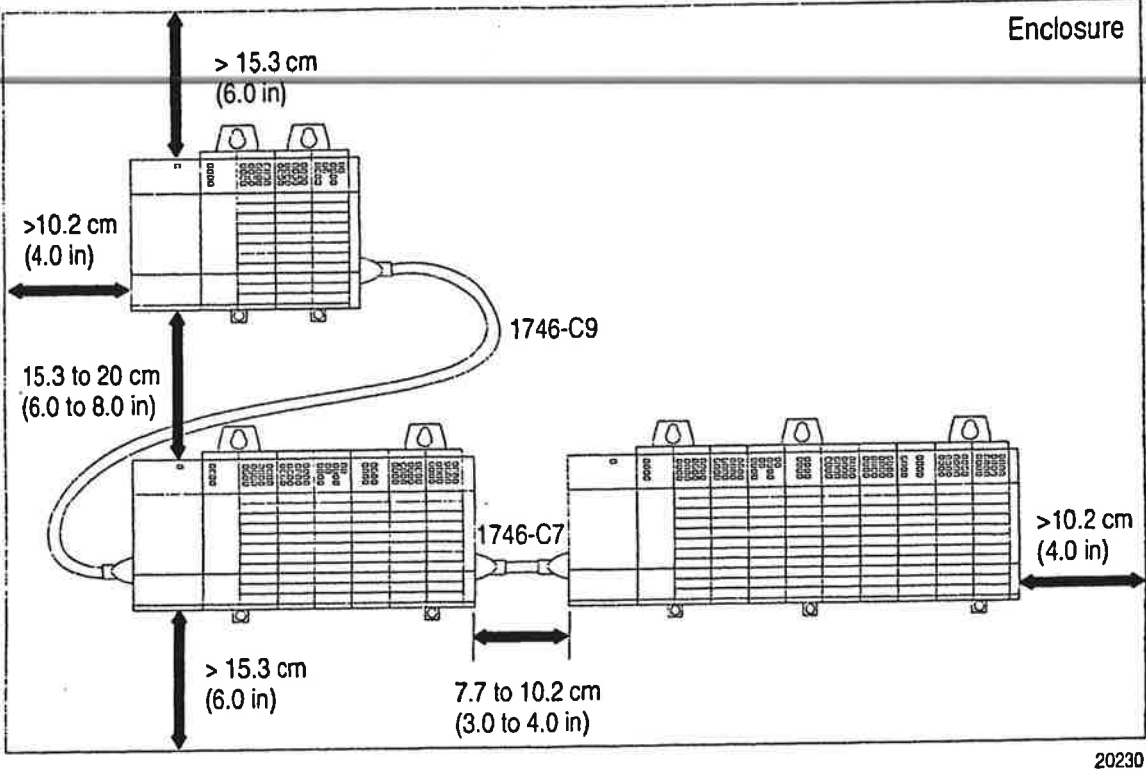
Documentation

For your:

- processor or I/O adapter module
- power supply
- communication modules and/or I/O modules

Allow Sufficient Mounting Space

Important: Make sure you meet these **minimum** spacing requirements. Up to three SLC chassis can be connected (for a maximum of 30 I/O slots).



20230

Important: When vertically connecting two 1746-A13 chassis with a 1746-C9 cable, the space cannot be greater than 15.3 cm (6.0 in) for the cable to reach from chassis to chassis.

For dimensions of:	See page:
left side of all chassis	10
1746-A4, -A7	10
1746-A10, -A13	11

Installation Instructions

SLC 500 Modular Chassis

1746-A4, -A7, -A10, -A13 Series B

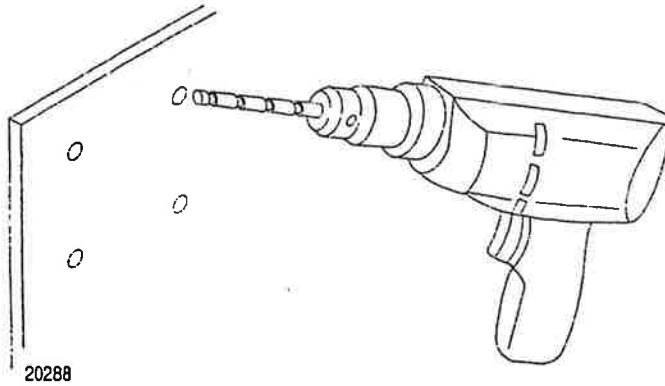
Install Your Chassis

1



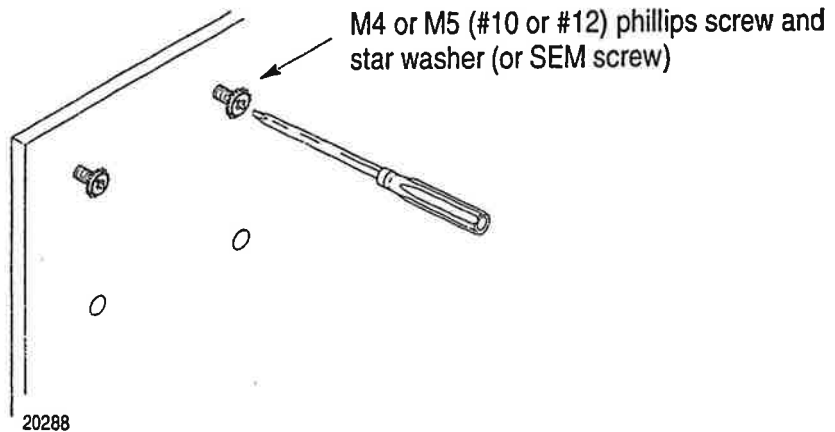
ATTENTION: Be careful of metal chips when drilling mounting holes for the SLC chassis. Do not drill holes above an SLC chassis if a processor and I/O modules are installed.

Drill holes in the back panel of the enclosure for chassis mounting tabs.



2

Install the hardware for the top mounting tabs.



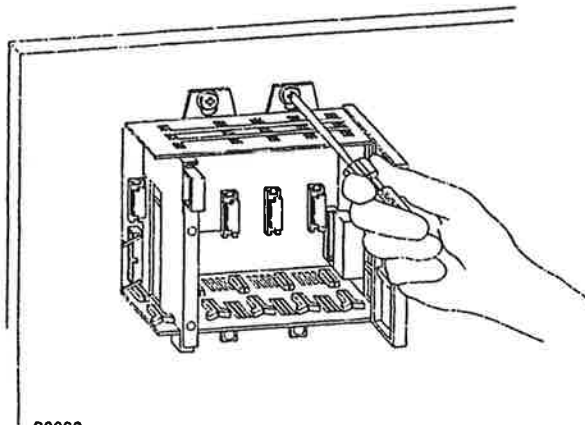
Note: Scrape paint off the back panel for an electrical connection between the chassis and back panel.

3



ATTENTION: If the chassis mounting tabs do not lay flat before the screws are tightened, use additional washers as shims so that the chassis will not be warped by tightening the screws. Warping a chassis could damage the backplane and cause poor connections.

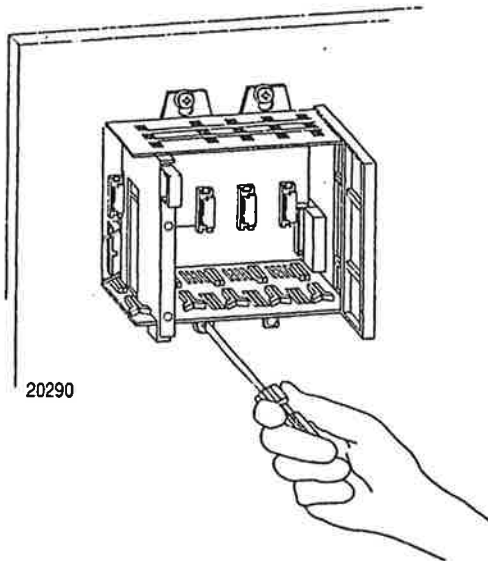
Slide the chassis over the installed hardware and tighten the screws.



20289

4

Leaving far-left and far-right tabs open for grounding, install the remaining tab hardware (for a four-slot chassis, leave both tabs open).



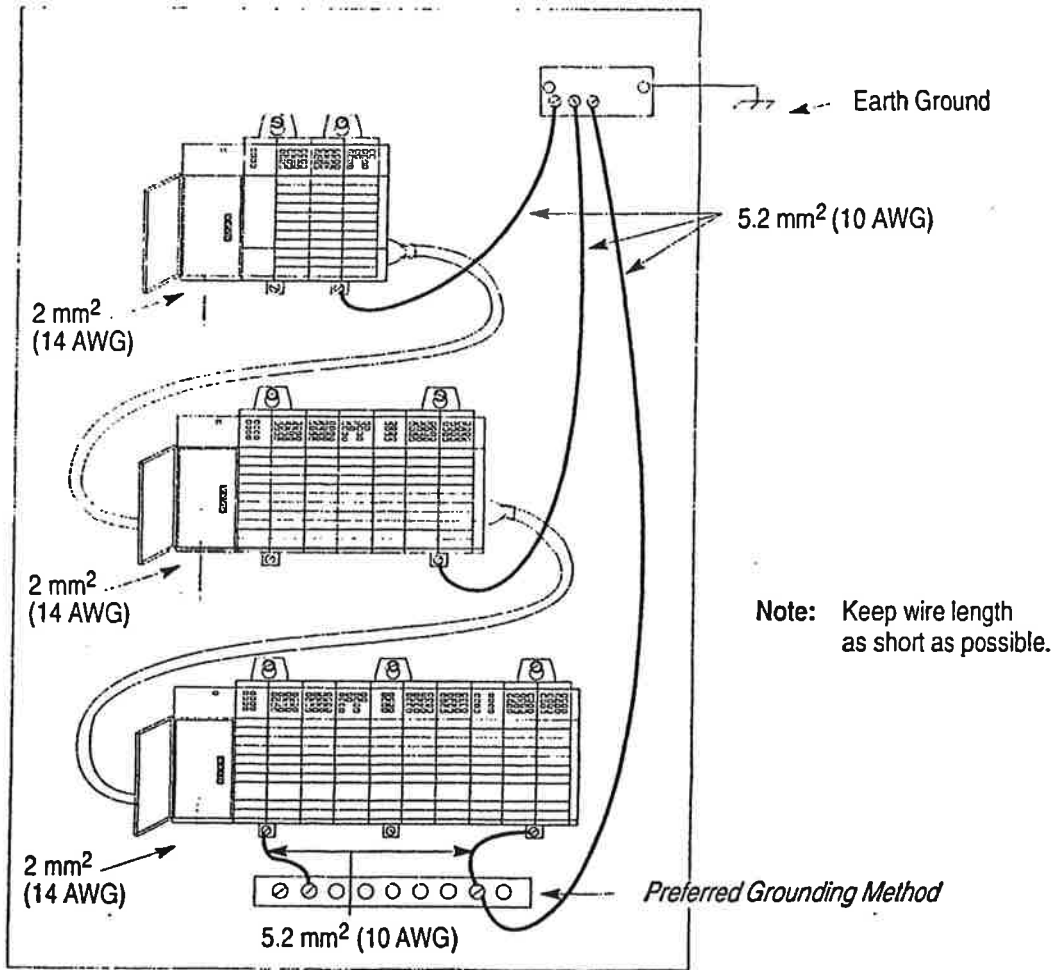
20290

Ground Your Chassis

To properly ground your I/O chassis:	See page:
verify grounding configuration	6
install a central ground bus	7
connect equipment grounding conductor	7
connect equipment grounding conductor to ground bus	8
connect ground bus to grounding-electrode system	8

Verify Grounding Configuration

This figure shows you how to run ground connections from the chassis to the ground bus. Two acceptable grounding methods are shown; we recommend using a ground bus because it reduces the electrical resistance at the connection.

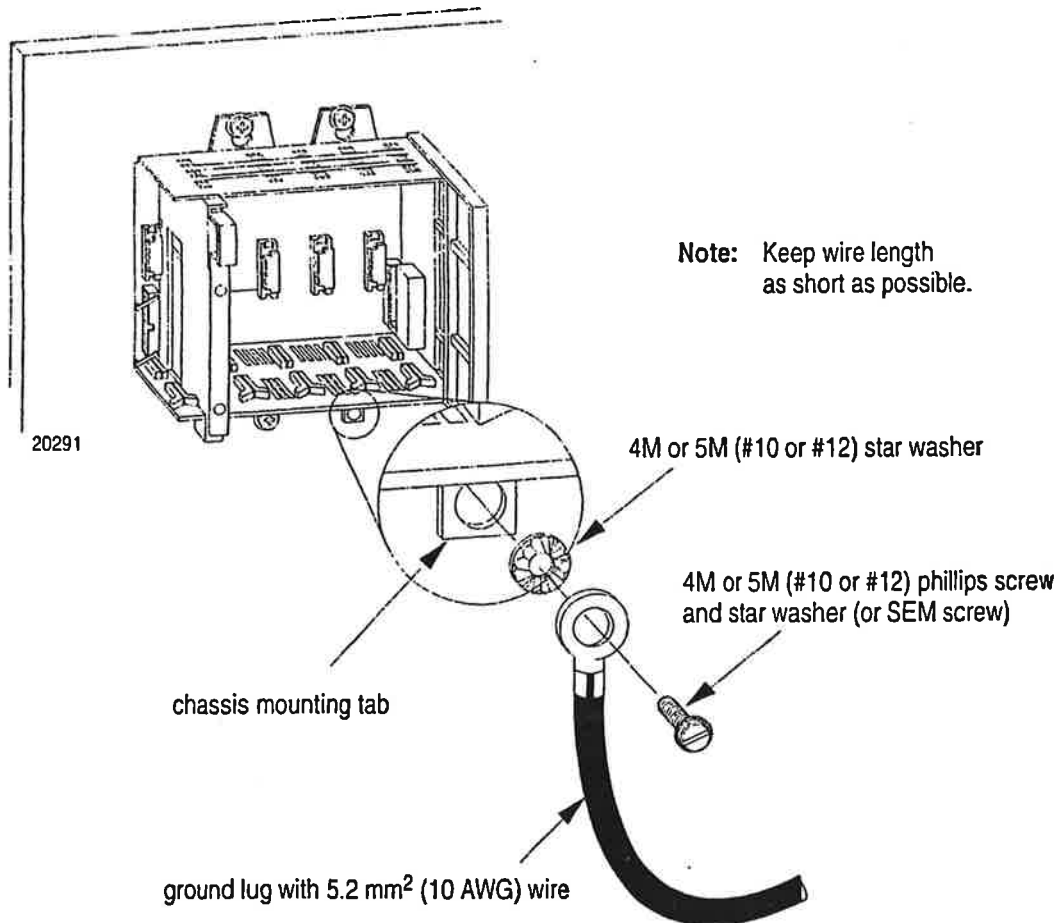


Install a Central Ground Bus

Each enclosure must contain a central ground bus. The ground bus is the common connection for each chassis within the enclosure and the enclosure itself. If you have not already installed a central ground bus, see the *Industrial Automation Wiring and Grounding Guidelines*, publication 1770-4.1.

Connect Equipment Grounding Conductor

Important: Use the following information, along with the installation manual for your programmable controller, to ground the chassis and your I/O modules.



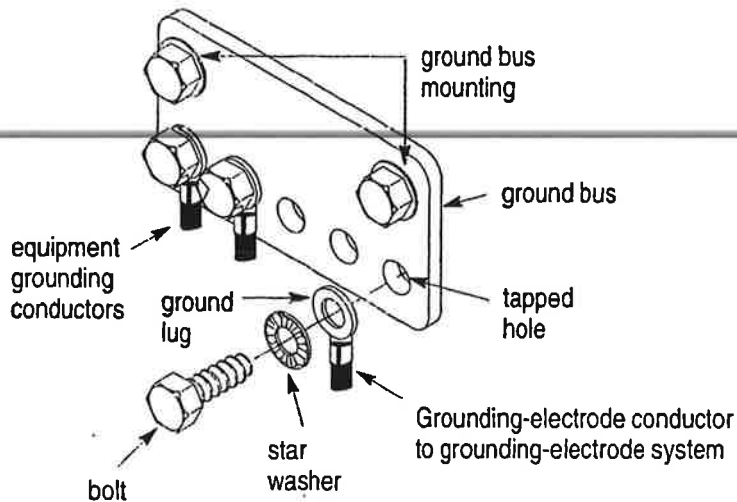
Installation Instructions

SLC 500 Modular Chassis

1746-A4, -A7, -A10, -A13 Series B

Connect Equipment Grounding Conductor to Ground Bus

Connect an equipment grounding conductor directly from each chassis to an individual bolt on the ground bus.



- use 2.54 cm (1 in) copper braid or 5.2 mm² (10 AWG) copper wire to connect each chassis, the enclosure, and a central ground bus mounted on the back-panel
- use a steel enclosure to guard against electromagnetic interference (EMI)
- make sure the enclosure door viewing window is a laminated screen or a conductive optical substrate (to block EMI)
- install a bonding wire for electrical contact between the door and the enclosure; do not rely on the hinge

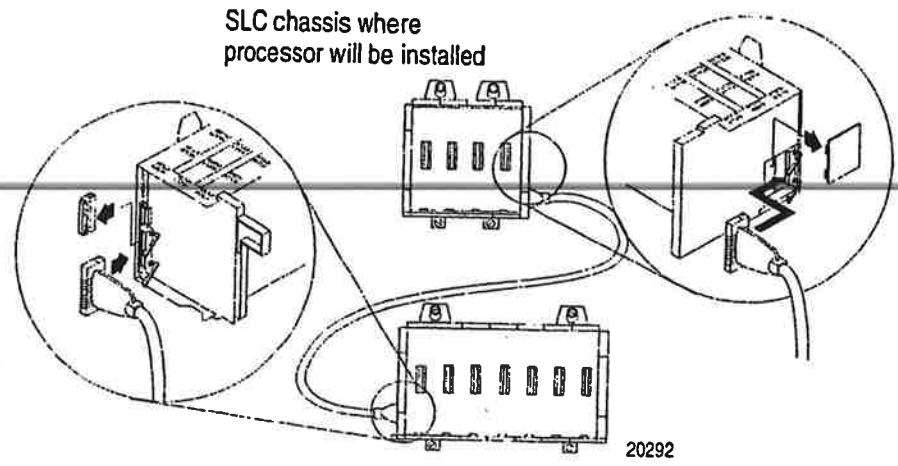
Important: Do not lay one ground lug directly on top of the other; this type of connection can become loose **due to compression** of the metal lugs. Place the first lug between a star washer and a nut with a captive star washer. After tightening the nut, place the second lug between the first nut and a second nut with a captive star washer.

Connect Ground Bus to Grounding-Electrode System

The grounding-electrode system is at earth-ground potential and is the central ground for all electrical equipment and ac power within any facility. Use a grounding-electrode conductor to connect the ground bus to the grounding-electrode system. Use at **minimum 8.3 mm² (8 AWG)** copper wire for the grounding-electrode conductor to guard against EMI. The National Electrical Code specifies safety requirements for the grounding-electrode conductor.

Install the Chassis Interconnect Cable (optional)

To connect up to three chassis together (for a maximum of 30 I/O slots), install the chassis interconnect cable before attaching your power supply.



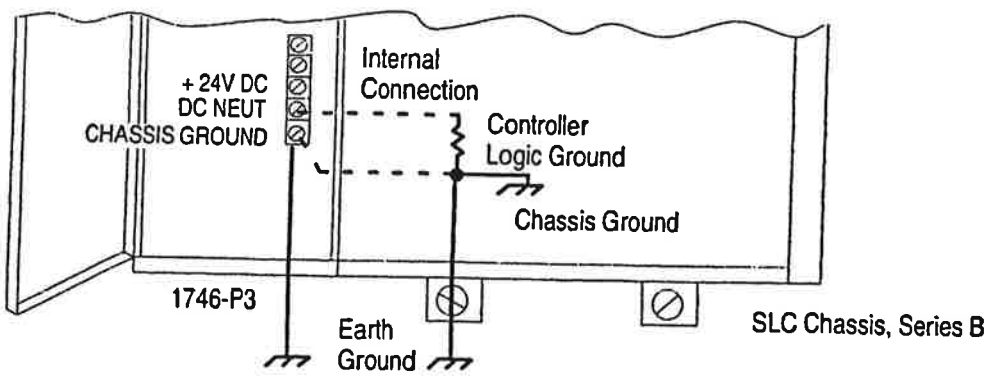
Install Your I/O Modules and Attach Your Power Supply

Use the installation instructions/user manuals for your modules to install them into the chassis. Use the installation instructions for your power supply (1746-P1, -P2, -P3, -P4, or -P5) to attach it to your chassis.



- ATTENTION:**
- Keep the connector plug on the left side-connector of the chassis if you are not connecting chassis together.
 - Remove the protective label from the top of the power supply before applying power.

Important: Series B chassis have a 1MΩ resistor between logic ground and chassis ground. When using a 1746-P3 dc power supply, follow the grounding instructions provided with the power supply to avoid unwanted potentials across the logic ground of the SLC processor.



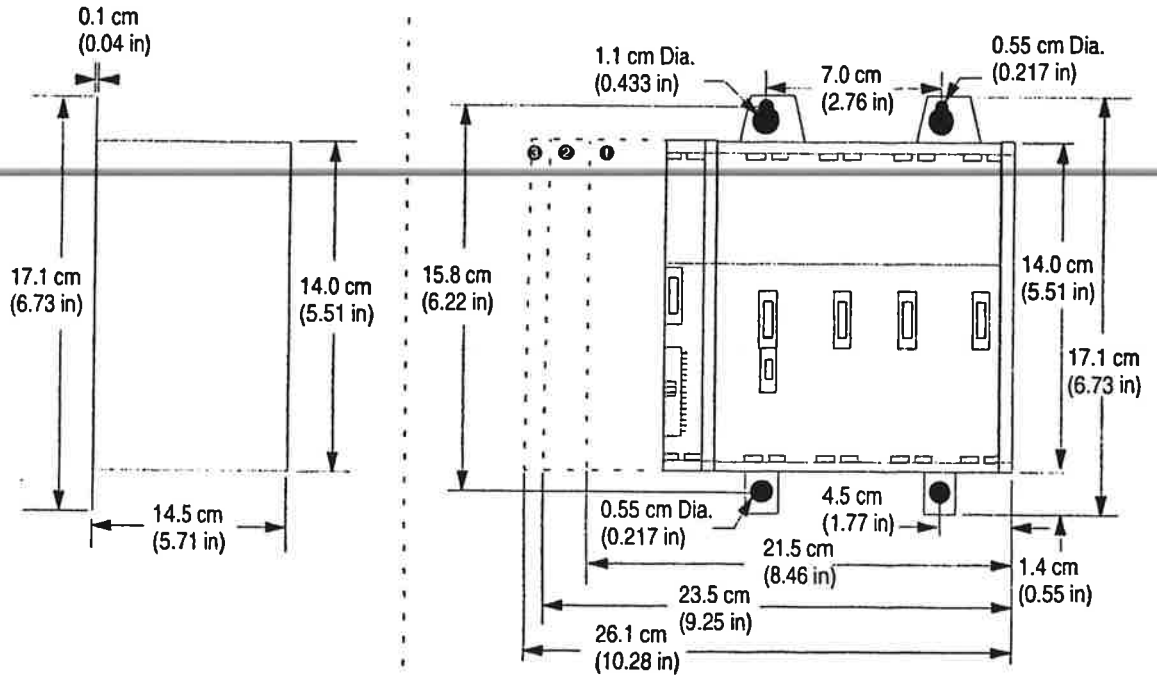
Installation Instructions

SLC 500 Modular Chassis

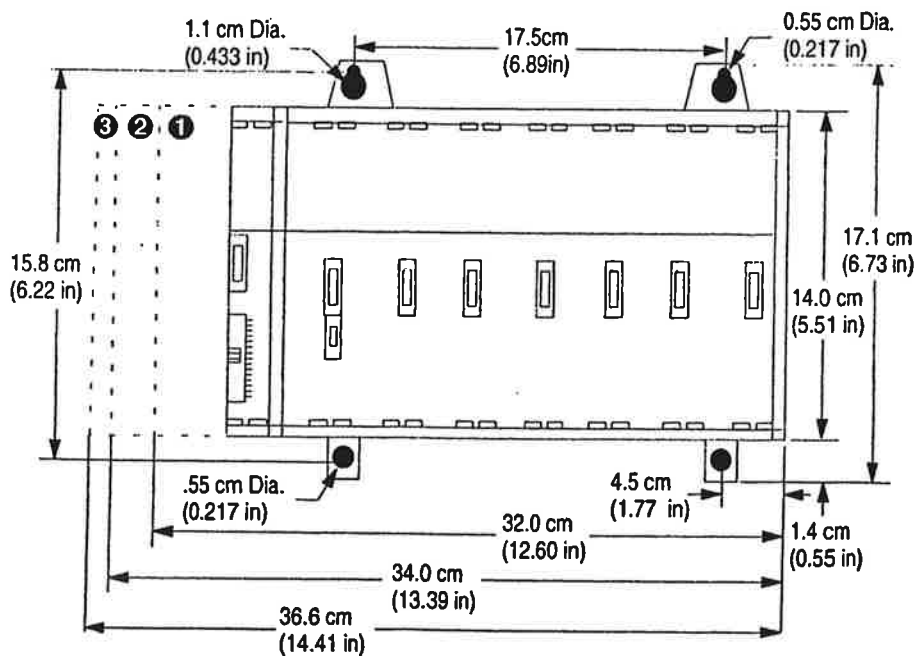
1746-A4, -A7, -A10, -A13 Series B

Mounting Dimensions

Left-side View (all chassis) 1746-A4

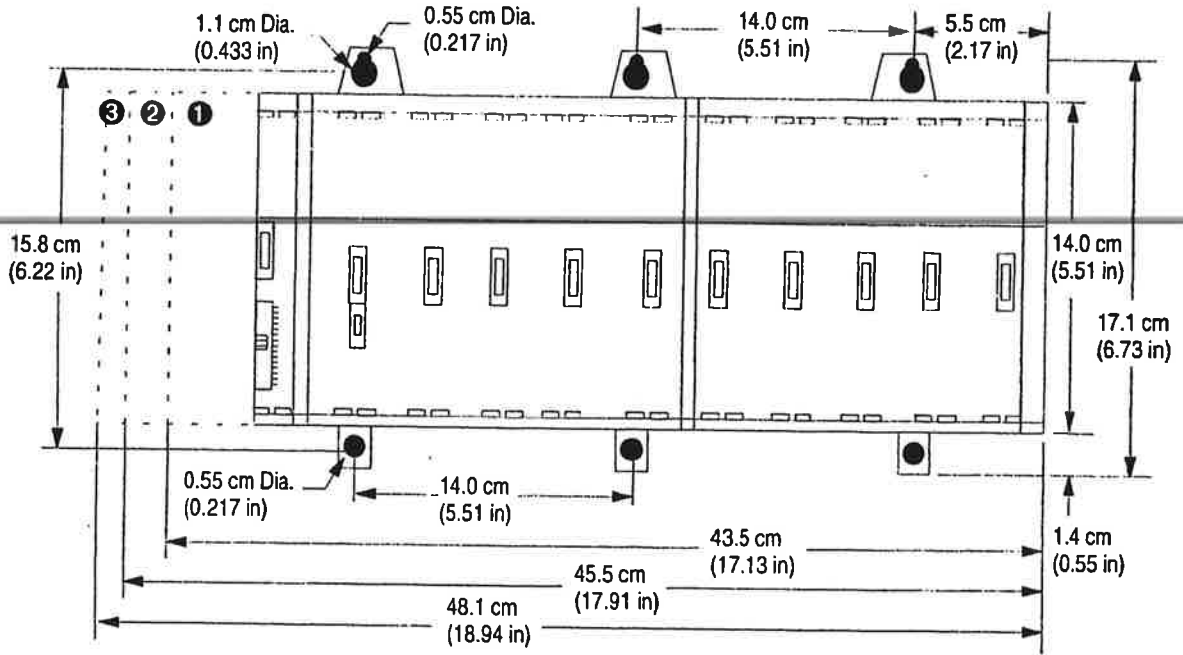


1746-A7

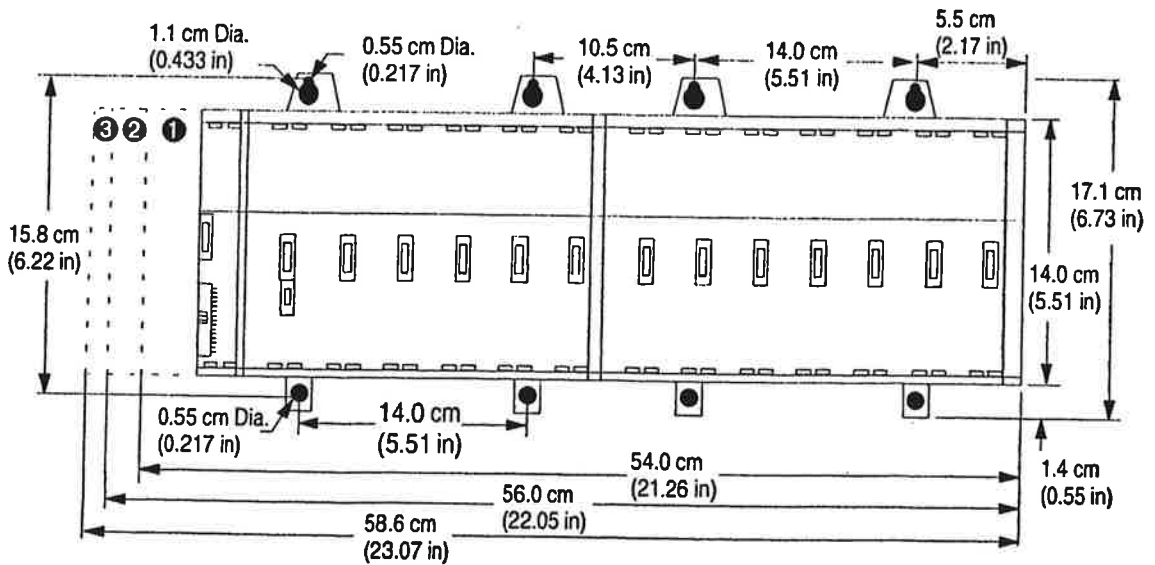


- ① Dimensions with 1746-P1 power supply.
- ② Dimensions with 1746-P2, 1746-P3, or 1746-P5 power supply.
- ③ Dimensions with 1746-P4 power supply.

1746-A10



1746-A13






- ① Dimensions with 1746-P1 power supply.
- ② Dimensions with 1746-P2, 1746-P3, or 1746-P5 power supply.
- ③ Dimensions with 1746-P4 power supply.

Installation Instructions
SLC 500 Modular Chassis
1746-A4, -A7, -A10, -A13 Series B

Specifications

SLC Chassis, Series B

1746-A4	1746-A7	1746-A10	1746-A13
<i>dimensions (with tabs)—W x H x D</i>			
17.7 x 17.1 x 14.5 cm (7.1 x 6.8 x 5.8 in)	28.2 x 17.1 x 14.5 cm (11.3 x 6.8 x 5.8 in)	39.7 x 17.1 x 14.5 cm (15.9 x 6.8 x 5.8 in)	50.2 x 17.1 x 14.5 cm (20.1 x 6.8 x 5.8 in)
<i>approximate weight (without modules)</i>			
0.75 kg (1.7 lbs)	1.1 kg (2.4 lbs)	1.45 kg (3.2 lbs)	1.9 kg (4.2 lbs)
<i>maximum backplane current</i>			
5.1V dc @ 10A; 24V dc @ 2.88A	5.1V dc @ 10A; 24V dc @ 2.88A	5.1V dc @ 10A; 24V dc @ 2.88A	5.1V dc @ 10A; 24V dc @ 2.88A
<i>module slots</i>			
4	7	10	13
<i>type of mount</i>			
panel mount	panel mount	panel mount	panel mount
<i>operating conditions</i>			
operating temperature:	0° to 60°C (32° to 140°F)		
storage temperature:	-40° to 85°C (-40° to 185°F)		
relative humidity:	5 to 95% (without condensation)		
<i>certification</i>			
 LISTED IND. CONT. EQ. FOR HAZ. LOC A196	 OPERATING TEMPERATURE CODE T3C	 CE compliant for all applicable directives	
CLASS I, GROUPS A, B, C, AND D, DIV. 2			



Allen-Bradley

**SLC 500™
Analog
Input Module
(Cat. No. 1746-NI8)**

User Manual



Important User Information

Because of the variety of uses for the products described in this publication, those responsible for the application and use of this control equipment must satisfy themselves that all necessary steps have been taken to assure that each application and use meets all performance and safety requirements, including any applicable laws, regulations, codes and standards.

The illustrations, charts, sample programs and layout examples shown in this guide are intended solely for purposes of example. Since there are many variables and requirements associated with any particular installation, Allen-Bradley does not assume responsibility or liability (to include intellectual property liability) for actual use based upon the examples shown in this publication.

Allen-Bradley publication SGI-1.1, *Safety Guidelines for the Application, Installation, and Maintenance of Solid-State Control* (available from your local Allen-Bradley office), describes some important differences between solid-state equipment and electromechanical devices that should be taken into consideration when applying products such as those described in this publication.

Reproduction of the contents of this copyrighted publication, in whole or in part, without written permission of Allen-Bradley Company, Inc., is prohibited.

Throughout this manual we use notes to make you aware of safety considerations:



ATTENTION: Identifies information about practices or circumstances that can lead to personal injury or death, property damage or economic loss.

Attention statements help you to:

- identify a hazard
- avoid the hazard
- recognize the consequences

Important: Identifies information that is critical for successful application and understanding of the product.

Table of Contents

Preface

Who Should Use this Manual	P-1
Purpose of this Manual	P-1
Contents of this Manual	P-2
Related Documentation	P-3
Common Techniques Used in this Manual	P-4
Allen-Bradley Support	P-4
Local Product Support	P-4
Technical Product Assistance	P-4
Your Questions or Comments on this Manual	P-4

Overview

Chapter 1

General Description	1-1
Hardware Features	1-2
General Diagnostic Features	1-3
System Overview	1-3
System Operation	1-3
Module Operation	1-4
Module Calibration	1-4

Quick Start for Experienced Users

Chapter 2

Required Tools and Equipment	2-1
Procedures	2-2

Installation and Wiring

Chapter 3

Electrostatic Damage	3-1
1746-NI8 Power Requirements	3-1
Module Location in Chassis	3-2
Modular Chassis Considerations	3-2
Fixed Expansion Chassis Considerations	3-2
General Considerations	3-3
Compliance to European Union Directives	3-3
EMC Directive	3-3
Module Installation and Removal	3-4
Terminal Block Removal	3-4
Switch Settings to Select Voltage or Current Input	3-4
Module Installation Procedure	3-5
Module Removal Procedure	3-6
Terminal Wiring	3-6
Terminal Block	3-6
Wiring Single-Ended and Differential Inputs	3-7
Wiring Guidelines	3-9
Input Devices	3-9
Wiring Input Devices to the 1746-NI8	3-10

Preliminary Operating Considerations

Chapter 4

Module ID Code	4-1
Class 1 and Class 3 Interface	4-2
Module Addressing	4-2
Class 1 Memory Map	4-2
Class 3 Memory Map	4-3
Output Image – Configuration Words	4-3
Input Image – Data Words and Status Words	4-4
Module Update Time	4-5
Channel Turn-On, Turn-Off, and Reconfiguration Times	4-6
Response to Slot Disabling	4-6
Input Response	4-6
Output Response	4-6
Channel Filter Frequency Selection	4-7
Channel Step Response	4-7
Channel Frequency	4-7
Channel Cut-Off Frequency	4-7
Aliasing Frequency	4-8
Noise Rejection	4-10

Channel Configuration, Data, and Status

Chapter 5

Channel Configuration	5-1
Channel Configuration Procedure	5-2
Select Input Type (Bits 0–2)	5-3
Select Data Format (Bits 3–5)	5-3
Select Open Circuit State (Bits 6 and 7)	5-3
Select Channel Filter Frequency (Bits 8–10)	5-4
Select Channel Enable (Bit 11)	5-4
Unused Bits (Bits 12–15)	5-5
Channel Data Word	5-5
Scaling the Channel Data Word	5-6
Data Type Descriptions	5-6
Using Scaled-for-PID and Proportional Counts	5-7
Scaling Examples	5-8
Engineering Units to “Real” Units	5-8
Scaled-for-PID to “Real” Units	5-9
Proportional Counts to “Real” Units	5-9
1746-NI4 Data Format Units to “Real” Units	5-10
User Defined Limits Data Format to “Real” Units	5-10
Channel Status Checking	5-11
Input Type Status (Bits 0–2)	5-13
Data Format Type Status (Bits 3–5)	5-13
Open Circuit Type Status (Bits 6 and 7)	5-13
Channel Filter Frequency (Bits 8–10)	5-13
Channel Status (Bit 11)	5-13

	Open Circuit Error (Bit 12)	5-14
	Over-Range Error (Bit 13)	5-14
	Under-Range Error (Bit 14)	5-14
	Configuration Error (Bit 15)	5-14
Ladder Programming Examples	Chapter 6	
	Initial Programming	6-1
	Procedure	6-2
	Interfacing to the PID Instruction	6-3
	Monitoring Channel Status Bits (Class 3 Mode Only)	6-4
Module Diagnostics and Troubleshooting	Chapter 7	
	Module Operation vs. Channel Operation	7-1
	Power-Up Diagnostics	7-1
	Channel Diagnostics	7-1
	LED Indicators	7-2
	Channel Status LEDs (Green)	7-3
	Invalid Channel Configuration	7-3
	Open-Circuit Detection	7-3
	Out-Of-Range Detection	7-3
	Module Status LED (Green)	7-4
	Troubleshooting Flowchart	7-5
	Replacement Parts	7-6
	Contacting Allen-Bradley	7-6
Application Examples	Chapter 8	
	Basic Example	8-1
	Application Setup – Display a Current (amperage) Value	8-1
	Device Configuration	8-1
	Channel Configuration	8-2
	Channel Configuration Worksheet (With Settings Established for Channel 0)	8-2
	Program Listing	8-3
	Data File	8-3
	Supplementary Example	8-4
	Application Setup – Display Amps, PSI, and Liquid Level	8-4
	Device Configuration	8-4
	Channel Configuration	8-5
	Channel Configuration Worksheet (With Settings Established for Channels 0-4)	8-6
	Program Setup and Operation Summary	8-7
	Program Listing	8-8
	Data File	8-10

Specifications**Appendix A**

Electrical Specifications	A-1
Physical Specifications	A-1
Environmental Specifications	A-2
Input Specifications	A-2

Configuration Worksheet**Appendix B****Converting from 1746-NI4
to 1746-NI8****Appendix C**

Module ID Code	C-1
Addressing	C-2
Channel Configuration	C-3
Ladder Program	C-3

**Two's Complement
Binary Numbers****Appendix D**

Positive Decimal Values	D-1
Negative Decimal Values	D-2

Glossary**Index**

Preface

Read this preface to familiarize yourself with the rest of the manual. This preface covers the following topics:

- who should use this manual
- the purpose of this manual
- contents of this manual
- related documentation
- common techniques used in this manual
- Allen-Bradley support

Who Should Use this Manual

Use this manual if you are responsible for the design, installation, programming, or maintenance of an automation control system that uses Allen-Bradley small logic controllers.

You should have a basic understanding of SLC 500 products. You should understand electronic process control and be able to interpret the ladder logic instructions required to generate the electronic signals that control your application.

If you do not, contact your local Allen-Bradley representative for the proper training before using this product.

Purpose of this Manual

This manual is a learning and reference guide for the 1746-NI8 Analog Input Module. It contains the information you need to install, wire, and configure the module. It also provides diagnostic and troubleshooting information, and application examples.

Contents of this Manual

Chapter	Title	Content
	Preface	Describes the purpose, background, and scope of this manual. Also specifies the audience for whom this manual is intended and gives directions to using Allen-Bradley support services. Provides listing of related documentation.
1	Overview	Provides a hardware and system overview. Explains and illustrates the theory behind the input module.
2	Quick Start for Experienced Users	Serves as a <i>Quick Start Guide</i> for the experienced user.
3	Installation and Wiring	Provides installation information and wiring guidelines.
4	Preliminary Operating Considerations	Gives you the background information you need to understand how to address and configure the module for optimum operation as well as how to make changes once the module is in a run state.
5	Channel Configuration, Data, and Status	Examines the channel configuration word and the channel status word, bit by bit, and explains how the module uses configuration data and generates status during operation.
6	Ladder Programming Examples	Gives an example of the ladder logic required to define the channel for operation. Also includes representative examples for unique programming requirements such as PID.
7	Module Diagnostics and Troubleshooting	Explains how to interpret and correct problems that may occur while using the module.
8	Application Examples	Examines both basic and supplementary applications and gives examples of the ladder logic necessary to achieve the desired result.
Appendix A	Specifications	Provides physical, electrical, environmental, and functional specifications for the module.
Appendix B	Configuration Worksheet	Provides a worksheet to help you configure the module for operation.
Appendix C	Converting from 1746-NI4 to 1746-NI8	Describes how to reconfigure a system using 1746-NI4 modules to one with that uses 1746-NI8 modules.
Appendix D	Two's Complement Binary Numbers	Describes the two's complement binary number system.
	Glossary	Lists key terms and abbreviations.

Related Documentation

The following documents contain information that may be helpful to you as you use Allen-Bradley SLC products. To obtain a copy of any of the Allen-Bradley documents listed, contact your local Allen-Bradley office or distributor.

For	Read This Document	Document Number
An overview of the SLC 500 family of products	SLC 500™ System Overview	1747-2.30
A description on how to install and use your <i>Modular</i> SLC 500 programmable controller	Installation & Operation Manual for Modular Hardware Style Programmable Controllers	1747-6.2
A description on how to install and use your <i>Fixed</i> SLC 500 programmable controller	Installation & Operation Manual for Fixed Hardware Style Programmable Controllers	1747-6.21
A procedural manual for technical personnel who use APS to develop control applications	Rockwell Software Advanced Programming Software (APS) User Manual	9399-APSUM
An introduction to APS for first-time users, containing basic concepts but focusing on simple tasks and exercises, and allowing the reader to quickly begin programming	APS Quick Start for New Users	9399-APSQS
A training and quick reference guide to APS	SLC 500™ Software Programmer's Quick Reference Guide Using APS – available on PASSPORT, list price \$50.00	ABT-1747-TSG001
A training and quick reference guide to A.I.	SLC 500™ Troubleshooting Guide Using A.I. Series – available on PASSPORT, list price \$50.00	ABT-1747-TSJ21
A common procedures guide to APS	SLC 500™ Family Common Procedures Guide Using APS – available on PASSPORT, list price \$50.00	ABT-1747-T550
A common procedures guide to A.I.	SLC 500™ Family Common Procedures Guide Using A.I. Series – available on PASSPORT, list price \$50.00	ABT-1747-TSJ51
A procedural and reference manual for technical personnel who use the APS import/export utility to convert APS files to ASCII and conversely ASCII to APS files	APS Import/Export User Manual	9399-APSie
A procedural and reference manual for technical personnel who use an HHT to develop control applications	Allen-Bradley Hand-Held Terminal User Manual	1747-NP002
An introduction to HHT for first-time users, containing basic concepts but focusing on simple tasks and exercises, and allowing the reader to quickly begin programming	Getting Started Guide for HHT	1747-NM009
A reference manual that contains status file data and instruction set information for the SLC 500 processors and MicroLogix 1000 controllers.	SLC 500™ / MicroLogix 1000™ Instruction Set Reference Manual	1747-6.15
In-depth information on grounding and wiring Allen-Bradley programmable controllers	Allen-Bradley Programmable Controller Grounding and Wiring Guidelines	1770-4.1
A description on how to install a PLC-5® system	PLC-5™ Family Programmable Controllers Hardware Installation Manual	1785-6.6.1
A description of important differences between solid-state programmable controller products and hard-wired electromechanical devices	Application Considerations for Solid-State Controls	SGI-1.1
An article on wire sizes and types for grounding electrical equipment	National Electrical Code	Published by the National Fire Protection Association of Boston, MA.
A complete listing of current Allen-Bradley documentation, including ordering instructions. Also indicates whether the documents are available on CD-ROM or in multi-languages.	Allen-Bradley Publication Index	SD499
A glossary of industrial automation terms and abbreviations	Allen-Bradley Industrial Automation Glossary	AG-7.1

Common Techniques Used in this Manual

The following conventions are used throughout this manual:

- Bulleted lists such as this one provide information, not procedural steps.
- Numbered lists provide sequential steps or hierarchical information.
- Text in **this font** indicates words or phrases you should type.
- Key names appear in bold, capital letters within brackets (for example, **[ENTER]**).

Allen-Bradley Support

Allen-Bradley offers support services worldwide, with over 75 Sales/Support Offices, 512 authorized Distributors and 260 authorized Systems Integrators located throughout the United States alone, plus Allen-Bradley representatives in every major country in the world.

Local Product Support

Contact your local Allen-Bradley representative for:

- sales and order support
- product technical training
- warranty support
- support service agreements

Technical Product Assistance

If you need to contact Allen-Bradley for technical assistance, please review the information in the *Troubleshooting* chapter first. Then call your local Allen-Bradley representative.

Your Questions or Comments on this Manual

If you find a problem with this manual, please notify us of it on the enclosed Publication Problem Report.

If you have any suggestions for how this manual could be made more useful to you, please contact us at the address below:

Allen-Bradley
Control and Information Group
Technical Communication, Dept. A602V, T122
P.O. Box 2086
Milwaukee, WI 53201-2086

Overview

This chapter describes the 1746-NI8 analog input module and explains how the SLC 500™ processor gathers analog input from the module. Included is information about:

- the module's hardware and diagnostic features
- an overview of system operation

General Description

The module receives and stores digitally converted analog data into its image table for retrieval by all fixed and modular SLC 500 processors. The module supports connections from any combination of up to eight voltage or current analog sensors.

The 1746-NI8 is a multiclass (Class 1 or Class 3) single-slot module. Class 1^① configuration utilizes 8 input words and 8 output words. Class 3 configuration utilizes 16 input words and 12 output words. Fixed and SLC 5/01™ processors can only operate as Class 1. The SLC 5/02™, SLC 5/03™, and SLC 5/04™ processors can be configured for either Class 1 or Class 3.

The 8 high-impedance input channels can be wired as either single-ended or differential inputs. The module provides a direct interface to the following input types:

- ±10V dc
- 1–5V dc
- 0–5V dc
- 0–10V dc
- 0–20 mA
- 4–20 mA
- ±20 mA
- 0–1 mA

The data presented to the processor can be configured as:

- Engineering Units
- Scaled-for-PID
- Proportional Counts (–32,768 to +32,767 range)
- Proportional Counts with User Defined Range (Class 3 only)
- 1746-NI4 Data Format

^① Requires use of Block Transfer in a remote configuration.

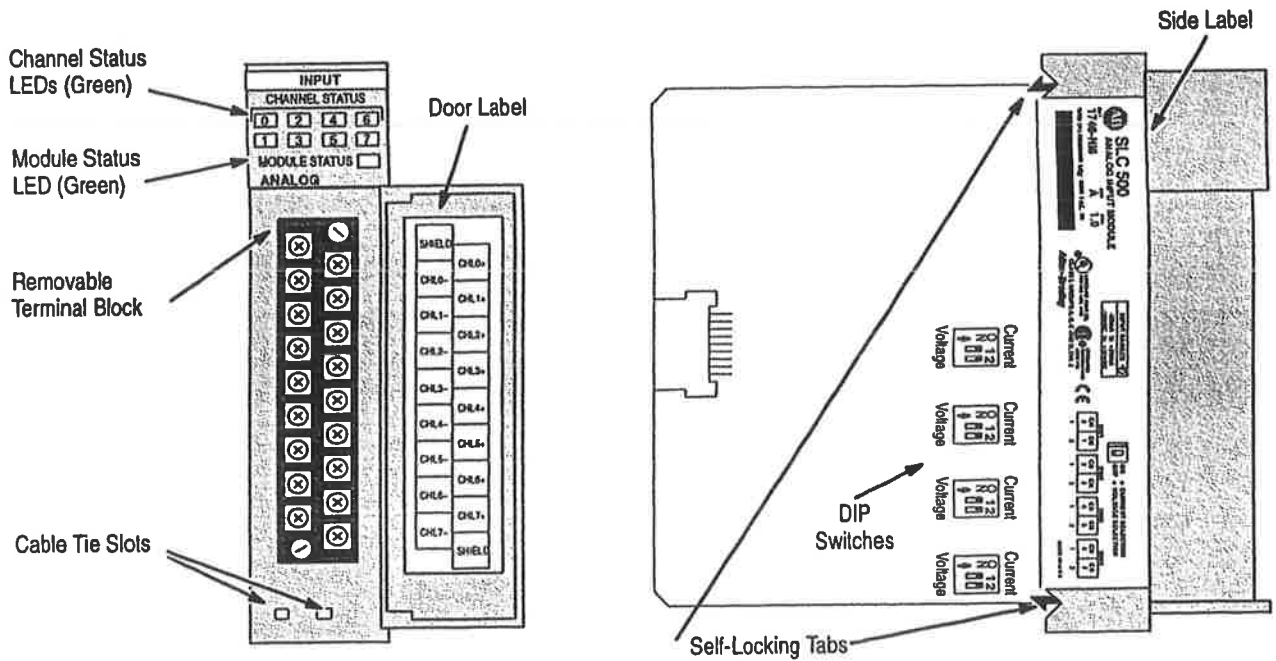
Each input channel also provides open-circuit, out-of-range, and invalid configuration indication via the LEDs. In Class 3 operation these conditions are also in the channel status word.

Important: Status words are only available when the module is configured for Class 3.

Hardware Features

The module fits into any slot, except the processor slot (0), in either an SLC 500 modular system or an SLC 500 fixed system expansion chassis (1746-A2).

The module contains a removable terminal block providing connection for eight analog input channels, which is specifically designed to interface with analog current and voltage input signals. The channels can be wired as either single-ended or differential inputs. There are no output channels on the module. Module configuration is done via the user program. There are DIP switches on the circuit board for selecting voltage or current input.



Hardware Feature	Function
Channel Status LED Indicators	Displays channel operating and fault status.
Module Status LED	Displays module operating and fault status.
Side Label (Nameplate)	Provides module information.
Removable Terminal Block	Provides physical connection to input devices.
Door Label	Permits easy terminal identification.
Cable Tie Slots	Secures and route wiring from module.
Self-Locking Tabs	Secures module in chassis slot.
Voltage/current Selection DIP Switches	Selects voltage or current input type to match the analog sensor.

General Diagnostic Features

The 1746-NI8 module contains diagnostic features that can help you identify the source of problems that may occur during power-up or during normal channel operation. These power-up and channel diagnostics are explained in chapter 7, *Module Diagnostics and Troubleshooting*.

System Overview

The module communicates to the SLC 500 processor through the parallel backplane interface and receives power from the SLC 500 power supply through the backplane. The +5V dc backplane supply powers the SLC circuitry, and the +24V dc backplane supply powers the module analog circuitry. No external power supply is required. You may install as many 1746-NI8 analog modules in your system as the power supply can support.

Each channel on the module can receive input signals from voltage or current analog input devices. You configure each channel individually to accept either a voltage or current input signal.

System Operation

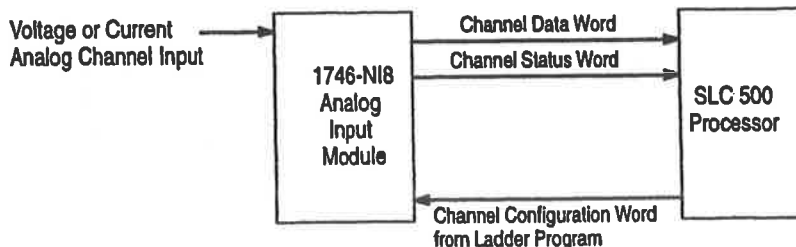
At power-up, the module performs a check of its internal circuits, memory, and basic functions. During this time the module status LED remains off. If no faults are found during the power-up diagnostics, the module status LED is turned on.

After power-up checks are complete, the module waits for valid channel configuration data from your SLC ladder logic program (channel status LEDs off). After configuration data is written to one or more channel configuration words and the channel enable status bits are set, the channel status LEDs go on and the module continuously converts the analog input to a value within the range you selected.

Each time a channel is read by the module, that data value is tested by the module for a fault condition (i.e., open-circuit, over-range, and under-range). If such a condition is detected, a unique bit is set in the channel status word and the channel status LED blinks.

The SLC processor reads the converted analog data from the module at the end of the program scan, or when commanded by the ladder program. The processor and module determine that the backplane data transfer was made without error, and the data is used in your ladder program. A graphic representation of this is shown below.

Data Transfer Between the Module and Processor (shown for one channel)



Module Operation

The 1746-NI8 module's input circuitry consists of eight differential analog inputs multiplexed into a single analog-to-digital (A/D) converter.

The A/D converter reads the selected input signal and converts it to a digital value. The multiplexer sequentially switches each input channel to the module's A/D converter. Multiplexing provides an economical means for a single A/D converter to convert multiple analog signals. However, multiplexing also affects the speed at which an input signal can change and still be detected by the converter.

Module Calibration

The module performs continuous autocalibration for all the channels that are enabled. There is no need to invoke a calibration cycle to compensate for changes in temperature.

Quick Start for Experienced Users

This chapter can help you to get started using the 1746-NI8 analog input module. We base the procedures here on the assumption that you have an understanding of SLC 500 products. You should understand electronic process control and be able to interpret the ladder logic instructions required to generate the electronic signals that control your application.

Because it is a start-up guide for experienced users, this chapter *does not* contain detailed explanations about the procedures listed. It does, however, reference other chapters in this book where you can get more information about applying the procedures described in each step. It also references other documentation that may be helpful if you are unfamiliar with programming techniques or system installation requirements.

If you have any questions or are unfamiliar with the terms used or concepts presented in the procedural steps, *always read the referenced chapters* and other recommended documentation before trying to apply the information.

This chapter will:

- tell you what equipment you need
- explain how to install and wire the module
- show you how to set up one channel for analog input
- examine the state of the LEDs at normal startup
- examine the channel status word

Required Tools and Equipment

Have the following tools and equipment ready:

- medium blade screwdriver
- medium cross-head screwdriver
- analog input device
- cable for wiring inputs to module
- SLC processor and power supply installed in chassis
- analog input module (1746-NI8)
- programming device and software

Procedures

1.	Check the contents of shipping box.	Reference
-----------	--	------------------

Unpack the shipping box making sure that the contents include:

- analog input module (Catalog Number 1746-NI8)
- removable terminal block (factory-installed)

If the contents are incomplete, call your local Allen-Bradley representative for assistance.

2.	Ensure that your chassis and power supply support the 1746-NI8 module.	Reference
-----------	---	------------------

Review the power requirements of your system to see that your chassis supports the module:

- If combining a 1746-NI8 module with another I/O module in a fixed controller, refer to the I/O module compatibility table found in chapter 3.
- For modular style systems, calculate the total load on the system power supply using the procedure described in the *SLC Installation & Operation Manual for Modular Style Controllers* (publication 1747-6.2) or the *SLC 500 Family System Overview* (publication 1747-2.30).
- The 1746-NI8 backplane current consumption is 200 mA at 5V dc and 100 mA at 24V dc.

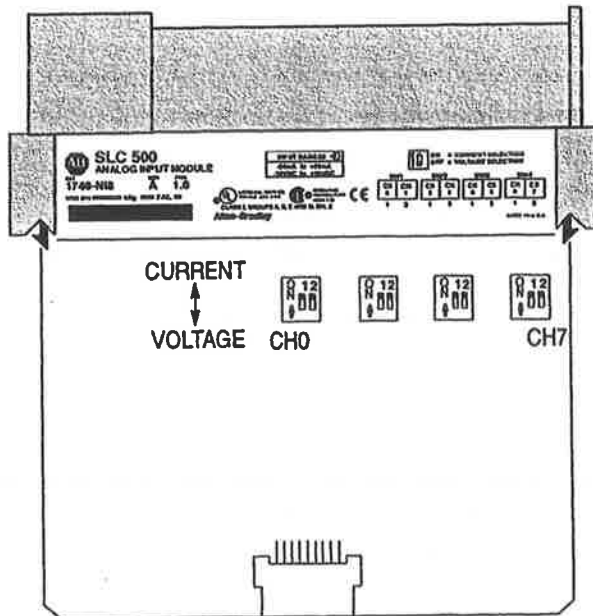
Chapter 3
(Installation and Wiring)

Appendix A
(Specifications)

3.	Select voltage or current input type to match the analog sensor.	Reference
-----------	---	------------------

The voltage/current selection DIP switches are located on the side of the module. The switch settings are OFF = VOLTAGE INPUT and ON = CURRENT INPUT.

Chapter 3
(Installation and Wiring)



4. Insert the 1746-NI8 module into the chassis.

Reference



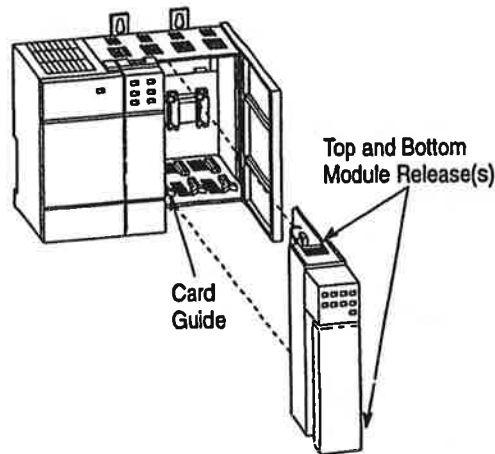
ATTENTION: Never install, remove, or wire modules with power applied to the chassis or devices wired to the module.

Make sure system power is off; then insert the module into your 1746 chassis. In this example procedure, local slot 1 is selected.

Important: For applications using the upper limit of the operating temperature range, the 1746-NI8 module (or multiple 1746-NI8 modules) should be placed in the right most slot(s) of the chassis. The specification for operating temperature is:

0°C to 55°C (32°F to 131°F) in any slot except slot 0

0°C to 60°C (32°F to 140°F) in right most slot of chassis



Chapter 3
(Installation and Wiring)

5. Connect sensor cable.

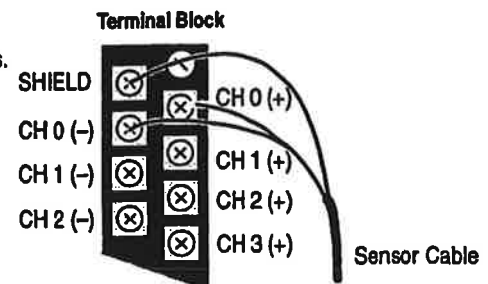
Reference

Connect sensor cable to the module's terminal block.

Important: Follow these guidelines when wiring the module.

- Use shielded communication cable (Belden 8761) and keep length as short as possible.
- Connect only one end of the cable shield to earth ground.
- Connect the shield drain wires for channels 0-3 to the top shield terminal.
- Connect the shield drain wires for channels 4-7 to the bottom shield terminal.
- Shield terminals are internally connected to chassis ground which is connected to earth ground via the SLC backplane.
- Single-ended source commons may be jumpered together at the terminal block.
- Channels are not isolated from each other. All analog commons are connected together internally.
- If a differential signal source has an analog common, it can not and must not be connected to the module.
- Common mode voltage range is ± 10.5 volts. The voltage between any two terminals must be less than 21 volts.
- The module does not provide power for the analog inputs.
- Use a power supply that matches the transmitter (sensor) specifications.

Chapter 3
(Installation and Wiring)



6.	Configure the system.	Reference
-----------	------------------------------	------------------

Configure your system I/O for the particular slot the 1746-NI8 is in (slot 1 in this example). Enter the module ID code. The ID code is 3526 for Class 1 interface, and 12726 for Class 3 interface. See chapter 4 for more information on Class 1 and Class 3 interfaces.

Chapter 4
(Preliminary Operating Considerations)

Important: All programming software does not support configuration for Class 3 operation.

- Advanced Programming Software (APS) supports Class 3 configuration. After entering the ID code (12726), enter 16 input words and 12 output words.
- SLC 500 A.I. Series™ Programming Software supports Class 3 configuration. After entering the ID code (12726), enter 16 input words and 12 output words.
- RSLogix 500™, version 1.30 or later, supports Class 3 configuration. After entering the ID code (12726), select Class 3 operation.
- Earlier versions of RSLogix 500 will only support configuration for Class 1 operation. Contact Rockwell Software for information on upgrading your software.

Appendix C
(Converting from 1746-NI4 to 1746-NI8)

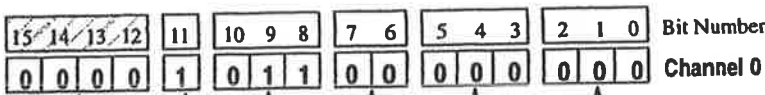
Your programming device's user manual.

If you are converting from a 1746-NI4 to a 1746-NI8 based system, see Appendix C.

7.	Determine the operating parameters.	Reference
-----------	--	------------------

Determine the operating parameters for channel 0. This example shows the channel 0 configuration word. The module is in slot 1. The default configuration word is all zero's.

Chapter 4
(Preliminary Operating Considerations)



- Input Type: ±10V dc
- Data Format: engineering units
- Open Circuit: only used for 4–20 mA input type
- Filter Frequency: 20 Hz
- Channel Enable: enabled
- Not Used

Chapter 5
(Channel Configuration, Data, and Status)

Appendix B
(NI8 Configuration Worksheet)

Appendix C
(Converting from 1746-NI4 to 1746-NI8)

1746-NI8 Module Output Image - Channel Configuration			Class 1	Class 3
O:1.0	channel 0 configuration word	bit mapped field	•	•
O:1.1	channel 1 configuration word	bit mapped field	•	•
O:1.2	channel 2 configuration word	bit mapped field	•	•
O:1.3	channel 3 configuration word	bit mapped field	•	•
O:1.4	channel 4 configuration word	bit mapped field	•	•
O:1.5	channel 5 configuration word	bit mapped field	•	•
O:1.6	channel 6 configuration word	bit mapped field	•	•
O:1.7	channel 7 configuration word	bit mapped field	•	•
O:1.8	lower scale limit range 0	16 bit integer		•
O:1.9	upper scale limit range 0	16 bit integer		•
O:1.10	lower scale limit range 1	16 bit integer		•
O:1.11	upper scale limit range 1	16 bit integer		•

8.	Program the configuration.	Reference
-----------	-----------------------------------	------------------

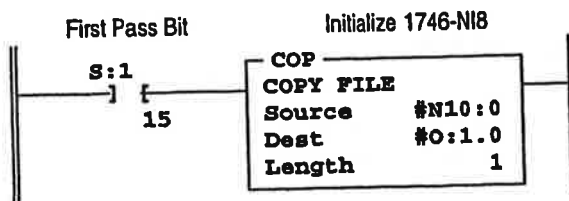
- Do the programming necessary to establish the new configuration word setting in the previous step.
1. Create integer file N10. Integer file N10 should contain one element for each channel used. (For this example we only need one, N10:0.)
 2. Enter the configuration parameters from step 7 for channel 0 into integer N10:0.
 3. Program an instruction in your ladder logic to copy the contents of N10:0 to output word O:1.0.

Chapter 6
(Ladder Logic Configuration Examples)

Chapter 8
(Application Examples)

DATA FILE N10

Offset	15	14	13	12	11	10	9	8	7	6	5	4	3	2	1	0
N10:0	0	0	0	0	1	0	1	1	0	0	0	0	0	0	0	0

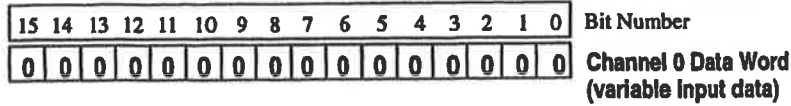


On power up, the first pass bit (S:1/15) is set for one scan, enabling the COPY instruction that transfers the channel configuration word 0. This configures and enables the channel.

9.	Write the ladder program.	Reference
-----------	----------------------------------	------------------

Write the remainder of the ladder logic program that specifies how your analog input data will be processed for your application. In this procedure the module is located in slot 1.

Chapter 5
(Channel Configuration, Data, and Status)



Chapter 6
(Ladder Logic Configuration Examples)

1746-N18 Module Input Image - Data Word			Class 1	Class 3
I:1.0	channel 0 data word	16 bit integer	•	•
I:1.1	channel 1 data word	16 bit integer	•	•
I:1.2	channel 2 data word	16 bit integer	•	•
I:1.3	channel 3 data word	16 bit integer	•	•
I:1.4	channel 4 data word	16 bit integer	•	•
I:1.5	channel 5 data word	16 bit integer	•	•
I:1.6	channel 6 data word	16 bit integer	•	•
I:1.7	channel 7 data word	16 bit integer	•	•

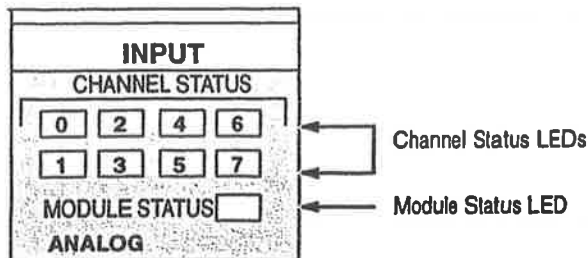
Chapter 8
(Application Examples)

Your programming device's user manual.

10.	Go through the system start-up procedure.	Reference
------------	--	------------------

Apply power. Download your program to the SLC processor and put the controller into Run mode. During a normal start up, the module status LED and any enabled channel status LED turn on.

Chapter 7
(Module Diagnostics and Troubleshooting)



11.	Check that the module is operating correctly.	Reference
------------	--	------------------

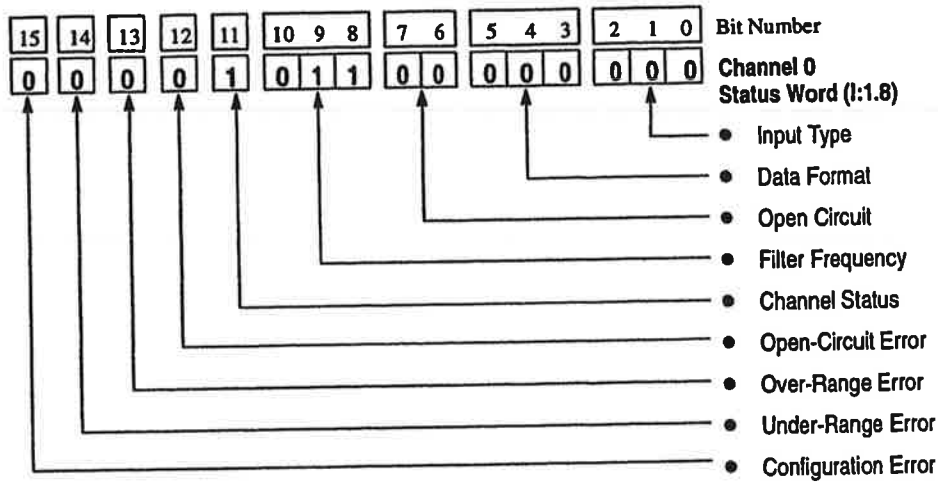
(Optional) If the Module Status LED is off, or if the Channel 0 LED is off or blinking, refer to chapter 7.

Class 3 Interface – Monitor the status of input channel 0 to determine its configuration setting and operational status. This is useful for troubleshooting when the blinking channel LED indicates that an error has occurred. The example below shows the configuration for channel 0 with no errors.

Chapter 5
(Channel Configuration, Data, and Status)

Chapter 7
(Module Diagnostics and Troubleshooting)

Chapter 8
(Application Examples)



Installation and Wiring

This chapter tells you how to:

- avoid electrostatic damage
- determine the chassis power requirement for the module
- choose a location for the module in the SLC chassis
- set the channels for voltage or current analog input
- install the module
- wire the module's terminal block
- wire input devices

Electrostatic Damage

Electrostatic discharge can damage semiconductor devices inside this module if you touch backplane connector pins. Guard against electrostatic damage by observing the following precautions.



ATTENTION: Electrostatic discharge can degrade performance or cause permanent damage. Handle the module as stated below.

- Wear an approved wrist strap grounding device when handling the module.
- Touch a grounded object to rid yourself of electrostatic charge before handling the module.
- Handle the module from the front, away from the backplane connector. Do not touch backplane connector pins.
- Keep the module in its static-shield bag when not in use, or during shipment.

1746-NI8 Power Requirements

The 1746-NI8 module receives its power through the SLC 500 chassis backplane from the fixed or modular +5V dc/+24V dc chassis power supply. The +5V dc backplane supply powers the SLC circuitry, and the +24V dc backplane supply powers the module analog circuitry. The maximum current drawn by the module is shown in the table below.

5V dc Amps	24V dc Amps
0.200	0.100

When you are using a *modular system* configuration, add the values shown in the table above to the requirements of all other modules in the SLC chassis to prevent overloading the chassis power supply.

When using a *fixed system* controller, refer to the **Important** note about compatibility in a 2-slot expansion chassis on page 3-2.

Module Location in Chassis

Fixed Controller Compatibility Table

	NI8	5V dc (Amps)	24V dc (Amps)
IA4	•	0.035	-
IA8	•	0.050	-
IA16	•	0.085	-
IM4	•	0.035	-
IM8	•	0.050	-
IM16	•	0.085	-
OA8	•	0.185	-
OAP12	•	0.370	-
OA16	•	0.370	-
IB8	•	0.050	-
IB16	•	0.085	-
IC16	•	0.085	-
ITB16	•	0.085	-
ITV16	•	0.085	-
IV8	•	0.050	-
IV16	•	0.085	-
IG16	•	0.140	-
OV8	•	0.135	-
OV16	•	0.270	-
OB8	•	0.135	-
OBP8	•	0.135	-
OBP16	•	0.250	-
OVP16	•	0.250	-
OG16	•	0.180	-
OW4	•	0.045	0.045
OW8	•	0.085	0.090
OW16	•	0.170	0.180
IO4	•	0.030	0.025
IO8	•	0.060	0.045
IO12	•	0.090	0.070
NI4	•	0.025	0.085
NI8	•	0.200	0.100
NIO4I	•	0.055	0.145
FIO4I	•	0.055	0.150
FIO4V	•	0.055	0.120
NIO4V	•	0.055	0.115
NT4	•	0.060	0.040
NR4	•	0.050	0.050
HSTP1	•	0.200	-
IH16	•	0.085	-
DCM	•	0.360	-
HS	•	0.300	-
OB16	•	0.280	-
IN16	•	0.085	-
BASn	•	0.150	0.125
BAS	•	0.150	0.040
OB32	•	0.452	-
OV32	•	0.452	-
IV32	•	0.106	-
IB32	•	0.106	-
OX8	•	0.085	0.090
NO4I	▽	0.055	0.195
NO4V	▽	0.055	0.145
KE _n	•	0.150	0.125
KE	•	0.150	0.040

Modular Chassis Considerations

Place your 1746-NI8 module in any slot of an SLC 500 modular, or modular expansion chassis, except for the extreme left slot (slot 0) in the first chassis. This slot is reserved for the processor or adapter modules.

Important: For applications using the upper limit of the operating temperature range, the 1746-NI8 module (or multiple 1746-NI8 modules) should be placed in the right most slot(s) of the chassis. The specification for operating temperature is:

Operating Temperature Range

0°C to 55°C (32°F to 131°F) in any slot except slot 0

0°C to 60°C (32°F to 140°F) in right most slot of chassis

Fixed Expansion Chassis Considerations

Important: The 2-slot, SLC 500 fixed I/O expansion chassis (1746-A2) will support only specific combinations of modules. If you are using the 1746-NI8 module in a 2-slot expansion chassis with another SLC I/O or communication module, refer to the table at the left to determine whether the combination can be supported. In the table:

- A dot indicates a valid combination.
- No symbol indicates an invalid combination.
- A triangle indicates an external power supply is required. (Refer to the Analog I/O Module User Manual, publication 1746-6.4.)

When using the table, be aware that there are certain conditions that affect the compatibility characteristics of the BASIC module (BAS) and the DH-485/RS-232C module (KE).

When you use the BAS module or the KE module to supply power to a 1747-AIC Link Coupler, the Link Coupler draws its power through the module. The higher current drawn by the AIC at 24V dc is calculated and recorded in the table for the modules identified as BAS_n (BAS networked) or KE_n (KE networked). Make sure to refer to these modules if your application uses the BAS or KE module in this way.

General Considerations

Most applications require installation in an industrial enclosure to reduce the effects of electrical interference. Analog inputs are highly susceptible to electrical noise. Electrical noise coupled to the analog inputs will reduce the performance (accuracy) of the module.

Group your modules to minimize adverse effects from radiated electrical noise and heat. Consider the following conditions when selecting a slot for the analog input module. Position the module:

- in a slot away from sources of electrical noise such as hard-contact switches, relays, and AC motor drives
- away from modules which generate significant radiated heat, such as the 32-point I/O modules

In addition, route shielded twisted pair analog input wiring away from any high voltage I/O wiring.

Compliance to European Union Directives

This product is approved for installation within the European Union and EEA regions. It has been designed and tested to meet the following directives.

EMC Directive

The 1746-NI8 analog input module is tested to meet Council Directive 89/336/EEC Electromagnetic Compatibility (EMC) and the following standards, in whole or in part, documented in a technical construction file:

- EN 50081-2
EMC – Generic Emission Standard, Part 2 – Industrial Environment
- EN 50082-2
EMC – Generic Immunity Standard, Part 2 – Industrial Environment

This product is intended for use in an industrial environment.

Module Installation and Removal

When installing the module in a chassis, it is not necessary to remove the terminal block from the module. However, if the terminal block is removed, use the write-on label located on the side of the terminal block to identify the module location and type.

Terminal Block Removal

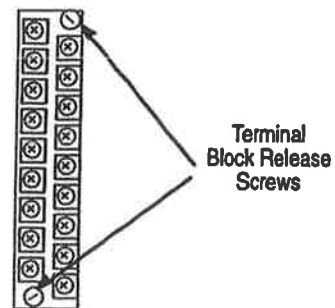
SLOT ____	RACK ____
● MODULE _____	



ATTENTION: Never install, remove, or wire modules with power applied to the chassis or devices wired to the module.

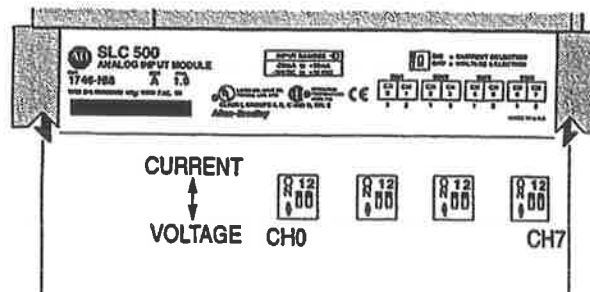
To remove the terminal block:

1. Loosen the two terminal block release screws.
2. Grasp the terminal block at the top and bottom and pull outward and down.



Switch Settings to Select Voltage or Current Input

Select between voltage and current inputs before installing the module in the chassis. Use the DIP switches on the module circuit board. The switch settings are OFF = VOLTAGE INPUT and ON = CURRENT INPUT. Do this for channels 0-7.



Module Installation Procedure

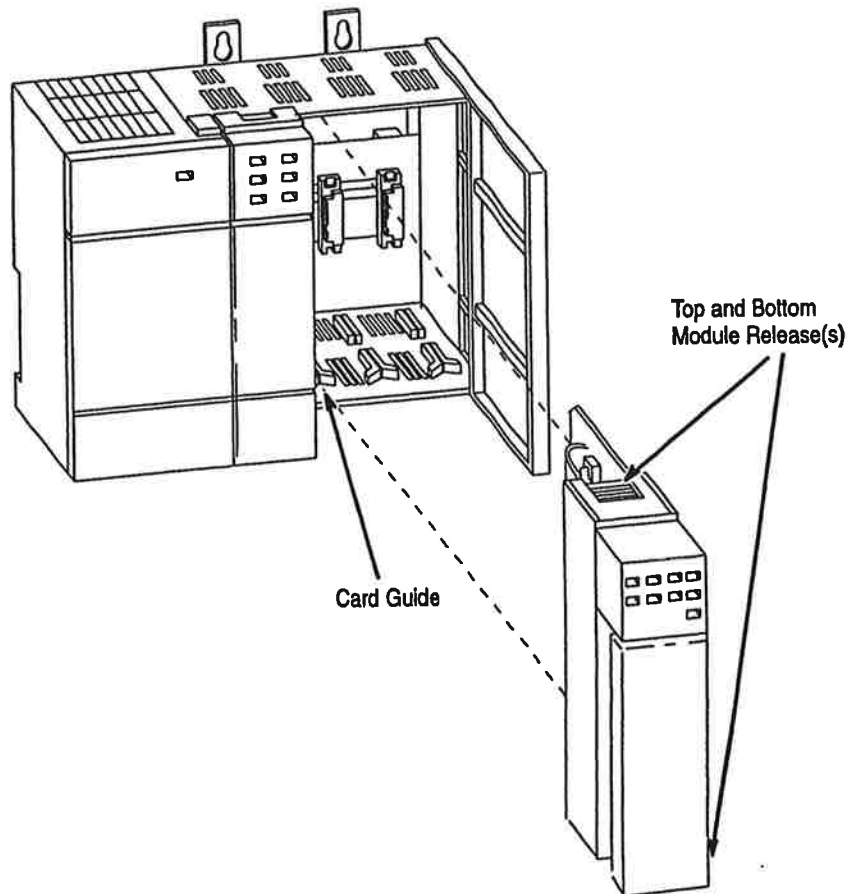
1. Align the circuit board of the analog input module with the card guides located at the top and bottom of the chassis.
2. Slide the module into the chassis until both top and bottom retaining clips are secured. Apply firm even pressure on the module to attach it to its backplane connector. Never force the module into the slot.
3. Cover all unused slots with the Card Slot Filler, Catalog Number 1746-N2.

Important: For applications using the upper limit of the operating temperature range, the 1746-NI8 module (or multiple 1746-NI8 modules) should be placed in the right most slot(s) of the chassis. The specification for operating temperature is:

Operating Temperature Range

0°C to 55°C (32°F to 131°F) in any slot except slot 0

0°C to 60°C (32°F to 140°F) in right most slot of chassis



Module Removal Procedure

1. Press the releases at the top and bottom of the module and slide the module out of the chassis slot.
2. Cover all unused slots with the Card Slot Filler, Catalog Number 1746-N2.

Terminal Wiring

The 1746-NI8 module contains an 18-position, removable terminal block. The terminal pin-out is shown below.

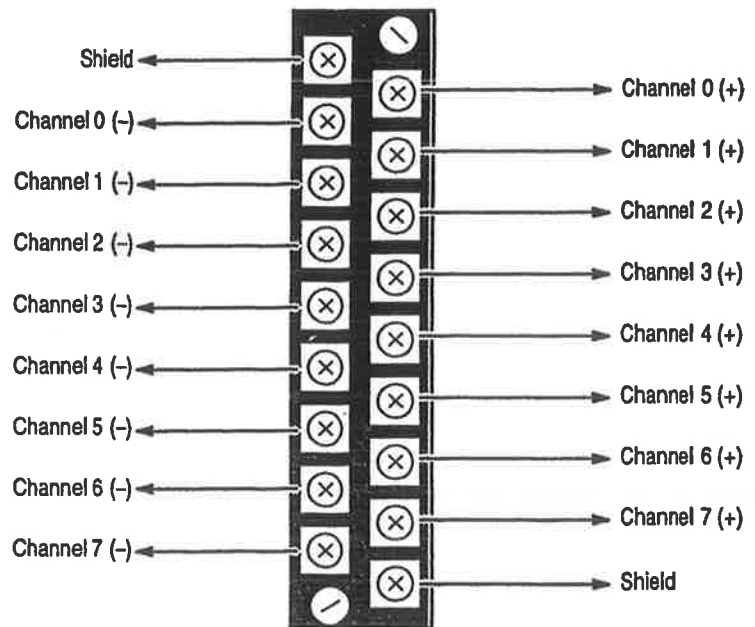


ATTENTION: Disconnect power to the SLC before attempting to install, remove, or wire the removable terminal wiring block.

To avoid cracking the removable terminal block, alternate the removal of the slotted terminal block release screws.

Terminal Block

(Terminal Block Spare Part Catalog Number 1746-RT25G)

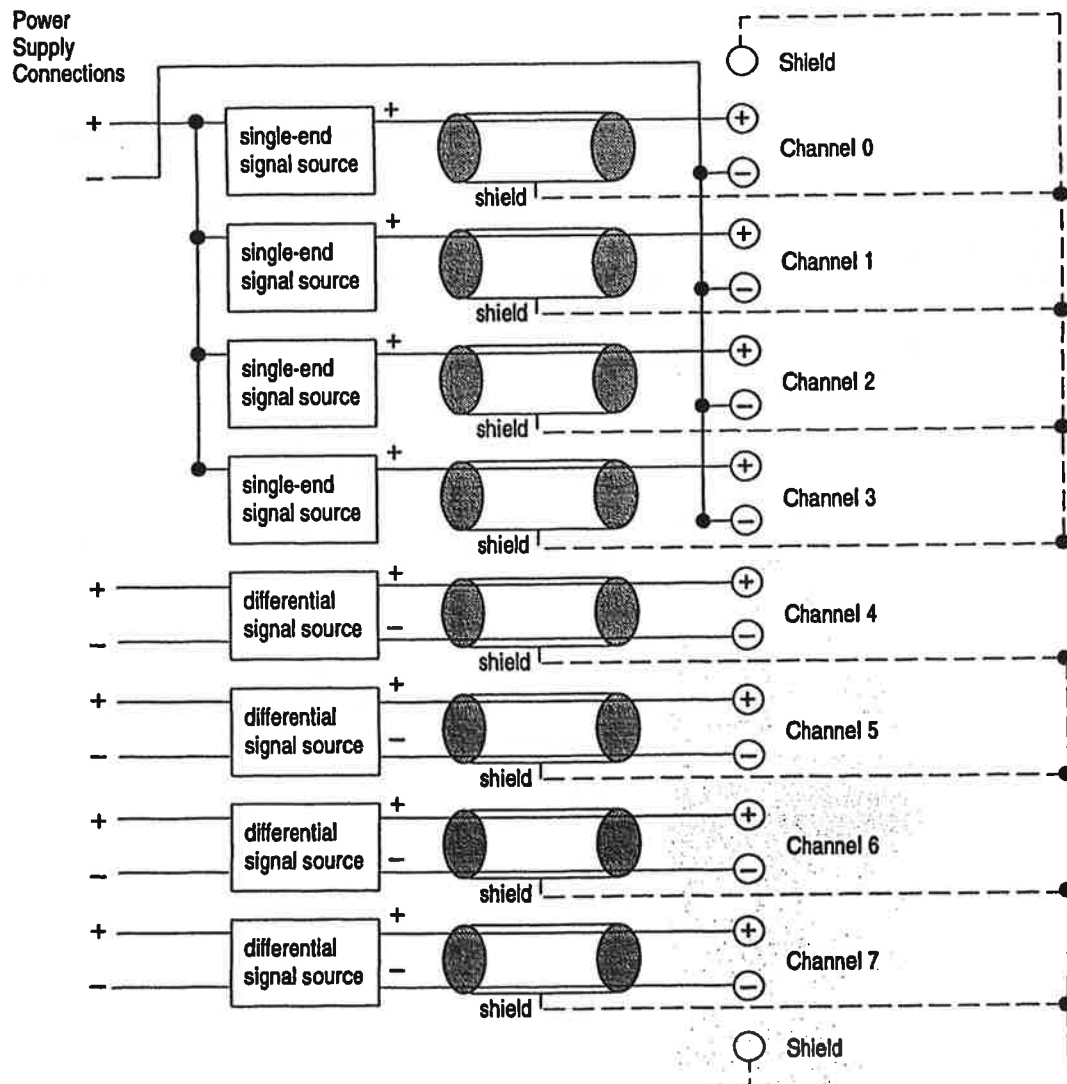


Wiring Single-Ended and Differential Inputs

The diagram below shows typical wiring for the module.

Important: Follow these guidelines when wiring the module.

- Use shielded communication cable (Belden 8761) and keep length as short as possible.
- Connect only one end of the cable shield to earth ground.
- Connect the shield drain wires for channels 0-3 to the top shield terminal.
- Connect the shield drain wires for channels 4-7 to the bottom shield terminal.
- Shield terminals are internally connected to chassis ground which is connected to earth ground via the SLC backplane.
- Single-ended source commons may be jumpered together at the terminal block.
- Channels are not isolated from each other.
- If a differential signal source has an analog common, it can not and must not be connected to the module.
- Common mode voltage range is ± 10.5 volts. The voltage between any two terminals must be less than 21 volts.
- The module does not provide power for the analog inputs.
- Use a power supply that matches the transmitter (sensor) specifications.

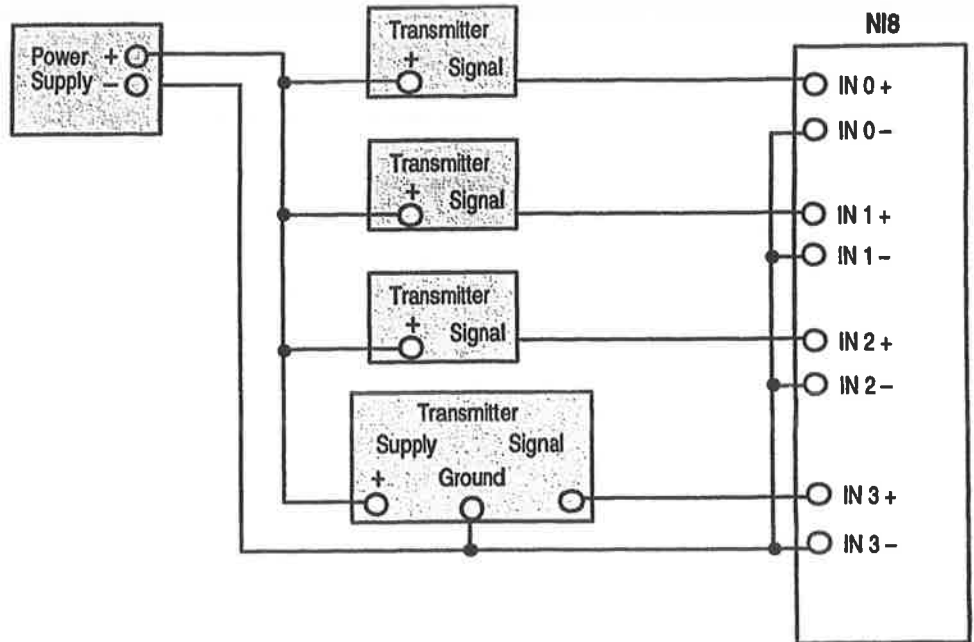


Wiring Schematic for Single-ended Analog Input Connections

When wiring single-ended analog input devices to the analog input module, the number of total wires necessary can be limited by jumpering all "IN-" terminals together. Note that differential inputs are more immune to noise than single-ended inputs.

Important: The module does *not* provide loop power for analog inputs. Use a power supply that matches the transmitter specifications.

Important: Follow the guidelines on pages 3-7 and 3-9 when wiring the module.

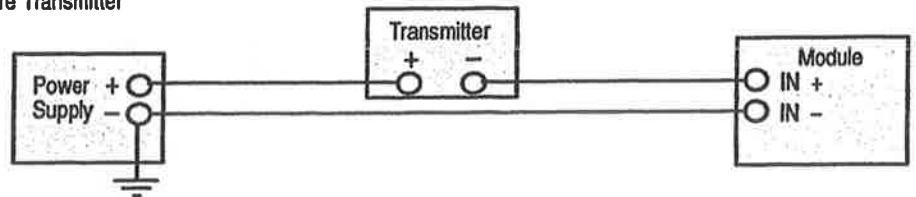


Wiring Schematics for 2, 3, and 4-Wire Analog Input Devices

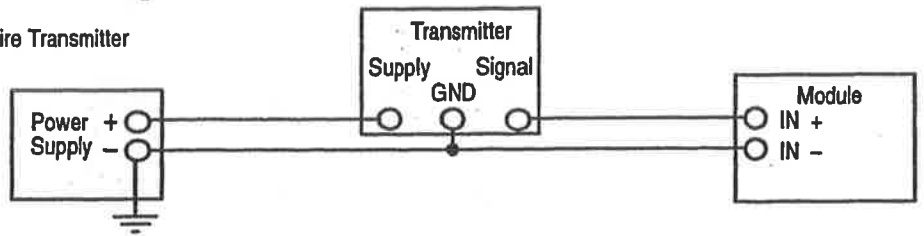
Important: The module does *not* provide loop power for analog inputs. Use a power supply that matches the transmitter specifications.

Important: Follow the guidelines on pages 3-7 and 3-9 when wiring the module.

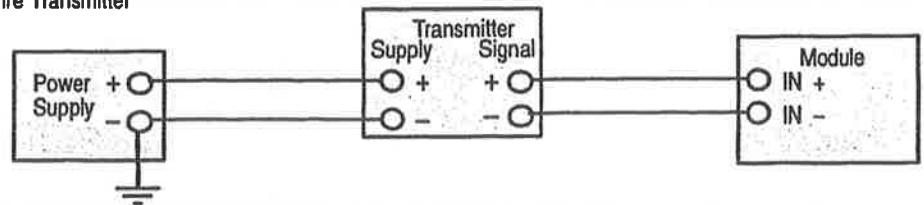
2-Wire Transmitter



3-Wire Transmitter



4-Wire Transmitter



Wiring Guidelines



ATTENTION: To prevent shock hazard, care should be taken when wiring the module to analog signal sources. Before wiring any analog module, disconnect power from the SLC 500 system and from any other source to the analog module.

Follow the guidelines below when planning your system wiring.

- To limit noise, keep signal wires as far away as possible from power and load lines.
- To ensure proper operation and high immunity to electrical noise, always use Belden 8761 (shielded, twisted pair) or equivalent wire.
- Connect the shield drain wire to the shield terminal on the 1746-NI8 module. Up to four shield wires may be connected to each shield connection screw terminal that provides a connection to chassis ground.
- Tighten terminal screws using a flat or cross-head screwdriver. Each screw should be turned tight enough to immobilize the wire's end. Excessive tightening can strip the terminal screw. The torque applied to each screw should not exceed 5 lb-in (0.565 Nm) for each terminal.
- Follow system grounding and wiring guidelines found in your SLC 500 Modular Hardware Style Installation and Operation Manual, publication 1747-6.2.

Input Devices

Transducer Source Impedance

If the source impedance of the input device and associated cabling is too high, it will affect the accuracy of the channel data word. Source impedance of 500 ohms will produce up to 0.05% of module error over and above the specified accuracy of the module.

You can compensate for device impedance error by implementing the following equation in your ladder program:

$$V_s = V_{\text{measured}} \times \left[\frac{(R_s + R_{in})}{R_{in}} \right]$$

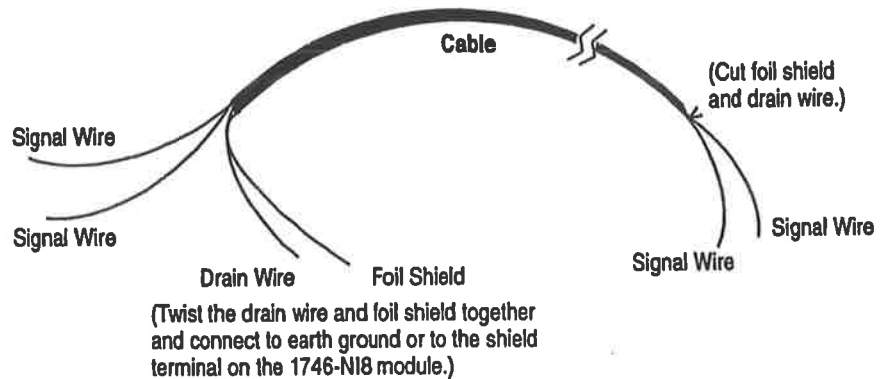
where: V_s = input device voltage
 R_s = input device source impedance
 R_{in} = 1746-NI8 input impedance (1 M Ω)

Wiring Input Devices to the 1746-NI8

After the analog input module is properly installed in the chassis, follow the wiring procedure below using Belden 8761 cable.



ATTENTION: Care should be taken to avoid connecting a voltage source to a channel configured for current input. Improper module operation or damage to the voltage source can occur.



To wire your 1746-NI8 module follow these steps.

1. At each end of the cable, strip some casing to expose the individual wires.
2. Trim the signal wires to 2-inch lengths. Strip about 3/16 inch (5 mm) of insulation away to expose the end of the wire.
3. At one end of the cable, twist the drain wire and foil shield together. This end of the cable will be connected to one of the shield terminals on 1746-NI8 module. Connect shields for channels 0-3 to the upper shield terminal, and shields for channels 4-7 to the lower shield terminal.
4. At the other end of the cable, cut the drain wire and foil shield back to the cable.
5. Connect the signal wires and the shield drain wire to the 1746-NI8 terminal block. Connect the other end of the cable to the input device.
6. Repeat steps 1 through 6 for each channel on the module.

Preliminary Operating Considerations

This chapter explains how the analog input module and the SLC 500 processor communicate through the module's input and output image. It lists the preliminary setup and operation required before the module can function in a 1746 I/O system. Topics discussed include how to:

- enter the module ID code
- select the Class 1 or Class 3 interface
- address your 1746-NI8 module
- select the proper input filter for each channel
- calculate the module update time
- interpret the module response to slot disabling

Module ID Code

The module identification code is a unique number encoded for each 1746 I/O module. The code defines for the processor the type of I/O or specialty module residing in a specific slot in the 1746 chassis.

Catalog Number	ID Code
1746-NI8	3526 – Class 1 interface 12726 – Class 3 interface

Important: All programming software does not support configuration for Class 3 operation.

- Advanced Programming Software (APS) supports Class 3 configuration. After entering the ID code (12726), enter 16 input words and 12 output words.
- SLC 500 A.I. Series™ Programming Software supports Class 3 configuration. After entering the ID code (12726), enter 16 input words and 12 output words.
- RSLogix 500™, version 1.30 or later, supports Class 3 configuration. After entering the ID code (12726), select Class 3 operation.
- Earlier versions of RSLogix 500 will only support configuration for Class 1 operation. Contact Rockwell Software for information on upgrading your software.

Class 1 and Class 3 Interface

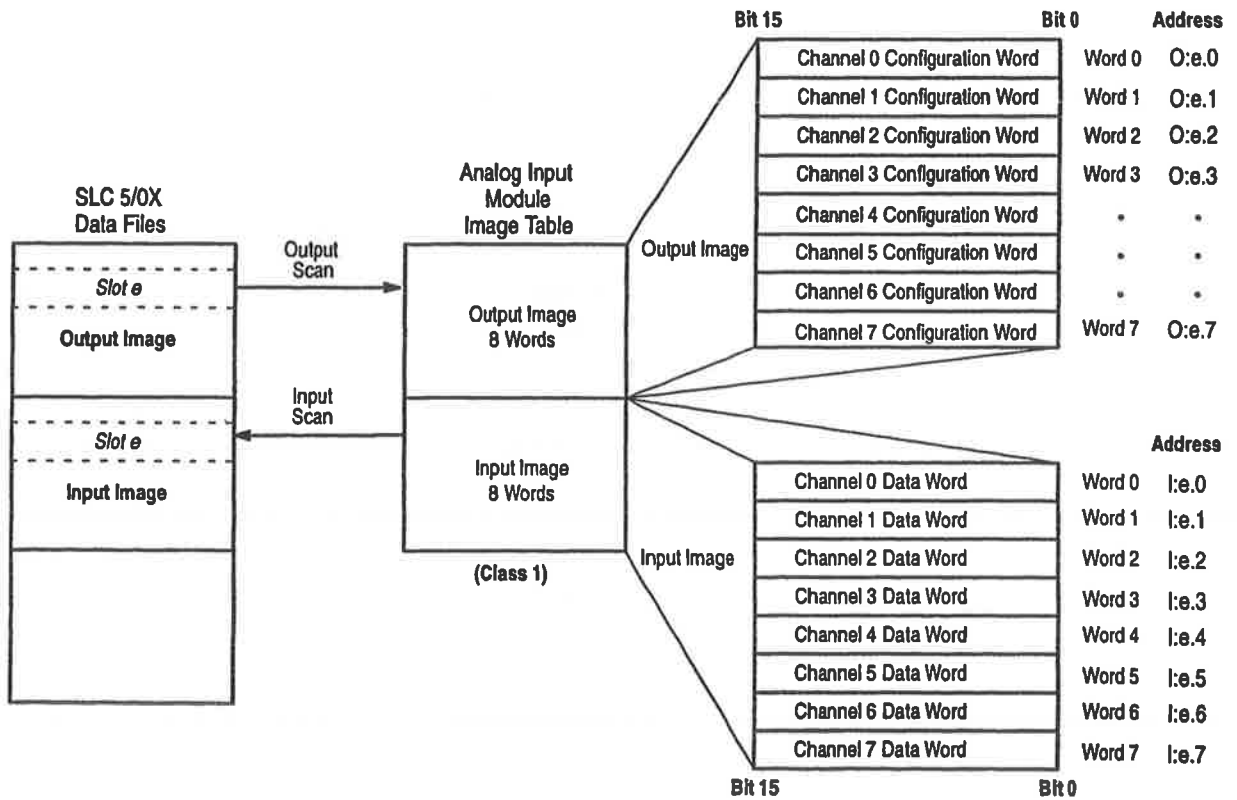
The 1746-NI8 analog input module has multiclass interface capabilities. Class 1 is the standard configuration. The module can be configured through the user program for Class 3 which enables user-defined data scaling and monitoring of channel status words.

Configuration	Class 1	Class 3
Compatible SLC Processors	SLC 500 fixed, SLC 5/01, SLC 5/02, SLC 5/03, and SLC 5/04	SLC 5/02, SLC 5/03, and SLC 5/04
Compatible Chassis	local chassis or remote chassis with a 1747-ASB module	local chassis
Input and Output Images	output image: 8 channel configuration words input image: 8 channel data words	output image: 8 channel configuration words and 4 limit ranges for user-defined scaling data format input image: 8 channel data words and 8 channel status words
Default	Class 1 is the default on power-up	Class 3 is programmable by user

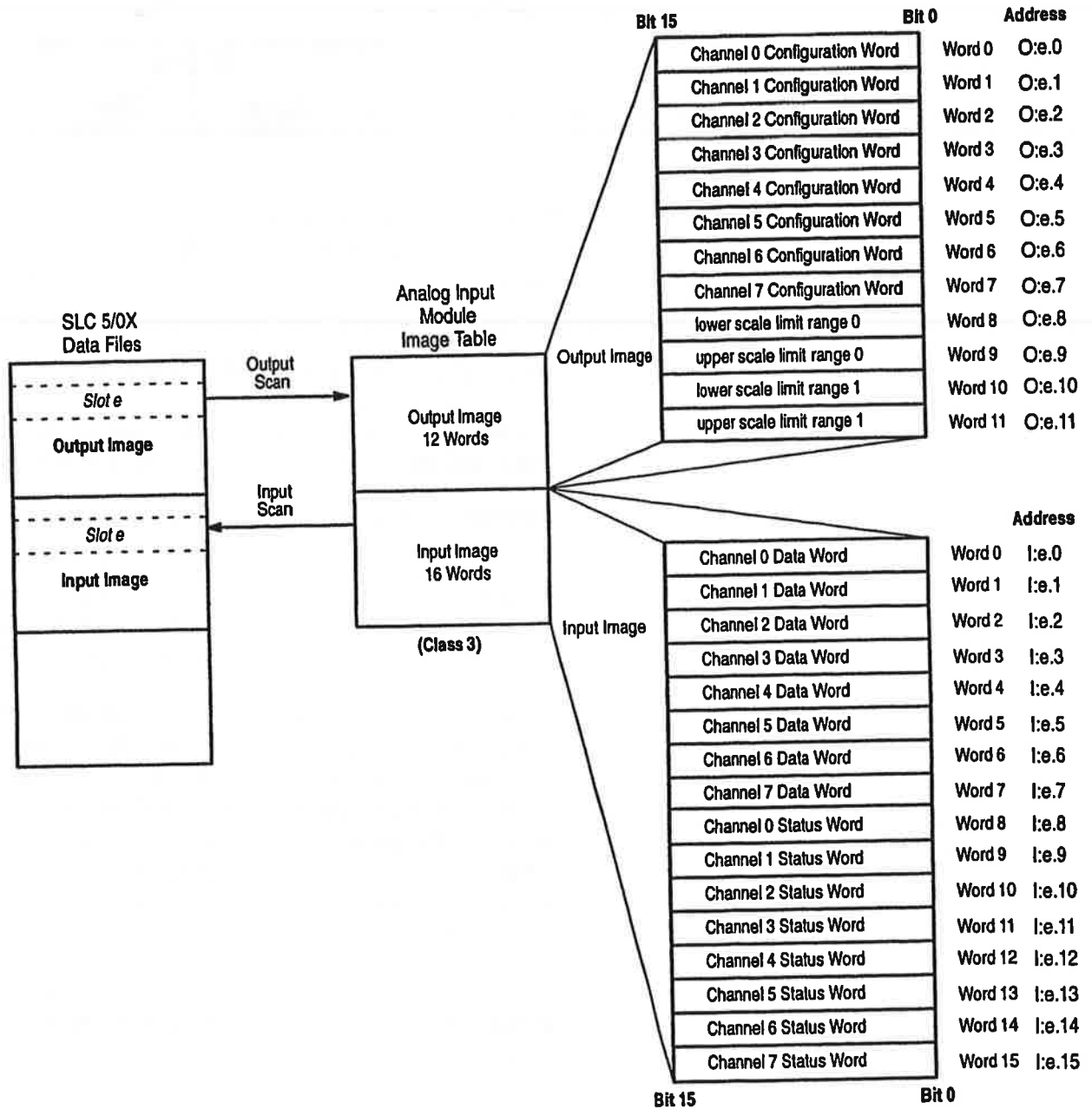
Module Addressing

The following memory maps show you how the input and output input image tables are defined for Class 1 and Class 3.

Class 1 Memory Map



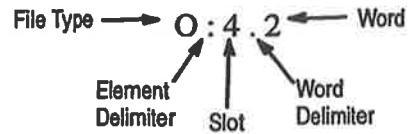
Class 3 Memory Map



Output Image – Configuration Words

The module output image (defined as the output from the processor to the module) contains information that you configure to define the way a specific module channel will work. Each output word configures a single channel.

Example – If you want to configure channel 2 on the analog module located in slot 4 in the chassis, your address would be O:4.2.



Chapter 5, *Channel Configuration, Data, and Status*, gives you detailed bit information about the data content of the configuration word.

Input Image – Data Words and Status Words

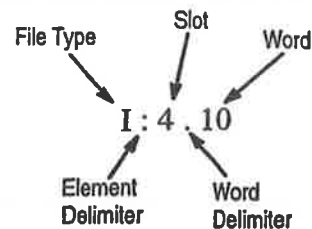
The input image (defined as the input from the module to the processor) represents data words and status words.

Important: Status words are only available when the module is configured for Class 3.

Input words 0–7 (data words) hold the input data that represent the value of analog inputs for channels 0–7. This data word is valid only when the channel is enabled and there are no channel errors.

Input words 8–15 (status words) contain the status of channels 0–7 respectively. The status bits for a particular channel reflect the configuration settings that you entered into the output image configuration word for that channel and provide information about the channel's operational state. To receive valid status information the channel must be enabled, and the channel must have processed any configuration changes that may have been made to the configuration word.

Example – To obtain the status of channel 2 (input word 10) of the analog module located in slot 4 in the SLC chassis, use address I:4.10.

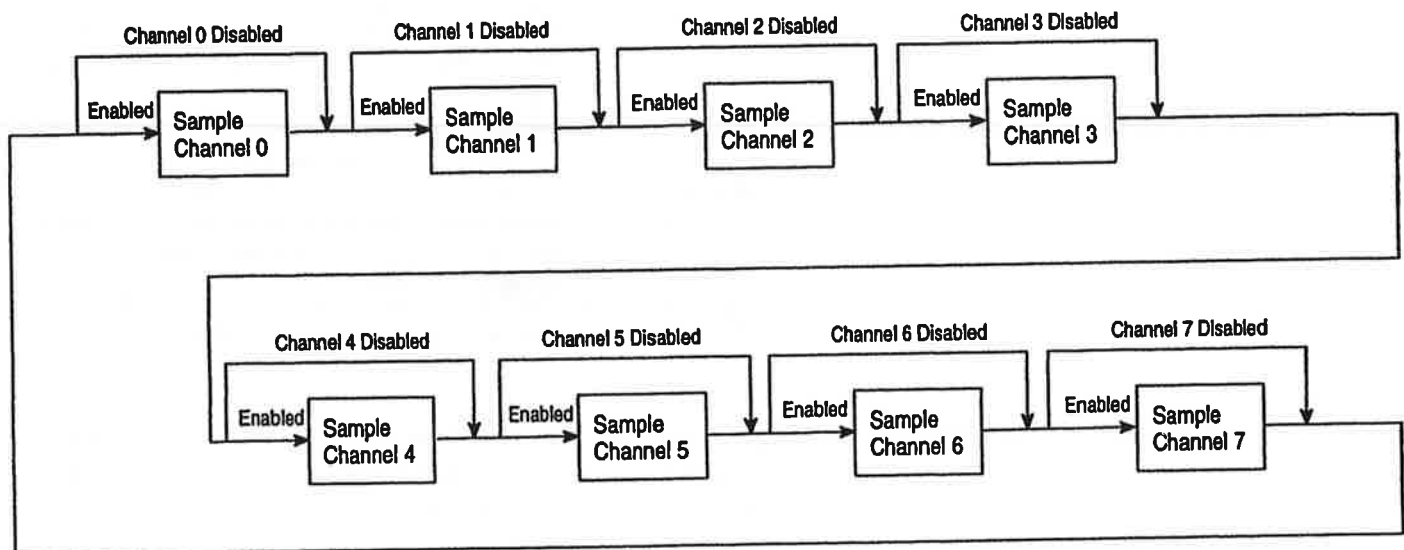


Chapter 5, *Channel Configuration, Data, and Status*, gives you detailed bit information about the content of the data word and the status word.

Module Update Time

The module update time is defined as the time required for the module to sample and convert the input signals of all enabled input channels and provide the resulting data values to the SLC processor. Module update time can be calculated by adding the the sum of all enabled channel sample times (0.75 msec per channel).

The 1746-NI8 module sequentially samples the channels in a continuous loop.



The following table shows the module update time. The module update time is the same regardless of the filter frequency. The fastest module update time occurs when only one channel is enabled. The slowest module update time occurs when 8 channels are enabled.

Module Update Time	
Number of Channels Enabled	Update Time
1	0.75 msec
2	1.50 msec
3	2.25 msec
4	3.00 msec
5	3.75 msec
6	4.50 msec
7	5.25 msec
8	6.00 msec

Channel Turn-On, Turn-Off, and Reconfiguration Times

The table below gives you the turn-on, turn-off, and reconfiguration times for enabling or disabling a channel.

	Description	Duration ^①
Turn-On Time	The time it takes to set the status bit (transition from 0 to 1) in the status word, after setting the enable bit in the configuration word.	101 to 107 msec maximum
Turn-Off Time	The time it takes to reset the status bit (transition from 1 to 0) in the status word, after resetting the enable bit in the configuration word.	1 to 7 msec maximum
Reconfiguration Time	The time it takes to change a channel configuration if the device type, filter frequency, or configuration error bits are different from the current setting. The enable bit remains in a steady state of 1. Changing data format does not require reconfiguration time.	101 to 107 msec maximum

^① The duration varies with the number of channels that are enabled.

Response to Slot Disabling

By writing to the status file in your modular SLC processor you can disable any chassis slot. Refer to your programming device's manual for the slot disable/enable procedure.



ATTENTION: Always understand the implications of disabling a module before using the slot disable feature.

Input Response

When a slot is disabled, the 1746-NI8 module continues to update its input image table. However, the SLC processor does not read inputs from a module that is disabled. Therefore, when the processor disables the module slot, the module inputs appearing in the processor image table remain in their last state, and the module's updated image table is not read. When the processor re-enables the module slot, the current state of the module inputs are read by the processor during the subsequent scan.

Output Response

The SLC processor may change the module output data (configuration) as it appears in the processor output image. However, this data is not transferred to the module. The outputs are held in their last state. When the slot is re-enabled, the current data in the processor image is transferred to the module.

Channel Filter Frequency Selection

The module uses a digital low pass filter that provides noise rejection for the input signals. The digital filter is programmable, allowing you to select from eight filter frequencies for each channel.

Selecting a low value (i.e., 1 Hz) for the channel filter frequency provides the best noise rejection for a channel. Selecting a high value for the channel filter frequency provides lower noise rejection and faster step response time. See page 4-10 for more information on noise rejection.

The following table shows the available filter frequencies and step response for each filter frequency.

Filter Frequency	Step Response Time		
	1% Accuracy ^①	0.1% Accuracy ^①	0.05% Accuracy ^①
1 Hz	730 msec + module update time	1100 msec + module update time	1200 msec + module update time
2 Hz	365 msec + module update time	550 msec + module update time	600 msec + module update time
5 Hz	146 msec + module update time	220 msec + module update time	240 msec + module update time
10 Hz	73 msec + module update time	110 msec + module update time	120 msec + module update time
20 Hz	36.5 msec + module update time	55 msec + module update time	60 msec + module update time
50 Hz	14.5 msec + module update time	22 msec + module update time	24 msec + module update time
75 Hz	10 msec + module update time	15 msec + module update time	18 msec + module update time
no filter	0.5 msec + module update time	0.75 msec + module update time	0.75 msec + module update time

^① The module accuracy for current inputs is 0.05%, and for voltage inputs is 0.1%.

Channel Step Response

The channel filter frequency determines the channel's step response. The step response is time required for the channel data word to reach a specified percentage of its expected final value. This means that if an input signal changes faster than the channel step response, a portion of that signal will be attenuated by the channel filter. The table above shows the step response for each filter frequency.

Channel Frequency

Channel Cut-Off Frequency

The channel filter frequency selection determines a channel's cut-off frequency, also called the -3 dB frequency. The cut-off frequency is defined as the point on the input channel frequency response curve where frequency components of the input signal are passed with 3 dB of attenuation. All frequency components at or below the cut-off frequency are passed by the digital filter with less than 3 dB of attenuation. All frequency components above the cut-off frequency are increasingly attenuated.

The cut-off frequency for each input channel is defined by its filter frequency selection. Choose a filter frequency so that your fastest changing signal is below that of the filter's cut-off frequency. The cut-off frequency should not be confused with update time. The cut-off frequency relates how the digital filter attenuates frequency components of the input signal. The update time defines the rate at which an input channel is scanned and its channel data word is updated.

Aliasing Frequency

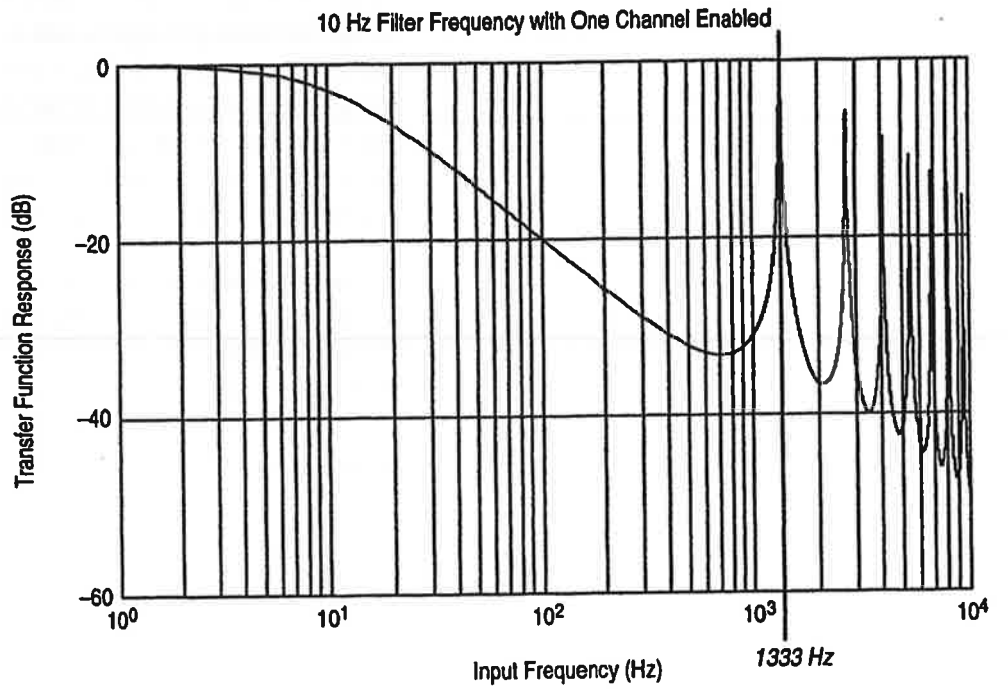
Aliasing is a natural characteristic of discrete time sampling of analog signals. This can result in erroneous data in the data channel word. Aliasing is usually not a problem because the duration of the high frequency signal is much shorter than the program scan time.

Aliasing begins at a lower frequency when more channels are enabled. Anti-aliasing filters are available, but it is recommended that you first check your transducer for malfunctions as the filters are fairly expensive.

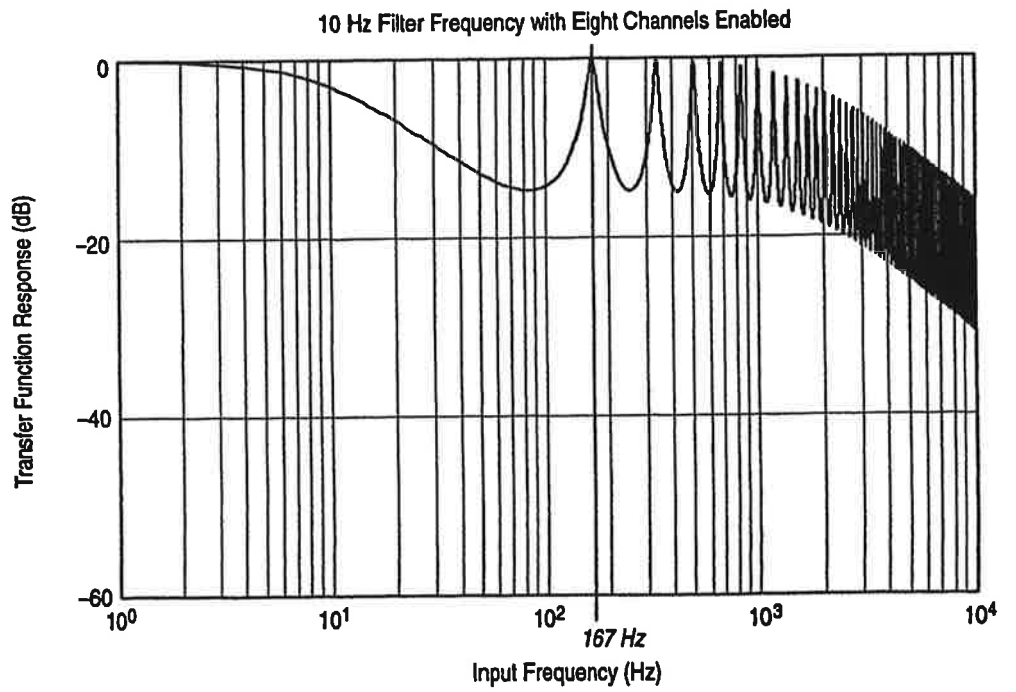
Aliasing occurs when unwanted signals, at a frequency greater than the effective sampling rate, are present. The effective sampling rate is determined by the number of enabled channels (n). The first aliasing frequency occurs at: $f_a = 1 / (n * 0.00075)$. Subsequent aliasing frequencies occur at integer multiples of f_a . The following table shows the first alias frequency, based on the number of channels enabled.

Aliasing Frequency for Number of Channels Enabled							
1 Channel	2 Channels	3 Channels	4 Channels	5 Channels	6 Channels	7 Channels	8 Channels
1333 Hz	666 Hz	444 Hz	333 Hz	267 Hz	222 Hz	190 Hz	167 Hz

The graph below shows the aliasing characteristic at a filter frequency of 10 Hz with one channel enabled.



The graph below shows the aliasing characteristic at a filter frequency of 10 Hz with eight channels enabled.



Noise Rejection

Rejection of common mode noise is inherent in the hardware design of the module. Common Mode Rejection is better than -75 dB for common mode DC signals and better than -100 dB for common mode 50 Hz and 60 Hz AC signals. The module performs well in the presence of common mode noise as long as the signals applied to the user terminals do not exceed the common mode voltage rating (± 10.5 Volts) of the module. Improper earth/chassis ground connections may be a source of common mode noise.

Rejection of normal mode noise is implemented in the firmware and is a function of the filter frequency selected by the user. A lower frequency filter will reject more normal mode noise than a higher frequency filter. Transducer power supply noise, transducer circuit noise, or process variable irregularities may be sources of normal mode noise.

Channel Configuration, Data, and Status

This chapter examines the channel configuration word and the channel status word bit by bit, and explains how the module uses configuration data and generates status during operation. It gives you information about how to:

- configure a channel
- scale the channel data
- check a channel's status

Channel Configuration

The channel configuration word is a part of the 1746-NI8 module's output image as shown below. The module output image uses 8 word values when the module is in Class 1 mode, and 12 word values when the module is in Class 3 mode. A description of the output image is shown below.

1746-NI8 Module Output Image – Channel Configuration			Class 1	Class 3
O:e.0	channel 0 configuration word	bit mapped field	•	•
O:e.1	channel 1 configuration word	bit mapped field	•	•
O:e.2	channel 2 configuration word	bit mapped field	•	•
O:e.3	channel 3 configuration word	bit mapped field	•	•
O:e.4	channel 4 configuration word	bit mapped field	•	•
O:e.5	channel 5 configuration word	bit mapped field	•	•
O:e.6	channel 6 configuration word	bit mapped field	•	•
O:e.7	channel 7 configuration word	bit mapped field	•	•
O:e.8	lower scale limit range 0	16 bit integer		•
O:e.9	upper scale limit range 0	16 bit integer		•
O:e.10	lower scale limit range 1	16 bit integer		•
O:e.11	upper scale limit range 1	16 bit integer		•

After module installation (and voltage or current is selected via the DIP switches) each channel must be configured to establish the way the channel operates. You configure the channel by entering bit values into the configuration word using your programming device. A bit-by-bit examination of the configuration word is provided in the chart on page 5-2. Programming is discussed in chapter 6. Addressing is explained in chapter 4.

The configuration word default setting is all zeros.

Channel Configuration Procedure

The channel configuration word consists of bit fields, the settings of which determine how the channel will operate. See the chart below and the descriptions that follow for configuration information. Appendix B contains a configuration worksheet.

After determining the configuration for each channel, follow the steps outlined in chapter 2, *Quick Start*, or in chapter 6, *Ladder Logic Configuration Examples*, to enter this configuration data into your ladder program and copy it to the 1746-NI8 module.

Channel Configuration Word (O:e.0 through O:e.11) – Bit Definitions

Bit(s)	Define	To Select ^①	Make these bit settings in the Channel Configuration Word																	
			15	14	13	12	11	10	9	8	7	6	5	4	3	2	1	0		
0-2	Input Type	SET DIP SWITCH TO "OFF" FOR VOLTAGE INPUT	± 10V dc														0	0	0	
			1-5V dc															0	0	1
			0-5V dc															0	1	0
			0-10V dc															0	1	1
		SET DIP SWITCH TO "ON" FOR CURRENT INPUT	0-20 mA															1	0	0
			4-20 mA															1	0	1
			± 20 mA															1	1	0
			0-1 mA															1	1	1
3-5	Data Format	Engineering Units														0	0	0		
		Scaled-for-PID														0	0	1		
		Proportional Counts														0	1	0		
		1746-NI4 Data Format														0	1	1		
		User Defined (Class 3)														1	0	0		
		User Defined (Class 3)														1	0	1		
		Illegal (configuration error)																		
		Illegal (configuration error)																		
6 and 7	Open Circuit	Zero															0	0		
		Upscale															0	1		
		Downscale															1	0		
		Illegal																		
8-10	Filter Frequency	No Filter							0	0	0									
		75 Hz							0	0	1									
		50 Hz							0	1	0									
		20 Hz							0	1	1									
		10 Hz							1	0	0									
		5 Hz							1	0	1									
		2 Hz							1	1	0									
		1 Hz							1	1	1									
11	Channel Enable	Channel Disabled						0												
		Channel Enabled						1												
12-15	Unused	Unused ^②	0	0	0	0														

① In addition to programming the configuration word, you must also use the DIP switches to select voltage or current.

② Ensure unused bits 12-15 are always be set to zeros.

Select Input Type (Bits 0-2)

The input type bit field lets you configure the channel for the type of input device you have connected to the module. Valid input is an analog voltage or current that provides a signal within one of the specified ranges.

Determine the input device type for a channel and enter its respective 3-digit binary code in bit field 0-2 of the channel configuration word. You must also set the DIP switches of the module for voltage or current.

Select Data Format (Bits 3-5)

Select a data format for the data word value. Your selection determines how the analog input value from the A/D converter will be expressed in the data word. Enter your 3-digit binary code in bit field 3-5 of the channel configuration word.

The data types are engineering units, scaled-for-PID, proportional counts, 1746-NI4 data format, and user defined scaling for Class 3 operation only. For all data types, the channel data word is proportional to the analog input signal.

To have the data in "real" units, the channel data word must be scaled mathematically. See *Channel Data Word* on page 5-5 for the default scaling values and *Scaling the Data Channel Word* on page 5-6 for data type descriptions and scaling examples.

Select Open Circuit State (Bits 6 and 7)

Determine the desired state for the channel data word if an open circuit condition is detected for that channel. Enter the 2-digit binary code in bit field 6-7 of the channel configuration word. Open circuit errors are only detected for 4-20 mA input types (bits 6-7 are ignored for other input types). The open circuit options are zero, upscale, and downscale.

- If zero is selected, the channel data word is forced to 0 during an open-circuit condition.
- Selecting upscale forces the channel data word value to its full scale value during an open-circuit condition. The full scale value is determined by the selected input type and data format.
- Selecting downscale forces the channel data word value to its low scale value during an open-circuit condition. The low scale value is determined by the selected input type and data format.

Important: The processor may continue receiving data values for a period of time after the open circuit condition occurs until when the condition is flagged. The module indicates an open circuit within one module scan times. The module response time is shown below.

Module Response to Open Circuit	
Number of Channels Enabled	Response Time (maximum)
1	0.75 msec
2	1.50 msec
3	2.25 msec
4	3.00 msec
5	3.75 msec
6	4.50 msec
7	5.25 msec
8	6.00 msec

Select Channel Filter Frequency (Bits 8–10)

Determine the desired input filter frequency for the channel and enter the 3-digit binary code in bit field 8–10 of the channel configuration word.

The channel filter frequency bit field lets you select one of 8 filters available for a channel. The filter frequency affects the noise rejection characteristics. A lower filter frequency increases the noise rejection, and a higher filter frequency decreases the noise rejection. Select a filter frequency considering acceptable noise and step response time. See Channel Filter Frequency Selection on page 4-7 for more information on filter frequency.

Select Channel Enable (Bit 11)

Determine which channels are used in your program and enable them. Place a one in bit 11 if the channel is to be enabled. Place a zero in bit 11 if the channel is to be disabled.

The 1746-NI8 module only scans those channels that are enabled. To optimize module operation and minimize throughput times, *unused channels should be disabled* by setting the channel enable bit to zero.

When set (1) the channel enable bit is used by the module to read the configuration word information you have selected. While the enable bit is set, modification of the configuration word may lengthen the module update time for one cycle. If any change is made to the configuration word, the change must be reflected in the status word before new data is valid.

While the channel enable bit is cleared (0), the channel data word and status word values are cleared. After the channel enable bit is set, the channel data word and status word remain cleared until the module sets the channel status bit (bit 11) in the channel status word. (Refer to Channel Status on page 5-11.)

Unused Bits (Bits 12-15)

Bits 12-15 are not defined. Ensure these bits are always set to zero.

Channel Data Word

The module input image uses 8 data word values whether the module is in Class 1 or Class 3 mode. The converted voltage or current input data values reside in I:e.0 through I:e.7 of the module's input image file. When an input channel is disabled, its data word is reset to zero.

			Class 1	Class 3
I:e.0	channel 0 data word	16 bit integer	•	•
I:e.1	channel 1 data word	16 bit integer	•	•
I:e.2	channel 2 data word	16 bit integer	•	•
I:e.3	channel 3 data word	16 bit integer	•	•
I:e.4	channel 4 data word	16 bit integer	•	•
I:e.5	channel 5 data word	16 bit integer	•	•
I:e.6	channel 6 data word	16 bit integer	•	•
I:e.7	channel 7 data word	16 bit integer	•	•

The channel data word contains a 16-bit integer that represents the value of the analog input channel. The tables below show the channel data word values for various input types and data formats. The second table shows the default full-scale values for the proportional counts data format. The table does not imply the entire data value range is usable resolution.

Input Type	Signal Range	Engineering Units	Engineering Units Scale
±10V dc	-10.25V to +10.25V	-10250 to +10250	1mV/step
0-5V dc	-0.5V to +5.5V	-500 to +5500	1mV/step
1-5V dc	+0.5V to +5.5V	+500 to +5500	1mV/step
0-10V dc	-0.5V to +10.25V	-500 to +10250	1mV/step
0-20 mA	-0.5 mA to 20.5 mA	-500 to 20500	1.0uA/step
4-20 mA	3.5 mA to 20.5 mA	3500 to 20500	1.0uA/step
±20 mA	-20.5 mA to 20.5 mA	-20500 to 20500	1.0uA/step
0-1 mA	-0.05 mA to 1.05 mA	-50 to 1050	1.0uA/step

Channel Data Word Values for Scaled Data				
Input Type	Signal Range	Scaled-for-PID	Proportional Counts (default)	NI4 Data Format
±10V dc	-10.00V to +10.00V	0 to 16383	-32768 to 32767	-32768 to 32767
0-5V dc	0.0V to +5.00V	0 to 16383	-32768 to 32767	0 to 16384
1-5V dc	+1.00V to +5.00V	0 to 16383	-32768 to 32767	3277 to 16384
0-10V dc	0.0V to +10.00V	0 to 16383	-32768 to 32767	0 to 32767
0-20 mA	0.0 mA to 20.0 mA	0 to 16383	-32768 to 32767	0 to 16384
4-20 mA	4.0 mA to 20.0 mA	0 to 16383	-32768 to 32767	3277 to 16384
±20 mA	-20.0 mA to 20.0 mA	0 to 16383	-32768 to 32767	-16384 to 16384
0-1 mA	0.0 mA to 1.00 mA	0 to 16383	-32768 to 32767	0 to 1000 ^①

^① This data format is not supported by the 1746-NI4 module, but is available for the 1746-NI8 module.

Scaling the Channel Data Word

This section provides descriptions of how the data types are expressed in the channel data word and examples of how to mathematically convert the data.

Data Type Descriptions

The **engineering units** are 1 mV/step for voltage input types, and 1.0 μ A/step for current input types.

The **scaled-for-PID** value is a 14-bit unsigned integer, with 0 representing the low scale value and 16,383 representing the full scale value minus 1 lsb. The input signal range is proportional to your selected input type and scaled into a 0-16,383 range, which is standard to the SLC PID algorithm.

The **proportional count** value is a 16-bit signed integer. The input signal range is proportional to your selected input and scaled into a -32,768 to 32,767 range.

The **1746-NI4 data format** converts the current and voltage signals into 16-bit 2's complement binary values. The table below identifies the current and voltage input ranges for the input channels, the number of significant bits, and the resolution.

Voltage/Current Range	Decimal Representation	Number of Significant Bits	Resolution per LSB
-10V dc to +10V dc - 1LSB	-32,768 to +32,767	16 bits	305.176 μ V
0 to 5V dc	0 to 16,384	14 bits	
1 to 5V dc	3,277 to 16,384	13.67 bits	
0 to 10V dc - 1LSB	0 to 32,767	15 bits	

Voltage/Current Range	Decimal Representation	Number of Significant Bits	Resolution per LSB
0 to 20 mA	0 to 16,384	14 bits	1.22070 μ A
4 to 20 mA	3,277 to 16,384	13.67 bits	
-20 mA to +20 mA	-16,384 to +16,384	15 bits	
0 to 1 mA	0 to 1000	10 bits	1 μ A ^①

^① This data format is not supported by the 1746-NI4 module, but is available for the 1746-NI8 module.

User defined scaling count (Class 3 operation only) allows the output image data words 8 and 9 (or words 10 and 11) to be selected to represent low scale and high scale limits. The module uses these limits and scales proportionately between them. For example, if words 8 and 9 are selected to represent low and high scaling ranges (data format select bits = 100 binary), and word 8 contains 0000 hex (0 decimal), and word 9 contains 4E20 hex (20000 decimal), this would represent the range of values that the voltage or current readings would be scaled into. The lowest voltage or current reading would be scaled to 0, and the highest voltage or current reading would be scaled to 20000, with other readings scaled proportionately between them.

If the module is in Class 1 mode and you attempt to configure for user defined proportional counting, a configuration error will be generated.

Using Scaled-for-PID and Proportional Counts

The scaled-for-PID and proportional count selections provide the highest display resolution, but also require you to manually convert the channel data to "real" units.

Scaling Examples

The following scaling examples show how to convert the channel data word from the configured data type to “real” units. “Real” units are the values being measured such as temperature and pressure. To perform the scaling, you must know the defined voltage or current range for the channel’s input type. The lowest possible value for an input type is S_{LOW} , and the highest possible value is S_{HIGH} . Refer to the Channel Data Word Value tables on pages 5-5 and 5-6 for the data channel word ranges.

Engineering Units to “Real” Units

Situation #1: A transducer is being used to measure temperature.
The 4–20 mA signal is proportional to 100–500°C (212–932°F).
The channel data word is in engineering units format.
The channel data = 5500.

Find: “Real” units equivalent in °F.

$$\text{Equation: } \textit{Real Units Equivalent} = \textit{channel data value} \times (\textit{scaling factor}) \times \left(\frac{S_{HIGH} - S_{LOW}}{\textit{input range}} \right)$$

where: $S_{LOW} = 212^{\circ}\text{F}$
 $S_{HIGH} = 932^{\circ}\text{F}$
channel data word = 5500
scaling for engineering units = 1 μA per step

$$\text{Solution: } \textit{Real Units Equivalent} = 5500 \times (1 \mu\text{A}) \times \left(\frac{932^{\circ}\text{F} - 212^{\circ}\text{F}}{20 \text{mA} - 4 \text{mA}} \right) = 247.5^{\circ}\text{F}$$

Situation #2: A transducer is being used to measure temperature.
The 0–10V dc signal is proportional to 0–10°C.
The channel data word is in engineering units format.
The channel data = 5000.

Find: “Real” units equivalent in °C.

$$\text{Equation: } \textit{Real Units Equivalent} = \textit{channel data value} \times (\textit{scaling factor}) \times \left(\frac{S_{HIGH} - S_{LOW}}{\textit{input range}} \right)$$

where: $S_{LOW} = 0^{\circ}\text{C}$
 $S_{HIGH} = 10^{\circ}\text{C}$
channel data word = 5000
scaling for engineering units = 1 mV per step

$$\text{Solution: } \textit{Real Units Equivalent} = 5000 \times (1 \text{mV}) \times \left(\frac{10^{\circ}\text{C} - 0^{\circ}\text{C}}{10\text{V dc} - 0\text{V dc}} \right) = 5.000^{\circ}\text{C}$$

► **TIP** If you are measuring a “real” voltage or current, then selecting engineering units allows the module to report “real” values without further scaling. For example, a 4.683V dc signal would produce a channel data word of 4683.

Scaled-for-PID to "Real" Units

Situation: A transducer is being used to measure temperature.
The 4–20 mA signal is proportional to 100–500°C (212–932°F).
The channel data word is in scaled-for-PID format.
The channel data = 5500.

Find: "Real" units equivalent in °F.

$$\text{Equation: } \textit{Real Units Equivalent} = S_{LOW} + \left[(S_{HIGH} - S_{LOW}) \times \left(\frac{\textit{channel data value}}{\textit{full scale default PID value}} \right) \right]$$

where: $S_{LOW} = 212^{\circ}F$
 $S_{HIGH} = 932^{\circ}F$
channel data word = 5500
full scale PID default value (from table on page 5–6) = 16383

$$\text{Solution: } \textit{Real Units Equivalent} = 212^{\circ}F + \left[(932^{\circ}F - 212^{\circ}F) \times \left(\frac{5500}{16383} \right) \right] = 453.71^{\circ}F$$

Proportional Counts to "Real" Units

Situation: A transducer is being used to measure pressure.
The –10V dc to +10V dc signal is proportional to 0 to 200 psi.
The channel data word is in proportional counts data format.
The channel data = 21567.

Find: "Real" units equivalent in psi.

$$\text{Equation: } \textit{Real Units Equivalent} = S_{LOW} + \left[(S_{HIGH} - S_{LOW}) \times \frac{(\textit{data value} + |\textit{proportional count low default value}|)}{(\textit{proportional count full scale default value})} \right]$$

where: $S_{LOW} = 0 \text{ psi}$
 $S_{HIGH} = 200 \text{ psi}$
channel data = 21567
proportional count low default value (from table on page 5–6) = –32768
proportional count full scale default value (from table on page 5–6) = 65535

$$\text{Solution: } \textit{Real Units Equivalent} = 0 \text{ psi} + \left[(200 \text{ psi} - 0 \text{ psi}) \times \frac{(21567 + |-32768|)}{(65535)} \right] = 165.55 \text{ psi}$$

1746-NI4 Data Format Units to "Real" Units

Situation: A transducer is being used to measure flow rate.
The -10V dc to +10V dc signal is proportional to 0-100 GPM.
The channel data word is in 1746-NI4 data format.
The channel data = 10000.

Find: "Real" units equivalent in GPM.

$$\text{Equation: } \textit{Real Units Equivalent} = \textit{channel data value} \times \left(\frac{S_{HIGH} - S_{LOW}}{\textit{input range}} \right)$$

where: $S_{LOW} = 0 \text{ GPM}$
 $S_{HIGH} = 100 \text{ GPM}$
channel data word = 5500
NI4 full scale default value (from table on page 5-6) = 65535

$$\text{Solution: } \textit{Real Units Equivalent} = 10000 \times \left(\frac{100 \text{ GPM} - 0 \text{ GPM}}{65535} \right) = 15.26 \text{ GPM}$$

User Defined Limits Data Format to "Real" Units

Situation: A transducer is being used to measure pressure.
The -10V dc to +10V dc signal is proportional to 0-200 psi.
The channel data word is in user defined data format.
The lower scale limit (configuration word 8) = 0.
The upper scale limit (configuration word 9) = 20000.
The channel data word = 16600.

Find: "Real" units equivalent in psi.

$$\text{Equation: } \textit{Real Units Equivalent} = \textit{channel data word} \times \left[\frac{(S_{HIGH} - S_{LOW})}{(\textit{upper scale limit} - \textit{lower scale limit})} \right]$$

where: $S_{LOW} = 0 \text{ psi}$
 $S_{HIGH} = 200 \text{ psi}$

$$\text{Solution: } \textit{Real Units Equivalent} = 16600 \times \left[\frac{(200 \text{ psi} - 0 \text{ psi})}{(20000 - 0)} \right] = 166.00 \text{ psi}$$

Channel Status Checking

If the module is in Class 3 mode, there are an additional 8 input image words available for status information. The channel status word is a part of the module's input image. Input words 8-15 correspond to and contain the configuration status of channels 0-7. You can use the data provided in the status word to determine if the input configuration data for any channel is valid per your configuration in O:e.0 through O:e.7.

For example, whenever a channel is disabled (O:e.x/11 = 0), its corresponding status word shows all zeros. This condition tells you that input data contained in the data word for that channel is not valid and should be ignored.

1746-NI8 Module Input Image - Status Word			Class 1	Class 3
I:e.8	channel 0 status word	bit mapped field		•
I:e.9	channel 1 status word	bit mapped field		•
I:e.10	channel 2 status word	bit mapped field		•
I:e.11	channel 3 status word	bit mapped field		•
I:e.12	channel 4 status word	bit mapped field		•
I:e.13	channel 5 status word	bit mapped field		•
I:e.14	channel 6 status word	bit mapped field		•
I:e.15	channel 7 status word	bit mapped field		•

The channel status word can be analyzed bit by bit. In addition to providing information about an enabled or disabled channel, each bit's status (0 or 1) tells you how the input data from the voltage or current analog sensor connected to a specific channel will be translated for your application. The bit status also informs you of any error condition and can tell you what type of error occurred.

A bit-by-bit examination of the status word is provided in the chart on the following page.

Channel 0-7 Status Word (I:e.8 through I:e.15) - Bit Definitions

Bit(s)	Define	These bit settings														Indicate this		
		15	14	13	12	11	10	9	8	7	6	5	4	3	2		1	0
0-2	Input Type														0	0	0	± 10 V dc
															0	0	1	1-5V dc
															0	1	0	0-5V dc
															0	1	1	0-10V dc
															1	0	0	0-20 mA
															1	0	1	4-20 mA
															1	1	0	± 20 mA
													1	1	1	0-1 mA		
3-5	Data Format													0	0	0	Engineering Units	
														0	0	1	Scaled-for-PID	
														0	1	0	Proportional Counts	
														0	1	1	1746-NI4 Data Format	
														1	0	0	User Defined (Class 3)	
														1	0	1	User Defined (Class 3)	
																		Illegal (configuration error)
6 and 7	Open Circuit																Zero	
																	Upscale	
																	Downscale	
																	Illegal (configuration error)	
8-10	Filter Frequency						0	0	0								No Filter	
							0	0	1								75 Hz	
							0	1	0								50 Hz	
							0	1	1								20 Hz	
							1	0	0								10 Hz	
							1	0	1								5 Hz	
							1	1	0								2 Hz	
					1	1	1								1 Hz			
11	Channel Status					0											Channel Disabled	
						1											Channel Enabled	
12	Open Circuit Error				0												No Error	
					1												Open Circuit Detected	
13	Over-Range Error			0													No error	
				1													Over-Range Condition	
14	Under-Range Error		0														No Error	
			1														Under-Range Condition	
15	Configuration Error	0															No Error	
		1															Configuration Error	

Important: If the channel for which you are seeking status is disabled (bit O:e.x/11 = 0), all bit fields are cleared. The status word for any disabled channel is always 0000 0000 0000 0000 regardless of any previous setting that may have been made to the configuration word.

Explanations of the status conditions follow.

Input Type Status (Bits 0-2)

The input type bit field indicates what type of input signal you have configured for the channel. This field reflects the input type defined in the channel configuration word. The input field is cleared when the channel is disabled.

Data Format Type Status (Bits 3-5)

The data format bit field indicates the data format you have defined for the channel. This field reflects the data type selected in the channel configuration word. The data format field is cleared when the channel is disabled.

Open Circuit Type Status (Bits 6 and 7)

The open circuit bit field indicates how you have defined the response of the module to an open circuit condition. This feature is active for the 4-20 mA input type only. The open circuit field is cleared when the channel is disabled.

Channel Filter Frequency (Bits 8-10)

The channel filter frequency bit field reflects the filter frequency you selected in the configuration word. This feature is active for all current and voltage input types. The filter frequency bit field is cleared while the channel is disabled.

Channel Status (Bit 11)

The channel status bit indicates the operational state of the channel. Once the channel enable bit is set, the module will configure the channel and take the first data sample of the channel data word before setting the channel status bit. The channel status bit is cleared upon power up and reset.

Open Circuit Error (Bit 12)

The open circuit error bit is set (1) whenever the channel detects an open circuit condition at its input. The open circuit error is active for the 4–20 mA input type only. The open circuit error state will always take precedence over the out-of-range error states. There will never be an out-of-range error when an open circuit is detected. The open circuit error bit is cleared when the channel is disabled or when the open circuit condition is removed.

Over-Range Error (Bit 13)

The over-range error bit is set (1) whenever a configured channel detects an over-range condition for the channel data. An over-range condition exists when the input value is above the specified upper limit of the particular sensor connected to that channel. The over-range bit is cleared when the channel is disabled.

Under-Range Error (Bit 14)

The under-range error bit is set (1) whenever a configured channel detects an under-range condition for the channel data. An under-range condition exists when the input value is below the specified lower limit of the particular sensor connected to that channel. The under-range bit is cleared when the channel is disabled.

Configuration Error (Bit 15)

The configuration error bit is set (1) whenever a configured channel detects that the channel configuration word is not valid. All other status bits reflect the settings from the configuration word (even those settings that may be in error). The configuration error bit is cleared when the channel is disabled.

Ladder Logic Configuration Examples

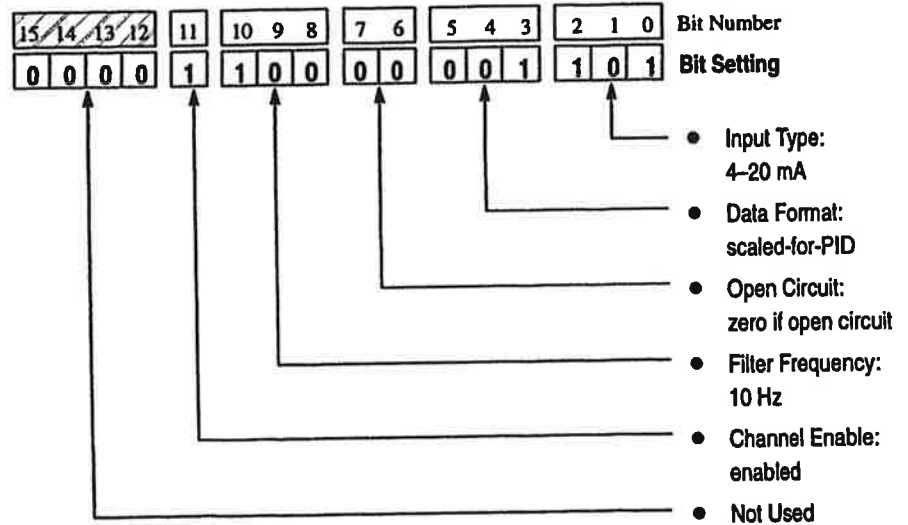
Earlier chapters explained how the configuration word defines the way a channel operates. This chapter shows the programming required to enter the configuration word into the processor memory. It also provides you with segments of ladder logic specific to unique situations that might apply to your programming requirements. The example segments include:

- initial programming of the configuration word
- interfacing the analog module to a PID instruction
- monitoring channel status bits (Class 3 Mode only)

Initial Programming

To enter data into the channel configuration word (O:e.0 through O:e.7) when the channel is disabled (bit 11 = 0), follow these steps. Refer to page 5-2 for specific configuration details.

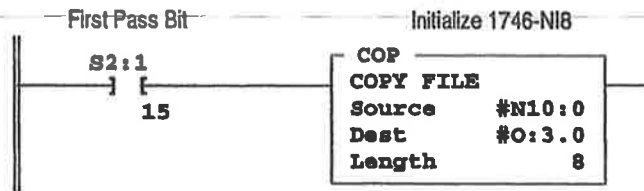
Example - A 1746-NI8 analog module is residing in slot 3 of a 1746 chassis. Configure all eight channels with the same parameters.



This example transfers configuration data and sets the channel enable bits of all eight channels with a single File Copy instruction.

Procedure

1. Create integer file N10. Integer file N10 should contain eight elements (N10:0 through N10:7).
2. Enter the configuration parameters for all eight analog input channels into a source integer data file N10. See Appendix B for the channel configuration worksheet.
3. Program a rung in your ladder logic to copy the contents of integer file N10 to the eight consecutive output words of the 1746-NI8 analog module beginning with word O:3.0.



On power up, bit S2:1/15 is set for the first program scan, and integer file N10 is sent to the eight 1746-NI8 channel configuration words.

DATA FILE N10

Offset	15	14	13	12	11	10	9	8	7	6	5	4	3	2	1	0
N10:0	0	0	0	0	1	1	0	0	0	0	0	0	1	1	0	1
N10:1	0	0	0	0	1	1	0	0	0	0	0	0	1	1	0	1
N10:2	0	0	0	0	1	1	0	0	0	0	0	0	1	1	0	1
N10:3	0	0	0	0	1	1	0	0	0	0	0	0	1	1	0	1
N10:4	0	0	0	0	1	1	0	0	0	0	0	0	1	1	0	1
N10:5	0	0	0	0	1	1	0	0	0	0	0	0	1	1	0	1
N10:6	0	0	0	0	1	1	0	0	0	0	0	0	1	1	0	1
N10:7	0	0	0	0	1	1	0	0	0	0	0	0	1	1	0	1

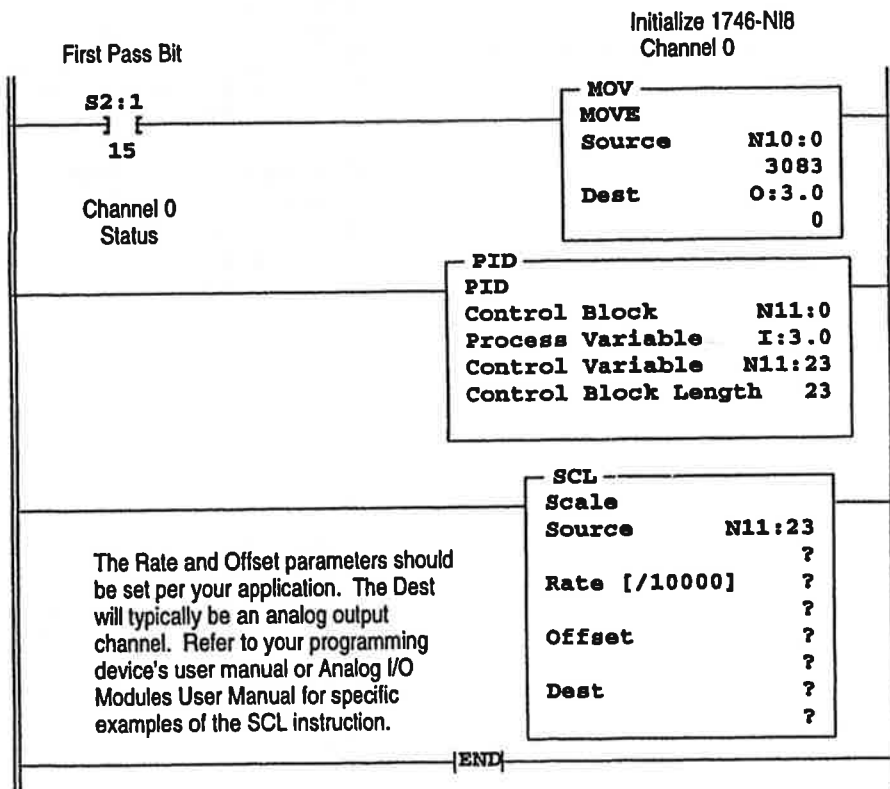
Interfacing to the PID Instruction

The analog input module was designed to interface directly to the SLC 5/02™ or later processor PID instruction without the need for an intermediate scale operation.

Example - Use 1746-NI8 channel data as the process variable in the PID instruction.

1. Select *scaled-for-PID* as the data format in the channel configuration word.
2. Specify the 1746-NI8 channel data word as the process variable for the PID instruction.

Program Listing



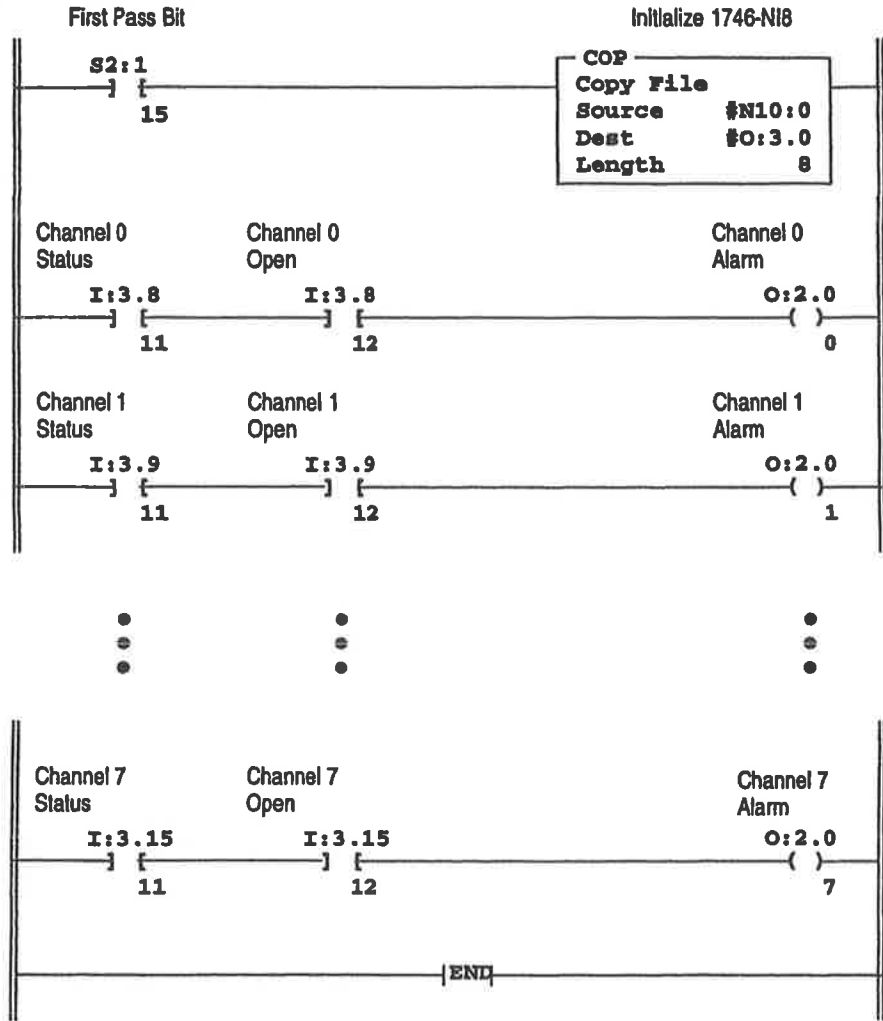
DATA FILE N10

Offset	15	14	13	12	11	10	9	8	7	6	5	4	3	2	1	0
N10:0	0	0	0	0	1	1	0	0	0	0	0	0	1	1	0	1

Monitoring Channel Status Bits (Class 3 Mode Only)

This example shows how you could monitor the open circuit error bits of each channel and set an alarm in the processor if one of the channels opens. An open circuit error can occur if the analog input device breaks, or one of the sensor wires gets cut or disconnected from the terminal block.

Program Listing



DATA FILE N10

Offset	15	14	13	12	11	10	9	8	7	6	5	4	3	2	1	0
N10:0	0	0	0	0	1	1	0	0	0	0	0	0	1	1	0	1
N10:1	0	0	0	0	1	1	0	0	0	0	0	0	1	1	0	1
N10:2	0	0	0	0	1	1	0	0	0	0	0	0	1	1	0	1
N10:3	0	0	0	0	1	1	0	0	0	0	0	0	1	1	0	1
N10:4	0	0	0	0	1	1	0	0	0	0	0	0	1	1	0	1
N10:5	0	0	0	0	1	1	0	0	0	0	0	0	1	1	0	1
N10:6	0	0	0	0	1	1	0	0	0	0	0	0	1	1	0	1
N10:7	0	0	0	0	1	1	0	0	0	0	0	0	1	1	0	1

Module Diagnostics and Troubleshooting

This chapter describes troubleshooting using the channel status LEDs as well as the module status LED. It explains the types of conditions that might cause an error to be reported and gives suggestions on how to resolve the problem. Major topics include:

- module operation vs. channel operation
- power-up diagnostics
- channel diagnostics
- LED indicators
- troubleshooting flowchart
- replacement parts
- contacting Allen-Bradley

Module Operation vs. Channel Operation

The module performs operations at two levels:

- module level operations
- channel level operations

Module level operations include functions such as power-up configuration and communication with the SLC processor.

Channel level operations describe channel-related functions, such as data conversion and open-circuit detection.

Internal diagnostics are performed at both levels of operation and any error conditions detected are immediately indicated by the module's LEDs.

Power-Up Diagnostics

At module powerup, a series of internal diagnostic tests is performed. These diagnostic tests must be successfully completed or a module error results and the module status LED remains off.

Channel Diagnostics

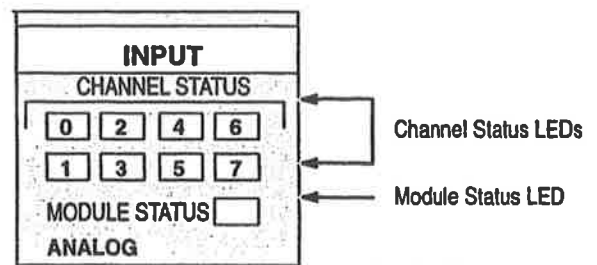
When a channel is enabled (bit 11 = 1), a diagnostic check is performed to see that the channel has been properly configured. In addition the channel is tested on every scan for configuration errors, over-range, under-range, and, for the 4–20 mA input type, open-circuit conditions.

A failure of any channel diagnostic test causes the faulted channel status LED to blink. All channel faults are indicated in bits 12–15 of the channel's status word. Channel faults are self-clearing. When the fault conditions are corrected, the channel status LED will stop blinking and resume steady illumination.

Important: If you clear (0) a channel enable bit (11) all channel status information is reset.

LED Indicators

The module has nine LEDs. Eight of these are channel status LEDs numbered to correspond to each of the input channels, and one is a module status LED.



LED State Table

If Module Status LED Is:	And Channel Status LED Is:	Indicated Condition:	Corrective action:
On	On	Channel Enabled	No action required.
	Blinking	Open-Circuit Condition	To determine the exact error, check the error bits in the input image. Check the channel configuration word for valid data. Make sure that the data format is indicated correctly in bits 3–5, and that the open-circuit selection state (bits 6 and 7) is valid. Refer to the troubleshooting flowchart on page 7-5 and to chapter 5 for more information.
		Out-of-Range Condition	
		Channel Configuration Error	
	Off	Power-Up	No action required.
Channel Not Enabled		No action required. For an example of how to enable a channel refer to chapter 2, Quick Start, or chapter 6, Ladder Logic Configuration Examples.	

Module Status LED State Table

If Module Status LED Is:	Indicated condition:	Corrective action:
On	Proper Operation	No action required.
Off	Module Fault	Cycle power. If condition persists, call your local distributor or Allen-Bradley for assistance.

Channel Status LEDs (Green)

The channel status LED is used to indicate channel status and related error information contained in the channel status word. This includes conditions such as:

- normal operation
- channel-related configuration errors
- open-circuit errors
- out-of-range errors

All channel errors are recoverable errors and after corrective action, normal operation resumes.

Invalid Channel Configuration

Whenever a channel's configuration word is improperly defined, the channel status LED blinks and bit 15 of the channel status word is set. Configuration errors occur when the data format (bits 3–5 in the channel configuration word) is invalid, or when the open-circuit state selection (bits 6 and 7) is invalid.

Open-Circuit Detection

An open-circuit test is performed on all enabled channels configured for 4–20 mA input. Whenever an open-circuit condition occurs (see possible causes listed below), the channel status LED blinks and bit 12 of the channel status word is set.

Possible causes of an open-circuit include:

- The sensing device may be broken.
- A wire may be loose or cut.
- The sensing device may not have been installed on the configured channel.

If an open-circuit is detected, the channel data word reflects input data as defined by the open-circuit bits (6 and 7) in the channel configuration word.

Out-Of-Range Detection

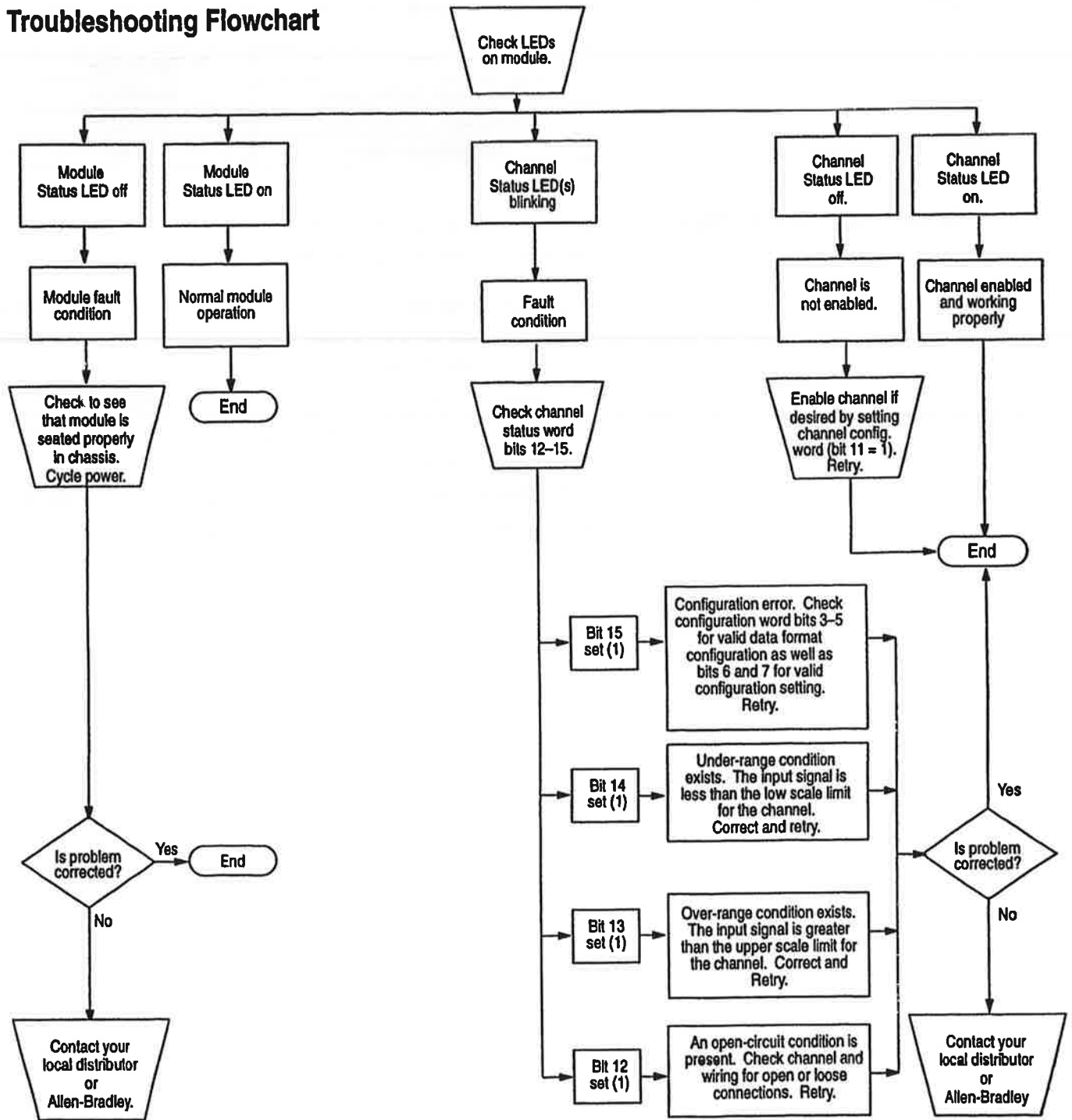
Whenever the data received at the channel data word is out of the defined operating range, an over-range or under-range error is indicated and bit 13 (over-range) or bit 14 (under-range) of the channel status word is set.

Module Status LED (Green)

The module status LED is used to indicate module-related diagnostic or operating errors. These *non-recoverable errors* may be detected at power-up or during module operation. Once in a module error state, the 1746-NI8 module no longer communicates with the SLC processor. Channel states are disabled, and data words are cleared.

Failure of any diagnostic test results in a non-recoverable error and requires the assistance of your local distributor or Allen-Bradley.

Troubleshooting Flowchart



Replacement Parts

The 1746-NI8 module has the following replaceable parts:

Part	Part Number
Replacement Terminal Block	1746-RT25G
Replacement Terminal Cover	1746-R13
1746-NI8 User Manual	1746-6.8

Contacting Allen-Bradley

If you need to contact Allen-Bradley for assistance, please have the following information available when you call:

- a clear statement of the problem including a description of what the system is actually doing. Note and record the LED states; also, note input and output image words for the module.
- a list of things you have already tried to remedy the problem
- processor type and firmware (FRN) number. See label on left side of processor.
- hardware types in the system including I/O modules and chassis
- fault code if the SLC processor is faulted

Application Examples

This chapter provides two application examples to help you use the analog input module. They are defined as a:

- basic example
- supplementary example

The **basic example** builds on the configuration word programming provided in chapter 6 to set up one channel for operation. This setup is then used in a typical application to display a current (amperage) value.

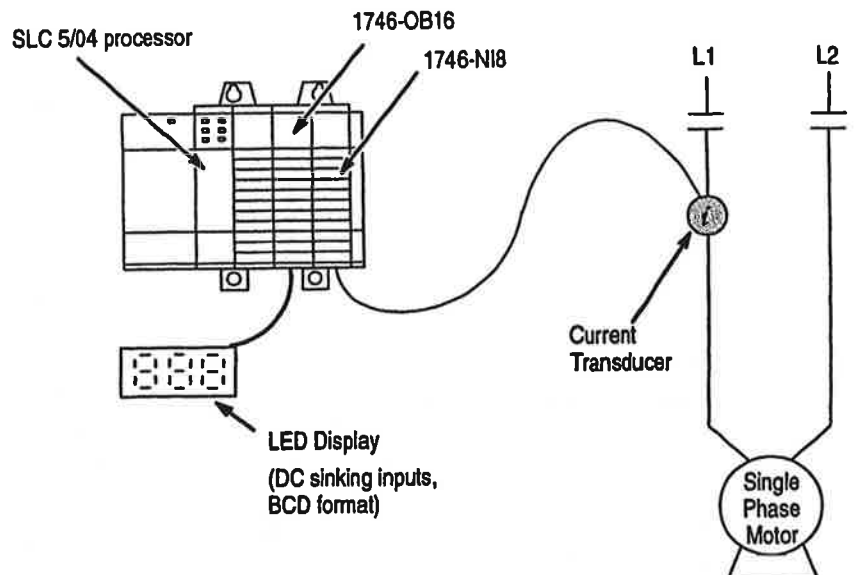
The **supplementary example** demonstrates how to perform a dynamic configuration of five of the eight available channels. The example sets up an application that allows you to manually select whether the current transducer data is displayed for L1, L2, or L3. The example also includes configuration and programming to display pressure and liquid level.

Basic Example

Application Setup – Display a Current (amperage) Value

In this example, the current draw of a single-phase motor is shown on an LED display. The display requires BCD data, so the program must convert the current reading from the analog input module to BCD before sending it to the display.

Device Configuration



Channel Configuration

Configure channel 0 of the 1746-NI8 module with the following setup:

- 4–20 mA input type
- engineering units data format
- zero data word in the event of an open circuit
- 10 Hz input filter to reject high frequency noise and provide rejection of 60 Hz line noise

Channel Configuration Worksheet (With Settings Established for Channel 0)

15	14	13	12	11	10	9	8	7	6	5	4	3	2	1	0	Bit Number
0	0	0	0	1	1	0	0	0	0	0	0	0	1	0	1	Channel 0 – NI0:0
0	0	0	0													Channel 1
0	0	0	0													Channel 2
0	0	0	0													Channel 3
0	0	0	0													Channel 4
0	0	0	0													Channel 5
0	0	0	0													Channel 6
0	0	0	0													Channel 7

• Input Type
 • Data Format
 • Open Circuit
 • Filter Frequency
 • Channel Enable
 • Not Used

Bit Definitions:

Bits	Definition	000	010	100	110
Bits 0–2	Input Type	000 = ±10V dc 001 = 1–5V dc	010 = 0–5V dc 011 = 0–10V dc	100 = 0–20 mA 101 = 4–20 mA	110 = ±20 mA 111 = 0–1 mA
Bits 3–5	Data Format	000 = engineering units 001 = scaled-for-PID	010 = proportional counts 011 = 1746-NI4 data format	100 = user defined scaling 101 = user defined scaling	110 = illegal 111 = illegal
Bits 6 and 7	Open Circuit	00 = zero	01 = upscale	10 = downscale	11 = illegal
Bits 8–10	Filter Frequency	000 = no filter 001 = 75 Hz	010 = 50 Hz 011 = 20 Hz	100 = 10 Hz 101 = 5 Hz	110 = 2 Hz 111 = 1 Hz
Bit 11	Channel Enable	0 = channel disabled 1 = channel enabled			
Bits 12–15	Not Used	0000 = always make this setting			

Program Listing

Rung 2.0

First Pass Bit

S:1

15

Initialize the 1746-N18
Module Channel 0

```
MOV
MOVE
Source      N10:0
Dest        O:3.0
```

Rung 2.1

```
SCP
Scale w/Parameters
Input       I:3.0
           0 <
Input Min.  3500
           3500 <
Input Max.  20500
           20500 <
Scaled Min. 0
           0 <
Scaled Max. 100
           100 <
Output      N7:0
           0 <
```

Rung 2.2

Convert the scaled channel 0 data word
to BCD and write this to the LED display.
If channel 0 is ever disabled, a zero is
written to the display.

```
TOD
TO BCD
Source      N7:0
           0 <
Dest        N7:1
           0000h <
```

```
MVM①
MASKED MOVE
Source      N7:1
           0 <
Mask        0FFFh
           4095 <
Dest        O:2.0
           0 <
```

Rung 2.3

END

① The use of the masked move instruction with the 0FFF mask allows you to use outputs 12, 13, 14, and 15 for other output devices in your system. The 7-segment display uses outputs 0-11.

Data File

DATA FILE N10

Offset	15	14	13	12	11	10	9	8	7	6	5	4	3	2	1	0
N10:0	0	0	0	0	1	1	0	0	0	0	0	0	1	1	0	1

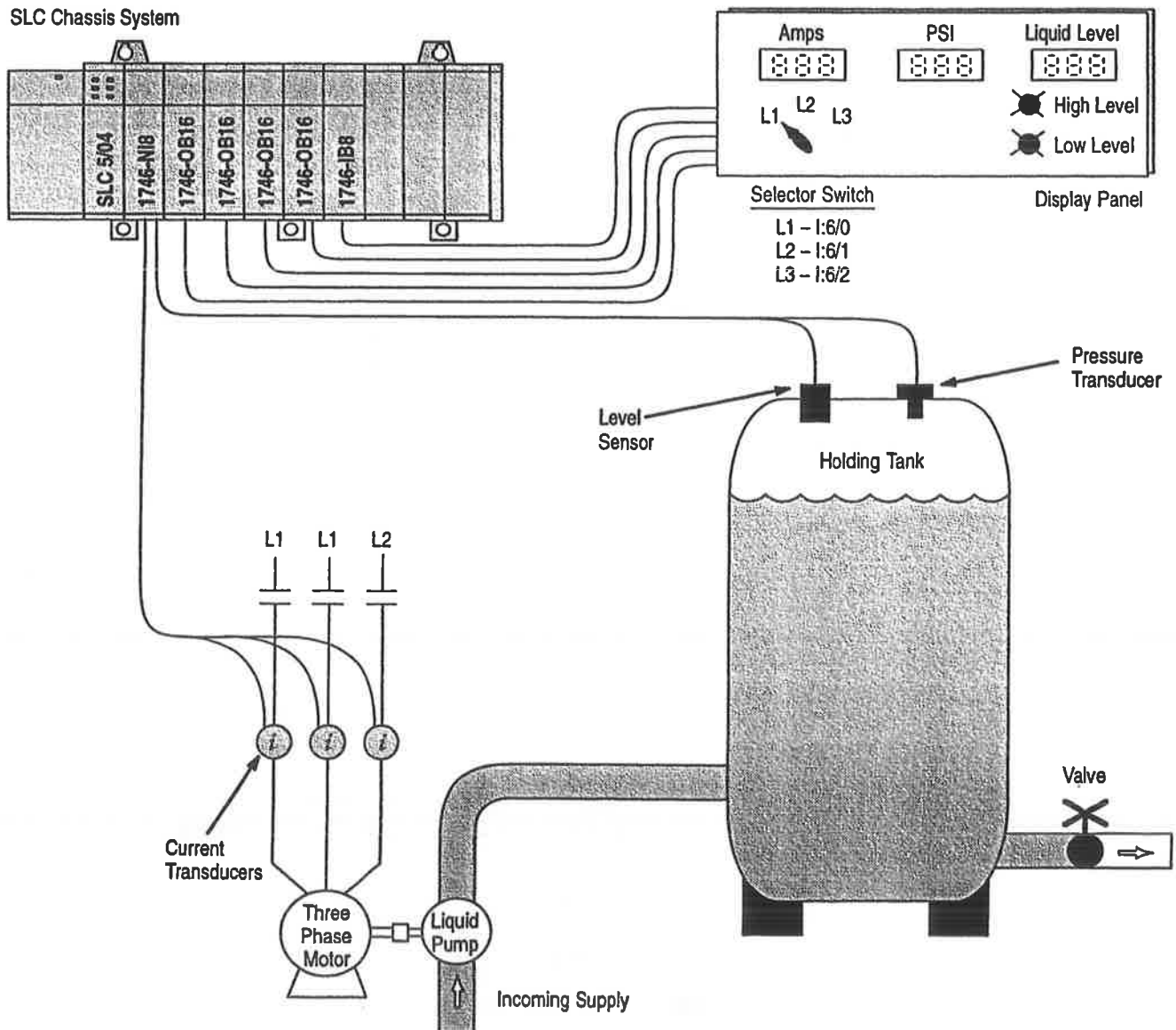
Supplementary Example

Application Setup – Display Amps, PSI, and Liquid Level

This example shows how to display current, pressure, and liquid level at one annunciator panel. The motor current draw is displayed in amps. The tank pressure is displayed in psi. The liquid level in the holding tank is displayed in inches.

A three-position selector switch allows the operator to choose between displaying the current draw for L1, L2, or L3 of the three-phase motor. Two warning pilot lights indicate a low or high liquid level condition in the holding tank. Each display is a 3-digit, 7-segment display. The displays have DC-sinking inputs and use BCD data format.

Device Configuration



Channel Configuration

Configuration setup for current transducers:

- channels 0, 1, and 2
- 4–20 mA input type
- engineering units data format
- zero data word in the event of an open circuit
- 10 Hz input filter to reject high frequency noise and provide 60 Hz line noise rejection

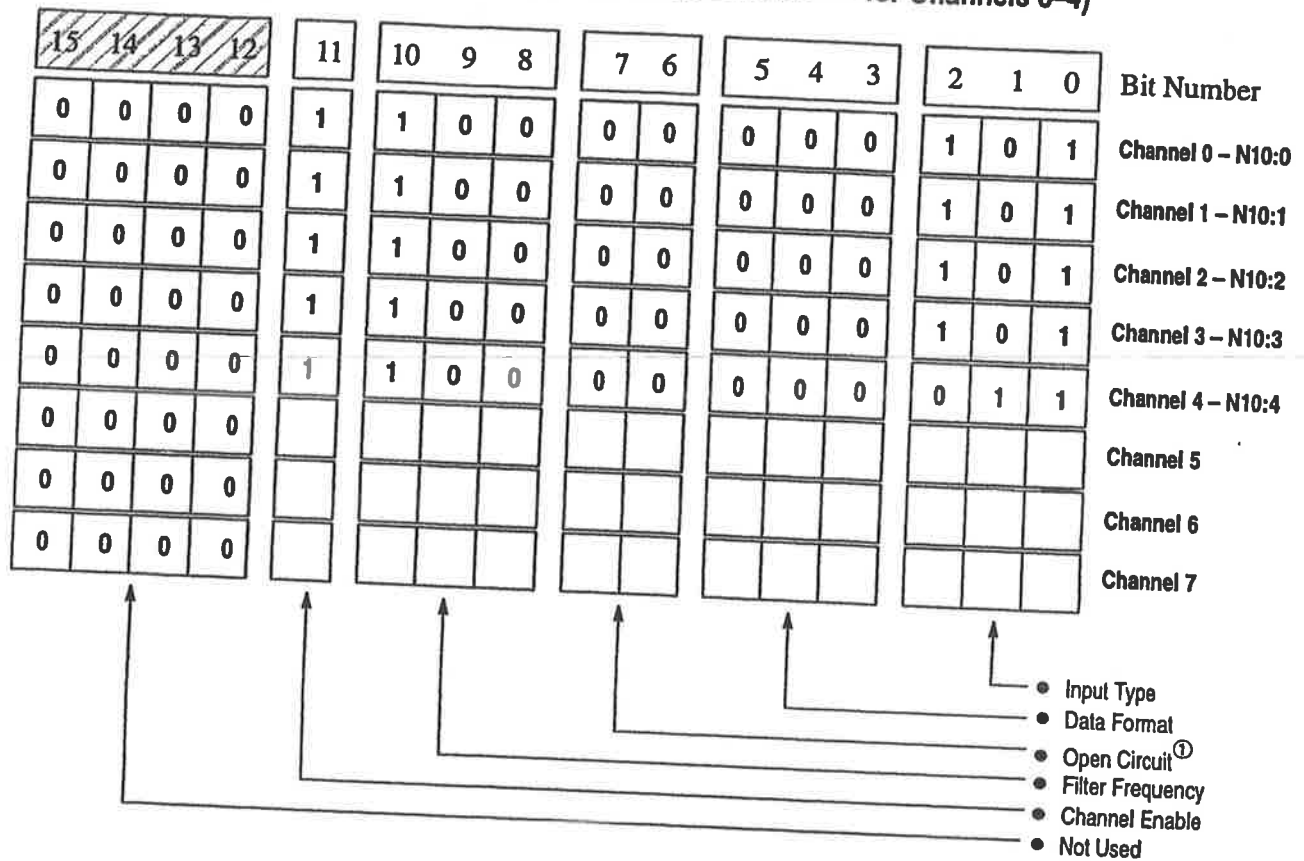
Configuration setup for pressure transducer:

- channel 3
- 4–20 mA input type
- engineering units data format
- zero data word in the event of an open circuit
- 10 Hz input filter to reject high frequency noise and provide 60 Hz line noise rejection

Configuration setup for level sensor:

- channel 4
- 0–10V dc input type
- engineering units data format
- zero data word in the event of an open circuit
- 10 Hz input filter to reject high frequency noise and provide 60 Hz line noise rejection

Channel Configuration Worksheet (With Settings Established for Channels 0-4)



Bit Definitions:

Bits 0-2	Input Type	000 = ±10V dc 001 = 1-5V dc	010 = 0-5V dc 011 = 0-10V dc	100 = 0-20 mA 101 = 4-20 mA	110 = ±20 mA 111 = 0-1 mA
Bits 3-5	Data Format	000 = engineering units 001 = scaled-for-PID	010 = proportional counts 011 = 1746-NI4 data format	100 = user defined scaling 101 = user defined scaling	110 = illegal 111 = illegal
Bits 6 and 7	Open Circuit^①	00 = zero	01 = upscale	10 = downscale	11 = illegal
Bits 8-10	Filter Frequency	000 = no filter 001 = 75 Hz	010 = 50 Hz 011 = 20 Hz	100 = 10 Hz 101 = 5 Hz	110 = 2 Hz 111 = 1 Hz
Bit 11	Channel Enable	0 = channel disabled			
Bits 12-15	Not Used	0000 = always make this setting			
				1 = channel enabled	

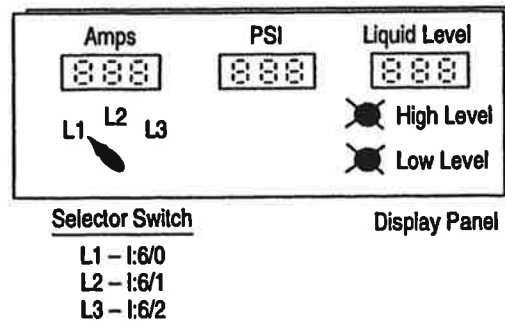
^① The open circuit option is only valid for the 4-20 mA data format.

Program Set Up and Operation Summary

1. Set up one configuration word in memory for each channel. The table below shows the configuration word allocation summary.

Channel	Configuration Word	Value
0	N10:0	L1 (amps)
1	N10:1	L2 (amps)
2	N10:2	L3 (amps)
3	N10:3	pressure (psi)
4	N10:4	liquid level (inches)

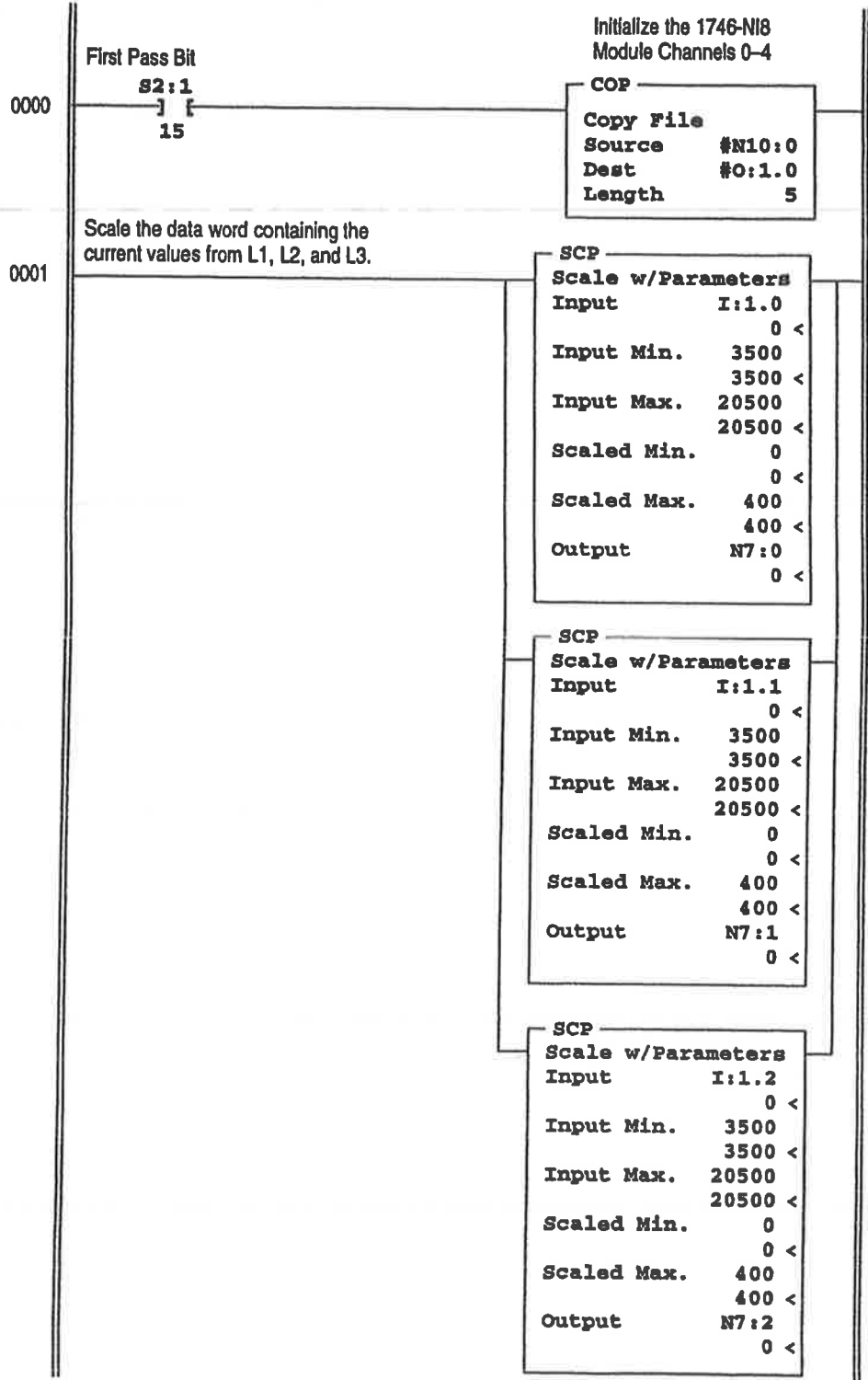
2. When the position of the three-position selector changes, convert the appropriate scaled data word to BCD and send the data to the LED display.

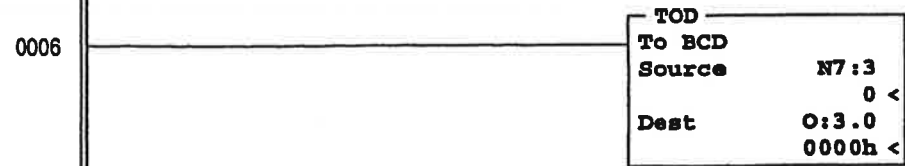
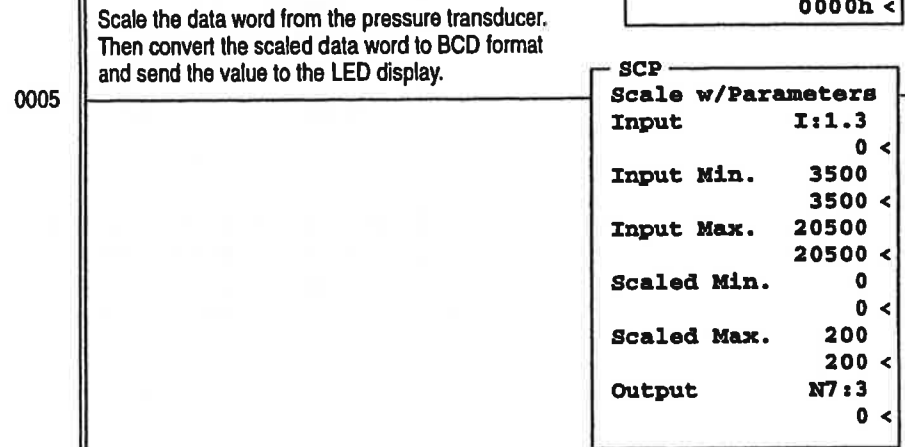
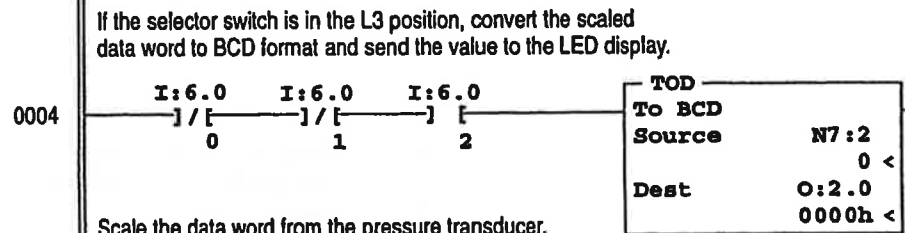
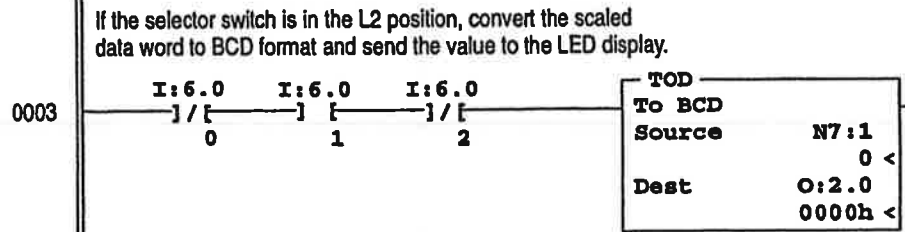
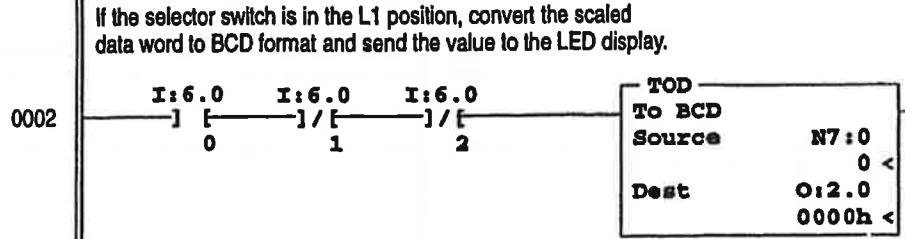


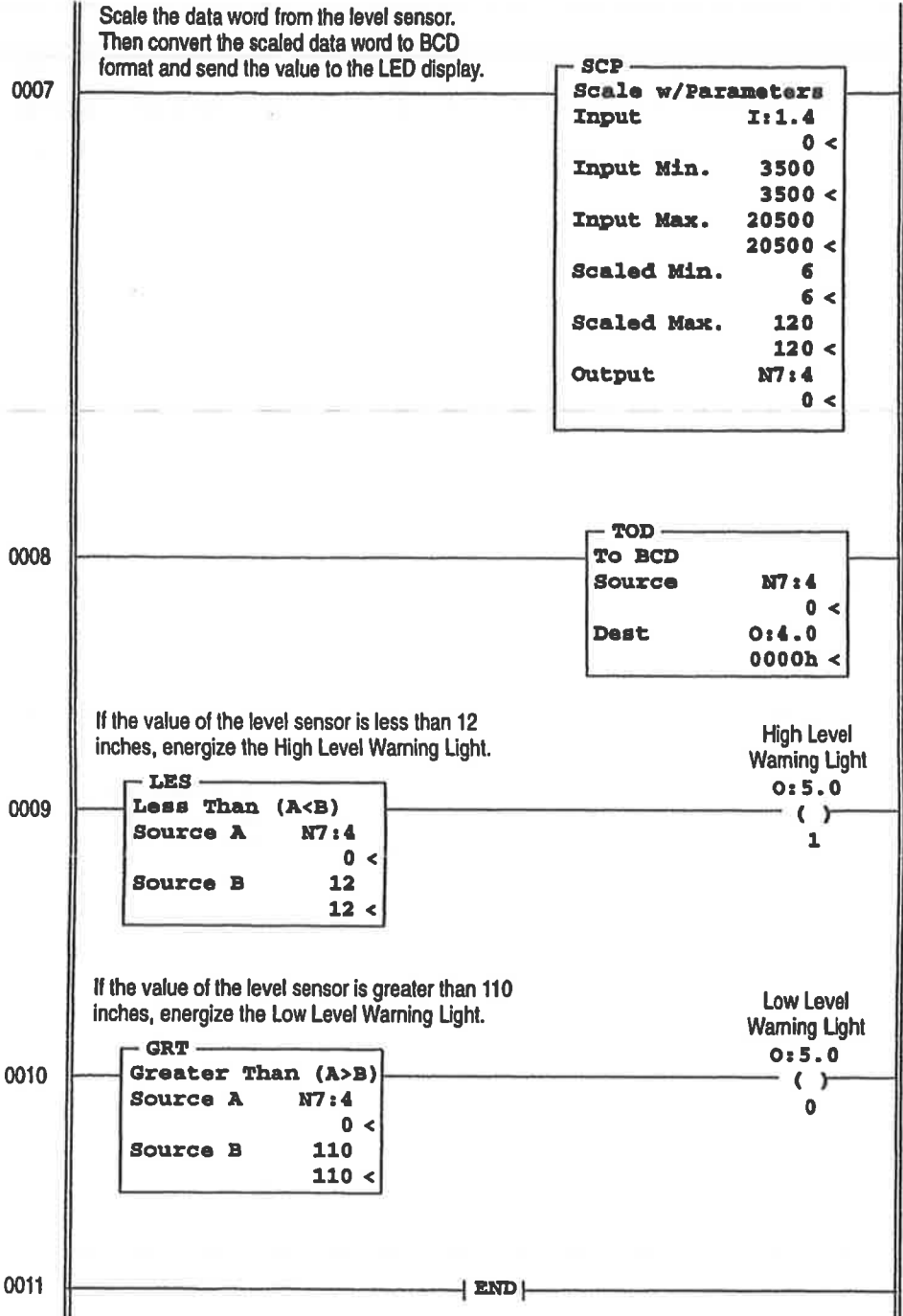
3. If the liquid level goes below the low level set point, turn on the low level warning light, and if the liquid level goes above the high level set point, turn on the high level warning light.
4. Convert the individual analog scaled data words to BCD and send the data to the respective LED displays.

Program Listing

The first rung of this program sends the channel setup information to the 1746-NI8 module. The next four rungs send the scaled data to the LED display based on the position of the selector switch.







Data File

DATA FILE N10

Offset	15	14	13	12	11	10	9	8	7	6	5	4	3	2	1	0
N10:0	0	0	0	0	1	1	0	0	0	0	0	0	0	1	0	1
N10:1	0	0	0	0	1	1	0	0	0	0	0	0	0	1	0	1
N10:2	0	0	0	0	1	1	0	0	0	0	0	0	0	1	0	1
N10:3	0	0	0	0	1	1	0	0	0	0	0	0	0	1	0	1
N10:4	0	0	0	0	1	1	0	0	0	0	0	0	0	0	1	1

Specifications

This appendix lists the specifications for the 1746-NI8 Analog Input Module.

Electrical Specifications

Description	Specification
Backplane Current Consumption	200 mA at 5V dc 100 mA at 24V dc
Backplane Power Consumption	3.4W maximum (1.0W @ 5V dc, 2.4W @ 24V dc)
Number of Channels	8 (backplane isolated)
I/O Chassis Location	Any I/O module slot except slot 0
A/D Conversion Method	Successive approximation, switched capacitor
Input Filtering	Low pass digital filter with programmable filter frequencies
Normal Mode Rejection (between [+] input and [-] input)	Provided by low-pass filter
Common Mode Rejection (between inputs and chassis ground)	Greater than or equal to 75 dB at DC Greater than or equal to 100 dB at 50/60 Hz
Input Filter Frequencies	1 Hz 2 Hz 5 Hz 10 Hz 20 Hz 50 Hz 75 Hz
Calibration	The module performs continuous autocalibration.
Isolation	50V dc continuous between the analog inputs and the backplane 530V ac and 750V dc pulse withstand for 1 second
Common-Mode Voltage Range	±10.5V (21V maximum between any two terminals)

Physical Specifications

Description	Specification
LED Indicators	9 green status indicators one for each of 8 channels and one for module status
Module ID Code	Class 1 Interface: 3526 Class 3 Interface: 12726
Recommended Cable	Belden #8761 or equivalent
Maximum Wire Size	Two 14 AWG wires per terminal
Maximum Cable Impedance	Voltage Source (with less than 10Ω impedance): 40Ω maximum loop impedance, for <1LSB error Current Source (transmitter properly wired to its power supply): 250Ω maximum loop impedance, to meet common-mode voltage requirements
Terminal Block	Removable, Allen-Bradley spare part Catalog Number 1746-RT25G

Environmental Specifications

Description	Specification
Operating Temperature	0°C to 55°C (32°F to 131°F) in any slot except slot 0 0°C to 60°C (32°F to 140°F) in right most slot of chassis
Storage Temperature	-40°C to +85°C (-40°F to +185°F)
Relative Humidity	5% to 95% (without condensation)
Certification	UL listed CSA approved CE compliant for all applicable directives
Hazardous Environment Classification	Class I Division 2 Hazardous Environment

Input Specifications

Description	Specification
Type of Input (Selectable)	±10V dc 1-5V dc 0-5V dc 0-10V dc 0-20 mA 4-20 mA ±20 mA 0-1 mA
Type of Data (Selectable)	Engineering Units Scaled-for-PID Proportional Counts (-32,768 to +32,767 range) Proportional Counts (User Defined Range, Class 3 only) 1746-NI4 Data Format
Input Impedance	1 MΩ
Voltage Input (maximum)	±30V between any two signal terminals
Current Input (maximum)	±30 mA
Time to Detect Open Circuit	1 module scan
Input Step Response	See Chapter 4, Channel Filter Frequency Selection, page 4-7
Input Resolution	1 mV or 1 μA
Display Resolution	1 mV or 1 μA
Overall Module Accuracy (0°C to 60°C, 32°F to 140°F)	Voltage input types (±10V dc, 1-5V dc, 0-5V dc, 0-10V dc): ±0.1% Current input types (0-20 mA, 4-20 mA, ±20 mA): ±0.05% Current input type (0-1 mA): ±0.5%
Overall Module Drift	Voltage input type: ±6 ppm/°C Current input type: ±12 ppm/°C
Module Update Time	See Chapter 4, Update Time, page 4-5
Channel Turn-On Time	See Chapter 4, Turn-On Time, page 4-6
Channel Turn-Off Time	See Chapter 4, Turn-Off Time, page 4-6
Channel Reconfiguration Time	See Chapter 4, Reconfiguration Time, page 4-6

Configuration Worksheet

The following worksheet is provided to help you configure each of the channels on your module. See Chapter 5 for detailed configuration information.

15 14 13 12				11	10 9 8	7 6	5 4 3	2 1 0	Bit Number
0	0	0	0						Channel 0
0	0	0	0						Channel 1
0	0	0	0						Channel 2
0	0	0	0						Channel 3
0	0	0	0						Channel 4
0	0	0	0						Channel 5
0	0	0	0						Channel 6
0	0	0	0						Channel 7

- Input Type
- Data Format
- Open Circuit
- Filter Frequency
- Channel Enable
- Not Used

Bit Definitions:

Bits	Function	000	010	100	110
Bits 0-2	Input Type	000 = ±10V dc	010 = 0-5V dc	100 = 0-20 mA	110 = ±20 mA
		001 = 1-5V dc	011 = 0-10V dc	101 = 4-20 mA	111 = 0-1 mA
Bits 3-5	Data Format	000 = engineering units	010 = proportional counts	100 = user defined scaling	110 = illegal
		001 = scaled-for-PID	011 = 1746-NI4 data format	101 = user defined scaling	111 = illegal
Bits 6 and 7	Open Circuit	00 = zero	01 = upscale	10 = downscale	11 = illegal
Bits 8-10	Filter Frequency	000 = no filter	010 = 50 Hz	100 = 10 Hz	110 = 2 Hz
		001 = 75 Hz	011 = 20 Hz	101 = 5 Hz	111 = 1 Hz
Bit 11	Channel Enable	0 = channel disabled			1 = channel enabled
Bits 12-15	Not Used	0000 = always make this setting			

Converting from 1746-NI4 to 1746-NI8

This information is provided for those who are replacing two 1746-NI4 modules with one 1746-NI8 module.

Module ID Code

The module identification code is a unique number encoded for each 1746 I/O module. The code defines for the processor the type of I/O or specialty module residing in a specific slot in the 1746 chassis.

Using your programming device, configure the slot with the appropriate ID code. In this example, the 1746-NI8 is in slot 3.

Catalog Number	ID Code
1746-NI8	3526 – Class 1 interface 12726 – Class 3 interface

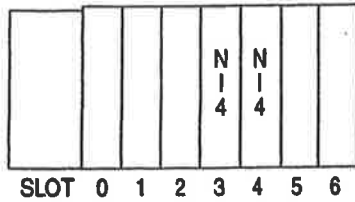
Important: All programming software does not support configuration for Class 3 operation.

- Advanced Programming Software (APS) supports Class 3 configuration. After entering the ID code (12726), enter 16 input words and 12 output words.
- SLC 500 A.I. Series™ Programming Software supports Class 3 configuration. After entering the ID code (12726), enter 16 input words and 12 output words.
- RSLogix 500™, version 1.30 or later, supports Class 3 configuration. After entering the ID code (12726), select Class 3 operation.
- Earlier versions of RSLogix 500 will only support configuration for Class 1 operation. Contact Rockwell Software for information on upgrading your software.

See chapter 4 for more information on Class 1 and Class 3 interfaces.

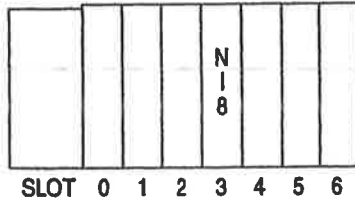
Addressing

Addressing is changed from two modules with 4 channels to one module with 8 channels. The input addressing is shown below.



1746-NI4 Input Addressing

- I:3.0 – Slot 3, Channel 0 Data Word
- I:3.1 – Slot 3, Channel 1 Data Word
- I:3.2 – Slot 3, Channel 2 Data Word
- I:3.3 – Slot 3, Channel 3 Data Word
- I:4.0 – Slot 4, Channel 0 Data Word
- I:4.1 – Slot 4, Channel 1 Data Word
- I:4.2 – Slot 4, Channel 2 Data Word
- I:4.3 – Slot 4, Channel 3 Data Word



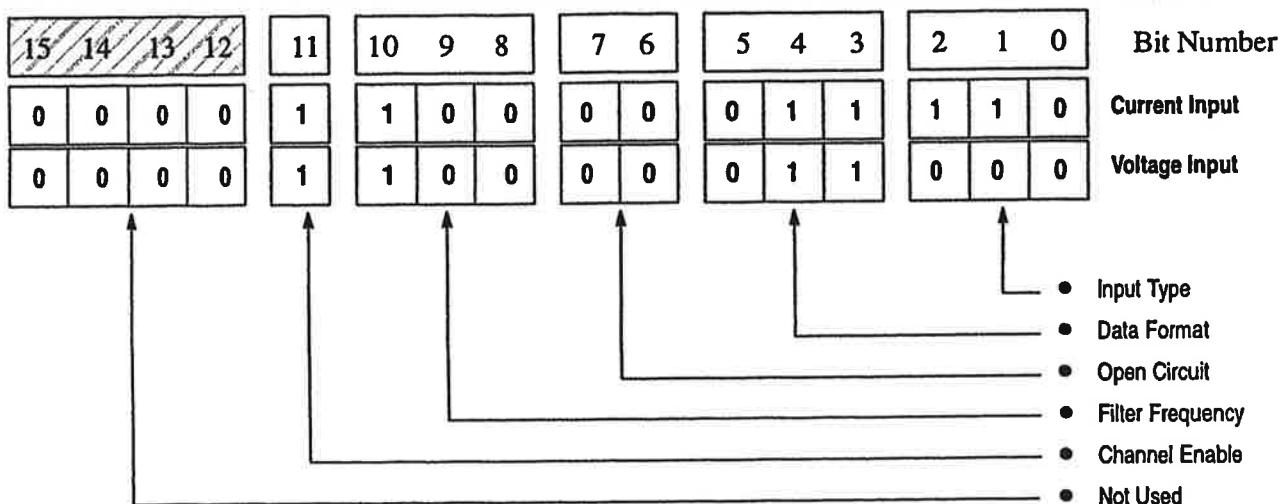
1746-NI8 Input Addressing

- I:3.0 – Slot 3, Channel 0 Data Word
- I:3.1 – Slot 3, Channel 1 Data Word
- I:3.2 – Slot 3, Channel 2 Data Word
- I:3.3 – Slot 3, Channel 3 Data Word
- I:3.4 – Slot 3, Channel 4 Data Word
- I:3.5 – Slot 3, Channel 5 Data Word
- I:3.6 – Slot 3, Channel 6 Data Word
- I:3.7 – Slot 3, Channel 7 Data Word

Channel Configuration

For the 1746-NI4, input selection (voltage or current) is made via a switch. For the 1746-NI8, input selection (voltage or current) is made via a switch and a configuration word is used to define the other operating parameters for the module. The 1746-NI4 does not employ a configuration word.

To configure the 1746-NI8 for the same input type as the 1746-NI4, use the following configuration word. For voltage input you must select $\pm 10V$ dc, and for current input you must select ± 20 mA. Define a configuration word for channels 0-7 on the 1746-NI8 module.



Bit Definitions for Converting from 1746-NI4 to 1746-NI8:

Bits 0-2	Input Type	000 = $\pm 10V$ dc 110 = ± 20 mA
Bits 3-5	Data Format	011 = 1746-NI4 data format
Bits 6 and 7	Open Circuit	00 = zero (the open circuit option is not available for the ± 20 mA data type)
Bits 8-10	Filter Frequency	100 = 10 Hz
Bit 11	Channel Enable	0 = channel disabled 1 = channel enabled
Bits 12-15	Not Used	0000 = always make this setting

See chapter 5 for more detailed information on channel configuration.

Ladder Program

To convert your ladder program from the 1746-NI4s to a 1746-NI8, you only need to change the module addressing. Change the addresses in the program (slot and word sub element number) to reflect the location of the new module.

See chapter 6 for more information on ladder programming.

Two's Complement Binary Numbers

The SLC 500 processor memory stores 16-bit binary numbers. Two's complement binary is used when performing mathematical calculations internal to the processor. Analog input values from the analog modules are returned to the processor in 16-bit two's complement binary format. For positive numbers, the binary notation and two's complement binary notation are identical.

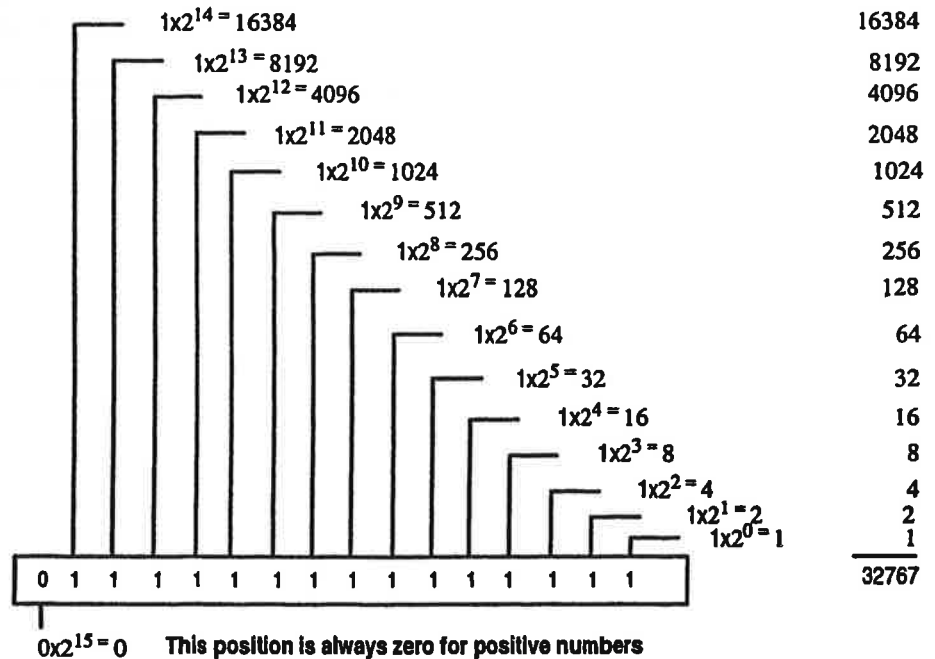
As indicated in the figure on the next page, each position in the number has a decimal value, beginning at the right with 2^0 and ending at the left with 2^{15} . Each position can be 0 or 1 in the processor memory. A 0 indicates a value of 0; a 1 indicates the decimal value of the position. The equivalent decimal value of the binary number is the sum of the position values.

Positive Decimal Values

The far left position is always 0 for positive values. As indicated in the figure below, this limits the maximum positive decimal value to 32767 (all positions are 1 except the far left position). For example:

$$0000\ 1001\ 0000\ 1110 = 2^{11} + 2^8 + 2^3 + 2^2 + 2^1 = 2048 + 256 + 8 + 4 + 2 = 2318$$

$$0010\ 0011\ 0010\ 1000 = 2^{13} + 2^9 + 2^8 + 2^5 + 2^3 = 8192 + 512 + 256 + 32 + 8 = 9000$$



Negative Decimal Values

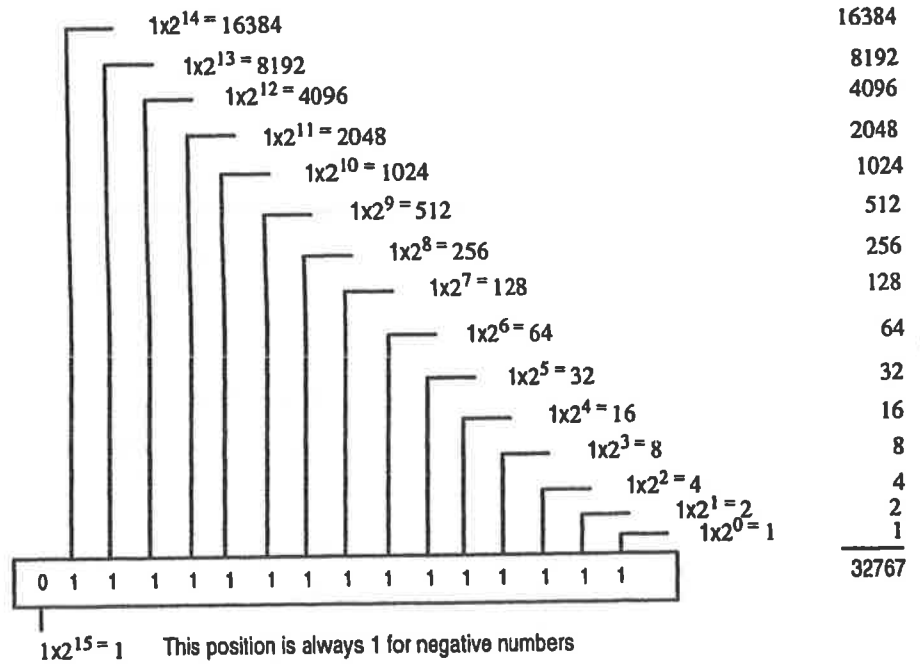
In two's complement notation, the far left position is always 1 for negative values. The equivalent decimal value of the binary number is obtained by subtracting the value of the far left position, 32768, from the sum of the values of the other positions. In the figure below (all positions are 1), the value is $32767 - 32768 = -1$. For example:

$$1111\ 1000\ 0010\ 0011 =$$

$$(2^{14} + 2^{13} + 2^{12} + 2^{11} + 2^5 + 2^1 + 2^0) - 2^{15} =$$

$$(16384 + 8192 + 4096 + 2048 + 32 + 2 + 1) - 32768 =$$

$$30755 - 32768 = -2013.$$



Glossary

The following terms and abbreviations are used throughout this manual. For definitions of terms not listed here refer to *Allen-Bradley's Industrial Automation Glossary, Publication AG-7.1.*

A/D - Refers to the analog to digital converter inherent to the module. The converter produces a digital value whose magnitude is proportional to the instantaneous magnitude of an analog input signal.

analog input module - An I/O module that contains circuits that convert analog dc input signals to digital values that can be manipulated by the processor.

attenuation - The reduction in the magnitude of a signal as it passes through a system.

backplane - A printed circuit board, at the back of the chassis, that provides electrical interconnection between the modules inserted into the chassis.

channel - Refers to one of eight, small-signal analog input interfaces available on the module's terminal block. Each channel is configured for connection to a voltage or current source input device, and has its own data and diagnostic status words.

channel update time - The time required for the module to sample and convert the input signals of one enabled input channel and update the channel data word.

chassis - A hardware assembly that houses devices such as I/O modules, adapter modules, processor modules, and power supplies.

common mode rejection ratio - The ratio of a device's differential voltage gain to common mode voltage gain. Expressed in dB, CMRR is a comparative measure of a device's ability to reject interference caused by a voltage common to its input terminals relative to ground. $CMRR = 20 \text{ Log}_{10} (V1/V2)$

common mode voltage - A voltage that appears in common at both input terminals of a differential analog input with respect to ground.

configuration word - Contains the channel configuration information needed by the module to configure and operate each channel. Information is written to the configuration word through the logic supplied in your ladder program.

dB - (decibel) A logarithmic measure of the ratio of two signal levels.

data word - A 16-bit integer that represents the value of the analog input channel. The channel data word is valid only when the channel is enabled and there are no channel errors. When the channel is disabled the channel data word is cleared (0).

digital filter - A filter implemented in firmware, using discrete, sampled data of the input signal.

filter - A device that passes a signal or range of signals and eliminates all others.

filter frequency - (-3 dB frequency) The user-selectable frequency.

full scale error - (gain error) The difference in slope between the actual and ideal analog transfer functions.

full scale range - (FSR) The difference between the maximum and minimum specified analog input values.

gain drift - The change in full scale transition voltage measured over the operating temperature range of the module.

input data scaling - The data formats that you select to define the logical increments of the channel data word. These may be scaled-for-PID, or Engineering Units, which are automatically scaled. They may also be proportional counts, which you must calculate to fit the resolution of the quantity being measured in your application.

input image - The input from the 1746-NI8 module to the SLC processor. The input image contains the module data words and status words.

local configuration - A control system where all the chassis are located within several feet of the processor, and chassis-to-chassis communication is via a 1746-C7 or 1746-C9 ribbon cable.

LSB - (Least Significant Bit) The bit that represents the smallest value within a string of bits.

module scan time - same as *module update time*

module update time - The time required for the module to sample and convert the input signals of all enabled input channels and make the resulting data values available to the SLC™ processor.

multiplexer - An switching system that allows several input signals to share a common A/D converter.

normal mode rejection - (differential mode rejection) A logarithmic measure, in dB, of a device's ability to reject noise signals between or among circuit signal conductors.

output image - The output from the SLC processor to the 1746-NI8 module. The output image contains the module configuration information. Each output word configures a single channel.

remote configuration - A control system where the chassis can be located several thousand feet from the processor chassis. Chassis communication is via the 1747-SN Scanner and 1747-ASB Remote I/O Adapter.

resolution - The smallest detectable change in a measurement, typically expressed in engineering units (e.g. 1 mV) or as a number of bits. For example a 12-bit system has 4,096 possible output states. It can therefore measure 1 part in 4096.

scaling - The process of changing a quantity from one notation to another.

status word - Contains status information about the channel's current configuration and operational state. You can use this information in your ladder program to determine whether the channel data word is valid.

step response time - This is the time required for the channel data word signal to reach a specified percentage of its expected final value, given a large step change in the input signal.

transducer - A device that converts one energy form to another (e.g., mechanical to electrical). When a transducer is actuated by signals from one system or medium, it can supply a related signal to the other system or medium.

Symbols

-3 dB frequency. *See* filter frequency

A

A/D

converter, 1-4
definition, G-1
value in data word, 5-3

abbreviations, G-1

addressing, 4-2
1746-NI4 to 1746-NI8, C-2
configuration word, 4-3
addressing example, 4-4
data word, 4-4
addressing example, 4-4
status word, 4-4
addressing example, 4-4

alarms, 6-4

aliasing frequency, 4-8

Allen-Bradley, P-4
contacting for assistance, P-4

analog input module
definition, G-1
overview, 1-1

attenuation
-3 dB frequency, 4-7
definition, G-1

B

backplane
connector, 3-5
data transfer, 1-4
definition, G-1
electrostatic damage, 3-1
ground connection, 2-3, 3-7
interface, 1-3
power supply, 3-1

bit allocation, 5-1
in status word, 5-12

bit definition
channel enable, 5-4
channel status, 5-13
configuration error, 5-14
data format, 5-3, 5-13
filter frequency, 5-4, 5-13
in configuration word, 5-2

in status word, 5-12
input type, 5-3, 5-13
open circuit error, 5-14
open circuit state, 5-3, 5-13
over-range error, 5-14
under-range error, 5-14

C

cable tie slots, 1-2

calibration, 1-4

channel, definition, G-1

channel configuration error, 7-3
fault detection bit, 5-14

channel filter frequency, 4-7
effects on noise filtering, 4-7
effects on update time, 4-7

channel status bit, 5-13

channel status LED, 1-3, 2-6

channel status word, example, 2-7

channel step response, 4-7

channel update time, definition, G-1

chassis
definition, G-1
installing module in, 3-5
installing module in, 2-3

CMRR. *See* common mode rejection ratio

common mode rejection ratio, definition, G-1

common mode voltage, definition, G-1

configuration word, 4-3
bit definition chart, 5-2
definition, G-1
factory default setting, 5-1
worksheet, B-1

configuring a channel, 5-1
worksheet, B-1

connection diagram, 2-3, 3-6

contacting Allen-Bradley for assistance, P-4

contents of manual, P-2

converting from 1746-NI4 to 1746-NI8, C-1

current draw, 3-1

cut-off frequency, 4-7

D

- data type descriptions, 5-6
- data word, 4-4
 - addressing, 4-4
 - converting to other units, 5-6
 - definition, G-2
 - module input image, 2-6, 5-5
 - scaling examples, 5-8
 - values for engineering units, 5-5
 - values for scaled data, 5-6
- data word format, 5-3
 - examining in status word, 5-13
 - setting in configuration word, 5-3
- dB, definition, G-2
- decibel. *See* dB
- default setting of configuration word, 5-1
- definition of terms, G-1
- diagnostics
 - at power-up, 7-1
 - channel diagnostics, 7-1
- differential mode rejection. *See* normal mode rejection
- digital filter, definition, G-2
- DIP switches, 1-2, 2-2
- disabling a channel, 5-4
- door label, 1-2

E

- electrical noise, 3-3, 3-9
- electrical specifications, A-1
- electrostatic damage, 3-1
- EMC Directive, 3-3
- enabling a channel, 5-4
- engineering units input, 5-6
- environmental specifications, A-2
- equipment required for installation, 2-1
- errors, 7-3
 - channel-related errors, configuration error, 7-3
 - detecting channel-related errors, 7-3
 - open circuit, 7-3
 - over-range error, 7-3
 - under-range error, 7-3
 - module-related errors, 7-4
 - conditions at power-up, 7-4
 - over-range error, 7-3
- European Union Directives, 3-3
- configuration word, 2-4

examples

- basic application example, 8-1
- how to address configuration word,
- how to address data word, 4-4
- how to address status word, 4-4
- how to use PID instruction, 6-3
- scaling the data word, 5-8
- supplementary application example, 8-4
- using alarms to indicate status, 6-4

F

- fault condition
 - at power-up, 1-3
 - during operation, 1-3
- filter, definition, G-2
- filter frequency, 4-7
 - definition, G-2
 - examining in status word, 5-13
 - setting in configuration word, 5-4
- FSR. *See* full scale range
- full scale error, definition, G-2
- full scale range, definition, G-2

G

- gain drift, definition, G-2
- gain error. *See* full scale error
- getting started, 2-1
 - procedure, 2-2
 - tools required, 2-1

H

- hazardous environment classification, A-2
- heat considerations, 3-3

I

- ID code, 4-1, C-1
- input channel multiplexing, 1-4
- input data scaling, definition, G-2
- input device type, 5-3
 - examining in status word, 5-13
 - setting in configuration word, 5-3
- input devices
 - source impedance, 3-9
 - wiring, 3-9
- input filter. *See* filter frequency
- input image, 2-6

See also status word and data word
definition, G-2

input response to slot disabling, 4-6

input specifications, A-2

input types, A-2

installation, 3-1, 3-5

equipment required, 2-1

getting started, 2-1

heat and noise considerations, 3-3

location in chassis, 2-3, 3-2

L

LEDs, 1-2

channel status indicators, 1-2

module status indicator, 1-2

state tables, 7-2

local configuration, definition, G-2

LSB, 5-6

definition, G-2

M

memory map, 4-2, 4-3

module ID code, 2-4, 4-1, C-1

how to enter, 2-4, 4-1, C-1

module operation, 1-4

module scan time

definition, G-2

minimizing, 5-4

response to open circuit, 5-4

module status LED, 2-6

module update time

calculating, 4-5

definition, G-2

for number of channels enabled, 4-5

increased by reconfiguration, 5-4

multiplexer, definition, G-2

multiplexing, 1-4

N

negative decimal values, D-2

noise filtering, 4-7

normal mode rejection, definition, G-3

O

open-circuit, 7-3

defining conditional state of channel data,
5-3

downscale enable, 5-3

upscale enable, 5-3

zero, 5-3

error condition, 7-3

fault detection bit, 5-14

module response to, 5-4, 5-13

operation

module, 1-4

system, 1-3

out-of-range error, 7-3

over-range error, 5-14

under-range error, 5-14

output image, 2-5, 4-3

definition, G-3

output response to slot disabling, 4-6

over-range error, 5-14

fault indicator bit, 5-14

P

physical specifications, A-1

PID input type, 5-6

PID instruction, 6-3

pinout diagram, 3-6

Positive Decimal Values, D-1

power requirements, 3-1

power-up sequence, 1-3

programming

alarms, 6-4

configuration settings, 2-5, 6-1

initial setting, 6-1

PID instruction, 6-3

proportional counts input, 5-6

R

reconfiguration time, 4-6

remote configuration, definition, G-3

removable terminal block, 1-2

removing the module, 3-4

resolution, definition, G-3

S

scaled-for-PID, 5-6

scaling, definition, G-3

scaling input data. *See* input data scaling

scan time, G-2

self-locking tabs, 1-2

shield connections, 3-6, 3-9
 slot disabling, 4-6
 software, 2-4, 4-1, C-1
 specifications, A-1
 electrical, A-1
 environmental, A-2
 input, A-2
 physical, A-1
 start-up instructions, 2-1
 status bit
 channel enable, 1-3
 fault condition, 1-3
 time to reset, 4-6
 time to set, 4-6

status LED. *See* channel status LED or
 module status LED

status word
See also input image
 addressing, 4-4
 bit definition chart, 5-12
 definition, G-3
 module input image, 5-11

step response time
 at filter frequency, 4-7
 definition, G-3
 in choosing filter frequency, 5-4

system operation, 1-3

T

terminal pinout diagram, 3-6
 terminal wiring, 3-6

wiring inputs, 3-10
 tools required for installation, 2-1
 transducer
 definition, G-3
 source impedance, 3-9
 wiring, 3-10
 troubleshooting
 contacting Allen-Bradley, P-4
 flowchart, 7-5
 LED examination, 7-2
 turn-off time, 4-6
 turn-on time, 4-6
 two's complement binary numbers, D-1

U

under-range error, 5-14
 fault bit, 5-14
 update time, 4-5
 See also channel update time; module
 update time
 effects of filter time setting, 4-7
 related to cut-off frequency, 4-8

W

wiring, 3-1
 routing considerations, 3-3
 terminal wiring, 3-6
 shield connections, 3-9
 worksheet, B-1

25
624





Allen-Bradley

Allen-Bradley, a Rockwell automation business, has been helping its customers improve productivity and quality for more than 90 years. We design, manufacture and support a broad range of automation products worldwide. They include logic processors, power and motion control devices, operator interfaces, sensors and a variety of software. Rockwell is one of the world's leading technology companies.

Worldwide representation.



Argentina • Australia • Austria • Bahrain • Belgium • Brazil • Bulgaria • Canada • Chile • China, PRC • Colombia • Costa Rica • Croatia • Cyprus • Czech Republic • Denmark • Ecuador • Egypt • El Salvador • Finland • France • Germany • Greece • Guatemala • Honduras • Hong Kong • Hungary • Iceland • India • Indonesia • Ireland • Israel • Italy • Jamaica • Japan • Jordan • Korea • Kuwait • Lebanon • Malaysia • Mexico • Netherlands • New Zealand • Norway • Pakistan • Peru • Philippines • Poland • Portugal • Puerto Rico • Qatar • Romania • Russia-CIS • Saudi Arabia • Singapore • Slovakia • Slovenia • South Africa, Republic • Spain • Sweden • Switzerland • Taiwan • Thailand • Turkey • United Arab Emirates • United Kingdom • United States • Uruguay • Venezuela • Yugoslavia

Allen-Bradley Headquarters, 1201 South Second Street, Milwaukee, WI 53204 USA, Tel: (1) 414 382-2000 Fax: (1) 414 382-4444



Allen-Bradley

**SLC 500™ Analog
I/O Modules**

**(Cat. Nos. 1746-NI4, -NI04I,
-NI04V, -NO4I, and -NO4V)**

User Manual

Important User Information

Because of the variety of uses for the products described in this publication, those responsible for the application and use of this control equipment must satisfy themselves that all necessary steps have been taken to assure that each application and use meets all performance and safety requirements, including any applicable laws, regulations, codes and standards.

The illustrations, charts, sample programs and layout examples shown in this guide are intended solely for purposes of example. Since there are many variables and requirements associated with any particular installation, Allen-Bradley does not assume responsibility or liability (to include intellectual property liability) for actual use based upon the examples shown in this publication.

Allen-Bradley publication SGI-1.1, *Safety Guidelines for the Application, Installation, and Maintenance of Solid-State Control* (available from your local Allen-Bradley office), describes some important differences between solid-state equipment and electromechanical devices that should be taken into consideration when applying products such as those described in this publication.

Reproduction of the contents of this copyrighted publication, in whole or in part, without written permission of Allen-Bradley Company, Inc., is prohibited.

Throughout this manual we use notes to make you aware of safety considerations:



ATTENTION: Identifies information about practices or circumstances that can lead to personal injury or death, property damage or economic loss.

Attention statements help you to:

- identify a hazard
- avoid the hazard
- recognize the consequences

Important: Identifies information that is critical for successful application and understanding of the product.



Publication Problem Report

If you find a problem with our documentation, please let us know by completing and returning this form.

Publication Title _____ Publication Date _____

Publication/Catalog No. _____ Part No. _____

Check Problem Type(s):	Describe Problem(s): (Please reference page numbers)
<input type="checkbox"/> Technical Accuracy What is inaccurate? <input type="checkbox"/> Text <input type="checkbox"/> Illustration/Photo	
<input type="checkbox"/> Completeness What information is missing? <input type="checkbox"/> Procedure/Step <input type="checkbox"/> Example <input type="checkbox"/> Explanation <input type="checkbox"/> Illustration/Photo <input type="checkbox"/> Guideline <input type="checkbox"/> Definition <input type="checkbox"/> Feature <input type="checkbox"/> Other	
<input type="checkbox"/> Clarity What is unclear?	
<input type="checkbox"/> Sequence What is not in the right order?	
<input type="checkbox"/> Other Comments Continue comments on back.	

Name _____ Title _____

Company _____ Department _____

Address _____ City _____ State _____ Zip _____

Telephone No. _____ Date _____

Other Comments

Lined area for writing comments.

PLEASE FOLD HERE



NO POSTAGE
NECESSARY
IF MAILED
IN THE
UNITED STATES



BUSINESS REPLY MAIL
FIRST CLASS MAIL PERMIT NO. 1594 MILWAUKEE, WI

POSTAGE WILL BE PAID BY ADDRESSEE

Allen-Bradley Company
Automation Group
SLC Marketing, Dept. 602G
P.O. Box 2086
Milwaukee, WI 53201-2086



Summary of Changes

The information below summarizes the changes to this manual since the last printing as 1746-NM003, Series B in February 1994. This manual incorporates the Document Update from October 1995.

To help you find new information and updated information in this release of the manual, we have included change bars as shown to the right of this paragraph.

New Information

The table below lists sections that document new features and additional information about existing features, and shows where to find this new information.

For This New Information	See
Quick Start for Experienced Users	Chapter 2
Wiring Schematic for Single-ended Analog Input Connections	Chapter 3
CE Certification	Chapter 3, Appendix A
Module Input and Output Circuits	Appendix D

Updated Information

Changes from the previous release that require you to perform a procedure differently or that require different equipment are listed below:

- Determining Your Power Requirements table – added specialty and discrete I/O modules (see chapter 3, Installing Your Analog Module).
- Additional information added to Grounding Your Cable section (see chapter 3, Installing Your Analog Module).
- Foil Shield and Drain Wire diagram, Figure 3.11, has been modified (see chapter 3, Installing Your Analog Module).

Table of Contents

	Preface	
	Who Should Use this Manual	P-1
	Purpose of this Manual	P-1
	Terms and Abbreviations	P-2
	Contents of this Manual	P-6
	Related Documentation	P-6
	Common Techniques Used in this Manual	P-7
	Allen-Bradley Support	P-8
	Local Product Support	P-8
	Technical Product Assistance	P-8
	Your Questions or Comments on this Manual	P-8
Overview	Chapter 1	
	How to Use Analog	1-1
	Types of Analog Modules	1-2
	1746-NIO4I and NIO4V Analog Combination Modules	1-2
	1746-NO4I and NO4V Analog Output Modules	1-2
Quick Start for Experienced Users	Chapter 2	
	Required Tools and Equipment	2-1
	Procedures	2-2
Installing Your Analog Module	Chapter 3	
	European Union Directive Compliance	3-1
	EMC Directives	3-1
	Determining Your Power Requirements for a Modular Controller ...	3-2
	Determining Your Power Requirements for a Fixed Controller	3-3
	Configuring Your Module	3-4
	Switch Settings for the 1746-NI4	3-4
	Switch Settings for the 1746-NIO4I and NIO4V	3-5
	External Power Switch for the 1746-NO4I and NO4V	3-5
	Choosing a Slot in the Chassis	3-6
	Installing your Module	3-6
	Removing the Analog Module Terminal Block	3-7
	Wiring Considerations	3-8
	System Wiring Guidelines	3-8
	Grounding Your Cable	3-9
	Determining the Cable Length	3-9
	Wiring the Analog Module	3-10
	Labeling and Installing the Terminal Block	3-12
	Grounding the Foil Shields and Drain Wires	3-12
	Minimizing Electrical Noise on Analog Modules	3-14

Module Operation and System Considerations

Chapter 4

Interface between the Module and the Processor	4-2
Entering Module ID Codes	4-2
Addressing Analog Modules	4-2
Bit Level Addressing	4-5
Processor Update of Analog Data	4-6
Monitoring the Input and Output Data	4-6
Converting Analog Input Data	4-7
Converting Analog Output Data	4-8
System Considerations	4-10
Safe State for Outputs	4-10
Retentive Programming Option	4-10
Retentive Analog Output Example	4-11
Non-Retentive Analog Output Example	4-11
During a Mode Change or Power Cycle	4-12
Input Out-of-Range Detection	4-12
Response to Slot Disable	4-14
Input Response to Slot Disable	4-14
Output Response to Slot Disable	4-14
Input Channel Filtering	4-15

Testing Your Module

Chapter 5

Testing the SLC 500 System	5-1
Start-up Procedures	5-1
Inspect the Analog Module	5-2
Disconnect Prime Movers (Motion Devices)	5-2
Power Up the SLC 500 System	5-3
Testing Analog Inputs	5-4
Testing Analog Outputs	5-6

Programming Examples

Chapter 6

Addressing, Out-of-Range Detection, and Scaling of Analog Inputs ..	6-1
Calculating the Linear Relationship	6-2
Calculating the Out-of-Range Flag	6-2
Using Standard Math	6-4
Using SCL Instruction	6-5
Addressing and Scaling Outputs	6-6
Calculating the Linear Relationship	6-6
Using Standard Math	6-8
Scaling Offset when $>32,767$ or $<-32,768$	6-9
Calculating the Linear Relationship	6-9
Calculating the Shifted Linear Relationship	6-10
Using Standard Math	6-11
Scaling and Range Checking of Analog Inputs and Outputs	6-12
Calculating the Linear Relationship	6-12

	Using Standard Math Instructions	6-14
	Scaling and Range Checking of Analog Inputs and Outputs	6-15
Maintenance and Safety	Chapter 7	
	Preventative Maintenance	7-1
	Safety Considerations When Troubleshooting	7-2
Specifications	Appendix A	
	Analog Module Specifications	A-1
	General Specifications for NI4, NIO4I, NIO4V, NO4I, and NO4V ...	A-1
	General Analog Input Specifications for NI4, NIO4I, NIO4V	A-2
	Current-Loop Input Specifications for NI4, NIO4I, and NIO4V	A-3
	Voltage Input Specifications for NI4, NIO4I, and NIO4V	A-3
	Current Output Specifications for NIO4I and NO4I	A-4
	Voltage Output Specifications for NIO4V and NO4V	A-5
Two's Complement Binary Numbers	Appendix B	
	Positive Decimal Values	B-1
	Negative Decimal Values	B-2
Optional Analog Input Software Calibration	Appendix C	
	Calibrating an Analog Input Channel	C-1
	Calculating the Software Calibration	C-2
	Procedure	C-2
	Example Ladder Diagram	C-3
Module Input and Output Circuits	Appendix D	
	Input Circuit for 1746-NI4, -NIO4I, and -NIO4V Modules	D-1
	Voltage Output Circuit for 1746-NIO4V Modules	D-1
	Current Output Circuit for 1746-NIO4I Modules	D-1
	Isolation Diagram	D-2

Preface

Read this preface to familiarize yourself with the rest of the manual. This preface covers the following topics:

- who should use this manual
- the purpose of this manual
- terms and abbreviations
- conventions used in this manual
- Allen-Bradley support

Who Should Use this Manual

Use this manual if you are responsible for designing, installing, programming, or troubleshooting control systems that use Allen-Bradley small logic controllers.

You should have a basic understanding of SLC 500™ products. You should understand programmable controllers and be able to interpret the ladder logic instructions required to control your application. If you do not, contact your local Allen-Bradley representative for information on available training courses before using this product.

Purpose of this Manual

This manual is a reference guide for the analog modules. It describes the procedures you use to install the analog modules and integrate them into your SLC 500 system.

Terms and Abbreviations

The following terms and abbreviations are specific to this product. For a complete listing of Allen-Bradley terminology, refer to the *Allen-Bradley Industrial Automation Glossary*, Publication Number ICCG-7.1.

A/D Conversion – Generation of a digital value whose magnitude is proportional to the instantaneous magnitude of an analog signal.

Channel – Refers to one of four small-signal analog input interfaces available on the module's terminal block. Each channel is configured for connection to an RTD or potentiometer input device, and has its own diagnostic status word.

Chassis – A hardware assembly that houses devices such as I/O modules, adapter modules, processor modules, and power supplies.

Common Mode Rejection – For analog inputs, the maximum level to which a common mode input voltage appears in the numerical value read by the processor, expressed in dB.

Common Mode Voltage – For analog inputs, the voltage difference between the negative terminal and analog common during normal differential operation.

Common Mode Voltage Range – For analog inputs, the largest voltage difference allowed between either the positive or negative terminal and analog common during normal differential operation.

D/A Conversion – Generation of an analog signal whose instantaneous magnitude is proportional to the magnitude of a digital value.

Differential Operation – The difference in voltage between a channel's positive terminal and negative terminal.

Differential Voltage, Maximum – The largest voltage difference allowed between the negative terminal and positive terminal during normal differential operation.

Maximum Differential Voltage – The largest voltage difference allowed between the negative terminal and positive terminal during normal differential operation.

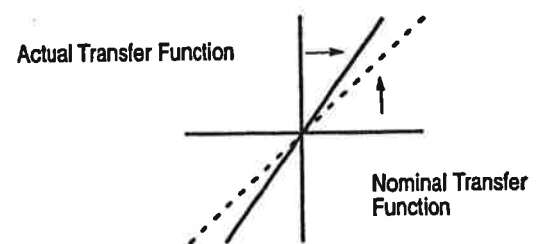
Full Scale – The magnitude of voltage or current over which normal operation is permitted.

Gain – Ratio of output signal to input signal magnitudes. The “gain” of an analog input or output is the scale factor which provides the nominal conversion relationship. Typically, this is the slope of the line when analog voltage or current is plotted versus the corresponding digital codes. (see Gain Error.)

Gain Error – The “gain” of an analog input or output is the scale factor which provides the nominal conversion relationship. Typically, this is the slope of the line when analog voltage or current is plotted versus the corresponding digital codes.

Figure P.1

Change in slope due to Gain Error
(exaggerated)



Gain error is the deviation of the scale factor or slope of the line from the ideal or nominal value. Gain error is expressed in percent of the input or output value.

Gain Error Drift – The effect of temperature on gain error is expressed by gain error drift. As temperature varies from $+25^{\circ}\text{C}$, the possible gain error increases. The gain error drift is specified in percent of input or output value $/^{\circ}\text{C}$.

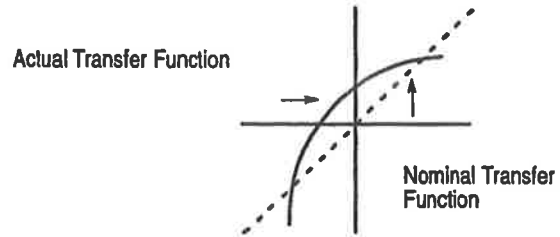
Least Significant Bit (LSB) – The digit (or bit) in a binary word (code) that carries the smallest value of weight. For the analog modules, 16-bit two's complement binary codes are used in the I/O image in the card.

For analog inputs, the LSB is defined as the rightmost bit, bit 0, of the 16-bit field. For analog outputs, the two rightmost bits are not significant, and the LSB is defined as the third bit from the right, bit 2, of the 16-bit field.

Linearity Error – An analog input or output is composed of a series of voltage or current values corresponding to digital codes. For an ideal analog input or output, the values lie in a straight line spaced by a voltage or current corresponding to 1 LSB. Any deviation of the converted input or actual output from this line is the linearity error of the input or output. The linearity is expressed in percent of full scale input or output.

Figure P.2

Variation from straight line due to Linearity Error (exaggerated)



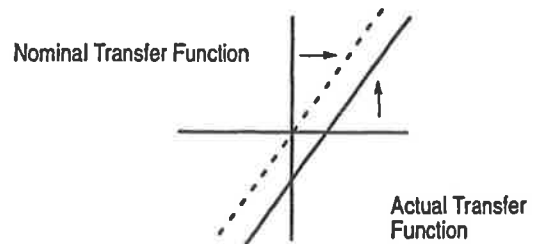
Number of Significant Bits – The power of two that represents the total number of completely different digital codes an analog signal can be converted into or generated from.

Offset – The steady-state deviation of a controlled variable from a fixed setpoint.

Offset Error – For analog inputs, the offset error is the non-zero digital code when zero voltage or zero current is applied to the input terminals. For analog outputs, the offset error is the non-zero digital code required to produce zero voltage or current at the output terminals.

Figure P.3

Offset Error (exaggerated)



Offset Error Drift – The effect of temperature on offset error is expressed by offset error drift. As temperature varies from $+25^{\circ}\text{C}$, the possible offset error increases. The offset error drift is specified in $\text{LSB}/^{\circ}\text{C}$ of full scale.

Overall Accuracy – The worst case deviation of the output voltage or current from the ideal over the full output range is the overall accuracy. For inputs, the worst case deviation of the digital representation of the input signal from the ideal over the full input range is the overall accuracy. This is expressed in percent of full scale.

Gain error, offset error, and linearity error all contribute to input and output channel accuracy.

Repeatability – The closeness of agreement among repeated measurements of the same variable under the same conditions.

Resolution – The nominal voltage or current increment that equals the smallest change, step or level, detected or represented by the analog channel.

Safe State – The state of the analog outputs entered when the processor is not in RUN mode. The user must insure that this is a safe state for the application.

Step Response – For inputs, the time required for the analog input signal to reach 95% of its expected final value.

Update Time – For analog inputs, the time between updates to the memory of the analog module of the digital value representing the analog input signal.

For analog outputs, the time from the digital code being received at the analog module to the analog output signal of the digital code being output at the terminals of the output channel.

Contents of this Manual

Table P.A

Chapter	Title	Contents
	Preface	Describes the purpose, background, and scope of this manual. Also specifies the audience for whom this manual is intended.
1	Overview	Describes how to use analog and the types of analog modules.
2	Quick Start for Experienced Users	Serves as a <i>Quick Start Guide</i> for the analog module.
3	Installing and Wiring Your Analog Module	Describes how to wire and install analog modules.
4	Module Operation and System Considerations	Describes how the module operates in a SLC 500 system and the application interface.
5	Testing Your Module	Describes how to test your module.
6	Programming Examples	Provides example programs depicting typical applications for the analog module.
7	Maintenance and Safety	Provides preventive maintenance ideas and safety considerations.
Appendix A	Specifications	Provides detailed technical specifications.
Appendix B	Two's Complement Binary Numbers	Describes Two's Complement Binary Numbers.
Appendix C	Optional Analog Input Software Calibration	Describes how to calibrate your module using software offsets.
Appendix D	Module Input and Output Circuits	Internal wiring of the module's I/O circuits

Related Documentation

The following documents contain additional information concerning Allen-Bradley SLC™ and PLC® products. To obtain a copy, contact your local Allen-Bradley office or distributor.

Table P.8

For	Read This Document	Document Number
An overview of the SLC 500 family of products	SLC 500 System Overview	1747-2.30
A description on how to install and use your <i>Modular</i> SLC 500 programmable controller	Installation & Operation Manual for Modular Hardware Style Programmable Controllers	1747-6.2
A description on how to install and use your <i>Fixed</i> SLC 500 programmable controller	Installation & Operation Manual for Fixed Hardware Style Programmable Controllers	1747-NI001
A procedural manual for technical personnel who use APS to develop control applications	Allen-Bradley Advanced Programming Software (APS) User Manual	1747-6.4
A reference manual that contains status file data, instruction set, and troubleshooting information about APS	Allen-Bradley Advanced Programming Software (APS) Reference Manual	1747-6.11
An introduction to APS for first-time users, containing basic concepts but focusing on simple tasks and exercises, and allowing the reader to begin programming in the shortest time possible	Getting Started Guide for APS	1747-6.3
A procedural and reference manual for technical personnel who use an HHT to develop control applications	Allen-Bradley Hand-Held Terminal User Manual	1747-NP002
An introduction to HHT for first-time users, containing basic concepts but focusing on simple tasks and exercises, and allowing the reader to begin programming in the shortest time possible	Getting Started Guide for HHT	1747-NM009
A training and quick reference guide to APS	SLC 500 Software Programmer's Quick Reference Guide Using APS—available on PASSPORT, list price of \$50.00	ABT-1747-TSG001
A training and quick reference guide to A.I.	SLC 500 Troubleshooting Guide Using A.I. Series—available on PASSPORT, list price of \$50.00	ABT-1747-TSJ21
A common procedures guide to APS	SLC 500 Family Common Procedures Guide Using APS—available on PASSPORT, list price of \$50.00	ABT-1747-T550
A common procedures guide to A.I.	SLC 500 Family Common Procedures Guide Using A.I. Series—available on PASSPORT, list price of \$50.00	ABT-1747-TSJ51
In-depth information on grounding and wiring Allen-Bradley programmable controllers	Allen-Bradley Programmable Controller Grounding and Wiring Guidelines	1770-4.1
A description of important differences between solid-state programmable controller products and hard-wired electromechanical devices	Application Considerations for Solid-State Controls	SGL-1.1
An article on wire sizes and types for grounding electrical equipment	National Electrical Code	Published by the National Fire Protection Association of Boston, MA.
A complete listing of current Allen-Bradley documentation, including ordering instructions. Also indicates whether the documents are available on CD-ROM or in multi-languages.	Allen-Bradley Publication Index	SD499
A glossary of industrial automation terms and abbreviations	Allen-Bradley Industrial Automation Glossary	AG-7.1

Common Techniques Used in this Manual

The following conventions are used throughout this manual:

- Bulleted lists such as this one provide information, not procedural steps.
- Numbered lists provide sequential steps or hierarchical information.
- *Italic* type is used for emphasis.
- Text in **this** font indicates words or phrases you should type.

We also use this convention to call attention to helpful information.



Allen-Bradley Support

Allen-Bradley offers support services worldwide, with over 75 Sales/Support Offices, 512 authorized Distributors and 260 authorized Systems Integrators located throughout the United States alone, plus Allen-Bradley representatives in every major country in the world.

Local Product Support

Contact your local Allen-Bradley representative for:

- sales and order support
- product technical training
- warranty support
- support service agreements

Technical Product Assistance

If you need to contact Allen-Bradley for technical assistance, please review the information in the *Troubleshooting* chapter first. Then call your local Allen-Bradley representative.

Your Questions or Comments on this Manual

If you find a problem with this manual, please notify us of it on the enclosed Publication Problem Report.

If you have any suggestions for how this manual could be made more useful to you, please contact us at the address below:

Allen-Bradley Company, Inc.
Automation Group
Technical Communication, Dept. 602V, T122
P.O. Box 2086
Milwaukee, WI 53201-2086

Overview

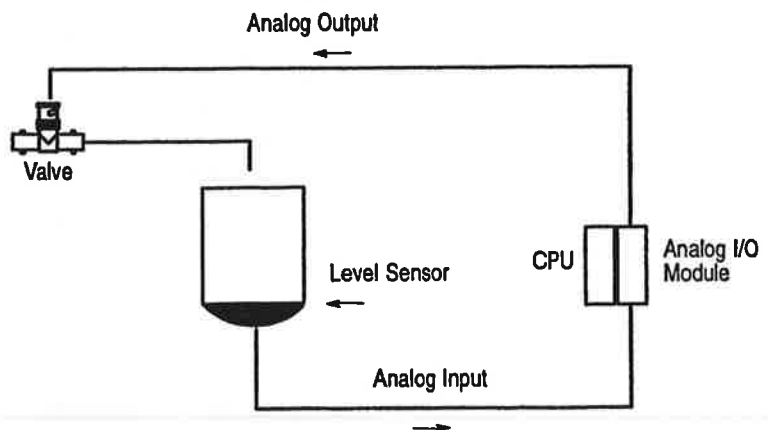
This chapter describes how analog is used and provides two application examples of analog. The types of available analog modules and their related specifications are also described.

How to Use Analog

Analog refers to the representation of numerical quantities by the measurement of continuous physical variables. Analog applications are present in many forms. The following application shows a typical use of analog.

In this application the processor controls the amount of fluid placed in a holding tank by adjusting the percentage of the valve opening. The valve is initially open 100%. As the fluid level in the tank approaches the preset point, the processor modifies the output to degrade closing the valve 90%, 80%, adjusting the valve to maintain a set point.

Figure 1.1



Types of Analog Modules

1746-NI4 Analog Input Module

The 1746-NI4 Analog Input module contains 4 analog input channels that are user selectable per channel for voltage or current to support a variety of monitoring and controlling applications

1746-NIO4I and NIO4V Analog Combination Modules

The NIO4I and NIO4V Analog Combination I/O modules provide two input and two output channels in a single slot module. The 1746-NIO4I module contains two current or voltage inputs (user selectable per channel), and two current outputs. The 176-NIO4V module contains two current or voltage inputs (user selectable per channel) and two voltage outputs.

1746-NO4I and NO4V Analog Output Modules

The NO4I and NO4V Analog Output Modules provide 4 analog output channels. The NO4I module contains four current outputs. The NO4V module contains four voltage outputs. Both of these modules support a variety of monitoring and controlling applications.

Table 1.A

Catalog 1746-	Input Channels per Module	Output Channels per Module	Backplane Current Draw		External 24V dc Power Supply Tolerance
			5V (max.)	24V (max.)	
NI4	4 differential, voltage or current selectable per channel, not individually isolated	NA	35 mA	85 mA	NA
NIO4I	2 differential, voltage or current selectable per channel, not individually isolated	2 current outputs, not individually isolated	55 mA	145 mA	NA
NIO4V	2 differential, voltage or current selectable per channel, not individually isolated	2 voltage outputs, not individually isolated	55 mA	115 mA	NA
NO4I	NA	4 current outputs, not individually isolated	55 mA	195 mA	24 \pm 10% at 195 mA max. (21.6 to 26.4V dc) [Ⓞ]
NO4V	NA	4 voltage outputs, not individually isolated	55 mA	145 mA	24 \pm 10% at 145 mA max. (21.6 to 26.4V dc) [Ⓞ]

[Ⓞ] Required for some applications if SLC 24V power is at a premium.

For more specification information, refer to Appendix A.

Quick Start for Experienced Users

This chapter can help you to get started using analog. We base the procedures here on the assumption that you have an understanding of SLC 500 products. You should understand electronic process control and be able to interpret the ladder logic instructions required to generate the electronic signals that control your application.

Because it is a start-up guide for experienced users, this chapter *does not* contain detailed explanations about the procedures listed. It does, however, reference other chapters in this book where you can get more information.

If you have any questions or are unfamiliar with the terms used or concepts presented in the procedural steps, *always read the referenced chapters* and other recommended documentation before trying to apply the information.

This chapter:

- tells you what tools and equipment you need
- lists preliminary considerations
- describes when to configure the module
- explains how to install and wire the module
- discusses system power-up procedures

Required Tools and Equipment

Have the following tools and equipment ready:

- small blade screwdriver
- an adequate length of communication cable (Belden 8761) for your specific application. (See chapter 3, Installing and Wiring Your Analog Module for maximum cable distances.)
- programming equipment

Procedures

1. Check the contents of shipping box.

Reference

Unpack the shipping box making sure that the contents include:

- Analog I/O module (Catalog Number 1746- Series)
- user manual (Publication 1746-6.4)

If the contents are incomplete, call your local Allen-Bradley representative for assistance.

2. Determine your power requirements for the modular controller.

Reference

Review the power requirements of your system to see that your chassis supports placement of the analog module.

- For modular style systems, calculate the total load on the system power supply using the procedure described in the SLC Installation & Operation Manual for modular style controllers (Publication Number 1747-6.2) or the SLC 500 Family System Overview (Publication Number 1747-2.30).
- For fixed SLC 500 controllers, refer to table 3.B on page 3-3.

Chapter 3
*(Installing and
Wiring Your
Analog Module)*

Appendix A
(Specifications)



Catalog Number	Backplane Current Draw		External 24V dc Power Supply Tolerance
	5V (max.)	24V (max.)	
1746-NI4	35 mA	85 mA	NA
1746-NIO4I	55 mA	145 mA	NA
1746-NIO4V	55 mA	115 mA	NA
1746-NO4I	55 mA	195 mA	24 ±10% at 195 mA max. (21.6 to 26.4V dc) ^①
1746-NO4V	55 mA	145 mA	24 ±10% at 145 mA max. (21.6 to 26.4V dc) ^①

^① Required for some applications.

3. Configure the module using the DIP switches (analog inputs only).	Reference
---	------------------

Each analog input channel can be configured for either voltage or current. Locate the DIP switches on your module and set them for your application.

Chapter 3
(Installing and Wiring Your Analog Module)

-  ON – Configures channel for current input
-  Off – Configures channel for voltage input

1746-NI4



Switch 1 = Channel 0
Switch 2 = Channel 1
Switch 3 = Channel 2
Switch 4 = Channel 3

Current

Voltage

1746-NIO4I, NIO4V



Switch 1 = Channel 0
Switch 2 = Channel 1

Current

Voltage

1746-NO4I, NO4V

24V dc
Power
Selector



Sw 1

Backplane

4. Install your module.**Reference**

When selecting a slot for an analog module, position the module:

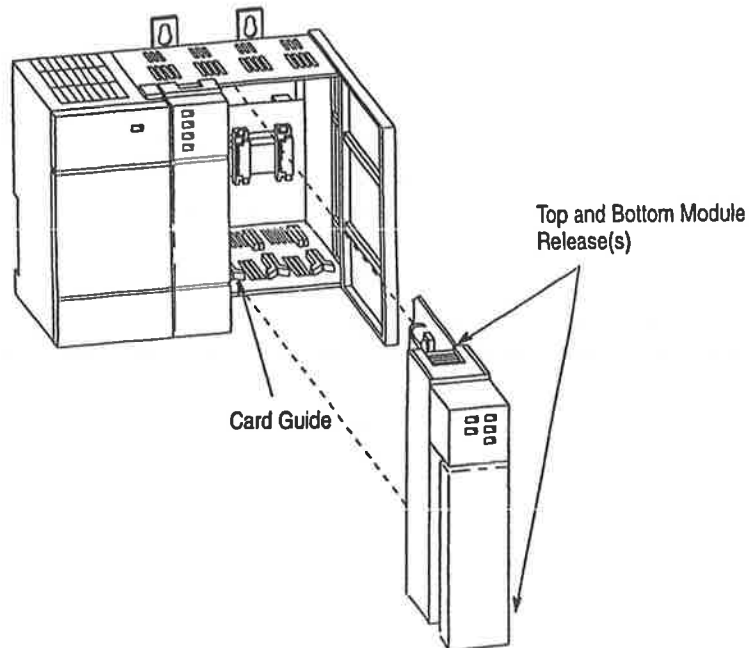
- In a slot away from ac or high voltage dc modules
- In the chassis closest to the bottom of the enclosure where the SLC 500 system is installed
- away from the chassis power supply if installed in a modular system

Chapter 3
*(Installing and
Wiring Your
Analog Module)*



ATTENTION: Never install, remove, or wire modules with power applied to the chassis or devices wired to the module.

Make sure system power is off; then insert the analog module into your 1746 chassis. In this example procedure, local slot 1 is selected.



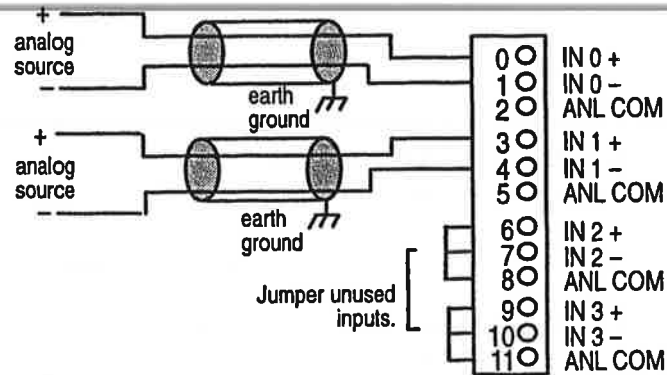
5. Wire the module.	Reference
----------------------------	------------------

Chapter 3
(Installing and
Wiring Your
Analog Module)

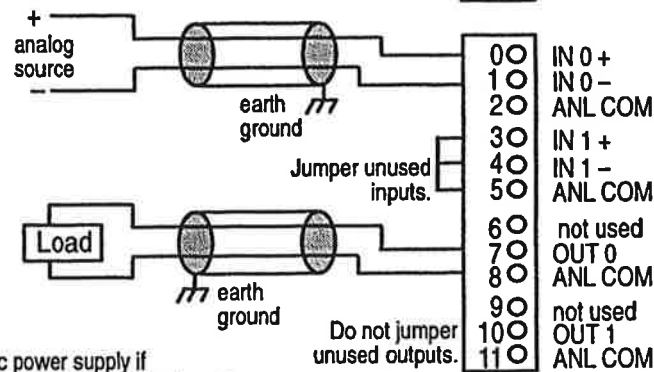
Important: Follow these guidelines when wiring the module.

- Use shielded communication cable (Belden 8761) and keep length as short as possible.
- Connect only one end of the cable shield to earth ground.
- Channels are not isolated from each other. All analog commons are connected together internally.
- The module does not provide power for analog inputs.
- Use a power supply that matches the transmitter (sensor) specifications.

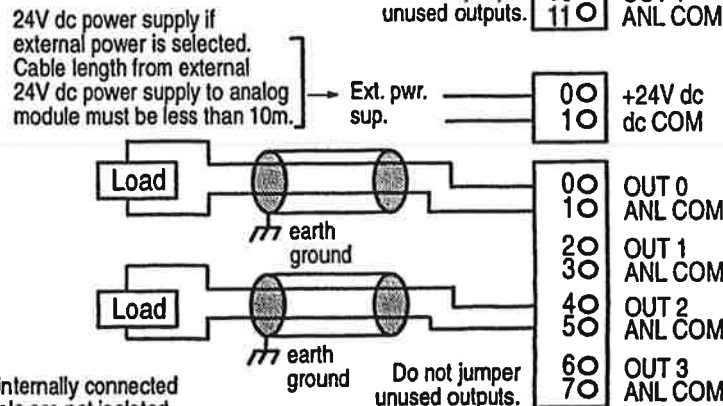
NI4



NIO4I & NIO4V



NO4I & NO4V



Analog commons are internally connected in the module. Channels are not isolated from each other.

6. Configure system I/O configuration.**Reference**

Configure your system I/O configuration for the particular slot the analog module is in. When assigning an I/O module to a slot location, select the module from the displayed list. If not listed, select *OTHER* at the bottom of the list and enter the module's ID code at the prompt.

Chapter 4
*(Module Operation
and System
Considerations)*

Catalog No.	Module ID Code
1746-NI4	4401
1746-NIO4I	3201
1746-NIO4V	3202
1746-NO4I	5401
1746-NO4V	5402

7. Check that the module is operating correctly.**Reference**

ATTENTION: Machine motion during system checkout can be hazardous to personnel. During all checkout procedures, you must disconnect all devices which, when energized, might cause machine motion.

Chapter 5
*(Testing Your
Module)*

Apply power to the fixed or modular system. The analog module LED (red) should be illuminated, indicating that the module is receiving 24V dc power.

8. Understanding analog inputs.

Reference

Analog inputs convert current and voltage signals into 16-bit (max.) integer values and place them in the input image for the slot that the analog module resides in.

Chapter 4
*(Module Operation
and System
Considerations)*

Address	NI4
I:e.0	Input Channel 0
I:e.1	Input Channel 1
I:e.2	Input Channel 2
I:e.3	Input Channel 3

Address	NIO4I, NIO4V
I:e.0	Input Channel 0
I:e.1	Input Channel 1

e=slot number

Voltage/Current Range	Integer Representation
-10V dc to +10V dc	-32,768 to +32,767
0 to 10V dc	0 to 32,767±10V dc
0 to 5V dc	0 to 16,384
1 to 5V dc	3,277 to 16,384
-20 mA to +20 mA	-16,384 to +16,384
0 to 20 mA	0 to 16,384±20 mA
4 to 20 mA	3,277 to 16,384

9. Understanding analog outputs.

Reference

Analog outputs convert 16-bit integer values placed in the output image to voltage or current signals for the slot that the analog card is in.

Chapter 4
*(Module Operation
and System
Considerations)*

Address	NO4
O:e.0	Output Channel 0
O:e.1	Output Channel 1
O:e.2	Output Channel 2
O:e.3	Output Channel 3

Address	NIO4I, NIO4V
O:e.0	Output Channel 0
O:e.1	Output Channel 1

NO4I, NIO4I	
Current Range	Decimal Representation for Output Word
0 to 21 mA	0 to 32,764
0 to 20 mA	0 to 31,208
4 to 20 mA	6,242 to 31,208

NO4V, NIO4V	
Voltage Range	Decimal Representation for Output Word
-10 to +10V dc	-32,768 to +32,764
0 to 10V dc	0 to 32,764
0 to 5V dc	0 to 16,384
1 to 5V dc	3,277 to 16,384

10. Write ladder logic to process the module's analog data.**Reference**

Several programming examples are provided in chapter 6 that demonstrate how to scale the raw data from the analog card into engineering units such as psi, percent, etc. Study these examples and apply them to your application as appropriate.

Chapter 5
*(Testing Your
Module)*

Chapter 6
*(Programming
Examples)*

Installing and Wiring Your Analog Module

To obtain the maximum performance from an analog module, proper module installation is imperative. This chapter describes the procedures that you must follow to install the analog module in an SLC 500 system. The following items are described:

- European Union Directive Compliance
- determining your power requirements
- configuring your module
- selecting a slot in the chassis
- installing your module
- wiring considerations
 - system wiring guidelines
 - grounding your cable
 - determining the cable length
- wiring the analog module
- minimizing electrical noise on the analog module

European Union Directive Compliance

If this product is installed within the European Union or EEA regions and has the CE mark, the following regulations apply.

EMC Directives

This product is tested to meet Council Directive 89/336/EEC Electromagnetic Compatibility (EMC) and the following standards, in whole or in part, documented in a technical construction file:

- EN 50081-2
EMC – Generic Emission Standard, Part 2 – Industrial Environment
- EN 50082-2
EMC – Generic Immunity Standard, Part 2 – Industrial Environment

This product is intended for use in an industrial environment.

Determining Your Power Requirements for a Modular Controller

Analog modules require both 5V dc and 24V dc power from the backplane of the SLC 500 system. However, the NO4I and NO4V analog modules can use an external 24V dc power supply. This eliminates the 24V dc backplane power requirement, providing configuration flexibility if SLC power supply loading is critical. These two modules provide user-supplied external 24V dc power supply connections. ^①

The following table shows the power requirements for each analog module using backplane power. Use this table to calculate the total load on the modular system power supply. For more information refer to the Installation & Operation Manual for modular controllers.

Important: The analog modules do not supply loop power for the input device. You must supply the appropriate loop power for loop-powered input devices.

Table 3.A

Catalog Number	5 Volt Current	24 Volt Current
1746-NI4	35 mA	85 mA
1746-NIO4I	55 mA	145 mA
1746-NIO4V	55 mA	115 mA
1746-NO4I	55 mA	195 mA ^②
1746-NO4V	55 mA	145 mA ^②

- ^① The 24V dc user power connection on a fixed SLC 500 can power an NO4I or NO4V analog module. However, the regulation of the 24V dc user connection on a modular SLC 500 power supply, Catalog Number 1746-P1, -P2, -P4 is outside of the requirements of the NO4I and NO4V analog modules and cannot be used.
- ^② Omit these values from your SLC power supply loading calculations if you decide to use an external power supply.

Determining Your Power Requirements for a Fixed Controller

The following chart provides available analog module combinations in the expansion chassis of a fixed controller.

Table 3.B

- valid combination
- invalid combination
- valid combination when used with external power supply

BASIC net = Basic Module is supplying power to an AIC. No other device requiring power is connected to the AIC.

NI4	NIO4I	NIO4V	NO4I	NO4V	
•	•	•	-	•	IA4
•	•	•	∇	•	IA8
•	•	•	∇	•	IA16
•	•	•	∇	•	IM4
•	•	•	∇	•	IM8
•	•	•	∇	•	IM16
•	•	•	∇	•	OA8
			∇	∇	OA16
			∇	∇	OAP12
•	•	•	∇	•	IB8
•	•	•	∇	•	IB16
•	•	•	∇	•	IV8
•	•	•	∇	•	IV16
•	•	•	∇	•	IG16
•	•	•	∇	•	OV8
•	•	•	∇	∇	OV16
•	•	•	∇	•	OB8
•	•	•	∇	•	OG16
•		•	∇	∇	OW4
•			∇	∇	OW8
			∇	∇	OW16
•	•	•	∇	•	IO4
•		•	∇	∇	IO8
•			∇	∇	IO12
•			∇	∇	NI4
			∇	∇	NIO4I
			∇	∇	NIO4V
			∇	∇	DCM
•			∇	∇	HS
•			∇	∇	OB16
•	•	•	∇	•	IN16
			∇	∇	BASIC net
•		•	∇	∇	BASIC
					OB32
					OV32
•	•	•	∇	•	IV32
•	•	•	∇	•	IB32
•			∇	∇	OX8
∇	∇	∇	∇	∇	NO4I
∇	∇	∇	∇	∇	NO4V
•	•	•	∇	•	ITB16
•	•	•	∇	•	ITV16
•	•	•	∇	•	IC16
•		•	∇	∇	OBP16
•		•	∇	∇	OVP16
•	•	•	∇	•	NT4
•	•	•	∇	•	NR4

Important: The NO4I and NO4V modules provide user supplied external 24V dc power supply connections. When the NO4I module is used in a fixed controller, you must provide an external power supply.


When the NO4I or NO4V is used with an external 24V dc power supply and is placed in a fixed controller expansion chassis, it is compatible with those modules noted in the compatibility chart on the previous page.^① When set for external power, the module will only draw the 5V current off the backplane. Refer to the next section for details on how to configure your module for external power.

- ^① The 24V dc user power connection on a fixed SLC 500 can power an NO4I or NO4V analog module. However, the regulation of the 24V dc user connection on a modular SLC 500 power supply, Catalog Number 1746-P1, -P2, and -P4 is outside of the requirements of the NO4I and NO4V analog modules and cannot be used.

Configuring Your Module

The NI4, NIO4I and NIO4V analog modules have user selectable DIP switch settings which allow you to configure the input channels as either current or voltage inputs. The switches are located on the analog module board. The following illustration shows the ON and OFF switch settings. Switch orientation is also provided on the nameplate of the module.

Figure 3.1

-  ON – Configures channel for current input
-  OFF – Configures channel for voltage input

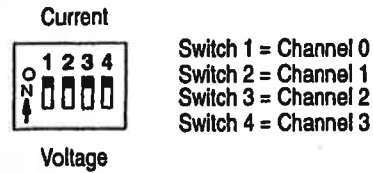


ATTENTION: Care should be taken to avoid connecting a voltage source to a channel configured for current input. Improper module operation or damage to the module can occur.

Switch Settings for the 1746-NI4

The NI4 has 4 individual DIP switches that control the input mode of input channels 0 through 3. A switch in the ON position configures the channel for current input. A switch in the OFF position configures the channel for voltage input.

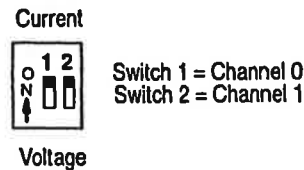
Figure 3.2



Switch Settings for the 1746-NIO4I and -NIO4V

The NIO4I and NIO4V have 2 individual switches labeled 1 and 2. These switches control the input mode of input channel 0 and 1. A switch in the ON position configures the channel for current input. A switch in the OFF position configures the channel for voltage input.

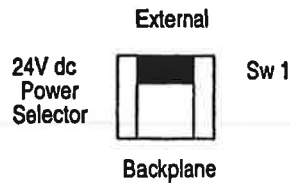
Figure 3.3



External Power Switch for the 1746-NO4I and -NO4V

The NO4I and NO4V analog output modules have an external 24V dc power switch, SW1, which gives you the option of using an external power supply.^① In the UP position, power is drawn from an external power source. In the DOWN position, power is drawn from the backplane of the module. The switch is located on the analog module board. Switch orientation is also provided on the nameplate of the module.

Figure 3.4



^① The 24V dc user power connection on a fixed SLC 500 can power an NO4I or NO4V analog module. However, the regulation of the 24V dc user connection on a modular SLC 500 power supply, Catalog Number 1746-P1, -P2, is outside of the requirements of the NO4I and NO4V analog modules and cannot be used.

Choosing a Slot in the Chassis

Two factors determine where the analog module should be located in the chassis: ambient temperature and electrical noise. Consider the following conditions when selecting a slot for an analog module.

Position the module:

- in a slot away from ac or high voltage dc module
- in the chassis closest to the bottom of the enclosure where the SLC 500 system is installed
- away from the chassis power supply if installed in a modular system

Installing Your Module

All modules are mounted in a single slot. Remember that in a modular system the processor always occupies the first slot of the first chassis.

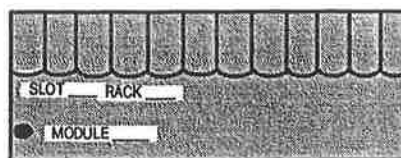
When installing the analog module in a chassis, it is not necessary to remove the terminal block from the module. However, if the terminal block is removed, use the write-on label located on the side of the terminal block to identify the module location and type.



ATTENTION: Never install, remove, or wire modules with power applied to the chassis. Also, do not expose analog modules to surfaces or other areas that may typically hold an electrostatic charge. Electrostatic charges can destroy the analog circuitry.

Figure 3.5

Terminal Block



Removing the Analog Module Terminal Block

To remove the terminal block, grasp it on the top and bottom and pull outward and down.

Important: The potentiometer sets the voltage during factory calibration to 2.5 volts. It is set and sealed at the factory and does not require any adjustments.

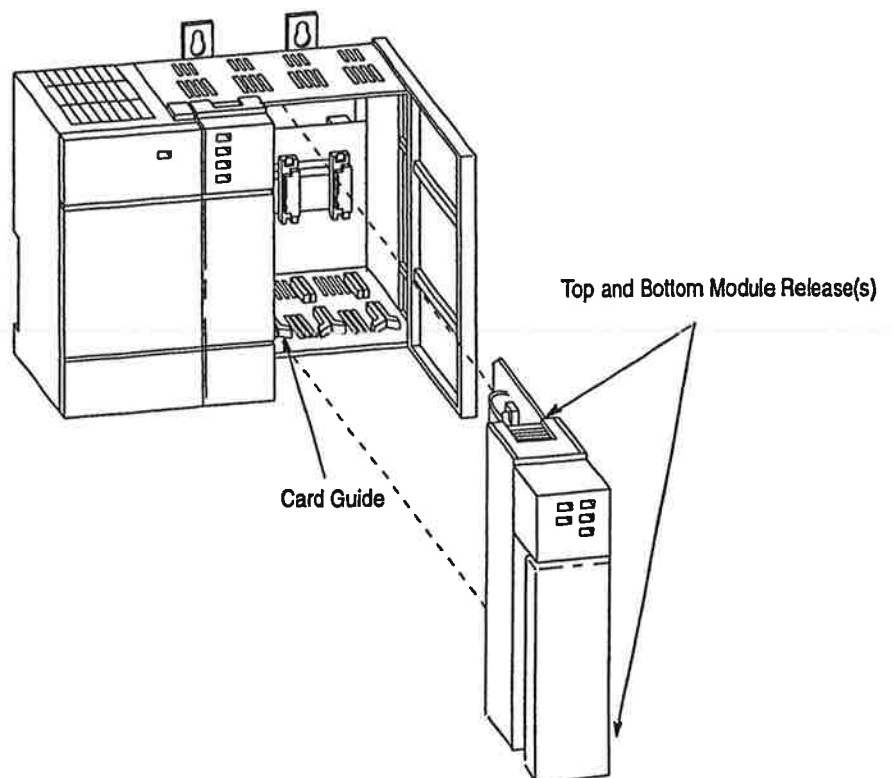
1. Verify that all switches are set correctly for the application.



ATTENTION: Care should be taken to avoid connecting a voltage source to a channel configured for a current input.

2. Align the circuit board of the analog module with the card guide of the chassis (Figure 3.6).
3. Slide the module in until both top and bottom retaining clips are secured.
4. To remove the module, depress the retaining clips at the top and bottom of the module and slide the module out.

Figure 3.6



Wiring Considerations

The following section provides system wiring guidelines, how to ground your Belden cable, and how to determine the cable length.



ATTENTION: Before wiring any analog module, disconnect power from the SLC 500 system and from any other source to the analog module.

System Wiring Guidelines

Use the following guidelines in planning the system wiring for the analog modules:

- all analog common terminals (ANL COM) are electrically connected inside the module. ANL COM is *not* connected to earth ground inside the module.
- voltages on IN+ and IN- terminals must remain within ± 20 Volts with respect to ANL COM to ensure proper input channel operation. This is true for current and voltage input channel operation.
- voltage outputs (OUT 0 and OUT 1) of the NIO4V and NO4V are referenced to ANL COM. Load resistance (R1) for a voltage output channel must be equal to or greater than 1K ohms.
- current output channels (OUT 0 and OUT 1) of the NIO4I and NO4I source current that returns to ANL COM. Load resistance (R1) for a current output channel must remain between 0 and 500 ohms.

Grounding Your Cable

Belden cable #8761 has two signal wires (black and clear), one drain wire and a foil shield. Refer to Figure 3.7. The drain wire and foil shield must be grounded at one end of the cable. *Do not* earth ground the drain wire and foil shield at *both* ends of the cable.

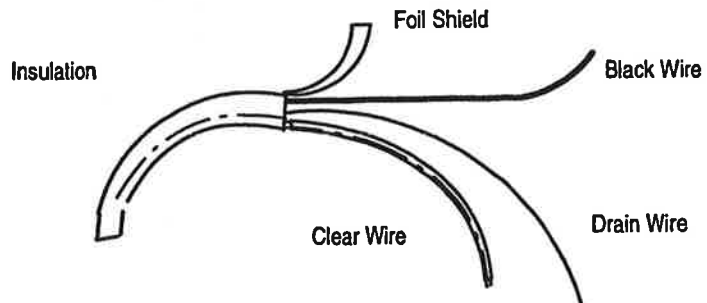
Input Channel – Use a chassis mounting tab as a ground for the drain wire and foil shield.

Output Channel – Ground the drain wire and foil shield at the analog load.

Important: If you cannot ground the output channel at the load, ground the drain wire and foil shield at the chassis mounting tab. *Do not* connect the foil shield or drain wire to the analog terminal block. They *must be* connected to an earth ground, which is not provided at the analog module.

Figure 3.7

Belden Cable #8761



Determining the Cable Length

Determine the length of cable you will need to connect a channel to its input or output device. Remember to leave additional length to route the drain wire and foil shield for earth grounding.

Wiring the Analog Module

After the analog module is properly installed in the chassis, use the following wiring procedure. Belden cable #8761 is recommended when wiring analog modules. This section assumes that you have properly installed the analog module.



ATTENTION: Before wiring any analog module, disconnect power from the SLC 500 system and from any other source to the analog module.

To wire your analog module follow these steps and refer to Figures 3.8 and 3.9.

1. Designate the end of the cable where the drain wire and foil shield is earth grounded as END 1. Designate the other end as END 2.
2. At each end of the cable strip some casing to expose the individual wires.
3. Trim the signal wires to 2 inch lengths. Strip about 3/16 inch (4.76mm) of insulation away to expose the end of the wire.
4. At End 1, twist the drain wire and foil shield together, bend them away from the cable, and apply shrink wrap.
5. At End 2, cut the drain wire and foil shield back to the cable and apply shrink wrap.
6. Connect the signal wires (black and clear) to the terminal block and the input and output devices. The recommended maximum torque is 5 lb.-in (0.565 NM) for all terminals.
 - If the foil shield and drain wire of the channel are grounded at the sourcing device, make sure End 2 of the cable is connected to the terminal block.
 - If the foil shield and drain wire are grounded at the chassis mounting tab, make sure End 1 is connected to the terminal block.
7. Repeat steps 1 through 6 for each channel on the analog module. Jumper the unused plus (+), minus (-) and common terminals of each input channel individually. Unused output and common terminals should be left unconnected.

Figures 3.8 and 3.9 depict the proper cable preparation for END 1 and END 2. Shrink wrap is applied to each cable end. Make sure the foil shield and drain wires on END 1 are long enough to reach their designated earth ground points.

Figure 3.8

**Cable Preparation
END 1**

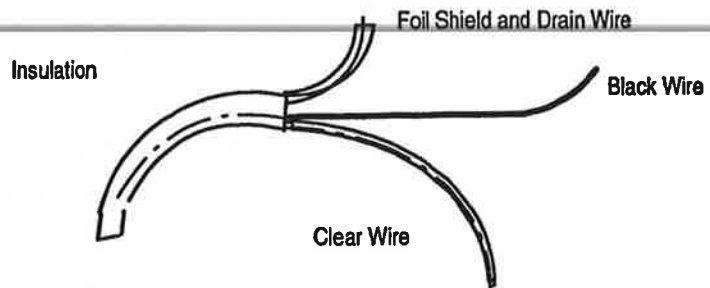
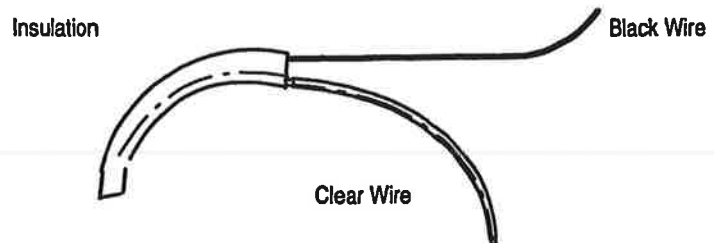


Figure 3.9
END 2

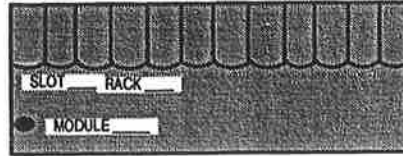


Labeling and Installing the Terminal Block

The terminal block has a write-on label. Labeling the terminal block will help ensure that it is installed on the correct module.

Figure 3.10

Terminal Block



Note: The black dot on the terminal block label indicates the position of terminal 0.

Once you have wired your analog module and properly labeled the terminal block, install the terminal block on the analog module. To install the terminal block:

1. Align the terminal block with the receptacle.
2. Insert the terminal block and press firmly at the top and bottom until it is properly secured.

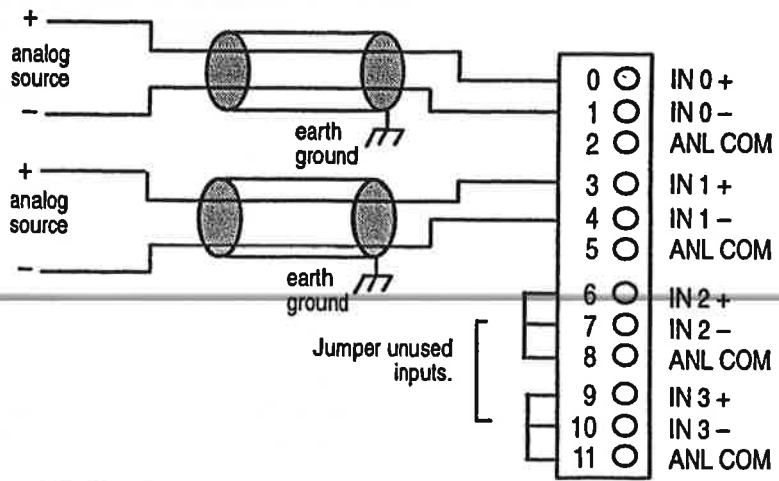
Grounding the Foil Shields and Drain Wires

You are now ready to earth ground your foil shield and drain wire from each cable. Do not connect the foil shield or drain wire to the analog module terminal block. The foil shield and drain wire *must be* connected to earth ground, which is not available on the terminal block. Refer to Figure 3.11 for wiring diagrams of the analog modules.

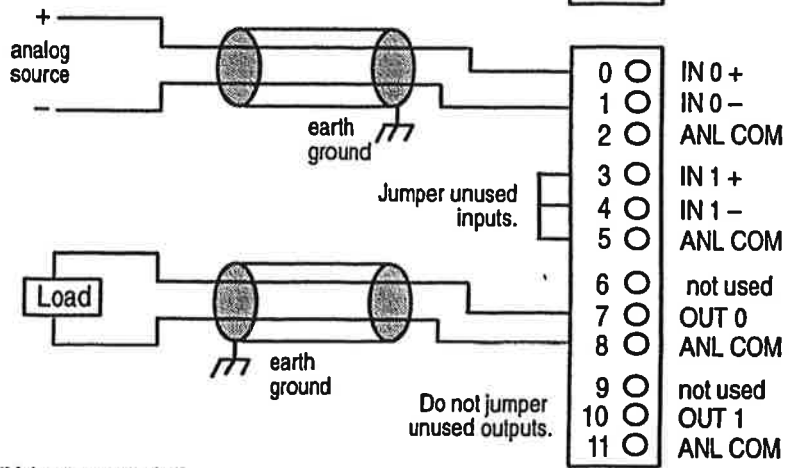
Figure 3.11

Wiring Diagram
(showing differential inputs)

NI4

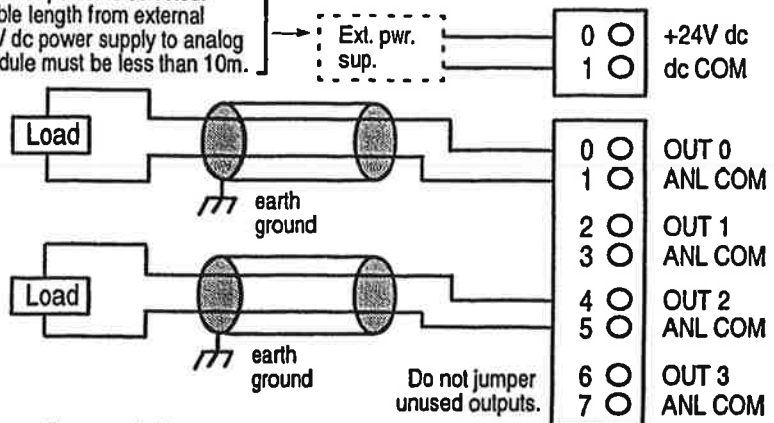


NIO4I & NIO4V



NO4I & NO4V

24V dc power supply if external power is selected. Cable length from external 24V dc power supply to analog module must be less than 10m.



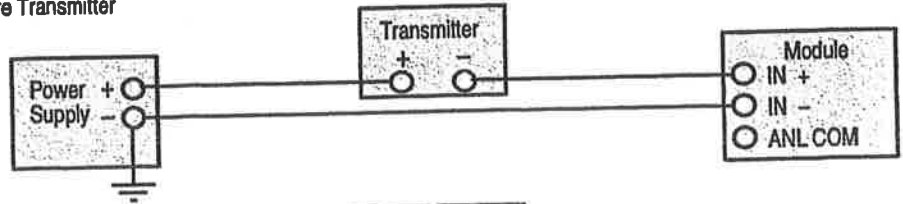
Analog commons are internally connected in the module. Channels are not isolated from each other.

Figure 3.12

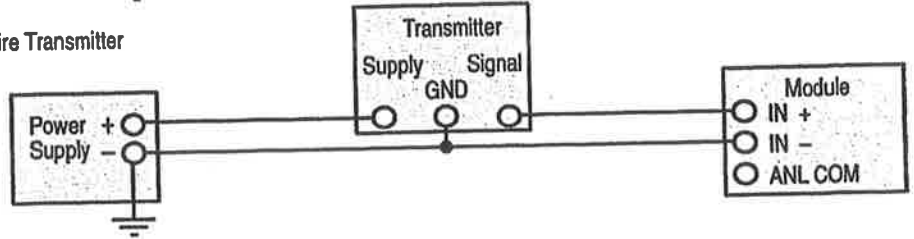
Wiring Schematics for 2, 3, and 4-Wire Analog Input Devices

Important: The module does *not* provide loop power for analog inputs. Use a power supply that matches the transmitter specifications.

2-Wire Transmitter



3-Wire Transmitter



4-Wire Transmitter

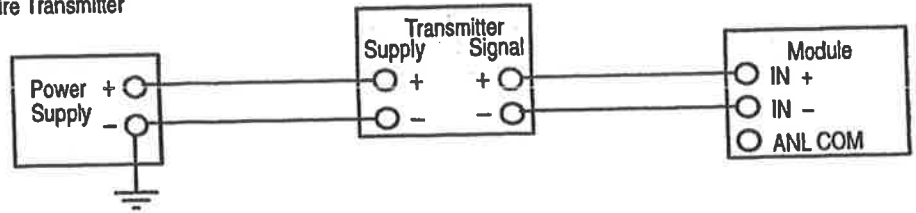
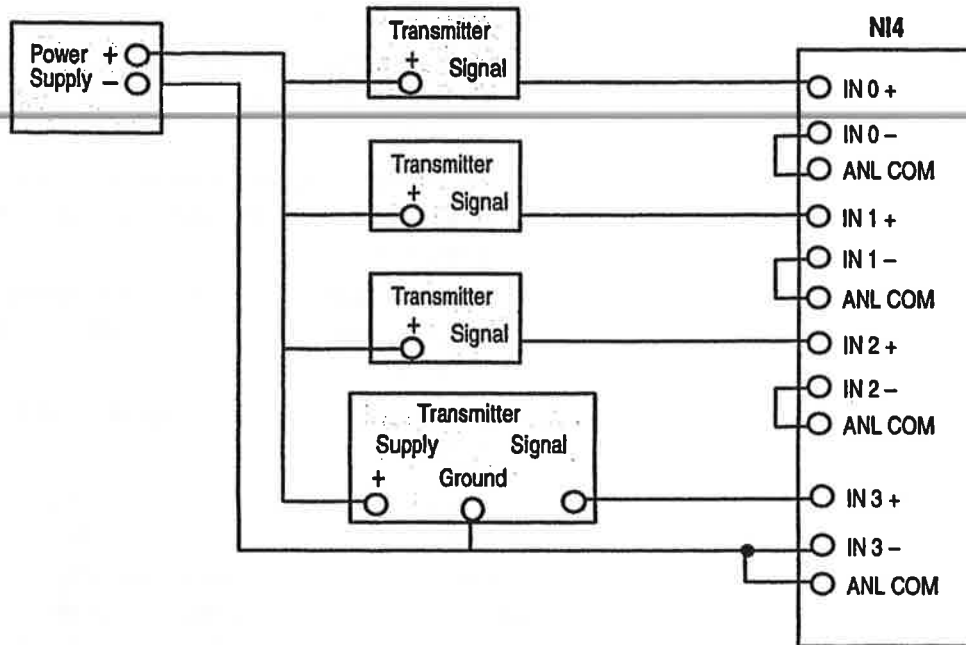


Figure 3.13

Wiring Schematic for Single-ended Analog Input Connections

When wiring single-ended analog input devices to the analog input card, the number of total wires necessary can be limited by using the ANALOG COMMON terminal. Note that differential inputs are more immune to noise than single-ended inputs.



Minimizing Electrical Noise on Analog Modules

Inputs on analog modules employ digital high frequency filters that significantly reduce the effects of electrical noise on input signals. However, because of the variety of applications and environments where analog modules are installed and operating, it is impossible to ensure that all environmental noise will be removed by the input filters.

Although it is not the purpose of this manual to address SLC 500 system procedures, several specific steps can be taken to help reduce the effects of environmental noise on analog signals:

- install the SLC 500 system in a properly rated (i.e., NEMA) enclosure. Make sure that the SLC 500 system is properly grounded.
- use Belden cable #8761 for wiring the analog modules making sure that the drain wire and foil shield are properly earth grounded.
- route the Belden cable separate from any other wiring. Additional noise immunity can be obtained by routing the cables in grounded conduit.
- group analog and low voltage dc modules away from ac I/O or high voltage dc modules.

A system may malfunction due to a change in the operating environment after a period of time. We recommend periodically checking system operation, particularly when new machinery or other noise sources are installed near the SLC 500 system. For further details on system installation and startup refer to:

- **Modular Hardware Style Installation & Operation Manual**
- **Fixed Hardware Style Installation & Operation Manual**
- **Safety Guidelines for the Application, Installation Maintenance of Solid State Control – A-B Publication SGI-1.1.**

Module Operation and System Considerations

After successfully installing your analog module, consider its operation within the SLC 500 system and in a specific application. This chapter describes:

Interface between the Module and Processor

- entering module ID codes
- addressing analog modules
- processor update of analog data
- monitoring the input and output data
- converting analog inputs
- converting analog outputs

System Considerations

- safe state for outputs
- retentive programming
- input out-of-range detection
- response to slot disable
- input channel filtering

Interface between the Module and the Processor

This section describes how to set up an analog module in a SLC 500 system.

Entering Module ID Codes

When configuring an analog module for an SLC 500 system using your programming software, a list of the different I/O modules, including the analog modules, is most likely provided for you. If a list is not provided, you need to enter the module identification code when configuring the slot. Refer to the table below for the appropriate analog module ID code.

Using the Hand-Held Terminal (HHT) firmware v1.1, enter the proper MODULE ID CODE under the "other" selection. Version 2.0 or later of the HHT firmware provides a list of I/O modules. Refer to the following publications for complete information:

- your programming software's user manual
- the Hand-Held Terminal User Manual

Table 4.A

Catalog No.	Module ID Code
1746-NI4	4401
1746-NIO4I	3201
1746-NIO4V	3202
1746-NO4I	5401
1746-NO4V	5402

Addressing Analog Modules

NI4 – Each input channel of the NI4 is addressed as a single word in the input image table. The NI4 uses a total of 4 words in the input image table. The converted values from channels 0 through 3 are addressed as input words 0 through 3 respectively for the slot where the module resides.

Example – If you want to address input channel 2 of the NI4 in slot 4, you would address it as input word 2 in slot 4 (I:4.2).

NIO4I and NIO4V – Each input channel of the NIO4I and NIO4V is addressed as a single word in the input image table and each output channel of the module is addressed as a single word in the output image table. Both the NIO4I and NIO4V use a total of 2 input words and 2 output words.

The converted input values from input channels 0 and 1 are addressed as words 0 and 1 of the slot where the module resides. The output values for the output channels 0 and 1 are addressed as output words 0 and 1 of the slot where the module resides.

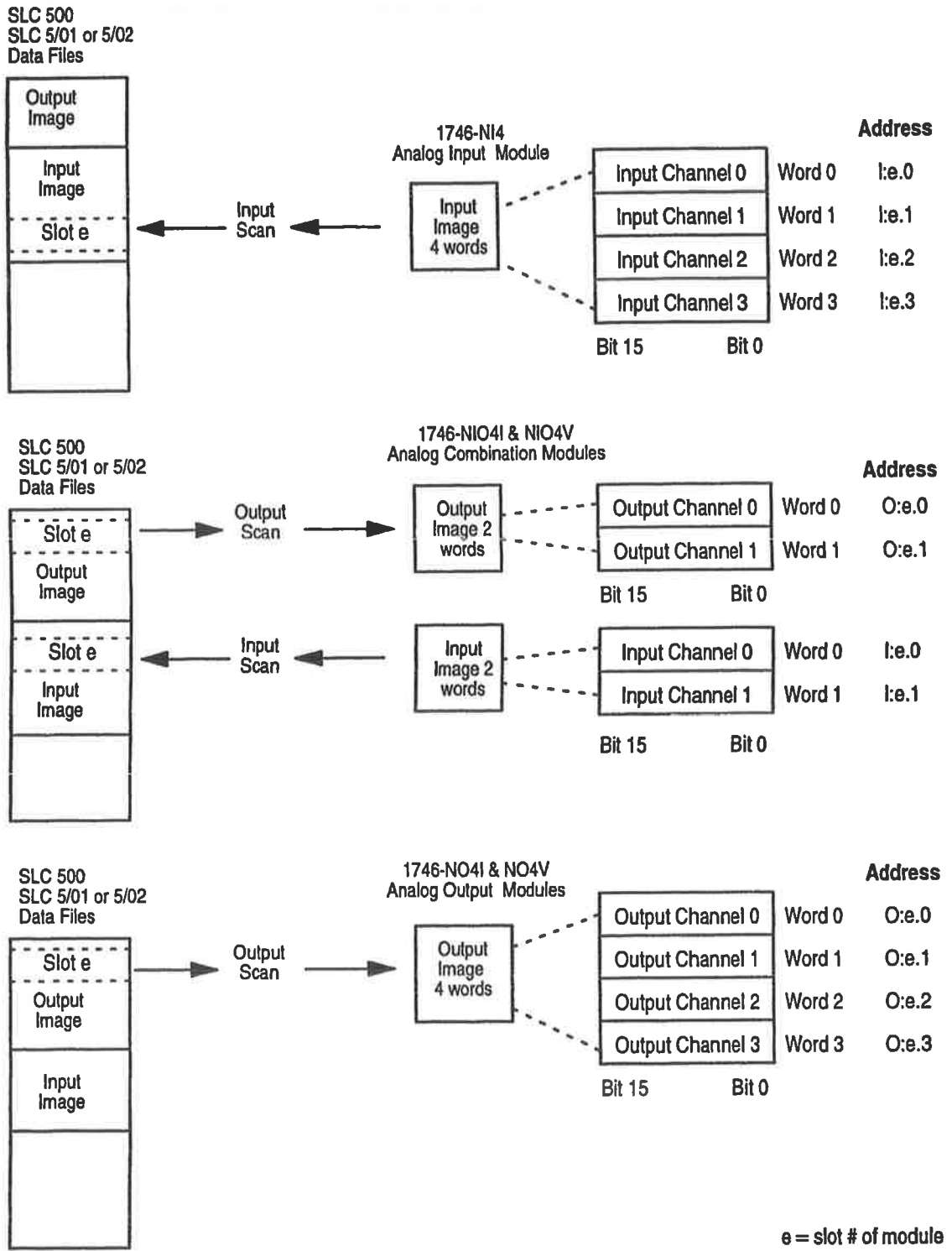
Example – If you want to address output channel 0 of the NIO4I in slot 3, you would address it as output word 0 in slot 3 (O:3.0).

NO4I and NO4V – Each output channel of the NO4I and NO4V is addressed as a single word in the output image table. Both modules use a total of 4 output words. The converted output values from output channels 0 through 3 are addressed as words 0 through 3 respectively for the slot where the module resides.

Example – If you want to address output channel 3 of the NO4I in slot 3, you would address it as output word 3 in slot 3 (O:3.3).

Figure 4.1 shows I/O addressing for the analog modules.

Figure 4.1
Addressing your Module



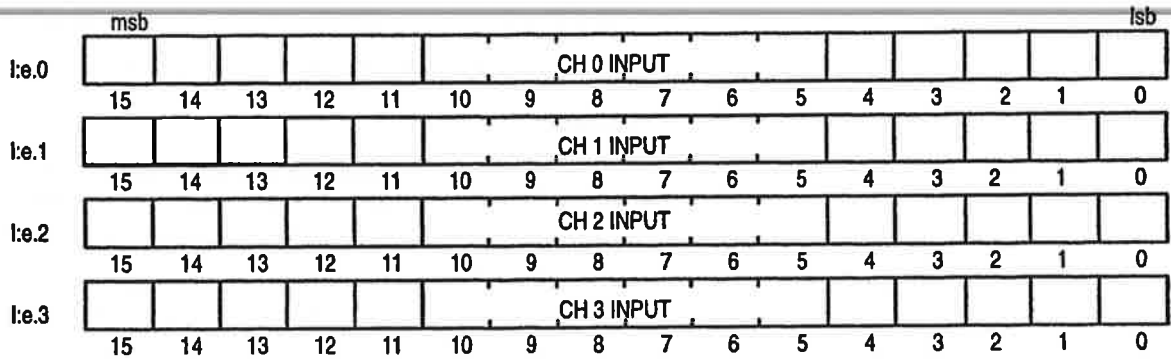
Bit Level Addressing

The following bit maps show bit level addressing for the analog inputs and outputs. The input channel converter resolution is 16 bits, or 1 word. The output channel converter resolution is 14 bits and is loaded from the most significant 14 bits of the associated output word.

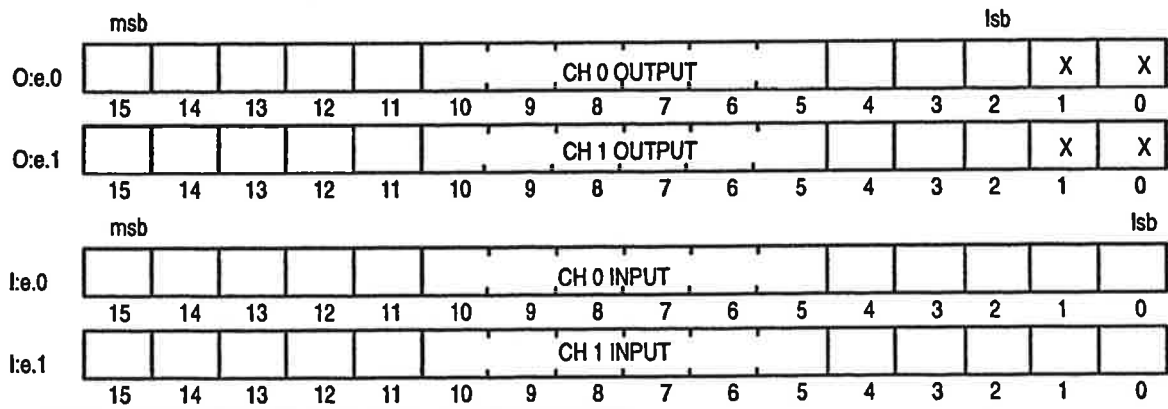
The two least significant bits (O:e.0/0 and O:e.0/1) of the output word have no effect on the actual output value.

Figure 4.2

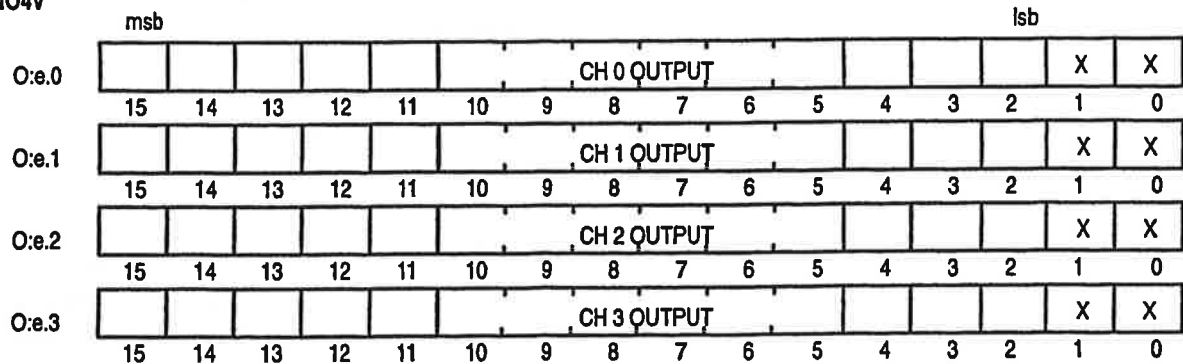
1746-NI4



1746-NIO4I & NIO4V



1746-NO4I & NO4V



e = slot # of module
x = bit not used

Processor Update of Analog Data

The analog input and output data is updated by the processor once during each scan of the user program. The table below shows typical analog update scan times and the number of input and output bits for the specified modules.

If an application requires processor updates of the analog data more frequently than once per scan, use an Immediate Input or an Immediate Output instruction. An Immediate Input or Output instruction typically updates 16 bits (or 1 analog channel) in 1 millisecond.

Refer to your programming software's user manual or Hand-Held Terminal User Manual for more information.

Table 4.B

Typical Time for Analog Data Updates to the Processor's Input and Output Image	
Once per processor scan (Automatic)	10 milliseconds for typical 1K program
Using immediate Input or Output Instruction	1 millisecond per analog channel

Table 4.C

Number of Input and Output Bits Representing Analog Data		
Description	Input Bits	Output Bits
NI4	64	—
NI4OI and NIO4V (2 input and 2 Output channels)	32	32
NO4I and NO4V	—	64

Monitoring the Input and Output Data

The analog input and output data can be monitored in several different radices using your programming software. Viewing the radix as decimal allows the analog input and output data to be viewed as decimal representations of integer words.

When monitoring in binary radix, data is viewed in two's complement representation for negative values. A description of two's complement data is available in Appendix B.

If you are using the Hand-Held Terminal (HHT) or the Data Table Access Module (DTAM) to monitor input and output data, the binary radix is the only available option. To view the analog input and output data in decimal radix, the data must be moved to an integer data file.

Converting Analog Input Data

Analog inputs convert current and voltage signals into 16 bit two's complement binary values.

The table below identifies the current and voltage input ranges for the input channels, the number of significant bits for the applications using input ranges less than full scale, and their resolution

Table 4.D

Voltage/Current Range	Decimal Representation	Number of Significant Bits	Resolution per LSB
-10V dc to +10V dc - 1LSB	-32,768 to +32,767	16 bits	305.176 μ V
0 to 10V dc - 1LSB	0 to 32,767	15 bits	
0 to 5V dc	0 to 16,384	14 bits	
1 to 5V dc	3,277 to 16,384	13.67 bits	
-20 mA to +20 mA	-16,384 to +16,384	15 bits	1.22070 μ A
0 to +20 mA	0 to 16,384	14 bits	
4 to +20 mA	3,277 to 16,384	13.67 bits	

To determine an approximate voltage that an input value represents, use one of the following equations:

$$\frac{10V}{32,768} \times \text{input value}^{\text{Ⓐ}} = \text{input voltage(V)}$$

[Ⓐ]The Input Value is the decimal value of the word in the input image for the corresponding analog input.

For example, if an input value of -16,021 is in the input image, the calculated input voltage is:

$$\frac{10V}{32,768} \times -16,201 = -4.889221(V)$$

It should be noted that this is the calculated value. The actual value may vary within the accuracy limitations of the module.

To determine an approximate current that an input value represents, you can use the following equation:

$$\frac{20 \text{ mA}}{16,384} \times \text{input value}^{\text{Ⓑ}} = \text{input current (mA)}$$

[Ⓑ]The Input Value is the decimal value of the word in the input image for the corresponding analog input.

For example, if an input value of 4096 is in the input image, the calculated input current is:

$$\frac{20 \text{ mA}}{16,384} \times 4096 = 5(\text{mA})$$

It should be noted that this is the calculated value. The actual value may vary within the accuracy limitations of the module.

Converting Analog Output Data

Analog outputs convert a 16 bit two's complement binary value into an analog output signal. Because the analog output channels have a 14 bit converter, the 14 most significant bits of this 16 bit number are the bits that the output channel converts.

The NIO4I and NO4I support two and four current outputs respectively, ranging from 0 mA to a maximum of 21 mA. The NIO4V and NO4V support two and four voltage outputs respectively, ranging from -10 to +10 Volts dc.

The following tables identify the current and voltage output ranges for the output channels, the number of significant bits for the applications using output ranges less than full scale, and their resolution.

Table 4.E Analog Output Conversion NIO4I and NO4I

Current Range	Decimal Representation for Output Word	Number of Significant Bits	Resolution per LSB
0 to 21 mA - 1LSB	0 to +32,764	13 bits	2.56348 μ A
0 to +20 mA	0 to +31,208	12.92 bits	
4 to +20 mA	6,242 to +31,208	12.6 bits	

Table 4.F Analog Output Conversion NIO4V and NO4V

Voltage Range	Decimal Representation for Output Word	Number of Significant Bits	Resolution per LSB
-10 to +10V dc - 1LSB	-32,768 to +32,764	14 bits	1.22070 mV
0 to +10V dc - 1LSB	0 to +32,764	13 bits	
0 to 5V dc	0 to +16,384	12 bits	
1 to 5V dc	+3,277 to +16,384	11.67 bits	

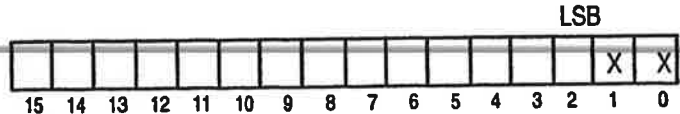
Use the following equation to determine the decimal value for the current output:

$$\frac{32,768}{21 \text{ mA}} \times \text{Desired Current Output (mA)} = \text{Output Decimal Value}$$

For example, if an output value of 4 mA is desired, the value to be put in the corresponding word in the output image can be calculated as follows:

$$\frac{32,768}{21 \text{ mA}} \times 4 \text{ mA} = 6242$$

Note: The actual resolution for analog current outputs is 2.56348 μA per LSB, where the LSB position in the output word is indicated as:



X = Bit Not Used

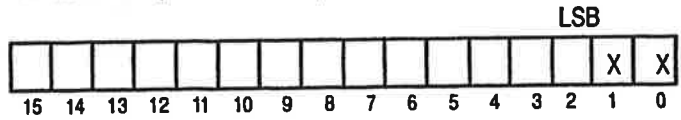
Use the following equation to determine the decimal value for the voltage output:

$$\frac{32,768}{10 \text{ V dc}} \times \text{Desired Voltage Output (V dc)} = \text{Output Decimal Value}$$

For example, if an output value of 1V dc is desired, the value to be put in the corresponding word in the output image can be calculated as follows:

$$\frac{32,768}{10 \text{ V dc}} \times 1 \text{ V dc} = 3277$$

Note: The actual resolution for analog voltage outputs is 1.22070 mV per LSB, where the LSB position in the output word is indicated as:



X = Bit Not Used

System Considerations

This section describes the system considerations for an analog module. These include:

- safe state for outputs
- retentive programming
- input out-of-range detection
- response to slot disable
- input channel filtering

Safe State for Outputs

Whenever an SLC 500 system is NOT in the RUN mode, the outputs on the analog module are automatically forced to 0 Volts or 0 milliamps by the SLC 500 system. This occurs when the processor is in the:

- FAULT mode
- PROGRAM mode
- TEST mode



ATTENTION: When designing and installing the SLC 500 system, devices connected to the analog module output channels must be placed into a safe state whenever the analog output is 0 volts or 0 milliamps (\pm the offset error).

Retentive Programming Option

This section describes the affects of a processor mode change on analog outputs. The following information applies to the 1746-NIO4I, NIO4V, NO4I and NO4V analog modules.

This programming option allows you to retain analog data in the Input and Output Image tables when the SLC 500 processor:

- transitions from RUN-PROGRAM-RUN mode OR
- when power is turned OFF and reapplied

In both cases, when power is reapplied, the data is transferred to the module whether the programming rung is true or false.

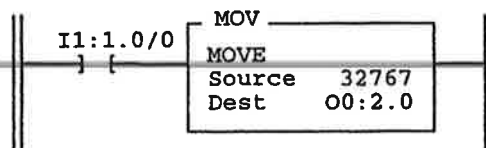
If an SLC 500 system detects a fault condition, the analog outputs reset to zero. The data in the Output Image table is retained during the fault. Once the fault condition is corrected and the major fault bit in the processor is cleared, the retained data is sent to the analog output channels.

If you choose not to use the retentive programming option, retained data is not sent to the output channels.

The following section provides example program options for retentive data and non-retentive data.

Retentive Analog Output Example

If a modular system is configured with the CPU in slot 0, a discrete I/O module in slot 1, and an analog output module in slot 2 the following ladder logic rung can be programmed.

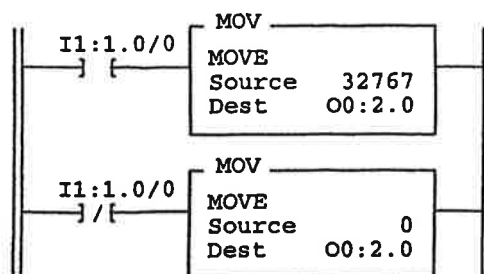


When bit 0 of the discrete I/O module turns ON, the rung is true and the value 32767 is moved into the Output Image table location that corresponds with analog output channel 0 in slot 2. At the end of the scan, this value is transferred to the module where it is converted to the appropriate voltage or current (depending on the type of module used).

If on the next program scan the rung becomes false, the MOVE of the value of 32767 to the Output Image table does not occur. Unless another rung is added to transfer data to the Output Image based on this rung being false, the previous data is retained. That is, the value 32767 remains in the Output Image table and is transferred to the analog module at the end of subsequent program scans until changed by the user program.

Non-Retentive Analog Output Example

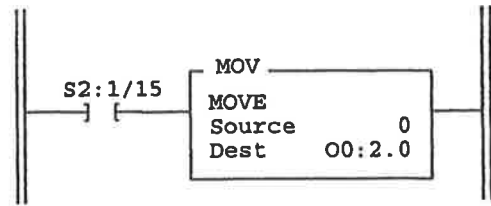
The following example shows a non-retentive program during a program execution and for a mode change or power cycle.



In the above example, as long as discrete input 0 is ON, the value 32767 is transferred to analog output channel 0. If discrete input 0 turns OFF, the value 0 is transferred to analog output channel 0.

During a Mode Change or Power Cycle

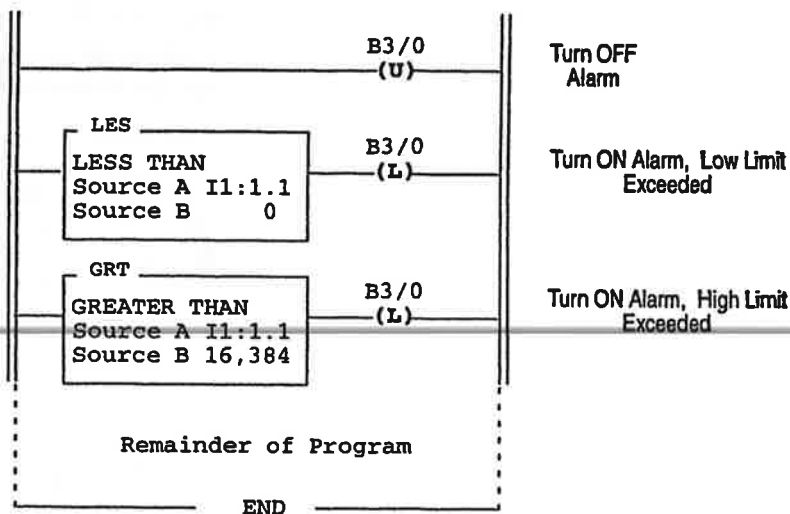
The first pass bit in the Status File is used to initialize the analog output following a power up in the RUN mode or entry into the RUN or TEST mode. The address of the First Pass bit is S2:1/15. When this bit is ON, the first pass of the program scan is taking place. Therefore, the following ladder rung can be programmed to always clear the analog output channel during the first program scan.



Input Out-of-Range Detection

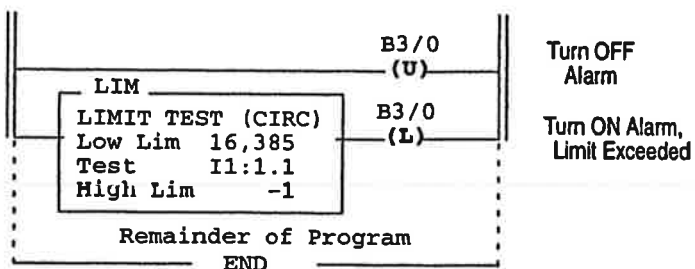
Analog modules do not provide an input out-of-range signal to the processor. However, if this feature is critical to a specific application, you can program the processor to provide this function.

The following program applies to all SLC 500 processors. The program shows two compare instructions that check for analog input values which exceed low and high limits respectively. For this example, the analog input value is in word 1 of slot 1 (I1:1.1). Whenever the input value exceeds a limit, this program latches a binary variable in memory that could serve as an alarm indication at some other point in the program.



The second program is for SLC 5/02 processors. This program uses the Limit Test instruction that checks both low and high limits in a single instruction. This instruction assumes that the analog input value is in word 1 of slot 1 (I1:1.1).

As in the above program, whenever the input value exceeds a limit, this program latches a binary variable in memory which could serve as an alarm indication at some other point in the program.



Response to Slot Disable

You have the ability to disable any slot in the chassis using the processor. Before disabling any slot containing an analog module, it is important to consider how the analog module will respond when the slot is disabled.



ATTENTION: Make sure that the implications of disabling an analog module slot are clearly understood before utilizing this feature.

The response to slot disable for inputs and outputs is the same for all the analog modules.

Input Response to Slot Disable

The module continues to update the input values to the processor. However, the processor does not read inputs from a module that is disabled. Therefore, when the processor disables the analog module slot, the module inputs appearing in the processor image table remain in their last state. When the processor re-enables the analog module slot, the current state of the module inputs are received by the processor during the subsequent scan.

Output Response to Slot Disable

The processor may change the analog module output data as it appears in the processor image table. However, this data is not transferred to the analog module.

Instead, the analog module holds its outputs in their last state. When the slot is re-enabled, the data that appears in the processor image table is transferred to the analog module on the subsequent scan.

Input Channel Filtering

The input channels for all of the analog modules incorporate extensive on board signal conditioning. The purpose of this conditioning is to reject the high frequency noise that can couple into an analog input signal while passing the normal variations of the input signal. The conditioning is performed by passing the input signal through a 6 pole Gaussian digital filter.

The sharp cut-off of this filter is demonstrated in the frequency response plot, Figure 4.3. Frequency components of the input signal at or below the filter corner frequency of 10 Hz are passed with under 3 dB of attenuation. This pass band allows the normal variation of sensor inputs such as temperature, pressure and flow transducers to be input data to the processor.

Noise signals coupled in at frequencies above the 10 Hz pass band is sharply rejected. An area of particular concern is the 50/60 Hz region, where pick up from power lines can occur. From the frequency response diagram, you see that a 60 Hz signal on the plus (+) input with respect to the minus (-) input is attenuated by over 55 dB (60 Hz normal mode rejection).

If power line noise is coupling into the input signal through the input cable, the proper use of differential inputs reduces the effect of noise. With differential inputs, noise couples into both the plus (+) and minus (-) inputs where it is attenuated by over 105 dB (60 Hz common mode rejection).

The affect of the filter with respect to time can be seen by examining the step response of the input channel. Figure 4.4 shows the response of the input value versus time when a step change is made in the voltage or current at the input terminal. The response of the filter demonstrates no overshoot and rapid settling time. The input value settles to within 95% of the final value in 60 milliseconds, independent of the input magnitude.

Example – If the input instantaneously changes from 0 to 10 volts, the value converted by the analog module after 60 milliseconds is 9.5 volts. Within this time the analog module updates the input data value in memory with an intermediate response every 512 microseconds.

Figure 4.3
Input Channel Frequency Response

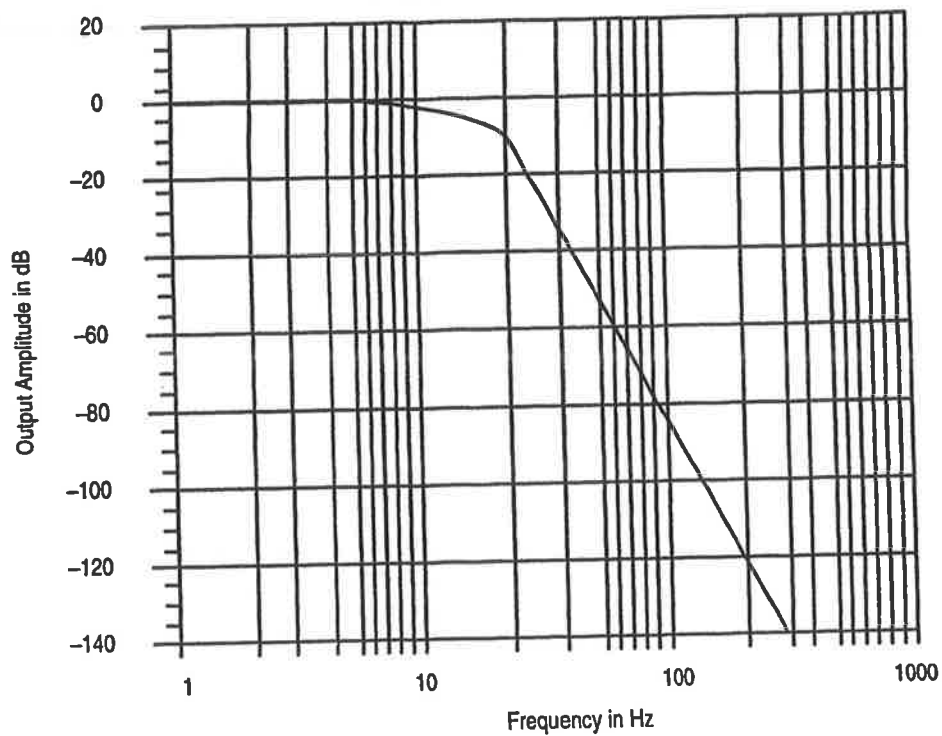
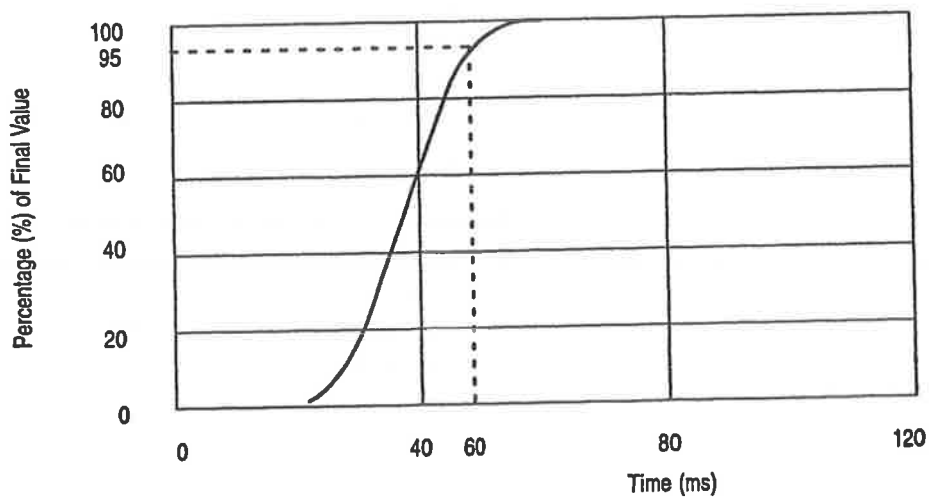


Figure 4.4
Input Channel Step Response



Testing Your Module

The purpose of this chapter is to help you isolate problems in a systematic and controlled manner before beginning normal system operation.

Testing the SLC 500 System

If your analog module is installed in the expansion chassis of a fixed system, test your system using the procedures described in the Fixed Hardware Style Installation & Operation Manual before executing the analog module start up procedures.

If your analog module is installed in a modular system, test the modular system using the procedures described in the Modular Hardware Style Installation & Operation Manual before executing the analog module start up procedures.

Start-up Procedures

Once you have tested your SLC 500 system, follow the steps below in sequence to test your analog module:

1. Inspect the analog module.
2. Disconnect prime movers.
3. Power up the SLC 500 system.
4. Test the analog inputs.
5. Test the analog outputs.
6. Start up the system.

Inspect the Analog Module

Problems can be prevented by inspecting the analog module before installing it in the SLC 500 system. Inspection should include the following steps:

1. Make sure that all voltage/current mode selection DIP switches are set properly (inputs only).
2. Make sure that all analog module wiring connections are correct and that there are no missing or broken wires. Check the tightness of all terminals to make certain wires are secure.



ATTENTION: Care should be taken to avoid connecting a voltage source to a channel configured for a current input. Improper module operation or damage to the module can occur.

3. Make sure that the shield for the cable used to wire the analog module is properly grounded. Refer to chapter 3 for additional information.



ATTENTION: Do not connect the Belden #8761 foil shield and drain wire to the analog module terminal block. The foil shield and drain wire must be connected to earth ground, which is not available on the analog module terminal block.

4. Make certain that the removable terminal block on the analog module is secured on the module.

Disconnect Prime Movers (Motion Devices)

During the following test procedures the processor is energized. As a safety precaution, make sure that machine motion does not occur. To achieve this:

Disconnect the motor wires at the motor starter or the motor itself. This allows you to test the operation of the starter coil, verifying that your output circuit is wired correctly and functioning.

To disconnect a solenoid, disengage the valve, leaving the coil connected.

In some instances, you may not be able to disconnect a device the preferred way. In these cases, open the output circuit at a point as close as possible to the motion-causing device. For example, your output might be a relay coil which in turn energizes a motor starter. If you cannot disconnect the motor wires, open the circuit at a point between the motor starter and the relay contact.



ATTENTION: Machine motion during system checkout can be hazardous to personnel. During all checkout procedures, you must disconnect all devices which, when energized, might cause machine motion.

Power Up the SLC 500 System

Apply power to the fixed or modular system. The analog module LED (red) should be illuminated, indicating that the module is receiving 24V dc power.

While an illuminated analog module LED does not ensure that the module is operating properly, a non-illuminated LED indicates that the analog module is not functional. Do not continue with the test procedures until the LED is illuminated.

The four most probable causes of a non-illuminated LED are:

- The SLC 500 system is not receiving power from its power supply. Check the POWER LED on the fixed system unit or the power supply on the modular system. If the LED is not illuminated, refer to the Fixed Hardware Style Installation & Operation Manual or the Modular Hardware Style Installation & Operation Manual. If the module is a 1746-NO4I or NO4V, check the state of the optional 24V dc power switch. If external power is selected, but not connected to the front of the module, the power LED will not illuminate.
- The power from the supply is not being received by the remainder of the SLC 500 system. You can test this by attempting to go online with the programming device.
- The slot in the chassis where the analog module is located is not operational. Remove the power from the SLC 500 system, move the analog module to another slot and restore power. If it appears that the slot is defective, replace the chassis.
- The analog module is defective.

Testing Analog Inputs

Before testing the analog module input channels, the SLC 500 system must be installed and tested according to the SLC 500 Fixed or Modular Style Installation & Operation Manual. The processor must be connected to a programming device, properly configured, and must have no rungs in its ladder program. The analog module LED must also be illuminated.



ATTENTION: The procedure described in this section for testing analog module input channels assumes that all I/O module outputs that normally activate prime movers or other potentially dangerous devices have been disconnected from these devices.

Do not attempt to test the analog module input channels unless prime movers and/or other potentially dangerous devices are disconnected from the I/O modules.

The devices connected to the analog module input channels are referred to as "sensors." If the sensors can be manually varied over their normal operating range, use these devices to test the analog module input channels.

If the sensors cannot be manually varied, a voltage source or current source is necessary to test the input channels. In this case, disconnect the analog module input channels at the sensor to test the terminal block wiring. The following steps apply to either test procedure.

Important: The following procedure does not ensure that the input mode DIP switch is properly configured. Visually inspect the input mode DIP switch before installing the analog module in the chassis.



ATTENTION: Care should be taken to avoid connecting a voltage source to a channel configured for a current input. Improper module operation or damage to the module can occur.

To test the analog inputs follow these steps:

1. Determine the boundary conditions for the analog module input channel. For example, if the input channel is connected to a sensor that has an output range of 1 mA to 5 mA, the boundary conditions would be 1 mA (lower) and 5 mA (upper).
2. Using the formulas from page 4-7, calculate the input decimal values that should appear in the processor image table when the boundary conditions are present on the analog module input channel.

For example, if 1 mA and 5 mA are boundary conditions, the decimal values would be 819 and 4096.

3. Assuming that the programming device is on-line with the processor, select the test mode and continuous scan mode function.
4. Display the data in File 1 (Input Image Table).
5. Change the radix of the display to decimal.
6. If the input channel of the module has been disconnected from its sensor, attach a voltage source (voltage input) or current source (current input) to the input and set the source to the *lower boundary* condition.

If the input channel is connected to its sensor, set the sensor to its lower boundary condition.

7. Locate the input channel image data in the image table. The input image word for the input channel being tested should read approximately the lower boundary calculated in step 2.

The exact value of the image word is affected by the accuracy of the analog module and the input sensor. Ensure that the deviation from the boundary value is within tolerances for the analog application.

8. If the input channel has been disconnected from its sensor, attach the voltage source (voltage input) or current source (current input) to the input and set the source to the *upper boundary* condition.

If the input channel is connected to its sensor, set the sensor to its upper boundary condition.

9. Repeat step 7 for the upper boundary condition.
10. Repeat steps 1 through 8 for the remaining analog inputs.

11. If any of the analog input channels do not pass the start-up procedure, check for the following potential causes:

- The processor is not in the TEST/CONTINUOUS scan mode.
- The terminal block is not secured on the analog module.
- The analog module terminal block is not wired properly or wires are broken. See chapter 3 for details on wiring the analog module.
- The analog module input channel sensor (or test voltage or current source) is not operating properly.

If a current source is not available to test a current input channel, a test voltage can be applied to the current input channel to achieve the input boundary conditions. In normal operation, a voltage source should not be connected to an analog input channel in the current mode. To determine the boundary conditions use the following equation:

$$\text{Voltage Input (V)} = \text{Current Input (mA)} \times 0.25$$

Example – If the current input boundary conditions are 1 mA and 5 mA, the boundary conditions in volts would be 0.25 volts and 1.25 volts. If this calculation is done correctly, the test voltage should never exceed 5 volts.

Testing Analog Outputs

Before testing the analog module output channels, the SLC 500 system must be installed and tested according to the SLC 500 Fixed or Modular Style Installation & Operation Manual. The processor must be connected to a programming device, properly configured, and must have no rungs in its ladder program. The analog module LED must be illuminated.



ATTENTION: The procedure described in this section for testing analog module output channels assumes that all I/O module outputs that normally activate prime movers or other potentially dangerous devices have been disconnected from these devices.

Do not attempt to test the analog module output channels unless prime movers and/or other potentially dangerous devices are disconnected from the I/O modules.

The devices connected directly to the analog module outputs are referred to as “actuators.” If the actuators do not affect prime movers or initiate any other potentially dangerous operation, use these devices to test the outputs.

If the actuators affect prime movers or initiate a potentially dangerous operation, use a voltmeter to test the voltage outputs and an ammeter to test the current outputs. Note that these meters have some inherent error of their own.

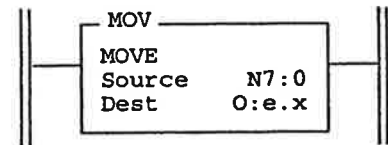
In the latter case, disconnect actuators at the analog module outputs to test the terminal blocks.

The following procedure applies to either of the previous situations.

1. Determine the boundary conditions for the analog module output channel. For example, if the output channel is connected to an actuator that has an input range of 1 volt to 5 volts, the boundary conditions are 1 volt (lower) and 5 volts (upper).
2. Using the formulas from page 4-9, calculate the output decimal values that must be entered into the processor image table to produce the analog module output channel boundary conditions determined in step 1.

For example, if 1 volt and 5 volts are boundary conditions, the decimal values would be 3277 and 16384.

3. Create and save the test rung shown below.



"e" is the slot number of the analog module

"x" is the number of the analog module output channel being tested

4. Download the program to the processor and enter the RUN mode.
5. Display the data in address N7:0.
6. Enter lower boundary condition value in N7:0. For example, if the lower boundary condition is 1 volt, enter 3277 into N7:0.
7. If the output channel has not been disconnected from its actuator, the actuator should assume its lower boundary condition.

If the output channel has been disconnected from its actuator, connect either the ammeter (current output) or voltmeter (voltage output) to the analog module output channel. The exact value of the meter reading is affected by the accuracy of the analog module and the meter. Ensure that the deviation from the lower boundary condition is within tolerances for the application in which the analog module is used.

For example, if 1 volt was the lower boundary condition, the voltmeter should read approximately 1 volt.

8. Enter upper boundary condition value in N7:0. For example, if the upper boundary condition is 5 volts, enter 16384 into N7:0.
9. Repeat step 7 for the upper boundary condition.
10. Repeat steps 1 through 9 for each output channel.
11. If any of the output channels do not pass the start-up procedure, check for the following potential causes:
 - The processor is not in the RUN mode.
 - The terminal block is not secured in the analog module.
 - The analog module terminal block is not wired properly or wires are broken. See chapter 3 for details on wiring the analog module.
 - The actuator or test ammeter/voltmeter is not operating properly.

Programming Examples

This chapter shows several programming examples that provide additional capabilities such as:

- Addressing, Out-of-Range Detection, and Scaling of Analog Inputs
- Addressing and Scaling of Analog Outputs
- Scaling Offsets when $> 32,767$ or $< -32,768$
- Scaling and Range Checking of Analog Inputs and Outputs

Important: The programming examples in this chapter are for informational purposes only. Because of the many variables and requirements associated with any application, the Allen-Bradley Company cannot assume responsibility or liability for actual use based on these examples.

Addressing, Out-of-Range Detection, and Scaling of Analog Inputs

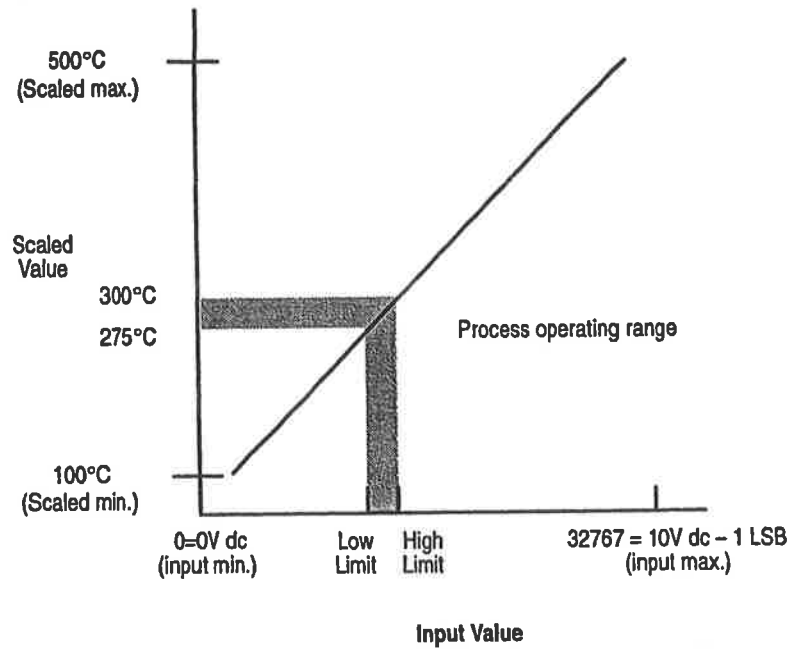
The following example uses an NI4 analog input module to show input addressing, range checking and scaling of analog inputs into engineering units.

We are making the following assumptions:

- The NI4 is located in slot 3 of a modular system.
- A temperature transducer with a 0 to 10V dc output is wired to the second input channel on the analog module.
- The transducer voltage signal is proportional to a range of 100° C to 500° C (212° F to 932° F).
- The process temperature must stay between 275° and 300° C (527° F to 572° F). If the temperature deviates from this range, a flag is set and this out-of-range value is not processed. The data is presented in degrees C for monitoring and display purposes.

The scaling operation is displayed in the following graph. It displays the linear relationship between the input and the resulting scaled values.

Figure 6.1



Calculating the Linear Relationship

Use the following equations to express the linear relationship between the input value and the resulting scaled value.

Scaled value = (input value x slope) + offset

$$\text{Slope} = (\text{scaled max.} - \text{scaled min.}) / (\text{input max.} - \text{input min.})$$

$$(500 - 100) / (32,767 - 0) = 400/32,767$$

$$\text{Offset} = \text{scaled min.} - (\text{input min.} \times \text{slope})$$

$$100 - (0 \times (400/32,767)) = 100$$

$$\text{Scaled value} = (\text{input value} \times (400 / 32767)) + 100$$

Calculating the Out-of-Range Flag Using the Scale Instruction

Use the following equation to calculate the low and high limit input values which determine the out-of-range flag.

$$\text{Input value} = (\text{scaled value} - \text{offset}) / \text{slope}$$

$$\text{low limit} \quad (275 - 100) / (400/32,767) = 14,344$$

$$\text{high limit} \quad (300 - 100) / (400/32,767) = 16,393$$

Once you have calculated the linear relationship and the out-of-range flag value, this example allows you to:

- Turn on a heater or fan to maintain the process temperature between 275° and 300° C by using the out-of-range flags.
- Monitor the process temperature using a Data Table Access Module (DTAM) or Hand-Held Terminal (HHT).
- *Output* the process temperature for operation interface purposes by:
 - MOVing the scaled value to an output module as variable data to a Dataliner
 - Converting the scaled value to BCD (using TOD instruction) and MOVing it to an LED display

The following ladder diagrams show how to program the processor. The first example uses standard math instructions available in any SLC 500 processor. The ladder diagram prevents a processor fault by unlatching the mathematical overflow bit S2:5/0 before the end of the scan.

The second example uses the scaling instruction (SCL)^① available in the 5/02 and higher processors. The rate parameter is calculated by multiplying the slope by 10,000.

$$\text{rate} = (400/32767) \times 10,000 = 122$$

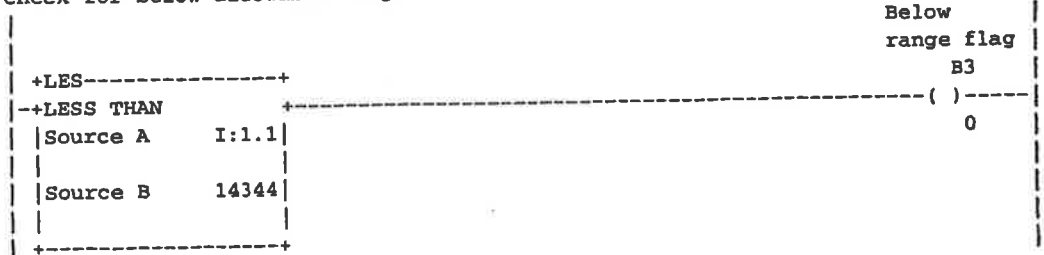
The third example uses the SCP (scale with parameters) instruction available in the SLC 5/03 (OS302 or later) and SLC 5/04 (OS401 or later) only.

① If the result of the Source times the Rate, divided by 10000 is greater than 32767, the SCL instruction overflows, causing error 0020 (Minor Error Bit), and places 32767 in the Destination. This occurs regardless of the current offset. For an alternate method, see page 6-14.

Using Standard Math

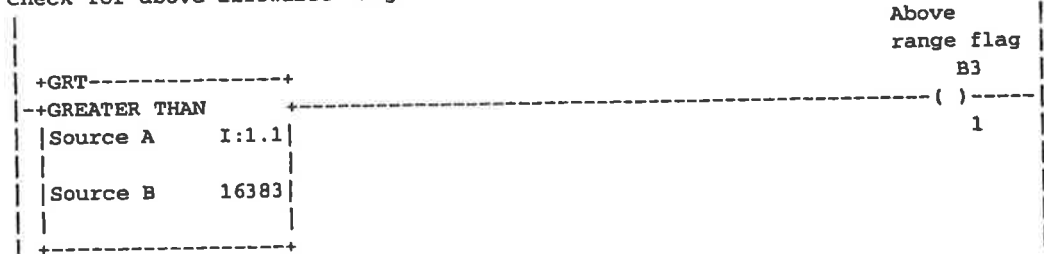
Rung 2:0

Check for below allowable range



Rung 2:1

Check for above allowable range



Rung 2:2

Turn on the below range alarm output when analog input is below acceptable range



Rung 2:3

Turn on the above range alarm output when analog input is above acceptable range



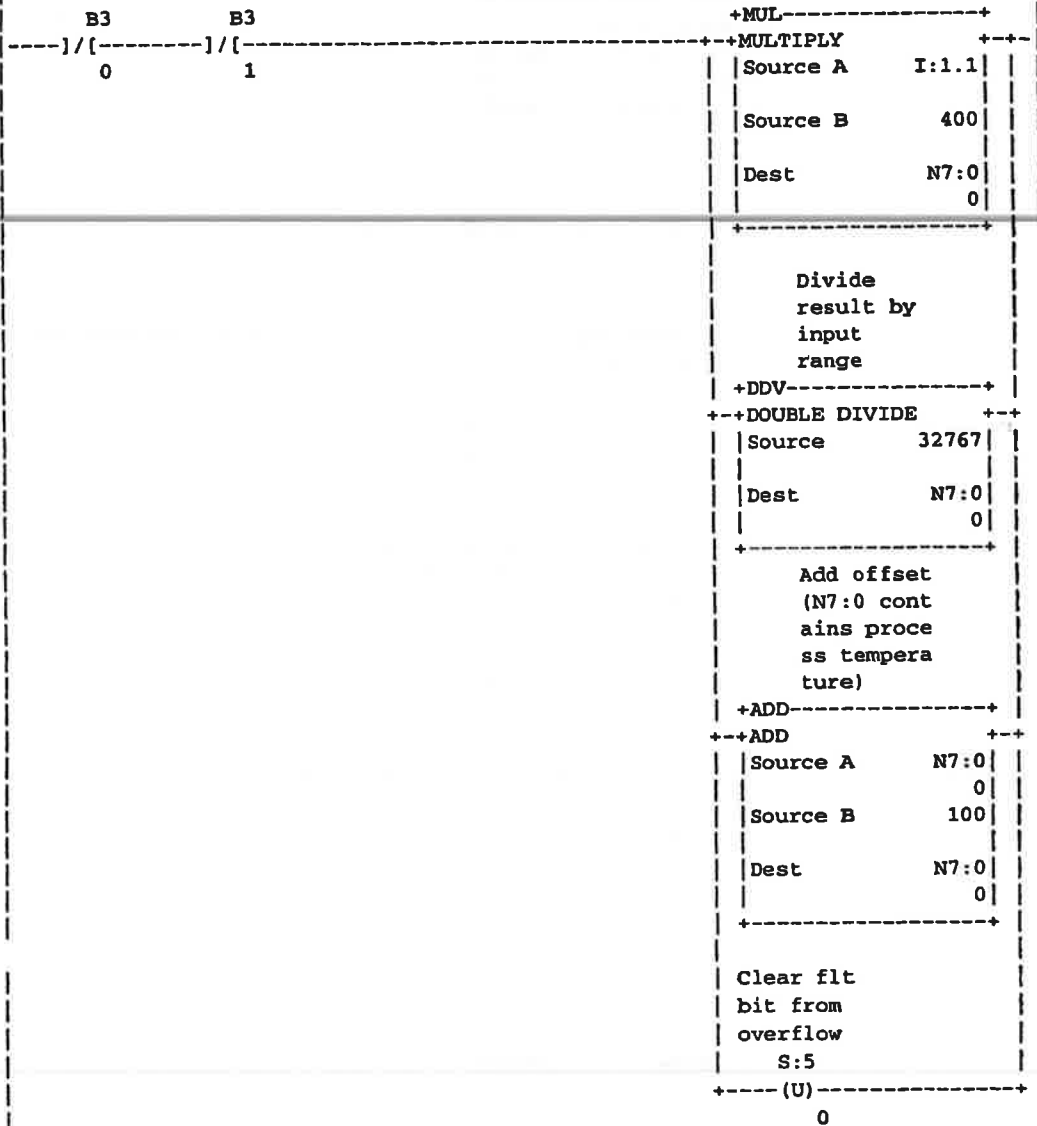
Ladder logic continued on the next page.

Rung 2:4

Scale the analog input value and process the result only when it is within the acceptable range

Below Above
range flag|range flag

Multiply
by the
scaled range



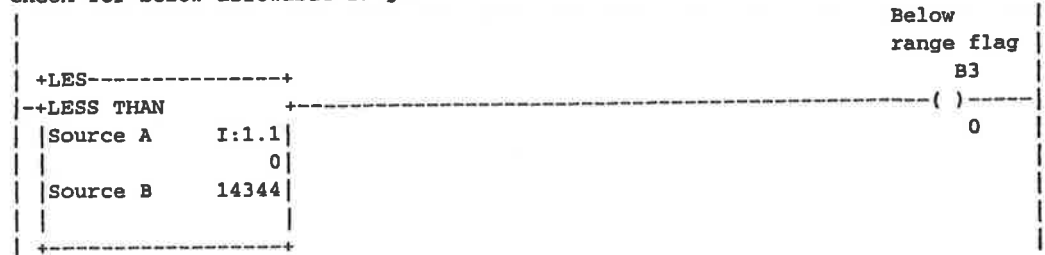
Rung 2:5

+END+

Using the Scale (SCL) Instruction

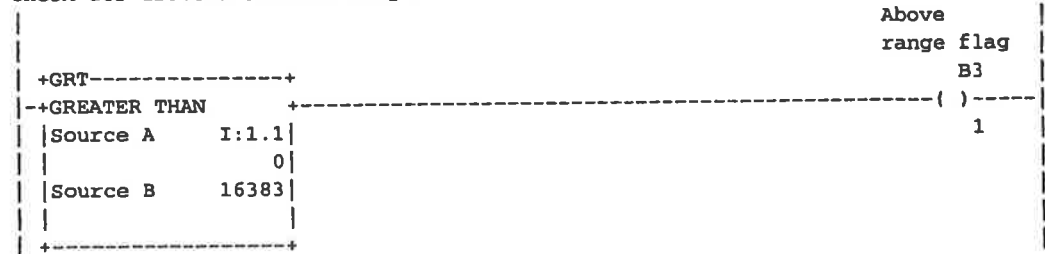
Rung 2:0

Check for below allowable range.



Rung 2:1

Check for above allowable range.



Rung 2:2

Turn on the below range alarm output when the analog input is below the acceptable range.



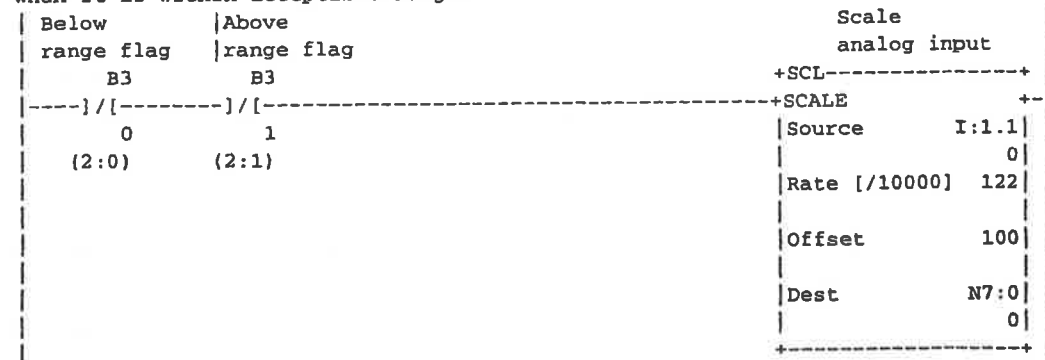
Rung 2:3

Turn on the above range alarm output when the analog input is above the acceptable range.

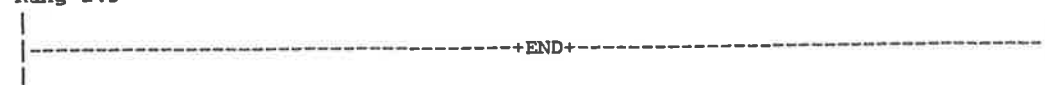


Rung 2:4

Scale analog input value and process the result only when it is within acceptable range.



Rung 2:5



Using Scale with Parameters (SCP) Instruction

Rung 2:0

Check for below allowable range.

		Below range flag B3
+LES-----+		()-----
-+LESS THAN		0
Source A	I:1.1	
	0	
Source B	14344	
+-----+		

Rung 2:1

Check for above allowable range.

		Above range flag B3
+GRT-----+		()-----
-+GREATER THAN		1
Source A	I:1.1	
	0	
Source B	16383	
+-----+		

Rung 2:2

Turn on the below range alarm output when the analog input is below the acceptable range.

		Below range alarm O:2
Below range flag B3		()-----
-----]	[-----	0
	0	

Rung 2:3

Turn on the above range alarm output when the analog input is above the acceptable range.

		Above range alarm O:2
Above range flag B3		()-----
-----]	[-----	1
	1	

Rung 2:4

Below range flag B3	Above range flag B3	Scale analog input
+-----]		+SCP-----+
-----]/ [-----]		+SCALE W/PARAMETERS+-----
	0	Input
	1	I:1.1
		0
		Input Min.
		0
		Input Max.
		32767
		Scaled Min.
		100
		Scaled Max.
		500
		Scaled Output N7:0
		0
+-----]		

Rung 2:5

+-----]		+END+
---------	--	-------

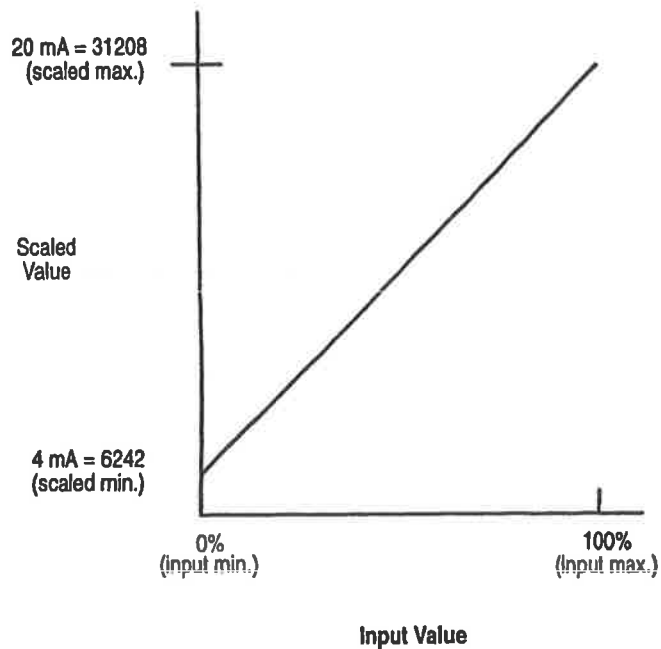
Addressing and Scaling Outputs

We are making the following assumptions:

- The NIO4I is located in slot 2 of a SLC 500 system.
- An actuator from a flow control valve is wired to output channel 0.
- The actuator accepts a 4 mA to 20 mA signal proportional to 0 to 100% of the valve's opening. For this example the signal actuator can not receive a signal out of the 4 mA to 20 mA range.
- The percentage of valve opening is manually input to the SLC.

The following graph displays the linear relationship.

Figure 6.2



Calculating the Linear Relationship

Use the following equations to calculate the scaled output value:

$$\text{Scaled value} = (\text{input value} \times \text{slope}) + \text{offset}$$

$$\text{Slope} = (\text{scaled max.} - \text{scaled min.}) / (\text{input max.} - \text{input min.})$$

$$(31,208 - 6,242) / (100 - 0) = 24,966/100$$

$$\text{Offset} = \text{scaled min.} - (\text{input min.} \times \text{slope})$$

$$6,242 - (0 \times (24,966/100)) = 6,242$$

$$\text{Scaled value} = (\text{input value} \times (24,966/100)) + 6,242$$

The out-of-range limits are predetermined because any value less than 0% is 6,242 and any value greater than 100% is 31,208. The ladder logic checks for the out-of-range flag to verify that not less than 4 mA and not more than 20 mA is provided out of the analog output channel.

The percentage of valve opening may be *input* to the processor by:

- entering the data through a DTAM or HHT
- MOVing the data from thumbwheels or a keypad (possibly converting the data from BCD using FRD instruction)

The percentage of valve opening may be *output* for operator interface by:

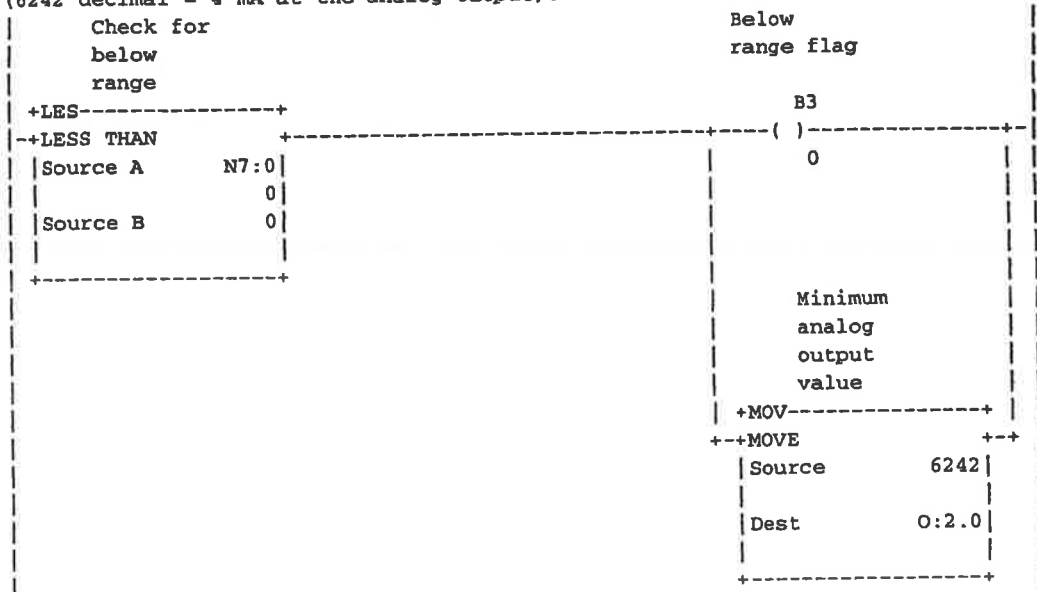
- monitoring the data using a DTAM or HHT
- MOVing the data to an output module as variable data to a Dataliner
- converting the data to BCD (using TOD instruction) and MOVing it to an LED display

Since the slope is greater than 3.2767 only standard math can be used for the ladder diagram with SLC 500 fixed, SLC 5/01, 5/02, 5/03 (OS300 or OS301), and 5/04 (OS400) processors. The ladder diagram prevents a processor fault by unlatching the mathematical overflow bit S2:5/0 before the end of the scan. Refer to the example ladder diagram on the next page. Following the standard math example is a ladder diagram using the SCP instruction, available only in the SLC 5/03 (OS302 or later) and the SLC 5/04 (OS401 or later).

Using Standard Math

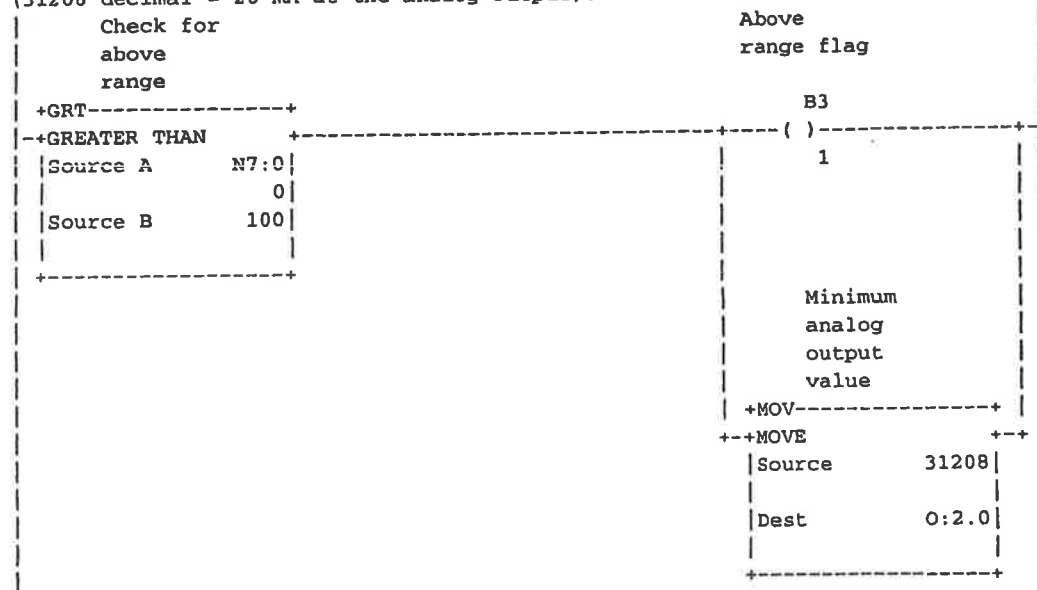
Rung 2:0

N7:0 contains percentage of valve open. If this value is less than 0, move the minimum value to the analog output (6242 decimal = 4 mA at the analog output).



Rung 2:1

N7:0 contains percentage of valve open. If this value is greater than 100, move the maximum value to the analog output (31208 decimal = 20 mA at the analog output).



Ladder logic continued on the next page.

Rung 2:2

Scale values in the 0 to 100% range to the decimal range for the 4-20 mA analog output.

Below range flag	Above range flag		Multiply by scaled range
B3	B3		+MUL-----+
)/[-----]/[-----]			+MULTIPLY
0	1		Source A N7:0
			0
			Source B 24966
			Dest N7:1
			0
			+-----+
			Divide by input range
			+DDV-----+
			+DOUBLE DIVIDE
			Source 100
			Dest N7:1
			0
			+-----+
			Add offset
			+ADD-----+
			+ADD
			Source A N7:1
			0
			Source B 6242
			Dest 0:2.0
			+-----+
			Clear math overflow bit
			S:5
			+-----+
			(U)
			0

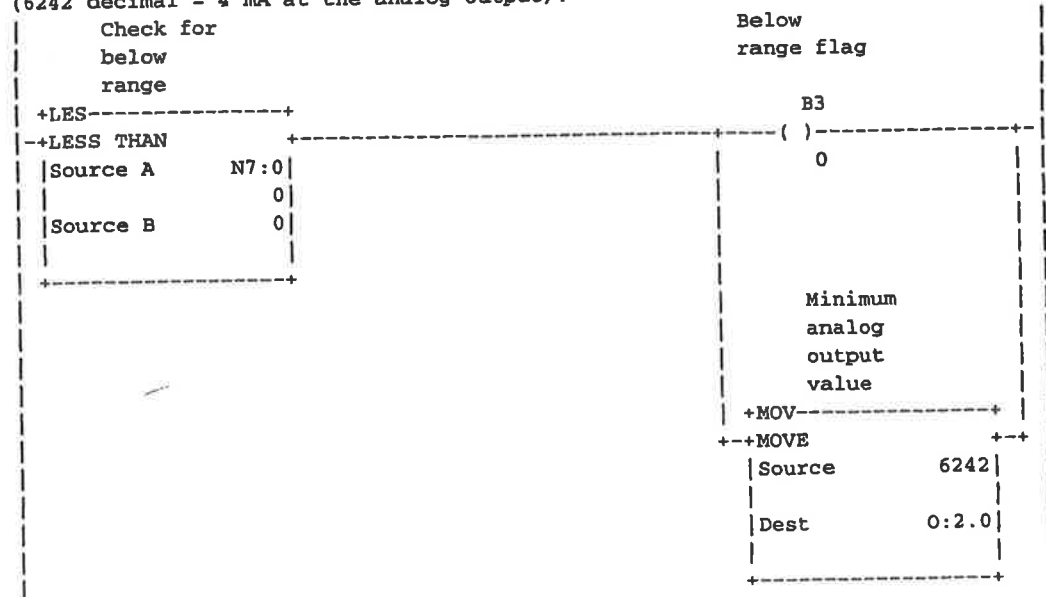
Rung 2:3

+END+

Using the Scale with Parameters (SCP) Instruction

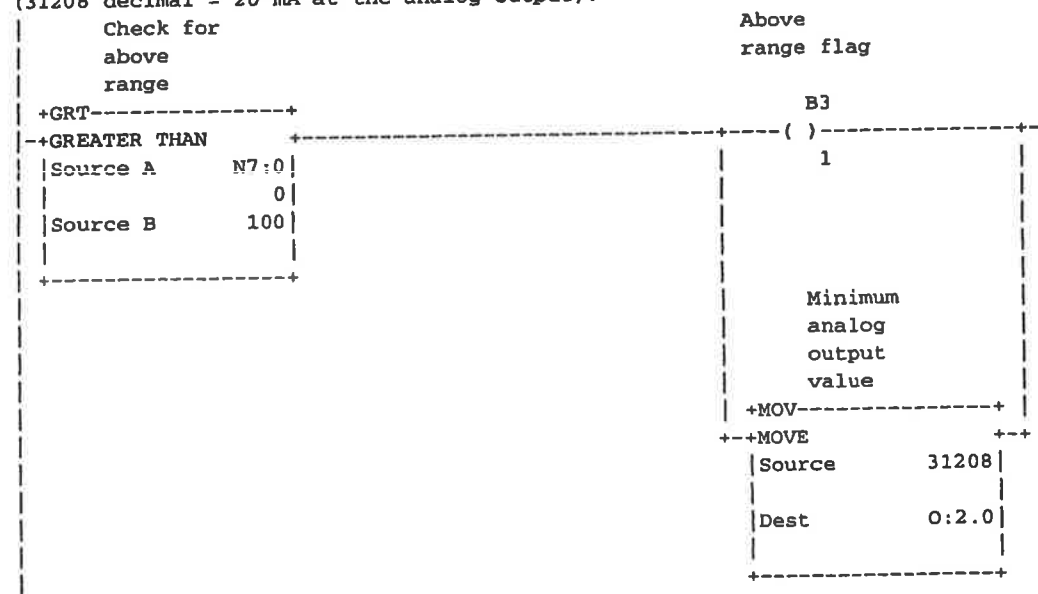
Rung 2:0

N7:0 contains percentage of valve open. If this value is less than 0, move the minimum value to the analog output (6242 decimal = 4 mA at the analog output).



Rung 2:1

N7:0 contains percentage of valve open. If this value is greater than 100, move the maximum value to the analog output (31208 decimal = 20 mA at the analog output).



Ladder logic continued on the next page.

Rung 2:2
 Scale values in the 0 to 100% range to the
 decimal range for the 4-20 mA analog output.

Below range flag B3	Above range flag B3	+SCP-----+ SCALE W/PARAMETERS
-----]/[-----]/[-----		Input N7:0
0	1	Input Min. 0
		Input Max. 100
		Scaled Min. 6242
		Scaled Max. 31208
		Scaled Output 0:2.0
		+-----+

Rung 2:3

-----+END+

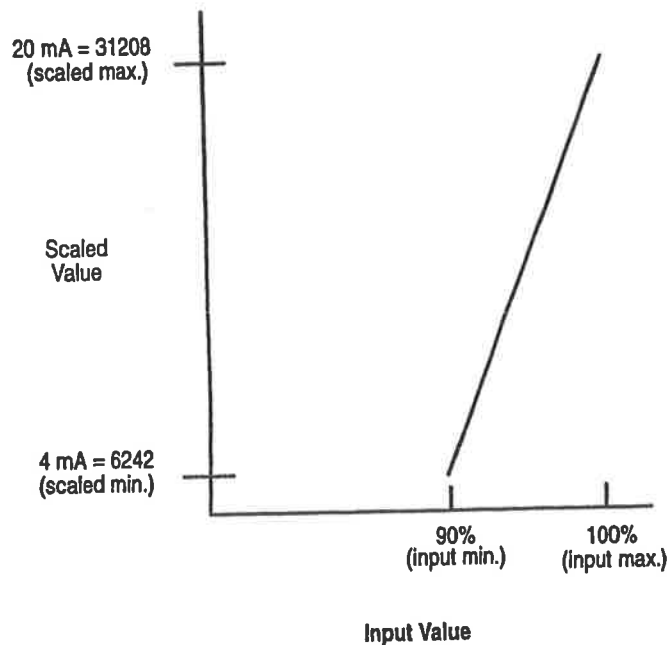
Scaling Offset when >32,767 or <-32,768

There may be applications when the offset value put into standard math instructions is greater than 32,767 or less than -32,768. In these cases, it is easier to shift the linear relationship along the input value axis and reduce the values.

This example is similar to the situation described in Example 2, except the 4 mA to 20 mA signal is scaled to a value between 90-100%. The NIO4I is located in slot 2 and the output device is wired to channel 0.

The following graph displays the linear relationship.

Figure 6.3



Calculating the Linear Relationship

Use the following equations to calculate the scaled units:

$$\text{Scaled value} = (\text{input value} \times \text{slope}) + \text{offset}$$

$$\text{Slope} = (\text{scaled max.} - \text{scaled min.}) / (\text{input max.} - \text{input min.})$$

$$(31,208 - 6,242) / (100 - 90) = 24,966/10$$

$$\text{Offset} = \text{scaled min.} - (\text{input min.} \times \text{slope})$$

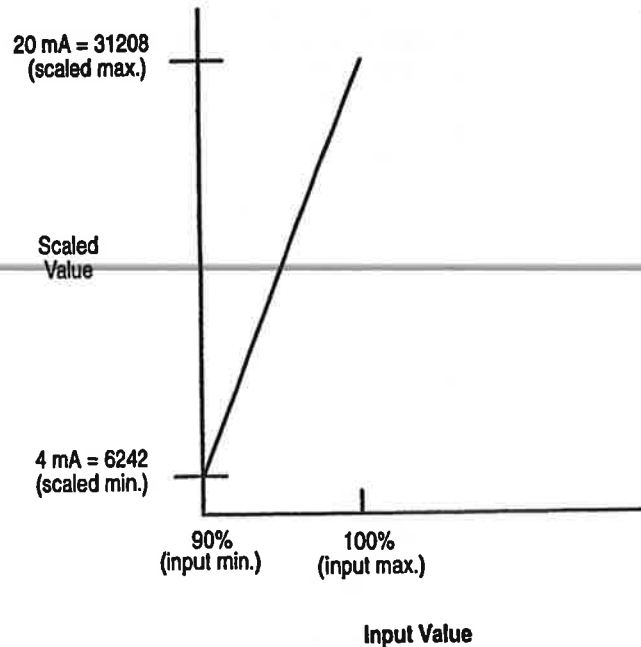
$$6242 - (90 \times (24,966/10)) = -218,452$$

$$\text{Scaled value} = (\text{input value}) \times (24,966/10) - 218,452$$

Notice the offset value is less than -32,768.

The following graph shows the shifted linear relationship. Notice that the resulting offset value is reduced.

Figure 6.4



Calculating the Shifted Linear Relationship

Use the following equations to recalculate the linear relationship:

$$\text{Scaled value} = ((\text{input value} - \text{input min.}) \times \text{slope}) + \text{offset}$$

$$\text{Slope} = (\text{scaled max.} - \text{scaled min.}) / (\text{input max.} - \text{input min.})$$

$$(31,208 - 6,242) / (100 - 90) = 24,966/10$$

$$\text{Offset} = \text{scaled min.}$$

$$6,242$$

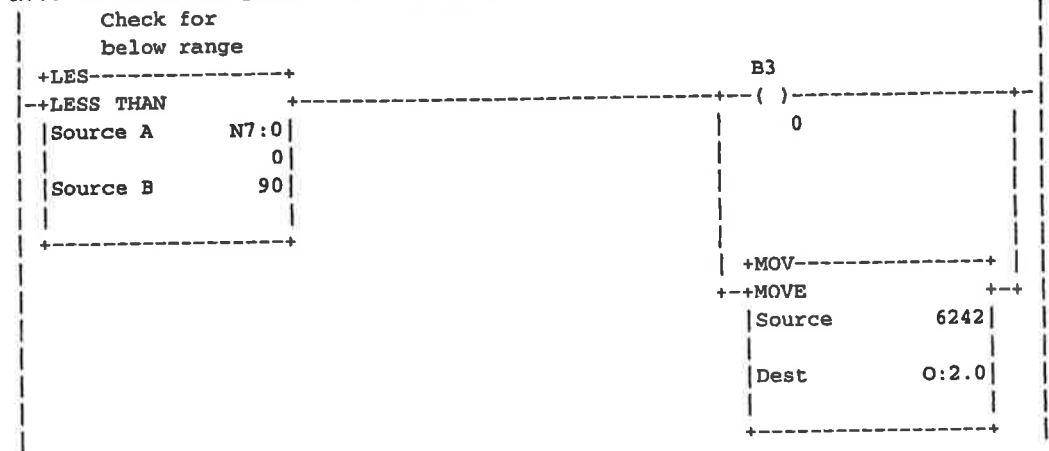
$$\text{Scaled value} = ((\text{input value} - 90) \times (24,966/10)) + 6242$$

Since the slope is greater than 3.2767, only standard math can be used for the ladder diagram with SLC 500 fixed, SLC 5/01, 5/02, 5/03 (OS300 and 301) and 5/04 (OS400). The following ladder diagram prevents a processor fault by unlatching the mathematical overflow bit S2:5/0 before the end of the scan. Refer to the example ladder diagram on the next page. Following this example is another ladder diagram performing the same function, but using the SCP (scale with parameters) instruction available only in the SLC 5/03 (OS302) and SLC 5/04 (OS401).

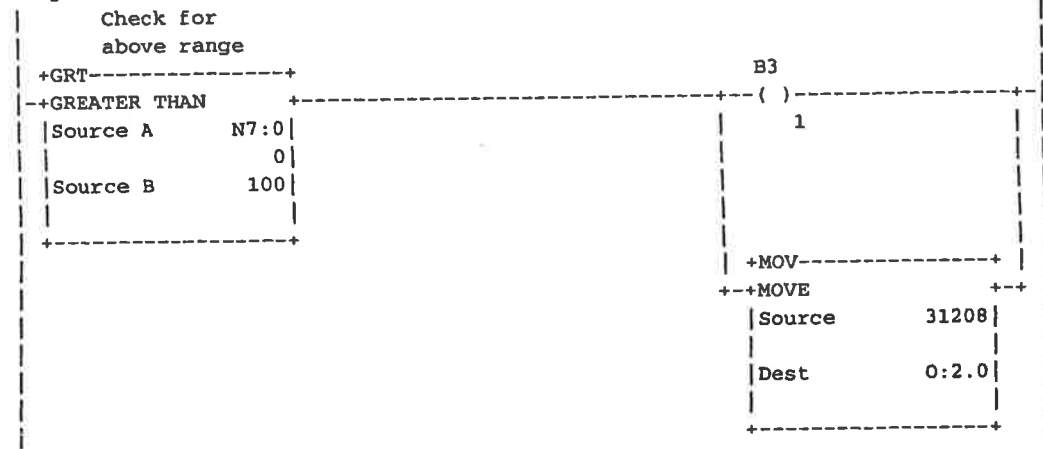
Using Standard Math

Rung 2:0

N7:0 contains the percentage of the valve open.



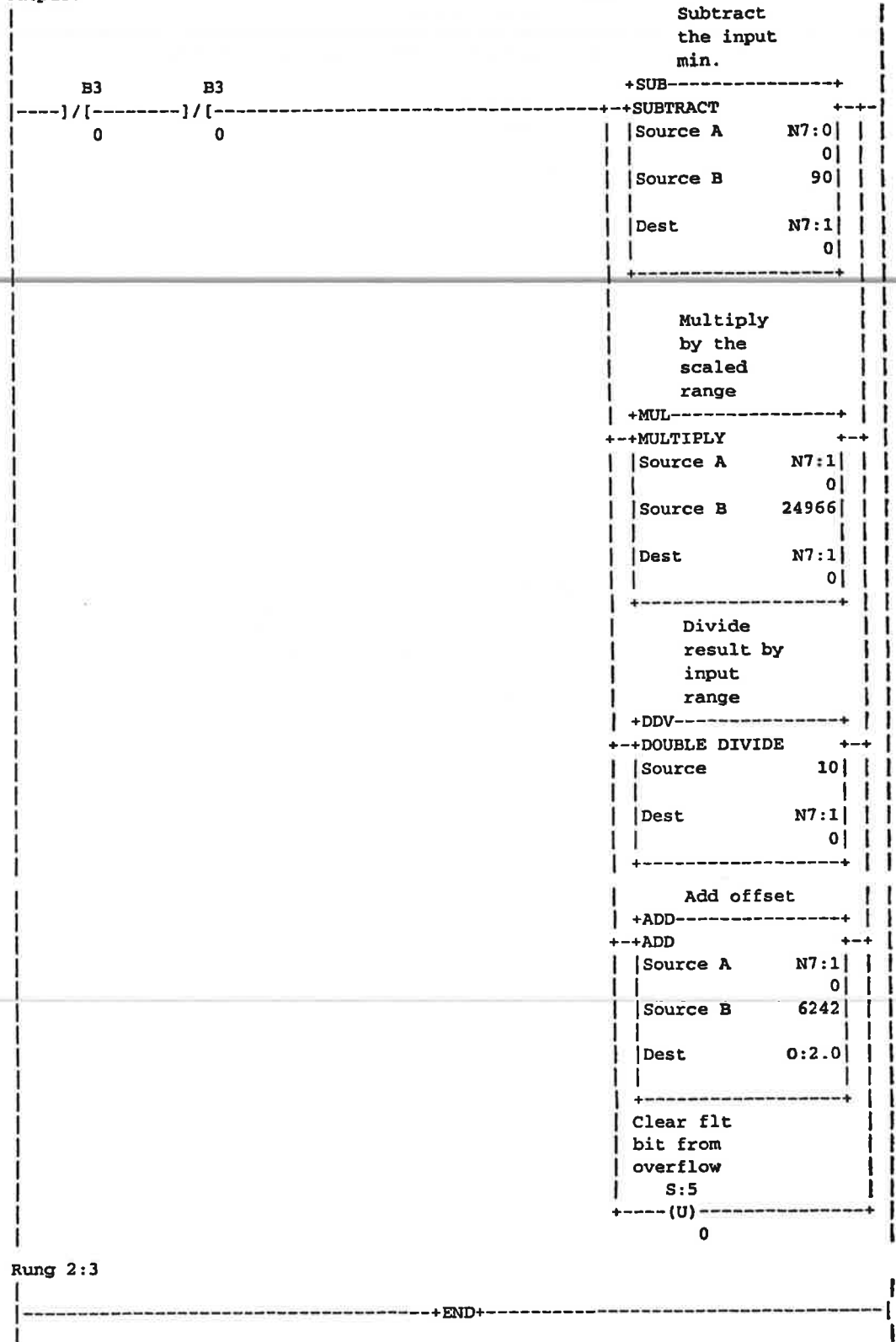
Rung 2:1



Ladder logic continued on the next page.

Rung 2:2

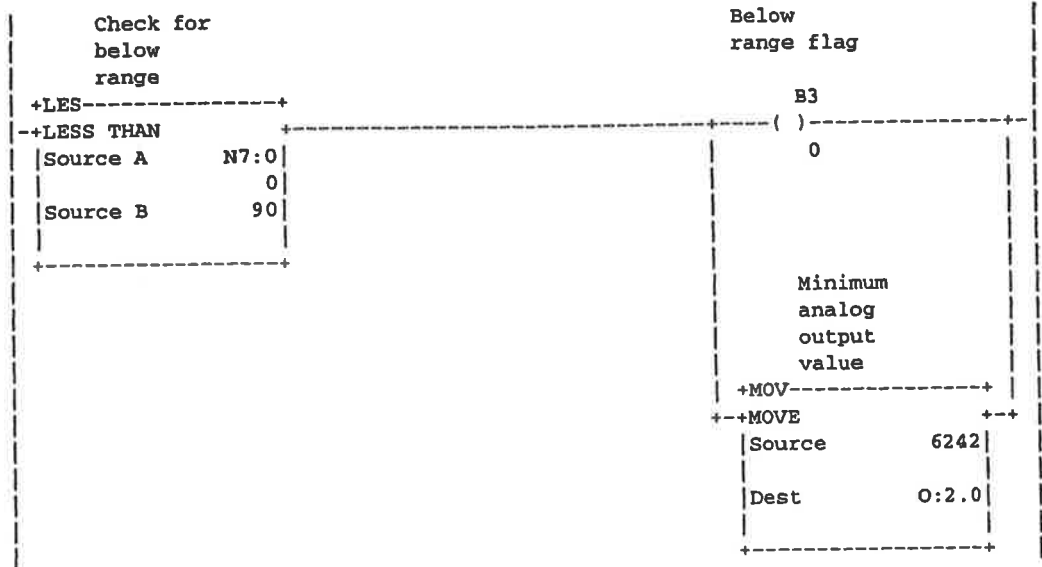
Scale values in the 90-100% range to the decimal range for the 4-20 mA analog output.



Using the Scale with Parameters (SCP) Instruction

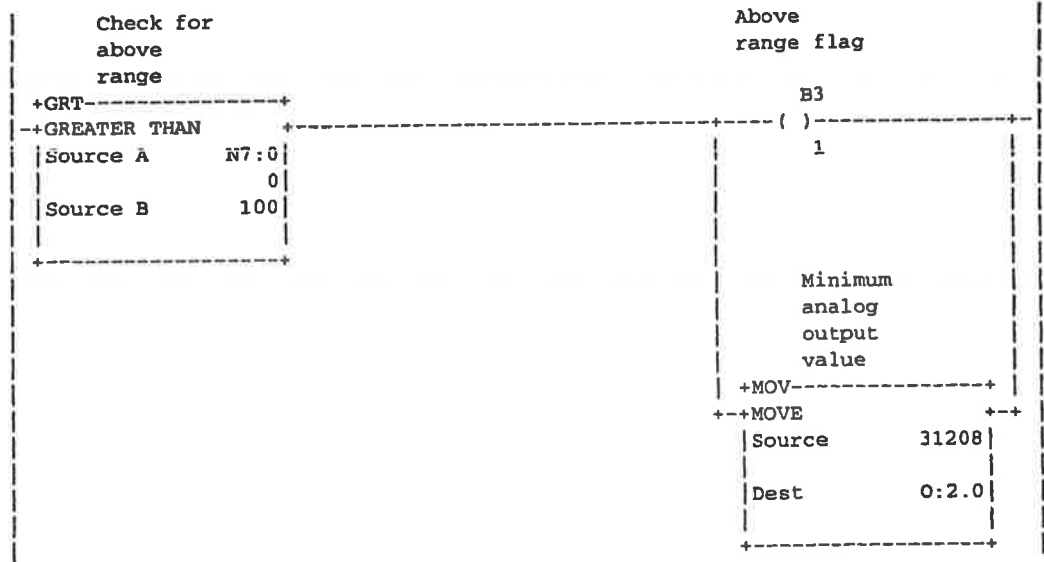
Rung 2:0

N7:0 contains percentage of valve open. If this value is less than 90, move the minimum value to the analog output (6242 decimal = 4 mA at the analog output).



Rung 2:1

N7:0 contains percentage of valve open. If this value is greater than 100, move the maximum value to the analog output (31208 decimal = 20 mA at the analog output).



Ladder logic continued on the next page.

Rung 2:2
 Scale values in the 90 to 100% range to the
 decimal range for the 4-20 mA analog output.

Below	Above	Scale for the analog output	
range flag	range flag		
B3	B3		
0	1	+SCP-----+ SCALE W/PARAMETERS	+-----+
		Input	N7:0
		Input Min.	90
		Input Max.	100
		Scaled Min.	6242
		Scaled Max.	31208
		Scaled Output	O:2.0
		+END+	

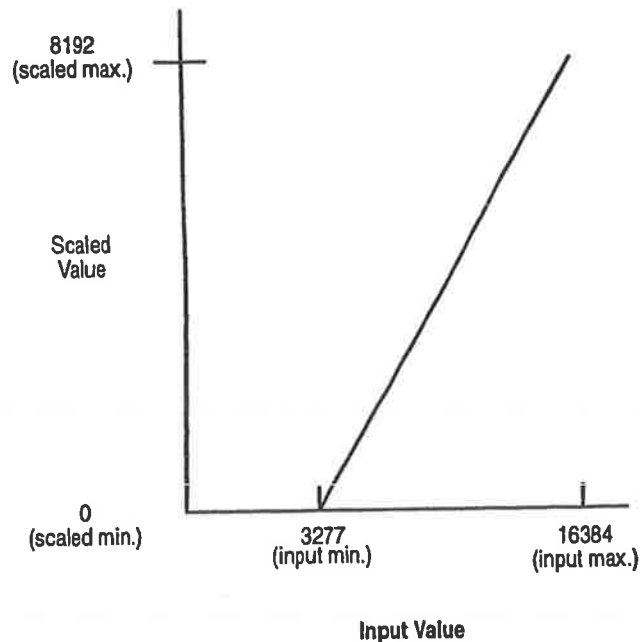
Scaling and Range Checking of Analog Inputs and Outputs

This example demonstrates the addressing of analog I/O and the scaling and range checking of analog input and output values. An NIO4V is placed in slot 1 of an SLC 500 system. A 0 to 200 psi pressure sensor is input as a 4 mA to 20 mA signal to input channel 0. The input value is checked to ensure it remains within the 4 mA to 20 mA range.

It is then scaled and output as a 0 to 2.5 volt signal to a panel meter pressure display connected to output channel 0. If an out-of-range condition is detected a flag bit will be set. The scaling operation is shown below.

The graph displays the linear relationship between the input value and the resulting scaled value.

Figure 6.5



Calculating the Linear Relationship

Use the following equations to express the linear relationship between the input value and the resulting scaled value:

$$\text{Scaled value} = (\text{input value} \times \text{slope}) + \text{offset}$$

$$\text{Slope} = (\text{scaled max.} - \text{scaled min.}) / (\text{input max.} - \text{input min.})$$

$$(8192 - 0) / (16384 - 3277) = 8192/13107$$

$$\text{Offset} = \text{scaled min.} - (\text{input min.} \times \text{slope})$$

$$0 - 3277 (8192/13,107) = -2048$$

$$\text{Scaled value} = (\text{input value} \times (8192/13017)) - 2048$$

This equation can be implemented using integer math capabilities of the SLC 500 system. Three example programs are shown. The first runs on any SLC 500 processor and the second uses the scaling instruction available on the SLC 5/02 and later processors. The third program uses the SCP (scale with parameters) instruction available only with SLC 5/03 (OS302 or later) and SLC 5/04 (OS401 or later).

In the first example program the analog input value is checked against the minimum and maximum allowable input values.

If the input is out-of-range, the output value is set to its minimum or maximum value. If the input value is in range the output value is determined by scaling the input. To scale an analog input, follow these steps:

1. Multiply the input by the scaled range
Scale range=(scaled max. – scaled min.).
2. Divide the 32 bit result by the input range
Input range=(input max. – input min.).
3. Add in the offset value (in this case negative). The final value is then moved to the analog output channel 0.

The multiply operation will generate an overflow bit and minor error flag whenever the results exceed 16 bits. Since the divide is carried out on the 32 bit result in the math register, the overflow does not present a problem. The minor error flag has to be cleared before the end of the program scan to avoid a system error.

Refer to the example ladder diagram on that follows.

Using Standard Math Instructions

Rung 2:0

Check for below range.



Ladder logic continued on the next page.

Rung 2:1

Check for above range.

```

+GRT-----+
|+GREATER THAN|
|Source A      I:1.0|
|Source B      16384|
+-----+
    
```

B3

```

( )
 1
    
```

```

+MOV-----+
+MOVE-----+
|Source        8192|
|Dest          0:1.0|
+-----+
    
```

Rung 2:2

Scale the analog input for the analog output.

```

B3      B3
] / [  ] / [
 0      1
    
```

Multiply
by the scaled
range

```

+MUL-----+
+MULTIPLY-----+
|Source A      I:1.0|
|Source B      8192|
|Dest          N7:0|
|              0|
+-----+
    
```

Divide
result by
the input
range

```

+DDV-----+
+DOUBLE DIVIDE-----+
|Source        13107|
|Dest          N7:0|
|              0|
+-----+
    
```

Add offset

```

+ADD-----+
+ADD-----+
|Source A      N7:0|
|              0|
|Source B      -2048|
|Dest          0:1.0|
+-----+
    
```

Clear flt
bit from
overflow
S:5

```

(U)
 0
    
```

Rung 2:3

+END+

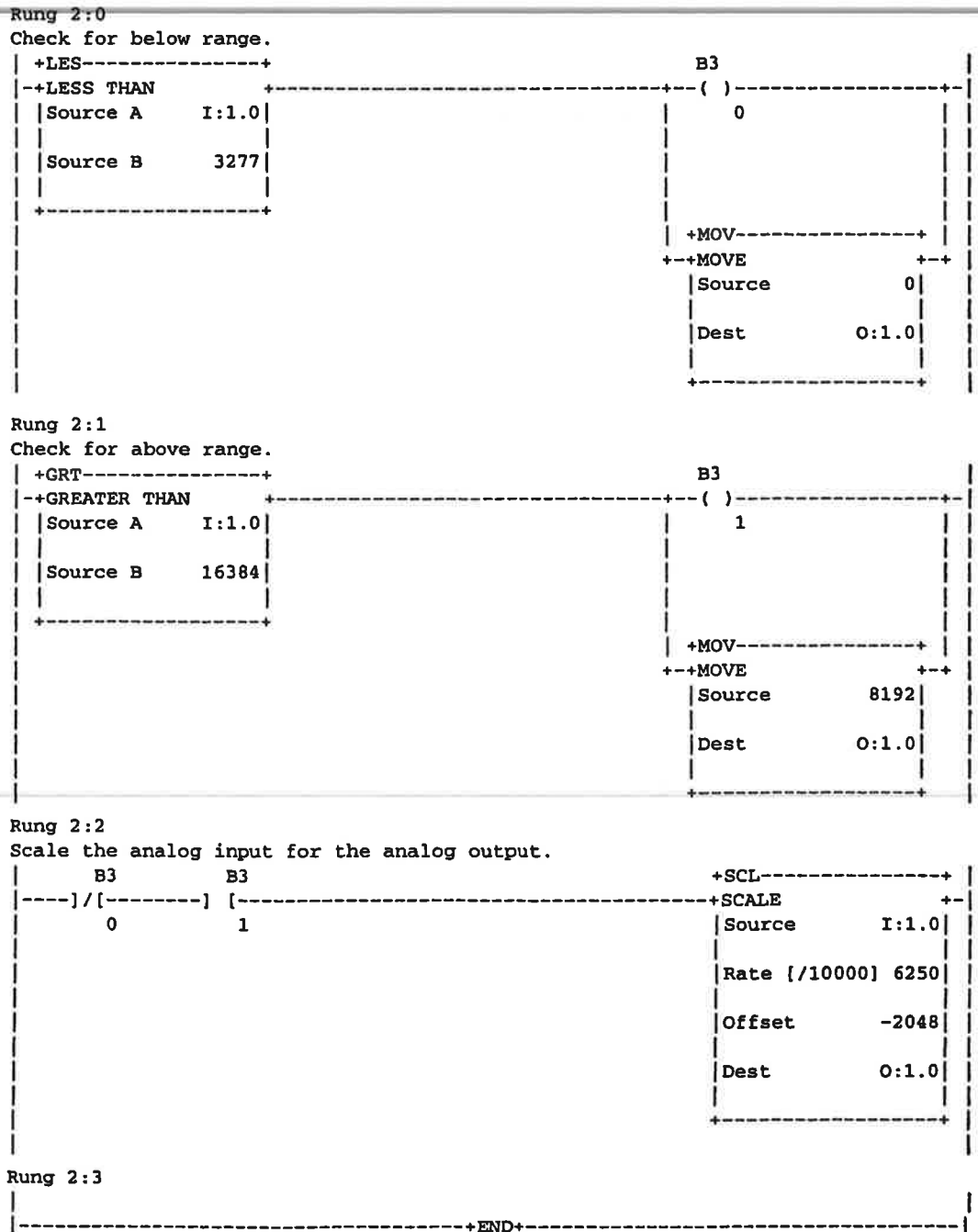
Scaling and Range Checking of Analog Inputs and Outputs

The scaling instruction available in the SLC 5/02 processor is used to realize a more efficient program. The scaling instruction uses the same multiply, divide and add algorithm but it does so with a single rate instead of the scaled range and input range values. The rate is determined by:

$$\text{Rate} = (\text{scaled range} / \text{input range}) \times 10,000$$

For the programming example the rate = 6250

Using SCL Instruction



Using the Scale with Parameters (SCP) Instruction

Rung 2:0

Check for below range.

```

+LES-----+
-+LESS THAN +-----+
|Source A   I:1.0|
|Source B   3277|
+-----+

```

B3

()

0

```

+MOV-----+
+MOVE-----+
|Source      0|
|Dest       O:1.0|
+-----+

```

Rung 2:1

Check for above range.

```

+GRT-----+
-+GREATER THAN +-----+
|Source A   I:1.0|
|Source B   16384|
+-----+

```

B3

()

1

```

+MOV-----+
+MOVE-----+
|Source     8192|
|Dest      O:1.0|
+-----+

```

Rung 2:2

Scale the analog input for the analog output.

```

      B3      B3
) / (-----) [-----]
      0        1

```

```

+SCP-----+
+SCALE W/PARAMETERS +-----+
|Input       I:1.0|
|Input Min.   3277|
|Input Max.   16384|
|Scaled Min.    0|
|Scaled Max.   8192|
|Scaled Output O:1.0|
+-----+

```

Rung 2:3

+END+

Maintenance and Safety

This chapter provides preventive maintenance information and safety considerations when troubleshooting your SLC 500 system.

Preventative Maintenance

The printed circuit boards of the analog modules must be protected from dirt, oil, moisture and other airborne contaminants. To protect these boards, the SLC 500 system must be installed in an enclosure suitable for the environment. The interior of the enclosure should be kept clean and the enclosure door should be kept closed whenever possible.

Regularly inspect your terminal connections for tightness. Loose connections may cause improper functioning of the SLC 500 system or damage the components of the system.



ATTENTION: To ensure personal safety and to guard against damaging equipment, inspect connections with incoming power OFF.

For general maintenance procedures for electrical equipment, refer to the requirements specific to your region.

- *Europe:* Refer to the standards found in EN 60204 and your national regulations.
- *United States:* Refer to article 70B of the National Fire Protection Association (NFPA). It describes general requirements regarding safety related work practices.

Safety Considerations When Troubleshooting

Safety considerations are an important element of proper troubleshooting procedures. Actively thinking about the safety of yourself and others, as well as the condition of your equipment, is of primary importance. Refer to the Fixed or Modular I/O Hardware Installation and Operation manual for additional information on troubleshooting.

The following section describes several safety areas you should be aware of when troubleshooting your SLC 500 system.

Indicator Lights – When the red LED on the analog module is illuminated it indicates that 24V dc power is applied to the module.

Activating Devices When Troubleshooting – When troubleshooting, never reach into the machine to actuate a device. Unexpected machine motion could occur. Use a wooden stick.

Stand Clear of Machine – When troubleshooting any SLC 500 system problem, have all personnel remain clear of the machine. The problem could be intermittent, and sudden unexpected machine motion could occur. Have someone ready to operate an emergency stop switch in case it becomes necessary to shut off power to the machine.

When troubleshooting, pay careful attention to this general warning:



ATTENTION: Never reach into a machine to actuate a switch since unexpected machine motion can occur and cause injury.

Remove all electrical power at the main power disconnect switches before checking electrical connections or inputs/outputs causing machine motion.

Program Alteration – There are several causes of alteration to the user program, including extreme environmental conditions, Electromagnetic Interference (EMI), improper grounding, improper wiring connections, and unauthorized tampering. If you suspect the program has been altered, check it against a previously saved program on an EEPROM or UV PROM memory module.

Safety Circuits – Circuits installed on the machine for safety reasons, like over travel limit switches, stop push buttons, and interlocks, should always be hard-wired to the master control relay. These devices must be wired in series so that when any one device opens, the master control relay is de-energized thereby removing power to the machine. Never alter these circuits to defeat their function. Serious injury or machine damage could result.

Specifications

Analog Module Specifications

This section lists the specifications for the 1746-NI4, NIO4I, NIO4V, NO4I and NO4V analog modules. They include:

- General specifications
- Current and Voltage input specifications
- Current and Voltage output specifications

General Specifications for NI4, NIO4I, NIO4V, NO4I, and NO4V

Table A.A

Description	Specification
SLC Communication Format	16 Bit Two's Complement Binary
Field Wiring to Backplane Isolation	500V dc
Update Time	512 μ s for all channels in parallel
Recommended Cable	Shielded Belden #8761
Maximum Wire Size	#14 AWG (maximum)
Terminal Block	Removable
Location	1746 chassis
Calibration	Factory Calibrated (Refer to calibration procedure, pg. C-2)
Noise Immunity	NEMA Standard ICS 2-230
Environmental Conditions	
Operating Temperature	0° to +60° C (+32° to +140° F)
Storage Temperature	-40° to +85° C (-40° to +185° F)
Relative Humidity	5 to 95% (non-condensing)
Agency Certification (when product or packaging is marked)	<ul style="list-style-type: none"> • CSA certified • CSA Class 1, Division 2 Groups A, B, C, D certified • UL listed • CE marked for all applicable directives

Table A.B

Catalog 1746-	Input Channels per Module	Output Channels per Module	Backplane Current Draw		External 24V dc Power Supply Tolerance
			5V (max.)	24V (max.)	
NI4	4 differential, voltage or current selectable per channel, not individually isolated	NA	35 mA	85 mA	NA
NIO4I	2 differential, voltage or current selectable per channel, not individually isolated	2 current outputs, not individually isolated	55 mA	145 mA	NA
NIO4V	2 differential, voltage or current selectable per channel, not individually isolated	2 voltage outputs, not individually isolated	55 mA	115 mA	NA
NO4I	NA	4 current outputs, not individually isolated	55 mA	195 mA	24 \pm 10% at 195 mA max. (21.6 to 26.4V dc) [ⓐ]
NO4V	NA	4 voltage outputs, not individually isolated	55 mA	145 mA	24 \pm 10% at 145 mA max. (21.6 to 26.4V dc) [ⓐ]

[ⓐ] Required for some applications if SLC 24V power is at a premium.

General Analog Input Specifications for NI4, NIO4I, NIO4V

Table A.C

Description	Specification
Converter Resolution	16 bit
Repeatability	\pm 1 LSB
Location of LSB in I/O image word	0000 0000 0000 0001
Non-linearity	0.01%
Common Mode Voltage Range	-20 to +20 volts
Common Mode Rejection at 0 to 10 Hz (min.)	50 dB
Common Mode Rejection at 60 Hz (min.)	105 dB
Normal Mode Rejection at 60 Hz (min.)	55 dB
Channel Bandwidth	10 Hz
Step Response	60 ms at 95%
Conversion Method	Delta-Sigma Modulation
Impedance to ANL COM	500K ohms
Impedance channel to channel	1M ohms

Current-Loop Input Specifications for NI4, NIO4I, and NIO4V

Table A.D

Description	Specification
Input Range (Normal Operation)	-20 to +20 mA
Absolute Maximum Input Current	-30 to +30 mA
Absolute Maximum Input Voltage	±7.5V dc or 7.5V ac RMS
Current Input Coding -20 to +20 mA	-16,384 to +16,384
Input Impedance	250 Ohms
Resolution	1.22070 μ A per LSB
Full Scale	20 mA
Overall Accuracy at +25° C (77° F) (max.)	±0.365% of full scale
Overall Accuracy at 0° to +60° C (32° to 140° F) (max.)	±0.642% of full scale [Ⓣ]
Overall Accuracy Drift (max.)	+79ppm/5 C of full scale
Gain Error at +25° C (77° F) (max.)	+0.323%
Gain Error at 0° to +60° C (32° to 140° F) (max.)	±0.556%
Gain Error Drift (max.)	±67ppm/° C
Offset Error at +25° C (77° F) (max.) (Iin = 0, Vcm = 0)	±7 LSB
Offset Error at 0° to +60° C (32° to 140° F) (max.) (Iin = 0, Vcm = 0)	±14 LSB
Offset Error Drift (max.) (Iin = 0, Vcm = 0)	±0.20 LSB/° C

[Ⓣ] Refer to Appendix C for a method to improve accuracy over temperature.

Voltage Input Specifications for NI4, NIO4I, and NIO4V

Table A.E

Description	Specification
Input Range	-10 to +10V dc - 1 LSB
Voltage Input Coding (-10 to +10V dc - 1 LSB)	-32,768 to +32,767
Input Impedance	1M ohms
Resolution	305.176 μ V per LSB
Full Scale	10V dc
Overall Accuracy at +25° C (77° F) (max.)	$\pm 0.284\%$ of full scale
Overall Accuracy at 0° to +60° C (32° to 140° F) (max.)	$\pm 0.504\%$ of full scale [ⓐ]
Overall Accuracy Drift (max.)	± 63 ppm/° C of full scale
Gain Error at +25° C (77° F) (max.)	$\pm 0.263\%$
Gain Error at 0° to +60° C (32° to 140° F) (max.)	$\pm 0.461\%$
Gain Error Drift (max.)	± 57 ppm/° C
Offset Error at +25° C (77° F) (max.)	± 7 LSB
Offset Error at 0° to +60° C (32° to 140° F) (max.)	± 14 LSB
Offset Error Drift (max.)	± 0.20 LSB/° C
Overvoltage Protection (max. across IN+ to IN- terminals)	either 220V ac RMS continuously or 220V dc continuously

[ⓐ] Refer to Appendix C for a method to improve accuracy over temperature.

Current Output Specifications for NIO4I and NO4I

Table A.F

Description	Specification
Converter Resolution	14 bit
Location of LSB in I/O image word	0000 0000 0000 01XX
Non-linearity	0.05%
Conversion Method	R-2R Ladder
Step Response	2.5 ms (at 95%)
Load Range	0 to 500 Ohms
Maximum Load Reactance	100 μ H
Current Output Coding (0 to +21 mA - 1 LSB)	0 to +32764
Output Range (Normal)	0 to +20 mA
Overrange Capability	5% (0 to +21 mA - 1 LSB)
Resolution	2.56348 μ A per LSB
Full Scale	21 mA
Overall Accuracy at +25° C (77° F) (max.)	$\pm 0.298\%$ of full scale
Overall Accuracy at 0° to +60° C (32° to 140° F) (max.)	$\pm 0.541\%$ of full scale
Overall Accuracy Drift (max.)	$\pm 70\text{ppm}/^\circ\text{C}$ of full scale
Gain Error at +25° C (77° F) (max.)	$\pm 0.298\%$
Gain Error at 0° to +60° C (32° to 140° F) (max.)	$\pm 0.516\%$
Gain Error Drift (max.)	$\pm 62\text{ppm}/^\circ\text{C}$
Offset Error at +25° C (77° F) (max.)	± 10 LSB
Offset Error at 0° to +60° C (32° to 140° F) (max.)	± 12 LSB
Offset Error Drift (max.)	± 0.06 LSB/ $^\circ\text{C}$

Voltage Output Specifications for NIO4V and NO4V

Table A.G

Description	Specification
Converter Resolution	14 bit
Location of LSB in I/O image word	0000 0000 0000 01XX
Non-linearity	0.05%
Conversion Method	R-2R Ladder
Step Response	2.5 ms (at 95%)
Load Range	1K to ∞ Ohms
Maximum Load Current	10 mA
Maximum Load Reactance	1 μ F
Voltage Output Coding (-10 to +10V dc - 1 LSB)	-32,768 to +32,764
Output Range (Normal)	-10 to +10 volts - 1 LSB
Resolution	1.22070 mV per LSB
Full Scale	10V dc
Overall Accuracy at +25° C (77° F) (max.)	$\pm 0.208\%$ of full scale
Overall Accuracy at 0° to +60° C (32° to 140° F) (max.)	$\pm 0.384\%$ of full scale
Overall Accuracy Drift (max.)	$\pm 54\text{ppm}/^\circ\text{C}$ of full scale
Gain Error at +25° C (77° F) (max.)	$\pm 0.208\%$
Gain Error at 0° to +60° C (32° to 140° F) (max.)	$\pm 0.374\%$
Gain Error Drift (max.)	$\pm 47\text{ppm}/^\circ\text{C}$
Offset Error at +25° C (77° F) (max.)	± 9 LSB
Offset Error at 0° to +60° C (32° to 140° F) (max.)	± 11 LSB
Offset Error Drift (max.)	± 0.05 LSB/ $^\circ\text{C}$

Two's Complement Binary Numbers

The SLC 500 processor memory stores 16-bit binary numbers. Two's complement binary is used when performing mathematical calculations internal to the processor. Analog input values from the analog modules are returned to the processor in 16-bit two's complement binary format. For positive numbers, the binary notation and two's complement binary notation are identical.

As indicated in the figure on the next page, each position in the number has a decimal value, beginning at the right with 2^0 and ending at the left with 2^{15} . Each position can be 0 or 1 in the processor memory. A 0 indicates a value of 0; a 1 indicates the decimal value of the position. The equivalent decimal value of the binary number is the sum of the position values.

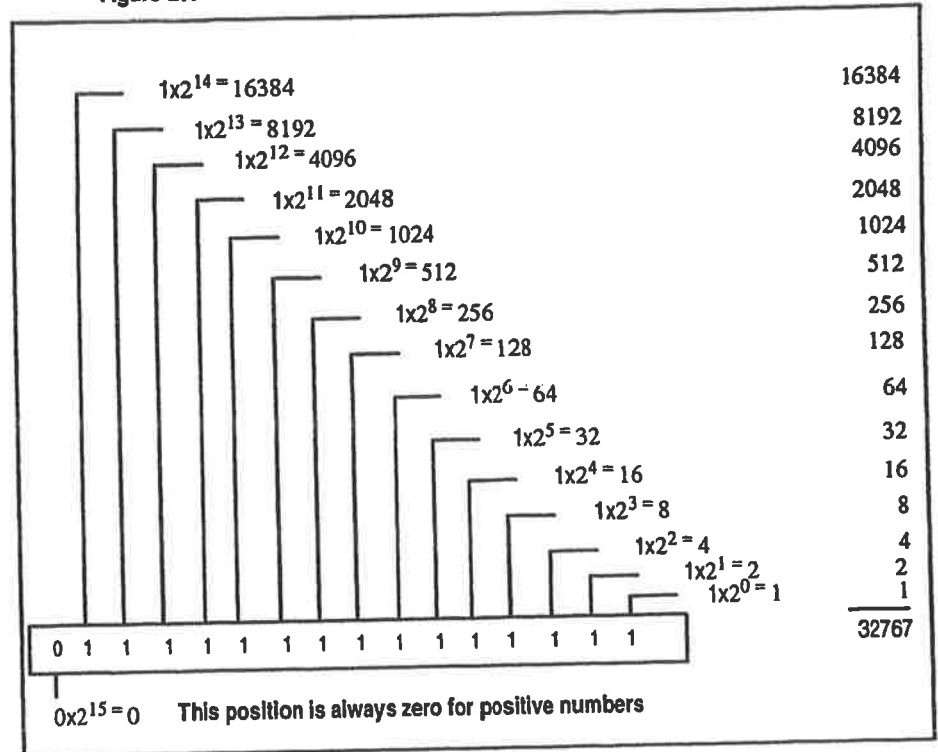
Positive Decimal Values

The far left position is always 0 for positive values. As indicated in the figure on the next page, this limits the maximum positive decimal value to 32767 (all positions are 1 except the far left position). For example:

$$\begin{aligned} 0000\ 1001\ 0000\ 1110 &= 2^{11} + 2^8 + 2^3 + 2^2 + 2^1 \\ &= 2048 + 256 + 8 + 4 + 2 = 2318 \end{aligned}$$

$$\begin{aligned} 0010\ 0011\ 0010\ 1000 &= 2^{13} + 2^9 + 2^8 + 2^5 + 2^3 \\ &= 8192 + 512 + 256 + 32 + 8 = 9000 \end{aligned}$$

Figure B.1



Negative Decimal Values

In two's complement notation, the far left position is always 1 for negative values. The equivalent decimal value of the binary number is obtained by subtracting the value of the far left position, 32768, from the sum of the values of the other positions. In the figure on the next page (all positions are 1), the value is $32767 - 32768 = -1$. For example:

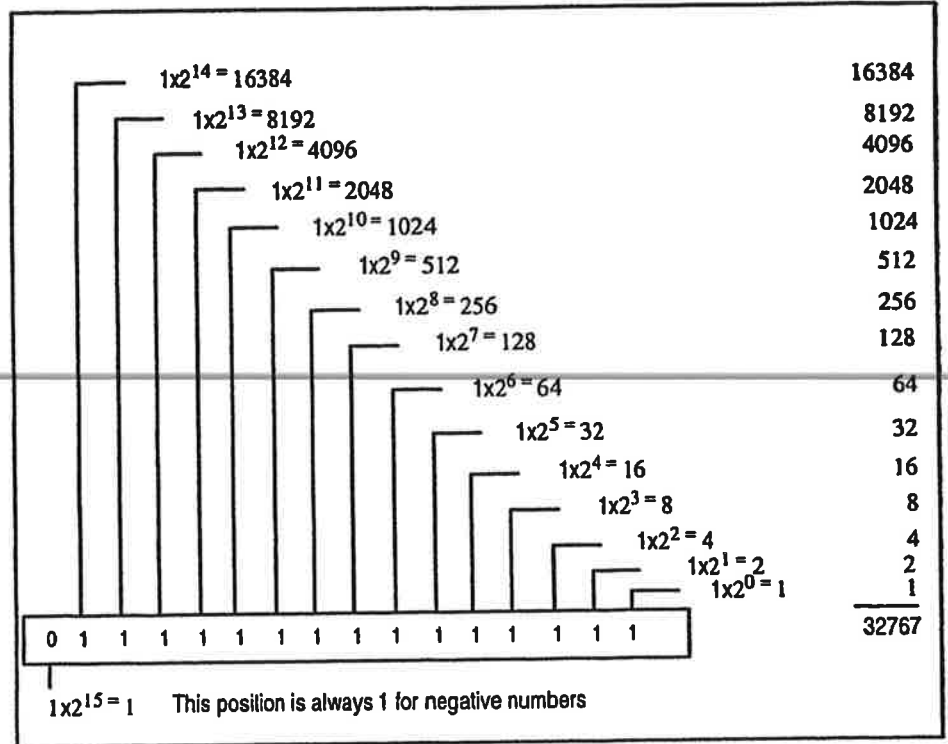
$$1111\ 1000\ 0010\ 0011 =$$

$$(2^{14} + 2^{13} + 2^{12} + 2^{11} + 2^5 + 2^1 + 2^0) - 2^{15} =$$

$$(16384 + 8192 + 4096 + 2048 + 32 + 2 + 1) - 32768 =$$

$$30755 - 32768 = -2013.$$

Figure B.2



Optional Analog Input Software Calibration

This appendix helps you calibrate an analog input channel using software offsets to increase the expected accuracy of an analog input circuit. Examples of equations and a ladder diagram are provided for your reference. A software calibration reduces the offset error and gain error at a given temperature by scaling the values read at calibration time. (Refer to the Preface for a definition of terms).

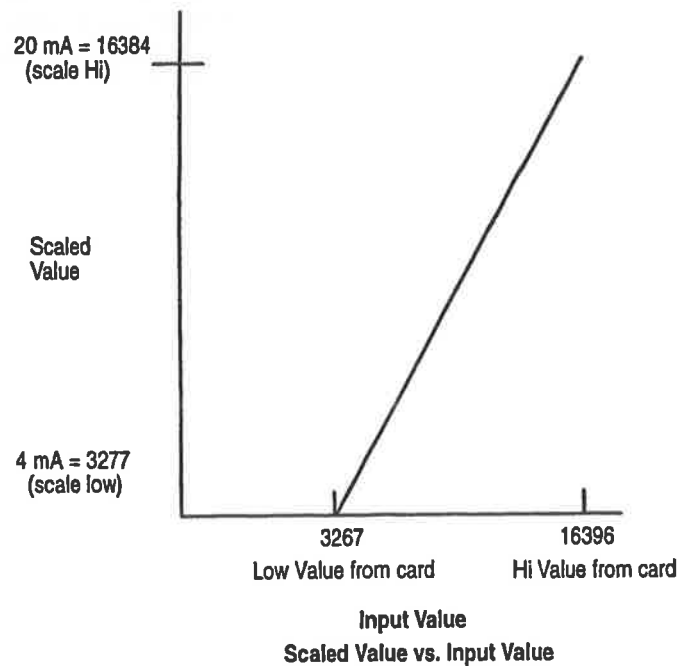
Calibrating an Analog Input Channel

The following procedure can be adapted to all analog inputs; current or voltage. For this example the 1746-NI4 with a 4 mA to 20 mA input is used. Refer to the 1746-NI4 specifications in appendix A. These specifications represent the worst case values. The overall error for the NI4, which is guaranteed to be not more than $\pm 0.365\%$ includes non-linearity, repeatability, offset error and gain error at a given temperature.

The overall error of $\pm 0.365\%$ at 20 mA equates to ± 60 LSB of error, or a code range of 16324 to 16444. Any value in this range is returned by an analog input channel at 20 mA. The expected nominal value at 20 mA is 16384. After performing a software calibration the overall error is reduced to 3 LSB, or a code range of 16381 to 16387.

The graph on the next page shows the linear relationship between the input value and the resulting scaled value. The values in this graph are from the example program.

Figure C.1



Calculating the Software Calibration

Use the following equation to perform the software calibration:

$$\text{Scaled Value} = (\text{input value} \times \text{slope}) + \text{offset}$$

$$\text{Slope} = (\text{scaled max.} - \text{scaled min.}) / (\text{input max.} - \text{input min.})$$

$$\text{Offset} = \text{Scaled min.} - (\text{input min.} \times \text{slope})$$

Procedure

1. Place your SLC 500 system in the normal operating temperature. Ensure that adjacent I/O modules in your system do not cause temperature fluctuations. For example, place high power and random load I/O modules away from your analog input module.
2. Determine the scaled high and low values you wish to use in your application. In this example, scaled high is 16384 and scaled low is 3277.
3. Using an analog input calibration source or your system's input device placed at the 4 mA position, capture the low value by energizing the calibrate low input. Ensure that your low value lies within the conversion range of your analog input.
4. Using an analog input calibration source or your system's input device placed at the 20 mA position, capture the high value by energizing the calibrate high input. Ensure that your high value lies within the conversion range of your analog input.

5. Energize the calibrate input. This causes the SLC to calculate the slope and offset values used to perform the error correction to the analog input.

The analog channel is now calibrated to ± 3 LSB at the calibration temperature. Use the offset error drift and gain error drift to calculate the amount of additional error that can be introduced into your system due to temperature variation.

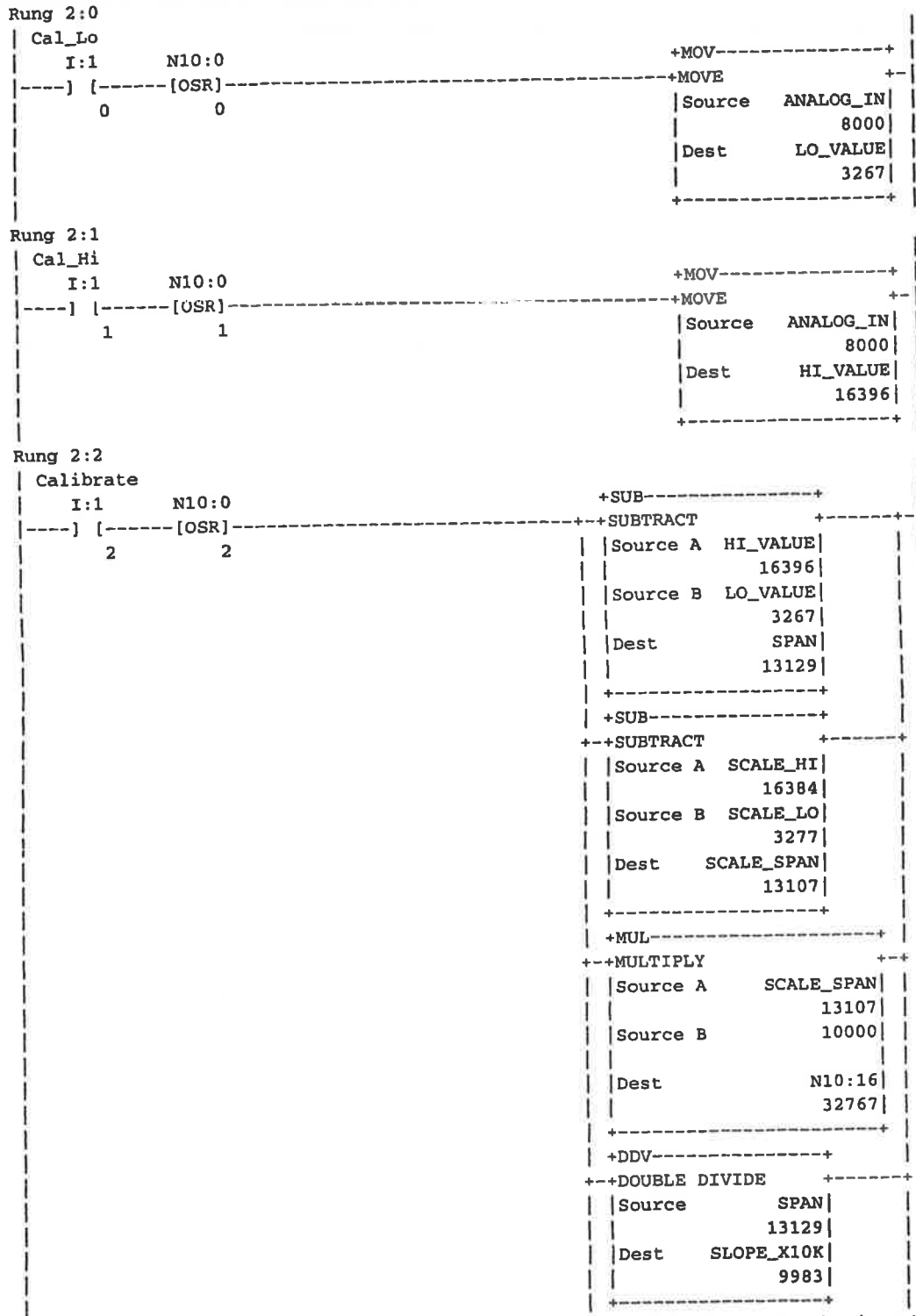
The recommended calibration period is once every 6 months. If an application has a wide range of operating temperatures, a software calibration should be performed every 3 to 4 months.

Example Ladder Diagram

The following ladder diagram requires 3 external inputs that are used to perform the calibration procedure. Lo causes the ladder to capture the 4 mA calibration value and Hi causes the ladder to capture the 20 mA calibration value. Cal causes the ladder diagram to scale the Hi and Lo values to the nominal values, which provides the slope and offset values used to calibrate the analog input channel.

The following symbols are used in this example:

Cal_Lo	= I:1.0/0
Cal_Hi	= I:1.0/1
Calibrate	= I:1.0/2
Conversion Enable	= N10:0/3
Analog_In	= I:2.0
Lo_Value	= N10:1
Hi_Value	= N10:2
Scale_Hi	= N10:3
Scale_Lo	= N10:4
Scale_Span	= N10:7
Span	= N10:9
Slope_x10K	= N10:18
Offset	= N10:19
Analog_Scl	= N10:20



Ladder logic continued on the next page.

```

+MUL-----+
+MULTIPLY      +
| Source A      LO_VALUE |
|                3267 |
| Source B      SLOPE_X10K |
|                9983 |
| Dest          N10:5 |
|                32767 |
+-----+
+DDV-----+
+DOUBLE DIVIDE  +
| Source        10000 |
| Dest          N10:6 |
|                3261 |
+-----+
+SUB-----+
+SUBTRACT      +
| Source A      SCALE_LO |
|                3277 |
| Source B      N10:6 |
|                3261 |
| Dest          OFFSET |
|                16 |
+-----+
S:5
(U)
0
    
```

Rung 2:3
 Conversion
 Enable
 N10:0

] [3

```

+MUL-----+
+MULTIPLY      +
| Source A      ANALOG_IN |
|                8000 |
| Source B      SLOPE_X10K |
|                9983 |
| Dest          N10:8 |
|                0 |
+-----+
S:5
(U)
0
+DDV-----+
+DOUBLE DIVIDE  +
| Source        10000 |
| Dest          N10:12 |
|                0 |
+-----+
+ADD-----+
+ADD           +
| Source A      N10:12 |
|                0 |
| Source B      OFFSET |
|                16 |
| Dest          ANALOG_SCL |
|                8002 |
+-----+
    
```

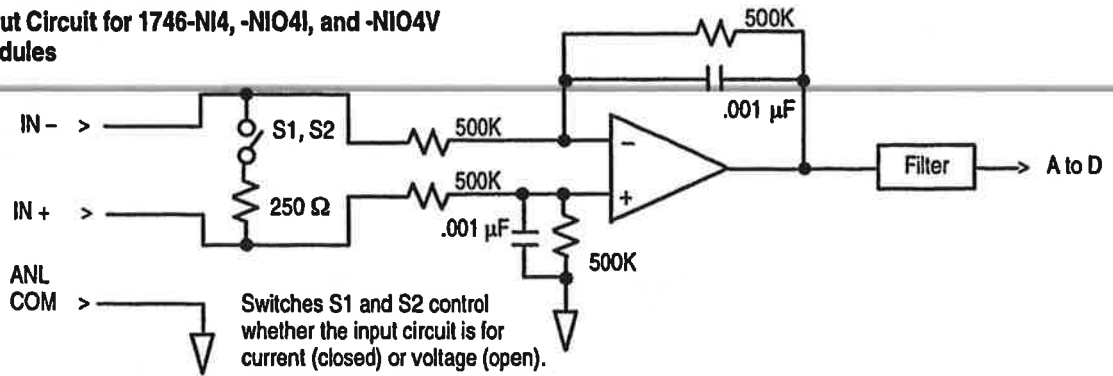
Rung 2:4

+END+

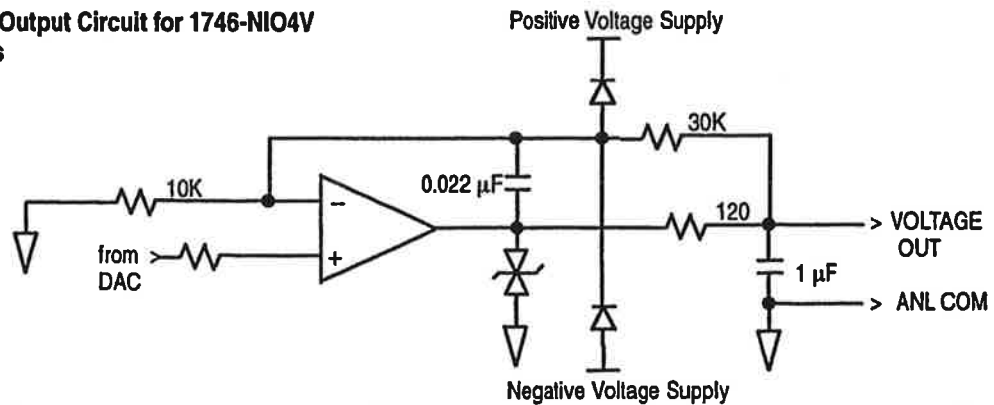
Module Input and Output Circuits

Figure D.1

Input Circuit for 1746-NI4, -NIO4I, and -NIO4V Modules



Voltage Output Circuit for 1746-NIO4V Modules



Current Output Circuit for 1746-NIO4I Modules

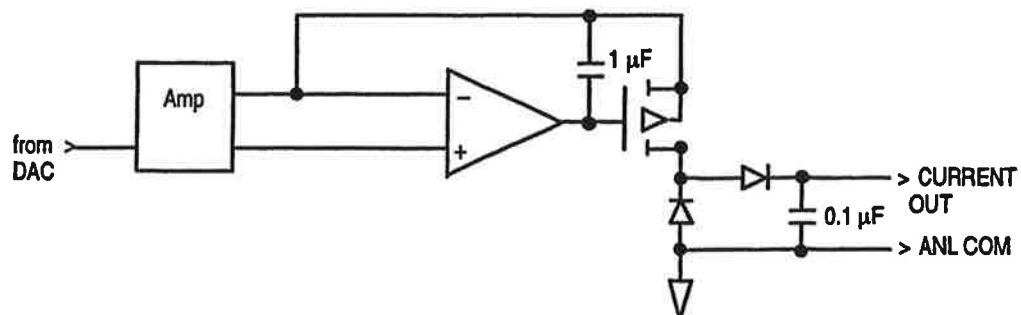
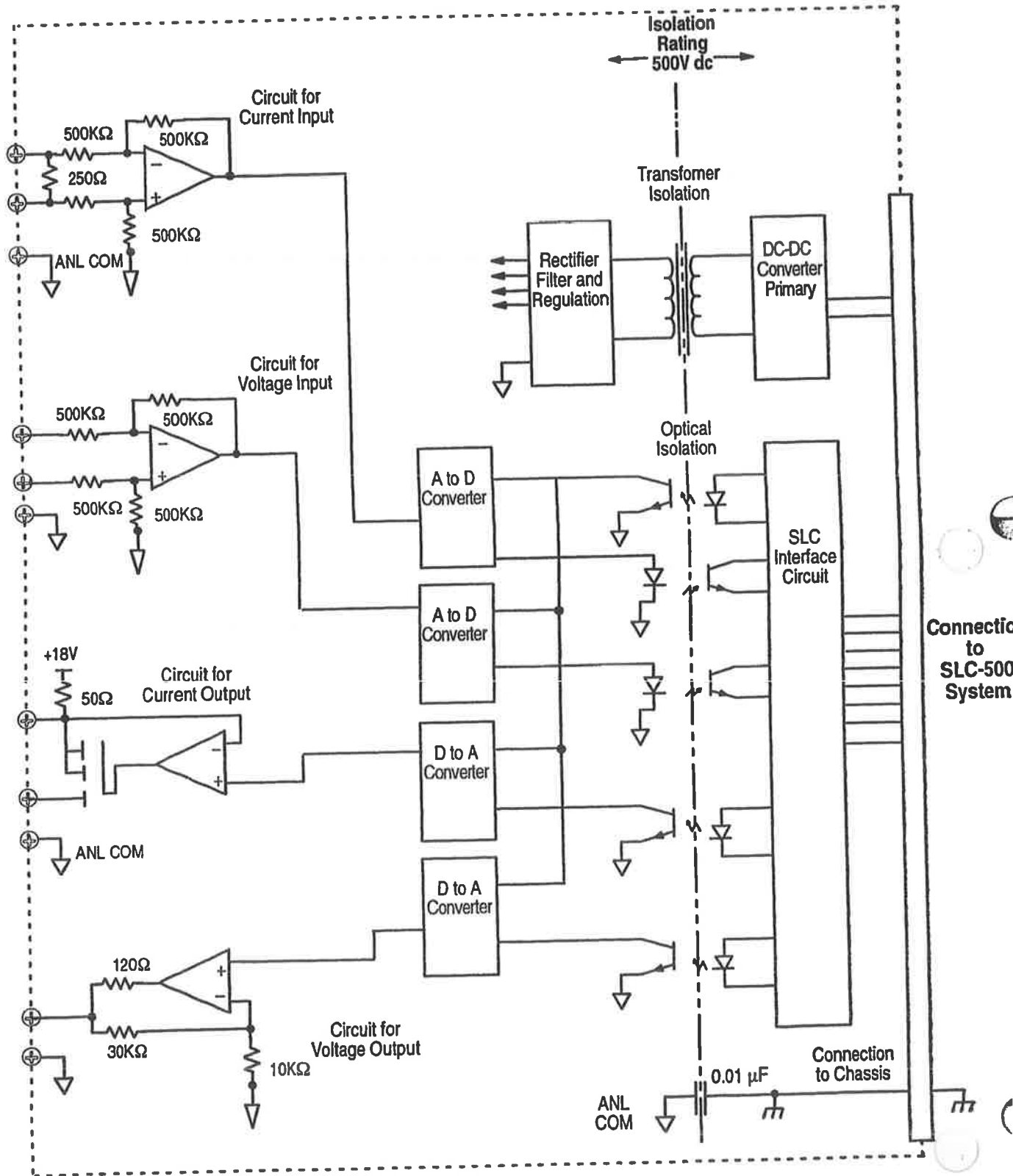


Figure D.2
Isolation Diagram



A

- A/D Conversion, P-2
- Addressing Analog Modules, 4-2
- Addressing and Scaling Outputs
 - Calculating the Linear Relationship, 6-8
 - overview, 6-8
 - Using Standard Math, 6-10
 - Using the Scale with Parameters (SCP) Instruction, 6-12
- Addressing, Out-of-Range Detection, and Scaling of Analog Inputs
 - Calculating the Linear Relationship, 6-2
 - Calculating the Out-of-Range Flag Using the Scale Instruction, 6-3
 - overview, 6-1
 - Using Standard Math, 6-4
 - Using the Scale (SCL) Instruction, 6-6
 - Using the Scale with Parameters (SCP) Instruction, 6-7
- Allen-Bradley, contacting for assistance, P-9
- analog modules
 - addressing, 4-2
 - configuring, 3-4
 - inspecting, 5-2
 - installing, 3-6
 - minimizing electrical noise, 3-16
 - Specifications, A-1
 - system considerations, 4-10
 - types, 1-2
 - wiring, 3-10

B

- Bit Level Addressing, 4-5

C

- Calculating the Software Calibration, C-2
- CE certification, 3-1
- channel, P-2

- chassis, P-2
- Choosing a Slot in the Chassis, 3-6
- Common Mode Rejection, P-2
- Common Mode Voltage, P-2
- Common Mode Voltage Range, P-2
- Configuring Your Module
 - External Power Switch for the 1746-NO4I and NO4V, 3-5
 - Switch Settings for the 1746-NI4, 3-4
 - Switch Settings for the 1746-NIO4I and NIO4V, 3-5
- contacting Allen-Bradley for assistance, P-9
- contents of manual, P-7
- Converting Analog Input Data, 4-7
- Converting Analog Output Data, 4-8
- Current Output Circuit for 1746-NIO4I Modules, D-1

D

- D/A Conversion, definition, P-2
- definitions, P-2
- determining power requirements
 - fixed controller, 3-3
 - modular controller, 3-2
- Differential Operation, P-2
- Disconnect Prime Movers, 5-2

E

- electrical noise, minimizing, 3-16
- equipment needed, 2-1
- European Union Directive Compliance, 3-1

F

- fixed controller, power requirements, 3-3
- Full Scale, P-2

G

- Gain, P-3
- Gain Error, P-3
- Gain Error Drift, P-3
- getting started
 - overview, 2-1
 - procedures, 2-2
- getting started quickly, 2-1
- Grounding the Foil Shields and Drain Wires, 3-12

H

- How to Use Analog, 1-1

I

- Input Channel Filtering, 4-15
- Input Circuit for 1746-NI4, -NIO4I, and -NIO4V Modules, D-1
- Input Out-of-Range Detection, 4-12
- Input Response to Slot Disable, 4-14
- Inspect the Analog Module, 5-2
- installation, getting started, 2-1
- Installing Your Module, 3-6

L

- Labeling and Installing the Terminal Block, 3-12
- Least Significant Bit (LSB), P-3
- Linearity Error, P-4

M

- manuals, related, P-7
- Maximum Differential Voltage, P-2
- Minimizing Electrical Noise, 3-16
- modular controller, power requirements, 3-2
- module ID codes, entering, 4-2

- Module Input and Output Circuits
 - Current Output Circuit for 1746-NIO4I Modules, D-1
 - Input Circuit for 1746-NI4, -NIO4I, and -NIO4V Modules, D-1
 - Voltage Output Circuit for 1746-NIO4V Modules, D-1
- Monitoring Input and Output Data, 4-6

N

- Negative Decimal Values, B-2
- Non-Retentive Analog Output Example, 4-11
- Number of Significant Bits, P-4

O

- Offset, P-4
- Offset Error, P-5
- Offset Error Drift, P-5
- Optional Analog Input Software Calibration, Calibrating an Analog Input Channel, C-1
- Output Response to Slot Disable, 4-14
- Overall Accuracy, P-5

P

- Positive Decimal Values, B-1
- power requirements
 - fixed controller, 3-3
 - modular controller, 3-2
- Power-Up the SLC 500 System, 5-3
- Preventive Maintenance, 7-1
- Processor Update of Analog Data, 4-6
- publications, related, P-7

Q

- Quick Start for Experienced U 2-1

R

- Related Documentation, P-7
- Repeatability, P-6
- Required Tools and Equipment, 2-1
- Resolution, P-6
- Response to Slot Disable, 4-14
- Retentive Programming Option, 4-10

S

- Safe State, P-6
- Safety Considerations when Troubleshooting, 7-2
- Scaling and Range Checking of Analog Inputs and Outputs
 - Calculating the Linear Relationship, 6-19
 - overview, 6-19, 6-22
 - Using SCL Instruction, 6-22
 - Using Standard Math Instructions, 6-21
 - Using the Scale with Parameters (SCP) Instruction, 6-23
- Scaling Offset when $>32,767$ or $<-32,768$
 - Calculating the Linear Relationship, 6-14
 - Calculating the Linear Shifted Relationship, 6-15
 - overview, 6-14
 - Using Standard Math, 6-16
 - Using the Scale with Parameters (SCP) Instruction, 6-18
- Specifications
 - current loop for NI4, NIO4I, NIO4V, A-3
 - current output for NIO4I, NO4I, A-5
 - general, A-1
 - input for NI4, NIO4I, NIO4V, A-2
 - voltage input for NI4, NIO4I, NIO4V, A-4
 - voltage output for NIO4V, NO4V, A-6

- start-up instructions, 2-1
- Step Response, P-6
- system considerations, 4-10

T

- terminal block
 - labeling and installing, 3-12
 - removing, 3-7
- terms, P-2
- Testing Analog Inputs, 5-4
- Testing Analog Outputs, 5-6
- tools needed, 2-1
- troubleshooting, contacting Allen-Bradley, P-9
- Two's Complement Binary Numbers, Positive Decimal Values, B-1, B-2
- Types of Analog Modules
 - 1746-NI4 Analog Input Module, 1-2
 - 1746-NIO4I and NIO4V Analog Combination Modules, 1-2
 - 1746-NIO4I and NO4V Analog Output Modules, 1-2

U

- Update Time, P-6
- using analog, 1-1

V

- Voltage Output Circuit for 1746-NIO4V Modules, D-1

W

- Wiring Considerations
 - Determining the Cable Length, 3-9
 - Grounding Your Cable, 3-9
 - System Wiring Guidelines, 3-8
- Wiring the Analog Module, 3-10



Allen-Bradley, a Rockwell automation business, has been helping its customers improve productivity and quality for more than 90 years. We design, manufacture and support a broad range of automation products worldwide. They include logic processors, power and motion control devices, operator interfaces, sensors and a variety of software. Rockwell is one of the world's leading technology companies.



Worldwide representation.

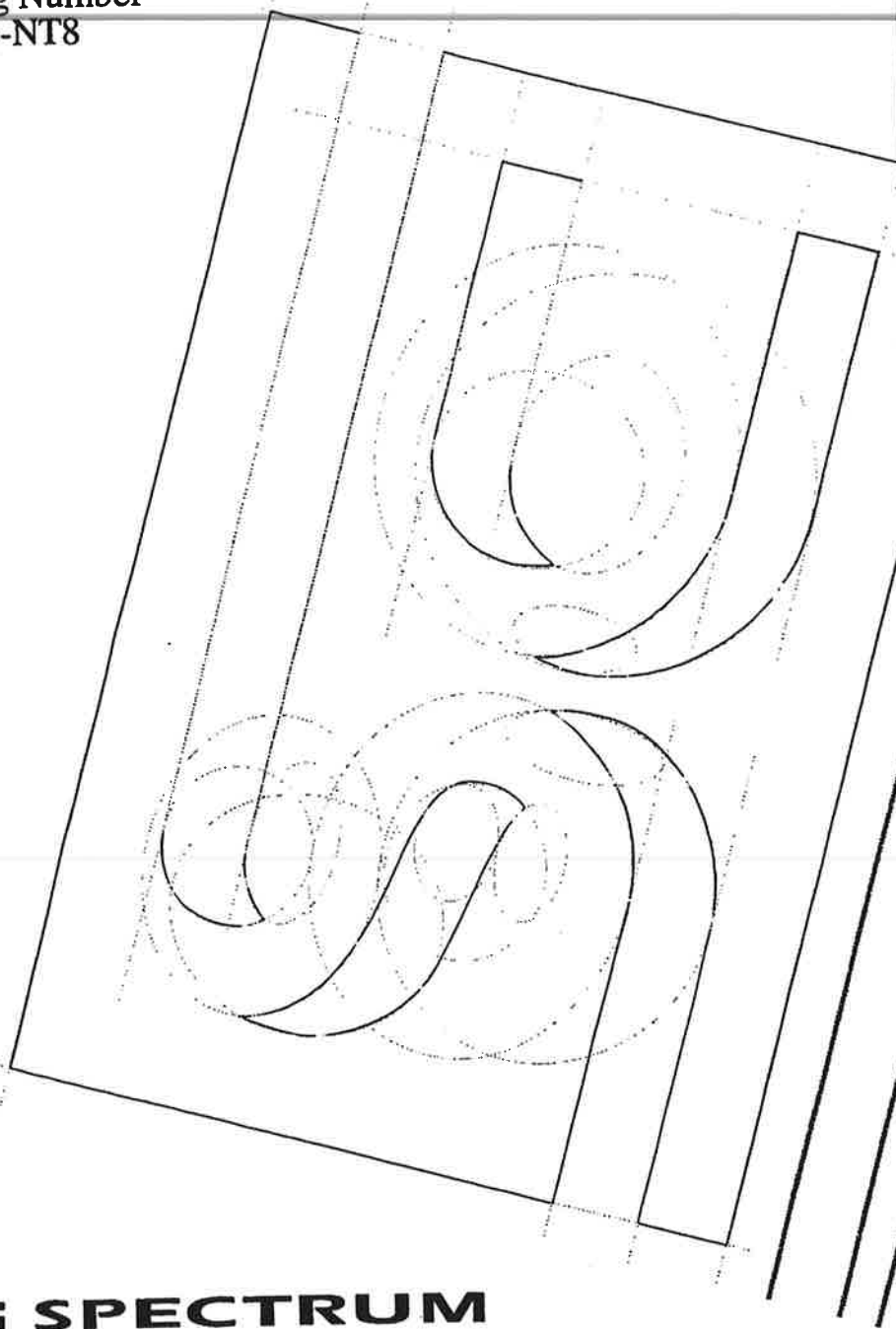
Argentina • Australia • Austria • Bahrain • Belgium • Brazil • Bulgaria • Canada • Chile • China, PRC • Colombia • Costa Rica • Croatia • Cyprus • Czech Republic • Denmark • Ecuador • Egypt • El Salvador • Finland • France • Germany • Greece • Guatemala • Honduras • Hong Kong • Hungary • Iceland • India • Indonesia • Ireland • Israel • Italy • Jamaica • Japan • Jordan • Korea • Kuwait • Lebanon • Malaysia • Mexico • Netherlands • New Zealand • Norway • Pakistan • Peru • Philippines • Poland • Portugal • Puerto Rico • Qatar • Romania • Russia-CIS • Saudi Arabia • Singapore • Slovakia • Slovenia • South Africa, Republic • Spain • Sweden • Switzerland • Taiwan • Thailand • Turkey • United Arab Emirates • United Kingdom • United States • Uruguay • Venezuela • Yugoslavia

Allen-Bradley Headquarters, 1201 South Second Street, Milwaukee, WI 53204 USA, Tel: (1) 414 382-2000 Fax: (1) 414 382-4444

Publication 0300162-03 Rev. D

SLC 500™ THERMOCOUPLE/mV ANALOG INPUT MODULE

Catalog Number
1746sc-NT8



 **SPECTRUM**
CONTROLS

Register Now

To get product updates and faster service.

Just fill out and return the Warranty Registration Card, below. For future reference, you should also write your serial number here:



Warranty Registration Card

Serial Number		Part Number	
Your Name		Title	
Company			SIC code
Street Address		E-Mail Address	
City	State	Zip	
Phone		Fax	
<input type="checkbox"/> User <input type="checkbox"/> OEM <input type="checkbox"/> Systems Integrator <input type="checkbox"/> Other: _____			
Application (and protocol, if applicable)			
Purchased from (Distributor)			Purchase Date

Please help us make our manuals more useful and usable by taking a moment to rate the following statements:

Agree Disagree

- ① ② ③ ④ ⑤ This Owner's Guide provides just the right amount of information.
- ① ② ③ ④ ⑤ It focuses on topics important to me.
- ① ② ③ ④ ⑤ The way it is organized makes it easy to use.
- ① ② ③ ④ ⑤ The layout makes it easy to find what I want.
- ① ② ③ ④ ⑤ The writing is very clear.
- ① ② ③ ④ ⑤ I can find few errors.
- ① ② ③ ④ ⑤ The illustrations are legible and useful.



NO POSTAGE
NECESSARY IF
MAILED IN THE
UNITED STATES



BUSINESS REPLY MAIL

FIRST-CLASS MAIL PERMIT NO. 1086 BELLEVUE, WA

POSTAGE WILL BE PAID BY ADDRESSEE

SPECTRUM CONTROLS, INC.

PRODUCT MARKETING

POST OFFICE BOX 5533

BELLEVUE WA 98006-9924



FOLD ALONG THIS LINE

How can we improve this manual?

Important Notes

1. Read all the information in this guide before installing the product.
2. The information in this owner's guide applies to hardware and software version 1.00 or later.
3. This guide assumes that the reader has a full working knowledge of the relevant processor.

Notice

The products and services described in this owner's guide are useful in a wide variety of applications. Therefore, the user and others responsible for applying the products and services described herein are responsible for determining their acceptability for each application. While efforts have been made to provide accurate information within this owner's guide, Spectrum Controls assumes no responsibility for the accuracy, completeness, or usefulness of the information herein.

Under no circumstances will Spectrum Controls be responsible or liable for any damages or losses, including indirect or consequential damages or losses, arising out of either the use of any information within this owner's guide or the use of any product or service referenced herein.

No patent liability is assumed by Spectrum Controls with respect to the use of any of the information, products, circuits, programming, or services referenced herein.

The information in this owner's guide is subject to change without notice.

Limited Warranty

Spectrum Controls warrants that its products are free from defects in material and workmanship under normal use and service, as described in Spectrum Controls literature covering this product, for a period of 1 year. The obligations of Spectrum Controls under this warranty are limited to replacing or repairing, at its option, at its factory or facility, any product which shall, in the applicable period after shipment, be returned to the Spectrum Controls facility, transportation charges prepaid, and which after examination is determined, to the satisfaction of Spectrum Controls, to be thus defective.

This warranty shall not apply to any such equipment which shall have been repaired or altered except by Spectrum Controls or which shall have been subject to misuse, neglect, or accident. In no case shall the liability of Spectrum Controls exceed the purchase price. The aforementioned provisions do not extend the original warranty period of any product which has either been repaired or replaced by Spectrum Controls.

Preface

Read this preface to familiarize yourself with the rest of the owner's guide. This preface covers:

- who should use this guide
- what this guide provides
- related Allen-Bradley documents
- terms & abbreviations you should know

Who Should Use This Guide

Use this guide if you design, install, program, or maintain a control system that uses Allen-Bradley Small Logic Controllers.

You should have a basic understanding of SLC 500 products. You should also understand electronic process control and the ladder program instructions required to generate the electronic signals that control your application. If you do not, contact your local Allen-Bradley representative for the proper training before using these products.

What This Guide Covers

This guide covers the 1746sc-NT8 thermocouple/millivolt analog input module. It contains the information you need to install, wire, use, and maintain these modules. It also provides diagnostic and troubleshooting help should the need arise.

Related Allen-Bradley Documents

Table A lists several Allen-Bradley documents that may help you as you use these products.

Table A. Related Allen-Bradley documentation

Allen-Bradley Doc. No.	Title
1747-2.30	SLC 500 System Overview
SGL-1.1	Application Considerations for Solid State Controls
1770-4.1	Allen-Bradley Programmable Controller Grounding and Wiring Guidelines
1747-6.2	Installation & Operation Manual for Modular Hardware Style Programmable Controllers
1747-NI001	Installation & Operation Manual for Fixed Hardware Style Programmable Controllers
1747-6.4	Allen-Bradley Advanced Programming Software (APS) User Manual
1747-6.11	Allen-Bradley Advanced Programming Software (APS) Reference Manual
1747-6.3	Getting Started Guide for Advanced Programming Software (APS)
ABT-1747-TSG001	SLC 500 Software Programmers's Quick Reference Guide
1747-NP002	Allen-Bradley HHT (Hand-Held Terminal) User Manual
1747-NM009	Getting Started Guide for HHT (Hand-Held Terminal)
SD499	Allen-Bradley Publication Index
AG-7.1	Allen-Bradley Industrial Automation Glossary

To obtain a copy of any of the Allen-Bradley documents listed, contact your local Allen-Bradley office or distributor.

Terms & Abbreviations You Should Know

You should understand the following terms and abbreviations before using this guide.

A/D – Refers to analog-to-digital conversion. The conversion produces a digital value whose magnitude is proportional to the instantaneous magnitude of an analog input signal.

Attenuation – The reduction in magnitude of a signal as it passes through a system. The opposite of gain.

Channel – Refers to one of eight, small-signal analog input interfaces to the modules's terminal block. Each channel is configured for connection to a thermocouple or DC millivolt (mV) input device, and has its own configuration and status words.

Chassis – A hardware assembly that houses devices such as I/O modules, adapter modules, processor modules, and power supplies.

CJC – (Cold Junction Compensation) The means by which the module compensates for the offset voltage error introduced by the temperature at the junction between the thermocouple lead wire and the input terminal block (the cold junction).

Common mode rejection ratio (CMRR) – The ratio of a device's differential voltage gain to common mode voltage gain. Expressed in dB, CMRR is a comparative measure of a device's ability to reject interference caused by a voltage common to its terminal relative to ground.

Common mode voltage – The voltage difference between the negative terminal and analog common during normal differential operation.

Configuration word – Contains the channel configuration information needed by the module to configure and operate each channel. Information is written to the configuration word through the logic supplied in your ladder program.

Cut-off frequency – The frequency at which the input signal is attenuated 3 dB by the digital filter. Frequency components of the input signal that are below the cut-off frequency are passed with under 3 dB of attenuation for low-pass filters.

dB (decibel) – A logarithmic measure of the ratio of two signal levels.

Data word – A 16-bit integer that represents the value of the analog input channel. The channel data word is valid only when the channel is enabled and there are no channel errors.

Digital filter – A low-pass filter of the A/D converter. The digital filter provides high-frequency noise rejection.

Effective resolution – The number of bits in the channel data word that do not vary due to noise.

Full-scale error (gain error) – The difference in slope between the actual and ideal analog transfer functions.

Full-scale range (FSR) – The difference between the maximum and minimum specified analog values.

Gain drift – The change in full-scale transition voltage measured over the operating temperature range of the module.

Input data scaling – Depends on the data format that you select for the channel data word. You can select from scaled-for-PID or Engineering Units for millivolt, thermocouple, or CJC inputs, which you must compute to fit your application's temperature or voltage resolution.

Local system – A control system with I/O chassis within several feet of the processor, and using 1746sc-C7 or 1746-C9 ribbon cable for communication.

LSB (least significant bit) – The bit that represents the smallest value within a string of bits. The “weight” of this value is defined as the full-scale range divided by the resolution.

Multiplexer – A switching system that allows several input signals to share a common A/D converter.

Normal mode rejection (differential mode rejection) – A logarithmic measure, in dB, of a device’s ability to reject noise signals between or among circuit signal conductors, but not between the equipment grounding conductor or signal reference structure and the signal conductors.

Remote system – A control system where the chassis can be located several thousand feet from the processor chassis. Chassis communication is via the 1747-SN Scanner and 1747-ASB Remote I/O Adapter.

Resolution – The smallest detectable change in a measurement, typically expressed in engineering units (e.g. 0.15C) or as number of bits. For example, a 12-bit value has 4,096 possible counts. It can therefore be used to measure 1 part in 4096.

Sampling time – The time required by the A/D converter to sample an input channel.

Status word – Contains status information about the channel’s current configuration and operational state. You can use this information in your ladder program to determine whether the channel data word is valid.

Step response time – The time required for the A/D signal to reach 95% of its expected, final value, given a full-scale step change in the input signal.

Update time – The time for the module to sample and convert a channel input signal and make the resulting value available to the SLC processor.

Table Of Contents

Preface

Who Should Use This Guide	i
What This Guide Covers	i
Related Allen-Bradley Documents	ii
Terms & Abbreviations You Should Know	ii

Module Overview

Chapter 1

General Description	1
System Overview	2
Block Diagram	5

Installing And Wiring Your Module

Chapter 2

Electrostatic Damage	7
Power Requirements	7
Selecting A Rack Slot	8
Module Installation and Removal	9
Wiring Your Module	11

Things To Consider Before Using Your Module

Chapter 3

Module ID Code	17
Module Addressing	17
Channel Filter Frequency Selection	19
Update Time	23
Auto-calibration	24
Channel Turn-On, Turn-Off, and Reconfiguration Times	24
Response to Slot Disabling	24

Channel Configuration, Data, and Status

Chapter 4

Channel Configuration	27
Channel Configuration Procedure	28
Channel Data/Status Word	36
Channel Status Checking	37

Programming Examples

Chapter 5

Initial Programming	41
Dynamic Programming	42
Verifying Channel Configuration Changes	44
Interfacing to the PID Instruction	46
Monitoring Channel Status Bits	47

Testing Your Module**Chapter 6**

Module and Channel Diagnostics	53
LED Indicators	54
Interpreting I/O Error Codes	56

**Maintaining Your Module
And Ensuring Safety****Chapter 7**

Preventive Maintenance	59
Safety Considerations	59

Appendices

Appendix A: Module Specifications	63
Electrical Specifications	63
Physical Specifications	63
Environmental Specifications	64
Input Specifications	64
Appendix B: Thermocouple Descriptions	71
Type J Thermocouples	71
Type K Thermocouples	73
Type T Thermocouples	75
Type E Thermocouples	77
Type R Thermocouples	79
Type S Thermocouples	80
Type B Thermocouples	82
Type N Thermocouples	83
References	86
Appendix C: Using Grounded Junction, Ungrounded Junction, and Exposed Thermocouples	93
Thermocouple Types	93
Isolation	94

Index

.....	97
-------	----

Figures

Figure 1. Module insertion into a rack	9
Figure 2. Terminal block diagram with CJC sensors	10
Figure 3. Ferrite EMI suppressor for CE compliance	13
Figure 4. Terminal block diagram with thermocouple cable	14
Figure 5. Image table	18
Figure 6. Signal attenuation with 10 Hz input filter	21
Figure 7. Signal attenuation with 50 Hz input filter	21
Figure 8. Signal attenuation with 60 Hz input filter	22
Figure 9. Signal attenuation with 250 Hz input filter	22
Figure 10. Channel configuration	41
Figure 11. Initial programming example	42
Figure 12. Data table for initial programming	42
Figure 13. Dynamic programming example	43
Figure 14. Data table for dynamic programming	44
Figure 15. Programming for configuration changes example	45
Figure 16. Data table for configuration changes	45
Figure 17. Programming for PID Control Example	46

Tables

Figure 18. Data table for PID Control	47
Figure 19. Monitoring channel status bits example	48
Figure 20. Data table for monitoring channel status bits	49
Figure 21. Troubleshooting Flowchart	55
Table A. Related Allen-Bradley documentation	ii
Table 1. Thermocouple Temperature Ranges	1
Table 2. Millivolt Input Ranges	2
Table 3. Hardware Features	2
Table 4. Recommendations to minimize interference from radiated electrical noise	4
Table 5. Maximum current drawn by the module	8
Table 6. Cut-off frequency, step response time, and effective resolution (based on filter frequency)	20
Table 7. Channel Sampling Time	23
Table 8. Auto-calibration	24
Table 9. Channel Configuration Word -	30
Table 10. Channel Data Word Format	33
Table 11. Channel Data Word Resolution	34
Table 12. Channel 0-7 Status Word (I:e.0 through I:e.7) - Bit Definitions ..	38
Table 13. Module-status LED	54
Table 14. Module-status and Channel-status LED	54



Module Overview

This chapter describes the thermocouple/millivolt input module and explains how the SLC controller reads thermocouple or millivolt analog input data from the module.

Read this chapter to familiarize yourself further with your thermocouple / mV analog input module. This chapter covers:

- general description and hardware features
- an overview of system and module operation
- block diagram of channel input circuits

General Description

This module is designed exclusively to mount into Allen-Bradley 1746 I/O racks for use with Allen-Bradley SLC 500 fixed and modular systems. The module stores digitally converted thermocouple and/or millivolt (mV) analog data in its image table for retrieval by all fixed and modular SLC 500 processors. The module supports connections from any combination of up to eight thermocouple and/or mV analog sensors.

Input Ranges

The following tables define thermocouple types and associated temperature ranges and the millivolt analog input signal ranges that each of the module's input channels will support. To determine the practical temperature range of your thermocouple, refer to the specifications in appendix A.

Table 1. Thermocouple Temperature Ranges

Type	°C Temperature Range	°F Temperature Range
J	-210°C to 760°C	-346°F to 1400°F
K	-270°C to 1370°C	-454°F to 2498°F
T	-270°C to 400°C	-454°F to 752°F
B	300°C to 1820°C	572°F to 3308°F
E	-270°C to 1000°C	-454°F to 1832°F
R	0°C to 1768°C	32°F to 3214°F
S	0°C to 1768°C	32°F to 3214°F
N	0°C to 1300°C	32°F to 2372°F
CJC Sensor	-25°C to 105°C	-13°F to 221°F

Table 2. Millivolt Input Ranges

-50 to +50 mV
-100 to +100 mV

Each input channel is individually configurable for a specific input device, and provides open-circuit, over-range, and under-range detection and indication.

Hardware Features

The module fits into any single slot for I/O modules in either an SLC 500 modular system or an SLC 500 fixed system expansion chassis (1746-A2). It is a Class 1¹ module (uses 8 input words and 8 output words).

¹ Requires use of Block Transfer in a remote configuration.

The module contains a removable terminal block providing connections for eight thermocouple and /or analog input devices. There are two cold-junction compensation (CJC) sensors that compensate for the cold junction at ambient temperature rather than at freezing (0°C). There are no output channels on the module. You configure the module with software rather than with jumpers or switches.

Table 3. Hardware Features

Hardware	Function
Channel Status LED Indicators	Display operating and fault status of channels 0-7
Module Status LED	Displays operating and fault status of the module
Side Label (Nameplate)	Provides module information
Removable Terminal Block	Provides electrical connection to input devices
Door Label	Permits easy terminal identification
Self Locking Tabs	Secure module in chassis slot

Diagnostic LEDs

The module contains diagnostic LEDs that help you identify the source of problems that may occur during power-up or during normal operation. Power-up and channel diagnostics are explained in Chapter 6, *Testing Your Module*.

System Overview

The module communicates with the SLC 500 processor and receives +5 Vdc and +24 Vdc power from the system power supply through the parallel backplane interface. No external power supply is required. You may install as many thermocouple modules in the system as the power supply can support.

Each module channel can receive input signals from a thermocouple or a mV analog input device. You configure each channel to accept either one. When configured for thermocouple input types, the module converts analog input voltages into cold-junction compensated and linearized, digital temperature readings. The module uses the National Institute of Standards and Technology (NIST) based on ITS-90 for thermocouple linearization.

When configured for millivolt analog inputs, the module converts analog values directly into digital counts. The module assumes that the mV input signal is linear prior to input to the module.

System Operation

At power-up, the module checks its internal circuits, memory, and basic functions. During this time the module status LED remains off. If the module finds no faults, it turns on its module status LED.

After completing power-up checks, the module waits for valid channel configuration data from your SLC ladder logic program (channel status LEDs are off). After channel configuration data is transferred and channel enable bits are set for one or more channels, the module turns on its channel status LEDs. Then it continuously converts the thermocouple or millivolt input to a value within the range you selected for the channel.

Each time the module reads an input channel, the module tests that data for a fault, i.e. over-range, or under-range condition. If open-circuit detection is enabled, the module tests for an open circuit condition. If it detects an open-circuit, over-range, or under-range condition, the module sets a unique bit in the channel status word and causes the channel status LED to blink.

The SLC processor reads the converted thermocouple or millivolt data from the module at the end of the program scan, or when commanded by the ladder program. After the processor and module determine that the data transfer was made without error, the data can be used in your ladder program.

Module Operation

The module's input circuitry consists of eight differential analog inputs, multiplexed into an A/D convertor. The A/D convertor reads the analog input signals and converts them to digital counts. The input circuitry also continuously samples the CJC sensors and compensates for temperature changes at the cold junction (terminal block). The module can be used with remote CJC sensor inputs. The sensors must be Analog Devices AD592CN temperature transducers to meet the accuracy specifications of the module. The module will not accept other CJC sensor inputs and thermocouple inputs will not function properly if incorrect CJC sensors are used.

Module Addressing

The module requires eight words each in the SLC processor's input and output image tables. Addresses for the module in slot e are as follows:

I:e.0-7 thermocouple/mV or status data for channels 0-7, respectively

O:e.0-7 configuration data for channels 0-7, respectively.

Compatibility with Thermocouple and Millivolt Devices & Cables

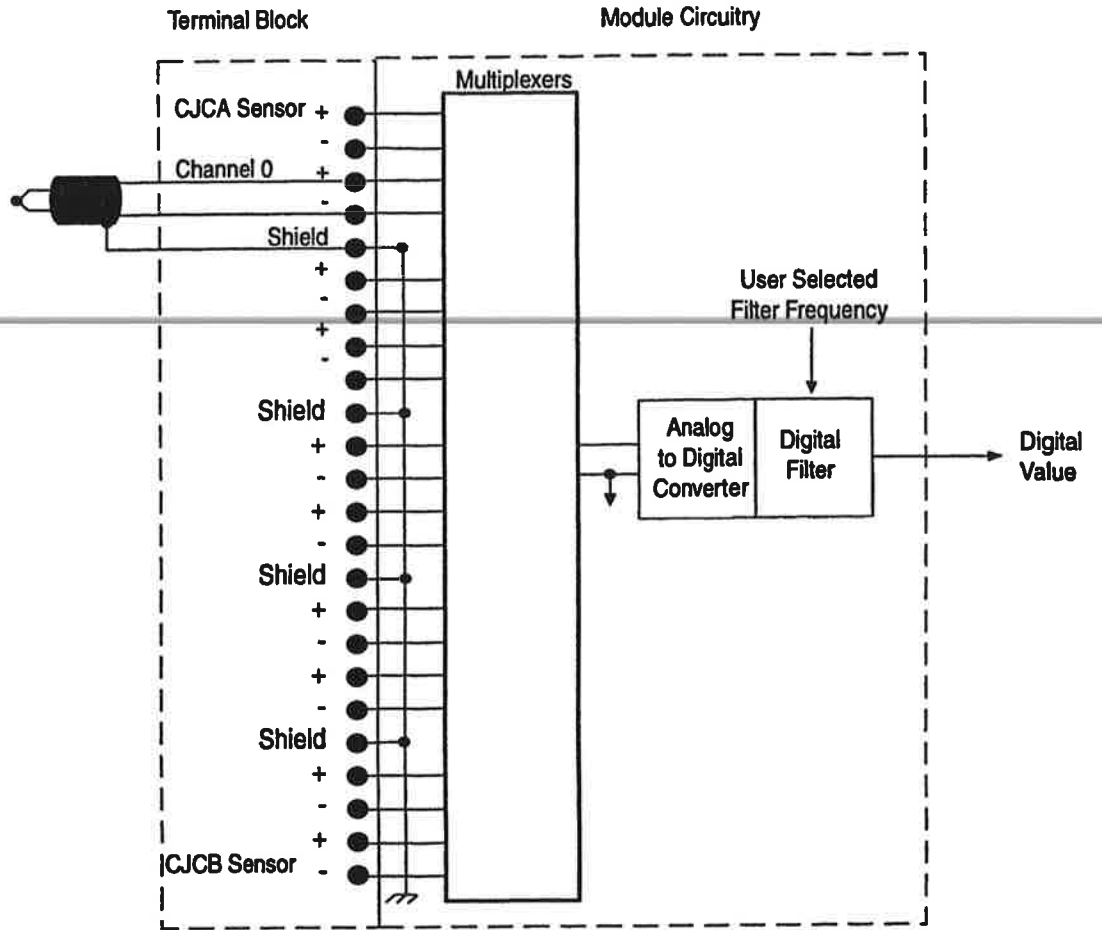
The module is compatible with the following standard types of thermocouples: B, E, J, K, N, R, S, and T and extension wire. Refer to appendices B and C for details. The module is also compatible with a variety of mV devices with an output of ± 50 or ± 100 mV.

To minimize interference from radiated electrical noise, we recommend twisted-pair and highly shielded cables such as the following:

Table 4. Recommendations to minimize interference from radiated electrical noise

For This Type of Device	We Recommend This Cable (or equivalent)
Thermocouple Type J	EIL Corp. J20-5-502
Thermocouple Type K	EIL Corp. K20-5-510
Thermocouple Type T	EIL Corp. T20-5-502
Other Thermocouple Types	consult with EIL Corp or other manufacturers
mV devices	Belden 8761, shielded, twisted-pair

Block Diagram





Installing And Wiring Your Module

Read this chapter to install and wire your module. This chapter covers:

- avoiding electrostatic damage
- determining power requirements
- installing the module
- wiring signal cables to the module's terminal block

Electrostatic Damage

Electrostatic discharge can damage semiconductor devices inside this module if you touch backplane connector pins. Guard against electrostatic damage by observing the following precautions:



CAUTION

ELECTROSTATICALLY SENSITIVE COMPONENTS

- Before handling the module, touch a grounded object to rid yourself of electrostatic charge.
- When handling the module, wear an approved wrist strap grounding device.
- Handle the module from the front, away from the backplane connector. Do not touch backplane connector pins.
- Keep the module in its static-shield container when not in use or during shipment.

Failure to observe these precautions can degrade the module's performance or cause permanent damage.

Power Requirements

The module receives its power through the SLC-500 chassis backplane from the fixed or modular +5 VDC/+24 VDC chassis power supply. The maximum current drawn by the module is shown in the table below.

Table 5. Maximum current drawn by the module

5VDC Amps	24VDC Amps
0.120	0.070

When using the module in a *modular system*, add the values shown above to the requirements of all other modules in the SLC to prevent overloading the chassis power supply.

When using the module in a *fixed controller*, be sure not to exceed the power supply rating for the 2-slot I/O chassis.

Considerations for a Modular System

Place your module in any slot of an SLC-500 modular, or modular expansion chassis, except for the left-most slot (slot 0) reserved for the SLC processor or adapter modules.

Considerations for a Fixed Controller

The power supply in the 2-slot SLC 500 fixed I/O chassis (1746-A2) can support only specific combinations of modules. Make sure the chassis power supply can support the NT8 and additional module power requirements.

Selecting A Rack Slot

Two factors determine where you should install your module in the rack: ambient temperature and electrical noise. When selecting a slot for your module, try to position your module:

- in a rack close to the bottom of the enclosure (where the air is cooler)
- away from modules that generate significant heat, such as 32-point input/output modules
- in a slot away from ac or high-voltage dc modules, hard contact switches, relays, and ac motor drives
- away from the rack power supply (if using a modular system)

Remember that in a modular system, the processor always occupies the first slot of the rack.

Module Installation and Removal



CAUTION

POSSIBLE EQUIPMENT OPERATION

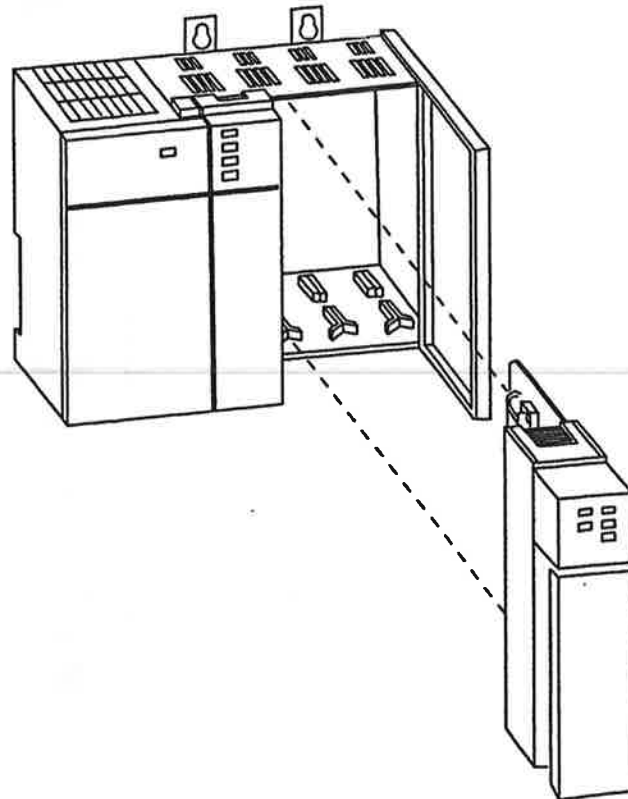
Before installing or removing your module, always disconnect power from the SLC 500 system and from any other source to the module (in other words, don't "hot swap" your module), and disconnect any devices wired to the module.

Failure to observe this precaution can cause unintended equipment operation and damage.

To insert your module into the rack, follow these steps:

1. Align the circuit board of your module with the card guides at the top and bottom of the chassis.

Figure 1. Module insertion into a rack



2. Slide your module into the chassis until both top and bottom retaining clips are secure. Apply firm even pressure on your module to attach it to its backplane connector. Never force your module into the slot.

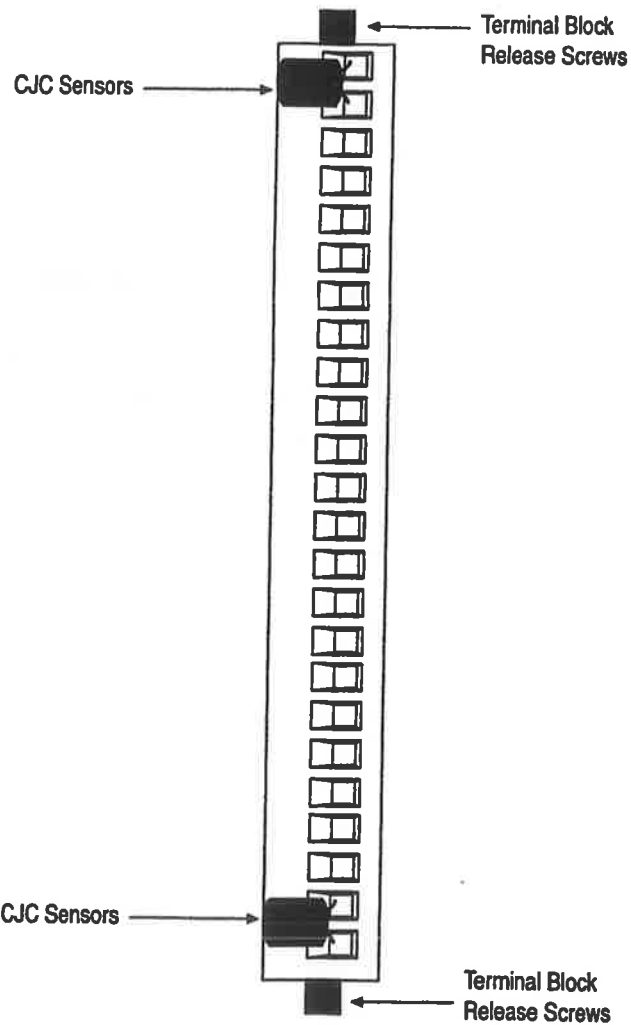
Cover all unused slots with the Card Slot Filler, Allen-Bradley part number 1746-N2.

Terminal Block Removal

To remove the terminal block:

1. Loosen the two terminal block release screws. To avoid cracking the terminal block, alternate between screws as you remove them.
2. Using a screwdriver or needle-nose pliers, carefully pry the terminal block loose. When removing or installing the terminal block be careful not to damage the CJC sensors.

Figure 2. Terminal block diagram with CJC sensors



**CAUTION****POSSIBLE EQUIPMENT OPERATION**

Before wiring your module, always disconnect power from the SLC 500 system and from any other source to the module.

Failure to observe this precaution can cause unintended equipment operation and damage.

Wiring Your Module

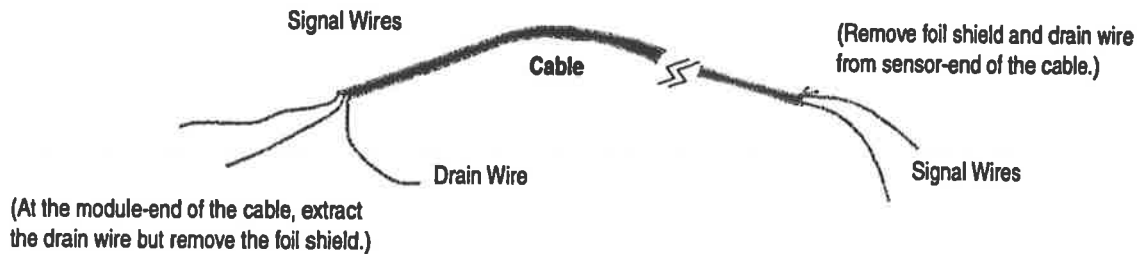
Follow these guidelines to wire your input signal cables:

- Power, input, and output (I/O) wiring must be in accordance with Class 1, Division 2 wiring methods [Article 501-4(b) of the National Electrical Code, NFPA 70] and in accordance with the authority having jurisdiction.
- Route the field wiring away from any other wiring and as far as possible from sources of electrical noise, such as motors, transformers, contactors, and ac devices. As a general rule, allow at least 6 in. (about 15.2 cm) of separation for every 120 V of power.
- Routing the field wiring in a grounded conduit can reduce electrical noise further.
- If the field wiring must cross ac or power cables, ensure that they cross at right angles.
- To limit the pickup of electrical noise, keep thermocouple and millivolt signal wires as far from power and load lines as possible.
- For high immunity to electrical noise, use Belden 8761 (shielded, twisted pair) or equivalent wire for millivolt sensors; or use shielded, twisted pair thermocouple extension lead wire specified by the thermocouple manufacturer. Using the incorrect type of thermocouple extension wire or not following the correct polarity may cause invalid readings.
- Ground the shield drain wire at only one end of the cable. The preferred location is at the shield connections on the terminal block. (Refer to IEEE Std. 518, Section 6.4.2.7 or contact your sensor manufacturer for additional details.)
- Keep all unshielded wires as short as possible.
- Tighten screw terminals with care. Excessive tightening can strip a screw.

- Follow system grounding and wiring guidelines found in your SLC 500 Installation and Operation Manual.

Preparing and Wiring the Cables

To prepare and connect cable leads and drain wires, follow these steps:



1. At each end of the cable, strip some casing to expose individual wires.
2. Trim signal wires to 5-inch lengths beyond the cable casing. Strip about 3/16 inch (4.76 mm) of insulation to expose the ends of the wires.
3. At the module-end of the cables (Figure 3.1):
 - extract the drain wire and signal wires
 - remove the foil shield
 - bundle the input cables with a cable strap
4. Connect pairs of drain wires together, Channels 0 and 1, Channels 2 and 3, Channels 4 and 5, Channels 6 and 7. Keep drain wires as short as possible.
5. Connect the drain wires to the shield inputs of the terminal block.
 - Channel 0 and 1 drain wires to pin 5
 - Channel 2 and 3 drain wires to pin 10
 - Channel 4 and 5 drain wires to pin 15
 - Channel 6 and 7 drain wires to pin 20
6. Connect the signal wires of each channel to the terminal block.

Important: Only after verifying that your connections are correct for each channel, trim the lengths to keep them short. Avoid cutting leads too short.
7. Connect TB1 chassis ground connector to the nearest chassis mounting bolt with 14 gauge wire. (Looking at the face of the module, TB1 is near the lower part of the terminal block on the primary side of the PCB.)

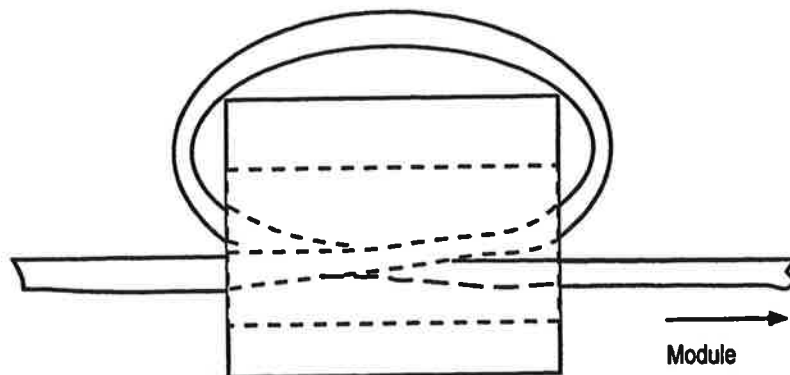
8. At the source-end of cables from mV devices:

- remove the drain wire and foil shield
- apply shrink wrap as an option
- connect to mV devices keeping the leads short

Important: If noise persists, try grounding the opposite end of the cable, instead (Ground one end only.)

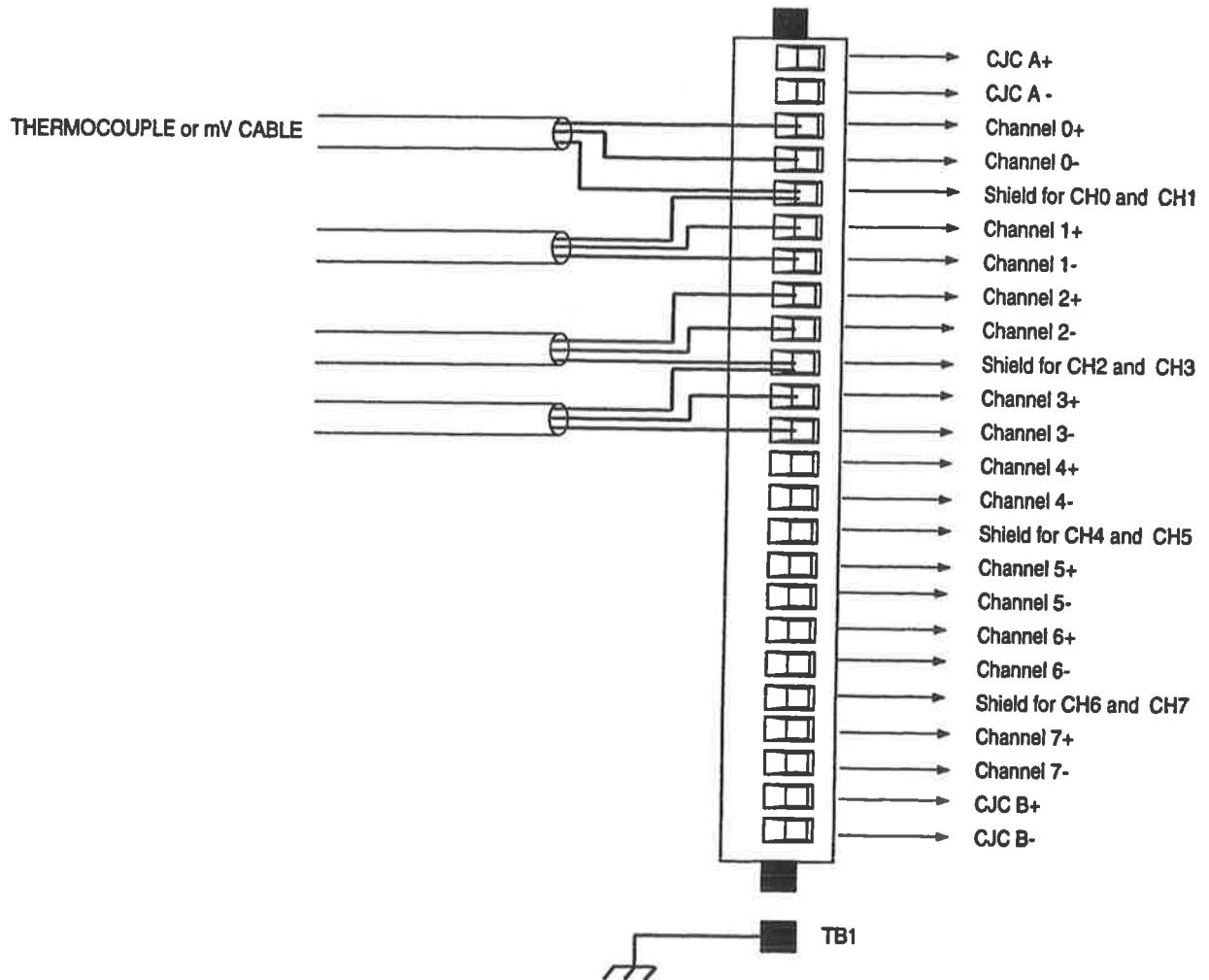
Important: For CE compliance, Ferrite EMI Suppressors are needed on each channel's terminal block connection. If remote CJC's are installed, shielded wire must be used and a Ferrite EMI suppressor is needed on each CJC input connection. The drain wire of the CJC cable must be connected to a shield connection at the module. Apply the suppressor close to the module terminal block, as shown below. A Steward Part 28B2024-0A0 or equivalent is recommended. The Steward 28B2024-0A0 has an impedance of 157Ω at 25 MHz, 256Ω at 100 MHz, and can accommodate one turn of wire.

Figure 3. Ferrite EMI suppressor for CE compliance



Note: Please refer to Appendix C for additional information on wiring and using grounded junction, ungrounded junction and exposed junction thermocouple types.

Figure 4. Terminal block diagram with input cable



The module also has a ground terminal TB1 which should be grounded to a chassis mounting bolt with 14 gauge wire.

Cold Junction Compensation (CJC)



CAUTION

POSSIBLE EQUIPMENT OPERATION

Do not remove or loosen the cold junction compensating temperature transducers located on the terminal block unless you are connecting remote CJC's to the module. Both CJC's are critical to ensure accurate thermocouple input readings at each channel. The module will not operate in thermocouple mode if a CJC is not connected.

Failure to observe this precaution can cause unintended equipment operation and damage.

To obtain accurate readings from each of the channels, the cold junction temperature (temperature at the module's terminal junction between the thermocouple wire and the input channel) must be compensated for. Two cold junction compensating sensors have been integrated in the removable terminal block. They must remain installed to retain accuracy. If remote CJC compensation is desired, the sensors at the terminal block must be removed and the external sensors wired to the CJCA and CJCB terminals. The remote CJC sensors must be Analog Devices AD592CN T0-92 style temperature transducer devices. The module will not function with any other CJC sensor connected.



Things To Consider Before Using Your Module

This chapter explains how the module and the SLC processor communicate through the processor's I/O image tables. It also describes the module's input filter characteristics. Topics discussed include:

- module ID code
- module addressing
- channel filter frequency selection
- Channel turn-on, turn-off, and reconfiguration times
- response to slot disabling

Module ID Code

The module ID code is unique number assigned to each type of 1746 I/O module. The ID defines for the processor the type of I/O module and the number of words used in the processor's I/O image table.

With APS software, use the system I/O configuration display to manually enter the module ID when assigning the slot number during the configuration. Do this by selecting (other) from the list of modules on the system I/O configuration display and enter 3533, the ID code for the 1746sc-NT8.

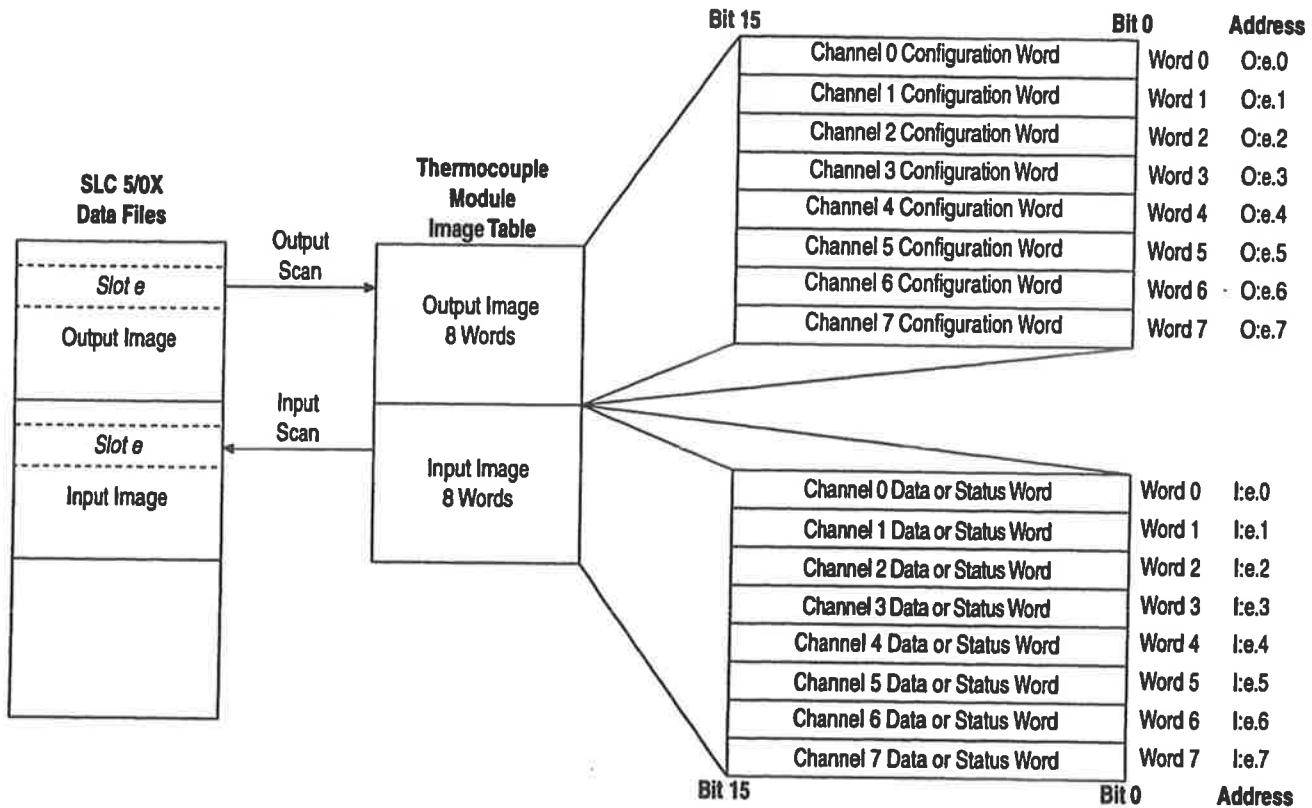
No special I/O configuration (SPIO CONFIG) is required. The module ID automatically assigns the correct number of input and output words.

If you are using different programming software package, refer to the documentation that came with your software.

Module Addressing

The following memory map shows you how the SLC processor's output and input tables are defined for the module.

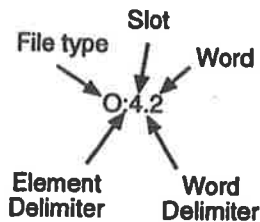
Figure 5. Image table



Output Image - Configuration Words

Eight words of the SLC processor’s output image table are reserved for the module. Output image words 0-7 are used to configure the module’s input channels 0-7. Each output image word configures a single channel, and can be referred to as a configuration word. Each word has a unique address based on the slot number assigned to the module.

Example Address - If you want to configure channel 2 on the module located in slot 4 in the SLC chassis, your address would be O:4.2.



Chapter 4, *Channel Configuration, Data, and Status*, gives you detailed bit information about the data content of the configuration word.

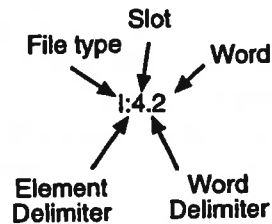
Input Image - Data Words and Status Words

Eight words of the SLC processor's input image table are reserved for the module. Input image words are multiplexed since each channel has one data word and one status word. The corresponding configuration word selects whether the channel status or channel data is in the input image word.

Status bits for a particular channel reflect the configuration settings that you entered into the configuration (output image) word for that channel. To receive valid status, the channel must be enabled and the module must have stored a valid configuration word for that channel.

Each input image word has a unique address based on the slot number assigned to the module.

Example Address - To obtain the status/data word of channel 2 (input word 2) of the module located in slot 4 in the SLC chassis use address I:4:2.



Chapter 4, *Channel Configuration, Data, and Status*, gives you detailed bit information about the content of the data word and the status word.

Channel Filter Frequency Selection

The thermocouple module uses a digital filter that provides high frequency noise rejection for the input signals. The digital filter is programmable, allowing you to select from four filter frequencies for each channel. The digital filter provides the highest noise rejection at the selected filter frequency. The graphs to follow show the input channel frequency response for each filter frequency selection.

Selecting a low value (i.e. 10 Hz) for the channel filter frequency provides the best noise rejection for a channel, but it also increases the channel update time. Selecting a high value for the channel filter frequency provides lower noise rejection, but decreases the channel update time.

The following table shows the available filter frequencies, cut-off frequency, step response, and ADC effective resolution for each filter frequency.

Table 6. Cut-off frequency, step response time, and effective resolution (based on filter frequency)

Filter Frequency	Cut-Off Frequency	Step Response	ADC Effective Resolution
10 Hz	2.62 Hz	400 ms	20.5
50 Hz	13.1 Hz	80 ms	19.0
60 Hz	15.72 Hz	66.7 ms	19.0
250 Hz	65.5 Hz	16 ms	15.5

The step response is calculated by a $4 \times (1/\text{filter frequency})$ settling time.

Channel Cut-Off Frequency

The channel filter frequency selection determines a channel's cut-off frequency, also called the -3 dB frequency. The cut-off frequency is defined as the point on the input channel frequency response curve where frequency components of the input signal are passed with 3 dB of attenuation. All frequency components at or below the cut-off frequency are passed by the digital filter with less than 3 dB of attenuation. All frequency components above the cut-off frequency are increasingly attenuated, as shown in the graphs below.

The cut-off frequency for each input channel is defined by its filter frequency selection. The table above shows the input channel cut-off frequency for each filter frequency. Choose a filter frequency so that your fastest changing signal is below that of the filter's cut-off frequency. The cut-off frequency should not be confused with update time. The cut-off frequency relates how the digital filter attenuates frequency components of the input signal. The update time defines the rate at which an input channel is scanned and its channel data word updated.

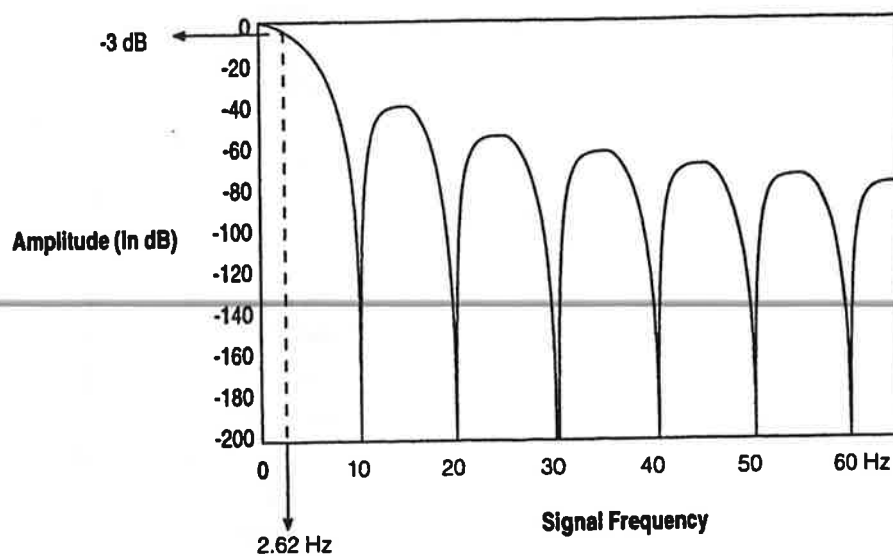
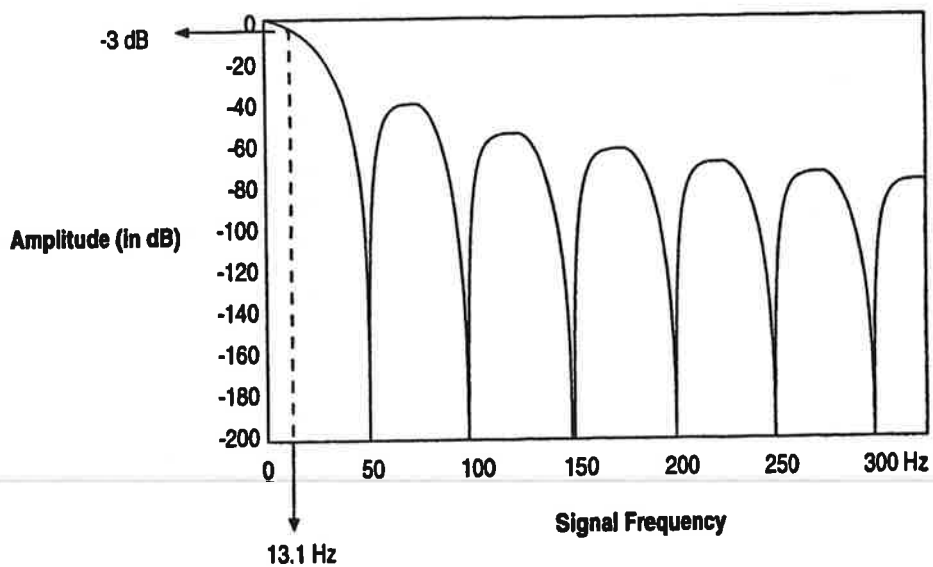
Figure 6. Signal attenuation with 10 Hz input filter**Figure 7. Signal attenuation with 50 Hz input filter**

Figure 8. Signal attenuation with 60 Hz input filter

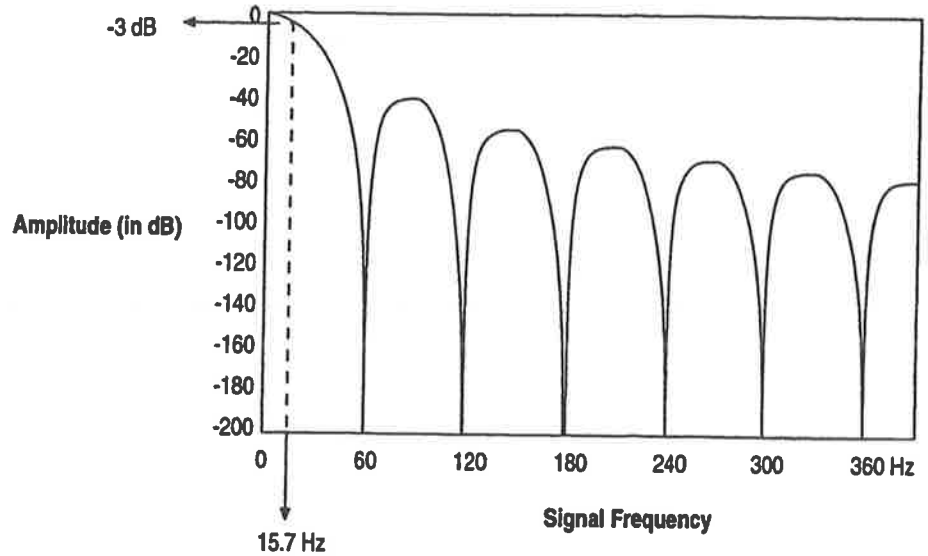
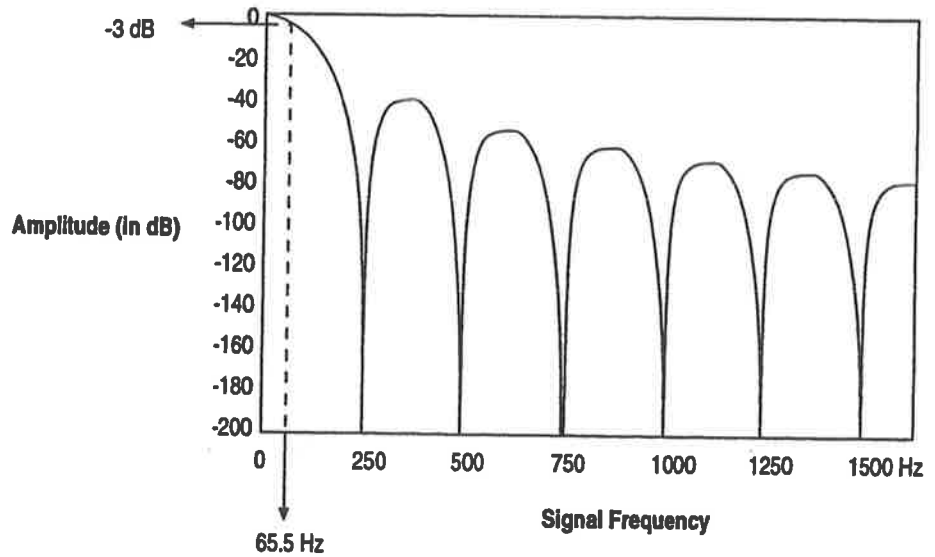


Figure 9. Signal attenuation with 250 Hz input filter

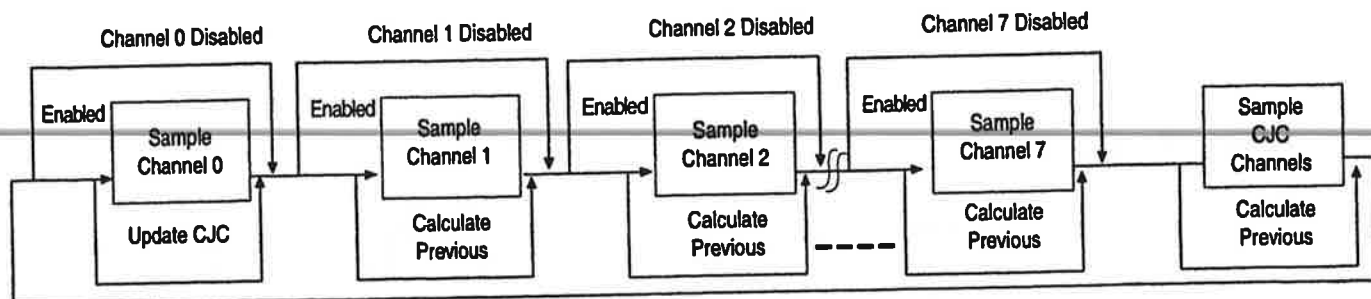


Channel Step Response

The channel filter frequency determines the channel's step response. The step response is time required for the analog input signal to reach 95% of its expected, final value given a full-scale step change in the input signal. This means that if an input signal changes faster than the channel step response, a portion of that signal will be attenuated by the channel filter. Table 6 shows the step response for each filter frequency.

Update Time

The thermocouple module update time is defined as the time required for the module to sample and convert the input signals of all enabled input channels and make the resulting data values available to the SLC processor. It can be calculated by adding the sum of all enabled sample times, plus a CJC update time.



The following table shows the channel sampling time for each filter frequency. It also gives the CJC update time.

Table 7. Channel Sampling Time

Channel Sampling Time for Each Filter Frequency (all values ± 1 msec)

Channel Sampling Time				
CJC Update Time	250 Hz Filter	60 Hz Filter	50 Hz Filter	10 Hz Filter
290 msec	66 msec	125 msec	140 msec	470 msec

The times above include a settling time necessary between input channel readings. The sampling times for filter frequencies listed do NOT include a 45 msec open circuit detection time utilized when the channel is configured for open-circuit detection. CJC open-circuit detection does not require the additional 45 msec settling time.

The fastest module update time occurs when only one channel with a 250 Hz filter frequency is enabled.

$$\text{Module update time} = 290 \text{ msec} + 66 \text{ msec} = 356 \text{ msec}$$

The slowest module update time occurs when eight channels, each using a 10 Hz filter frequency, are enabled.

$$\text{Module update time} = 290 \text{ msec} + 470 \text{ msec} + 470 \text{ msec} + 470 \text{ msec} + 470 \text{ msec} + 470 \text{ msec} + 470 \text{ msec} + 470 \text{ msec} = 4.05 \text{ sec}$$

Update Time Calculation Example

The following example shows how to calculate the module update time for the given configuration:

Channel 0 configured for 250 Hz filter frequency, enabled
 Channel 1 configured for 250 Hz filter frequency, enabled
 Channel 2 configured for 50 Hz filter frequency, enabled
 Channel 3 through 7 disabled

Using the values from the table above, add the sum of all enabled channel sample times, plus one CJC update time.

Channel 0 sampling time	= 66 msec
Channel 1 sampling time	= 66 msec
Channel 2 sampling time	= 140 msec
CJC update time	= 290 msec
Module update time	= 562 msec

Channel Turn-On, Turn-Off, and Reconfiguration Times

The time required for the module to recognize a new configuration for a channel is generally one module update time plus 890 μ sec per newly configured channel. If the filter frequency selected for the newly enabled, configured channel is new to the module, then auto-calibration will be performed following configuration recognition.

Turn-off time requires up to one module update time.

Reconfiguration time is the same as turn-on time.

Auto-Calibration

Auto-calibration is performed by the module to correct for drift errors over temperature. Auto-calibration occurs immediately following configuration of a previously unselected filter frequency, and generally every two minutes for all selected filter frequencies of the system. The time required to perform auto-calibration is defined as follows:

Table 8. Auto-calibration Time

250 Hz Filter	60 Hz Filter	50 Hz Filter	10 Hz Filter
325 msec	525 msec	585 msec	1.975 s

CJC sensors are acquired at 60 Hz to maximize the trade-offs between resolution and update rate. For example, if some channels are acquired at 250 Hz and some are acquired at 50 Hz, then the total auto-calibration time would be:

250 Hz	325 msec
60 Hz	525 msec
50 Hz	<u>585 msec</u>
	1.435 sec

During auto-calibration, input values are not updated.

Response to Slot Disabling

By writing to the status file in the modular SLC processor, you can disable any chassis slot. Refer to your SLC programming manual for the slot disable/enable procedure.

**CAUTION****POSSIBLE EQUIPMENT OPERATION**

Always understand the implications of disabling a module before using the slot disable feature.

Failure to observe this precaution can cause unintended equipment operation.

Input Response

When a thermocouple slot is disabled, the thermocouple module continues to update its input image table. However, the SLC processor does not read input from a module that is disabled. Therefore, when the processor disables the thermocouple module slot, the module inputs appearing in the processor image table remain in their last state, and the module's updated image table is not read. When the processor re-enables the module slot, the current state of the module inputs are read by the processor during the subsequent scan.

Output response

The SLC processor may change the thermocouple module output data (configuration) as it appears in the processor output image. However, this data is not transferred to the thermocouple module. The outputs are held in their last state. When the slot is re-enabled, the data in the processor image is transferred to the thermocouple module.



Channel Configuration, Data, and Status

Read this chapter to:

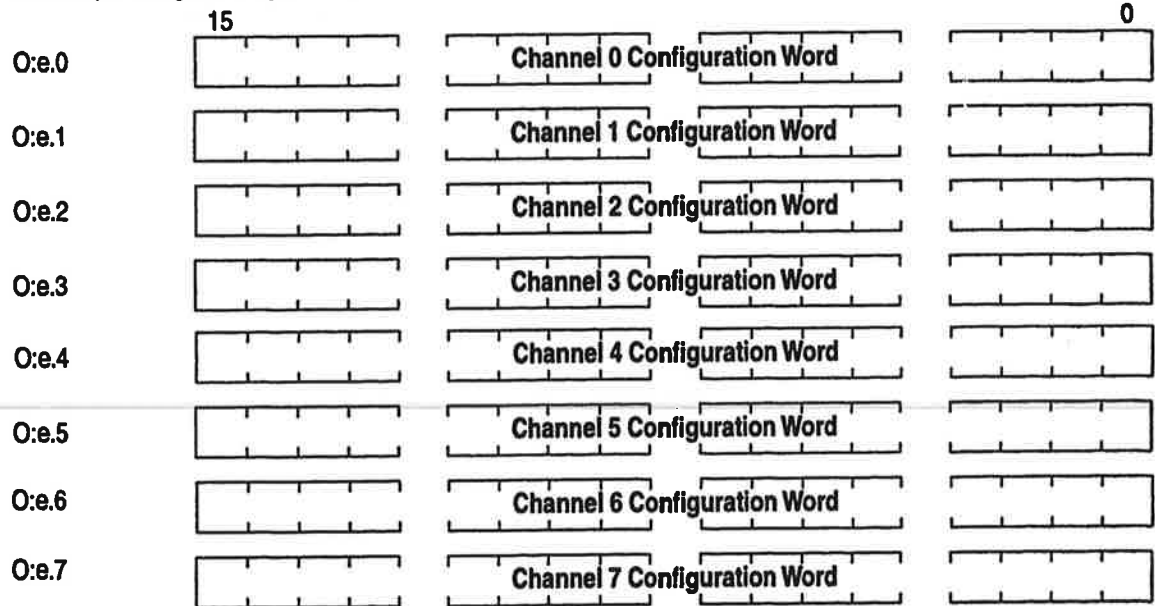
- configure each input channel
- check each input channel's configuration and status

Channel Configuration

Channel configuration words appear in the SLC controller's output image table as shown below. Words 0-7 correspond to module channels 0-7.

After module installation, you must configure each channel to establish the way the channel operates (e.g., thermocouple type, temperature units, etc.). You configure the channel by setting bits in the configuration word using your programmer. We present bit descriptions next.

SLC Output Image (Configuration) Words



e = slot number of the module

The configuration word default settings are all zero. Next, we describe how you set configuration bits of a channel configuration word to set up the following channel parameters:

- type of thermocouple or mV input
- data format such as engineering units, counts, or scaled for PID
- how the channel should respond to a detected open input circuit
- filter frequency selection
- temperature units in °C or °F
- whether the channel is enabled or disabled
- whether status or data information is selected for the module's input image table.

Channel Configuration Procedure

The channel configuration word consists of bit fields, the settings of which determine how the channel will operate. This procedure looks at each bit field separately and helps you configure a channel for operation. Refer to the chart on the following page and the bit field descriptions that follow for complete configuration information.

1. Determine which channels are used in your program and enable them. Place a one in bit 0 if the channel is to be enabled. Place a zero in bit 0 if the channel is to be disabled.
2. Determine the input device type (J, K, etc. thermocouple) (or mV) for a channel and enter its respective 4-digit binary code in bit field 1-4 of the channel configuration word.
3. Select a data format for the data word value. Your selection determines how the analog input value from the A/D converter will be expressed in the data word. Enter your 2-digit binary code in bit field 5-6 of the channel configuration word.
4. Determine the desired state for the channel data word if an open circuit condition is enabled and detected for that channel. Enter the 2-digit binary code in bit field 7-8 of the channel configuration word.
5. If the channel is configured for thermocouple inputs or the CJC sensor, determine if you want the channel data word to read in degrees Fahrenheit or degrees Celsius and enter a one or a zero in bit 9 of the configuration word. If the channel is configured for a mV analog sensor, enter a zero in bit 9.

6. Determine the desired input filter frequency for the channel and enter the 2-digit binary code in bit field 10-11 of the channel configuration word. A lower filter frequency increases the channel update time, but also increases the noise rejection and channel resolution. A higher filter frequency decreases the channel update time, but also decreases the noise rejection and effective resolution.
7. Ensure that bits 12-14 contain zeros.
8. Determine whether the channel input image word should contain data or status. Place a one in bit 15 if channel data is desired. Place a zero in bit 15 if status is desired.
9. Build the channel configuration word for every channel on each thermocouple / mV module repeating the procedures given in steps 1-8.
10. Enter this configuration into your ladder program and copy it to the thermocouple module.

A detailed explanation appears in the following table:

Table 9. Channel Configuration Word (O:e.0 through O:e.7) - Bit Definitions

		15	14	13	12	11	10	9	8	7	6	5	4	3	2	1	0
Channel Enable	Channel disable																0
	Channel enable																1
Input Type	Thermocouple Type J												0	0	0	0	
	Thermocouple Type K												0	0	0	1	
	Thermocouple Type T												0	0	1	0	
	Thermocouple Type E												0	0	1	1	
	Thermocouple Type R												0	1	0	0	
	Thermocouple Type S												0	1	0	1	
	Thermocouple Type B												0	1	1	0	
	Thermocouple Type N												0	1	1	1	
	±50 mV												1	0	0	0	
	±100 mV												1	0	0	1	
	Invalid												1	0	1	0	
	Invalid												1	0	1	1	
	Invalid												1	1	0	0	
	Invalid												1	1	0	1	
Invalid												1	1	1	0		
	CJC temperature											1	1	1	1		
Data Format	Engineering Units x10											0	0				
	Engineering Units x100											0	1				
	Scaled for PID											1	0				
	Proportional counts											1	1				
Open Circuit	Zero on open circuit								0	0							
	Max. on open circuit								0	1							
	Min. on open circuit								1	0							
	Disabled								1	1							
Temperature Units	Degrees C [ⓐ]							0									
	Degrees F [ⓐ]							1									
Channel filter freq.	10 Hz input filter				0	0											
	50 Hz input filter				0	1											
	60 Hz input filter				1	0											
	250 Hz input filter				1	1											
Unused	Unused [ⓑ]		0	0	0												
	Invalid		1	1	1												
Input Image Type	Status word		0														
	Data word		1														

[ⓐ] For engineering units x1, values are expressed in 0.1 degrees or 0.01 mV. For Engineering units x10, values are expressed in 1.0 degrees or 0.1 mV.

[ⓑ] When millivolt input type is selected, the bit setting for temperature units is ignored.

[ⓒ] Ensure unused bits 12-14 are always to be set to zeros.

Select Channel Enable (Bit 0)

Use the channel enable bit to enable a channel. The thermocouple module only scans those channels that are enabled. To optimize module operation and minimize throughput times, unused channels should be disabled by setting the channel enable bit to zero.

When set (1) the channel enable bit is used by the module to read the configuration word information you have selected. While the enable bit is set, modification of the configuration word may lengthen the module update time for one cycle. If any change is made to the configuration word, the change will be reflected in the status word before new data is valid (described in the last section of this chapter).

While the channel enable bit is cleared (0), the associated channel data/status word values are cleared. After the channel enable bit is set, the associated channel data/status word remains cleared until the thermocouple module sets the channel status bit (bit 0) in the channel status word.

Select Input Types (Bits 1-4)

The input type bit field lets you configure the channel for the type of input device you have connected to the module. Valid input devices are types J, K, T, E, R, S, B, and N thermocouple sensors and $\pm 50\text{mV}$ and $\pm 100\text{mV}$ analog input signals. The channel can also be configured to read the cold-junction temperature calculated for that specific channel. When the cold-junction compensation (CJC) temperature is selected, the channel ignores the physical input signal.

Select Data Format (Bits 5 and 6)

The data format bit field lets you define the expressed format for the channel data word contained in the module input image. The data types are engineering units, scaled-for-PID, and proportional counts.

The **engineering units** allow you to select from two resolutions, x1 or x10. For engineering units x1, values are expressed in 0.1 degrees or 0.01mV. For engineering units x10, values are expressed in 1.0 degrees or 0.1mV. (Use the x10 setting to produce temperature readings in whole degrees Celsius or Fahrenheit.)

The **scaled-for-PID** value is the same for millivolt, thermocouple, and CJC input types. The input signal range is proportional to your selected input type and scaled into a 0-16,383 range, which is standard to the SLC PID algorithm.

The **proportional counts** are scaled to fit the defined temperature or voltage range. The input signal range is proportional to your selected input and scaled into a (-32,768 to 32,767) range.

Using Scaled-for-PID and Proportional Counts

The thermocouple module provides eight options for displaying input channel data. These are 0.1°F, 0.1°C, 1°F, 1°C, 0.01 mV, 0.1 mV, Scaled-for-PID, and Proportional Counts. The first six options represent real Engineering Units provided/displayed by the 1746sc-NT8, and do not require explanation. The Scaled-for-PID and Proportional Counts selections provide the highest NT8 display resolution, but also require you to manually convert the channel data to real Engineering Units.

The equations below show how to convert from Scaled-for-PID to Engineering Units, Engineering Units to Scaled-for-PID, Proportional Counts to Engineering Units, and Engineering Units to Proportional Counts. To perform the conversions, you must know the defined temperature or millivolt range for the channel's input type. Refer to the Channel Data Word Format table on the following page. The lowest possible value for an input type is S_{LOW} , and the highest possible value is S_{HIGH} .

Scaling Examples

Scaled-for-PID to Engineering Units

Equation:
$$\text{Engr Units Equivalent} = S_{LOW} + [(S_{HIGH} - S_{LOW}) \times (\text{Scaled-for-PID value displayed} / 16384)]$$

Assume type J input type, scaled-for-PID display type, channel data = 3421.
Want to calculate °C equivalent.

From Channel Data Word Format table, $S_{LOW} = -210^{\circ}\text{C}$ and $S_{HIGH} = 760^{\circ}\text{C}$.

Solution:
$$\text{Engr Units Equivalent} = -210^{\circ}\text{C} + [(760^{\circ}\text{C} - (-210^{\circ}\text{C})) \times (3421 / 16384)] = -7.46^{\circ}\text{C}$$

Engineering Units to Scaled-for-PID

Equation:
$$\text{Scaled-for-PID Equivalent} = 16384 \times [(\text{Engineering Units desired} - S_{LOW}) / (S_{HIGH} - S_{LOW})]$$

Assume type J input type, scaled-for-PID display type, desired channel temp. = 344°C.

Want to calculate Scaled-for-PID equivalent.

From Channel Data Word Format table, $S_{LOW} = -210^{\circ}\text{C}$ and $S_{HIGH} = 760^{\circ}\text{C}$.

Solution:
$$\text{Scaled-for-PID Equivalent} = 16384 \times [(344^{\circ}\text{C} - (-210^{\circ}\text{C})) / (760^{\circ}\text{C} - (-210^{\circ}\text{C}))] = 9357$$

Proportional Counts to Engineering Units

Equation:
$$\text{Engr Units Equivalent} = S_{LOW} + \{(S_{HIGH} - S_{LOW}) \times [(\text{Proportional Counts value displayed} + 32768) / 65536]\}$$

Assume type E input type, proportional counts display type, channel data = 21567.

Want to calculate °F equivalent.

From Channel Data Word Format table, $S_{LOW} = -454^{\circ}\text{F}$ and $S_{HIGH} = 1832^{\circ}\text{F}$

Solution:
$$\text{Engr Units Equivalent} = -454^{\circ}\text{F} + \{[1832^{\circ}\text{F} - (-454^{\circ}\text{F})] \times [(21567 + 32768) / 65536]\} = 1441.3^{\circ}\text{F}$$

Engineering Units to Proportional Counts

Equation: Proportional Counts Equivalent = $\{65536 \times ((\text{Engineering Units desired} - S_{\text{LOW}})/(S_{\text{HIGH}} - S_{\text{LOW}}))\} - 32768$

Assume type E input type, proportional counts display type, desired channel temp. = 1000°F.

Want to calculate Proportional Counts equivalent.

From Channel Data Word Format table, SLOW = -454°F and SHIGH = 1832°F.

Solution: Proportional Counts Equivalent = $\{65536 \times [(1000^\circ\text{F} - (-454^\circ\text{F})) / (1832^\circ\text{F} - (-454^\circ\text{F}))]\} - 32768 = 8916$.

Table 10. 1746sc-NT8 Thermocouple Module - Channel Data Word Format

Data Format

Input Type	Engineering Units x 10		Engineering Units x 1		Scaled-for-PID	Proportional Counts
	° Celsius	° Fahrenheit	° Celsius	° Fahrenheit		
J	-210 to 760	-346 to 1400	-2100 to 7600	-3460 to 14000	0 to 16383	-32768 to 32767
K	-270 to 1370	-454 to 2498	-2700 to 13700	-4540 to 24980	0 to 16383	-32768 to 32767
T	-270 to 400	-454 to 752	-2700 to 4000	-4540 to 7520	0 to 16383	-32768 to 32767
E	-270 to 1000	-454 to 1832	-2700 to 10000	-4540 to 18320	0 to 16383	-32768 to 32767
R	0 to 1768	32 to 3214	0 to 17680	320 to 32140	0 to 16383	-32768 to 32767
S	0 to 1768	32 to 3214	0 to 17680	320 to 32140	0 to 16383	-32768 to 32767
B	300 to 1820	572 to 3308	3000 to 18200	5720 to 32767 ^①	0 to 16383	-32768 to 32767
N	0 to 1300	32 to 2372	0 to 13000	320 to 23720	0 to 16383	-32768 to 32767
±50 mV	-500 to 500 ^②	-500 to 500 ^②	-5000 to 5000 ^②	-5000 to 5000 ^②	0 to 16383	-32768 to 32767
±100 mV	-1000 to 1000 ^②	-1000 to 1000 ^②	-10000 to 10000 ^②	-10000 to 10000 ^②	0 to 16383	-32768 to 32767
CJC Sensor	-25 to 105	-13 to 221	-250 to 1050	-130 to 2210	0 to 16383	-32768 to 32767

^① Type B thermocouple cannot be represented in engineering units x 1 (°F) above 3276.8°F. Software treats it as over range error.

^② When millivolts are selected, the temperature setting is ignored. Analog input data is the same for either °C or °F selection.

Table 11. 1746sc-NT8 Thermocouple Module - Channel Data Word Resolution

Data Format

Input Type	Engineering Units x 10		Engineering Units x 1		Scaled-for-PID		Proportional Counts	
	° Celsius	° Fahrenheit	° Celsius	° Fahrenheit	° Celsius	° Fahrenheit	° Celsius	° Fahrenheit
J	1°C/step	1°F/step	0.1°C/step	0.1°F/step	0.0592°C/step	0.1066°F/step	0.0148°C/step	0.0266°F/step
K	1°C/step	1°F/step	0.1°C/step	0.1°F/step	0.1001°C/step	0.1802°F/step	0.0250°C/step	0.0450°F/step
T	1°C/step	1°F/step	0.1°C/step	0.1°F/step	0.0409°C/step	0.0736°F/step	0.0102°C/step	0.0184°F/step
E	1°C/step	1°F/step	0.1°C/step	0.1°F/step	0.0775°C/step	0.1395°F/step	0.0194°C/step	0.0349°F/step
R	1°C/step	1°F/step	0.1°C/step	0.1°F/step	0.1079°C/step	0.1942°F/step	0.0270°C/step	0.0486°F/step
S	1°C/step	1°F/step	0.1°C/step	0.1°F/step	0.1079°C/step	0.1942°F/step	0.0270°C/step	0.0486°F/step
B	1°C/step	1°F/step	0.1°C/step	0.1°F/step	0.0928°C/step	0.1670°F/step	0.0232°C/step	0.0417°F/step
N	1°C/step	1°F/step	0.1°C/step	0.1°F/step	0.0793°C/step	0.1428°F/step	0.0198°C/step	0.0357°F/step
±50 mV ^⓪	0.1mV/step	0.1mV/step	0.01mV/step	0.01mV/step	6.104μV/step	6.104μV/step	1.526μV/step	1.526μV/step
±100 mV ^⓪	0.1mV/step	0.1mV/step	0.01mV/step	0.01mV/step	12.21μV/step	12.21μV/step	3.052μV/step	3.052μV/step
CJC Sensor	1°C/step	1°F/step	0.1°C/step	0.1°F/step	0.0079°C/step	0.0143°F/step	0.0020°C/step	0.0036°F/step

^⓪ When millivolts are selected, the temperature setting is ignored. Analog input data is the same for either °C or °F selection.

Important: Data resolution is not equivalent to data accuracy. Input accuracy of ±50μV may span multiple steps for PID and Proportional Counts data types. As an example a Type B thermocouple temperature range of 0 to 1820°C provides a voltage input range of 0 to 13.82mV to the NT8. This is a very small input range and when it is scaled to PID or proportional counts ranges a small input change will result in many counts being changed.

Select Open Circuit State (Bits 7 and 8)

The open-circuit bit field lets you define the state of the channel data word when an open-circuit condition is detected for that channel. This feature can be disabled by selecting the disable option.

An open-circuit condition occurs when the thermocouple itself or its extension wire is physically separated or open. This can happen if the wire gets cut or disconnected from terminal block.

If either of the two CJC devices are removed from the module wiring terminal, any input channel configured for either a thermocouple or CJC temperature input will be placed in an open circuit condition. An input channel configured for millivolt input is not affected by CJC open-circuit conditions.

The results of the data word in an open-circuit condition depend upon the selection of bits 7 and 8.

If zero is selected, the channel data word is forced to 0 during an open-circuit condition.

Selecting maximum forces the channel data word value to its full scale value during an open-circuit condition. The full scale value is determined by the selected input type and data format.

Selecting minimum forces the channel data word value to its low scale value during an open-circuit condition. The low scale value is determined by the selected input type and data format.

Disabling the open-circuit selection may result in unintended operation on a failure. Generally, with the open-circuit option disabled, the data word remains unchanged. The open circuit error bit and the channel LED will flag the condition until the error is resolved.

For example, if channel one is configured as a thermocouple type when the CJC breaks in an open-circuit condition, if open-circuit detection is disabled, the data word will remain unchanged. If the circuit selection is set at minimum, the data word will be set to the low scale value for the range and format.

Important: The open-circuit enabled gives about 45 msec added to a channel's update time. Disabling the open-circuit detection removes the time adder. CJC sensors do not require the additional time, thus it is recommended that when using a channel for CJC sensor acquisition, the open circuit selection is enabled.

Select Temperature Units (Bit 9)

The temperature units bit lets you select temperature engineering units for thermocouple and CJC input types. Units are either degrees Celsius ($^{\circ}\text{C}$) or degrees Fahrenheit ($^{\circ}\text{F}$). This bit field is only active for thermocouple and CJC input types. It is ignored when millivolt inputs types are selected.

Important: If you are using engineering units (x1 mode) and Fahrenheit temperature units (i.e. 0.1°F), the full scale temperature for thermocouple type B is not achievable with 16-bit signed numerical representation. An over range error will occur for that channel if it tries to represent the full scale value. The maximum representable temperature is 3276.7°F (instead of 3308°F).

Select Channel Filter Frequency (Bits 10 and 11)

The channel filter frequency bit field lets you select one of four filters available for a channel. The filter frequency affects the channel update time and noise rejection characteristics. A smaller filter frequency increases the channel update time, but also increases the noise rejection and channel resolution. A larger filter frequency decreases the noise rejection, but also decreases the channel update time and channel resolution.

- 250 Hz setting provides minimal noise filtering.
- 60 Hz setting provides 60 Hz AC line noise filtering.
- 50 Hz setting provides 50 Hz AC line noise filtering.
- 10 Hz setting provides both 50 Hz and 60 Hz AC line noise filtering.

When a CJC input type is selected, this field is ignored. To maximize the speed versus resolution trade-off, CJC inputs are sampled at 60 Hz.

Unused Bits (Bits 12-14)

Bits 12-14 are not defined. Ensure these bits are always cleared (0).

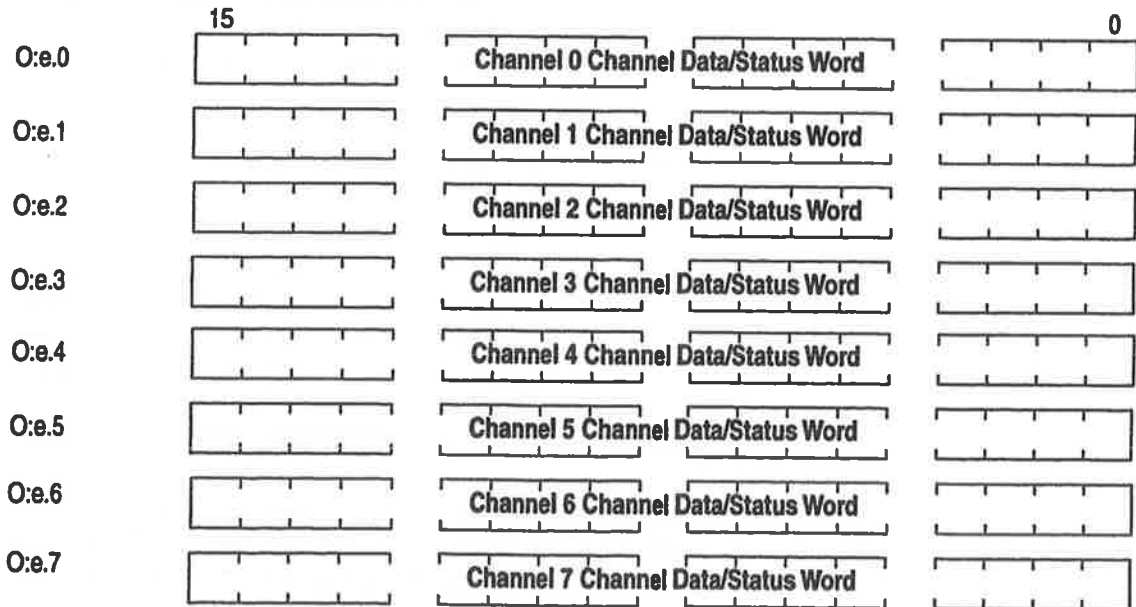
Select Input Image Type (Bit 15)

The input image type bit allows you to select data or status information in the channel's input image word. When set (1) the module places channel data in the corresponding input image word. When the bit is cleared (0) the module places channel status in the corresponding input image word.

Channel Data/Status Word

The actual thermocouple or millivolt input data values or channel status reside in I:e.0 through I:e.7 of the thermocouple module input image file. The data values present will depend on the input type and data formats you have selected. When an input channel is disabled, its data word is reset (0).

Module Input Image (Data/Status) Word



Channel Status Checking

You can use the information provided in the status word to determine if the input configuration data for any channel is valid per your configuration in O:e.0 through O:e.7.

The channel status can be analyzed bit by bit. In addition to providing information about an enabled or disabled channel, each bit's status (0 or 1) tells you how the input data from the thermocouple or millivolt analog sensor connected to a specific channel will be translated for your application. The bit status also informs you of any error condition and can tell you what type of error occurred.

A bit-by-bit examination of the status word is provided in the chart on the following page.

Important: If the channel for which you are seeking status is disabled, all bit fields are cleared. The status word for any disabled channel is always 0000 0000 0000 0000 regardless of any previous setting that may have been made to the configuration word.

Explanations of the status conditions follow.

Channel Status (Bit 0)

The channel status bit indicates operational state of the channel. When the channel enable bit is set in the configuration word (bit 0), the thermocouple module configures the selected channel and takes a data sample for the channel data word before setting this bit in the status word.

Input Type Status (Bits 1-4)

The input type bit field indicates what type of input signal you have configured for the channel. This field reflects the input type defined in the channel configuration word.

Data Format Type Status (Bits 5 and 6)

The data format bit field indicates the data format you have defined for the channel. This field reflects the data type selected in bits 5 and 6 of the channel configuration word.

Open Circuit Type Status (Bits 7 and 8)

The open-circuit bit field indicates how you have defined the open circuit bits configuration word, and therefore, the response of the thermocouple module to an open-circuit condition. This feature is active for all input types, including CJC temperature input.

Temperature Units Type Status (Bit 9)

The temperature units field indicates the state of the temperature units bit in the configuration word (bit 9).

Channel Filter Frequency (Bits 10 and 11)

The channel filter frequency bit field reflects the filter frequency you selected in the configuration word.

Open Circuit Error (Bit 12)

This bit is set (1) whenever a configured channel detects an open-circuit condition at its input. An open-circuit at the CJC sensor will also flag this error if the channel input type is either thermocouple or CJC temperature. A range error on the CJC sensor will also flag this bit if the input type is a thermocouple type.

Under-Range Error (Bit 13)

This bit is set (1) whenever a configured channel detects an under-range condition for the channel data. An under-range condition exists when the input value is equal to or below the specified lower limit of the particular sensor connected to that channel.

Over-Range Error (Bit 14)

This bit is set (1) whenever a configured channel detects an over-range condition for the channel data. An over-range condition exists when the input value is equal to or above the specified upper limit of the particular sensor connected to that channel.

Channel Error (Bit 15)

This bit is set (1) whenever a configured channel detects an error in the configuration word, or an error has occurred while acquiring the ADC data value. If during the auto-calibration process, the module detects an out-of-range condition for the filter frequency selected for the channel, the channel error bit will be set. An out-of-range condition occurring during auto-calibration would be the result of an overly noisy environment, whereby the module cannot maintain accuracy specifications, thus flagging an error. The error bit is cleared when the error condition is resolved. The channel data word is not updated during a period of auto-calibration filter frequency tolerance errors.

Programming Examples

Earlier chapters explained how the configuration word defines the way a channel operates. This chapter shows the programming required to enter the configuration word into the processor memory. It also provides you with segments of ladder logic specific to unique situations that might apply to your programming requirements. The example segments include:

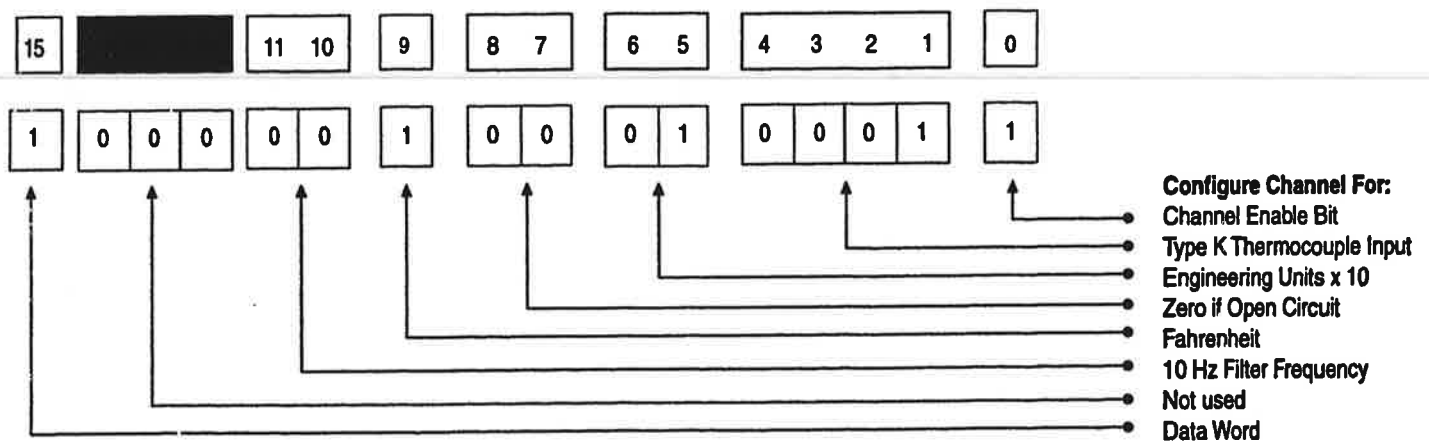
- initial programming of the configuration word
- dynamic programming of the configuration word
- verifying channel configuration changes
- interfacing the thermocouple module to a PID instruction
- monitoring channel status bit

Initial Programming

To enter data into the channel configuration word (O:e.0 through O:e.7) when the channel is disabled (bit 0 = 0), follow these steps. Refer to page 30 (Table 9) for specific configuration details.

Example - Configure eight channels of a thermocouple module residing in slot 3 of 1746 chassis. Configure each channel with the same parameters.

Figure 10. Channel configuration



This example transfers configuration data and sets the channel enable bits of all eight channels with a single File Copy instruction.

Procedure

1. Using the memory map function, create integer file N10. Integer file N10 should contain eight elements (N10:0 through N10:7).
2. Using the APS software data monitor function, enter the configuration parameters for all eight thermocouple channels into a source integer data file N10.

Figure 11. Data table for initial programming

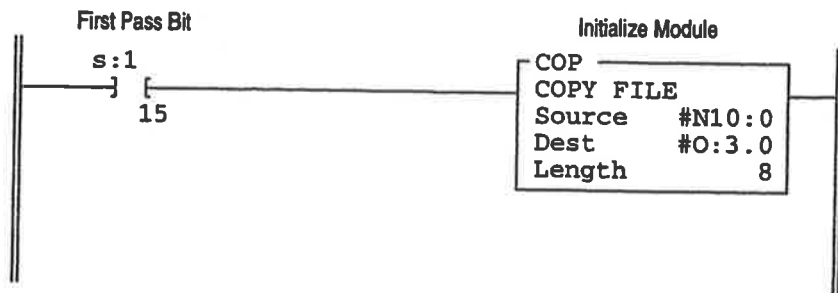
address	15	data	0	address	15	data	0
N10:0	1000	0010	0010	0011			
N10:1	1000	0010	0010	0011			
N10:2	1000	0010	0010	0011			
N10:3	1000	0010	0010	0011			
N10:4	1000	0010	0010	0011			
N10:5	1000	0010	0010	0011			
N10:6	1000	0010	0010	0011			
N10:7	1000	0010	0010	0011			

Press a key or enter value
 N10:3/0 = 1
 offline no forces binary data decimal addr File EXMPL

CHANGE RADIX F1	SPECIFY ADDRESS F5	NEXT FILE F7	PREV FILE F8
--------------------	-----------------------	-----------------	-----------------

3. Program a rung in your ladder logic to copy the contents of integer file N10 to the eight consecutive output words of the thermocouple module beginning with O:3.0.

Figure 12. Initial programming example



On power up, bit S:1/15 is set for the first program scan, and integer file N10 is sent to the NT8 channel configuration words.

Dynamic Programming

The following example explains how to change data in the channel configuration word when the channel is currently enabled.

Example - Execute a dynamic configuration change to channel 2 of the thermocouple module located in slot 3 of a 1746 chassis. Change from monitoring an external type K thermocouple to monitoring the CJC sensors mounted on the terminal block. This gives a good indication of what the temperature is inside the control cabinet. Finally, set channel 2 back to type K thermocouple.

Figure 13. Dynamic programming example

Program Listing

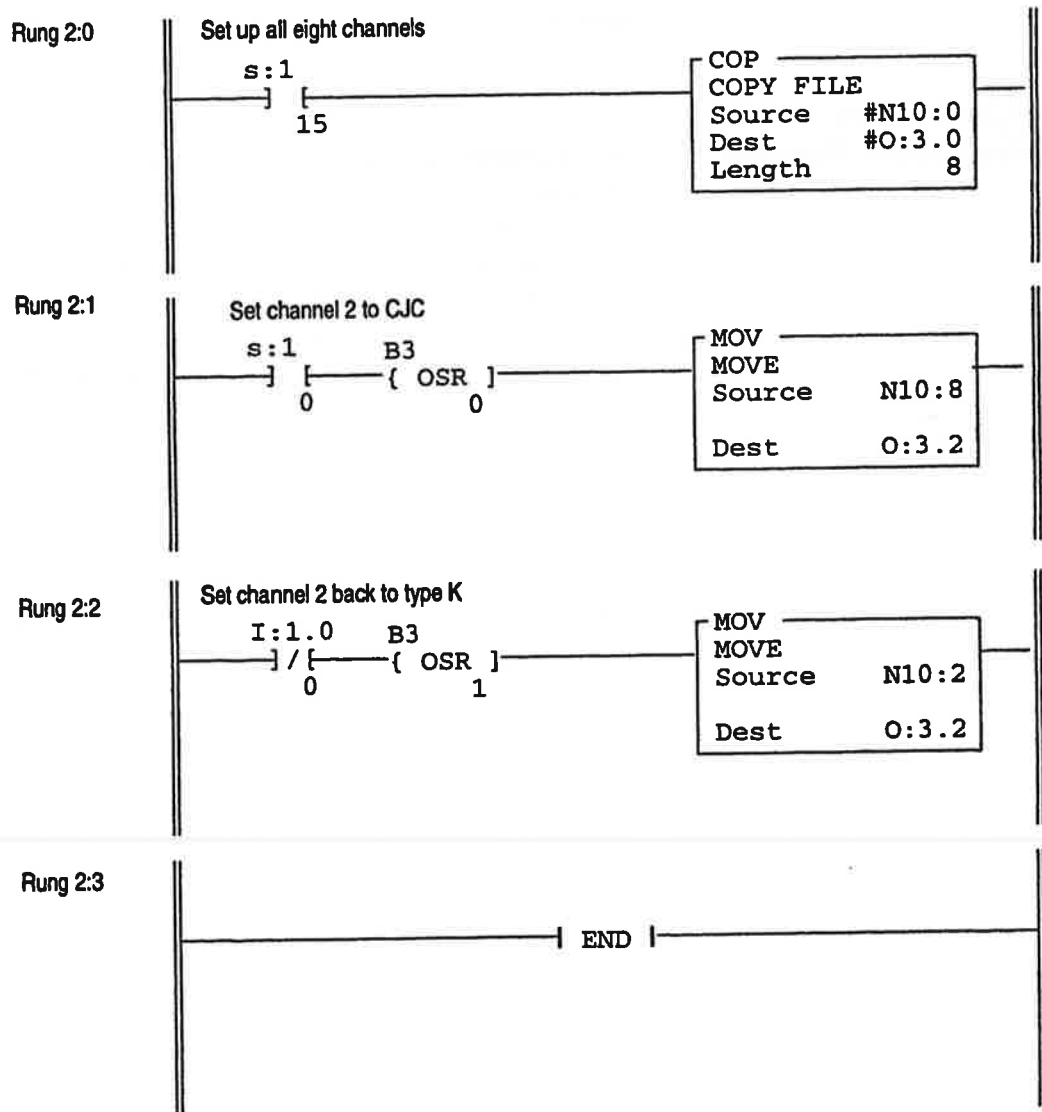


Figure 14. Data table for dynamic programming

address	15	data			0	address	15	data			0
N10:0	1000	0010	0010	0011	0011	N10:8	1000	0010	0011	1111	1111
N10:1	1000	0010	0010	0011	0011						
N10:2	1000	0010	0010	0011	0011						
N10:3	1000	0010	0010	0011	0011						
N10:4	1000	0010	0010	0011	0011						
N10:5	1000	0010	0010	0011	0011						
N10:6	1000	0010	0010	0011	0011						
N10:7	1000	0010	0010	0011	0011						

Important: While the module performs the configuration alteration, it does not monitor input device data change at any channel.

Verifying Channel Configuration Changes

When executing a dynamic channel configuration change, there will always be a delay from the time the ladder program makes the change to the time the NT8 gives you a data word using that new configuration information. Therefore, it is very important to verify that a dynamic channel configuration change took effect in the NT8 module, particularly if the channel being dynamically configured is used for control. The following example explains how to verify that channel configuration changes have taken effect.

Example - Execute a dynamic configuration change to channel 2 of the thermocouple module located in slot 3 of a 1746 chassis, and set an internal “data valid” bit when the new configuration has taken effect. In this example the input image of the channel is selected to contain the channel status word.

Figure 15. Programming for configuration changes example

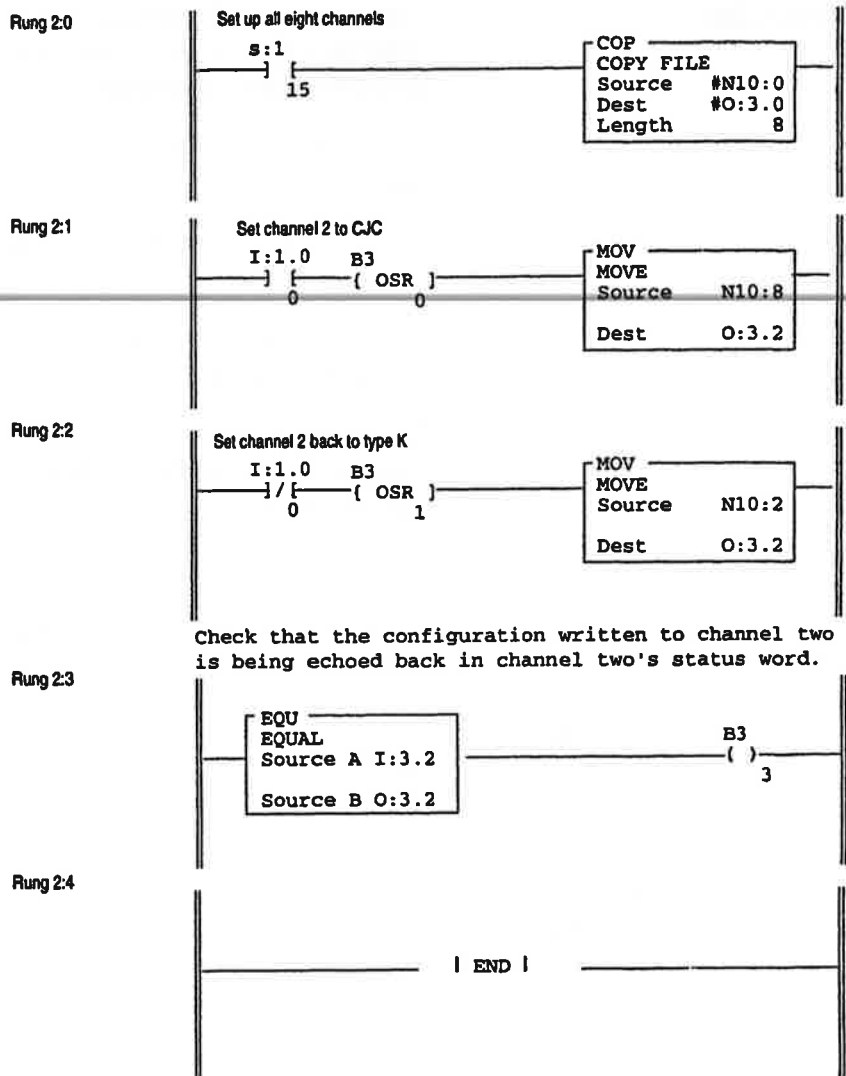


Figure 16. Data table for configuration changes

Data Table

address	15	data	0	address	15	data	0		
N10:0	0000	0010	0010	0011	N10:8	0000	0010	0011	1111
N10:1	0000	0010	0010	0011					
N10:2	0000	0010	0010	0011					
N10:3	0000	0010	0010	0011					
N10:4	0000	0010	0010	0011					
N10:5	0000	0010	0010	0011					
N10:6	0000	0010	0010	0011					
N10:7	0000	0010	0010	0011					

Interfacing to the PID Instruction

The thermocouple module was designed to interface directly to the SLC 5/02™ or later processor PID instruction without the need for an immediate scale operation.

Example - Use NT8 channel data as the process variable in the PID instruction.

1. Select *scaled-for-PID* as the data type in the channel configuration word.
2. Specify the thermocouple channel data word as the process variable for the PID instruction.

In this example, the value 32,835 is the numeric equivalent of configuration word N10:0 for channel 0. It is configured for a type K thermocouple, scaled-for-PID, zero the signal for an open circuit, 10 Hz, °C, and channel enabled.

Figure 17. Programming for PID Control Example

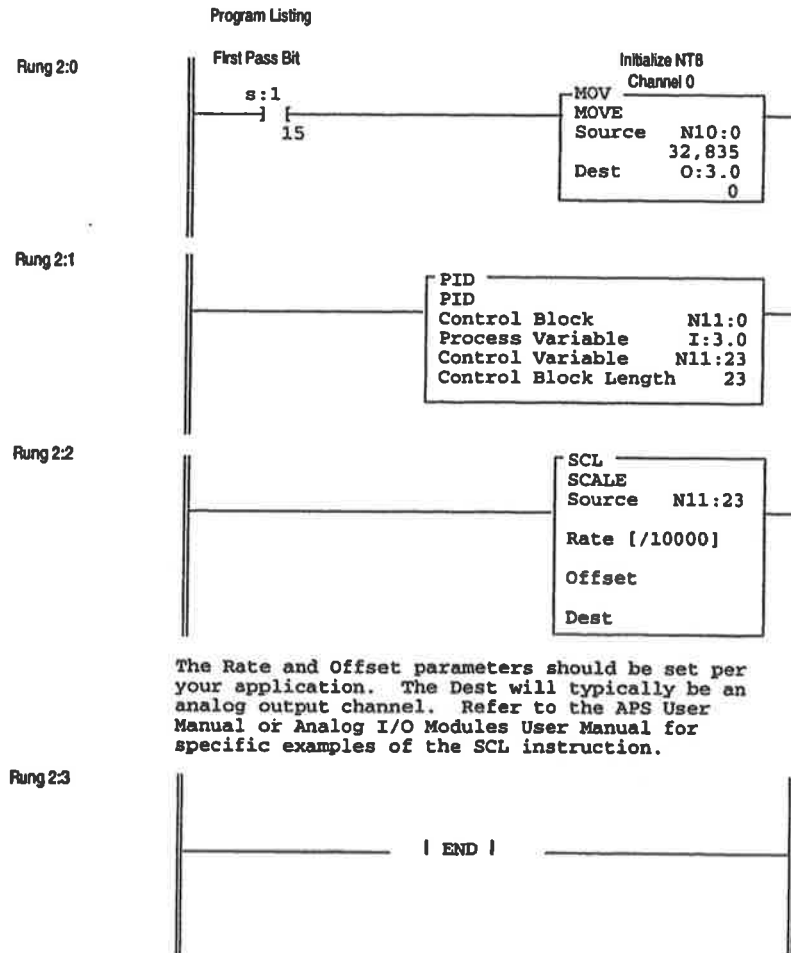


Figure 18. Data table for PID Control

Data Table

address	15	data	0	address	15	data	0
N10:0	1000	0000	0100	0011			

Monitoring Channel Status Bits

The example shows how you could monitor the open circuit error bits of each channel and set an alarm in the processor if one of the thermocouples opens. An open circuit error can occur if the thermocouple breaks, one of the thermocouple wires gets cut or disconnected from the terminal block, or if the CJC sensors are not installed or are damaged.

Important: If a CJC input is not installed or is damaged, all eight alarms are set, and all eight channel LEDs blink.

Figure 19. Monitoring channel status bits example

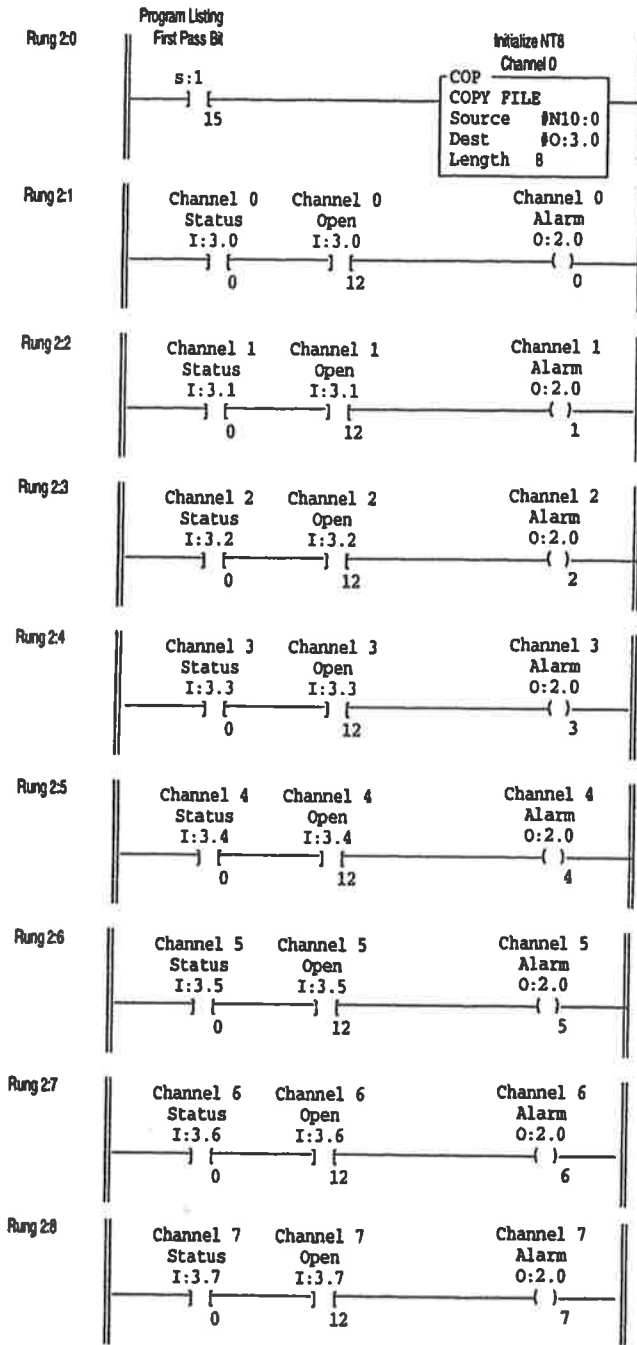


Figure 20. Data table for monitoring channel status bits

Data Table

address	15	data	0	address	15	data	0		
N10:0	0000	0010	0010	0011	N10:4	0000	0010	0010	0011
N10:1	1000	0010	0010	0011	N10:5	0000	0010	0010	0011
N10:2	1000	0010	0010	0011	N10:6	0000	0010	0010	0011
N10:3	1000	0010	0010	0011	N10:7	0000	0010	0010	0011

This is an example of how to automatically switch between reading the channel status words and channel sensor data words. Specifically, this example shows a very simple method of utilizing a timer to periodically switch between reading the channel status and data words.

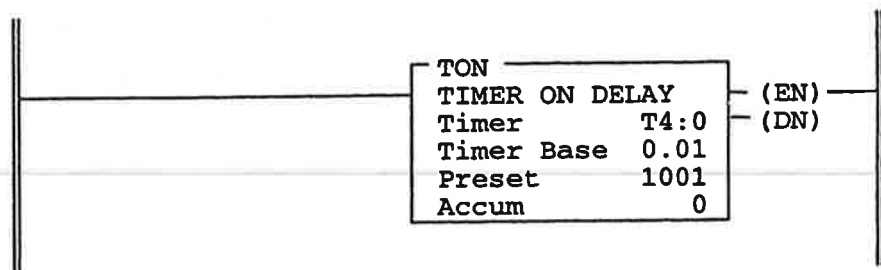
The program utilizes a timer accumulator value to determine when to set up the configuration words, and when to read in the channel status and channel data information. The channel status information is copied from the I:2.0 to I:2.7 registers into registers N7:10 to N7:17. The channel data information is copied from I:2.0 to I:2.7 into registers N7:0 to N7:7. This allows sensor data and channel status information to be accessed at any time from these registers. However, when the module channels are configured to read sensor data, the channel status words (as reflected in N7:10 to N7:17) are not being dynamically updated, and visa-versa.

A longer interval between reading in the channel status information could be achieved through the utilization of a combination of counters and timers. If you are utilizing an SLC 5/03 or SLC 5/04 or later processor, the internal processor clock registers S:40 to S:42 could be utilized to determine the timing.

Rung 2:0

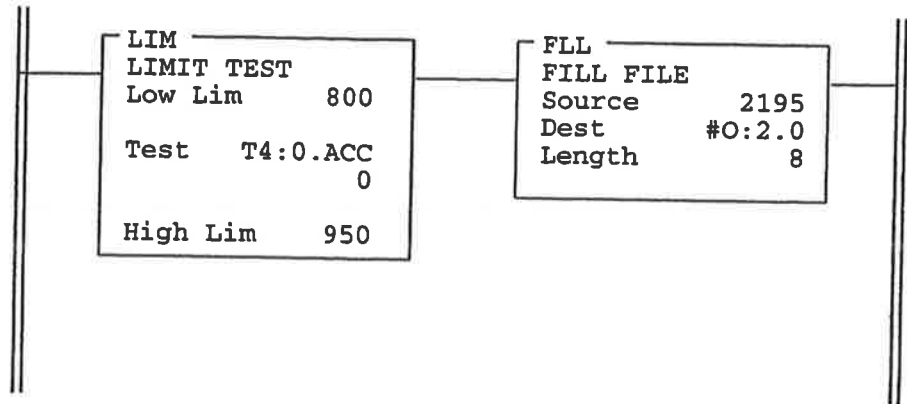
Timer T4:0 counts out a five second interval. It's accumulator indicates the progress it has made toward completion. The accumulator value shall be utilized to determine when to set the channel configuration word to send sensor data or to send status information.

A longer interval between transitions can be achieved using a combination of timers and counters.



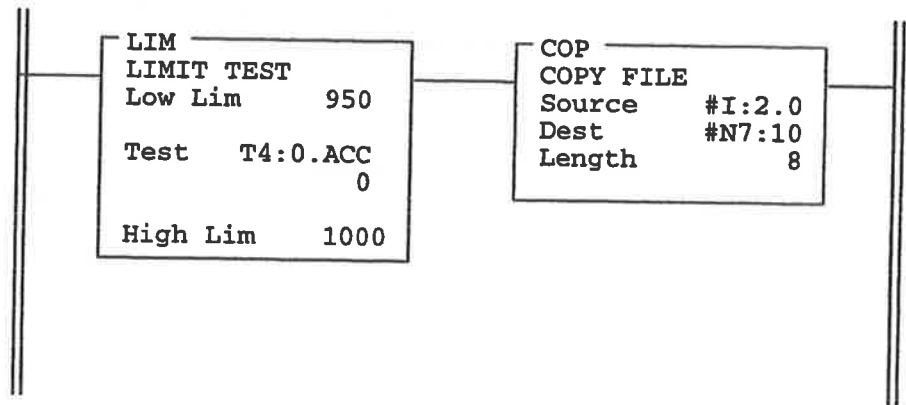
Rung 2:1

This rung tests to see if T4:0.ACC is at a value between 800 and 950 counts. If so, the channel configuration words are defined (through the Fill File command) to send status information.

**Rung 2:2**

This rung executes a Copy File command to move the channel status word (as enabled in the previous rung) into registers N7:10 through N7:17 for all thermocouple channels.

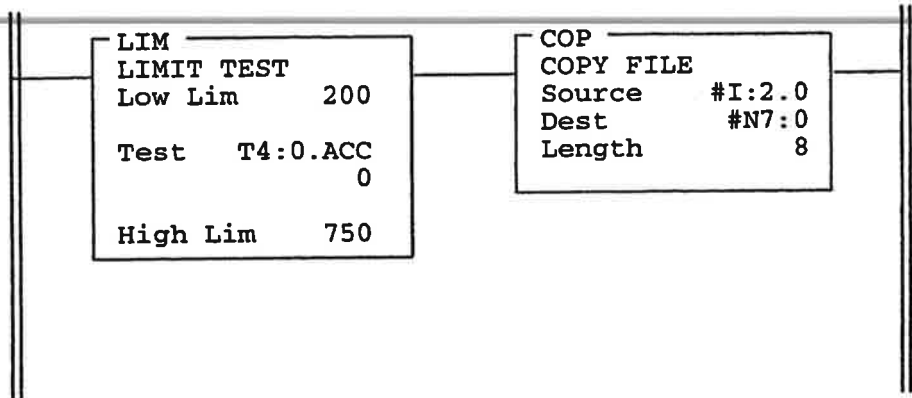
Though the module is quick about switching from sensor data to status information. It is a good idea to give the module a little time to switch modes. That is why there is a half second period in time between when the channel is set-up to send the status word and when the status word is read into the N7 table.



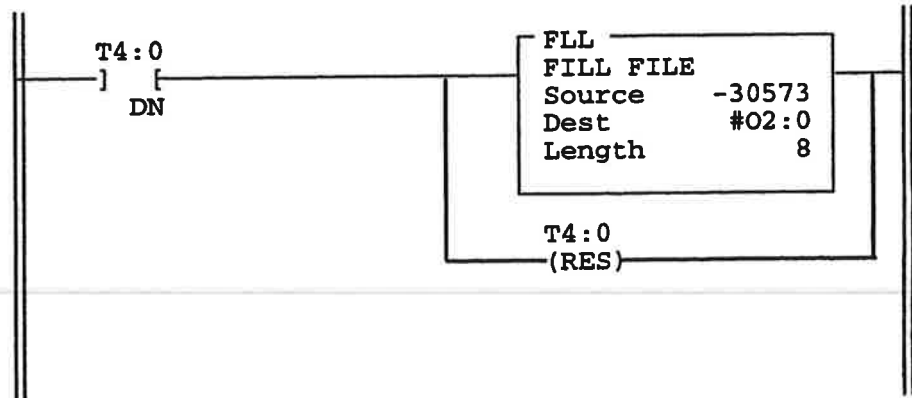
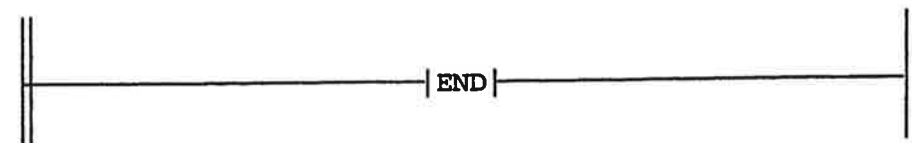
Rung 2:3

This rung will copy the channel sensor data into registers N7:0 through N7:7, about 2 seconds after the configuration word has been changed to send sensor data.

Timing is important here. Because the channels are multiplexed, it can take the module 2 seconds to update the channel input word with sensor data, if it has been sending channel status information.

**Rung 2:4**

This rung will set the channel configuration words for sending sensor data, each time the timer completes a cycle. It also resets the timer.

**Rung 2:5**



Testing Your Module

This chapter describes troubleshooting with channel-status and module-status LEDs. It explains the types of conditions that might cause the module to flag an error, and suggests what corrective action you could take. Topics include:

- module and channel diagnostics
- LED indicators
- Interpreting I/O error codes
- troubleshooting flowchart

Module and Channel Diagnostics

The module operates at two levels:

- module level
- channel level

Module level operation includes functions such as power-up, configuration, and communication with the SLC processor. ON indicates the module is OK. OFF indicates a fault.

Channel level operation includes functions such as data conversion and open-circuit detection. ON indicates the channel is OK. Blinking indicates a fault.

The module performs internal diagnostics at both levels, and immediately indicates detected error conditions with either of its status LEDs. When a status LED is continuously ON, the status is OK.

Module Diagnostics at Power-up

At module power-up, the module performs a series of internal diagnostic tests. If the module detects a failure, its module status LED remains off.

Channel Diagnostics

When a channel is enabled, the module checks for a valid configuration. Then on each scan of its inputs, the module checks for out-of-range and open-circuit fault conditions of its inputs including the CJC input.

When the module detects a failure of any channel diagnostic test, it causes the channel status LED to blink and sets the corresponding

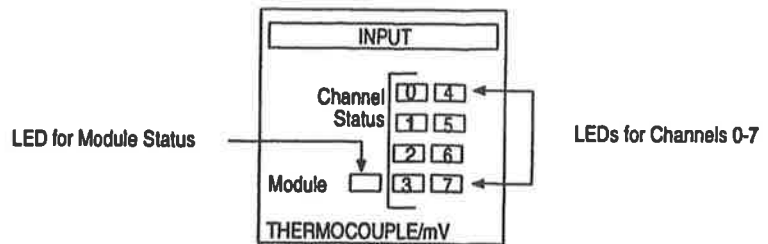
channel fault bit (bits 12-15 of the channel status word). Channel fault bits and LEDs are self-clearing when fault conditions are corrected.

Important: If you clear the channel enable bit, channel status bits are reset.

LED Indicators

The module has nine LEDs:

- eight channel-status LEDs, numbered to correspond with each channel
- one module-status LED



LED Troubleshooting Tables

Table 13. Module-status LED

If Module Status LED Is:	Then:	Take this Corrective Action:
On	The module is OK.	No action required.
Off	The module is turned off, or it detected a module fault.	Cycle power. If the condition persists, call your local distributor or Spectrum Controls for assistance.

Table 14. Module-status and Channel-status LED

If Module Status LED Is:	And Channel Status LED Is:	Then:	Take this Corrective Action:
On	On	The channel is enabled.	No action required.
	Blinking	The module detected: open-circuit condition under-range condition over-range condition channel	Examine error bits in status word if bit 12=1, the input has an open circuit if bit 13=1, the input value is under range if bit 14=1, the input value is over range if bit 15=1, the channel has a diagnostic error
	Off	The module is in power up, or the channel is disabled.	No action is required.

Channel-status LEDs (Green)

The channel-status LED operates with status bits in the channel status word to indicate the following faults detected by the module:

- invalid channel configuration
- an open-circuit input
- out-of-range errors
- selected filter frequency data acquisition or auto-calibration errors

When the module detects any of the following fault conditions, it causes the channel-status LED to blink and sets the corresponding fault bit in the channel status word. Channel fault bits (bits 12-15) and channel-status LEDs are self-clearing when fault conditions are corrected.

Open-circuit Detection (Bit 12)

If open-circuit is enabled for an input channel, the module tests the channel for an open-circuit condition each time it scans its input. Open-circuit detection is always performed for the CJC inputs. Possible causes of an open circuit include:

- broken thermocouple or CJC sensor
- thermocouple or CJC sensor wire cut or disconnected
- millivolt input wire cut or disconnected

Out-of-Range Detection (Bit 13 for under range, bit 14 for over range)

The module tests all enabled channels for an out-of-range condition each time it scans its inputs. Possible causes of an out-of-range condition include:

- the temperature is too hot or too cold for the thermocouple being used
- a type B thermocouple may be registering a °F value in EU x1 beyond the range allowed by the SLC processor (beyond 32,767) for the data word
- a CJC sensor may be damaged or the temperature being detected by the CJC may be outside the CJC sensor range limits

Channel Error (Bit 15)

The module sets this fault bit when it detects any of the following:

Configuration errors:

- configuration bits 1-4: invalid input type = 1010, 1011, 1100, 1101, or 1110

- configuration bits 12-14: invalid non-zero bit setting
- invalid data acquisition of an input channel
- the filter frequency selected for the valid channel currently fails auto-calibration range checks

Module Status LED (Green)

The module-status LED indicates when the module detects a nonrecoverable fault at power up or during operation. For this type of fault, the module:

- no longer communicates with the SLC processor
- disables all channels
- clears all data and status words

A module failure is non-recoverable and requires the assistance of your local distributor or Spectrum Controls.

Interpreting I/O Error Codes

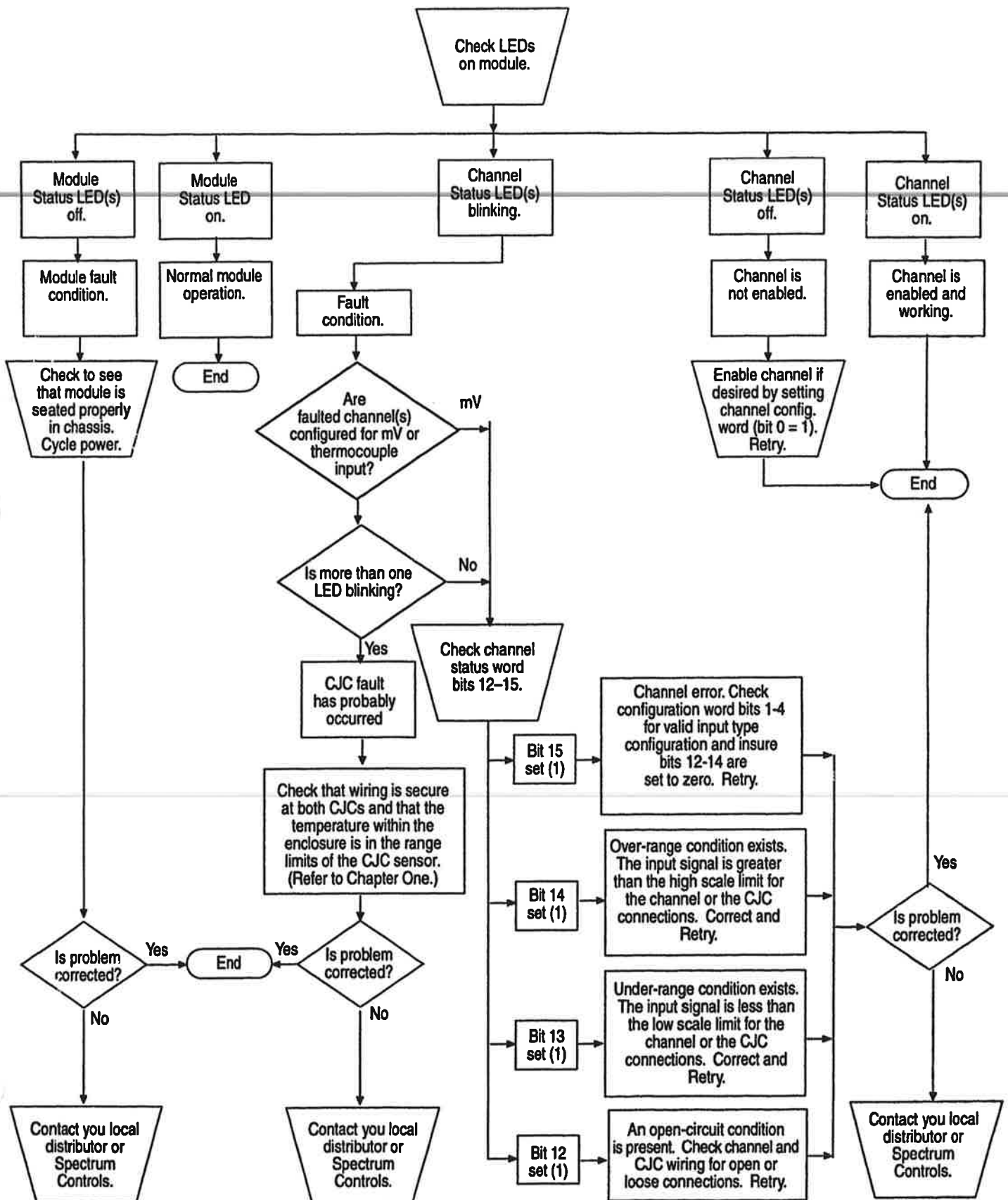
I/O error codes appear in word S:6 of the SLC processor status file. The first two digits of the error code identify the slot (in hexadecimal) with the error. The last two digits identify the I/O error code (in hexadecimal).

The error codes that apply to your module include (in hexadecimal):

- 50-5E
- 71 (watchdog error)
- 90-94

For a description of the error codes, refer to the *Allen-Bradley Advanced Programming Software (APS) Reference Manual*, Allen-Bradley publication 1746-6.11.

Figure 21. Troubleshooting Flowchart





Maintaining Your Module And Ensuring Safety

Read this chapter to familiarize yourself with:

- preventive maintenance
- safety considerations

The National Fire Protection Association (NFPA) recommends maintenance procedures for electrical equipment. Refer to article 70B of the NFPA for general safety-related work practices.

Preventive Maintenance

The printed circuit boards of your module must be protected from dirt, oil, moisture, and other airborne contaminants. To protect these boards, install the SLC 500 system in an enclosure suitable for its operating environment. Keep the interior of the enclosure clean, and whenever possible, keep the enclosure door closed.

Also, regularly inspect the terminal connections for tightness. Loose connections may cause a malfunctioning of the SLC system or damage to the components.



WARNING

POSSIBLE LOOSE CONNECTIONS

Before inspecting connections, always ensure that incoming power is OFF.

Failure to observe this precaution can cause personal injury and equipment damage.

Safety Considerations

Safety is always the most important consideration. Actively think about the safety of yourself and others, as well as the condition of your equipment. The following are some things to consider:

Indicator Lights – When the module status LED on your module is illuminated, your module is receiving power.

Activating Devices When Troubleshooting – Never reach into a machine to activate a device; the machine may move unexpectedly. Use a wooden stick.

Standing Clear Of Machinery – When troubleshooting a problem with any SLC 500 system, have all personnel remain clear of machinery. The problem may be intermittent, and the machine may move unexpectedly. Have someone ready to operate an emergency stop switch.

**CAUTION****POSSIBLE EQUIPMENT OPERATION**

Never reach into a machine to actuate a switch. Also, remove all electrical power at the main power disconnect switches before checking electrical connections or inputs/ outputs causing machine motion.

Failure to observe these precautions can cause personal injury or equipment damage.

Safety Circuits – Circuits installed on machinery for safety reasons (like over-travel limit switches, stop push-buttons, and interlocks) should always be hard-wired to the master control relay. These circuits should also be wired in series so that when any one circuit opens, the master control relay is de-energized, thereby removing power. Never modify these circuits to defeat their function. Serious injury or equipment damage may result.

**WARNING****EXPLOSION HAZARD**

SUBSTITUTION OF COMPONENTS MAY IMPAIR SUITABILITY FOR CLASS1 DIVISION2.

**WARNING****EXPLOSION HAZARD**

DO NOT DISCONNECT EQUIPMENT UNLESS POWER HAS BEEN SWITCHED OFF OR THE AREA IS KNOWN TO BE NON-HAZARDOUS.

NOTE: THIS EQUIPMENT IS SUITABLE FOR USE IN CLASS1, DIVISION 2, GROUPS A, B, C, AND D OR NON-HAZARDOUS LOCATIONS ONLY.



WARNING

EXPLOSION HAZARD

**WHEN IN HAZARDOUS LOCATIONS, TURN OFF POWER
BEFORE REPLACING OR WIRING MODULES.**

Refer to your system's *Installation & Operation Manual* for more information.



WARNING

**THIS DEVICE IS INTENDED TO ONLY BE USED WITH THE
ALLEN-BRADLEY SLC500 SYSTEMS.**

Module Specifications

This appendix lists the specifications for the 1746sc-NT8 Thermocouple/millivolt Input Module.

Electrical Specifications

Backplane Current Consumption	120 mA at 5 VDC 70 mA at 24 VDC
Backplane Power Consumption	2.28W maximum (0.5W @ 5 VDC, 1.68W @ 24 VDC)
Number of Channels	8 (backplane and channel-to-channel isolated)
I/O Chassis Location	Any I/O module slot except 0
A/D Conversion Method	Sigma-Delta Modulation
Input Filtering	Low pass digital filter with programmable notch (filter) frequencies
Normal Mode Rejection (between [+] input and [-] input)	Greater than 100 dB at 50 Hz Greater than 100 dB at 60 Hz
Common Mode Rejection (between input and ground)	Greater than 100 dB at 50/60 Hz
Input Filter Cut-Off Frequencies	Greater than 100 dB at 50/60 Hz 2.6 Hz at 10 Hz filter frequency 13.1 Hz at 50 Hz filter frequency 15.72 Hz at 60 Hz filter frequency 65.5 Hz at 250 Hz filter frequency
Calibration	Module autocalibrates at power-up and approximately every two minutes afterwards
Input Overvoltage Protection	±30 Vdc continuous 600W pulsed for 1 msec.
Isolation	500 VDC continuous between inputs and chassis ground and between inputs and backplane. 12.5 VDC continuous between channels.

Physical Specifications

LED Indicators	9 green status indicators, one for each of 8 channels and one for module status
Module ID Code	3533
Recommended Cable: for thermocouple inputs... for mV inputs...	Shielded twisted pair thermocouple extension wire [Ⓢ] Belden 8761 or equivalent
Maximum Wire Size	One 14 AWG wire or two 22 AWG wires per terminal

[Ⓢ] Refer to the thermocouple manufacturer for the correct extension wire.

Environmental Specifications

Operating Temperature	0°C to 60°C (32°F to 140°F)
Storage Temperature	-40°C to 85°C (-40°F to 185°F)
Relative Humidity	5% to 95% (without condensation)
Certification	UL & CUL approved
Hazardous Environment Classification	Class I Division 2 Hazardous Environment Groups A, B, C, D
EMC	CE compliant

Input Specifications

Type of Input (Selectable)	Thermocouple Type J	-210°C to 760°C	(-346°F to 1400°F)
	Thermocouple Type K	-270°C to 1370°C	(-454°F to 2498°F)
	Thermocouple Type T	-270°C to 400°C	(-454°F to 752°F)
	Thermocouple Type E	-270°C to 1000°C	(-454°F to 1832°F)
	Thermocouple Type R	0°C to 1768°C	(32°F to 3214°F)
	Thermocouple Type S	0°C to 1768°C	(32°F to 3214°F)
	Thermocouple Type B	300°C to 1820°C	(572°F to 3308°F)
	Thermocouple Type N	0°C to 1300°C	(32°F to 2372°F)
		Millivolt (-50 mVdc to +50 mVdc)	
		Millivolt (-100 mVdc to +100 mVdc)	
Thermocouple Linearization	NIST ITS-90 standard		
Cold Junction Compensation	Accuracy $\pm 1.72^\circ\text{C}$, -25°C to $+105^\circ$ On board CJC Sensor Required, Analog Devices AD592CN		
Input Impedance	Greater than 10M Ω		
Temperature Scale (Selectable)	°C or °F and 0.1°C or 0.1°F		
DC Millivolt Scale (Selectable)	0.1 mV or 0.01 mV		
Open Circuit Detection (Selectable)	Upscale, Downscale, Zero, or Disabled		
Time to Detect Open Circuit	One channel cycle time		
Input Step Response	0 to 95% in 400 msec (10 Hz)		
Display Resolution	See Channel Data Word Resolution table on page 34		
Overall Module Accuracy @ 25°C (77°F)	See Module Accuracy Tables, page 65		
Overall Module Accuracy (0°C to 60°C, 32°F to 140°F)	See Module Accuracy Tables, page 65		
Overall Module Drift	See Module Accuracy Tables, page 65		
Module Update Time	Dependent upon enabled channels (see Update Time, page 23)		
Channel Turn-Off Time	Up to one module update time		

Overall Accuracy

The accuracy of the module is determined by many aspects of the hardware and software functionality of the module. The following attempts to explain what the user can expect in terms of accuracy based on the thermocouple, millivolt, and volt inputs for the NT8 module.

The accuracies specified as follows include errors due to the cold junction compensation for thermocouples, and hardware and software errors associated with the system. The hardware and software errors include calibration of the system, and non-linearity of the ADC. For the sake of the calculations the resolution of the ADC was assumed to be at least 16 bits (use of the 10Hz, 50Hz, and 60Hz filter frequencies). Note: The 250Hz frequency should not be applied to thermocouple inputs.

Thermocouple

The following table provides the total error expected of the thermocouple based on the thermocouple type, and the given reference point, at 25C. The calculations assumed typical hardware/software error, and typical CJC accuracy at 25C.

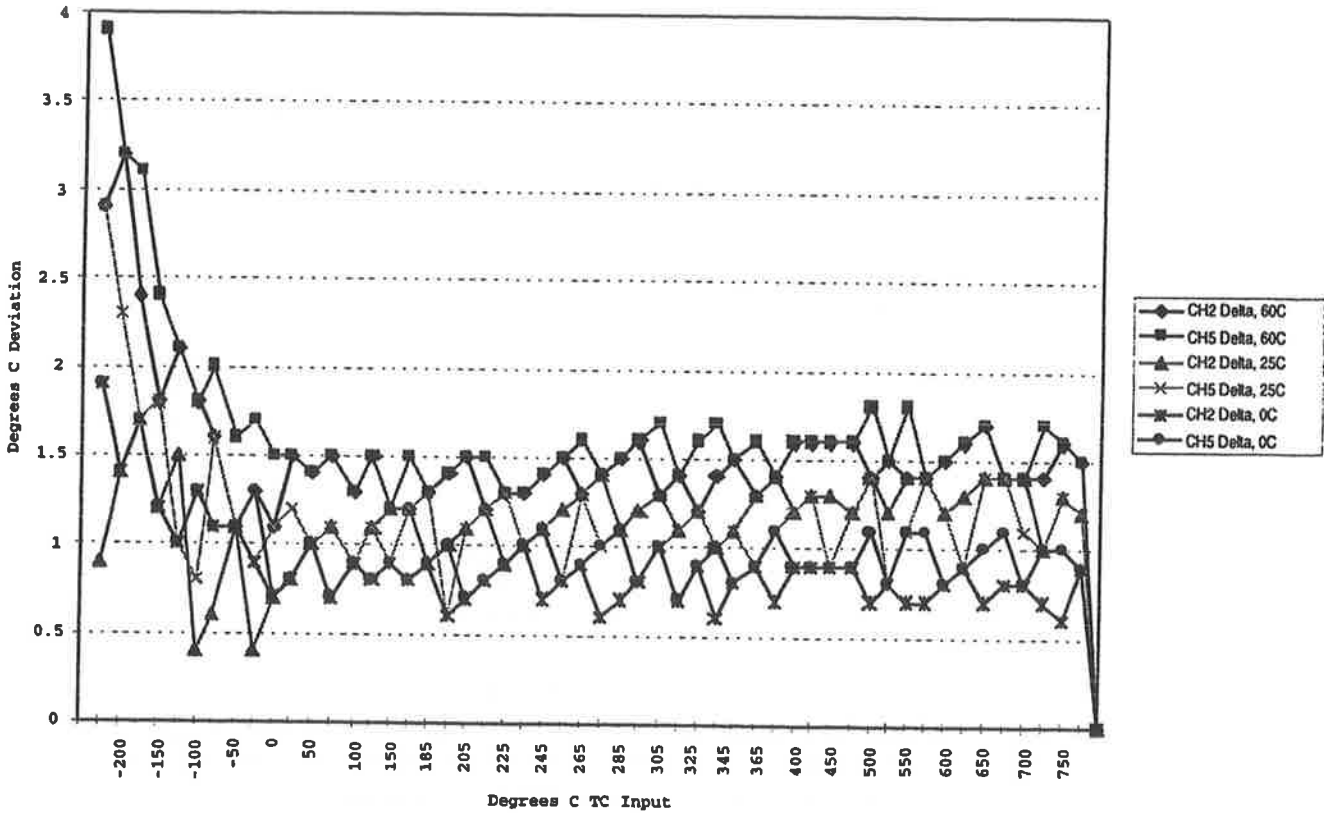
Thermocouple Type	Degrees C Thermocouple Reference Point	Error stated in Deg. C
J	275C	±1.4C
K	550C	±1.5C
T	65C	±1.3C
E	365C	±1.0C
R	885C	±3.6C
S	885C	±3.4C
B	1060C	±2.7C
N	500C	±1.3C

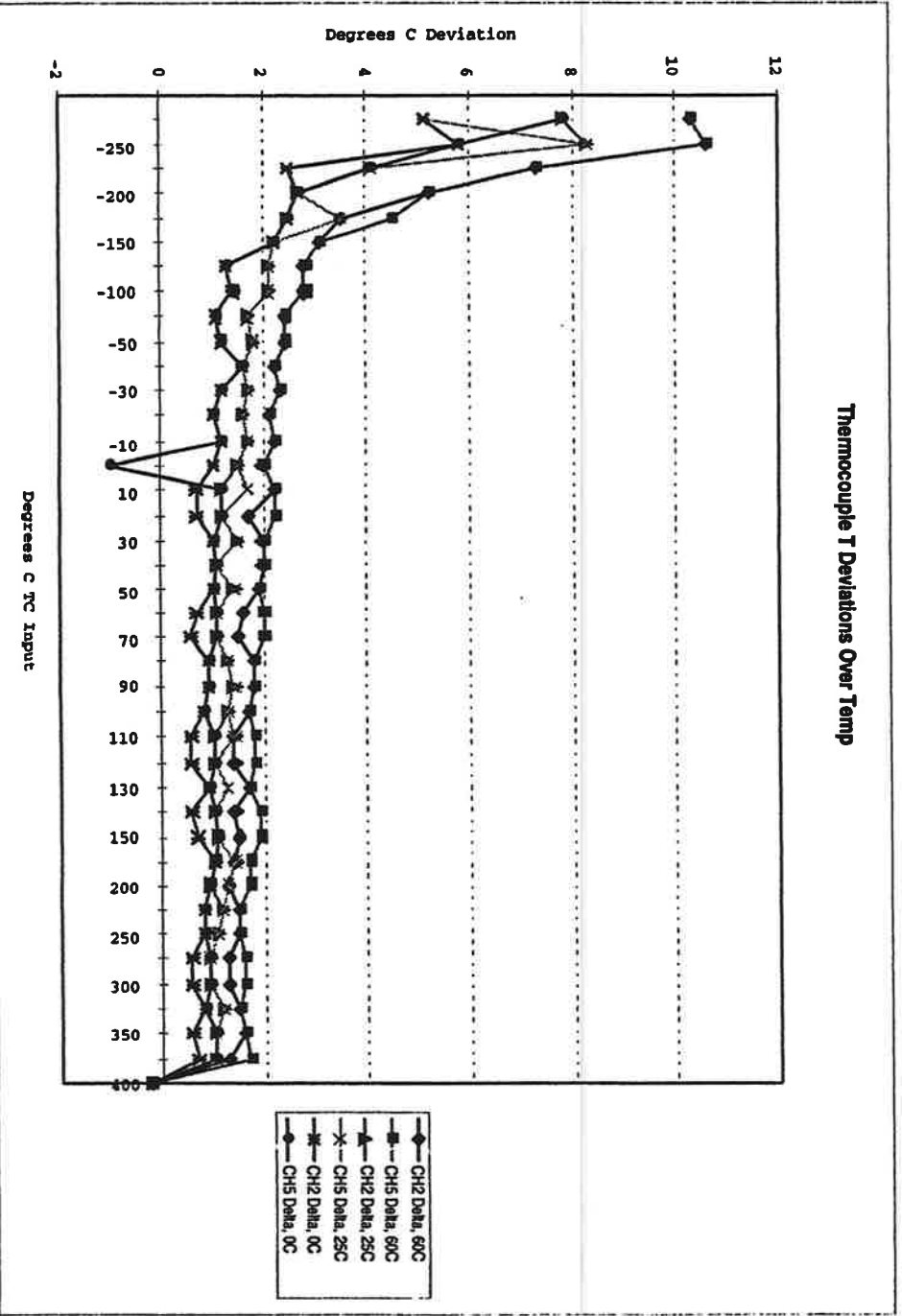
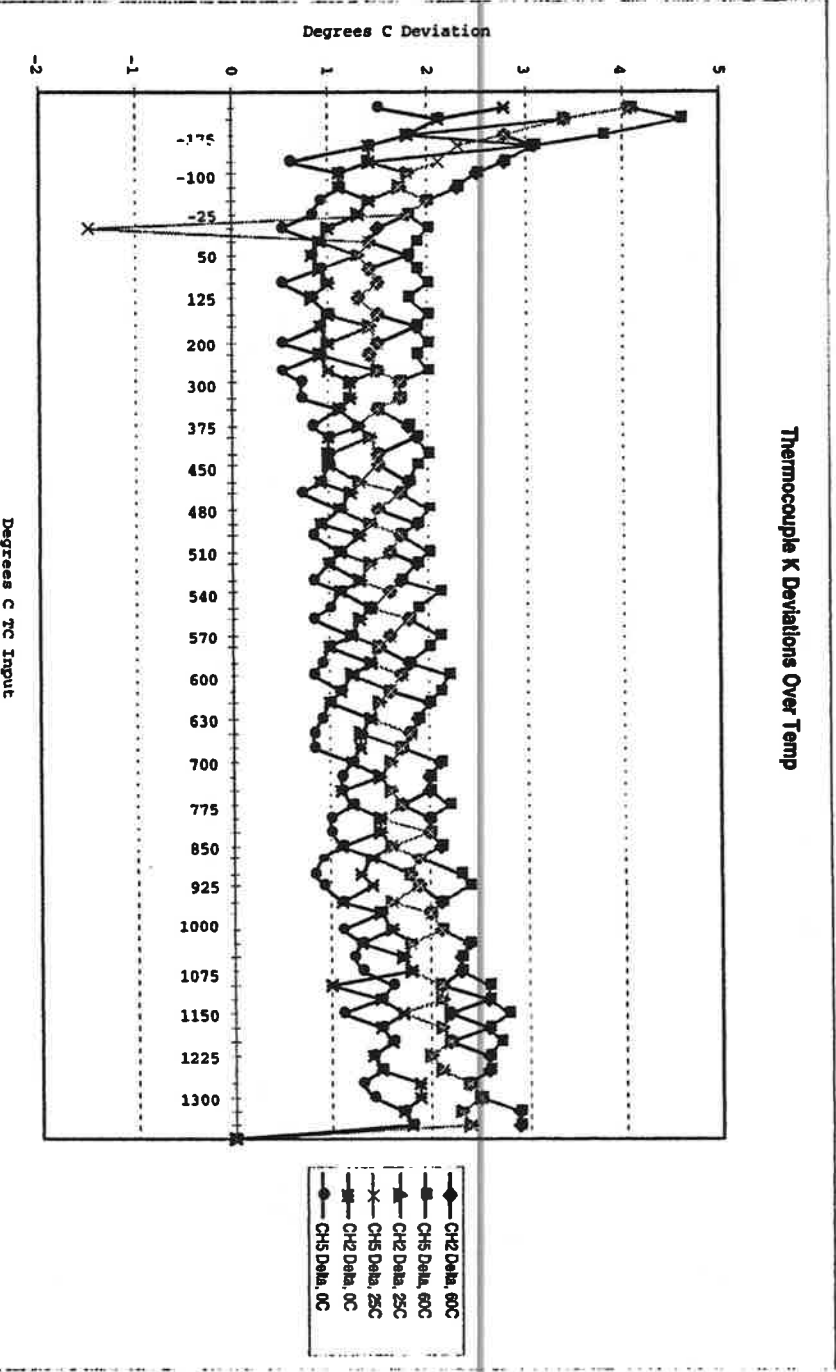
The following table provides the total error expected over the temperature range of the module (0-60C) for each thermocouple based upon the type, and the given reference point, at the extremes of the temperature range (0 or 60C). The calculations are based on maximum hardware/software error, and maximum CJC inaccuracy over temperature.

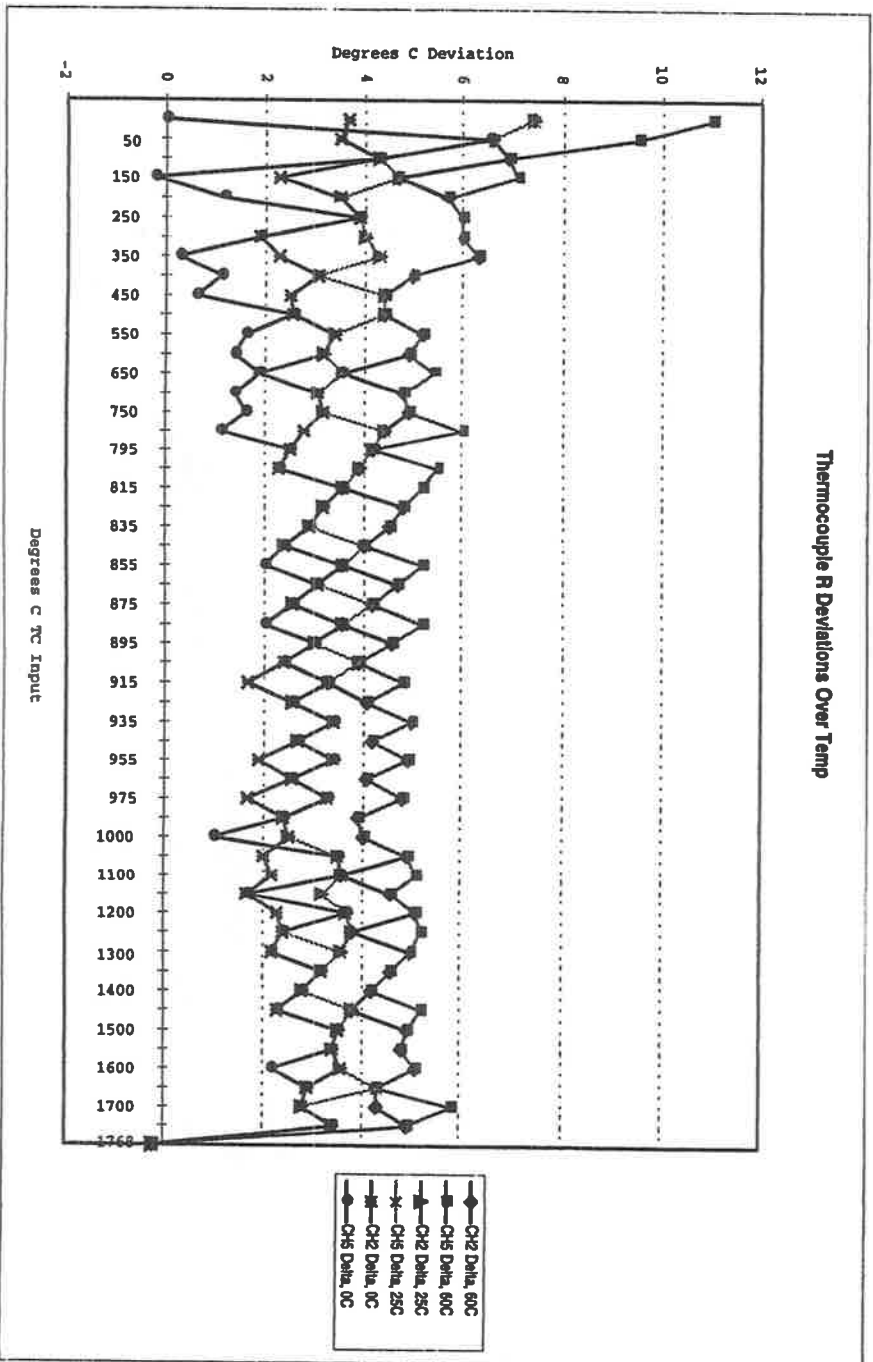
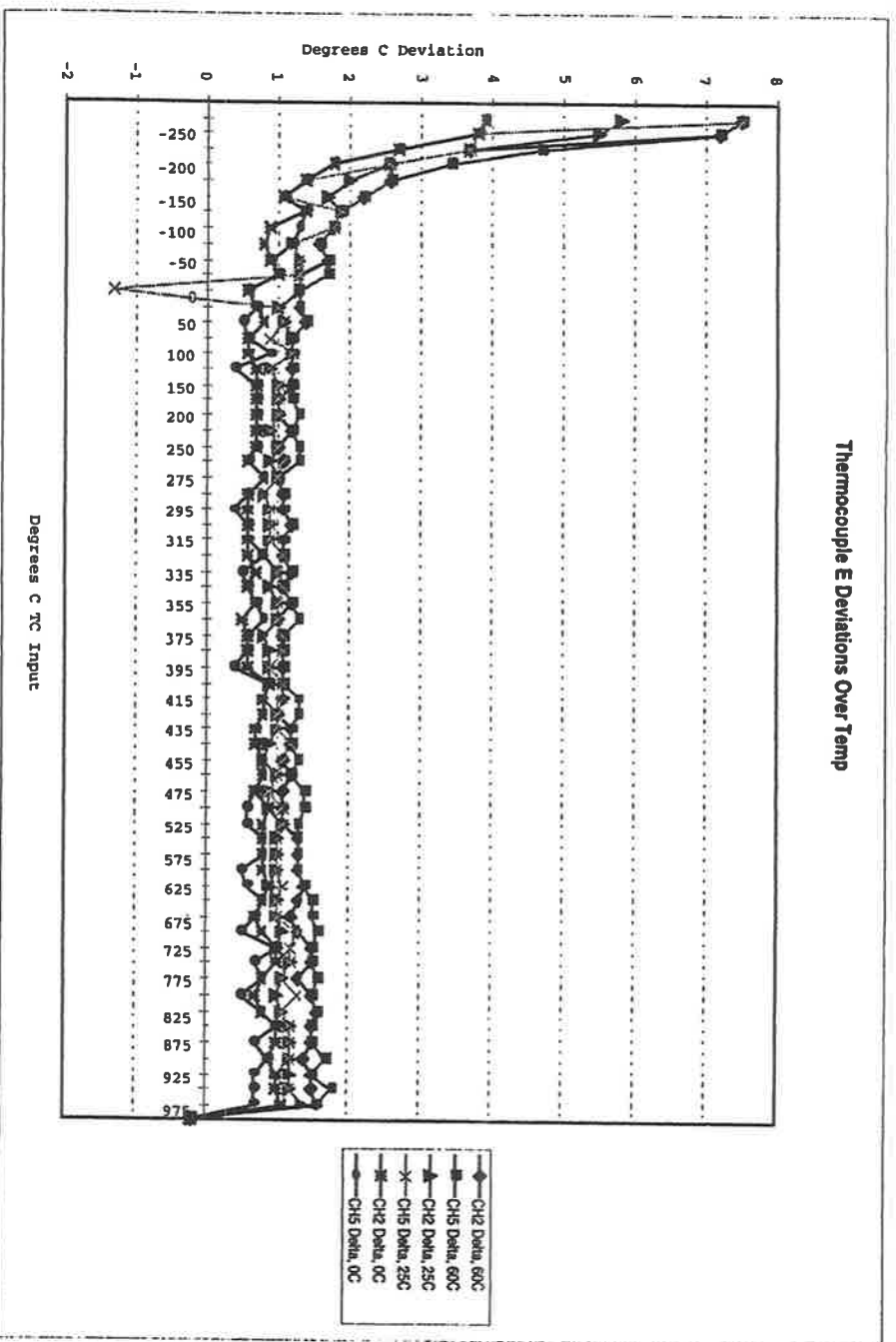
Thermocouple Type	Degrees C Thermocouple Reference Point	Error stated in Deg. C
J	275C	±3.0C
K	550C	±3.0 C
T	65C	±3.4C
E	365C	±2.5C
R	885C	±6.5C
S	885C	±7.2C
B	1060C	±8.4C
N	500C	±3.0C

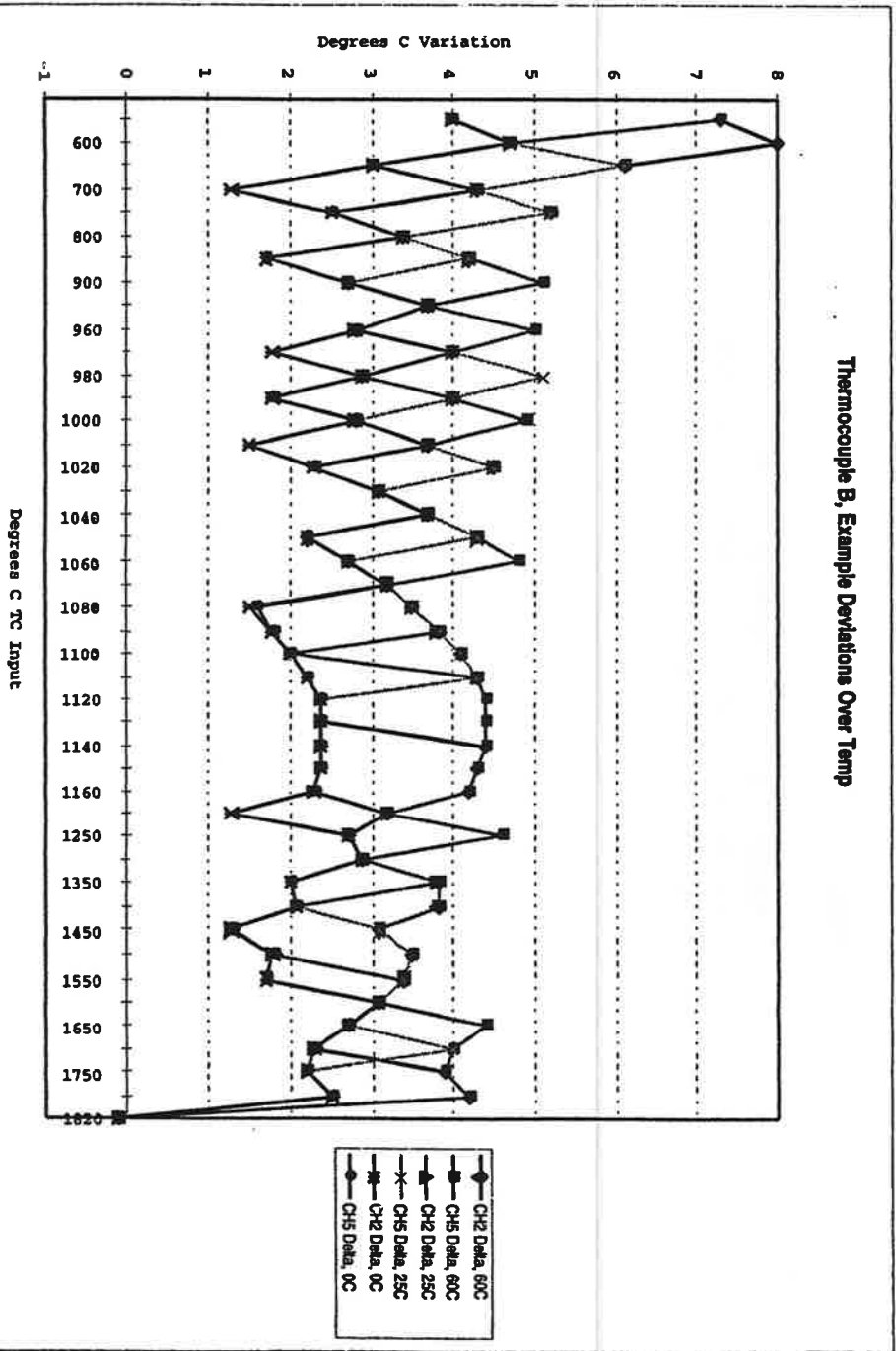
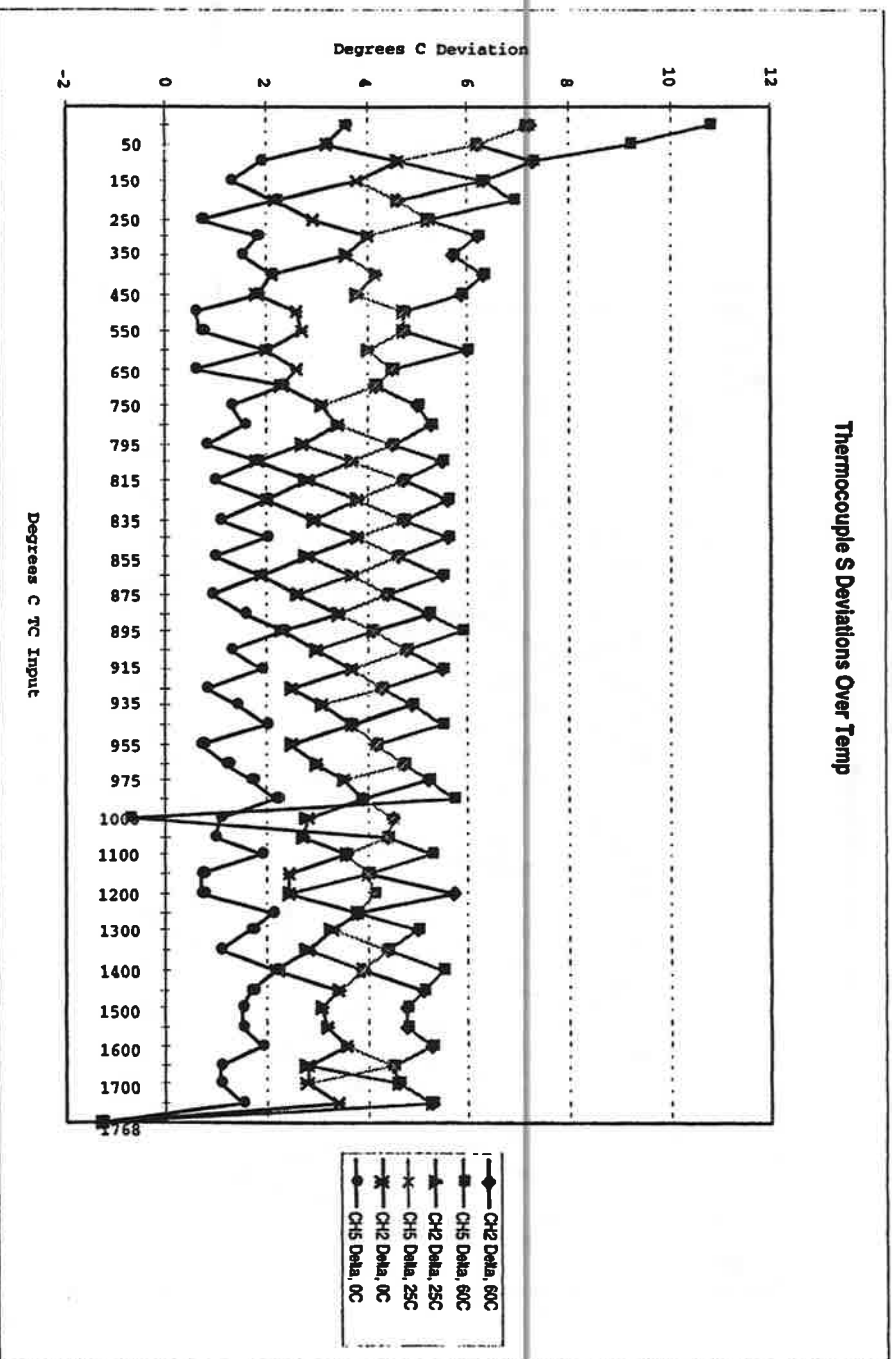
The diagrams that follow for each thermocouple type, give data for a sample module over the input range of the thermocouple, over temperature. Thermocouples are usually parabolic in their μV to degrees C curves. Normally, at the ends of any given thermocouple range, the ratio of change in temperature increases as a result of a change in voltage. In other words, at the ends, a smaller change in voltage results in a larger change in degrees. The data that follows gives an idea of a sample module's error over the thermocouple range, versus at a single reference point as provided with the tables above.

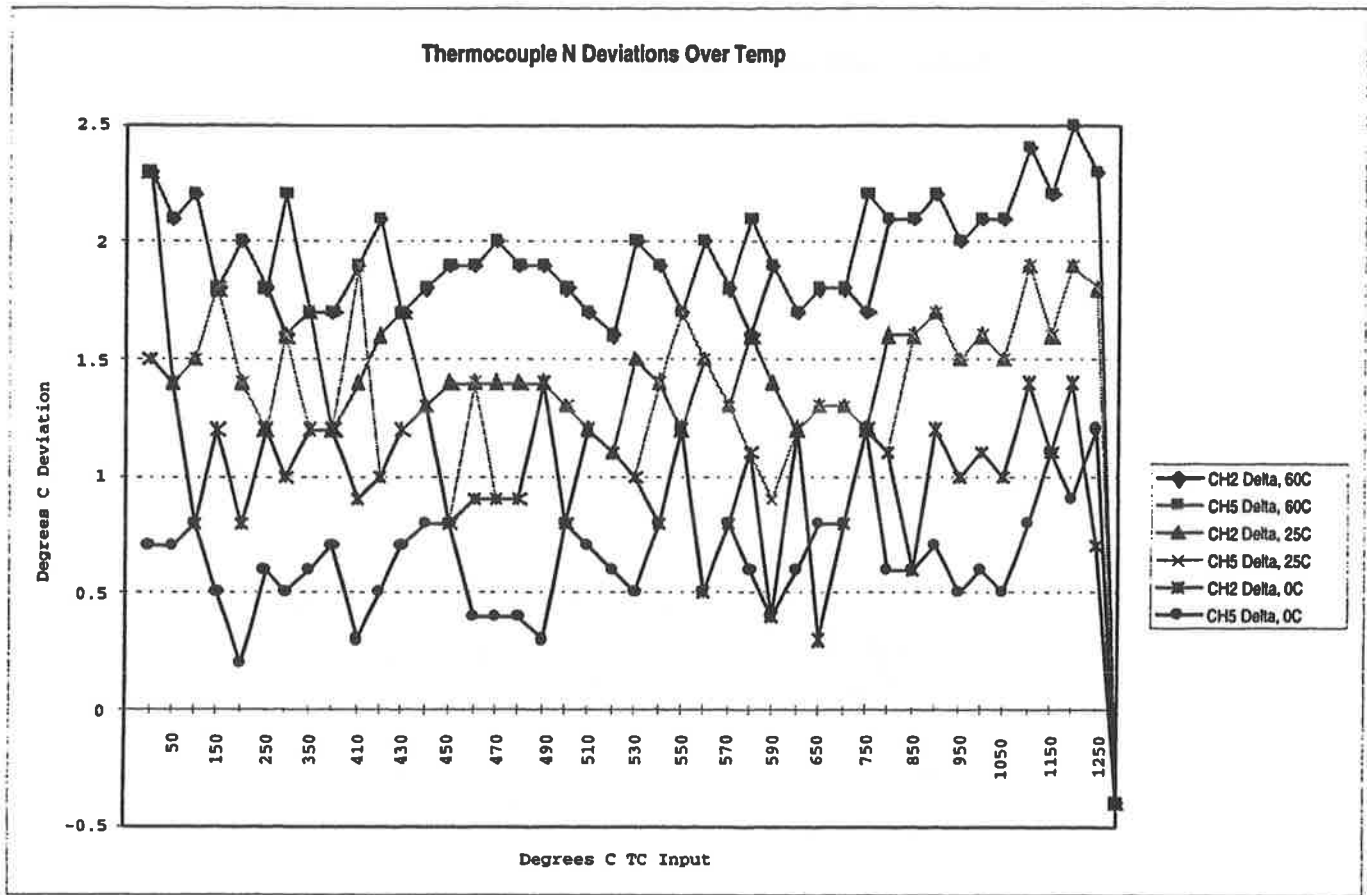
Thermocouple J Deviations Over Temp











Millivolt

For millivolt inputs, the error is $\pm 30\mu\text{V}$ typical at 25C, and $\pm 120\mu\text{V}$ maximum over temp. CJC compensation does not affect the millivolt inputs in terms of accuracy.

Thermocouple Descriptions

The following information was extracted from the NIST Monograph 175 issued in January 1990, which supersedes the IPTS-68 Monograph 125 issued in March 1974. NIST Monograph 175 is provided by the United States Department of Commerce, National Institute of Standards and Technology.

International Temperature Scale of 1990

The ITS-90 [1,3] is realized, maintained and disseminated by NIST to provide a standard scale of temperature for use in science and industry in the United States. This scale was adopted by the International Committee of Weights and Measures (CIPM) at its meeting in September 1989, and it became the official international temperature scale on January 1, 1990. The ITS-90 supersedes the IPTS-68(75) [2] and the 1976 Provisional 0.5 K to 30 K Temperature Scale (EPT-76) [4].

The adoption of the ITS-90 has removed several deficiencies and limitations associated with IPTS-68. Temperatures on the ITS-90 are in closer agreement with thermodynamic values than were those of the IPTS-68 and EPT-76. Additionally, improvements have been made in the non-uniqueness and reproducibility of the temperature scale, especially in the temperature range from $t_{68} = 630.74\text{C}$ to 1064.43C , where the type S thermocouple was the standard interpolating device on the IPTS-68.

For additional technical information regarding ITS-90, refer to the NIST Monograph 175.

J Type Thermocouples

Iron Versus Copper-Nickel Alloy (SAMA) Thermocouples

This is one of the most common types of industrial thermocouples, because of its relatively high Seebeck coefficient and low cost. It has been reported that more than 200 tons of type J materials are supplied annually to industry in this country. However, this type is least suitable for accurate thermometry because there are significant nonlinear deviations in the thermoelectric output of thermocouples obtained from different manufacturers. These irregular deviations lead to difficulties in obtaining accurate calibrations based on a limited number of calibration points. The positive thermoelement is commercially pure (99.5% Fe) iron, usually containing significant impurity levels of carbon, chromium, copper, manganese, nickel, phosphorus, silicon, and sulfur.

Thermocouple wire represents such a small fraction of the total production of commercial iron wire that the producers do not control the chemical composition to maintain constant thermoelectric properties. Instead, instrument companies and thermocouple fabricators select material most suitable for the thermocouple usage. The total and specific types of impurities that occur in commercial iron change with time,

location of primary ores, and methods of smelting. Many unusual lots have been selected in the past, for example spools of industrial iron wire and even scrapped rails from an elevated train line. At present, iron wire that most closely fits these tables has about 0.25 percent manganese and 0.12 percent copper, plus other minor impurities.

The negative thermoelement for type J thermocouples is a copper-nickel alloy known ambiguously as constantan. The word constantan has commonly referred to copper-nickel alloys containing anywhere from 45 to 60 percent copper, plus minor impurities of carbon, cobalt, iron, and manganese. Constantan for type J thermocouples usually contains about 55 percent copper, 45 percent nickel, and a small but thermoelectrically significant amount of cobalt, iron, and manganese, about 0.1 percent or more. **It should be emphasized that type JN thermoelements are NOT generally interchangeable with type TN (or EN) thermoelements, although they are all referred to as "constantan".** In order to provide some differentiation in nomenclature, type JN is often referred to as SAMA constantan.

Type J thermocouples are recommended by the ASTM [5] for use in the temperature range from 0C to 760C in vacuum, oxidizing, reducing, or inert atmospheres. If used for extended times in air above 500C, heavy gage wires are recommended because the oxidation rate is rapid at elevated temperatures. Oxidation normally causes a gradual decrease in the thermoelectric voltage of the thermocouple with time. Because iron rusts in moist atmospheres and may become brittle, type J thermocouples are not recommended for use below 0C. In addition, they should not be used unprotected in sulfurous atmospheres above 500C.

The positive thermoelement, iron, is relatively insensitive to composition changes under thermal neutron irradiation, but does exhibit a slight increase in manganese content. The negative thermoelement, a copper-nickel alloy, is subject to substantial composition changes under thermal neutron irradiation since copper is converted to nickel and zinc.

Iron undergoes a magnetic transformation near 769C and an alpha-gamma crystal transformation near 910C [6]. Both of these transformations, especially the latter, seriously affect the thermoelectric properties of iron, and therefore of type J thermocouples. This behavior and the rapid oxidation rate of iron are the main reasons why iron versus constantan thermocouples are not recommended as a standardized type above 760C. If type J thermocouples are taken to high temperatures, especially above 900C, they will lose the accuracy of their calibration when they are recycled to lower temperatures. If type J thermocouples are used in air at temperatures above 760C, only the largest wire, AWG 8 (3.3mm) should be used and they should be held at the measured temperature for 10 to 20 minutes before readings are taken. The thermoelectric voltage of the type J thermocouples may change by as much as 40uV (or 0.6C equivalent) per minute when first brought up to temperatures near 900C.

ASTM Standard E230-87 in the 1992 Annual Book of ASTM Standards [7] specifies that the initial calibration tolerances for type J commercial thermocouples be $\pm 2.2^\circ\text{C}$ or $\pm 0.75\%$ (whichever is greater) between 0°C and 750°C . Type J thermocouples can also be supplied to meet special tolerances, which are equal to approximately one-half the standard tolerances given above. Tolerances are not specified for type J thermocouples below 0°C or above 750°C .

The suggested upper temperature limit of 760°C given in the above ASTM standard [7] for protected type J thermocouples applies to AWG 8 (3.25mm) wire. For smaller diameter wires the suggested upper temperature limit decreases to 590°C for AWG 14 (1.63mm), 480°C for AWG 20 (0.81mm), 370°C for AWG 24 or 28 (0.51mm or 0.33mm), and 320°C for AWG 30 (0.25mm). These temperature limits apply to thermocouples used in conventional closed-end protecting tubes and they are intended only as a rough guide to the user. They do not apply to sheathed thermocouples having compacted mineral oxide insulation.

K Type Thermocouples

Nickel-Chromium Alloy Versus Nickel-Aluminum Alloy Thermocouples

This type is more resistant to oxidation at elevated temperatures than types E, J, or T thermocouples and, consequently, it finds wide application at temperatures above 500°C . The positive thermoelement, KP, which is the same as EP, is an alloy that typically contains about 89 to 90% nickel, 9 to about 9.5% chromium, both silicon and iron in amounts up to about 0.5%, plus smaller amounts of other constituents such as carbon, manganese, cobalt, and niobium. The negative thermoelement, KN, is typically composed of about 95 to 96% nickel, 1 to 1.5% silicon, 1 to 2.3% aluminum, 1.6 to 3.2% manganese, up to about 0.5% cobalt and smaller amounts of other constituents such as iron, copper, and lead. Also, type KN thermoelements with modified compositions are available for use in special applications. These include alloys in which the manganese and aluminum contents are reduced or eliminated, while the silicon and cobalt contents are increased.

The low temperature research [8] by members of the NBS Cryogenics Division showed that the type K thermocouple may be used down to liquid helium temperatures (about 4K) but that its Seebeck coefficient becomes quite small below 20K. Its Seebeck coefficient at 20K is only about $4\mu\text{V/K}$, being roughly one-half that of the type E thermocouple which is the most suitable of the letter-designated thermocouples types for measurements down to 20K. Type KP and type KN thermoelements do have a relatively low thermal conductivity and good resistance to corrosion in moist atmospheres at low temperatures. The thermoelectric homogeneity of type KN thermoelements, however, was found [8] to be not quite as good as that of type EN thermoelements.

Type K thermocouples are recommended by the ASTM [5] for use at temperatures within the range -250°C to 1260°C in oxidizing or inert

atmospheres. Both the KP and the KN thermoelements are subject to deterioration by oxidation when used in air above about 750C, but even so, type K thermocouples may be used at temperatures up to about 1350C for short periods with only small changes in calibration. When oxidation occurs it normally leads to a gradual increase in the thermoelectric voltage with time. The magnitude of the change in the thermoelectric voltage and the physical life of the thermocouple will depend upon such factors as the temperature, the time at temperature, the diameter of the thermoelements and the conditions of use.

The ASTM Manual [5] indicates that type K thermocouples should not be used at high temperatures in sulfurous, reducing, or alternately oxidizing and reducing atmospheres unless suitably protected with protecting tubes. They also should not be used in vacuum (at high temperatures) for extended times because the chromium in the positive thermoelement, a nickel-chromium alloy, vaporizes out of solution and alters the calibration. In addition, their use in atmospheres that promote "green-rot" corrosion [9] of the positive thermoelement should be avoided. Such corrosion results from the preferential oxidation of chromium in atmospheres with low, but not negligible, oxygen content and can lead to a large decrease in the thermoelectric voltage of the thermocouple with time. The effect is most serious at temperatures between 800C and 1050C.

Both thermoelements of type K thermocouples are reasonably stable, thermoelectrically, under neutron irradiation since the resulting changes in their chemical compositions due to transmutation are small. The KN thermoelements are somewhat less stable than the KP thermoelements in that they experience a small increase in the iron content accompanied by a slight decrease in the manganese and cobalt contents.

ASTM Standard E230-87 in the 1992 Annual Book of ASTM Standards [7] specifies that the initial calibration tolerances for type K commercial thermocouples be $\pm 2.2\text{C}$ or $\pm 0.75\%$ (whichever is greater) between 0C and 1250C, and $\pm 2.2\text{C}$ or $\pm 2\%$ (whichever is greater) between -200C and 0C. In the 0C to 1250C range, type K thermocouples can be supplied to meet special tolerances that are equal to approximately one-half the standard tolerances given above. Type K thermocouple materials are normally supplied to meet the tolerances specified for temperatures above 0C. However, the same materials may not satisfy the tolerances specified for the -200C to 0C range. If materials are required to meet the tolerances below 0C, this should be specified when they are purchased.

The suggested upper temperature limit of 1260C given in the ASTM standard [7] for protected type K thermocouples applies to AWG 8 (3.25mm) wire. It decreases to 1090C for AWG 14 (1.63mm), 980C for AWG 20 (0.81mm), 870 for AWG 24 or 28 (0.51mm or 0.33mm), and 760C for AWG 30 (0.25mm). These temperature limits apply to thermocouples used in conventional closed-end protecting tubes and they

are intended only as a rough guide to the user. They do not apply to thermocouples having compacted mineral oxide insulation.

T Type Thermocouples

Copper Versus Copper-Nickel Alloy Thermocouples

This type is one of the oldest and most popular thermocouples for determining temperatures within the range from about 370C down to the triple point of neon (-248.5939C). Its positive thermoelement, TP, is typically copper of high electrical conductivity and low oxygen content that conforms to ASTM Specification B3 for soft or annealed bare copper wire. Such material is about 99.95% pure copper with an oxygen content varying from 0.02 to 0.07% (depending upon sulfur content) and with other impurities totaling about 0.01%. Above about -200C the thermoelectric properties of type TP thermoelements, which satisfy the above conditions, are exceptionally uniform and exhibit little variation between lots. Below about -200C the thermoelectric properties are affected more strongly by the presence of dilute transition metal solutes, particularly iron.

The negative thermoelement, TN or EN, is a copper-nickel alloy known ambiguously as constantan. The word constantan refers to a family of copper-nickel alloys containing anywhere from 45 to 60% copper. These alloys also typically contain small percentages of cobalt, manganese and iron, as well as trace impurities of other elements such as carbon, magnesium, silicon, etc. The constantan for type T thermocouples usually contains about 55% copper, 45% nickel, and small but thermoelectrically significant amounts, about 0.1% or larger, of cobalt, iron, or manganese. **It should be emphasized that type TN (or EN) thermoelements are NOT generally interchangeable with type JN thermoelements although they are all referred to as "constantan".** In order to provide some differentiation in nomenclature, type TN (or EN) is often referred to as Adams' (or RP1080) constantan and type JN is usually referred to as SAMA constantan.

The thermoelectric relations for type TN and type EN thermoelements are the same, that is the voltage versus temperature equations and tables for platinum versus type TN thermoelements apply to both types of thermoelements over the temperature range recommended for each thermocouple type. However, it should not be assumed that type TN and type EN thermoelements may be used interchangeably or that they have the same commercial initial calibration tolerances.

The low temperature research [8] by members of the NBS Cryogenics Division showed that the type T thermocouple may be used down to liquid helium temperatures (about 4K) but that its Seebeck coefficient becomes quite small below 20K. Its Seebeck coefficient at 20K is only about 5.6 μ V/K, being roughly two-thirds that of the type E thermocouple. The thermoelectric homogeneity of most type TP and type TN (or EN) thermoelements is reasonably good. There is considerable variability, however, in the thermoelectric properties of type TP thermoelements

below about 70K caused by variations in the amounts and types of impurities present in these nearly pure materials. The high thermal conductivity of the type TP thermoelements can also be troublesome in precise applications. For these reasons, type T thermocouples are generally unsuitable for use below about 20K. Type E thermocouples are recommended as the most suitable of the letter-designated thermocouple types for general low-temperature use, since they offer the best overall combination of desirable properties.

Type T thermocouples are recommended by the ASTM [5] for use in the temperature range from -200C to 370C in vacuum or in oxidizing, reducing or inert atmospheres. The suggested upper temperature limit for continuous service of protected type T thermocouples is set at 370C for AWG 14 (1.63mm) thermoelements since type TP thermoelements oxidize rapidly above this temperature. However, the thermoelectric properties of type TP thermoelements are apparently not grossly affected by oxidation since negligible changes in the thermoelectric voltage were observed at NBS [10] for AWG 12, 18, and 22 type TP thermoelements during 30 hours of heating in air at 500C. At this temperature the type TN thermoelements have good resistance to oxidation and exhibit only small voltage changes heated in air for long periods of time, as shown by the studies of Dahl [11]. Higher operating temperatures, up to at least 800C, are possible in inert atmospheres where the deterioration of the type TP thermoelement is no longer a problem. The use of type T thermocouples in hydrogen atmospheres at temperatures above about 370C is not recommended since type TP thermoelements may become brittle.

Type T thermocouples are not well suited for use in nuclear environments since both thermoelements are subject to significant changes in composition under thermal neutron irradiation. The copper in the thermoelements is converted to nickel and zinc.

Because of the high thermal conductivity of type TP thermoelements, special care should be exercised when using the thermocouples to ensure that the measuring and reference junctions assume the desired temperatures.

ASTM Standard E230-87 in the 1992 Annual Book of ASTM Standards [7] specifies that the initial calibration tolerances for type T commercial thermocouples be $\pm 1\text{C}$ or $\pm 0.75\%$ (whichever is greater) between 0C and 350C, and $\pm 1\text{C}$ or $\pm 1.5\%$ (whichever is greater) between -200C and 0C. Type T thermocouples can also be supplied to meet special tolerances which are equal to approximately one-half the standard tolerances given above. Type T thermocouple materials are normally supplied to meet the tolerances specified for temperatures above 0C. However, the same materials may not satisfy the tolerances specified for the -200C to 0C range. If materials are required to meet the tolerances below 0C, this should be specified when they are purchased.

The suggested upper temperature limit of 370C given in the ASTM standard [7] for protected type T thermocouples applies to AWG 14 (1.63mm) wire. It decreases to 260C for AWG 20 (0.81mm), 200C for AWG 24 or 28 (0.51mm or 0.33mm), and 150C for AWG 30 (0.25mm). These temperature limits apply to thermocouples used in conventional closed-end protecting tubes and they are intended only as a rough guide to the user. They do not apply to thermocouples having compacted mineral oxide insulation.

E Type Thermocouples

Nickel-Chromium Alloy Versus Copper-Nickel Alloy Thermocouples

This type, and the other base-metal types, do not have specific chemical compositions given in standards; rather, any materials whose emf-temperature relationship agrees with that of the specified reference table within certain tolerances can be considered to be a type E thermocouple. The positive thermoelement, EP, is the same material as KP. The negative thermoelement, EN, is the same material as TN.

The low-temperature research [8] by members of the NBS Cryogenics Division showed that type E thermocouples are very useful down to liquid hydrogen temperatures (n.b.p. about 20.3K) where their Seebeck coefficient is about 8 μ V/C. They may even be used down to liquid helium temperatures (4.2K) although their Seebeck coefficient becomes quite low, only about 2 μ V/C at 4K. Both thermoelements of type E thermocouples have a relatively low thermal conductivity, good resistance to corrosion in moist atmospheres, and reasonably good homogeneity. For these three reasons and their relatively high Seebeck coefficients, type E thermocouples have been recommended [8] as the most useful of the letter-designated thermocouple types for low-temperature measurements.

For measurements below 20K, the non-letter-designated thermocouple, KP versus gold-0.07 at .% iron, is recommended. The properties of this thermocouple have been described by Sparks and Powell [12].

Type E thermocouples also have the largest Seebeck coefficient above 0C for any of the letter-designated thermocouples. For that reason they are being used more often whenever environmental conditions permit.

Type E thermocouples are recommended by the ASTM [5] for use in the temperature range from -200C to 900C in oxidizing or inert atmospheres. If used for extended times in air above 500C, heavy gage wires are recommended because the oxidation rate is rapid at elevated temperatures. About 50 years ago, Dahl [11] studies the thermoelectric stability of EP and EN type alloys when heated in air at elevated temperatures and his work should be consulted for details. More recent stability data on these alloys in air were reported by Burley et al. [13]. Type E thermocouples should not be used at high temperatures in sulfurous, reducing, or alternately reducing and oxidizing atmospheres

unless suitably protected with protecting tubes. They also should not be used in vacuum (at high temperatures) for extended times because the chromium in the positive thermoelement, a nickel-chromium alloy, vaporizes out of solution and alters the calibration. In addition, their use in atmospheres that promote "green-rot" corrosion of the positive thermoelement should be avoided. Such corrosion results from the preferential oxidation of chromium in atmospheres with low, but not negligible, oxygen content and can lead to a large decrease in the thermoelectric voltage of the thermocouple with time. The effect is most serious at temperatures between 800C and 1050C.

The negative thermoelement, a copper-nickel alloy, is subject to composition changes under thermal neutron irradiation since the copper is converted to nickel and zinc.

Neither thermoelement of type E thermocouples is very sensitive to minor changes in composition or impurity level because both are already heavily alloyed. Similarly, they are also not extremely sensitive to minor differences in heat treatment (provided that the treatment does not violate any of the restrictions mentioned above). For most general applications, they may be used with the heat treatment given by the wire manufacturers. However, when the highest accuracy is sought, additional preparatory heat treatments may be desirable in order to enhance their performance. Details on this and other phases of the use and behavior of type KP thermoelements (EP is the same as KP) are given in publications by Pots and McElroy [14], by Burley and Ackland [15], by Burley [16], by Wang and Starr [17,18], by Bentley [19], and by Kollie et al. [20].

ASTM Standard E230-87 in the 1992 Annual Book of ASTM Standards [7] specifies that the initial calibration tolerances for type E commercial thermocouples be $\pm 1.7C$ or $\pm 0.5\%$ (whichever is greater) between 0C and 900C, and $\pm 1.7C$ or $\pm 1\%$ (whichever is greater) between -200C and 0C. Type E thermocouples can also be supplied to meet special tolerances which are equal to $\pm 1C$ or $\pm 0.4\%$ (whichever is greater) between 0C and 900C, and $\pm 1C$ or $\pm 0.5\%$ (whichever is greater) between -200C and 0C. Type E thermocouple materials are normally supplied to meet the tolerances specified for temperatures above 0C. The same materials, however, may not satisfy the tolerances specified for the -200C to 0C range. If materials are required to meet the tolerances below 0C, this should be specified when they are purchased.

The suggested upper temperature limit, 870C, given in the ASTM standard [7] for protected type E thermocouples applies to AWG 8 (3.25mm) wire. It decreases to 650C for AWG 14 (1.63mm), 540C for AWG 20 (0.81mm), 430C for AWG 24 or 28 (0.51mm or 0.33mm), and 370C for AWG 30 (0.25mm). These temperature limits apply to thermocouples used in conventional closed-end protecting tubes and they are intended only as a rough guide to the user. They do not apply to thermocouples having compacted mineral oxide insulation.

R Type Thermocouples

Platinum-13% Rhodium Alloy Versus Platinum Thermocouples

This type is often referred to by the nominal chemical composition of its positive (RP) thermoelement: platinum-13% rhodium. The negative (RN) thermoelement is commercially-available platinum that has a nominal purity of 99.99% [21]. An industrial consensus standard (ASTM E1159-87) specifies that rhodium having a nominal purity of 99.98% shall be alloyed with platinum of 99.99% purity to produce the positive thermoelement, which typically contains 13.00 \pm 0.05% rhodium by weight. This consensus standard [21] describes the purity of commercial type R materials that are used in many industrial thermometry applications and that meet the calibration tolerances described later in this section. It does not cover, however, the higher-purity, reference-grade materials that traditionally were used to construct thermocouples used as transfer standards and reference thermometers in various laboratory applications and to develop reference functions and tables [22,23]. The higher purity alloy material typically contains less than 500 atomic ppm of impurities and the platinum less than 100 atomic ppm of impurities [22]. Differences between such high purity commercial material and the platinum thermoelectric reference standard, Pt-67, are described in [22] and [23].

A reference function for the type R thermocouple, based on the ITS-90 and the SI volt, was determined recently from new data obtained in a collaborative effort by NIST and NPL. The results of this international collaboration were reported by Burns et al [23]. The function was used to compute the reference table given in this monograph.

Type R thermocouples have about a 12% larger Seebeck coefficient than do Type S thermocouples over much of the range. Type R thermocouples were not standard interpolating instruments on the IPTS-68 for the 630.74C to gold freezing-point range. Other than these two points, and remarks regarding history and composition, all of the precautions and restrictions on usage given in the section on type S thermocouples also apply to type R thermocouples. Glawe and Szaniszlo [24], and Walker et al [25,26] have determined the effects that prolonged exposure at elevated temperatures ($>1200\text{C}$) in vacuum, air, and argon atmospheres have on the thermoelectric voltages of type R thermocouples.

ASTM Standard E230-87 in the 1992 Annual Book of ASTM Standards [7] specifies that the initial calibration tolerances for type R commercial thermocouples be $\pm 1.5\text{C}$ or $\pm 0.25\%$ (whichever is greater) between 0C and 1450C. Type R thermocouples can be supplied to meet special tolerances of $\pm 0.6\text{C}$ or $\pm 0.1\%$ (whichever is greater).

The suggested upper temperature limit, 1480C, given in the ASTM standard [7] for protected type R thermocouples applies to AWG 24 (0.51mm) wire. This temperature limit applies to thermocouples used in conventional closed-end protecting tubes and it is intended only as a

rough guide to the user. It does not apply to thermocouples having compacted mineral oxide insulation.

S Type Thermocouples

Platinum-10% Rhodium Alloy Versus Platinum Thermocouples

This type is often referred to by the nominal chemical composition of its positive (SP) thermoelement: platinum-10% rhodium. The negative (SN) thermoelement is commercially available platinum that has a nominal purity of 99.99% [21]. An industrial consensus standard (ASTM E1159-87) specifies that rhodium having a nominal purity of 99.98% shall be alloyed with platinum of 99.99% purity to produce the positive thermoelement, which typically contains 10.00 +/- 0.05% rhodium by weight. The consensus standard [21] describes the purity of commercial type S materials that are used in many industrial thermometry applications and that meet the calibration tolerances described later in this section. It **does not** cover, however, the higher-purity, reference-grade materials that traditionally were used to construct thermocouples used as standard instruments of the IPTS-68, as transfer standards and reference thermometers in various laboratory applications, and to develop reference functions and tables [27,28]. The higher purity alloy material typically contains less than 500 atomic ppm of impurities and the platinum less than 100 atomic ppm of impurities [27]. Difference between such high purity commercial material and the platinum thermoelectric reference standard, Pt-67, are described in [27] and [28].

A reference function for the type S thermocouple, based on the ITS-90 and the SI volt, was determined recently from new data obtained in an international collaborative effort involving eight national laboratories. The results of this international collaboration were reported by Burns et al. [28]. The new function was used to compute the reference table given in this monograph.

Research [27] demonstrated that type S thermocouples can be used from -50C to the platinum melting-point temperature. They may be used intermittently at temperatures up to the platinum melting point and continuously up to about 1300C with only small changes in their calibrations. The ultimate useful life of the thermocouples when used at such elevated temperatures is governed primarily by physical problems of impurity diffusion and grain growth, which lead to mechanical failure. The thermocouple is most reliable when used in a clean oxidizing atmosphere (air) but may be used also in inert gaseous atmospheres or in a vacuum for short periods of time. However, type B thermocouples are generally more suitable for such applications above 1200C. Type S thermocouples should not be used in reducing atmospheres, nor in those containing metallic vapor (such as lead or zinc), nonmetallic vapors (such as arsenic, phosphorus, or sulfur) or easily reduced oxides, unless they are suitably protected with nonmetallic protecting tubes. Also, they should never be inserted directly into a metallic protection tube for use at high temperatures. The stability of type S thermocouples at high

temperatures (>1200C) depends primarily upon the quality of the materials used for protection and insulation, and has been studied by Walker et al. [25,26] and by Bentley [29]. High purity alumina, with low iron content, appears to be the most suitable material for insulating, protecting, and mechanically supporting the thermocouple wires.

Both thermoelements of type S thermocouples are sensitive to impurity contamination. In fact, type R thermocouples were developed essentially because of iron contamination effects in some British platinum-10% rhodium wires. The effects of various impurities on the thermoelectric voltages of platinum based thermocouple materials have been described by Rhys and Taimsalu [35], by Cochrane [36] and by Aliotta [37]. Impurity contamination usually causes negative changes [25,26,29] in the thermoelectric voltage of the thermocouple with time, the extent of which will depend upon the type and amount of chemical contaminant. Such changes were shown to be due mainly to the platinum thermoelement [25,26,29]. Volatilization of the rhodium from the positive thermoelement for the vapor transport of rhodium from the positive thermoelement to the pure platinum negative thermoelement also will cause negative drifts in the thermoelectric voltage. Bentley [29] demonstrated that the vapor transport of rhodium can be virtually eliminated at 1700C by using a single length of twin-bore tubing to insulate the thermoelements and that contamination of the thermocouple by impurities transferred from the alumina insulator can be reduced by heat treating the insulator prior to its use.

McLaren and Murdock [30-33] and Bentley and Jones [34] thoroughly studied the performance of type S thermocouples in the range 0C to 1100C. They described how thermally reversible effects, such as quenched-in point defects, mechanical stresses, and preferential oxidation of rhodium in the type SP thermoelement, cause chemical and physical inhomogeneities in the thermocouple and thereby limit its accuracy in this range. They emphasized the importance of annealing techniques.

The positive thermoelement is unstable in a thermal neutron flux because the rhodium converts to palladium. The negative thermoelement is relatively stable to neutron transmutation. Fast neutron bombardment, however, will cause physical damage, which will change the thermoelectric voltage unless it is annealed out.

At the gold freezing-point temperature, 1064.18C, the thermoelectric voltage of type S thermocouples increases by about 340uV (about 3%) per weight percent increase in rhodium content; the Seebeck coefficient increases by about 4% per weight percent increase at the same temperature.

ASTM Standard E230-87 in the 1992 Annual Book of ASTM Standards [7] specifies that the initial calibration tolerances for type S commercial thermocouples be $\pm 1.5C$ or $\pm 0.25\%$ (whichever is greater) between

0C and 1450C. Type S thermocouples can be supplied to meet special tolerances of $\pm 0.6\text{C}$ or $\pm 0.1\%$ (whichever is greater).

The suggested upper temperature limit, 1480C, given in the ASTM standard [7] for protected type S thermocouples applies to AWG 24 (0.51mm) wire. This temperature limit applies to thermocouples used in conventional closed-end protecting tubes and it is intended only as a rough guide to the user. It does not apply to thermocouples having compacted mineral oxide insulation.

B Type Thermocouples

Platinum-30% Rhodium Alloy Versus Platinum-6% Rhodium Alloy Thermocouples

This type is sometimes referred to by the nominal chemical composition of its thermoelements: platinum - 30% rhodium versus platinum - 6% rhodium or "30-6". The positive (BP) thermoelement typically contains 29.60 \pm 0.2% rhodium and the negative (BN) thermoelement usually contains 6.12 \pm 0.02% rhodium. The effect of differences in rhodium content are described later in this section. An industrial consensus standard [21] (ASTM E1159-87) specifies that rhodium having a purity of 99.98% shall be alloyed with platinum of 99.99% purity to produce the thermoelements. This consensus standard [21] describes the purity of commercial type B materials that are used in many industrial thermometry applications that meet the calibration tolerances described later in this section. Both thermoelements will typically have significant impurities of elements such as palladium, iridium, iron, and silicon [38].

Studies by Ehringer [39], Walker et al. [25,26], and Glawe and Szanislo [24] have demonstrated that thermocouples, in which both legs are platinum-rhodium alloys, are suitable for reliable temperature measurements at high temperatures. Such thermocouples have been shown to offer the following distinct advantages over types R and S thermocouples at high temperatures: (1) improved stability, (2) increased mechanical strength, and (3) higher operating temperatures.

The research by Burns and Gallagher [38] indicated that the 30-6 thermocouple can be used intermittently (for several hours) up to 1790C and continuously (for several hundred hours) at temperatures up to about 1700C with only small changes in calibration. The maximum temperature limit for the thermocouple is governed, primarily, by the melting point of the Pt-6% rhodium thermoelement which is estimated to be about 1820C by Acken [40]. The thermocouple is most reliable when used in a clean oxidizing atmosphere (air) but also has been used successfully in neutral atmospheres or vacuum by Walker et al [25,26], Hendricks and McElroy [41], and Glawe and Szanislo [24]. The stability of the thermocouple at high temperatures has been shown by Walker et al. [25,26] to depend, primarily, on the quality of the materials used for protecting and insulating the thermocouple. High purity alumina with low iron-content appears to be the most suitable material for the purpose.

Type B thermocouples should not be used in reducing atmospheres, nor those containing deleterious vapors or other contaminants that are reactive with the platinum group metals [42], unless suitably protected with nonmetallic protecting tubes. They should never be used in metallic protecting tubes at high temperatures.

The Seebeck coefficient of type B thermocouples decreases with decreasing temperature below about 1600C and becomes almost negligible at room temperature. Consequently, in most applications the reference junction temperature of the thermocouple does not need to be controlled or even known, as long as it is between 0C and 50C. For example, the voltage developed by the thermocouple, with the reference junction at 0C, undergoes a reversal in sign at about 42C, and between 0C and 50C varies from a minimum of -2.6uV near 21C to a maximum of 2.3uV at 50C. Therefore, in use, if the reference junction of the thermocouple is within the range 0C to 50C, then a 0C reference junction temperature can be assumed and the error introduced will not exceed 3uV. At temperatures above 1100C, an additional measurement error of 3uV (about 0.3C) would be insignificant in most instances.

ASTM Standard E230-87 in the 1992 Annual Book of ASTM Standards [7] specifies that the initial calibration tolerances for type B commercial thermocouples be +/-0.5% between 870C and 1700C. Type B thermocouples can also be supplied to meet special tolerances of +/-0.25%. Tolerances are not specified for type B thermocouples below 870C.

The suggested upper temperature limit of 1700C given in the ASTM standard [7] for protected type B thermocouples applies to AWG 24 (0.51mm) wire. This temperature limit applies to thermocouples used in conventional closed-end protecting tubes and it is intended only as a rough guide to the user. It does not apply to thermocouples having compacted mineral oxide insulation.

N Type Thermocouples

Nickel-Chromium-Silicon Alloy Versus Nickel-Silicon-Magnesium Alloy Thermocouples

This type is the newest of the letter-designated thermocouples. It offers higher thermoelectric stability in air above 1000C and better air-oxidation resistance than types E, J, and K thermocouples. The positive thermoelement, NP, is an alloy that typically contains about 84% nickel, 14 to 14.4% chromium, 1.3 to 1.6% silicon, plus small amounts (usually not exceeding about 0.1%) of other elements such as magnesium, iron, carbon, and cobalt. The negative thermoelement, NN, is an alloy that typically contains about 95% nickel, 4.2 to 4.6% silicon, 0.5 to 1.5% magnesium, plus minor impurities of iron, cobalt, manganese and carbon totaling about 0.1 to 0.3%. The type NP and NN alloys were known originally [16] as nicrosil and nisil, respectively.

The research reported in NBS Monograph 161 showed that the type N thermocouple may be used down to liquid helium temperatures (about 4K) but that its Seebeck coefficient becomes very small below 20K. Its Seebeck coefficient at 20K is about 2.5uV/K, roughly one-third that of type E thermocouples which are the most suitable of the letter-designated thermocouples types for measurements down to 20K. Nevertheless, types NP and NN thermoelements do have a relatively low thermal conductivity and good resistance to corrosion in moist atmospheres at low temperatures.

Type N thermocouples are best suited for use in oxidizing or inert atmospheres. Their suggested upper temperature limit, when used in conventional closed-end protecting tubes, is set at 1260C by the ASTM [7] for 3.25mm diameter thermoelements. Their maximum upper temperature limit is defined by the melting temperature of the thermoelements, which are nominally 1410C for type NP and 1340C for type NN [5]. The thermoelectric stability and physical life of type N thermocouples when used in air at elevated temperatures will depend upon factors such as the temperature, the time at temperature, the diameter of the thermoelements, and the conditions of use. Their thermoelectric stability and oxidation resistance in air have been investigated and compared with those of type K thermocouples by Burley [16], by Burley and others [13,44-47], by Wang and Starr [17,43,48,49], by McLaren and Murdock [33], by Bentley [19], and by Hess [50].

Type N thermocouples, in general, are subject to the same environmental restrictions as types E and K. They are not recommended for use at high temperatures in sulfurous, reducing, or alternately oxidizing and reducing atmospheres unless suitably protected with protecting tubes. They also should not be used in vacuum (at high temperatures) for extended times because the chromium and silicon in the positive thermoelement, a nickel-chromium-silicon alloy, vaporize out of solution and alter the calibration. In addition, their use in atmospheres with low, but not negligible, oxygen content is not recommended, since it can lead to changes in calibration due to the preferential oxidation of chromium in the positive thermoelement. Nevertheless, Wang and Starr [49] studied the performances of type N thermocouples in reducing atmospheres, as well as in stagnant air, at temperatures in the 870C to 1180C range and found them to be markedly more stable thermoelectrically than type K thermocouples under similar conditions.

The performance of type N thermocouples fabricated in metal-sheathed, compacted ceramic insulated form also has been the subject of considerable study. Anderson and others [51], Bentley and Morgan [52], and Wang and Bediones [53] have evaluated the high-temperature, thermoelectric stability of thermocouples insulated with magnesium oxide and sheathed in Inconel and in stainless steel. Their studies showed that the thermoelectric instabilities of such assemblies increase rapidly with temperature above 1000C. It was found also that the smaller

the diameter of the sheath the greater the instability. Additionally, thermocouples sheathed in Inconel showed substantially less instability above 1000C than those sheathed in stainless steel. Bentley and Morgan [52] stressed the importance of using Inconel sheathing with a very low manganese content to achieve the most stable performance. The use of special Ni-Cr based alloys for sheathing to improve the chemical and physical compatibility with the thermoelements also has been investigated by Burley [54-56] and by Bentley [57-60].

Neither thermoelement of a type N thermocouple is extremely sensitive to minor differences in heat treatment (provided that the treatment does not violate any of the restrictions mentioned above). For most general applications, they may be used with the heat treatment routinely given by the wire manufacturer. Bentley [61,62], however, has reported reversible changes in the Seebeck coefficient of type NP and NN thermoelements when heated at temperatures between 200C and 1000C. These impose limitations on the accuracy obtainable with type N thermocouples. The magnitude of such changes was found to depend on the source of the thermoelements. Consequently, when the highest accuracy and stability are sought, selective testing of materials, as well as special preparatory heat treatments beyond those given by the manufacturer, will usually be necessary. Bentley's articles [61,62] should be consulted for guidelines and details.

ASTM Standard E230-87 in the 1992 Annual Book of ASTM Standards [7] specifies that the initial calibration tolerances for type N commercial thermocouples be $\pm 2.2\text{C}$ or $\pm 0.75\%$ (whichever is greater) between 0C and 1250C. Type N thermocouples can also be supplied to meet special tolerances that are equal to approximately one-half the standard tolerances given above. Tolerances are not specified for type N thermocouples below 0C.

The suggested upper temperature limit of 1260C given in the ASTM standard [7] for protected type N thermocouples applies to AWG 8 (3.25mm) wire. It decreases to 1090C for AWG 14 (1.63mm), 980C for AWG 20 (0.81mm), 870C for AWG 24 or 28 (0.51mm or 0.33mm), and 760C for AWG 30 (0.25mm). These temperature limits apply to thermocouples used in conventional closed-end protecting tubes and they are intended only as a rough guide to the user. They do not apply to thermocouples having compacted mineral oxide insulation.

References

- [1] Preston-Thomas, H. The International Temperature Scale of 1990 (ITS-90). *Metrologia* 27, 3-10; 1990. *ibid.* p. 107.
- [2] The International Practical Temperature Scale of 1968, Amended Edition of 1975. *Metrologia* 12, 7-17, 1976.
- [3] Mangum, B. W.; Furukawa, G. T. Guidelines for realizing the International Temperature Scale of 1990 (ITS-90). *Natl. Inst. Stand. Technol. Tech. Note 1265*; 1990 August. 190 p.
- [4] The 1976 Provisional 0.5 to 30 K Temperature Scale. *Metrologia* 15, 65-68; 1979.
- [5] ASTM, American Society for Testing and Materials. Manual on the use of thermocouples in temperature measurement. *Special Tech. Publ. 470B*; edited by Benedict, R. P.; Philadelphia: ASTM; 1981. 258p.
- [6] Hansen, M.; Anderko, K. Constitution of binary alloys. New York: McGraw-Hill Book Co.; 1958.
- [7] ASTM, American Society for Testing and Materials, Standard E230-87, *1992 Annual Book of ASTM Standards*. Vol. 14.03; Philadelphia: ASTM; 1992. 102-230.
- [8] Sparks, L. L.; Powell, R. L.; Hall, W. J. Reference tables for low-temperature thermocouples. *Natl. Bur. Stand. (U.S.) Monogr. 124*; 1972 June. 61p.
- [9] Starr, C.D.; Wang, T. P. Effect of oxidation on stability of thermocouples, *Proceedings of the American Society for Testing and Materials* Vol. 63, 1185-1194; 1963.
- [10] Roeser, W. F.; Dahl, A. I. Reference tables for iron-constantan and copper-constantan thermocouples. *J. Res. Natl. Bur. Stand. (U.S.)* 20, 337-355; RP1080; 1938 March.
- [11] Dahl, A. I. Stability of base-metal thermocouples in air from 800 to 2200F. *J. Res. Natl. Bur. Stand. (U.S.)* 24, 205-224; RP1278; 1940 February.
- [12] Sparks, L. L.; Powell, R. L. Low temperatures thermocouples: KP, "normal" silver, and copper versus Au-0.02 at % Fe and Au-0.07 at % Fe. *J. Res. Natl. Bur. Stand. (U.S.)* 76A(3), 263-283; 1972 May-June.
- [13] Burley, N. A.; Hess, R. M.; Howie, C. F.; Coleman, J. A. The nicrosil versus nisol thermocouple: A critical comparison with the ANSI standard letter-designated base-metal thermocouples. *Temperature: Its Measurement and Control in Science and Industry*; Vol. 5, Schooley, J. F., ed.; New York: American Institute of Physics; 1982. 1159-1166.

- [14] Potts, J. F. Jr.; McElroy, D. L. The effects of cold working, heat treatment, and oxidation on the thermal emf of nickel-base thermoelements. Herzfeld, C. M.; Brickwedde, F. G.; Dahl, A. I.; Hardy, J. D., ed. *Temperature: Its Measurement and Control in Science and Industry*; Vol. 3, Part 2; New York: Reinhold Publishing Corp.; 1962. 243-264.
- [15] Burley, N. A.; Ackland, R. G. The stability of the thermo-emf/temperature characteristics of nickel-base thermocouples. *Jour. of Australian Inst. of Metals* 12(1), 23-31; 1967.
- [16] Burley, N. A. Nicrosil and nisil: Highly stable nickel-base alloys for thermocouples. *Temperature: Its Measurement and Control in Science and Industry*; Vol. 4, Plumb, H. H., ed.; Pittsburgh: Instrument Society of America; 1972. 1677-1695.
- [17] Wang, T. P.; Starr, C. D. Electromotive force stability of nicrosil-nisil. *Journal of Testing and Evaluation* 8(4), 192-198; 1980.
- [18] Starr, C. D.; Wang, T. P. Effect of oxidation on stability of thermocouples, *Proceedings of the American Society for Testing and Materials* Vol. 63 1185-1194; 1963.
- [19] Bentley, R. E. Short-term instabilities in thermocouples containing nickel-based alloys. *High Temperatures- High Pressures* 15, 599-611; 1983.
- [20] Kollie, T. G.; Horton, J. L.; Carr, K. R.; Herskovitz, M. B.; Mossman, C. A. Temperature measurement errors with type K (Chromel vs. Alumel) thermocouples due to short-ranged ordering in Chromel. *Rev. Sci. Instrum.* 46, 1447-1461; 1975.
- [21] ASTM, American Society for Testing and Materials, Standard E1159-87, *1992 Annual Book of ASTM Standards*. Vol. 14.03; Philadelphia: ASTM; 1992. 388-389.
- [22] Bedford, R. E.; Ma, C. K.; Barber, C. R.; Chandler, T. R.; Quinn, T. J.; Burns, G. W.; Scroger, M. New reference tables for platinum 10% rhodium/platinum and platinum 13% rhodium/platinum thermocouples. *Temperature: Its Measurement and Control in Science and Industry*; Vol. 4, Part 3, p. 1585; Plumb, H. H., ed.; Pittsburgh: Instrument Society of America; 1972.
- [23] Burns, G. W.; Strouse, G. F.; Mangum, B. W.; Croarkin, M. C.; Guthrie, W. F.; Chattle, M. New reference functions for platinum-13% rhodium versus platinum (type R) and platinum-30% rhodium versus platinum-6% rhodium (type B) thermocouples based on the ITS-90. in *Temperature: Its Measurement and Control in Science and Industry*; Vol. 6; Schooley, J. F., ed.; New York: American Institute of Physics; 1992. 559-564.

- [24] Glawe, G. E.; Szaniszlo, A. J. Long-term drift of some noble- and refractory-metal thermocouples at 1600K in air, argon, and vacuum. *Temperature: Its Measurement and Control in Science and Industry*; Vol. 4; Plumb, H. H., ed.; Pittsburgh: Instrument Society of America; 1972. 1645-1662.
- [25] Walker, B. E.; Ewing, C. T.; Miller, R. R. Thermoelectric instability of some noble metal thermocouples at high temperatures. *Rev. Sci. Instrum.* **33**, 1029-1040; 1962.
- [26] Walker, B. E.; Ewing, C. T.; Miller, R. R. Study of the instability of noble metal thermocouples in vacuum. *Rev. Sci. Instrum.* **36**, 601-606; 1965.
- [27] Bedford, R. E.; Ma, C. K.; Barber, C. R.; Chandler, T. R.; Quinn, T. J.; Burns, G. W.; Scroger, M. New reference tables for platinum 10% rhodium/platinum and platinum 13% rhodium/platinum thermocouples. *Temperature: Its Measurement and Control in Science and Industry*; Vol. 4; Plumb, H. H., ed.; Pittsburgh: Instrument Society of America; 1972. 1585-1603.
- [28] Burns, G. W.; Strouse, G. F.; Mangum, B. W.; Croarkin, M. C.; Guthrie, W. F.; Marcarino, P.; Battuello, M.; Lee, H. K.; Kim, J. C.; Gam, K. S.; Rhee, C.; Chattle, M.; Arai, M.; Sakurai, H.; Pokhodun, A. I.; Moiseeva, N. P.; Perevalova, S. A.; de Groot, M. J.; Zhang, J.; Fan, K.; Wu, S. New reference functions for platinum-10% rhodium versus platinum (type S) thermocouples based on the ITS-90, Part I and Part II. in *Temperature: Its Measurement and Control in Science and Industry*; Vol. 6; Schooley, J. F., ed.; New York: American Institute of Physics; 1992. 537-546.
- [29] Bentley, R. E. Changes in Seebeck coefficient of Pt and Pt 10% Rh after use to 1700C in high-purity polycrystalline alumina. *Int. J. Thermophys.* **6**(1), 83-99; 1985.
- [30] McLaren, E. H.; Murdock, E. G. New considerations on the preparation, properties and limitations of the standard thermocouple for thermometry. *Temperature: Its Measurement and Control in Science and Industry*; Vol. 4; Plumb, H. H., ed.; Pittsburgh: Instrument Society of America; 1972. 1543-1560.
- [31] McLaren, E. H.; Murdock, E. G. The properties of Pt/PtRh thermocouples for thermometry in the range 0-1100C: I. Basic measurements with standard thermocouples. *National Research Council of Canada Publication APH 2212/NRCC 17407*; 1979.
- [32] McLaren, E. H.; Murdock, E. G. The properties of Pt/PtRh thermocouples for thermometry in the range 0-1100C: II. Effect of heat treatment on standard thermocouples. *National Research Council of Canada Publication APH 2213/NRCC 17408*; 1979.

- [33] McLaren, E. H.; Murdock, E. G. Properties of some noble and base metal thermocouples at fixed points in the range 0-1100C. *Temperature: Its Measurement and Control in Science and Industry*; Vol. 5; Schooley, J. F., ed.; New York: American Institute of Physics; 1982. 953-975.
- [34] Bentley, R. E.; Jones, T. P. Inhomogeneities in type S thermocouples when used to 1064C. *High Temperatures- High Pressures* 12, 33-45; 1980.
- [35] Rhys, D. W.; Taimsalu, P. Effect of alloying additions on the thermoelectric properties of platinum. *Engelhard Tech. Bull.* 10, 41-47; 1969.
- [36] Cochrane, J. Relationship of chemical composition to the electrical properties of platinum. *Engelhard Tech. Bull.* 11, 58-71; 1969. Also in *Temperature: Its Measurement and Control in Science and Industry*; Vol. 4; Plumb, H. H., ed.; Pittsburgh: Instrument Society of America; 1972. 1619-1632.
- [37] Aliotta, J. Effects of impurities on the thermoelectric properties of platinum. *Inst. and Control Systems*, 106-107; March 1972.
- [38] Burns, G. W.; Gallagher, J. S. Reference tables for the Pt-30 percent Rh versus Pt-6 percent Rh thermocouple. *J. Res. Natl. Bur. Stand. (U.S.)* 70C, 89-125; 1966.
- [39] Ehringer, H. Uber die lebensdauer von PtRh-thermoelementen. *Metall* 8, 596-598; 1954.
- [40] Acken, J. S. Some properties of platinum-rhodium alloys. *J. Res. Natl. Bur. Stand. (U.S.)* 12, 249; RP650; 1934.
- [41] Hendricks, J. W.; McElroy, D. L. High temperature- high vacuum thermocouple drift tests. *Environmental Quarterly*, 34-38; March 1967.
- [42] Zysk, E. D. Platinum metal thermocouples. *Temperature: Its Measurement and Control in Science and Industry*; Vol. 3; Herzfeld, C. M., ed.; New York: Reinhold Publishing Corp.; 1962. Part 2, pp. 135-156.
- [43] Starr, C. D.; Wang, T. P. A new stable nickel-base thermocouple. *Journal of Testing and Evaluation* 4(1), 42-56; 1976.
- [44] Burley, N. A.; Powell, R. L.; Burns, G. W.; Scroger, M. G. The nicrosil versus nisol thermocouple: properties and thermoelectric reference data. *Natl. Bur. Stand. (U.S.) Monogr.* 161; 1978 April. 167p.
- [45] Burley, N. A.; Jones, T. P. Practical performance of nicrosil-nisol thermocouples. *Temperature Measurement, 1975*; Billing, B. F.; Quinn, T. J., ed.; London and Bristol: Institute of Physics; 1975. 172-180.

- [46] Burley, N. A.; Hess, R. M.; Howie, C. F. Nicrosil and nisil: new nickel-based thermocouple alloys of ultra-high thermoelectric stability. *High Temperatures- High Pressures* **12**, 403-410; 1980.
- [47] Burley, N. A.; Cocking, J. L.; Burns, G. W.; Scroger, M. G. The nicrosil versus nisil thermocouple: the influence of magnesium on the thermoelectric stability and oxidation resistance of the alloys. *Temperature: Its Measurement and Control in Science and Industry*; Vol. 5, Schooley, J. F., ed.; New York: American Institute of Physics; 1982. 1129-1145.
- [48] Wang, T. P.; Starr, C. D. Nicrosil-nisil thermocouples in production furnaces in the 538C (1000F) to 1177C (2150F) range. *ISA Transactions* **18(4)**, 83-99; 1979.
- [49] Wang, T. P.; Starr, C. D. Oxidation resistance and stability of nicrosil-nisil in air and in reducing atmospheres. *Temperature: Its Measurement and Control in Science and Industry*; Vol. 5, Schooley, J. F., ed.; New York: American Institute of Physics; 1982. 1147-1157.
- [50] Hess, T. G. Nicrosil-nisil: high-performance thermocouple alloys. *ISA Transactions* **16(3)**, 81-84; 1977.
- [51] Anderson, R. L.; Lyons, J. D.; Kollie, T. G.; Christie, W. H.; Eby, R. Decalibration of sheathed thermocouples. *Temperature: Its Measurement and Control in Science and Industry*; Vol. 5., Schooley, J. F., ed.; New York: American Institute of Physics; 1982. 977-1007.
- [52] Bentley, R. E.; Morgan, T. L. Ni-based thermocouples in the mineral-insulated metal-sheathed format: thermoelectric instabilities to 1100C. *J. Phys. E: Sci. Instrum.* **19**, 262-268; 1986.
- [53] Wang, T. P.; Bediones, D. 10,000 hr. stability test of types K, N, and a Ni-Mo/Ni-Co thermocouple in air and short-term tests in reducing atmospheres. *Temperature: Its Measurement and Control in Science and Industry*; Vol. 6; Schooley, J. F., ed.; New York: American Institute of Physics; 1992. 595-600.
- [54] Burley, N. A. N-CLAD-N: A novel advanced type N integrally-sheathed thermocouple of ultra-high thermoelectric stability. *High Temperatures- High Pressures* **8**, 609-616; 1986.
- [55] Burley, N. A. A novel advanced type N integrally-sheathed thermocouple of ultra-high thermoelectric stability. *Thermal and Temperature Measurement in Science and Industry*; 3rd Int. IMEKO Conf.; Sheffield; Sept. 1987. 115-125.
- [56] Burley, N. A. 'N-CLAD-N' A novel integrally sheathed thermocouple: optimum design rationale for ultra-high thermoelectric stability. *Temperature: Its Measurement and Control in Science and Industry*; Vol. 6; Schooley, J. F., ed.; New York: American Institute of Physics; 1992. 579-584.

- [57] Bentley, R. E. The new nicrosil-sheathed type N MIMS thermocouple: an assessment of the first production batch. *Mater. Australas.* **18**(6), 16-18; 1986.
- [58] Bentley, R. E.; Russell, Nicrosil sheathed mineral-insulated type N thermocouple probes for short-term variable-immersion applications to 1100C. *Sensors and Actuators* **16**, 89-100; 1989.
- [59] Bentley, R. E. Irreversible thermoelectric changes in type K and type N thermocouple alloys within nicrosil-sheathed MIMS cable. *J. Phys. D.* **22**, 1908-1915; 1989.
- [60] Bentley, R. E. Thermoelectric behavior of Ni-based ID-MIMS thermocouples using the nicrosil-plus sheathing alloy. *Temperature: Its Measurement and Control in Science and Industry*; Vol. 6; Schooley, J. F., ed.; New York: American Institute of Physics; 1992. 585-590.
- [61] Bentley, R. E. Thermoelectric hysteresis in nicrosil and nisol. *J. Phys. E: Sci. Instrum.* **20**, 1368-1373; 1987.
- [62] Bentley, R. E. Thermoelectric hysteresis in nickel-based thermocouple alloys. *J. Phys. D.* **22**, 1902-1907; 1989.



Using Grounded Junction, Ungrounded Junction, and Exposed Junction Thermocouples

This appendix describes the types of thermocouples available, and explains the trade-offs in using them with the NT8 module.

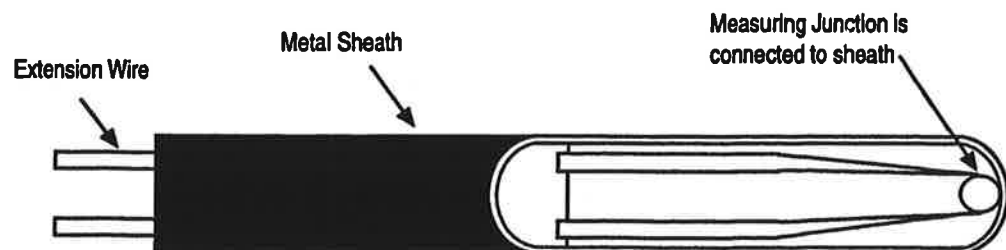
Thermocouple Types

There are three (3) types of thermocouple junctions:

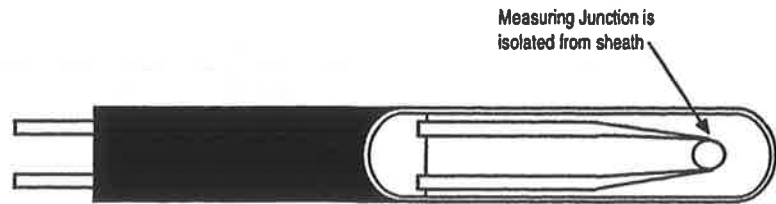
- **Grounded Junction** - The measuring junction is physically connected to the protective sheath forming a completely sealed integral junction. If the sheath is metal (or electrically conductive) then there is electrical continuity between the junction and sheath. The junction is protected from corrosive or erosive conditions. The response time approaches that of the exposed junction type.
- **Ungrounded Junction** - The measuring junction is electrically isolated from the protective metal sheath. This may also be referred to as an insulated junction. This type is often used where noise would affect the reading and for frequent or rapid temperature cycling. The response time is longer than the grounded junction.
- **Exposed Junction** - The measuring junction does not have a protective metal sheath so it is exposed. This junction style provides the fastest response time but leaves the thermocouple wires unprotected against corrosive or mechanical damage.

The illustration that follows shows each of the three (3) thermocouple types.

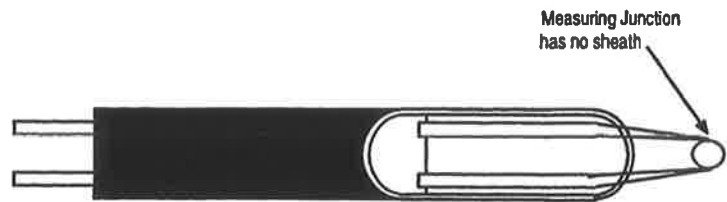
Grounded Junction



Ungrounded (Insulated) Junction



Exposed Junction



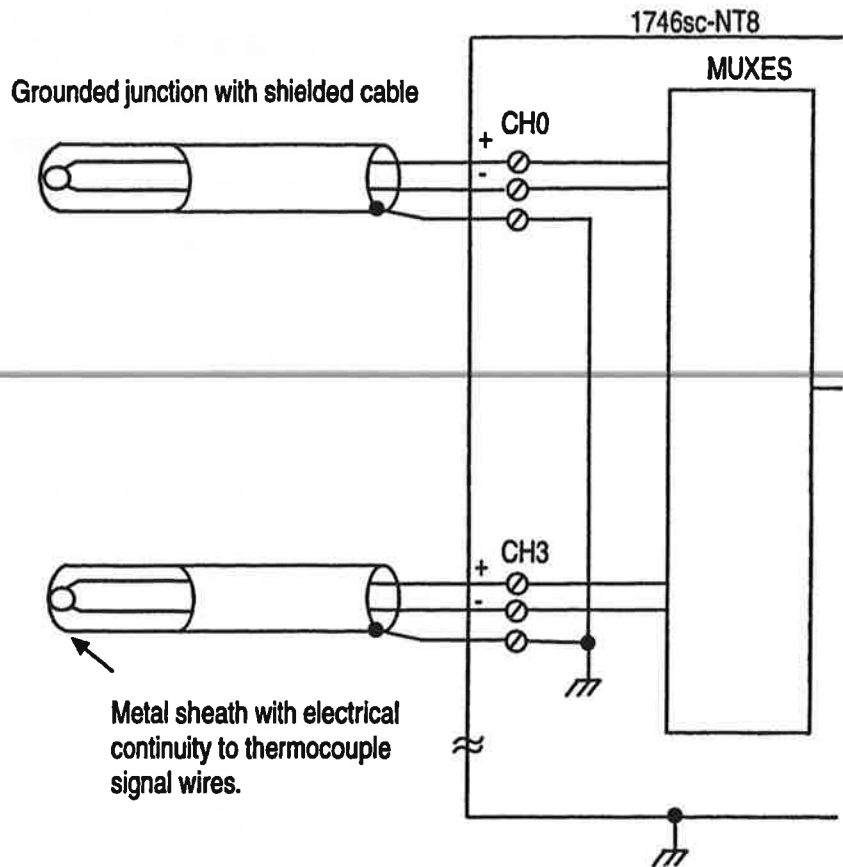
Isolation

The NT8 module provides 12.5 VDC electrical isolation channel to channel, 500 VDC electrical isolation channel to chassis ground, and 500 VDC electrical isolation channel to backplane. Care must be taken when choosing a thermocouple type, and connecting it from the environment being measured to the NT8 module. If adequate precautions are not taken for a given thermocouple type, the electrical isolation of the NT8 module may be compromised.

Grounded Junction Thermocouples

As shown in the illustration that follows, the shield input terminals are connected together, which are then connected to chassis ground. Using grounded junction thermocouples with electrically conductive sheaths, removes the thermocouple signal to chassis ground isolation of the module. This is inherent to the thermocouple construction. In addition, if multiple grounded junction thermocouples are used, the module's channel to channel isolation is removed since there is no isolation between signal and sheath, and the sheaths are tied together. It should be noted that the isolation is removed even if the sheaths are connected to chassis ground at a location other than the module, since the module is connected to chassis ground.

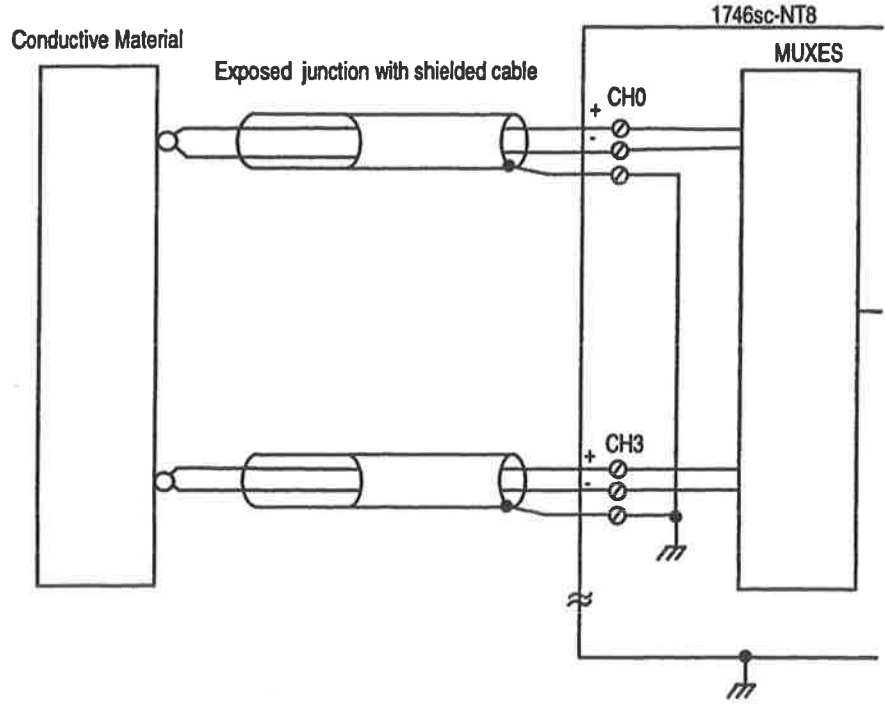
For grounded junction thermocouples it is recommended that they have protective sheaths made of electrically insulated material (e.g. ceramic), or the metal protective sheaths be floated. The metal sheaths would need to be floated with respect to any path to chassis ground or to another thermocouple metal sheath. This means the metal sheath must be insulated from electrically conductive process material, and have all connections to chassis ground broken. It should be noted that a floated sheath may result in a less noise immune thermocouple signal.



Exposed Junction Thermocouples

As shown in the illustration that follows, using exposed junction thermocouples may result in removal of channel to channel isolation. This may occur if multiple exposed thermocouples are in direct contact with electrically conductive process material. To prevent violation of channel to channel isolation:

- For multiple exposed thermocouples, do not allow the measuring junction of the thermocouple to make direct contact with electrically conductive process material.
- Use a single exposed junction thermocouple with multiple ungrounded junction thermocouples.
- Use all ungrounded junction thermocouple instead of the exposed junction type.



Index

A

Accuracy, overall 65
Addressing 4
 configuration word 18
Auto-calibration 24

B

Bit descriptions
 configuration word 41
Block diagrams 5, 10, 14

C

Cables, for thermocouples 4
 for wiring 12
Channel
 configuration word 27
 configuration faults 55
 configuration procedure 28
 data words 19, 36
 status words 19
Cold junction compensation iii, 14
Compatibility, with input devices 4
Configuration
 of channel 41
 of I/O (SLC system), with software 30
 procedure (for channel) 28, 44
 word 27
Connection diagram 14
Convert units
 to EU, scaled-PID, prop. count 32
Counts, proportional, selection of 33
Current draw 7, 8
Cut-off frequency iii

D

Data formats 38
Data words iii, 18, 36
Definition of terms ii
Diagnostics
 at power-up 53
 channel & module 53
Digital filter iii, 20
Documentation, related ii

E

Electrical noise 11
Electrostatic damage 7
Engineering units
 selection of and conversion to 32
Examples, how to:
 address configuration words 18
 address data and status words 19
 create and access software files 27, 32
 software configure system hardware 30

F

Fault bits 55
Filter, input 20
Flowchart, troubleshooting 57

G

Grounding, cable shields 11

H

Hardware
 features of module 2
 configure I/O (SLC system) 30
Heat considerations, for module location 14

I

ID code 17
I/O configuration, with software 28
I/O image
 configuration and calibration words 18
 data and status words 19
Input circuit, block diagram 5
Input data scaling iii, 32
Input device types, selection of 28
Input filter 20
Installation 9

L

Ladder logic, examples
 see programming examples
LEDs 54
 channel and module 54

M

Module (1746sc-NT8)
 addressing 4, 17
 configuration words 18, 30
 diagnostics 53
 hardware features 2
 input ranges 1
 installation 9
 ID code 17
 power requirements 7, 8
 troubleshooting 57
 wiring 12

O

Open-circuit
 select channel response to 39
 fault detection bit 39, 55
Operation
 of module 3
 of system 3
Out-of-range detection 40, 55
Overview
 of module 1
 of system 2
Output image 18

P

PID, scaled for, input format 31
Power requirements 7, 8
Power-up sequence 3
Programming Examples 41
Proportional counts 31

R

Resolution
 channel and device 20

S

Scaled for PID 31
Shield, connections 11, 12
Specifications 63
Status word 18, 36, 38
Step response 19
System operation 3

T

Temperature units
 selection in configuration word 35
Terminal block 10, 14
Terminal wiring
 channel devices 14
 CJC devices 14
Terms, used in manual ii
Thermocouple
 cables 4
 descriptions 67
 ranges/types 1, 32, 64
 resolution 64
Troubleshooting 54
 flowchart 57
 LED indication 54, 63

U

Under-range fault 40
Units, engineering 31
Update time 23

W

Wiring 11
 cable shield grounding 11
 input circuit block diagram 5
 terminal wiring 14

20



20




Getting Technical Assistance

If you need technical assistance, please review the information in Chapter 6, "Testing Your Module," before calling your local distributor of Spectrum Controls.

Note that your module contains electronic components which are susceptible to damage from electrostatic discharge (ESD). An electrostatic charge can accumulate on the surface of ordinary plastic wrapping or cushioning material. **In the unlikely event that the module should need to be returned to Spectrum Controls, please ensure that the unit is enclosed in approved ESD packaging (such as static-shielding / metallized bag or black conductive container).** Spectrum Controls reserves the right to void the warranty on any unit that is improperly packaged for shipment.

For further information or assistance, please contact your local distributor, or call the Spectrum Controls Customer Satisfaction department at (425) 746-9481 from 8:00 A.M. to 5:00 P.M. Pacific Time.

Declaration of Conformity

<i>Declaration of Conformity</i>	
<i>Application of Council Directive(s)</i>	73/23/EEC Low Voltage Directive 89/336/EEC Electromagnetic Compatibility
<i>Standard(s) to which Conformity is Declared</i>	EN50081-2:1993, EN50082-2:1995 EN61010-1:1993, EN61131-2:1995
<i>Manufacturer's Name Manufacturer's Address</i>	Spectrum Controls Inc. 2700 Richards Road South East, Bellevue Washington, 98005 U.S.A.
<i>Importer's Name Importer's Address</i>	Spectrum Controls Inc. 2700 Richards Road South East, Bellevue Washington, 98005 U.S.A.
<i>Type Of Equipment</i>	Allen-Bradley SLC500 Compatible I/O Modules
<i>Model No.</i>	1746sc Series
<i>I, the undersigned, hereby declare that the equipment specified above conforms to the above Directive(s) and Standard(s)</i>	
<i>Date Of Issue:</i> 1/17/97	
<i>Place:</i> Bellevue, Washington U.S.A.	Bruce M. Wanta <i>(Name)</i>
	Chairman <i>(Position)</i>
SPN: 0300144-02 Rev B.0	



The ENCOMPASS logo and SLC 500 are trademarks of Allen-Bradley Company, Inc. Copyright © 1999, Spectrum Controls, Inc. All rights reserved. Printed in U.S.A. Specifications subject to change without notice. Publication 0300162-03 Rev. D March 1999

U.S.A. Headquarters
Spectrum Controls Inc.
P.O. Box 5533
Bellevue, Washington 98006
Fax: (425) 641-9473
Tel: (425) 746-9481

Midwestern U.S.A. Sales Office
Spectrum Controls, Inc.
48945 Van Dyke, Suite 4B
Utica, Michigan 48317
Fax: (810) 731-2715
Tel: (810) 731-2397

Southeastern U.S.A. Sales Office
Spectrum Controls, Inc.
5300 Regency Lake Ct
Sugar Hill, Georgia 30518
Fax: (770) 614-5886
Tel: (770) 614-5885

Web Site: <http://www.spectrumcontrols.com>
E-mail: spectrum@spectrumctls.com





High-Speed Counter Module

(Catalog Numbers 1746-HSCE)

Installation Instructions

5

Inside ...	page
Important User Information	2
For More Information	3
High-Speed Counter Module Overview	4
Dip Switch and Jumper Locations	7
Installing the Module	10
Removing the Terminal Block	11
Important Wiring Considerations	12
Encoders	14
Specifications	20

Important User Information

Because of the variety of uses for the products described in this publication, those responsible for the application and use of this control equipment must satisfy themselves that all necessary steps have been taken to assure that each application and use meets all performance and safety requirements, including any applicable laws, regulations, codes and standards.

The illustrations, charts, sample programs and layout examples shown in this guide are intended solely for purposes of example. Since there are many variables and requirements associated with any particular installation, Allen-Bradley does not assume responsibility or liability (to include intellectual property liability) for actual use based upon the examples shown in this publication.

Allen-Bradley publication SGI-1.1, *Safety Guidelines for the Application, Installation, and Maintenance of Solid-State Control* (available from your local Allen-Bradley office), describes some important differences between solid-state equipment and electromechanical devices that should be taken into consideration when applying products such as those described in this publication.

Reproduction of the contents of this copyrighted publication, in whole or in part, without written permission of Allen-Bradley Company, Inc., is prohibited.

Throughout these installation instructions we use notes to make you aware of safety considerations:



ATTENTION: Identifies information about practices or circumstances that can lead to personal injury or death, property damage or economic loss.

Attention statements help you to:

- identify a hazard
- avoid the hazard
- recognize the consequences

Important: Identifies information that is critical for successful application and understanding of the product.



For More Information

As part of our effort to preserve, protect, and improve our environment, Allen-Bradley is reducing the amount of paper we use. Less paper means more options for you. In addition to traditional printed publications and CD-ROM versions, we now offer on-line manuals with the most up-to-date information you can get. We recommend that you read the related publications listed below before starting up your control system.

Related Publications

For	Refer to this Document	Pub. No.
A more detailed description on how to configure and program the High-Speed Counter Module.	High-Speed Counter Module User Manual	1746-6.5
A more detailed description on how to install and use your modular SLC 500 system.	SLC 500 Modular Hardware Style Installation and Operation Manual	1747-6.2
A reference manual that contains status file data, instruction set, and troubleshooting information.	SLC 500 and MicroLogix 1000 Instruction Set Reference Manual	1747-6.15
A CD-ROM containing both of the manuals listed above, plus the: <ul style="list-style-type: none"> • SLC 500 Analog I/O Modules User Manual • Discrete I/O Modules Installation Instructions • Discrete I/O Modules Product Data 	SLC 500 Literature Collection on CD-ROM	1747-CD1-1

How to Get More Information

For	Obtain Information By
Fast response to a specific question	<ul style="list-style-type: none"> • Visiting the Automation Bookstore at http://www.theautomationbookstore.com — Electronic versions of our manuals are available for you to search and download. • Calling (440) 646-5436 for the Allen-Bradley Fax Back service. You will be faxed information on the topic you request.
Publications in printed or CD-ROM format	Ordering a manual or CD-ROM using one of the following methods: <ul style="list-style-type: none"> • Fill out and return the User Manual Request Card that was shipped with the module. • Visiting the Automation Bookstore at http://www.theautomationbookstore.com
Multiple copies of a manual	<ul style="list-style-type: none"> • Visiting the Automation Bookstore at http://www.theautomationbookstore.com

High-Speed Counter Module Overview

The High-Speed Counter Module, Catalog Number 1746-HSCE is an SLC 500 family compatible device. It can be used with SLC 5/02 (and above) processors.^①

The module's bidirectional counting ability allows it to detect movement in either direction. In addition, x2 and x4 counting modes are provided to fully use the capabilities of high resolution quadrature encoders.

High-speed inputs from quadrature encoders and various high-speed switches are supported. Accepting input pulse frequencies of up to 50k Hz allows precise control of fast motions.

In addition to providing an Accumulated Counter, the module provides a Rate Counter to determine Rate Measurement by indicating the pulse input frequency in Hz. (Refer to the block diagram on the following page.) The Rate Measurement is determined by accumulating input pulses over a fixed period of time. You set the Rate Period to best match your application requirements.

Background Rate calculation is provided in Sequencer and Range Modes. This operation accepts input rates up to 32,767 Hz. The dynamically configurable Rate Period ranges from 10 ms to 2.55 seconds.

The module's four current sink (open collector) outputs can be controlled from one of two sources:

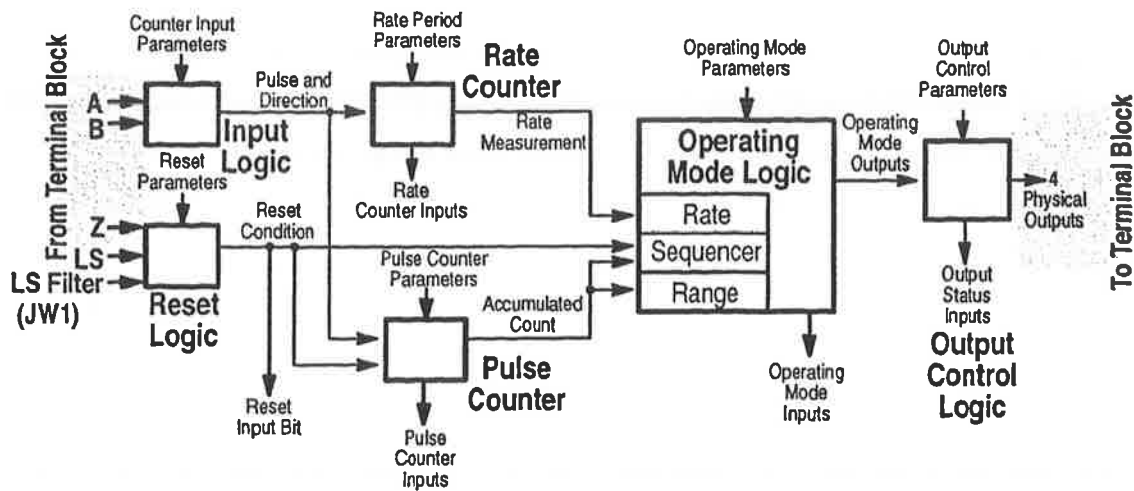
- the user program
- the module

Control of the counter reset is configured through user-set parameters. The counter can be reset from any combination of the Z input, Limit Switch input, or Soft Reset control bits.

^① The 1746-NT4 Thermocouple Module is not compatible with the 1747-ASB Remote I/O Adapter Module.

Module operation is determined by selections made in the Setup and Control Word (M0:e.1). Setting the Function Control bit to 1 triggers the module to start the proper pulse counter, rate measurement, and output control functions. Many parameters are dynamic and can be changed without disrupting counter operation.

A block diagram of the module is shown below. Inputs from the terminal block enter the diagram at the left, outputs to the terminal block exit at the right. M0 and Output file parameters from the SLC enter the logic blocks from the top. Input file data to the SLC exit the logic blocks from the bottom.

**Counter Input Parameters**

Input Type (M0:e.1/9-11)
Up/Down Count Direction (M0:e.1/3) *-d*

Reset Parameters

Soft Reset bit (M0:e.1/4) *-d*
Reset Mode (M0:e.1/5-7)

Rate Period Parameters

Rate Period (M0:e.9/0-7 or M0:e.16/0-7) *-d*

Operating Mode Parameters

Operating Mode (M0:e.1/14-15)
Function Control Bit (M0:e.1/12)
Range Definitions:
Range Starting Values (M0:e.10 - 33) *-d*
Range Ending Values (M0:e.10 - 33) *-d*
Range Outputs (M0:e.3 - 8) *-d*
Valid Ranges (M0:e.2) *-d*

Sequencer Definitions:

Valid Steps (M0:e.2 and M0:e.3/0-7) *-d*
Step Presets (M0:e.17 - 40) *-d*
Step Outputs (M0:e.4 - 15) *-d*
Initial Outputs (M0:e.3/8-15) *-d*
Sequencer Reset (M0:e.1/0) *-d*

Output Status Inputs (I:e.4/8-15)**Error Inputs**

Critical Error (I:e.0/10)
Configuration Error bit (I:e.0/11)
Configuration Error Code (I:e.4/0-7)

-d indicates a dynamic parameter

Pulse Counter Parameters

Reset Value (M0:e.34 or M0:e.41) *-d*
Maximum Count Value (M0:e.34 or M0:e.41)
Counter Hold bit (M0:e.1/2) *-d*
Counter Type bit (M0:e.1/13)

Output Control Parameters

Direct Outputs (O:e.0/0-7) *-d*
Output Source Select (M0:e.0/0-7) *-d*
Enable Outputs bit (M0:e.1/1) *-d*

Rate Counter Inputs

Rate Valid (I:e.0/3)
Rate Counter Overflow (I:e.0/4)
Rate Measurement Overflow (I:e.0/5)
Zero Rate Period Count (I:e.0/2)
Rate Period Count (I:e.2)
Rate Measurement (I:e.3)

Pulse Counter Inputs

Accumulated Count (I:e.1)
Overflow/Underflow (I:e.0/13)
Pulse Counter State (I:e.0/14-15)

Reset Input bit (I:e.0/12)**Operating Mode Inputs**

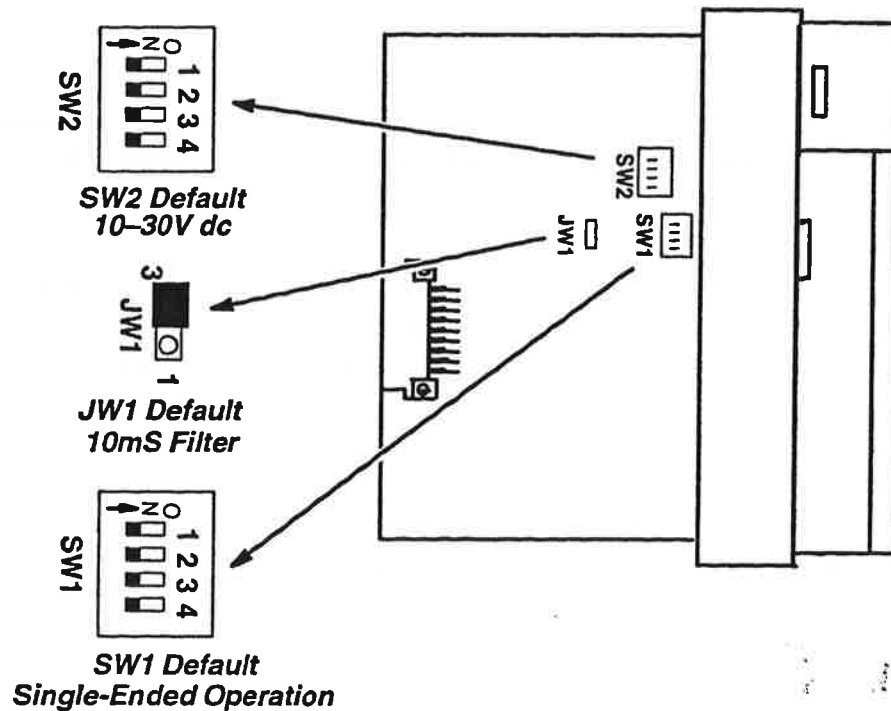
Sequencer Inputs
Current Sequencer Step (I:e.5/0-7)
Next Sequencer Step (I:e.5/8-15)
Sequence Done (I:e.0/6)
Range inputs
Ranges Active (I:e.6/0-11)

Dip Switch and Jumper Locations

Two dip switches (SW1 and SW2) and one jumper (JW1) are located on the side of the module.

- SW1 selects the type of input (single ended or differential).
- SW2 selects the output voltage range (4.5–10V dc or 10–30V dc).
- JW1 selects the filtering rate (300 μ s or 10 ms) used to debounce the limit switch input.

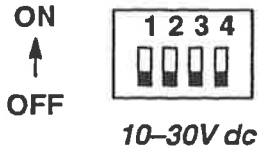
Default settings are shown below:



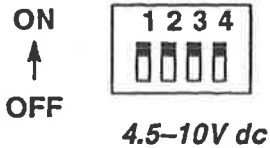
ATTENTION: Use a small screwdriver to change dip switch positions. Graphite from pencils will damage the switch.

SW2 Settings

Select an output voltage range that coincides with your supply voltage. The selections are 4.5 – 10V dc or 10 – 30V dc.



Switch	1	2	3	4
Output	0	1	2	3

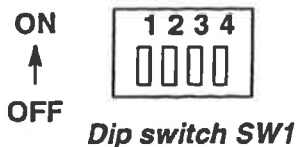


ATTENTION: All switches of SW2 must be ON or all switches must be OFF. Permanent damage may result if some are ON and some are OFF.

Operating in the 10–30V dc range with the switches set for the 4.5–10V dc range damages the module.

SW1 Settings

Select an input connection, single-ended or differential.



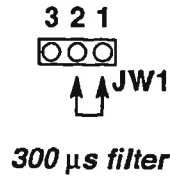
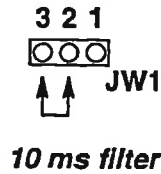
Switch	1	2	3	4
Channel	A	B	Z	not used

Position	Input connection	Input ON range
<input checked="" type="checkbox"/> ON	differential	2.8–4.5V dc
<input type="checkbox"/> OFF	single-ended	3.1–5.5V dc

It is possible to configure different inputs in different modes. For example, input A (CHA) can be configured as differential and input Z (CHZ) can be configured as single-ended.

JW1 Settings

Select 300 μ s or 10 ms filtering to debounce the limit switch input. Position the jumper as follows:



The LS input allows you to make a direct connection to nominal voltage levels of 5, 12, or 24V dc. The ON voltage ranges are as follows:

Wiring terminal	ON range
LS (24V dc)	16.5–30V dc
LS (12V dc)	9.4–16.5V dc
LS (5V dc)	3.8–5.5V dc

Limit switch ON ranges

Refer to pages 19 and 20 for limit switch wiring instructions.



ATTENTION: Only connect one LS input range at a time. Otherwise, the module will be damaged.

Installing the Module

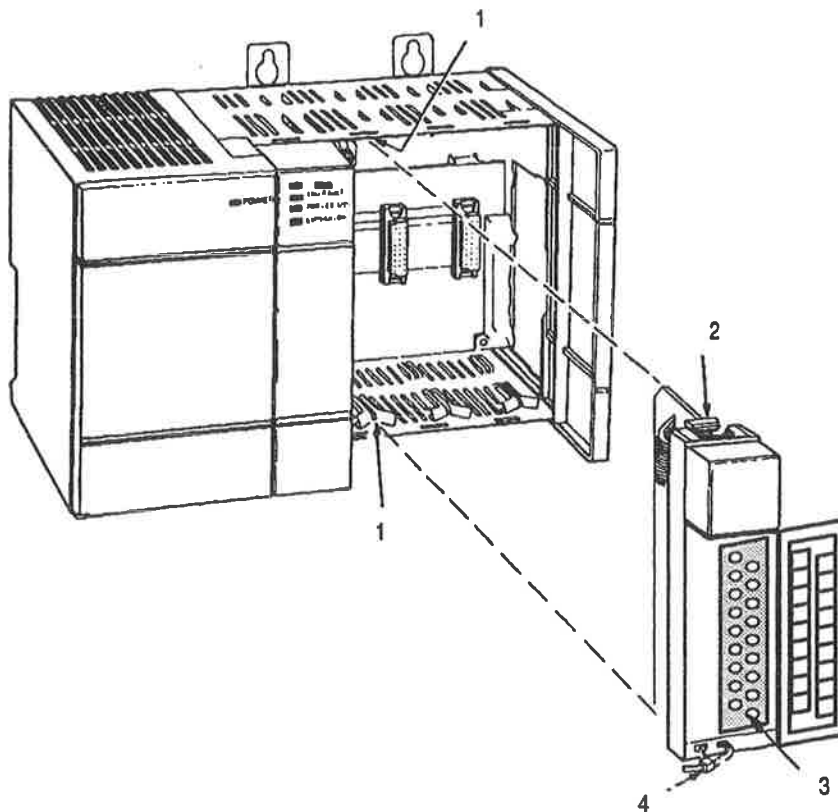
Installation procedures for this module are the same as any other discrete I/O or specialty module.

Important: Set the dip switches before installing the module.



ATTENTION: Disconnect power before attempting to install, remove, or wire the module.

Make sure your SLC power supply has adequate reserve current capacity. The module requires 320 mA at 5V dc.



1. Align the full-size circuit board with the rack card guide. The first slot (slot 0) of the first rack is reserved for the CPU.
2. Slide the module into the rack until the top and bottom latches are latched. To remove the module, press the releases at the top and bottom of the module and slide it out.

3. Make sure the removable terminal wiring block is attached to the module and all wires are connected to the terminal block.
4. Insert the cable tie in the slots and secure the cable.
5. Cover all unused slots with the Card Slot Filler, Catalog Number 1746-N2.

Removing the Terminal Block

The removable terminal wiring block eliminates the need to rewire a module if it is removed from the rack. Each terminal accepts two #14 AWG wires.



ATTENTION: Disconnect power before attempting to install, remove, or wire the removable terminal wiring block.

To avoid cracking the removable terminal block, alternate the removal of the slotted terminal block release screws.

Remove the terminal block by turning the slotted terminal block release screws counterclockwise. The screws are attached to the terminal block, so it will follow as the screws are turned out.

Wiring the Removable Terminal Block

The terminal screws can be turned with flat or cross slot screwdrivers. Each screw should be turned tight enough to immobilize the wire's end. Overtightening can strip the terminal screw. The torque applied to each screw should not exceed 0.6 Nm (5.3 inch pounds).

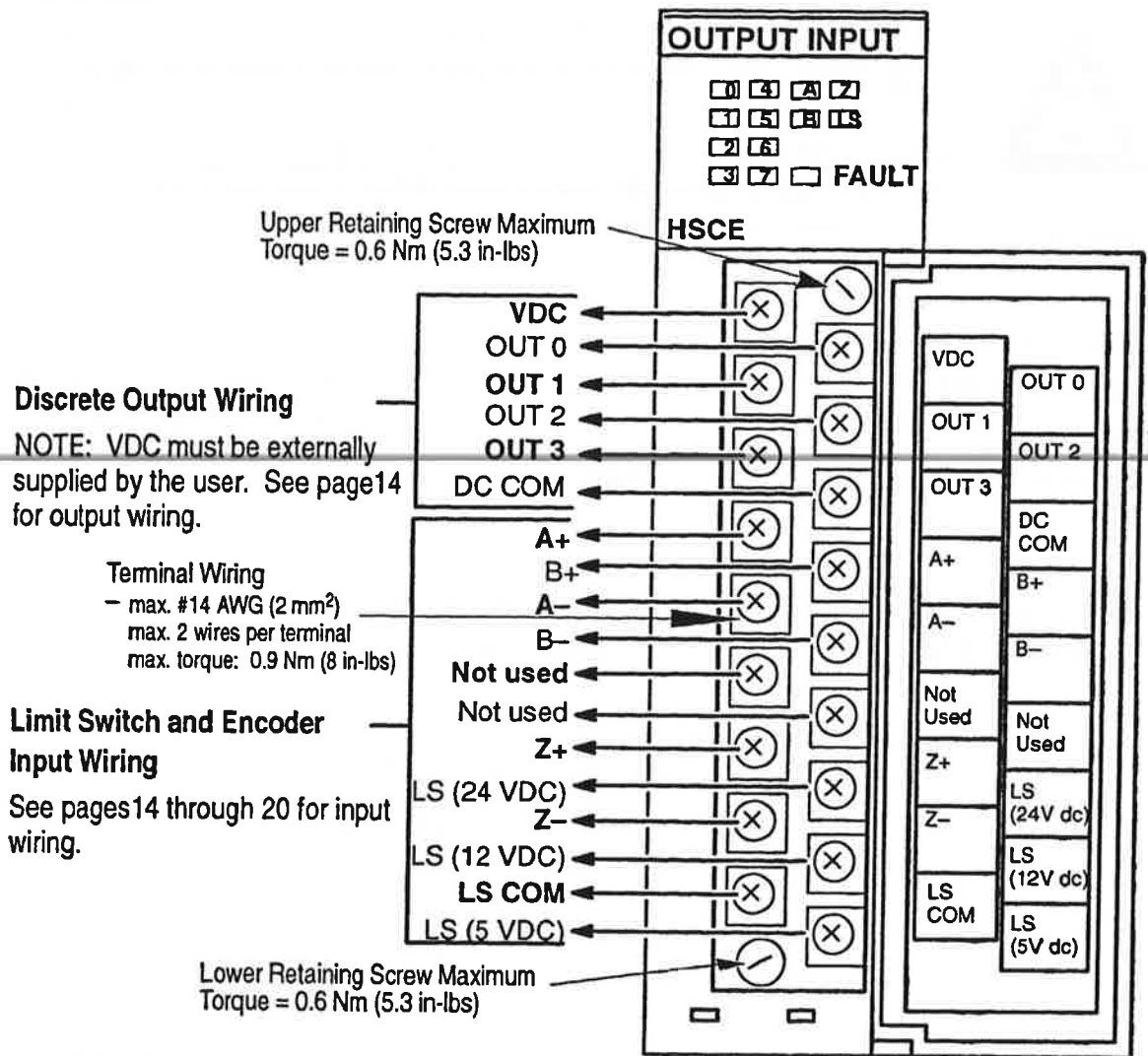
Important Wiring Considerations

Use the following guidelines when planning the system wiring for the module:

- Install the SLC 500 system in a NEMA-rated enclosure.
- Disconnect power to the SLC processor and the module before wiring.
- Make sure the SLC 500 system is properly grounded.
- Group this module and low-voltage DC modules away from AC I/O or high-voltage DC modules.
- Shielded cable is required for high-speed input signals A, B, and Z. We recommend Belden 9503 or equivalent for lengths up to 305 m (1000 ft).
- When the LS input is driven by an electromechanical device, route the wiring away from other inputs. In addition, JW1 should be set for the 10 ms filter.
- When the LS input is driven by a solid state device, use a shielded cable. You *do not* have to route the cable away from other inputs.
- Shields should be grounded only at the end of the signal source end of the cable. Ground the shield to the case of the signal source, so energy coupled to the shield will not be delivered to signal source's electronics.

Input and Output Connections

Input and output wiring terminals are located on the front of the module, behind the terminal cover. When you connect input and output devices, you must also be concerned with the settings of dip switch SW1 (input connections), dip switch SW2 (output connections), and jumper JW1 (limit switch input connections). The location and description of these are shown on pages 7 through 9.



Outputs

The module provides four physical outputs. They can be controlled by the module when certain counter conditions are met, or they can be controlled from the user program (refer to *High-Speed Counter Module User Manual* publication 1746-6.5 for M0:e.0 information).

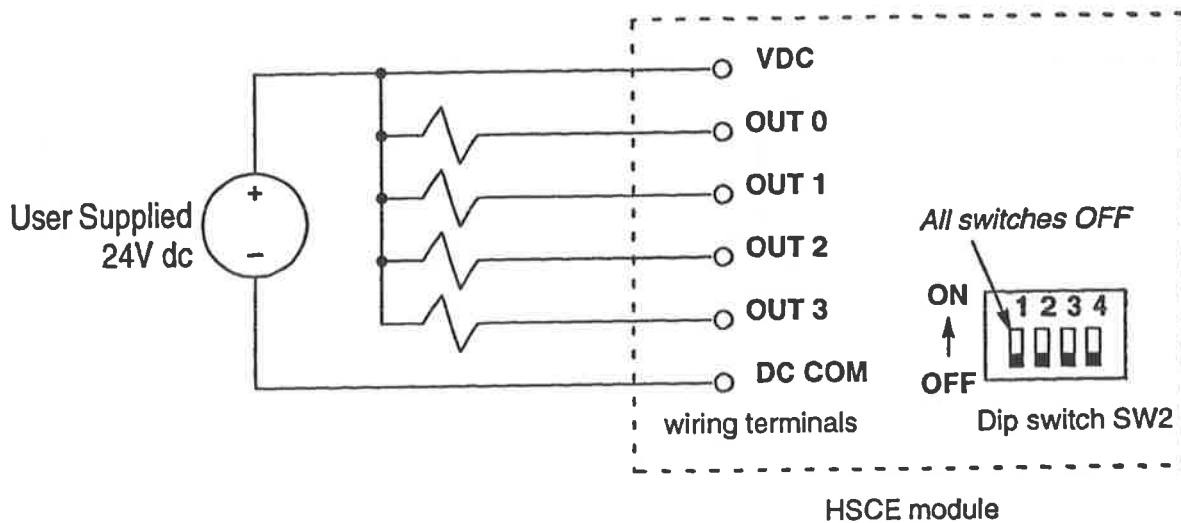
The outputs are bipolar transistors connected in a sinking (open collector sinking) configuration. When the output is energized, it sinks the current.



ATTENTION: Do not use incandescent lamps as output indicators. The high peak inrush current required to heat the filament can damage the module's output circuits. Use LED type indicators that satisfy the output circuit ratings, such as Allen-Bradley 800A and 800T LED indicators.

You can select an output voltage range of 4.5–10V dc or 10–30V dc. Refer to page 22 for the maximum current specifications for each voltage range. Dip switch SW2, located on the PC board, is used to select the voltage range. Refer to pages 7 through 9 for switch SW2 location and settings.

The figure below indicates wiring connections for four 24V dc outputs. Switches of SW2 are OFF for this output voltage.

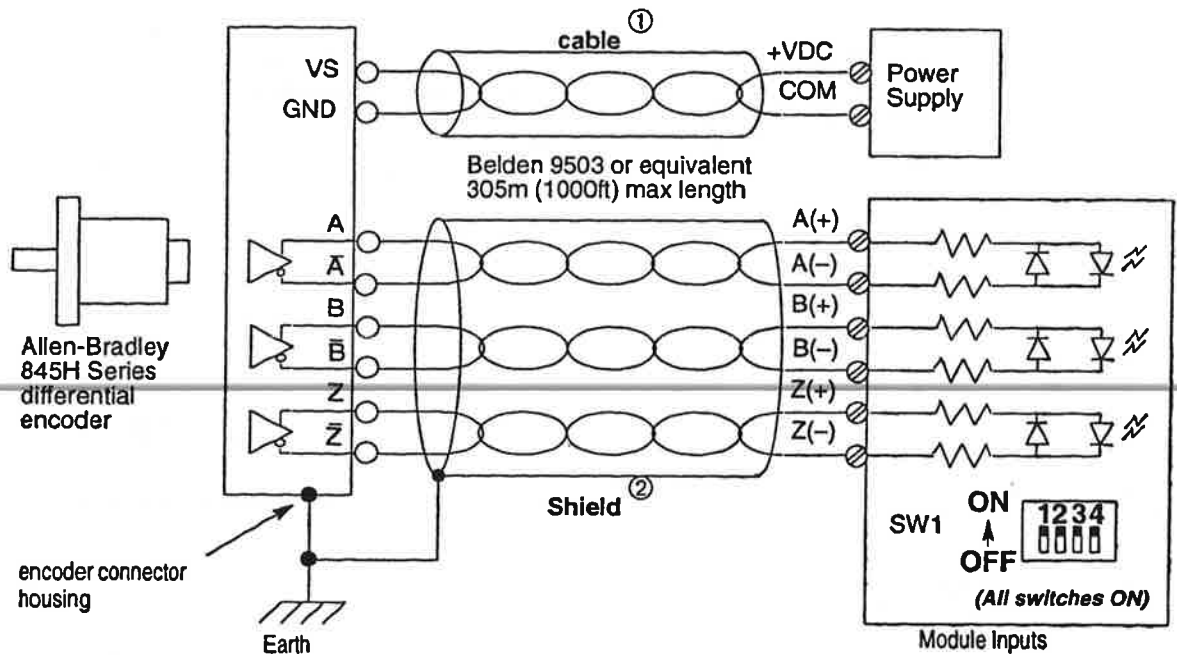


The outputs are *not* electrically isolated from each other. (They are referenced to the same output common terminal.) However, outputs are isolated from the rest of the circuitry to a level of 1500 volts.

Encoders

The wiring diagrams on the following pages are provided to support the Allen-Bradley encoders you may already have. Differential encoders provide the best immunity to electrical noise. We recommend, whenever possible, to use differential encoders.

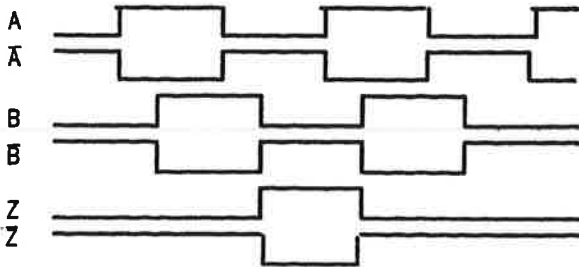
Differential Encoder Wiring



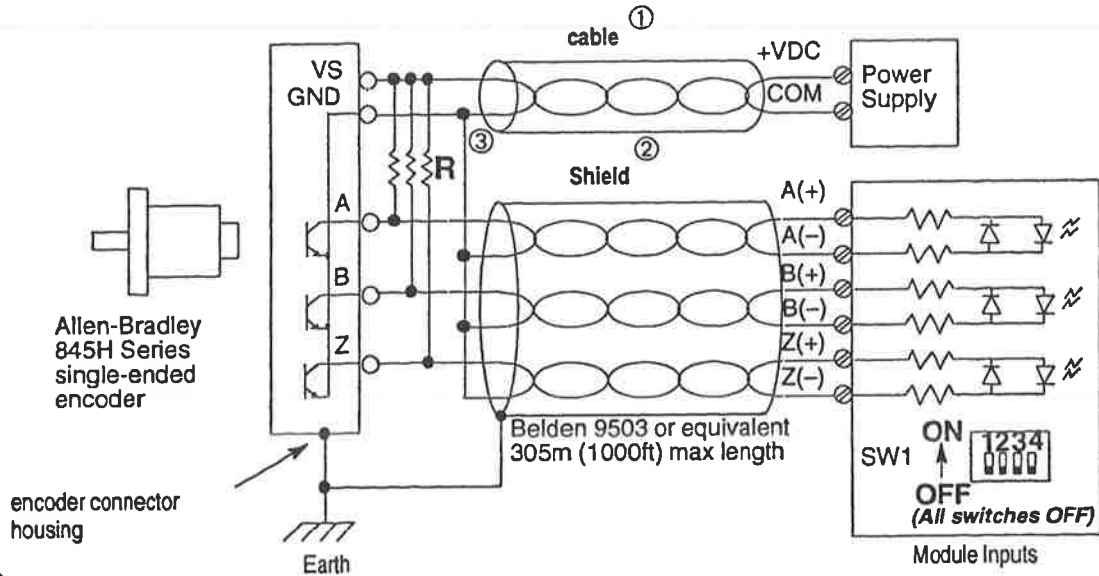
- ① Refer to your encoder manual for proper cable type and length.
- ② Due to the topology of the module's input circuits, terminating the shield at the encoder end provides the highest immunity to EMI interference. Connect EARTH ground directly to the encoder connector housing.

Differential Encoder Output Waveforms

The illustration below shows the different encoder output waveforms. If your encoder matches these waveforms, the encoder signals can be directly connected to the associated screw terminals on the module. For example, the A lead from the encoder is connected to the module's A+ screw. If your encoder does not match these waveforms, some wiring modifications may be necessary. Refer to appendix C in *High-Speed Counter Module User Manual Publication 1746-6.5* for a description of these modifications.



Single-Ended Encoder Wiring (Open Collector)



- ① Refer to your encoder manual for proper cable type and length.
- ② Due to the topology of the module's input circuits, terminating the shield at the encoder end provides the highest immunity to EMI interference. Connect EARTH ground directly to the encoder connector housing.
- ③ The pullup resistor (R) value depends on the power supply value (VS). The table below lists the resistor values for typical power supply values. These resistors must be located at the encoder end of the cable.

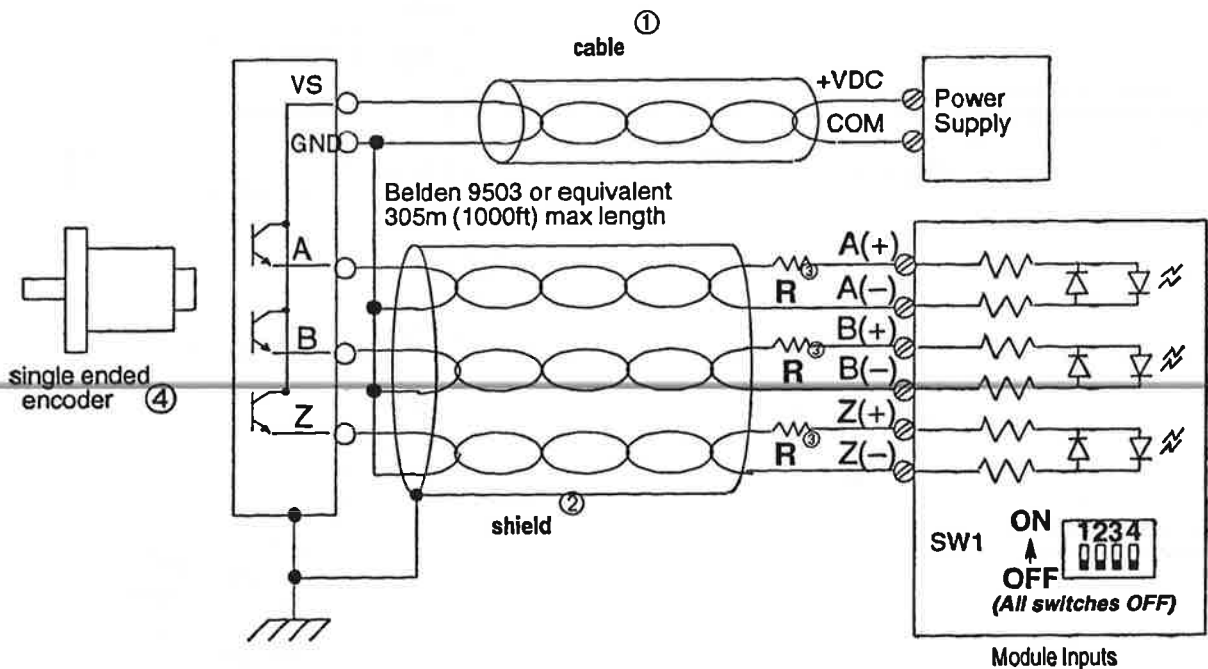
VS Value	R Value	Maximum Output Leakage
+5V dc	150 ohm 1/4W 5%	6.3 mA
+12V dc	1800 ohm 1/4W 5%	1.5 mA
+24V dc	4700 ohm 1/4W 5%	1.2 mA

Single-Ended Encoder Output Waveforms

The figure below shows the single-ended encoder output waveforms. When the waveform is low, the encoder output transistor is ON.



Single-Ended Encoder Wiring (Sourcing)



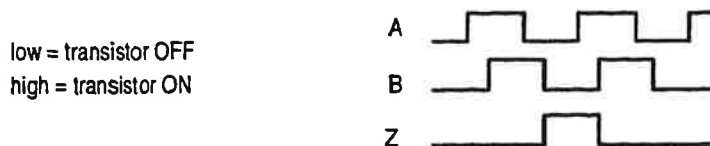
- ① Refer to your encoder manual for proper cable type and length.
- ② Due to the topology of the module's input circuits, terminating the shield at the encoder end provides the highest immunity to EMI interference. Connect EARTH ground directly to the encoder connector housing.
- ③ The resistor (R) value depends on the power supply value (VS). The table below lists the resistor values for typical power supply values. These resistors must be located at the module end of the cable.

VS Value	R Value	Maximum Output Leakage
+5V dc	no resistor needed	100 μ A
+12V dc	1800 ohm 1/4W 5%	100 μ A
+24V dc	4700 ohm 1/4W 5%	100 μ A

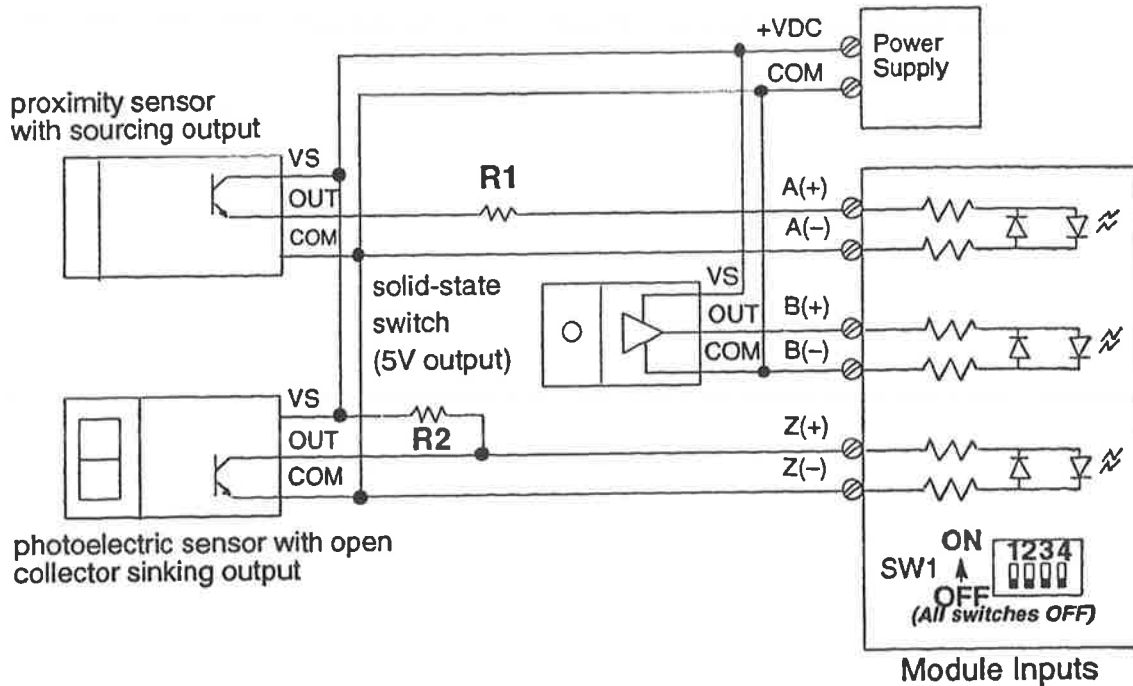
④ The Allen-Bradley 845H sourcing encoder is not compatible with this module.

Single-Ended Encoder Output Waveforms

The figure below shows the single-ended encoder output waveforms. When the waveform is low, the encoder output transistor is OFF.



Single-Ended Wiring (Discrete Devices)



Important:

- This diagram shows the sensors operating from a common power supply. Separate power supplies for each circuit can be used.
- The resistor (R1) value depends on the power supply value (VS). The table below lists the resistor values for typical power supply values. These resistors must be located at the module end of the cable.

VS Value	R1 Value	Maximum Output Leakage
+5V dc	no resistor needed	100 μ A
+12V dc	1800 ohm 1/4W 5%	100 μ A
+24V dc	4700 ohm 1/4W 5%	100 μ A

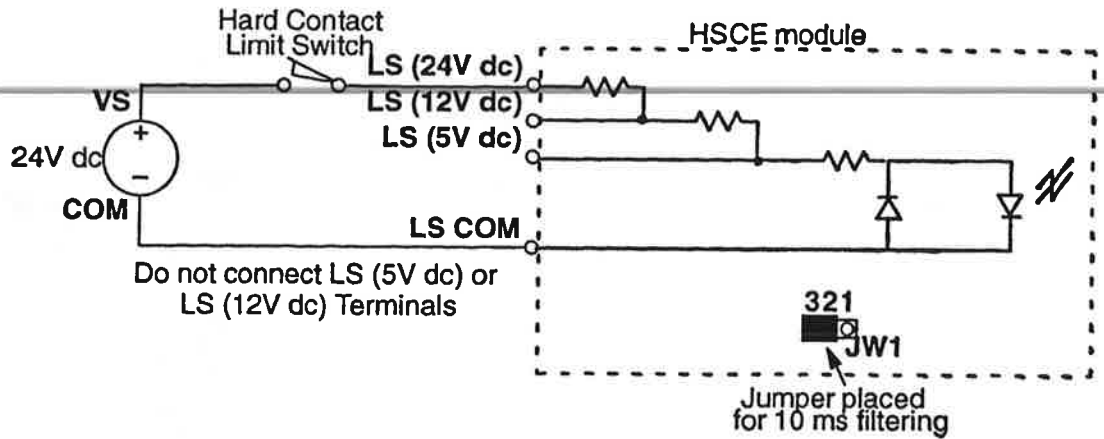
- The pullup resistor (R2) value depends on the power supply value (VS). The table below lists the resistor values for typical power supply values. These resistors must be located at the sensor end of the cable.

VS Value	R2 Value	Maximum Output Leakage
+5V dc	150 ohm 1/4W 5%	6.3 mA
+12V dc	1800 ohm 1/4W 5%	1.5 mA
+24V dc	4700 ohm 1/4W 5%	1.2 mA

Limit Switch Wiring (24 V dc Hard Contact)



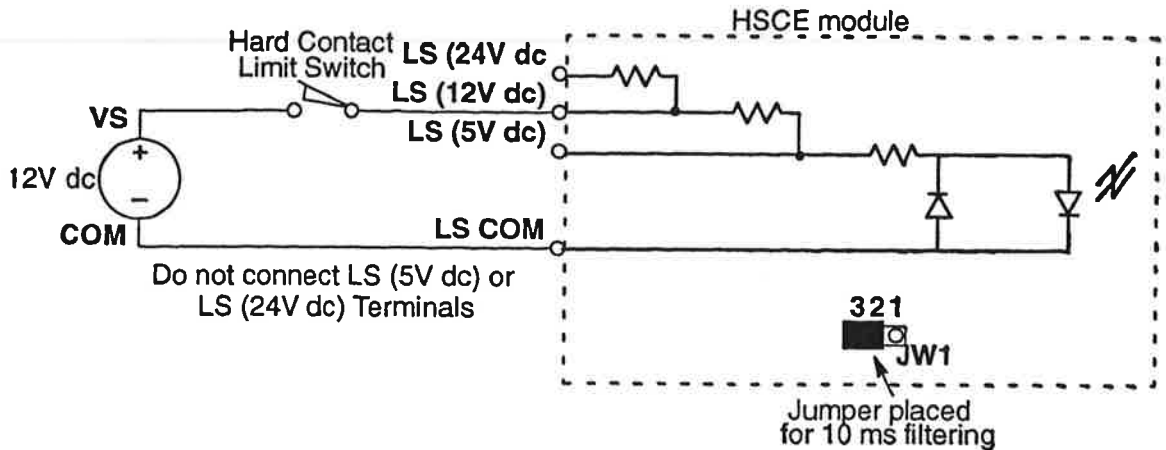
ATTENTION: Only connect one LS input range at a time. Otherwise, the module will be damaged.



Limit Switch Wiring (12V dc Hard Contact)



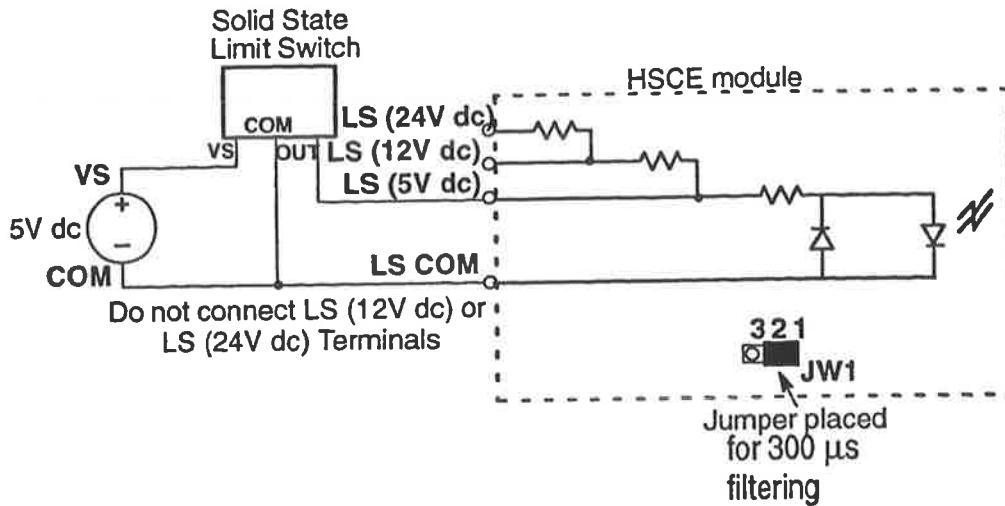
ATTENTION: Only connect one LS input range at a time. Otherwise, the module will be damaged.



Limit Switch Wiring (5V dc Solid State)



ATTENTION: Only connect one LS input range at a time. Otherwise, the module will be damaged.



Specifications

General

Operating Temperature	0°C to +60°C (+32°F to +140°F)
Storage Temperature	-40°C to +85°C (-40°F to +185°F)
Humidity	5 to 95% without condensation
Backplane Current Consumption (power supply loading)	320 mA at +5V dc 0 mA at +24V dc
Maximum Cable Length ^①	305 m (1000 ft)
Agency Certification (when product or packaging is marked)	<ul style="list-style-type: none"> • CSA certified • CSA Class I, Division 2 Groups A, B, C, D certified • UL listed • CE marked for all applicable directives

^① Belden 9503 or equivalent

Inputs A, B, and Z

	Differential (Switch 1 on)	Single Ended (Switch 1 off)
Input Voltage	$\pm 5V$ dc	0 to 5V dc ^①
On-State Voltage	2.8 to 4.5V dc	3.1 to 5.5V dc
Off-State Voltage	-5.5 to 0.8V dc	0 to 0.8V dc
Max Off-State Leakage Current	100 μA	600 μA
Input Current (mA)	2.5 mA at 2.8V dc 7.5 mA at 4.5V dc	2.5 mA at 3.1V dc 7.5 mA at 5.5V dc
Nominal Input Impedance	700 Ω	825 Ω
Min. Pulse Width	10 μs	
Min. Phase Separation ^②	4.5 μs	
Max. Input Frequency Sequencer and Range Rate	50k Hz 32.767k Hz	
Isolation (from backplane)	1500 volts	

① 12 and 24 volts must be used with a pullup resistor

② Channel A to channel B

Limit Switch Input

	5V dc	12V dc	24V dc
On-State Voltage	3.8 to 5.4V dc	9.4 to 16.5V dc	16.5 to 30V dc
Off-State Voltage	0 to 1.2V dc	0 to 2.4V dc	0 to 3.9V dc
Input Current minimum nominal maximum	4.6 mA 6.8 mA 9.2 mA		
Max. Off-State Leakage Current	1 mA (all ranges)		
Isolation (from backplane)	1500 volts		

Outputs (Open Collector, Sinking)

	4.5 to 10V dc (Switch 2 on)	10 to 30V dc (Switch 2 off)
Max. On-State Output Current	16 mA at 4.5V dc 40 mA at 10V dc	40 mA at 10V dc 125 mA at 30V dc
Max. On-State Voltage Drop	0.4V dc	1.0V dc
Max. Off-State Leakage Current	100 μ A	
Isolation (from backplane)	1500 volts	

 **Rockwell** Automation

Allen-Bradley

Worldwide representation.



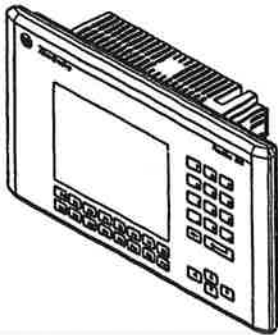
Argentina • Australia • Austria • Bahrain • Belgium • Brazil • Bulgaria • Canada • Chile • China, PRC • Colombia • Costa Rica • Croatia • Cyprus • Czech Republic • Denmark • Ecuador • Egypt • El Salvador • Finland • France • Germany • Greece • Guatemala • Honduras • Hong Kong • Hungary • Iceland • India • Indonesia • Ireland • Israel • Italy • Jamaica • Japan • Jordan • Korea • Kuwait • Lebanon • Malaysia • Mexico • Netherlands • New Zealand • Norway • Pakistan • Peru • Philippines • Poland • Portugal • Puerto Rico • Qatar • Romania • Russia-CIS • Saudi Arabia • Singapore • Slovakia • Slovenia • South Africa, Republic • Spain • Sweden • Switzerland • Taiwan • Thailand • Turkey • United Arab Emirates • United Kingdom • United States • Uruguay • Venezuela • Yugoslavia

Allen-Bradley Headquarters, 1201 South Second Street, Milwaukee, WI 53204 USA
Tel: (1) 414 382-2000 Fax: (1) 414 382-4444



Allen-Bradley

**PanelView
550/900 Operator
Terminals**



User Manual

Important User Information

Because of the variety of uses for the products described in this publication, those responsible for the application and use of this control equipment must satisfy themselves that all necessary steps have been taken to assure that each application and use meets all performance and safety requirements, including any applicable laws, regulations, codes and standards.

The illustrations, charts, sample programs and layout examples shown in this guide are intended solely for purposes of example. Since there are many variables and requirements associated with any particular installation, Allen-Bradley does not assume responsibility or liability (to include intellectual property liability) for actual use based upon the examples shown in this publication.

Allen-Bradley publication SGI-1.1, *Safety Guidelines for the Application, Installation, and Maintenance of Solid-State Control* (available from your local Allen-Bradley office), describes some important differences between solid-state equipment and electromechanical devices that should be taken into consideration when applying products such as those described in this publication.

Reproduction of the contents of this copyrighted publication, in whole or in part, without written permission of Allen-Bradley Company, Inc., is prohibited.

Throughout this manual we use notes to make you aware of safety considerations:



ATTENTION: Identifies information about practices or circumstances that can lead to personal injury or death, property damage or economic loss.

Attention statements help you to:

- identify a hazard
- avoid the hazard
- recognize the consequences

Important: Identifies information that is critical for successful application and understanding of the product.

PanelBuilder 550, PanelBuilder 900, PanelView 550, PanelView 900, SLC, SLC 500, SLC 5A11, SLC 5A12, SLC 5A13, SLC 504, Data Highway Plus are trademarks of Allen-Bradley Company, Inc.
PLC and PLC-5 are registered trademarks of Allen-Bradley Company, Inc.
INTERCHANGE is a trademark of Rockwell Software Inc.
Microsoft and MS-DOS are registered trademarks, and Windows is a trademark of Microsoft Corporation.

Table of Contents

Preface

Chapter Objectives	P-1
Overview of this Manual	P-1
Intended Audience	P-2
European Union Directive Compliance	P-2
Conventions	P-2
Terminology	P-2
Related Publications	P-2
Allen-Bradley Support	P-3

Terminal Overview

Chapter 1

Chapter Objectives	1-1
Intended Uses	1-1
Terminal Types	1-2
PanelView 900 Color Terminals	1-3
PanelView 550 Features	1-4
PanelView 900 Features	1-8
DH-485 Communications	1-12
RS-232 Communications	1-13
Remote I/O Communications	1-14
Applications	1-15
Configuration Mode Menu	1-17
Terminal Messages	1-17
Printing	1-17
Alarm History	1-18
Memory Card	1-19
Function Key Legends	1-20
Accessories and Replacement Parts	1-21

Applying Power

Chapter 2

Chapter Objectives	2-1
Wiring and Safety Guidelines	2-1
Connecting AC Power	2-1
Connecting DC Power	2-4
Power-up Sequence	2-6
Resetting the Terminal	2-8

Configuration Mode Menu

Chapter 3

Chapter Overview	3-1
Application Settings	3-1
Accessing the Configuration Mode Menu	3-2
Selecting a Language	3-4
Memory Card Transfer	3-5
DH-485 Communication Setup	3-6

	Remote I/O Communication Setup	3-7
	Preset Operations	3-9
	Terminal Information	3-10
	Time and Date Setup	3-11
	Screen Setup	3-12
	Printer Setup	3-15
Using a Memory Card	Chapter 4	
	Chapter Objectives	4-1
	Loading Application from a Memory Card	4-1
	Loading Application on a Memory Card	4-3
Running Applications	Chapter 5	
	Chapter Objectives	5-1
	Application Information	5-1
	Push Button Operation	5-2
	Control Lists	5-3
	Numeric Entry Controls	5-6
	Screen Selectors	5-8
	List Indicators	5-10
	Multistate Indicators	5-10
	Bar Graph Displays	5-10
	Numeric Data Displays	5-11
	Message Displays	5-11
	Time or Date	5-11
Installing the PV550 Terminal	Chapter 6	
	Chapter Objectives	6-1
	Series C Terminals	6-1
	Enclosures	6-1
	Required Tools	6-2
	Mounting Dimensions	6-2
	Clearances	6-3
	Cutout Dimensions	6-4
	Installing the PV550 in a Panel	6-5
Installing the PV900 Terminal	Chapter 7	
	Chapter Objectives	7-1
	Hazardous Locations	7-1
	Enclosures	7-1
	Required Tools	7-2
	Mounting Dimensions	7-2
	Clearances	7-4
	Cutout Dimensions	7-5
	Installing the PV900 in a Panel	7-6

DH-485 Terminal Connections

Chapter 8

Chapter Objectives	8-1
Wiring and Safety Guidelines	8-1
DH-485 Connectors	8-2
Connecting to Single SLC (Point-to-Point)	8-3
Connecting to DH-485 Multidrop Network	8-4
Connecting a Hand-Held Terminal	8-5
Connecting a Computer	8-6
Connecting a Printer	8-8

RS-232 Terminal Connections

Chapter 9

Chapter Objectives	9-1
Wiring and Safety Guidelines	9-1
RS-232 Ports	9-2
Connecting to SLC 5/03, 5/04 (Point-to-Point)	9-3
Connecting a Computer	9-4
Connecting to a DH Plus Network	9-5
Connecting a Printer	9-6

Remote I/O Terminal Connections

Chapter 10

Chapter Objectives	10-1
Wiring and Safety Guidelines	10-1
Remote I/O Port	10-2
Supported Controllers	10-3
Connecting to a Remote I/O Port	10-4
Connecting a Computer	10-5
Remote I/O Pass-Through	10-7

Troubleshooting and Maintenance

Chapter 11

Chapter Objectives	11-1
Equipment Required	11-1
Using the Troubleshooting Chart	11-1
Troubleshooting Chart	11-2
LED Indicators	11-4
Cleaning the Display Window	11-5
Replacing the Clock Module	11-5
Replacing the PV550 Backlight Lamp	11-6
Replacing the PV900 Color Backlight	11-8

Specifications	Appendix A
Terminal Messages and Self Test Numbers	Appendix B
European Union Directive Compliance	Appendix C
	Glossary
	Index
	Figures
1.1	PanelView 550 Terminal Features (Front) 1-4
1.2	PanelView 550 Terminal Features (Back) 1-6
1.1	PanelView 900 Terminal Features (Front) 1-8
1.2	PanelView 900 Terminal Features (Back) 1-10
6.1	PV550 Mounting Dimensions 6-2
6.2	PV550 Mounting Clearances 6-3
6.3	PV550 Panel Cutout Dimensions 6-4
7.1	PV900 Touch Terminal Mounting Dimensions 7-2
7.2	PV900 Keypad Terminal Mounting Dimensions 7-3
7.3	PV900 Mounting Clearances 7-4
7.4	PV900 Panel Cutout Dimensions 7-5
8.1	DH-485 Connection to SLC (Point-to-Point) 8-3
8.2	DH-485 Connection to an SLC Network 8-4
8.3	DH-485 Connection to Hand-Held Terminal 8-5
8.4	Connecting a Computer to DH-485 Connector Using a Power Supply 8-7
8.5	Connecting a Computer to DH-485 Connector Using a DH-485 Powered Device 8-7
8.6	Connecting a Printer to a DH-485 terminal 8-8
9.1	RS-232 Connection to SLC 5/03, 5/04 (Point-to-Point) 9-3
9.2	Connecting Computer to an RS-232 Terminal 9-4
9.3	Connecting to a DH+ Network 9-5
9.4	Connecting a Printer to an RS-232 Terminal 9-6
10.1	Remote I/O Connections 10-4
10.2	Connecting Computer to a Remote I/O Terminal 10-5
10.3	Connecting a Printer to a Remote I/O Terminal 10-6
11.1	LED Indicators 11-4
	Tables
1.A	Accessories 1-21
1.B	Replacement Parts 1-22
3.A	DH-485 LED Indications 3-3
3.B	Remote I/O LED Indications 3-3
11.A	Troubleshooting Chart 11-2

Preface

Objectives

Read this chapter to familiarize yourself with the rest of the manual. You will learn about:

- contents of this manual
- intended audience
- conventions used
- terminology
- European Union Directive Compliance
- related publications
- Allen-Bradley Support

Overview of this Manual

The following table describes the contents of each chapter.

Chapter	Title	Purpose
	Preface	Provides an overview of the manual.
1	Terminal Overview	Describes the main features and operating capabilities of the PanelView 550/900 terminals.
2	Applying Power	Describes how to apply power to and reset the PanelView 550/900 terminals.
3	Configuration Mode Menu	Provides instructions on how to set up the terminal using the configuration mode menu.
4	Using a Memory Card	Describes how to copy applications to or from a memory card.
5	Running Applications	Describes objects common to many applications.
6	Installing the PV550 Terminal	Shows how to mount the PV550 terminal in an enclosure or panel.
7	Installing the PV900 Terminal	Shows how to mount the PV900 terminal in an enclosure or panel.
8	DH-485 Terminal Connections	Describes how to connect a DH-485 device and computer to the DH-485 version of the PanelView terminal.
9	RS-232 Terminal Connections	Describes how to connect a DH-485 device and computer to the RS-232 version of the PanelView terminal.
10	Remote I/O Terminal Connections	Describes how to connect a Remote I/O Scanner and computer to the Remote I/O version of the PanelView terminal.
11	Troubleshooting and Maintenance	Provides assistance in identifying and correcting common operating problems. Procedures for routine maintenance items are also provided.

Intended Audience

No special knowledge is required to understand this manual or operate the PanelView 550 and 900 terminal. Before running an application, you must know the functions of all screens and screen objects. This information is available from the application designer.

Equipment installers must be familiar with standard panel installation techniques.

European Union Directive Compliance

Refer to Appendix C for details on installing the PanelView 550 or 900 terminals in industrial environments requiring compliance with European Union Directives.

Conventions

This manual uses the following conventions:

- PanelView 550 and 900 terminal function and operator entry keys are referred to as keys. Terminal configuration screen controls are referred to as buttons.
- PV550 refers to a PanelView 550 terminal.
- PV900 refers to a PanelView 900 terminal.

Terminology

This manual contains some terms that may be unfamiliar. Use the glossary at the back of this manual for assistance.

Related Publications

The following table lists other publications related to the PanelView 550 and 900 Operator Terminals.

Publication Number	Description
2711-6.0	PanelBuilder 550/900 Configuration Software User Manual
2711-6.2	PanelView 550/900 Getting Started Manual
2711-805	PanelView File Transfer Utility User Guide
1770-4.1	Programmable Controller Wiring and Grounding Guidelines
1770-6.2.2	Data Highway / Data Highway Plus / Data Highway-485 Cable Installation Manual

For information relating to SLC or PLC logic controllers, refer to your controller's user manuals.

Allen-Bradley Support

Allen-Bradley offers support services worldwide, with over 75 Sales/Support Offices, 512 authorized Distributors and 260 authorized Systems Integrators located throughout the United States alone, plus Allen-Bradley representatives in every major country in the world.

Local Product Support

Contact your local Allen-Bradley representative for:

- sales and order support
- product technical training
- warranty support
- support service agreements

Technical Product Assistance

If you need to contact Allen-Bradley for technical assistance, please review the information in Chapter 11 on *Troubleshooting* first. Then call your local Allen-Bradley representative.

Terminal Overview

Chapter Objectives

This chapter gives an overview of the PanelView 550 and 900 Operator Terminals.

- intended uses
- terminal types
- PanelView 900 color terminals
- PanelView 550 features
- PanelView 900 features
- DH-485 communications
- RS-232 communications
- Remote I/O communications
- applications
- configuration mode menu
- terminal messages
- printing
- alarm history
- memory card
- function key legends
- accessories and replacement parts

Intended Uses

You can use the PanelView 550 and 900 operator terminals for a wide variety of machine control and monitoring applications.



ATTENTION: Do not use a PanelView 550 or 900 terminal for emergency stops or other controls critical to the safety of personnel or equipment. Use separate hardwired operator interface devices that do not depend on solid state electronics. See the inside front cover of this manual for additional guidelines.

Terminal Types

The table below lists the types of PanelView 550 and 900 terminals. The differences in the terminals relate to:

- display type (monochrome or color)
- operator input (touch screen or keypad)
- communication ports (Remote I/O, DH-485, RS-232)
- RS-232 printer port

In addition, each terminal is available with either:

- AC or DC power

The DC versions of the PanelView 550 and 900 terminals are designated by L1 at the end of the Catalog Number (e.g., 2711-B5A1L1, -T9A1L1).

PanelView Terminal	Operator Input	Communication Ports			Printer Port	Catalog No.
		RIO	DH-485	RS-232 (DH-485)	RS-232	
PV550 Monochrome	Touch Screen and Keypad	✓			✓ ^①	2711-B5A1
			✓			2711-B5A2
			✓		✓	2711-B5A3
				✓		2711-B5A5
				✓	✓	2711-B5A9
	Keypad	✓			✓ ^①	2711-K5A1
			✓			2711-K5A2
			✓		✓	2711-K5A3
				✓		2711-K5A5
		✓	✓	2711-K5A9		
PV900 Monochrome	Touch Screen	✓			✓ ^①	2711-T9A1
			✓			2711-T9A2
			✓		✓	2711-T9A3
				✓		2711-T9A5
				✓	✓	2711-T9A9
	Keypad	✓			✓ ^①	2711-K9A1
			✓			2711-K9A2
			✓		✓	2711-K9A3
				✓		2711-K9A5
		✓	✓	2711-K9A9		
PV900 Color	Touch Screen	✓			✓ ^①	2711-T9C1
			✓		✓	2711-T9C3
				✓	✓	2711-T9C9
	Keypad	✓			✓ ^①	2711-K9C1
			✓		✓	2711-K9C3
			✓	✓	2711-K9C9	

^① On Remote I/O terminals, you can use the RS-232 printer port for either printing or transferring applications.

PanelView 900 Color Terminals

The PanelView 900 color terminals support a fixed palette of the 16 standard EGA colors.

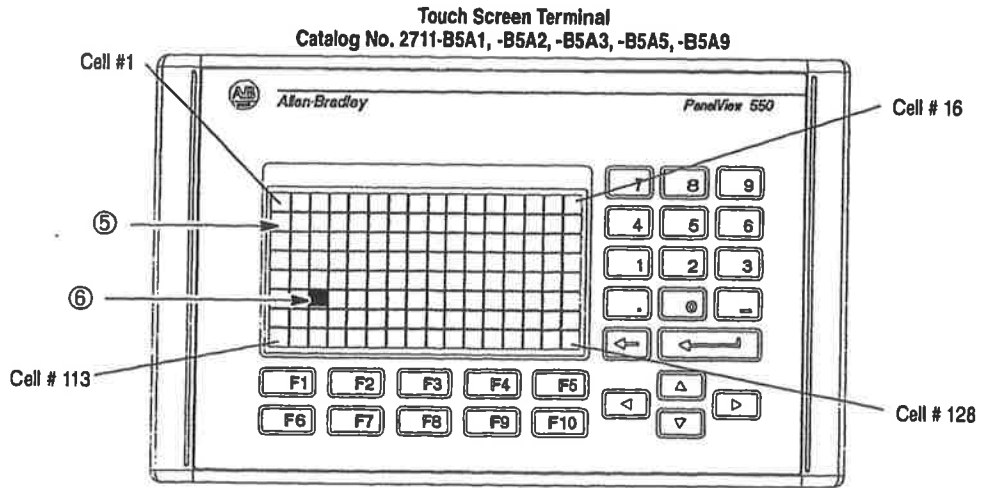
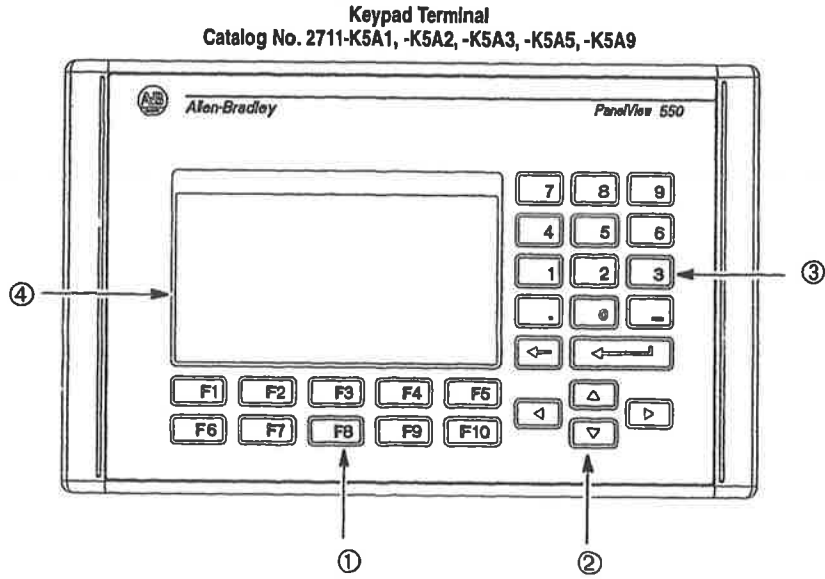
All color in an application is defined when an application is developed using the PanelBuilder 900 software. Colors are not selectable at the terminal.

All color used on the terminal's configuration screens and messages are fixed and cannot be changed.

PanelView 550 Features

Figures 1.1 and 1.2 show the features of the PanelView 550 terminals.

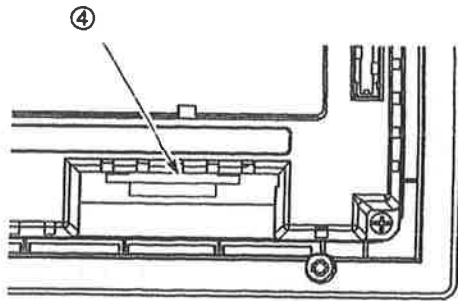
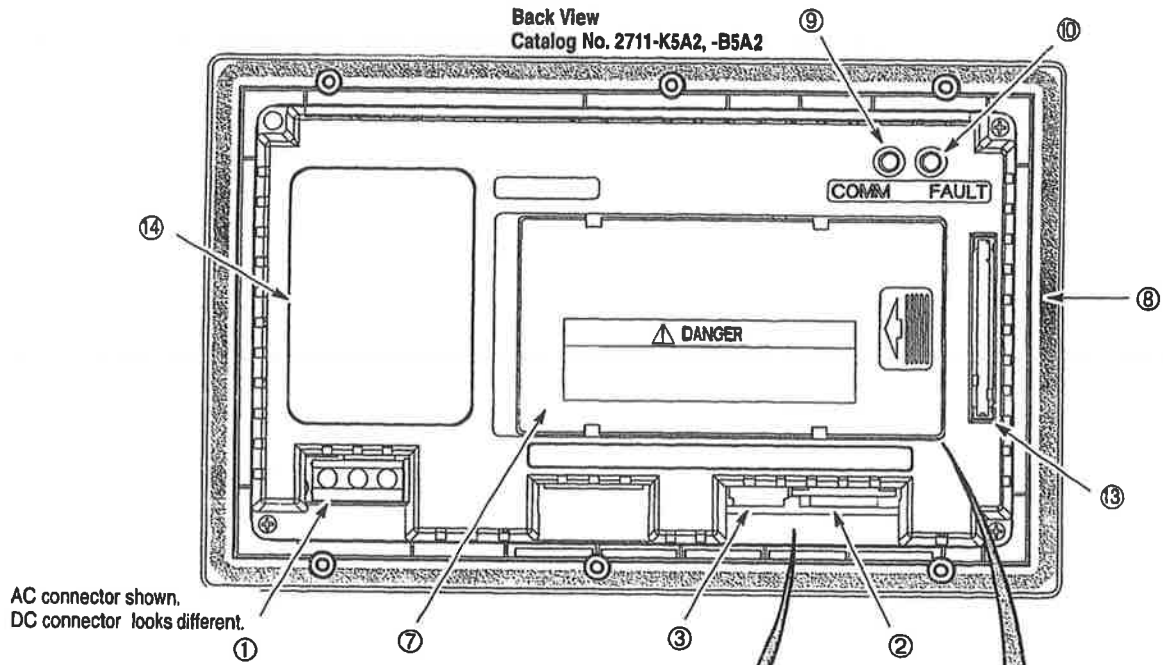
Figure 1.1
PanelView 550 Terminal Features (Front)



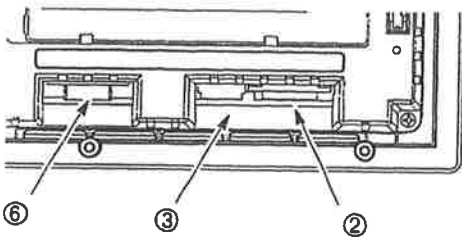
#	Feature	Description
①	Function Keys (F1 - F10)	Use the function keys on keypad terminals to initiate functions on the terminal display. These keys may have custom legends. On the keypad & touch screen terminals, the function keys are optional. To initiate functions, use the function keys and/or touch screen objects.
②	Cursor Keys	Use the cursor keys to move the cursor on displayed lists, to select a numeric entry object, or to enter configuration mode.
③	Numeric Entry Keys	<p>0 - 9 Use the 0 to 9 keys to enter numeric values.</p> <p>. Use the decimal key to enter a decimal point.</p> <p>- Use the minus key to enter a negative value.</p> <p>← Use the backspace key to clear entered digits or to cancel the scratchpad.</p> <p>↵ Use the enter key to enter and store a value.</p>
④	Keypad Terminal Display	On keypad terminals, initiate the function of a displayed object, such as an ON or OFF push button, by pressing a function key (F1 - F10).
⑤	Touch Screen Terminal Display	On touch screen & keypad terminals, initiate the function of a displayed object, such as an ON or OFF push button, by touching the screen object. Each interactive screen object occupies one or more of 128 touch cells. The function keys are optional. To initiate functions, use the function keys and/or touch screen objects.
⑥	Touch Cells (Touch Screen Terminal)	The 128 touch cells (16 columns x 8 rows) let you initiate functions by touching the screen. Interactive screen objects are aligned with touch cells when the application is created.

Figure 1.2
PanelView 550 Terminal Features (Back)

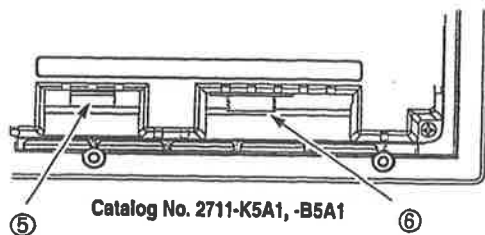
Back View
Catalog No. 2711-K5A2, -B5A2



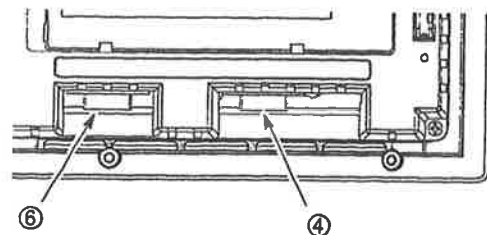
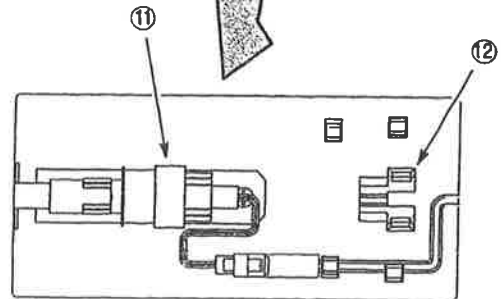
Catalog No. 2711-K5A5, -B5A5



Catalog No. 2711-K5A3, -B5A3



Catalog No. 2711-K5A1, -B5A1



Catalog No. 2711-K5A9, -B5A9

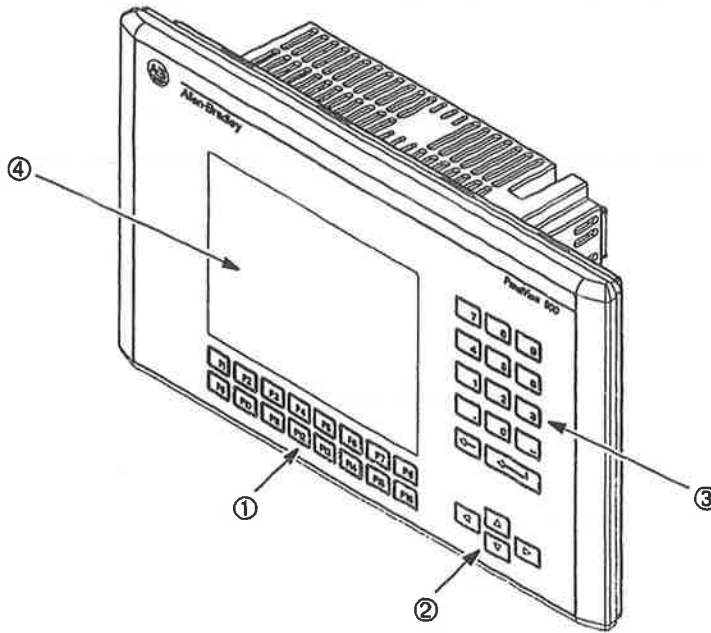
#	Feature	Description
①	Power Connection Terminals	Connects to external power source.
②	DH-485 Communications Port	Connects to an SLC controller, DH-485 network, or Wallmount Power Supply (Catalog No. 1747-NP1).
③	DH-485 Programming Connector	Connects to a Personal Computer Interface Converter (Catalog No. 1747-PIC) for transferring applications. Also connects to an SLC programmer, such as the Hand-Held Terminal (Catalog No. 1747-PT1).
④	RS-232 Communications Port	Connects to the Channel 0 port of an SLC 5/03 or 5/04 controller for point-to-point DH-485 communications. Also connects to the RS-232 serial port of a computer for transferring applications. The Channel 0 port is configured for DH-485 communications using the SLC 500 Advanced Programming Software.
⑤	Remote I/O Port	Connects to a controller scanner or sub-scanner on a Remote I/O network.
⑥	RS-232 Printer/File Transfer Port	Connects to a printer . On Remote I/O terminals this port also connects to the RS-232 serial port of a computer for transferring applications.
⑦	Access Cover	Provides access to the (user replaceable) backlight lamp.
⑧	Sealing Gasket	Seals the front of the terminal to an enclosure or panel.
⑨	COMM LED (Green)	Indicates when communications is occurring.
⑩	FAULT LED (Red)	Indicates firmware or hardware faults.
⑪	Backlight Lamp	Light source for the display backlight. Light transmits through a fiber-optic bundle to the back of the LCD display.
⑫	Spare Bulb Holder	Stores a spare backlight lamp.
⑬	PCMCIA Card Slot	Accepts a memory card which stores applications. Terminal firmware upgrades are provided on a memory card.
⑭	Nameplate Label	Provides product information.

PanelView 900 Features

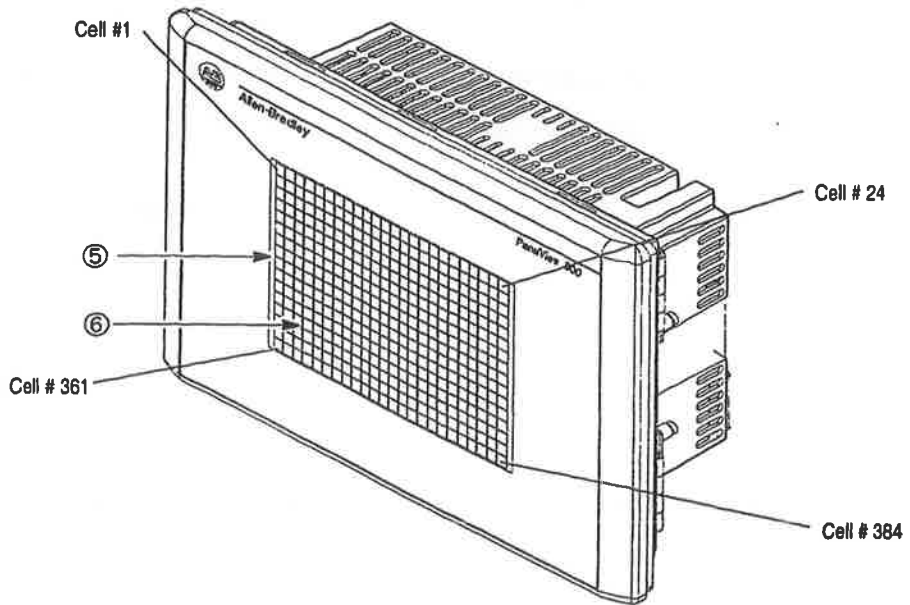
Figures 1.3 and 1.4 show the features of the PanelView 900 monochrome and color terminals. The monochrome terminals are not shown but are very similar to the color terminals.

Figure 1.3
PanelView 900 Terminal Features (Front)

Keypad Terminal
Catalog No. 2711-K9A1, -K9A2, -K9A3, -K9A5, -K9A9, -K9C1, -K9C3, -K9C9



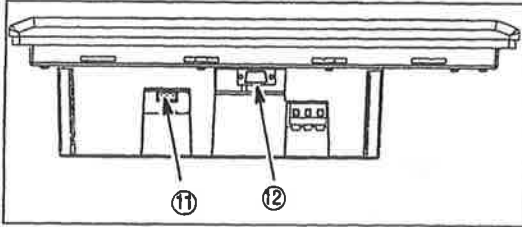
Touch Screen Terminal
Catalog No. 2711-T9A1, -T9A2, -T9A3, -T9A5, -T9A9, -T9C1, -T9C3, -T9C9



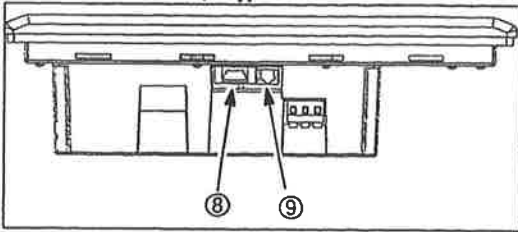
#	Feature	Description
①	Function Keys (F1 - F16)	Use the function keys on keypad terminals to initiate functions on the terminal's display. These keys may have custom legends.
②	Cursor Keys	Use the cursor keys to move the cursor on displayed lists, to select a numeric entry object or to enter configuration mode.
③	Numeric Entry Keys	0 - 9 Use the 0 to 9 keys to enter numeric values. . - Use the decimal key to enter a decimal point. Use the minus key to enter a negative value. ← Use the backspace key to clear entered digits or to cancel the scratchpad. ↵ Use the enter key to enter and store a value.
④	Keypad Terminal Display	On keypad terminals, initiate the function of a displayed object, such as an ON or OFF push button, by pressing a function key F1 - F16.
⑤	Touch Screen Terminal Display	On touch screen terminals, initiate the function of a displayed object, such as an ON or OFF push button, by touching the screen object. Each interactive screen object occupies one or more of the 384 touch cells.
⑥	Touch Cells (Touch Screen Terminal Only)	The 384 touch cells (24 columns x 16 rows) on the touch screen let you initiate functions by touching the screen. Interactive screen objects are automatically aligned with the touch cells when the application is created.

Figure 1.4
PanelView 900 Terminal Features (Back)

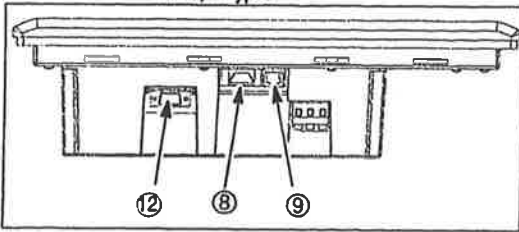
Remote I/O Versions (Catalog No. 2711-K9A1, -K9C1, -T9A1, -T9C1)
Bottom View, Keypad Screen Shown



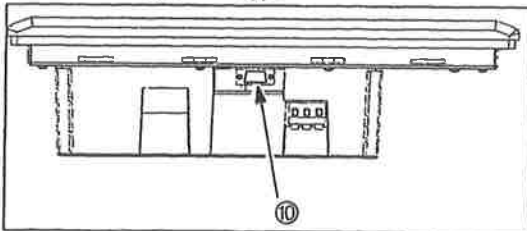
DH-485 Versions (Catalog No. 2711-K9A2, -T9A2)
Bottom View, Keypad Screen Shown



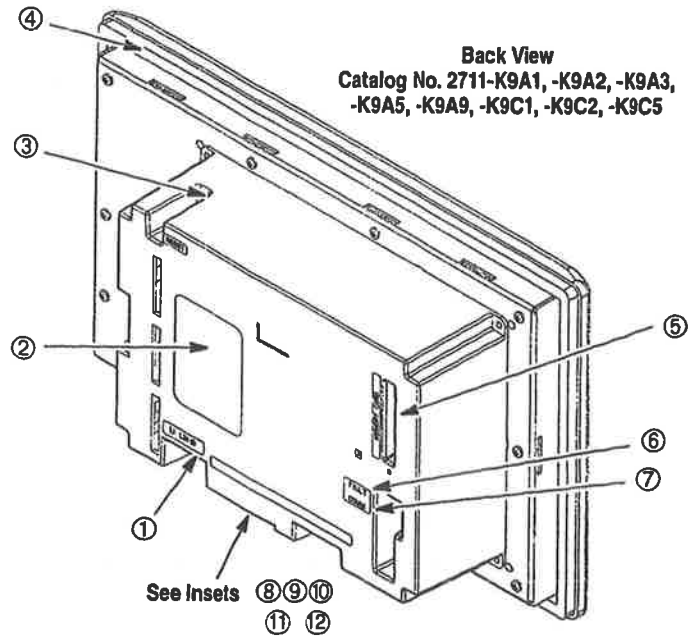
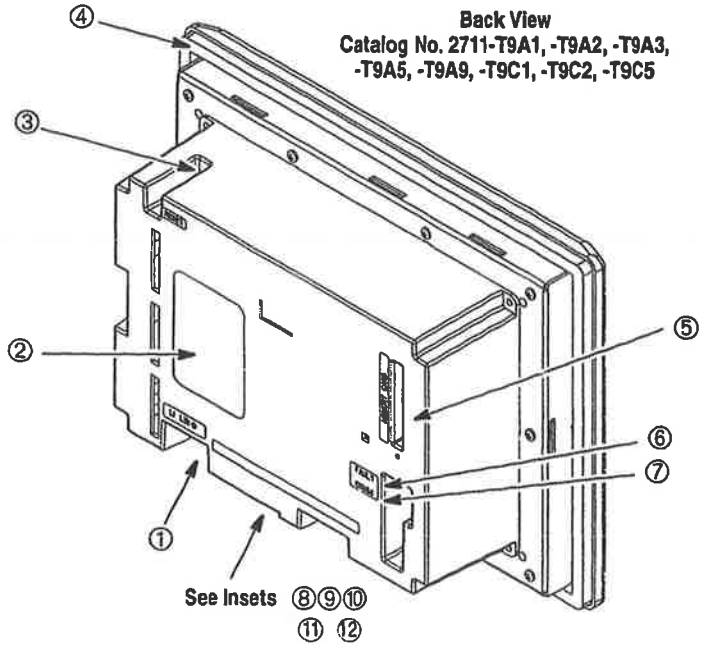
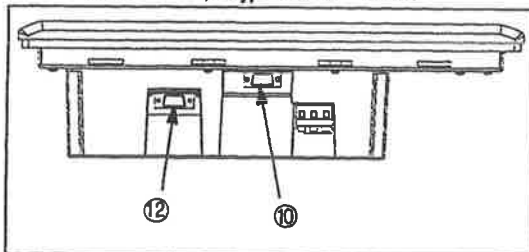
DH-485 Versions with RS-232 Port
(Catalog No. 2711-K9A3, -K9C3, -T9A3, -T9C3)
Bottom View, Keypad Screen Shown



RS-232 Versions (Catalog No. 2711-K9A5, -T9A5)
Bottom View, Keypad Screen Shown



RS-232 Versions with RS-232 Port
(Catalog No. 2711-K9A9, -K9C9, -T9A9, -T9C9)
Bottom View, Keypad Screen Shown

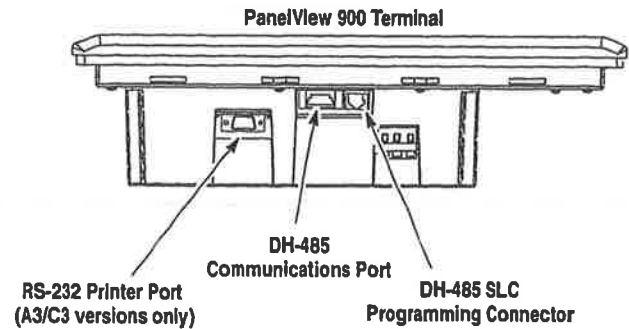
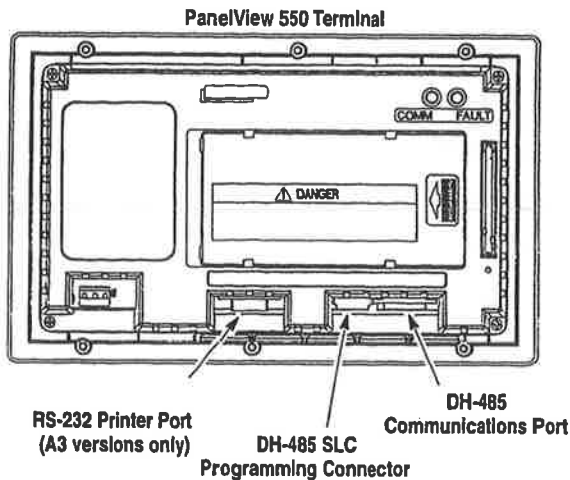


#	Feature	Description
①	Power Connection Terminals	Connects to external power source.
②	Nameplate Label	Provides product information.
③	Reset Button	Resets the terminal.
④	Sealing Gasket	Seals the front of the terminal to an enclosure or panel.
⑤	PCMCIA Card Slot	Accepts a memory card which stores applications. Terminal firmware upgrades are provided on a memory card.
⑥	FAULT LED (Red)	Indicates firmware or hardware faults.
⑦	COMM LED (Green)	Indicates when communications is occurring.
⑧	DH-485 Communications Port	Connects to an SLC controller, DH-485 network, or Wallmount Power Supply (Catalog No. 1747-NP1).
⑨	DH-485 Programming Connector	Connects to a Personal Computer Interface Converter (Catalog No. 1747-PIC) for transferring applications. Also connects to an SLC programmer, such as the Hand-Held Terminal (Catalog No. 1747-PT1).
⑩	RS-232 Communications Port	Connects to the Channel 0 port of an SLC 5/03 or 5/04 controller for point-to-point DH-485 communications. Also connects to the RS-232 serial port of a computer for transferring applications. The Channel 0 port is configured for DH-485 communications using the SLC 500 Advanced Programming Software.
⑪	Remote I/O Port	Connects to a controller scanner or sub-scanner on a Remote I/O network.
⑫	RS-232 Printer/File Transfer Port	Connects to a printer. On Remote I/O terminals this port also connects to the RS-232 serial port of a computer for transferring applications.

DH-485 Communications

(2711-B5A2,-B5A3,-K5A2,-K5A3,
-T9A2,-T9A3,-K9A2,-K9A3,-K9C3,-T9C3)

The DH-485 versions of the PV550 and PV900 (monochrome and color) terminals communicate with external devices through either the DH-485 communications port or the DH-485 programming connector. Both are electrically isolated, the difference is in the connector type.



The A2 versions (2711-B5A2, -K5A2, -T9A2, -K9A2) of the DH-485 terminal have two DH-485 ports.



Use the DH-485 SLC Programming Connector to:

- download/upload PanelView applications
- monitor SLC operation
- test and troubleshoot network devices
- enter/modify SLC programs

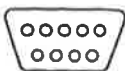


Use the DH-485 Communication Port to connect the terminal to:

- SLC controller
- DH-485 network
- Link Coupler Isolation Module (Catalog No. 1747-AIC)
- SLC 500 Wallmount Power Supply (Catalog No. 1747-NP1)

Use this power supply when transferring PanelView applications between a terminal and a computer without an SLC connected. The power supply provides power for DH-485 communications.

The A3 and C3 versions (2711-B5A3, -K5A3, -T9A3, -K9A3, -T9C3, -K9C3) of the DH-485 terminal also have an RS-232 port.



Use the RS-232 Port to:

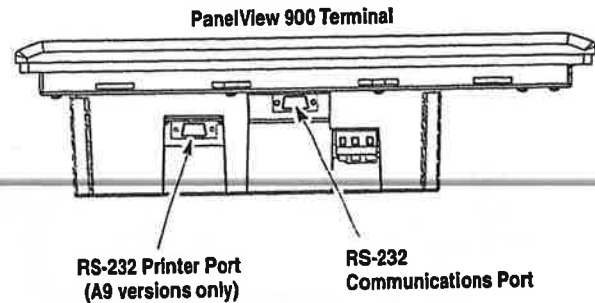
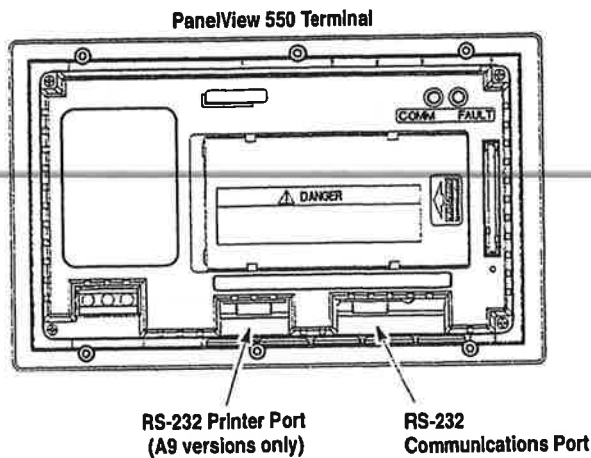
connect a printer that supports the IBM enhanced character set.

Chapter 8 describes the DH-485 communication options and required connections.

RS-232 Communications

(2711-B5A5,-B5A9,-K5A5,-K5A9,
-T9A5,-T9A9,-K9A5,-K9A9,-K9C9,-T9C9)

The RS-232 versions of the PV550 and PV900 (monochrome and color) terminals communicate with external devices through the RS-232 communications port.



The A5 versions (2711-B5A5, -K5A5, -T9A5, -K9A5) of the RS-232 terminal have a single RS-232 communications port.

Use the RS-232 Communications Port to:

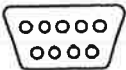
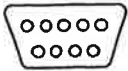
- communicate with a single SLC 5/03 or 5/04 controller (Channel 0 Port)
- download/upload PanelView applications.

The A9 and C9 versions (2711-B5A9, -K5A9, -T9A9, -K9A9, -T9C9, -K9C9) of the RS-232 terminal have an additional RS-232 Printer Port.

Use the RS-232 Printer Port to:

connect a printer that supports the IBM enhanced character set.

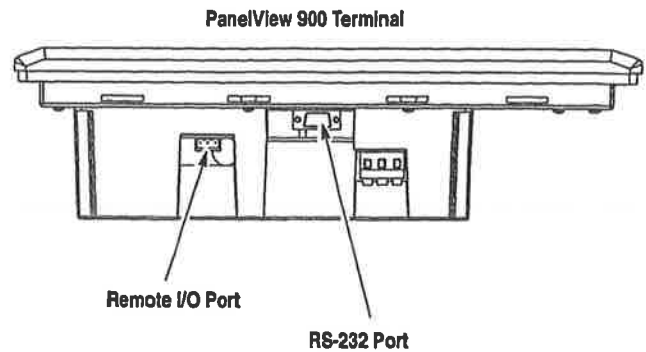
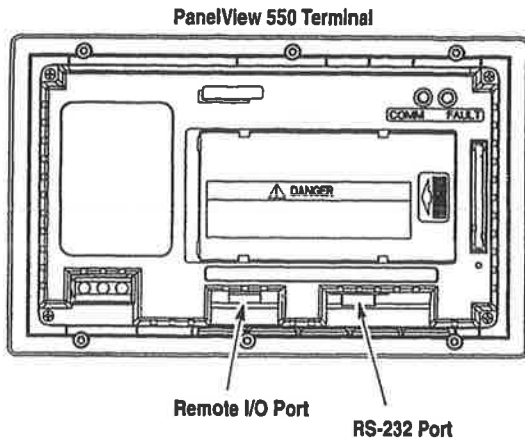
Chapter 9 shows required connections.



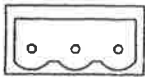
Remote I/O Communications

(2711-B5A1,-K5A1,-K9A1,-T9A1,-T9C1,-K9C1)

The Remote I/O versions of the PV550 and PV900 (monochrome and color) terminals communicate with a PLC or SLC controller/scanner through the Remote I/O port.

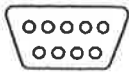


The A1 versions (2711-B5A1, -K5A1, -K9A1, -T9A1, -T9C1, -K9C1) of the Remote I/O terminal have a Remote I/O port and an RS-232 port.



Use the Remote I/O Port to:

- communicate with the Remote I/O scanner port on a PLC controller
- communicate with SLC controllers using a 1747-SN Remote I/O scanner module
- communicate with other Remote I/O scanners
- transfer application using Remote I/O Pass-Through



Use the RS-232 Port to either:

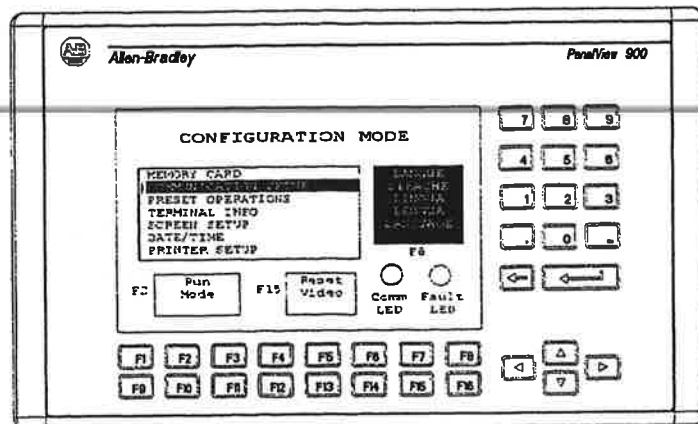
- transfer PanelView applications between a computer and the terminal using a direct connection.
- connect a printer that supports the IBM enhanced character set.

Chapter 10 shows required connections.

Applications

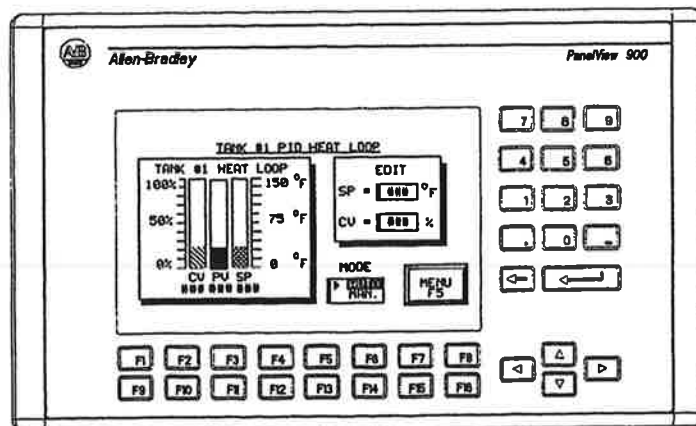
The PV550 and PV900 (monochrome and color) terminals operate with custom designed applications. When power is first applied to the terminal (no application file loaded), the terminal displays the Configuration Mode menu.

Note: Remote I/O terminals provide an out-of-box application for setting remote I/O communication parameters.



Refer to Chapter 3 for a description of terminal functions you can perform with or without an application loaded.

If an application is loaded, the terminal displays the application's startup screen. For example:



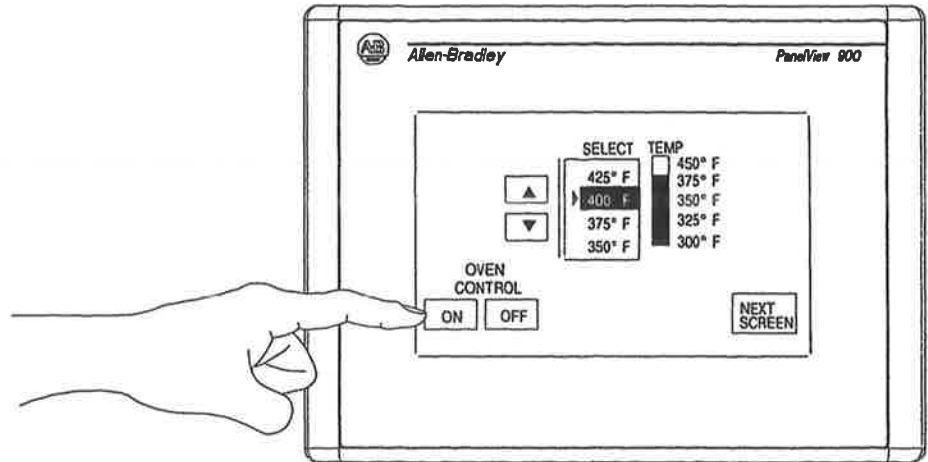
Note: The application designer is responsible for documenting the operation of the application and selecting a startup screen.

How the terminal operates depends on the application and the type of terminal (touch screen or keypad).

Touch Screen Terminal Operation

Applications created for touch screen terminals are controlled by touching an object on the screen.

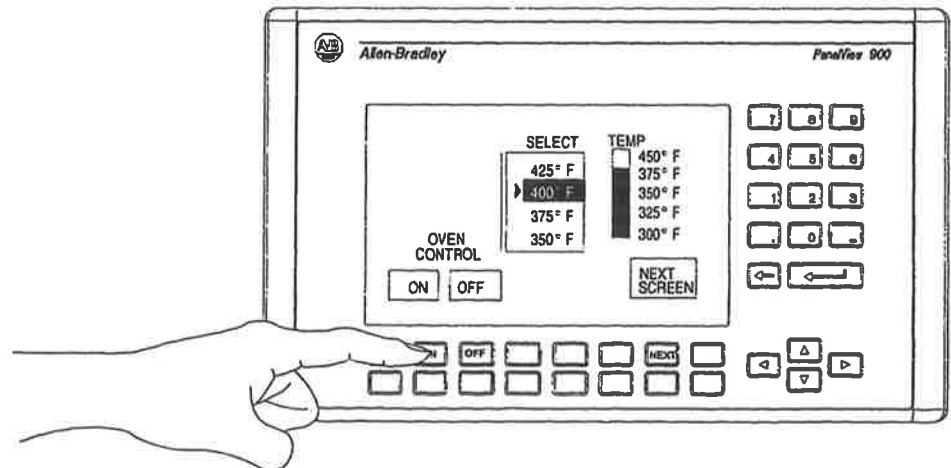
PanelView 550 Keypad and Touch Screen Terminals support both touch and function key input.



ATTENTION: Do not press multiple touch screen objects at the same time. Pressing multiple objects simultaneously may result in unintended operation.

Keypad Terminal Operation

On keypad terminals, the function keys (F1-F10 on PV550 or F1-F16 on PV900) control the operation of the application. Pressing a function key initiates the function of the corresponding object. Enter data manually using the numeric entry keys.





A function key legend kit is available for the PV550 and PV900 terminals to create custom labels as shown above. See Table 1.A.

Configuration Mode Menu

From the Configuration Mode menu on the PV550 and PV900 terminals you can:

- select a terminal language
- upload/download applications with a memory card
- set or display serial communication parameters
- select preset values
- obtain terminal and application information
- adjust screen parameters
- set time and date
- set printer parameters (for terminals with RS-232 printer port)
- return to run mode

To display the Configuration Mode menu:

- On PV900 touch screen terminals, press the Goto Config. Screen button created on a screen during application design.
- On PV550 terminals and PV900 keypad terminals, simultaneously press the left  and right  arrow keys.

Chapter 3 describes all operations on the Configuration Mode menu.

Terminal Messages

Terminal messages:

- display the status of an operation
- indicate minor faults, errors or numeric entry mistakes
- display operator prompts
- display errors that prevent further operations.

Appendix B describes terminal messages and provides a list of recommended actions.

Printing

PanelView terminals equipped with an RS-232 printer port can print:

- triggered messages in a message display
- triggered states of a multistate indicator
- alarm messages
- alarm history

Print attributes for objects are defined in the application.

Any printer that supports the IBM enhanced character set can be connected to the RS-232 printer port.

Alarm History

Terminals with V2.0 firmware support an Alarm History to record triggered alarms. The Alarm History records information on as many alarms (up to 100) that the terminal can hold in nonvolatile RAM. The number of alarms stored in the history is configured using the PanelBuilder software.

The Alarm History records the following data for each alarm:

- acknowledge indicator
 - = Acknowledged Alarm
 - = Unacknowledged Alarm
 - = No Acknowledge Required
- alarm date and time
- acknowledge date and time
- alarm trigger value
- alarm text including variables

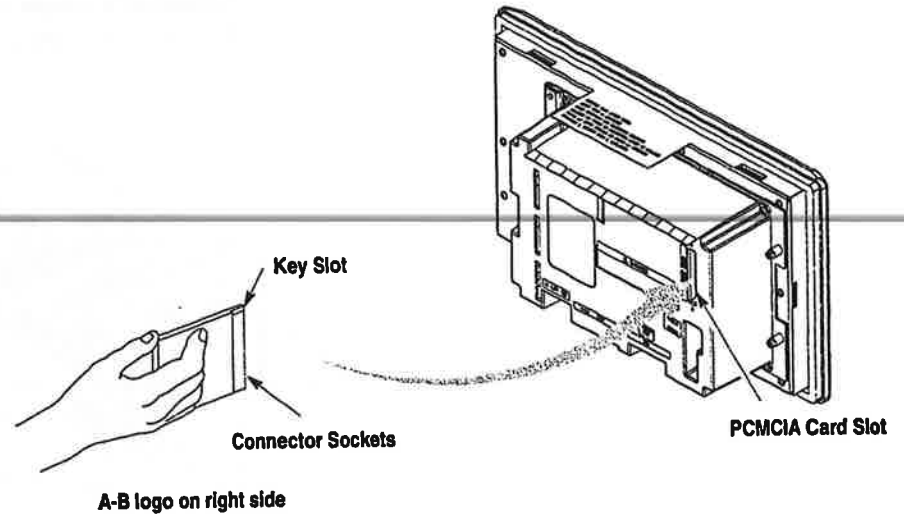
The Alarm History object may appear on the Alarm Banner or other application screens. The data that displays in the history is configured using the PanelBuilder software.

The Alarm History is cleared:

- when an application is downloaded to the terminal
- when the terminal is reset or power is cycled (as defined in the PanelBuilder software)

Memory Card

An optional 256K (Catalog No. 2711-NM11) or 1M memory card (Catalog No. 2711-NM12) allows you to store, load and transfer application files between terminals or computers. The card loads in the back of the terminal with the key slot on top as shown below.



Note: The back of the PV900 terminal is shown above. The location of the PCMCIA card slot on the PV550 terminal is similar.



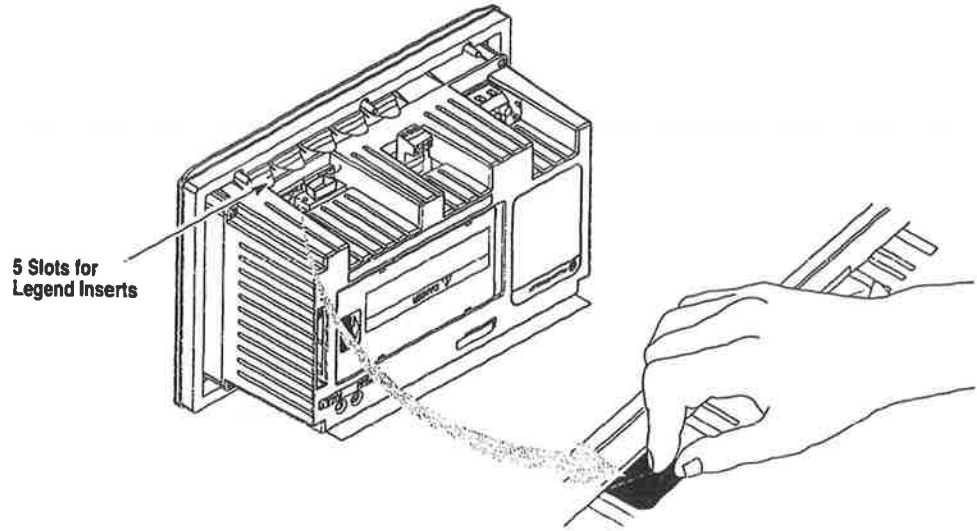
ATTENTION: Explosion Hazard – Do not install or remove memory card, replace lamp, or connect or disconnect equipment unless power has been switched off or the area is known to be non-hazardous.

Function Key Legends

Function Key Legend Kits are available to create custom labels for the function keys of a PV550 or PV900 keypad terminal. Use custom labels to identify keys associated with screen objects.

- **PV550 Function Key Legend Kit (Catalog No. 2711-NF1)**

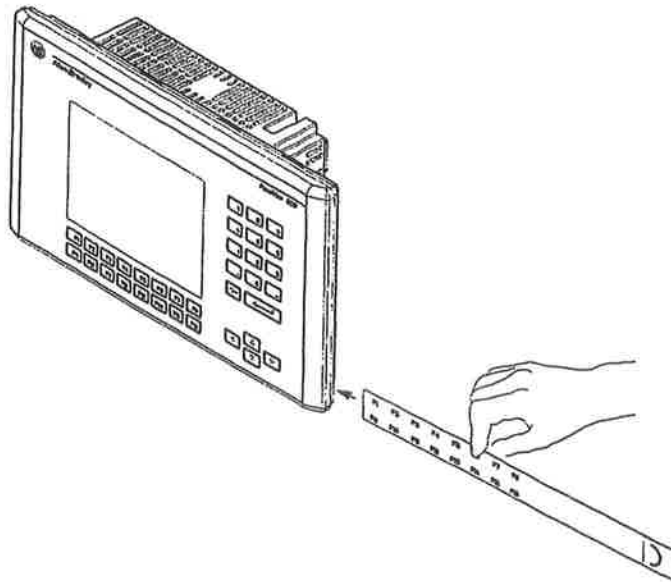
Contains 5 inserts that are preprinted on one side with the labels F1 - F10. Create custom labels on the blank sides of the inserts.



- **PV900 Function Key Legend Kit**

(Catalog No. 2711-NF2A for Monochrome, -NF2C for Color)

Contains one insert that is preprinted on one side with the labels F1 - F16. Create custom labels on the blank side of the insert.



Accessories and Replacement Parts

Table 1.A
Accessories

Item	Catalog No.	PV550	PV900	Description
Configuration Software	2711-ND2	✓		Windows based software required for creating PV550 applications on a computer.
	2711-ND3	✓	✓	Windows based software required for creating PV550 and PV900 applications on a computer.
PanelBuilder 550 to 900 Software Upgrade	2711-ND2ND3	✓		Upgrades PanelBuilder 550 software to PanelBuilder 900 Software allowing you to create applications for both the 550 and 900 terminals.
Function Key Legend Kit	2711-NF1	✓		5 legend inserts for the PV550 terminal. The inserts are preprinted on one side with the function key labels F1- F10 (2 label positions on each insert). Create custom labels on the blank sides of the inserts.
	2711-NF2A		✓	One legend insert for the PV900 keypad (monochrome) terminal. The insert has preprinted function key labels (F1-F16) on one side. Create custom labels on the blank side.
	2711-NF2C		✓	One legend insert for the PV900 keypad (color) terminal. The insert has preprinted function key labels (F1-F16) on one side. Create custom labels on the blank side.
Memory Card	2711-NM11	✓	✓	Blank 256 Kbyte memory card for storing and transferring PV550 or PV900 applications.
	2711-NM12	✓	✓	Blank 1 Mbyte memory card for storing and transferring PV550 or PV900 applications.
Antiglare Overlay	2711-NV4	✓		Self-stick antiglare filter for reducing reflection of display window.
PanelView File Transfer Utility	2711-ND7	✓	✓	Transfers .PVA application files between a DH-485 PV550 or PV900 terminal and a computer from the DOS environment. Does not require Microsoft Windows.
PIC Interface Converter	1747-PIC	✓	✓	Converts RS-232 signals to/from RS-485 signals. Use to transfer PanelView applications between a DH-485 terminal and a personal computer.
Wallmount Power Supply	1747-NP1	✓	✓	Provides power for DH-485 communications when an SLC or network is not connected and supplying power.
Link Coupler	1747-AIC	✓	✓	Links devices on a DH-485 network.
DH-485 Operating and Programming Cable	1747-C10	✓	✓	6 foot (1.83 meter) cable connects a DH-485 PV550 or PV900 terminal to an SLC or DH-485 network.
	1747-C11	✓	✓	1 foot (0.30 meter) cable connects DH-485 PV550 or PV900 terminal to an SLC or DH-485 network.
	1747-C20	✓	✓	20 foot (6.1 meter) cable connects DH-485 PV550 or PV900 terminal to an SLC or DH-485 network.
RS-232 Cable	2711-NC13	✓	✓	16.4 foot (5 meter) cable connects an RS-232 PV550 or PV900 terminal to the Channel 0 port of an SLC 5/03 controller or the RS-232 port of a computer. Each cable end has a 9-pin female, D-shell connector.
	2711-NC14	✓	✓	32.7 foot (10 meter) cable connects an RS-232 PV550 or PV900 terminal to the Channel 0 port of an SLC 5/03 controller or the RS-232 port of a computer. Each cable end has a 9-pin female, D-shell connector.
	2706-NC13	✓	✓	10 foot (3 meter) cable connects an RS-232 PV550 or PV900 terminal to the Channel 0 port of an SLC 5/03 controller or the RS-232 port of a computer. Each cable end has a 9-pin female, D-shell connector.
Remote I/O Cable	1770-CD	✓	✓	Shielded, 3-conductor cable (Belden 9463) for connecting a Remote I/O PV550 or PV900 terminal to a Remote I/O network.

**Table 1.B
Replacement Parts**

Item	Replacement Part No.	PV550	PV900	Description
Backlight Lamp	2711-NL1	✓		Replacement halogen backlight lamp for the PV550 terminal. Provides backlighting for the LCD display.
	2711-NL2		✓	Replacement backlight pack for the PV900 color terminal.
Real Time Clock Module	2711-NB2	✓		Replacement real time clock module for the PV550 terminal (Series D or earlier). Module contains an internal lithium battery.
	2711-NB3		✓	Replacement real time clock module for the PV900 terminal (Series E or later). Module contains an internal lithium battery.
Remote I/O Connector	22112-046-03	✓	✓	Terminal block type connector plugs into the Remote I/O port of a PV550 or PV900 terminal.
Panel Mount Clips	2711-NP2		✓	Set of 6 replacement panel mount clips for the PV900 terminal.

Applying Power

Chapter Objectives

This chapter shows how to apply power to the PV550 and PV900 terminals, including:

- wiring and safety guidelines
- connecting AC power
- connecting DC power
- power-up sequence
- resetting the terminal

Wiring and Safety Guidelines

Use publication 70E, Electrical Safety Requirements for Employee Workplaces when wiring the PV550 and PV900 terminals. In addition to the NFPA general guidelines:

- connect the terminal to its own branch circuit.
The input power source should be protected by a fuse or circuit breaker rated at no more than 15 Amps.
- route incoming power to the terminal by a separate path from the communications cable.



ATTENTION: Do not run signal wiring and power wiring in the same conduit.

- where power and communication lines must cross, they should cross at right angles. Communication lines can be installed in the same conduit as low level DC I/O lines (less than 10 Volts).

Connecting AC Power

The table below shows the AC electrical ratings for the PV550 and PV900 terminals.

Terminal Type	Supply Voltage	Power Consumption
PV550	85 to 264V ac, 47 to 63 Hz	45 VA maximum
PV900M and PV900C	85 to 264V ac, 47 to 63 Hz	110 VA maximum



ATTENTION: Do not apply power to the terminal until all wiring connections have been made. Failure to do so may result in electrical shock.

PanelView 550 AC Power Connections

The PanelView 550 terminal is an IEC 1131-2 Equipment Class I device and requires you to connect the GND (Ground) terminal to an earth conductor.



ATTENTION: The PV550 terminal is designed for safe use when installed in a NEMA Type 12, 13, 4X (indoor use only), IP54 or IP65 rated enclosure.

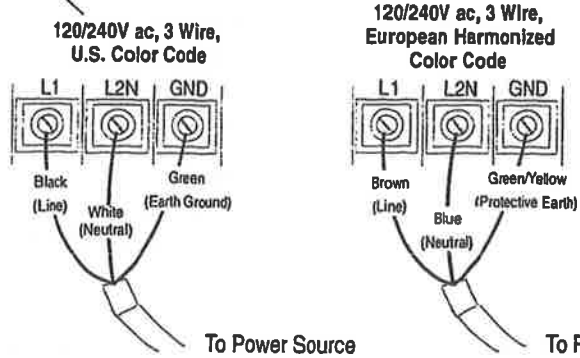
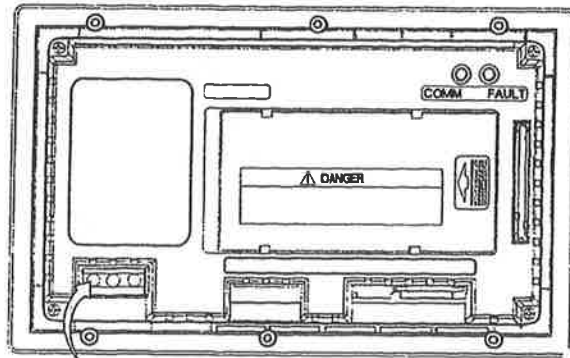


ATTENTION: Explosion Hazard – Do not connect or disconnect equipment while circuit is live unless area is known to be non-hazardous.

Connect the power source to the PV550 terminal at the 3-screw terminal block (fixed).



ATTENTION: Improper wiring of the power terminals may result in voltage at the communication connector shells. Refer to figure below when wiring.



PanelView 900 AC Power Connections

The PanelView 900 terminal is an IEC 1131-2 Equipment Class I device and requires you to connect the \oplus (Protective Earth) terminal to an earth conductor.



ATTENTION: The PV900 terminal is designed for safe use when installed in a NEMA Type 12, 13, 4X (indoor use only), IP54 or IP65 rated enclosure.

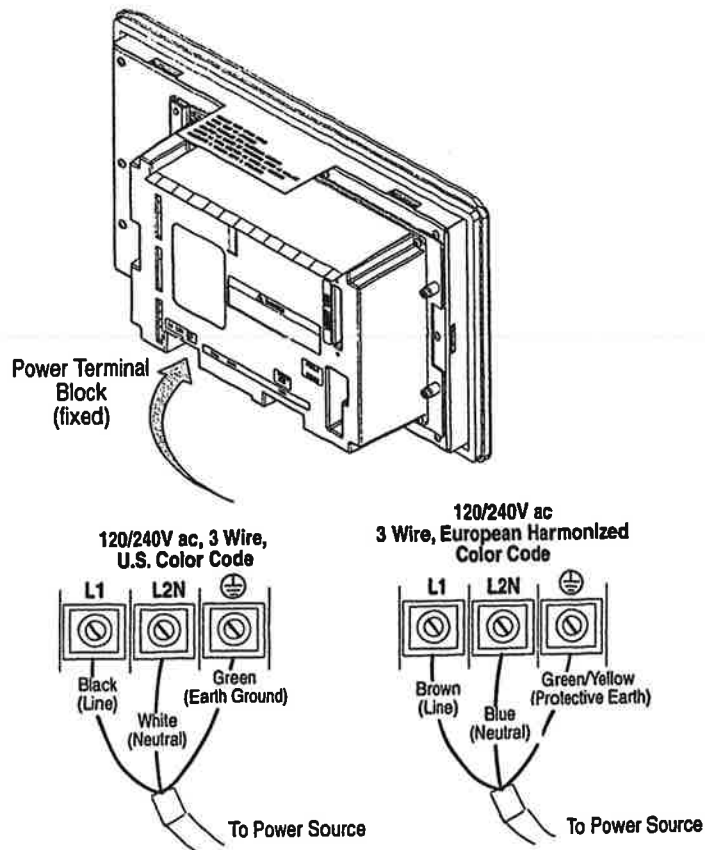


ATTENTION: Explosion Hazard – Do not connect or disconnect equipment while circuit is live unless area is known to be non-hazardous.

Connect the power source to the PV900 terminal at the 3-screw terminal block (fixed).



ATTENTION: Improper wiring of the power terminals may result in voltage at the communication connector shells. Refer figure below when wiring.



Connecting DC Power

The L1 versions (e.g., Catalog No. 2711-K5A1L1, -T9A1L1) of the PV550 and PV900 terminals connect to a 24V dc power source.

The table below shows the electrical ratings for the DC versions of the terminals. Electronic circuitry and an internal fuse protect the terminals from reverse polarity and over-voltage conditions.

Terminal Type	Supply Voltage	Power Consumption
PV550	18 to 30V dc (24V dc nominal)	12 Watts max. (0.5A @ 24V dc)
PV900M	18 to 30V dc (24V dc nominal)	24 Watts max. (2.7A @ 24V dc)



ATTENTION: Do not connect the PanelView terminal to an AC power source. Connecting to an AC power source may damage the terminal.



ATTENTION: The PanelView terminal is designed for safe use when installed in a NEMA Type 12, 13, 4X (indoor use only), IP65 enclosure.

PanelView 550/900 DC Power Connections

To connect DC power to the PV550 or PV900 terminal:

1. Secure the DC power wires to the terminal block screws.
2. Secure the Earth Ground wire to the correct terminal block screw.

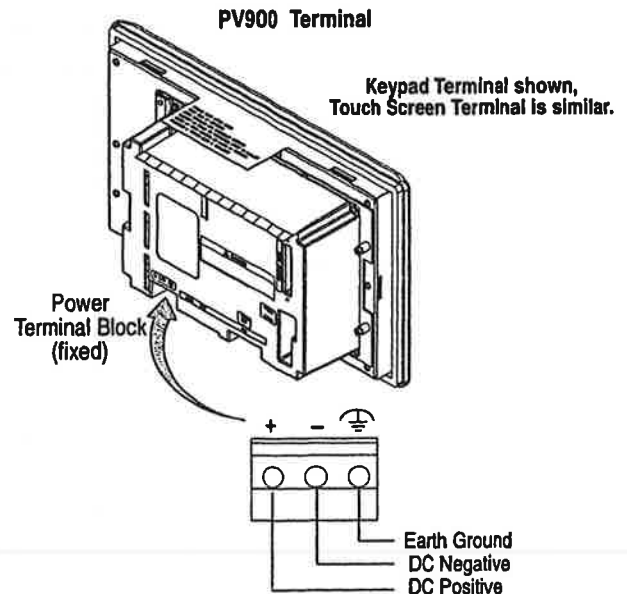
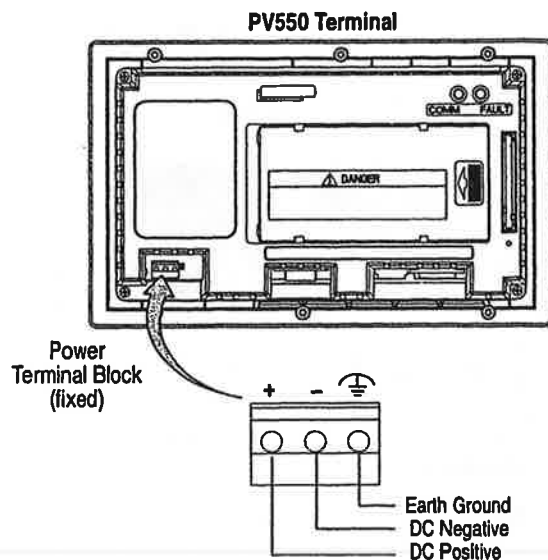


ATTENTION: Explosion Hazard – Do not connect or disconnect equipment while circuit is live unless area is known to be non-hazardous.



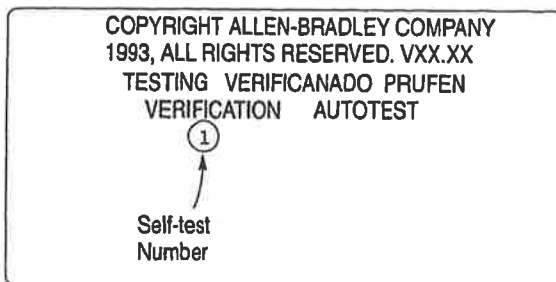
ATTENTION: Do not apply power to the terminal until all wiring connections have been made. Failure to do so may result in electrical shock.

3. Apply 24V dc power to the terminal.



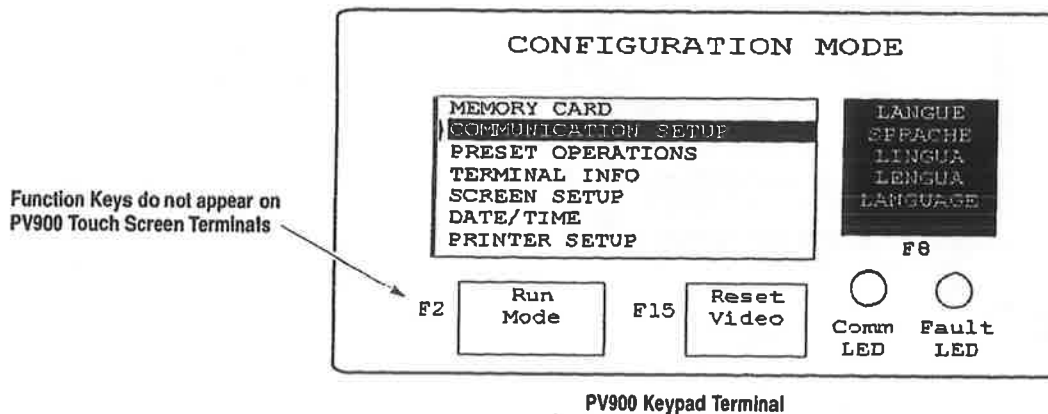
Power-up Sequence

When resetting or applying power to the PV550 or PV900 terminal, the terminal runs a series of self-tests. The initial display shows copyright information and the status of each self-test number. See Appendix B for a description of the self-test numbers.



For DH-485 and RS-232 Terminals

- If an application is loaded, the terminal displays either the:
 - screen present prior to reset or power down
 - startup screen
- If no application is loaded, the Configuration Mode menu appears



Note: The Reset Video button (F15 key) does not appear on PV550 terminals.

For Remote I/O Terminals

An out-of-box application screen opens that lets you set Remote I/O parameters for the terminal. This screen is only available for initial setup. Once an application is downloaded, the Remote I/O setup screen is erased.

Remote I/O Setup

Rack #: Octal Rack Size: F1
 Starting Module Group: F2
 Pass-Through Enabled: F3
 Last Chassis: F4
 Block Transfer Time out: F5
 Baud Rate: F6

PV550 Terminal

Remote I/O Setup

Rack # (Octal): F1
 Rack Size: F2
 Starting Module Group: F3
 Pass-Through Enabled: F4
 Last Chassis: F5
 Baud Rate: F6

PV900 Keypad Terminal

Press this Function Key on Keypad Terminals		To set this Remote I/O Parameter	Description	Options								
PV550	PV900											
↵	F1	Rack #	Sets the rack address of the terminal on the Remote I/O network. On PV550: Press ↵ to open the scratchpad. Enter the rack address and press ↵ again. On PV900: Press F1 to set the rack # and then use the up and down arrow keys to select an address.	0 to 76								
F1	F2	Rack Size	Sets the rack size of the terminal. Each key press displays a different size. The terminal occupies a single rack.	1/4, 1/2, 3/4, Full								
F2	F3	Starting Module Group	Sets the starting module group number of the terminal in the assigned rack. Each key press displays a different module group.	0,1 2,3 4,5 6,7								
F3	F4	Pass-Through Enabled	Enables or disables Pass-Through. Pass-Through allows you to transfer applications between a computer on the DH+ network and a terminal on the Remote I/O link. A PLC5 controller passes the data between the 2 networks.	Yes or No								
F4	F5	Last Chassis	Specifies whether the terminal occupies the last module group in its assigned rack. Only applies to PLC2 controllers.	Yes or No								
F5		Block Transfer Timeout	Specifies a timeout value for block transfers. Each key press displays a different value.	0 to 60 seconds (0 is the default)								
F6	F6	Baud Rate	Sets the baud rate at which the terminal will communicate on the Remote I/O network.	<table border="0"> <tr> <td><u>Baud</u></td> <td><u>Max Cable Length</u></td> </tr> <tr> <td>57.6K (default)</td> <td>10,000 feet</td> </tr> <tr> <td>115.2K</td> <td>5,000 feet</td> </tr> <tr> <td>230.4K</td> <td>2,500 feet</td> </tr> </table>	<u>Baud</u>	<u>Max Cable Length</u>	57.6K (default)	10,000 feet	115.2K	5,000 feet	230.4K	2,500 feet
<u>Baud</u>	<u>Max Cable Length</u>											
57.6K (default)	10,000 feet											
115.2K	5,000 feet											
230.4K	2,500 feet											

Resetting the Terminal





Resetting the terminal re-initializes the PV550 or PV900 terminal (same as cycling power).

PanelView 550 Terminals

To reset the PV550 terminal:

Simultaneously press the left arrow , right arrow  and enter  keys. The terminal performs its power-up sequence.

The sequence in which keys are pressed (while running an application), determines what appears after the reset.

- If you press the left  and right arrow  keys before the enter  key, the Configuration Mode menu appears.
- If you press the enter  key before the arrow keys, the terminal runs the loaded application.

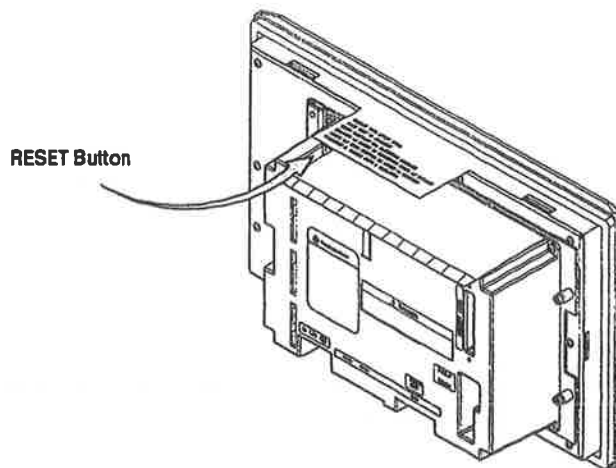
PanelView 900 Terminals

To reset the PV900 terminal:

Press the Reset button on back of terminal. The terminal performs its power-up sequence.



ATTENTION: Use a pointed object to press the Reset button. Do not use the tip of a pencil, graphite may damage the terminal.



Configuration Mode Menu

Chapter Objectives

This chapter describes terminal functions you can access on the Configuration Mode menu.

- application settings
- accessing the Configuration Mode Menu
- selecting a language
- memory card transfer
- DH-485 communication setup
- Remote I/O communication setup
- preset operations
- terminal information
- time and date setup
- screen setup
- printer setup

Application Settings

Configuration parameters are set from the terminal or from the PanelBuilder 550/900 software when creating the application. Settings downloaded with the application have priority over terminal settings if the following option is enabled in the Terminal Setup dialog of the PanelBuilder software.

Use downloaded configuration settings

In addition, the application may allow the controller to change the following while an application is running:

- time and date
- current display screen
- piloted control lists



Accessing the Configuration Mode Menu

From the Configuration Mode menu you can:

- select a terminal language
- upload / download applications with a memory card
- set or display communication parameters
- select preset value options
- obtain terminal and application information
- make screen adjustments
- set time and date
- set printer parameters (for terminals with RS-232 printer port)
- return to run mode

The Configuration Mode menu appears on power-up if an application isn't loaded or if the Configuration Mode menu was the last screen displayed prior to a reset or power down.

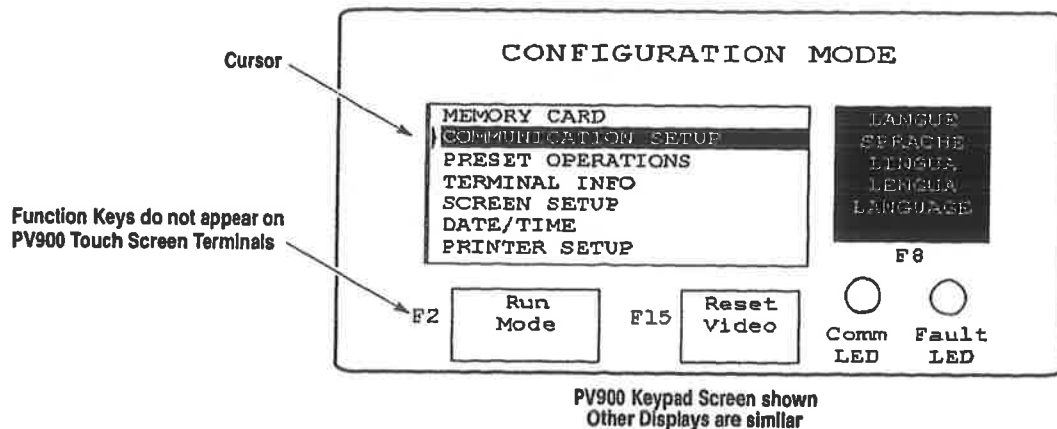
To access Configuration Mode on keypad terminals:

If an application is running, simultaneously press the left arrow  and right arrow  keys on the terminal keypad.

To access Configuration Mode on PV900 touch screen terminals:





- press the Goto Config. Screen button that the application designer placed on an application screen or
- press the filled box that appears in the lower right corner of the screen during power-up

The Configuration Mode menu looks like this:



Note: PV550 terminals do not have a Reset Video button (F15 key)

Operations List

Select an operation using the up  or down  arrow keys. Press  (keypad terminals) or  (PV900 touch screen terminals) to enter the selection.

Language Button [F8]

The Language button, [F8] key on keypad terminals, displays the language menu.

Run Mode Button [F2]

The Run Mode button, [F2] key on keypad terminals, runs the loaded application.

Reset Video [F15] – PV900 Terminals Only

The Reset Video button, [F15] key on PV900 keypad terminals, resets the video to default settings. The reset video function is useful if the screen is set to non-viewable settings.

Comm and Fault LED

The 2 LEDs on the Configuration Mode menu screen indicate the operating state of the terminal. The operating states vary for DH-485 and Remote I/O communications.

Table 3.A
DH-485 LED Indications

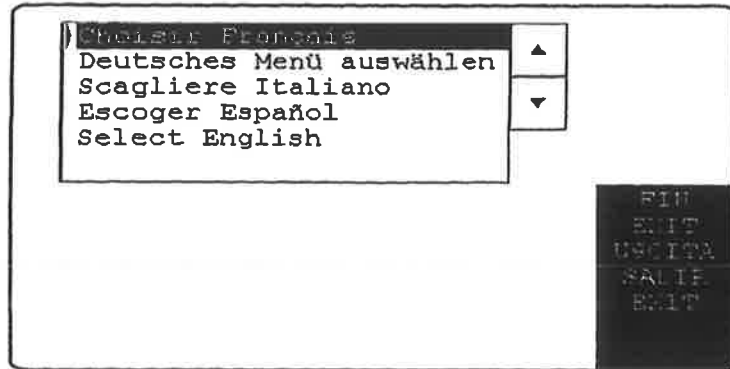
LED	This pattern:	Indicates
Comm	Solid Fill	Normal operating state.
	Blinking	No communications established.
	Flashing	When power is first applied (momentarily).
Fault	No Fill	Normal operating state.
	Blinking	Hardware is functioning but no application file is loaded or the current application is corrupted.

Table 3.B
Remote I/O LED Indications

LED	This pattern:	Indicates
Comm	Solid Fill	Normal operating state.
	No Fill	No communications.
	Blinking	PLC Controller is in program mode.
	Flashing	When power is first applied (momentarily).
Fault	No Fill	Normal operating state.
	Blinking	Hardware is functioning but no application file is loaded or the current application is corrupted.

Selecting a Language

Press the Language button, [F8] key on keypad terminals, from the Configuration Mode menu to display the Language Selection screen.





PV900 Keypad Screen shown
Other Displays are similar

The terminal supports 5 languages:

- French
- German
- Italian
- Spanish
- English

Language List

Select a language using the up  or down  arrow keys. Once selected, all configuration screens and terminal messages are displayed in the selected language.

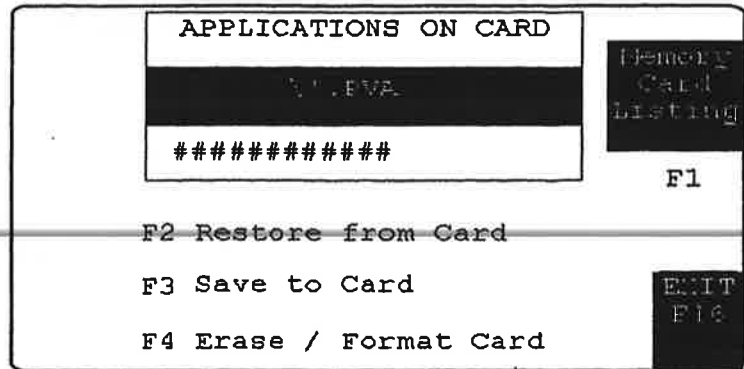
Exit

To return to the Configuration Mode menu:

- press the Exit button on touch screen terminals
- or the [F10] key on PV550 terminals
- or the [F16] key on PV900 keypad terminals

Memory Card Transfer

Use the Memory Card Transfer screen to transfer applications between a memory card and the terminal. Chapter 4 describes the transfer procedure.



PV900 Keypad Screen shown
Other Displays are similar

Memory Card Listing [F1]

Use the Memory Card Listing button, [F1] key on keypad terminals, to display the contents of a memory card. Only one file name is displayed at a time. Press the Memory Card Listing button or [F1] to scroll through the file names.

Applications On Card

Displays the selected application file stored on the memory card.

Restore from Card [F2]

Transfers the application, under Applications On Card, to the terminal. Any application in the terminal is overwritten.

Save to Card [F3]

Saves the current application in the terminal to the memory card.

Erase / Format Card [F4]

Erases and formats the memory card. This function deletes all applications from the card. You can't delete individual files.

Exit

To return to the Configuration Mode menu:

- press the Exit button on touch screen terminals
- or the [F10] key on PV550 terminals
- or the [F16] key on PV900 keypad terminals

DH-485 Communication Setup

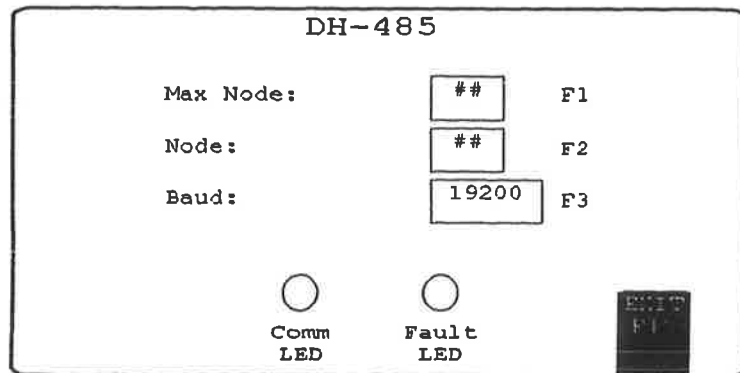
Select Communication Setup from the Configuration Mode menu, to modify or display DH-485 settings for either a:

- DH-485 PanelView terminal
- RS-232 PanelView terminal

Default DH-485 settings are:

- Max Node Address = 31
- Node Address = 2
- Baud Rate = 19200

Note: You can set DH-485 parameters from the terminal or from the PanelBuilder 550/900 Software. Settings downloaded with the application have priority over terminal settings if this option was selected in the Terminal Setup dialog of the software. DH-485 settings take effect immediately after an application is downloaded.



PV900 Keypad Screen shown
Other Displays are similar

Max Node [F1]

Opens the numeric entry scratchpad. Enter the highest node number on the network (up to 31) and press the enter key. (On PV900 touch screen terminals, press the enter key on the scratchpad.) A change to the maximum node address takes effect immediately.

Node [F2]

Opens the numeric entry scratchpad. Enter the node address of the PanelView terminal (0 - 31) and press the enter key. (On PV900 touch screen terminals, press the enter key on the scratchpad.) If you enter a value greater than the maximum node address, the value is accepted and the maximum node address is updated. A node address change takes effect immediately.

Baud [F3]

Steps through the available baud rates: 1200, 2400, 9600, or 19200 with each key press. A selected baud rate takes effect immediately.

Comm LED

Pattern	Indicates
Solid Fill	Normal operating state.
Blinking	No communications established.

Note: The Comm LED momentarily flashes when power is first applied.

Fault LED

Pattern	Indicates
No Fill	Normal operating state.
Blinking	Hardware is functioning but no application file is loaded or the current application is corrupted.

Exit

To return to the Configuration Mode menu:

- press the Exit button on touch screen terminals
- or the [F10] key on PV550 terminals
- or the [F16] key on PV900 keypad terminals

Remote I/O Communication Setup

Select Communication Setup from the Configuration Mode menu to display Remote I/O settings for a PanelView Remote I/O terminal.

Remote I/O settings are configured with the out-of-box application provided with the terminal (see Chapter 2) or from the PanelBuilder Software. All settings on the RIO configuration screen are **read only**, except for baud rate.

The baud rate downloaded with the application file has priority over the terminal setting if you selected this option in the Terminal Setup dialog of the software. A change to the baud rate, after an application is downloaded, takes effect immediately.

RIO Configuration

Rack Number: 3

Rack Size: Full

Starting Group: 0,1

Pass-Through Enabled: Yes

Last Chassis: Yes

Baud: F3

No PLC communication.

PV900 Keypad Screen shown
Other Displays are similar

Rack Number (read only)

Displays the current rack number (0 to 76 octal) of the terminal.

Rack Size (read only)

Displays the current rack size of the terminal. The terminal can occupy $1/4$, $1/2$, $3/4$ or a Full rack.

Starting Group (read only)

Displays the starting module group of the terminal: 0,1 2,3 4,5 6,7

Pass-Through Enabled (read only)

Enables/disables Pass-Through. With Pass-Through enabled, you can transfer applications between a computer on the Allen-Bradley DH+ network and a terminal on the remote I/O link. A PLC5 controller passes the data between the two networks.

Last Chassis (read only)

Indicates if the terminal occupies the last module group in its assigned rack.

Baud [F3]

Steps through the available baud rates: 57.6K, 115.2K, 230.4K. A selected baud rate takes effect immediately. The default baud rate is 57.6K. The maximum cable length is restricted by higher baud rates.

Exit

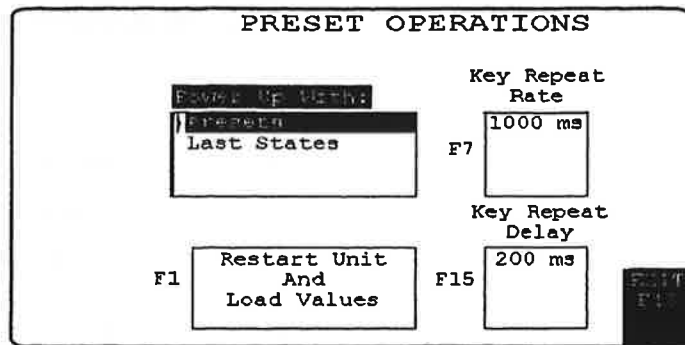
To return to the Configuration Mode menu:

- press the Exit button on touch screen terminals
- or the [F10] key on PV550 terminals
- or the [F16] key on PV900 keypad terminals

Preset Operations



Maintained and multistate push buttons, numeric entry controls, and control list selectors can use a preset (initial value) other than 0. Select Preset Operations from the Configuration Mode menu to set values of control objects with either:

- values provided by the PanelView application, or
- last values entered from terminal prior to a reset or power down.



Keypad Screen shown
Touch Screen is similar

Power-Up With:

Displays the current power-up selection. Use the up  and down  arrow keys on the keypad terminals (or the up and down list keys on PV900 touch screen terminals) to select an option. The selection takes effect the next time the terminal is powered up.

- Select **Presets** to load initial values of control objects (into PLC/SLC data tables) with values supplied by the application.
- Select **Last States** to load initial values of control objects (into PLC/SLC data tables) with values entered at the terminal prior to a terminal reset or power down.

Restart Unit and Load Values [F1]

Press the Restart Unit and Load Values button, [F1] key, to load the selection in the Power-Up With box and reset the terminal.

Key Repeat Rate [F7] – PV900 Terminals Only

Press the Key Repeat Rate button, [F7] key, to step through the key repeat rates: 0 (disabled), 200 ms (5 times/sec), 250 ms (4 times/sec), 330 ms (3 times/sec), 500 ms (2 times/sec), 1000 ms (1 time/sec).

The selected value specifies the number of repeats that occur per second when a key is pressed and released.

Key Repeat Delay [F15] – PV900 Terminals Only

Press the Key Repeat Delay button, [F15] key on keypad terminals, to step through available delay rates: 200 ms, 400 ms, 600 ms, 800 ms, 1000 ms, 1500 ms, 2000 ms, 2500 ms.

The selected value specifies the how long a key must be pressed before it is repeated.

Exit

To return to the Configuration Mode menu:

- press the Exit button on touch screen terminals
- or the [F10] key on PV550 terminals
- or the [F16] key on PV900 keypad terminals

Terminal Information

Select Terminal Info from the Configuration Mode menu to display basic terminal information.

```

                                TERMINAL INFO

    Boot:                        *****

    Firmware:                    *****

    Hardware:
    *****

    Filename:                    *****

                                ***** Bytes Used
                                ***** Bytes Free
  
```

PV900 Keypad Screen shown
Other Displays are similar

Boot

Displays the boot code revision. This information may be needed when contacting Allen-Bradley for technical support.

Firmware

Displays the firmware revision. This information may be needed when contacting Allen-Bradley for technical support.

Hardware

Displays the hardware configuration:

```

Keypad (KP)
Touch Screen (TS)
Keypad and Touch Screen (TS KP)
Communications Port (P0.485, P1.RIO, P0.232)
Screen Size (ss5.5, SS9.0)
  
```

Filename

Displays the name of the active application file. If the application file exists but is invalid, the file name appears as *****.

- **Bytes Used** displays the number of bytes used by the loaded application.
- **Bytes Free** displays the number of bytes available.

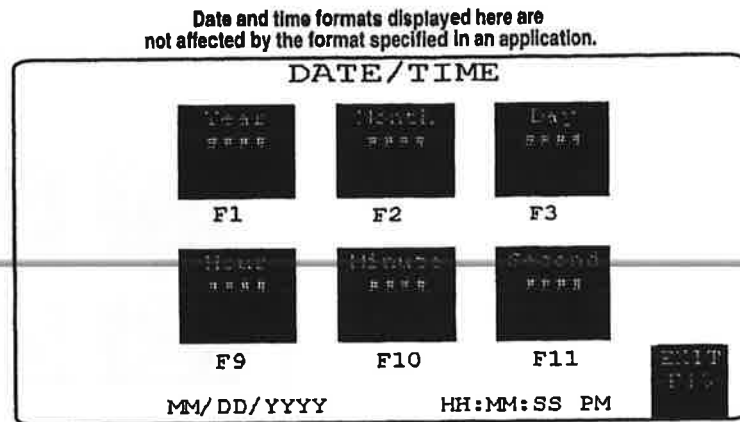
Exit

To return to the Configuration Mode menu:

- press the Exit button on touch screen terminals
- or the [F10] key on PV550 terminals
- or the [F16] key on PV900 keypad terminals

Time and Date Setup

Select Date / Time from the Configuration Mode menu to reset the date and/or time.

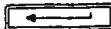


PV900 Keypad Screen shown
Other Displays are similar

Setting the Time

Use screen buttons (touch screens) or function keys to set the time.

On PV550 Press	On PV900 Press	To
Hours button [F6] Key	Hours button [F9] Key	Set current hour
Minutes button [F7] Key	Minutes button [F10] Key	Set minutes
Seconds button [F8] Key	Seconds button [F11] Key	Set seconds


An entry scratchpad is displayed for each setting. Use the terminal keypad to enter the values. Press  after each entry.

All changes take effect immediately.

Setting the Date

Use screen buttons (touch screens) or function keys to set the date.

Press	To
Year button [F1] Key	Set current year
Month button [F2] Key	Set month (1 to 12)
Day button [F3] Key	Set day (1 to 31)

An entry scratchpad is displayed for each setting. Use the terminal keypad to enter the values. Press  after each entry.

All changes take effect immediately.

Exit

To return to the Configuration Mode menu:

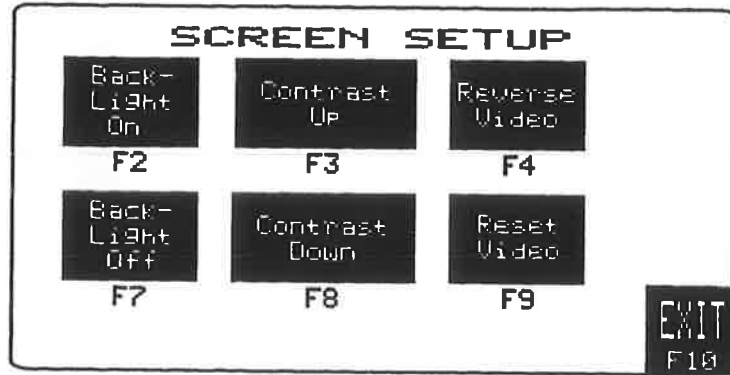
- press the Exit button on touch screen terminals
- or the [F10] key on PV550 terminals
- or the [F16] key on PV900 keypad terminals

Screen Setup

Select Screen Setup from the Configuration Mode menu to adjust the terminal display. Settings take effect immediately.

Screen Setup varies for the PV550 and PV900 terminals.

PanelView 550 Screen Setup



ATTENTION: Certain settings may make viewing the screen difficult. Do not exit this screen until the viewing adjustments are acceptable.

Backlight On [F2] / Backlight Off [F7]

Press Backlight buttons, [F2] and [F7] keys, to control the backlight.

Contrast Up [F3] / Contrast Down [F8]



Press Contrast buttons, [F3] and [F8] keys, to change the contrast of the display. Repeat for more or less contrast.

Reverse Video [F4]

Press Reverse Video button, [F4] key, to toggle reverse video (light text / graphics on a dark background).

Reset Video [F9]

Press Reset Video button, [F9] key, to reset the display to normal (default settings).

The [F9] key is also active on the Configuration Mode menu. If the screen is set to a non-viewable setting, press the left arrow  and right arrow  keys simultaneously on the terminal keypad. Then press [F9] to reset the screen.

Exit [F10]

Press the Exit button, [F10] key, to save the display settings and return to the Configuration Mode menu.

PanelView 900 Screen Setup

SCREEN SETUP		
Normal Intensity 100 F1	SCREEN SAVER Mode off F3	SCREEN CONDITIONER Mode Disabled F6
Video Mode Reverse F2	Timeout 10 min. F4	Hour : Minute ## : 0# F7 F8
Reset Video F15	Intensity 35 F5	EXIT F16



ATTENTION: Certain settings may make viewing the screen difficult. Do not exit this screen until the viewing adjustments are acceptable.

Normal Intensity [F1]

Press the Normal Intensity button, [F1] key on keypad terminals to adjust the intensity of the display. The intensity is adjusted in steps with each key press: 35, 40, 50, 60, 70, 80, 90, 100. The new setting takes effect immediately.

Video Mode [F2]

Press the Video Mode button, [F2] key on keypad terminals, to toggle between normal video (light text / graphics on a dark background) and reverse video (dark text / graphics on a light background). The change takes affect immediately. We recommend normal video.

Screen Saver Mode [F3]

Press the Screen Saver Mode button, [F3] key on keypad terminals, to toggle the screen saver On or Off. When On, the screen intensity is reduced if user input or controller screen changes are not received within the time specified in the Screen Saver Timeout box.

Screen Saver Timeout [F4]

Press the Screen Saver Timeout button, [F4] key on keypad terminals, to adjust the period of time before an inactive screen enters screen saver mode. The timeout is adjusted in steps with each key press: 5 min., 10 min., 15 min., 20 min., 25 min., 30 min.

Screen Saver Intensity [F5]

Press the Screen Saver Intensity button, [F5] key on keypad terminals, to adjust the screen intensity during screen saver mode. The intensity is adjusted in steps with each key press: 0, 35, 40, 50, 60, 70, 80, 90, 100.

Screen Conditioner Mode [F6] – PV900 Monochrome Terminals Only

Press the Screen Conditioner Mode button, [F6] key on keypad terminals, to enable or disable the screen conditioner. This parameter lets you set a daily schedule for conditioning the display of PV900 monochrome terminals to prevent image burn in.

The conditioning process takes approximately 30 minutes. If the terminal is active, the maintenance will not start until the terminal is inactive.

Screen Conditioner Hour [F7] – PV900 Monochrome Terminals Only



Press the Screen Conditioner Hour button, [F7] key on keypad terminals, to specify the hour at which to start the screen conditioner. The hour is adjusted in steps with each key press: 0 – 24.

Screen Conditioner Minute [F8] – PV900 Monochrome Terminals Only

Press the Screen Conditioner Minute button, [F8] key on keypad terminals, to specify the minute at which to start the screen conditioner. The time is adjusted in steps with each key press: 0 – 60.

Reset Video [F15]

Press the Reset Video button, [F15] key on keypad terminals, to reset the display to normal (default settings).

Note: On keypad terminals, the [F15] key is also active on the Configuration Mode menu screen. If the screen is set to a non-viewable setting, press the left arrow  and right arrow  keys simultaneously. Then press [F15] to reset the screen.

Exit [F16]

Press the Exit button, [F16] key on keypad terminals, to save the display settings and return to the Configuration Mode menu.

Printer Setup

Select Printer Setup from the Configuration Mode menu to set parameters for those terminals equipped with an RS-232 printer port. Any printer that supports the IBM enhanced character set can be connected to the RS-232 printer port.

The Printer Setup option will not appear on the Configuration Mode menu if the terminal does not have an RS-232 serial port.

Print settings are maintained between power cycles.

Page format parameters for printing are defined in the Terminal Setup dialog and downloaded with the application.

PRINTER SETUP

Handshaking None F1	Communication Parameters No Parity 8 Data Bits 2 Stop Bits F2	Baud Rate 1200 F3
Top Of Form F9	Port Mode Printing F10	EXIT F16

PV900 Keypad Screen shown
Other Displays are similar

Handshaking [F1]

Press the Handshaking button, [F1] on keypad terminals, to specify the type of handshaking used by the RS-232 port.

- None (initial default)
- Hardware
- Software

Communication Parameters [F2]

Press the Communication Parameters button, [F2] on keypad terminals, to set the communication parameters of the printer port. Each key press toggles through the available combinations for:

- Parity (Even or Odd)
- Data Bits (7 or 8)
- Stop Bits (1 or 2)

Baud Rate [F3]

Press the Baud Rate button, [F3] on keypad terminals, to set the baud rate of the printer port. The baud rate must match the baud rate of the printer. The baud rate is adjusted with each key press: 1200, 2400, 4800, 9600, 19200. The initial default is 9600.

Top of Form [F9]

Press the Top of Form button, [F9] on keypad terminals, to advance the printer to the top of the next page.

Manually adjust the printer to the top of the page before pressing the Top of Form button. The printer also uses the Perforation Skip Value (if defined in the Printer Setup of the PanelBuilder Software) when the Top of Form button is pressed.

On powerup, the printer is automatically set to top of form.

Port Mode [F10]

Press the Port Mode button, [F10] key on keypad terminals, to toggle the RS-232 port between printer mode and file transfer mode.

The RS-232 port of the terminal must support both printing and application transfers to switch between these modes.

Exit [F16]

Press the Exit button, [F16] key on keypad terminals, to save the printer settings and return to the Configuration Mode menu.

Using a Memory Card

Chapter Objectives

This chapter describes how to transfer applications between the PanelView terminal and a PCMCIA memory card.

- loading application from a memory card
- loading application on a memory card



For details on transferring applications between a computer and the PV550 or PV900 terminal, see the PanelBuilder 550/900 Configuration Software manual (Publication 2711-6.0).

Loading Application from a Memory Card

This section shows how to load an application into the terminal from a memory card.



ATTENTION: Explosion Hazard – Do not install or remove memory card unless power has been switched off or the area is known to be non-hazardous.

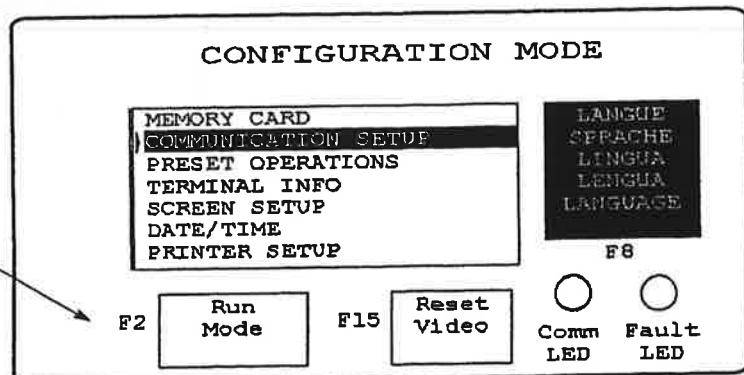
To load an application from a memory card:

1. Install the memory card in the terminal.


If the terminal does not have an application loaded, the Configuration Mode menu automatically appears. Skip step 2.

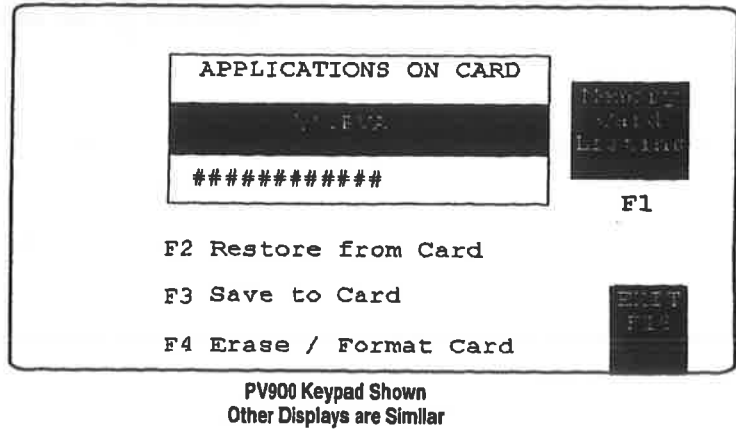
2. Open the Configuration Mode menu by simultaneously pressing the left and right arrows (on keypad terminals) or the Goto Config. Screen button (on touch screen terminals).

Function Keys do not appear on PV900 Touch Screen Terminals



Note: PV550 terminals do not have a Reset Video button (F15 key)

3. Select Memory Card and press Enter .

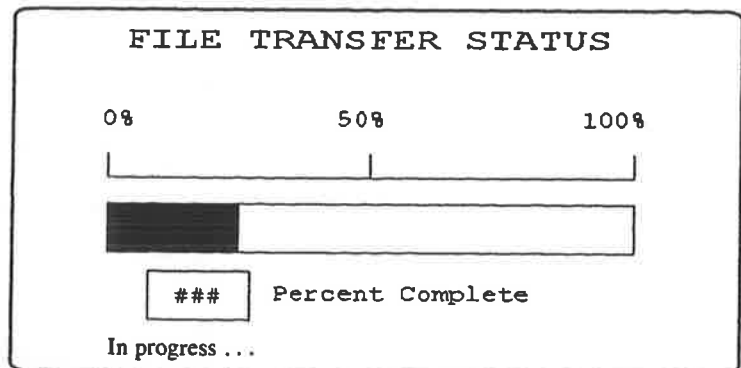


4. Press Memory Card Listing, [F1] on keypad terminals, until the application file you want to load is displayed.
5. Press Restore From Card, [F2] key on keypad terminals, to begin the transfer.

Because this operation overwrites the current application in the terminal, you are prompted to abort or continue.

Proceed with download?
F1 - Abort
F2 - Continue

While the transfer is in progress, the terminal displays the status.



6. When the transfer is complete, the PanelView terminal checks the validity of the application, resets and runs the application.



Loading Application on a Memory Card

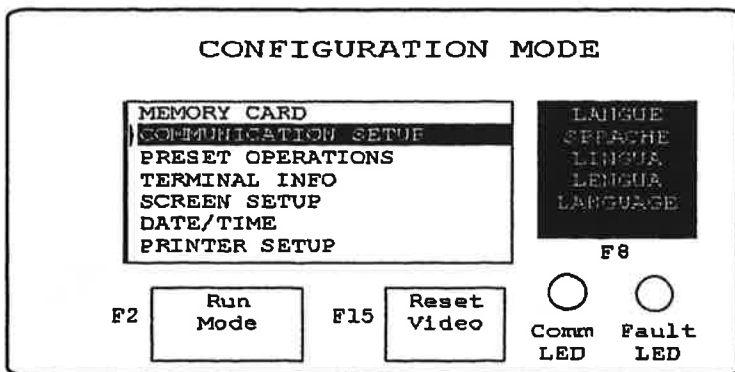
This section shows how to load an application in the terminal onto a memory card.

To transfer an application to a memory card:

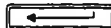


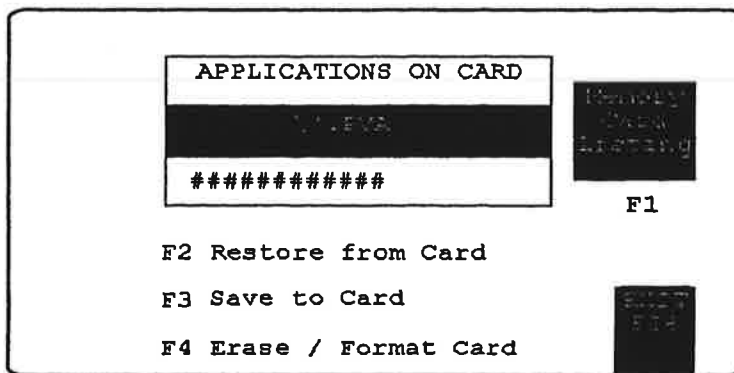
ATTENTION: Explosion Hazard – Do not install or remove memory card unless power has been switched off or the area is known to be non-hazardous.

1. Install the memory card in the terminal.
2. Open the Configuration Mode menu by simultaneously pressing the left  and right  arrows (on keypad terminals) or the Goto Config. Screen button (on touch screen terminals).



PV900 Keypad Shown
Other Displays are Similar

3. Select Memory Card and press the enter  key.



PV900 Keypad Shown
Other Displays are Similar

- If necessary, press Erase / Format Card, [F4] key on keypad terminals, to format or erase the memory card.

Because this operation erases all data on the memory card, you are prompted to abort or continue.

Format erases entire card.

F1 - Abort

F2 - Continue

- Press Save to Card, [F3] on keypad terminals, to transfer the application in the terminal to the card.

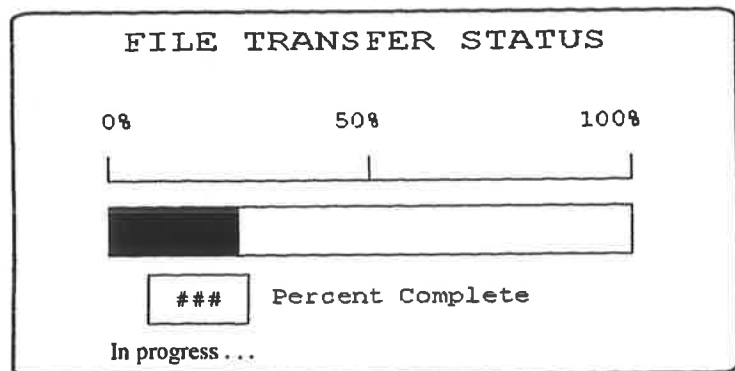
If the application file already exists on the memory card, you are prompted to abort or continue.

The PVA file exists:

F1 - Abort

F2 - Upload with new PVA file

While the transfer is in progress, the terminal displays the status.



- When the transfer is complete, the application file name appears in the Applications On Card listing. Press Memory Card Listing, [F1] key on keypad terminals, to scroll through the list.

Note: If you uploaded a file that already exists on the memory card, the uploaded file name is altered with a sequentially numbered digit as a suffix. For example, Control.pva becomes Control0.pva.

For files with eight character names, the last character is overwritten by the digit. For example, Motorcon.pva becomes Motorco0.pva.

Running Applications

Chapter Objectives

This chapter describes operating procedures that are common to most application programs.

- application information
- push button operation
- control lists
- numeric entry controls
- screen selectors
- list indicators
- multistate indicators
- bar graph displays
- numeric data displays
- message displays
- time or date
- printing
- alarms

Application Information

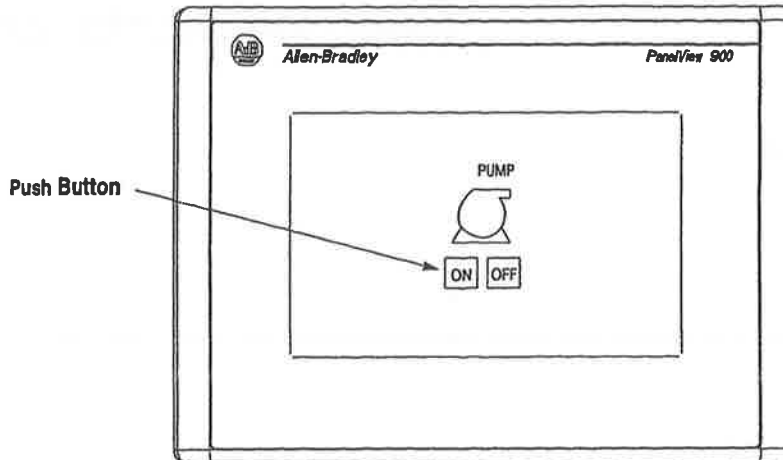
The application designer is responsible for documenting the operation of an application. Before running an application, you should understand what processes are being controlled and monitored.



ATTENTION: Do not press multiple touch screen objects at the same time. Pressing multiple screen objects simultaneously may result in unintended operation.

Push Button Operation

Screen push buttons function like similar mechanical push buttons.



Push buttons can have a variety of appearances. Push buttons may change their inner text, fill pattern, border or shape when pressed (each state assigned different attributes).



Toggle Foreground/
Background



Border, White Fill



No Border,
Diagonal Fill



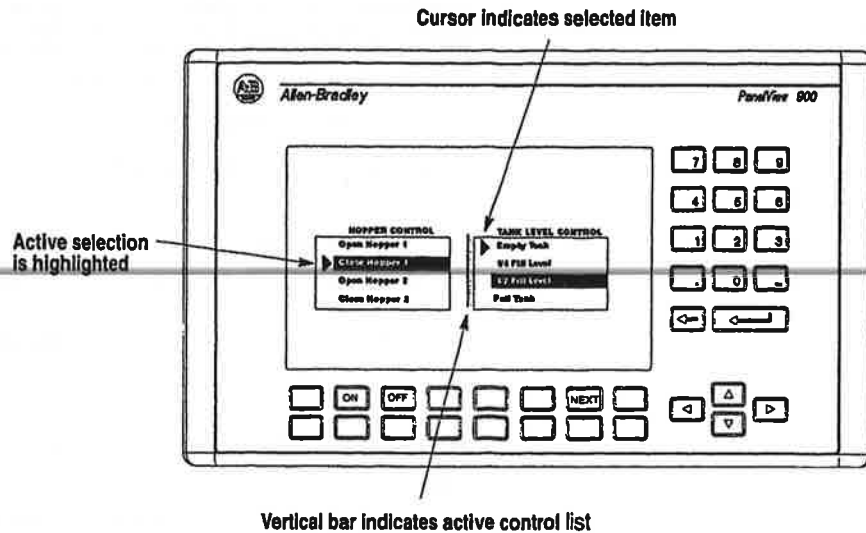
Ellipse
White Fill

The following attributes are common to most push buttons:

- All push buttons are momentarily disabled (0.5 second) after screen changes. This prevents multiple buttons, in the same location on different screens, from being pressed inadvertently.
- All buttons must be released on the previous screen before buttons can be pressed on the new screen.
- Momentary push buttons are assigned a hold time. The hold time maintains the pressed state so that each change of state can be read by the controller at least once. The hold time varies between 0 and 1 second depending upon the configured setting.

Control Lists



Control lists perform functions similar to push buttons. They can modify either individual bits or values at a controller address.





Active List Item

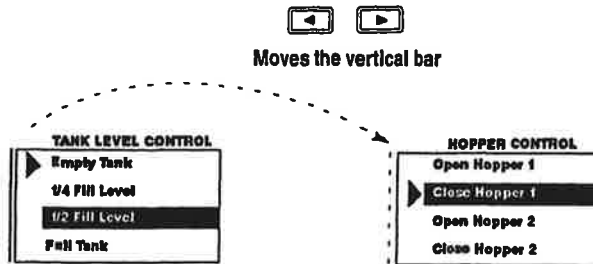
Active item is highlighted.

Active Control List



Has a vertical indicator bar on left side of list. Only 1 control list or numeric entry cursor point is active on a screen. Activate a control list by touching the object (touch screen only), pressing the assigned function key, or using the left  or right  arrows to move the indicator bar between control lists and numeric cursor points.

To activate a control list:

- touch the object (touch screen only)
- or press the assigned function key
- or on a screen with multiple control lists or numeric cursor points, press the left  or right  arrows to move the indicator bar between the objects.



Cursor

Indicates the item selected. Move the cursor up or down the control list using the up  and down arrows . Cursor operation is configured by the application designer. If the cursor is at the first or last item in a control list, pressing the up arrow key (when at top) or down arrow key (when at bottom) will either:









- cause no movement of the cursor, or
- move cursor to the top or bottom of the list.



If the list contains more items than can appear at one time, the list will scroll. If the cursor is at the top or bottom of a scrolling list, the list scrolls one row at a time as the arrow keys are pressed.

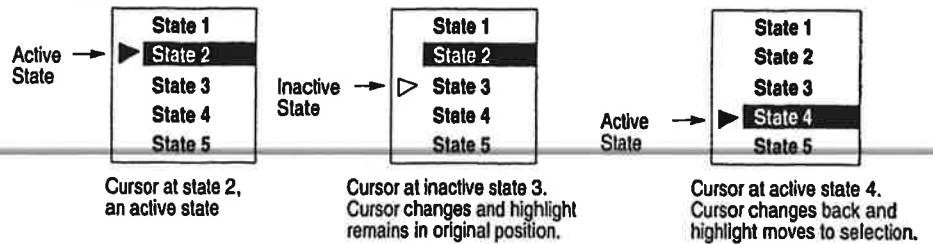
List Keys – PV900 Terminals Only

PV900 touch screen terminals require list keys on the screen to move the cursor in a control list and select entries. The following table shows the available list keys.





List Key	Type	Description
	Move Up	Moves the cursor to the previous item in the list.
	Move Down	Moves the cursor to the next item in the list.
	Home	Moves the cursor to the first item in the list.
	End	Moves the cursor to the last item in the list.
	Page Up	Moves the cursor up one page in a scrolling list.
	Page Down	Moves the cursor down one page in a scrolling list.
	Backspace	Returns the cursor to the currently highlighted selection.
	Enter	Confirms a selection and sends the value to the controller if Write on Enter was configured for the control list.

Cursor - Piloted Control Lists

On a piloted control list, some items are under controller operation only. In addition, some items may be designated as inactive. You cannot select controller items or inactive items. In both cases, the cursor appears as a hollow arrow head when you select the item.

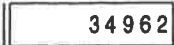
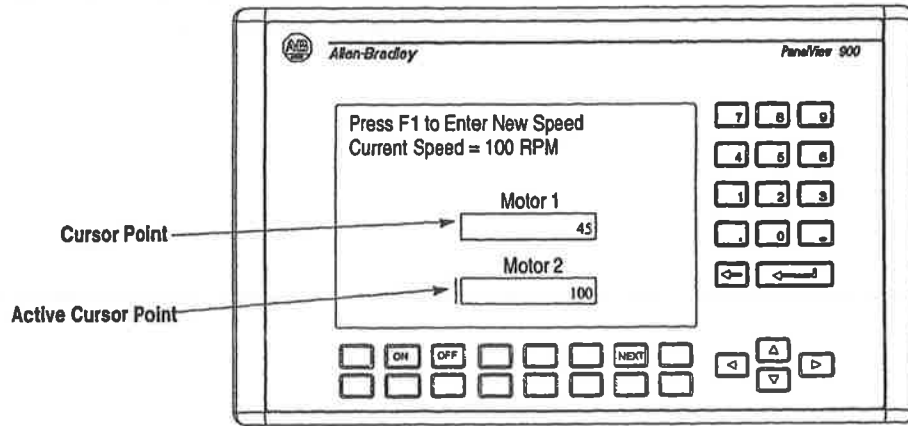


To select an item on a control list:

1. Select the control list by:
 - touching the object (touch screens only)
 - or pressing its function key
 - or pressing the left  or right  arrow keys until the control list has a vertical bar indicating that it is active.
2. Move the cursor up or down the control list using the up  or down  arrows. If the cursor appears as a hollow arrow head, the item cannot be selected.
3. Depending on the application design, you may or may not have to press Enter to enter the selection indicated by the cursor.

Numeric Entry Controls

Two types of controls allow numeric value at a tag address: Cursor Point and Keypad Enable button.



Numeric Entry Cursor Point

Cursor points appear as a box. A vertical line on the left side of the box appears when the cursor point is selected. Data is entered in a scratchpad.

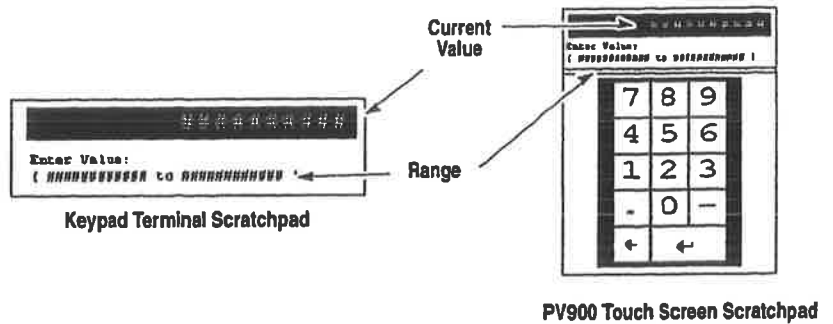


Keypad Enable Button

A keypad enable button appears like a standard push button. The data displayed in the button is the last value sent to the button's tag address. When selected, a numeric entry scratchpad is displayed.



Scratchpad

Both controls display a numeric entry scratchpad in the center of the screen. The scratchpad shows the range of values that can be entered in the data entry field.



During data entry, wait until the number you enter appears in the scratchpad before entering the next number.

To enter a value using a cursor point:

1. Select the cursor point by:
 - touching the object (touch screens only)
 - pressing the associated function key
 - pressing the left  or right  arrows until the cursor point shows a vertical bar

2. Press Enter or type the first digit of the number you want to enter.

The scratchpad opens.

3. Enter the value using the terminal keypad and press Enter.


To enter a value using a keypad enable button:

1. Press the keypad enable button.


The scratchpad opens.

2. Enter the value using the terminal keypad and press Enter.

To change an entry on a scratchpad:

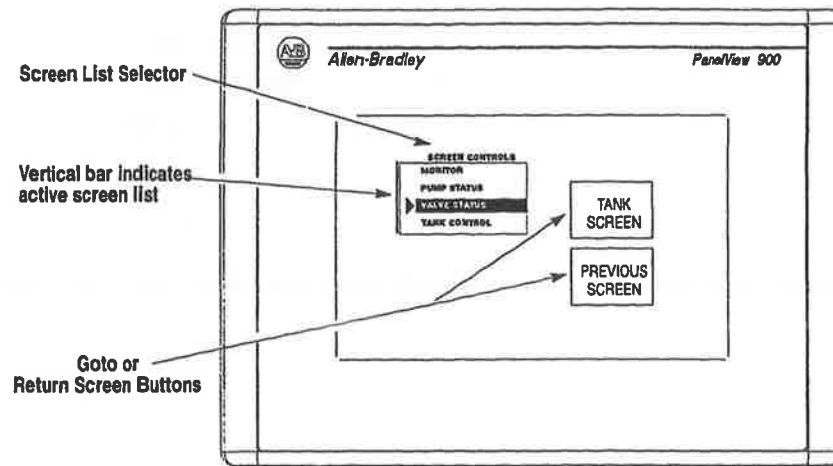
1. Press the backspace  key to delete one character at a time.
2. Enter the new value and press Enter.

To cancel a scratchpad:

1. Press the backspace  key to delete one character at a time.
2. When pressing backspace in an empty scratchpad (value = 0), the scratchpad is removed.

Screen Selectors



The 2 types of screen selector controls are Screen List Selectors and Screen Buttons.





Goto and Return screen buttons can have a variety of appearances such as unique inner text, fill pattern, border or shape. Return type screen buttons display the previous screen. Goto buttons display the assigned screen.

Screen lists display a list of application screens. The selected screen is highlighted.

To activate a screen list:

- touch the object (touch screen only)
- or press the assigned function key
- or on a screen with multiple screen lists, press the left  or right  arrow key until a vertical bar appears.

To select an item on a screen list:

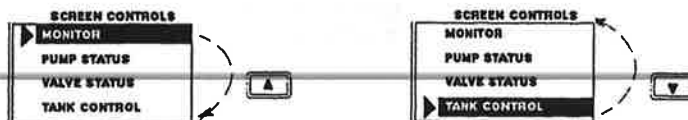
1. Move the cursor up or down the screen list using the up  and down  arrows.
2. Press Enter to enter the selection.

The selected screen is displayed.

Cursor Operation

Cursor operation is configured by the application designer. If the cursor is at the first or last item in a screen list, pressing the up arrow key (when at top) or down arrow key (when at bottom) will either:









- cause no movement of the cursor, or
- move cursor to the top or bottom of the list.



If a screen list contains more items than can appear at one time, the list will scroll. If the cursor is at the top or bottom of a scrolling list, the list scrolls one row at a time as the up/down arrows are pressed.

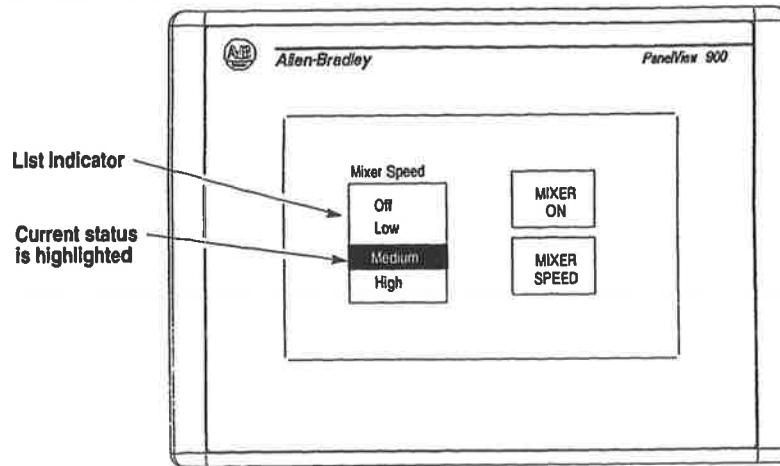
List Keys – PV900 Terminals Only

PV900 touch screen terminals require list keys on the screen to move the cursor and select an entry in a screen list. The following table shows the available list keys.

List Key	Type	Description
	Move Up	Moves the cursor to the previous item in the list.
	Move Down	Moves the cursor to the next item in the list.
	Home	Moves the cursor to the first item in the list.
	End	Moves the cursor to the last item in the list.
	Page Up	Moves the cursor up one page in a scrolling list.
	Page Down	Moves the cursor down one page in a scrolling list.
	Backspace	Returns the cursor to the currently highlighted selection.
	Enter	Confirms a selection and displays the screen.

List Indicators

List indicators highlight an item from a list depending upon the status of either a bit or value at a controller address.



An indicator list may have a maximum of 255 entries. The list automatically scrolls to display the status of an item.

Note: List indicators do not have a cursor ► like control or screen selector lists do.

Multistate Indicators

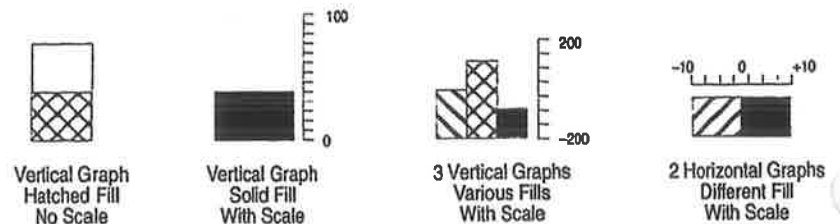
Multistate indicators display the status of either a bit or value at a controller address.

Multistate indicators can have a variety of appearances. In addition, multistate indicators may change their inner text, fill pattern, or graphic with each state (each state assigned different attributes). Each indicator may have up to 500 states. Here are a few examples.



Bar Graph Displays

Bar graphs provide a graphical representation of a variable value. Bar graphs can appear with or without scales and border, and can have a variety of rectangular shapes and fill patterns.



Numeric Data Displays

Numeric Data Displays may appear with or without supporting text.

Flow = 37 Gallons

0 0 0 2 3 9 . 4 5

Depending on the application design, displayed data may:

- be zero filled
- have fixed, floating or no decimal point
- have different field widths (number of digits)
- have various text sizes
- be scaled.

Message Displays

Message displays contain alphanumeric characters and are displayed when triggered by a controller. The message display can be any size and will not overlap other controls. Messages may contain:

- alphanumeric text
- variable data
- graphics
- time and date.

Time or Date

Time and date information can appear as a separate item or in some control / display objects (push buttons, multistate indicators, message displays, or data displays). Time and date can appear with or without supporting text.

The date can have a variety of formats.

Month/Day/Year 7/3/95	With Leading Zeroes 07/03/95
Day/Month/Year 3/7/95	With 4 Digit Year 3/7/1995
Year/Month/Day 95/7/3	With User - Defined Separator 7*3*95

The time can also have a variety of formats.

12 Hour Format 2:56	With Time Zone & Time Standard Designations 2:56 PM CST
24 Hour Format 14:56	With Leading Zeroes 02:56
With Seconds 14:56:29	With User - Defined Separator 14*56*29

Printing

Terminals equipped with an RS-232 printer port can print:

- triggered messages in a Message Display
- triggered states of a Multistate Indicator
- alarm messages
- alarm history

Text is printed without formatting options. Print attributes for objects and alarms are defined in the application.

Printing is a background operation. While printing, the terminal continues to update and you can perform other terminal operations.

The terminal prints messages in the same order they are received. If the print buffer is full, the terminal displays a queue full warning message. New print requests are aborted.

The print queue is not maintained between power cycles. Any messages in the queue when the terminal is reset are cleared.

Alarms

Applications that support alarms may contain:

- Alarm Banner display that pops up when alarm is triggered
- Alarm buttons that enable the operator to act on an alarm
 - Print Alarm
 - Acknowledge Alarm
 - Clear Alarm
 - Acknowledge All
- Alarm History that records all alarms
 - Print History button
 - Clear History button

Alarm configurations are application dependent. Consult your application designer for details on how to handle alarms for your application.

Installing the PV550 Terminal

Chapter Objectives

This chapter describes how to mount the PV550 terminal in a panel or enclosure

- Series C terminals
- enclosures
- required tools
- mounting dimensions
- clearances
- cutout dimensions
- installing the PV550 in a panel

Series C Terminals

Series C (or higher) PV550 terminals are certified for Class I Division 2 Hazardous Locations.



ATTENTION: In Class I, Division 2 Hazardous locations, the PanelView 550 terminal must be wired per the National Electric Code and/or Canadian Electric Code as it applies to hazardous locations.

Series C terminals have an operating temperature code of T2 (maximum operating temperature is 300°C or 572°F). Install Series C terminals in environments where atmospheric gases **do not** have ignition temperatures less than 300°C (572°F).

Enclosures

Mount the PV550 terminal in a panel or enclosure to protect the internal circuitry. The terminal meets NEMA Type 12 / 13 and 4X (indoor use) ratings only when mounted in a panel or enclosure with the equivalent rating.

Allow enough space within the enclosure for adequate ventilation. Consider heat produced by other devices in the enclosure. The ambient temperature around the terminal must be between 0° and 55° C (32° and 131° F).

Make provisions for accessing the back panel of the terminal for wiring, routine maintenance, installing a memory card, and troubleshooting.

Required Tools

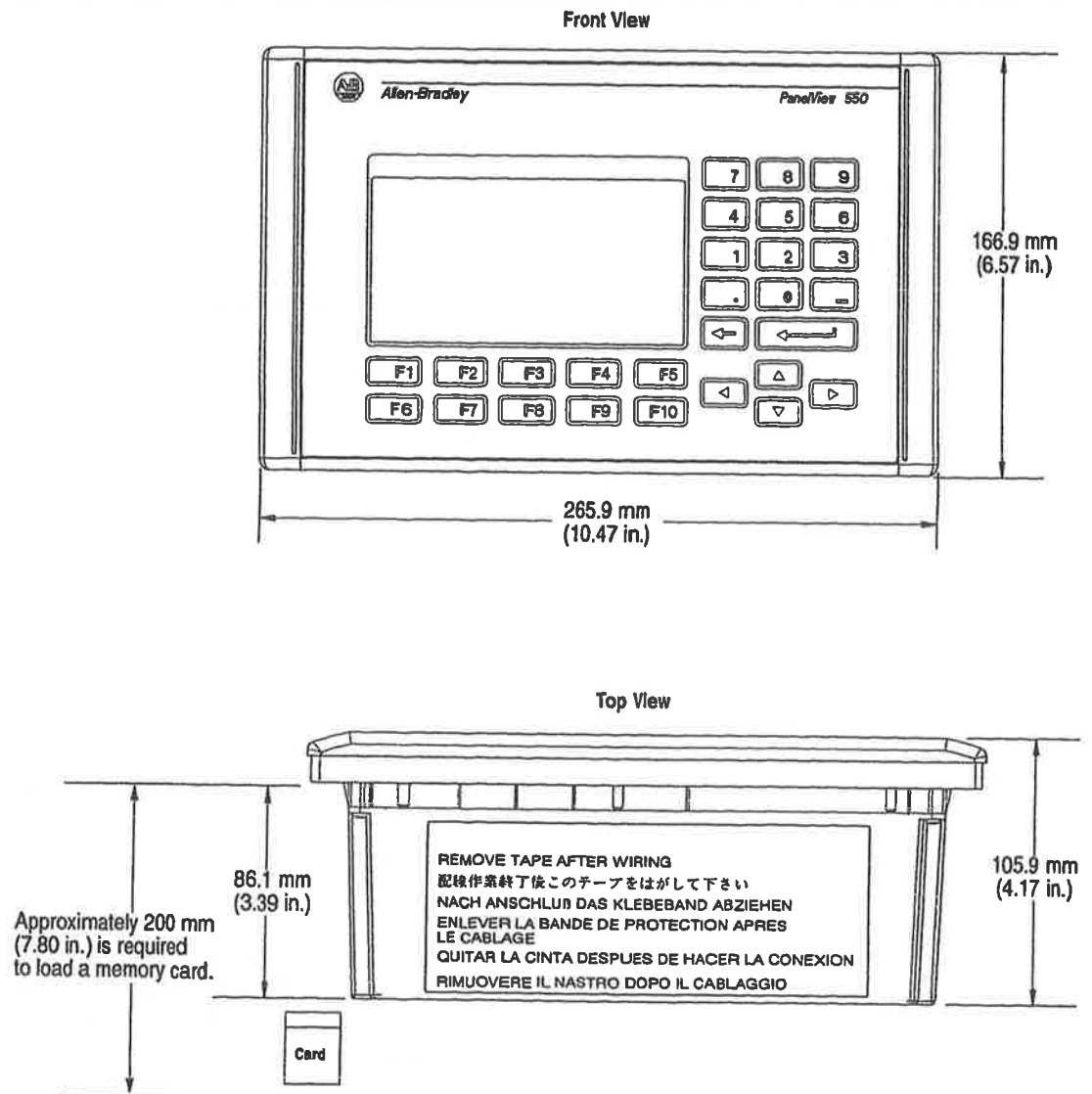
Other than the tools required to make the panel cutout, the tools required for PV550 installation are:

- 7mm (M4) deep well socket wrench or nut driver
- small slotted screwdriver
- torque wrench (in. / lbs).

Mounting Dimensions

Figure 6.1 shows mounting dimensions for the PV550 terminal.

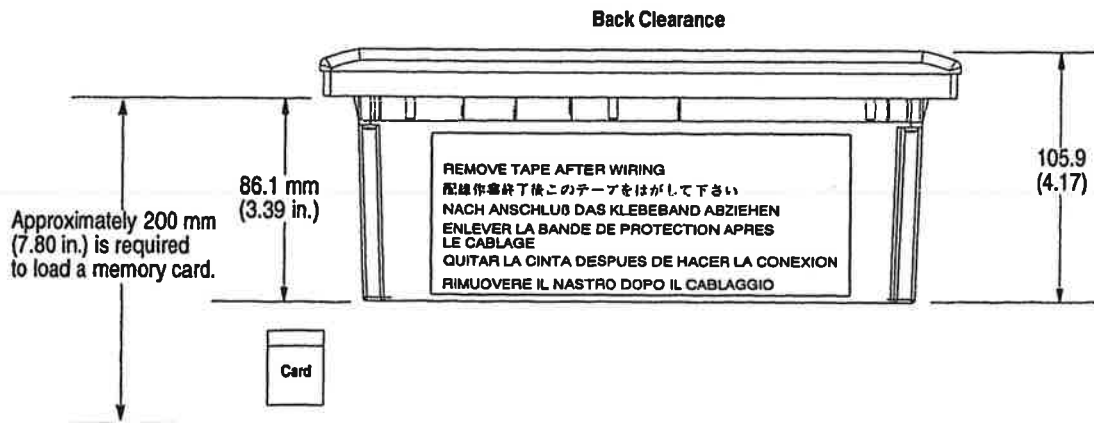
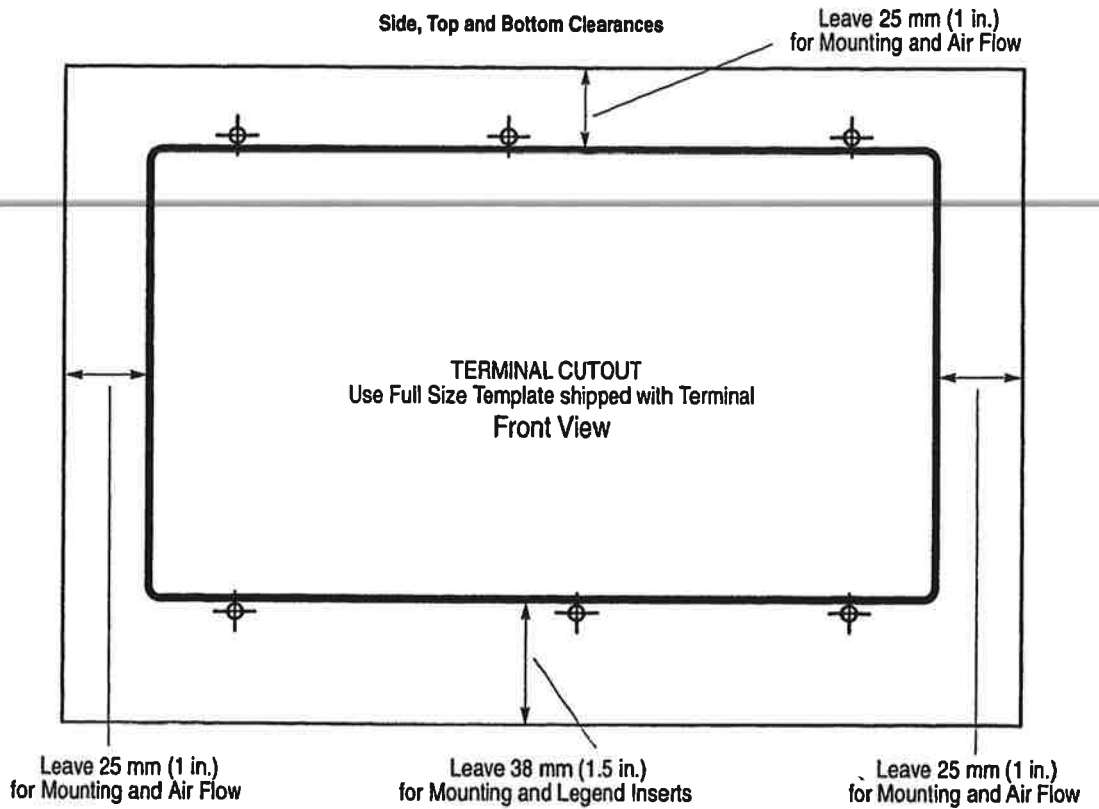
Figure 6.1
PV550 Mounting Dimensions



Clearances

Allow adequate space for mounting, air flow, maintenance, memory card and legend insert installation. See Figure 6.2.

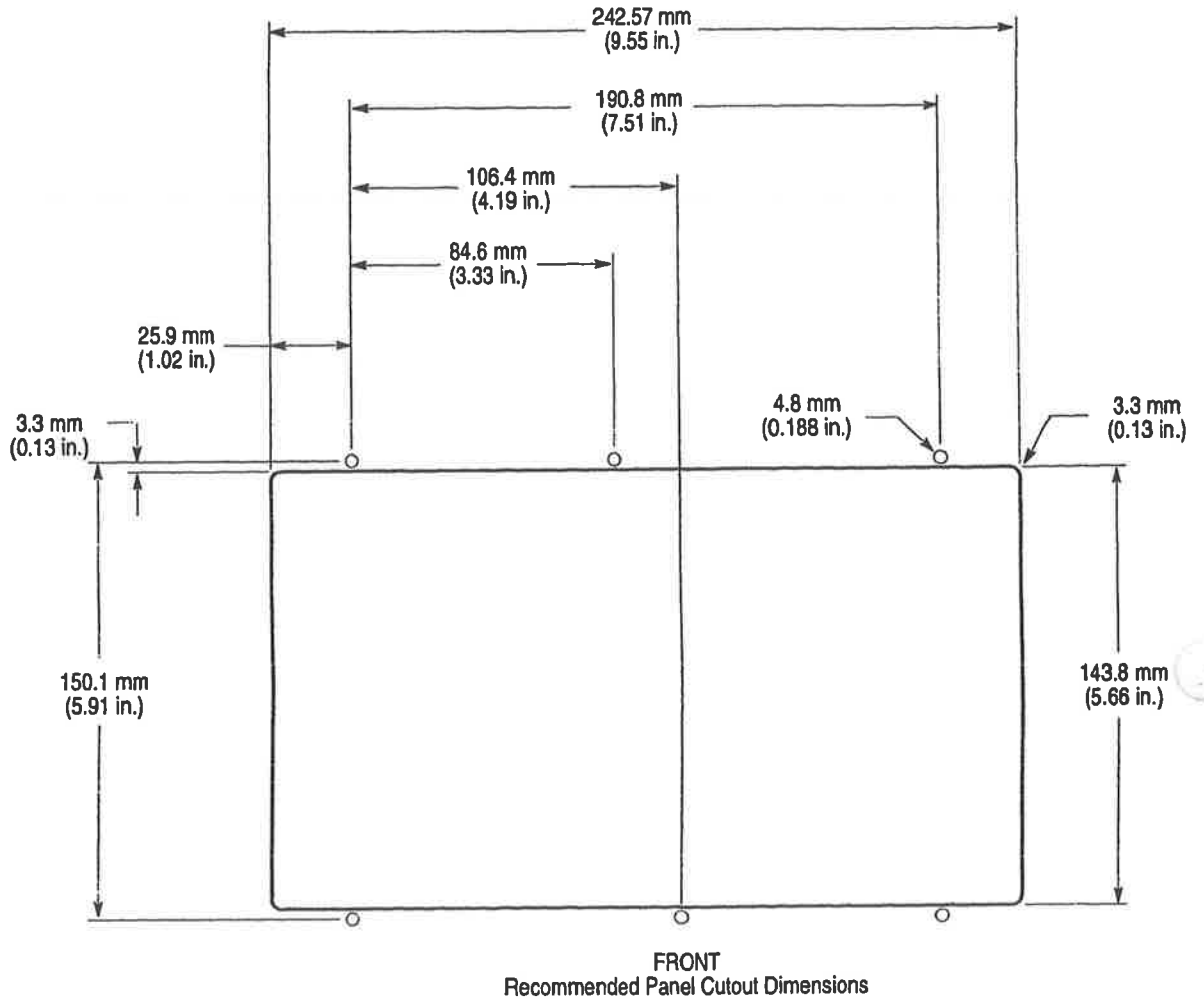
Figure 6.2
PV550 Mounting Clearances



Cutout Dimensions

Use the full size cutout template shipped with the PV550 terminal to mark the cutout dimensions. Figure 6.3 provides a reduced cutout with dimensions.

Figure 6.3
PV550 Panel Cutout Dimensions



Installing the PV550 in a Panel

To install the PanelView 550 terminal in a panel:



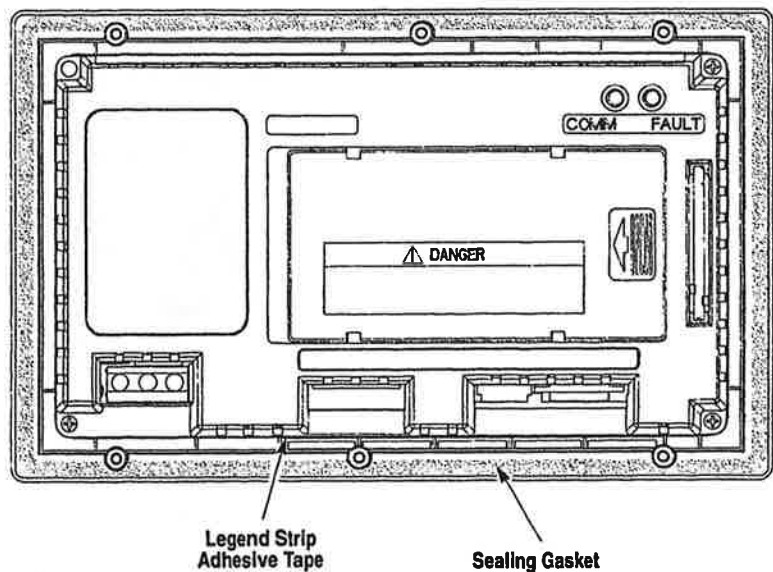
ATTENTION: Disconnect all electrical power from the panel before making cutout.

Make sure the area around the panel cutout is clear.

Take precautions so that metal cuttings do not enter any components that may already be installed in panel.

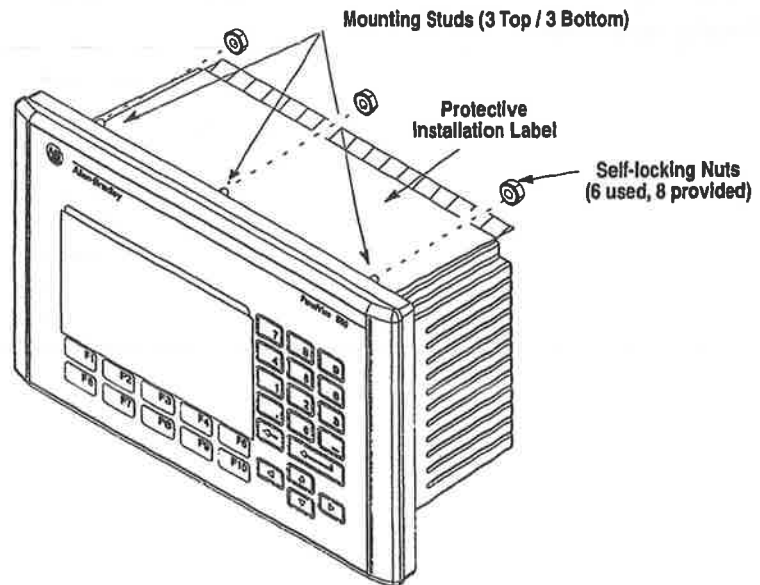
Failure to follow this warning may result in personal injury or damage to the panel components.

1. Cut an opening in the panel using the panel cutout. Remove sharp edges or burrs.
2. Make sure the terminal sealing gasket is properly positioned on the terminal. This gasket forms a compression type seal. Do not use sealing compounds.



3. Check that the ends of the legend strips are secured to the legend strip adhesive.
4. Place the terminal in the panel cutout.
5. Verify that the opening is the proper size to clear the bezel and to allow the gasket to contact the panel.
6. Make sure the ends of the legend inserts are positioned behind the panel cutout.

7. Install the 6 self-locking nuts, hand tight.



8. Alternately tighten the self-locking nuts until the terminal is held firmly against the panel. Tighten nuts to a torque of 10 inch-pounds. Do not over-tighten nuts.



ATTENTION: Mounting nuts must be tightened to a torque of 10 inch-pounds to provide a proper seal and to prevent potential damage to the terminal. Allen-Bradley assumes no responsibility for water or chemical damage to the terminal or other equipment within the enclosure because of improper installation.

9. Remove the protective installation label covering the top vents of the terminal.



ATTENTION: Failure to remove the protective installation label covering the top vents could result in overheating and damage to the terminal.

Installing the PV900 Terminal

Chapter Objectives

This chapter describes how to mount the PV900 monochrome and color terminals in a panel or enclosure

- hazardous locations
- enclosures
- required tools
- mounting dimensions
- clearances
- cutout dimensions
- installing the PV900 in a panel

Hazardous Locations

The following PanelView 900 terminals are certified for Class I Division 2 Hazardous Locations.

- PanelView 900 monochrome terminals, Series C or higher
- PanelView 900 color terminals, Series A or higher



ATTENTION: In Class I, Division 2 Hazardous locations, the PanelView 900 terminal must be wired per the National Electric Code and/or Canadian Electric Code as it applies to hazardous locations.

These terminals have an operating temperature code of T4 (maximum operating temperature is 135°C or 275°F). Install the terminals in environments where atmospheric gases **do not** have ignition temperatures less than 135°C(275°F).

Enclosures

The PV900 terminal must be mounted in an environment that provides IEC-1131-2 Pollution degree 2 protection.

Mount the PV900 terminal in a panel or enclosure to protect the internal circuitry. The terminal meets NEMA Type 12/13 and 4X (indoor use) ratings only when mounted in a panel or enclosure with the equivalent rating.

Allow enough space within the enclosure for adequate ventilation. Consider heat produced by other devices in the enclosure. The ambient temperature around the terminals must be:

- 0° and 50°C (32° and 122°F) for PV900 monochrome terminals
- 0° and 55°C (32° and 131°F) for PV900 color terminals

Make provisions for accessing the back panel of the terminal for wiring, routine maintenance, installing a memory card, and troubleshooting.

Required Tools

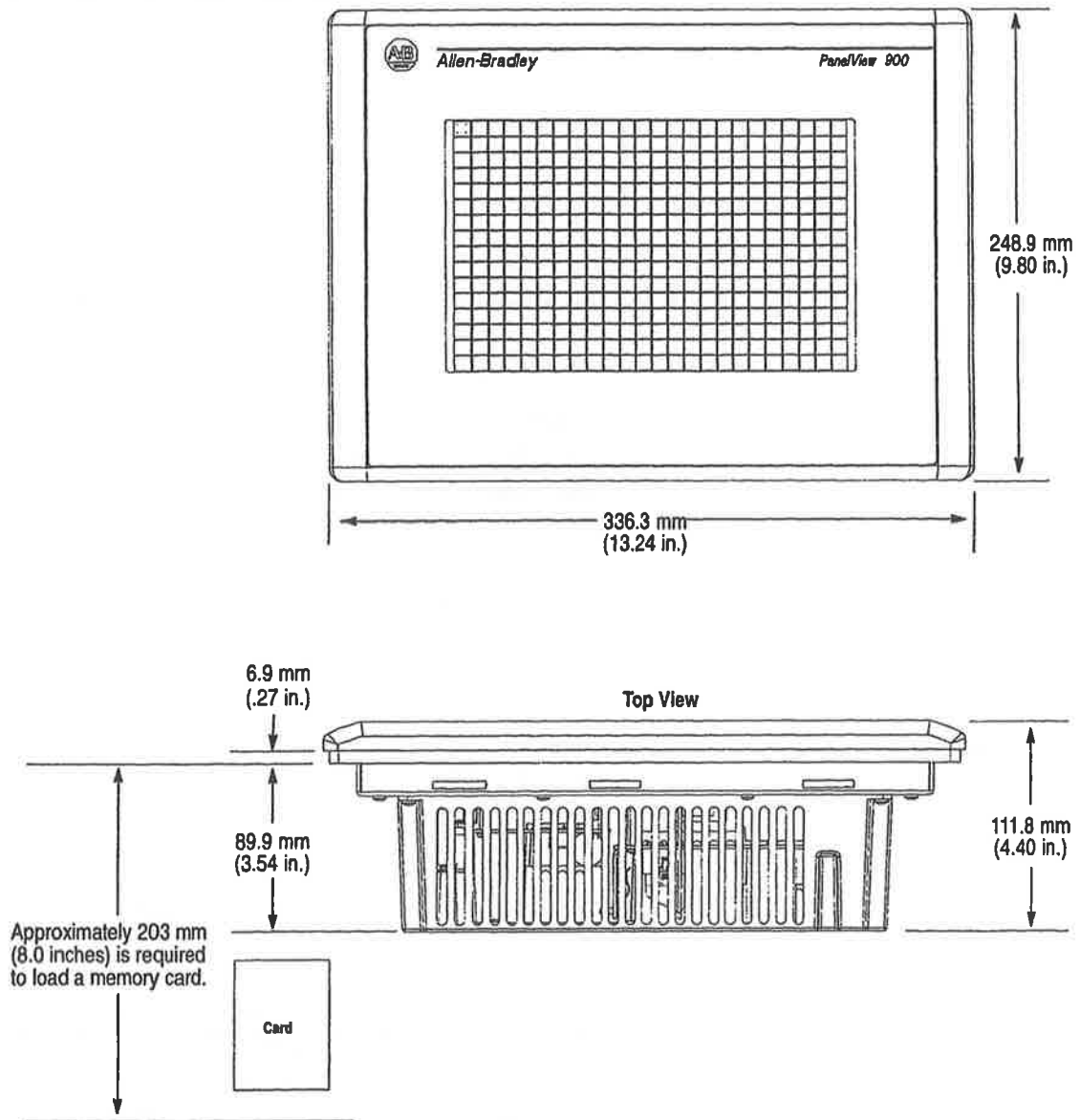
Other than the tools required to make the panel cutout, the tools required for PV900 installation are:

- small slotted screwdriver
- torque wrench (in. / lbs) with slotted or phillips head driver

Mounting Dimensions

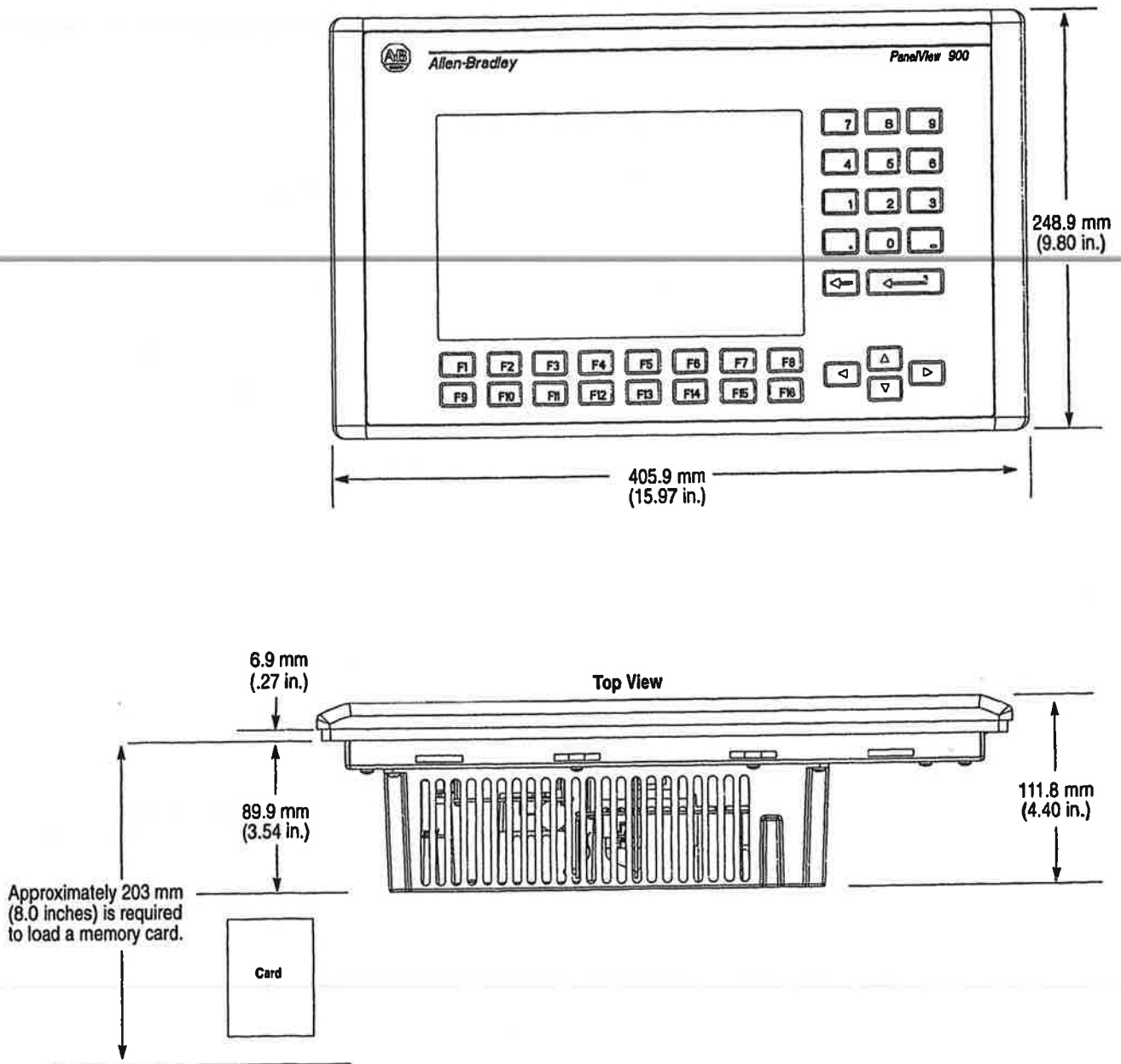
Figures 7.1 and 7.2 shows mounting dimensions for the PV900 monochrome and color terminals.

Figure 7.1
PV900 Touch Terminal Mounting Dimensions



Note: For PanelView 900 Color Terminals, add 2 mm (.08 inches) to the depth dimensions

Figure 7.2
PV900 Keypad Terminal Mounting Dimensions



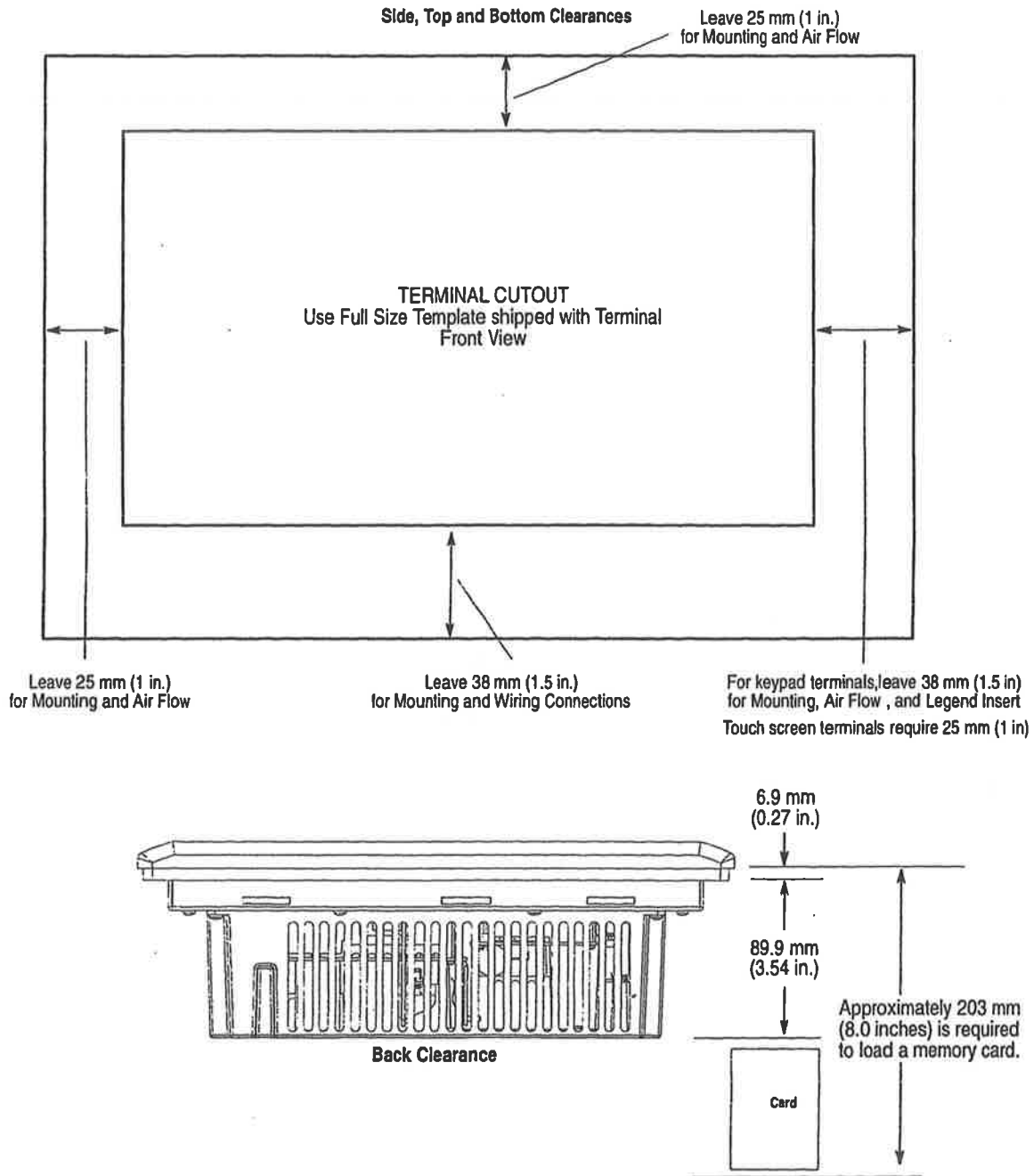
Note: For PanelView 900 Color Terminals, add 2 mm (.08 inches) to the depth dimensions

Clearances

Allow adequate space for mounting, air flow, maintenance, memory card and legend strip installation. See Figure 7.3.

Important: If using a memory card, allow a back clearance to load the card.

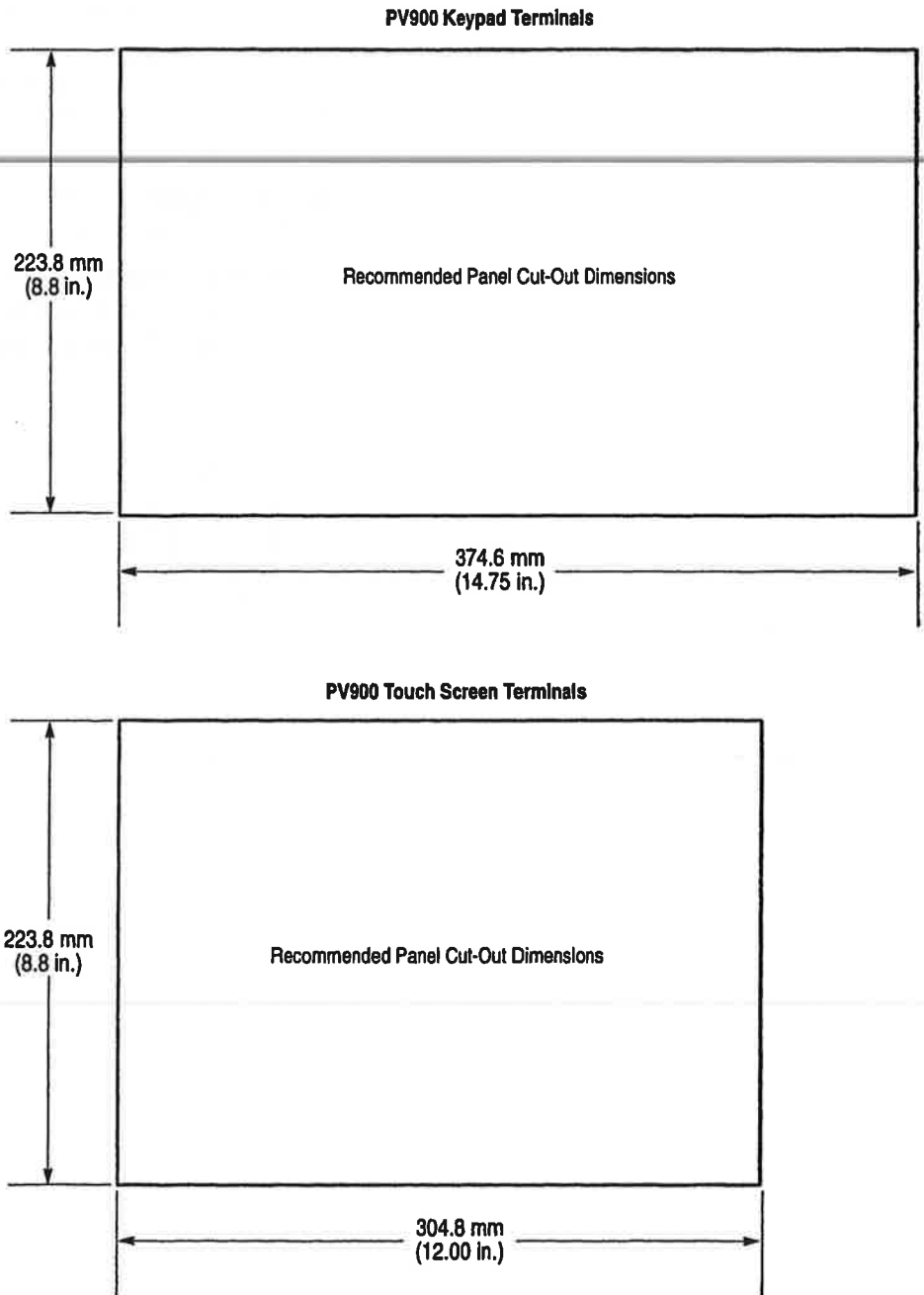
Figure 7.3
PV900 Mounting Clearances



Cutout Dimensions

Use the full size templates provided with the terminal to mark the cutout dimensions. Figure 7.4 provides reduced size versions of the cutouts with dimensions.

Figure 7.4
PV900 Panel Cutout Dimensions



Installing the PV900 in a Panel

To install the PV900 monochrome or color terminal in a panel:



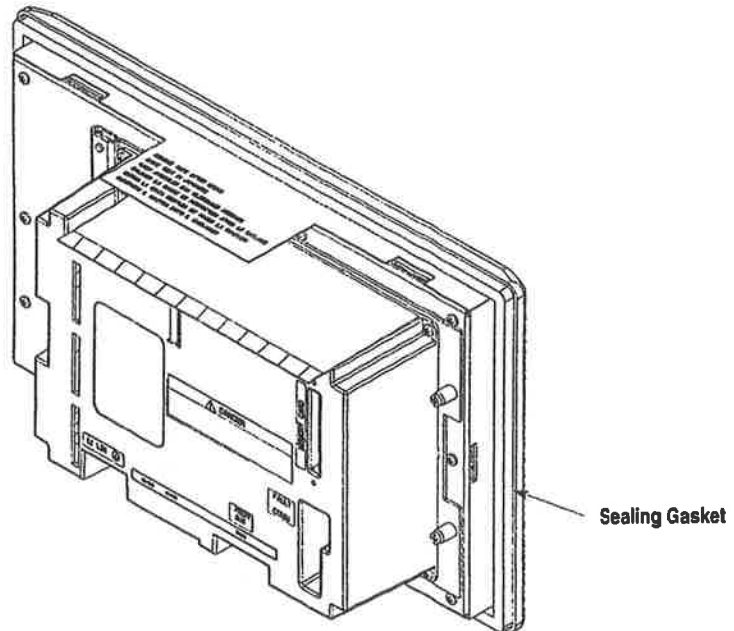
ATTENTION: Disconnect all electrical power from the panel before making cutout.

Make sure the area around the panel cutout is clear.

Take precautions so that metal cuttings do not enter any components that may already be installed in panel.

Failure to follow this warning may result in personal injury or damage to the panel components.

1. Cut an opening in the panel using the panel cutout provided with the terminal. Remove any sharp edges or burrs.
2. Make sure the terminal sealing gasket is properly positioned on the terminal as shown below. This gasket forms a compression type seal. Do not use sealing compounds.



3. Although the keypad legend strip can be installed at any time, we recommend that you install it after the terminal is installed.
4. Place the terminal in the panel cutout.

DH-485 Terminal Connections

Chapter Objectives

This chapter describes connections for the DH-485 versions of the PV550 and PV900 (monochrome and color) terminals.

- wiring and safety guidelines
- DH-485 connectors
- connecting to a single SLC
- connecting to a DH-485 network
- connecting to a hand-held terminal
- connecting a computer
- connecting a printer

Wiring and Safety Guidelines

Use publication NFPA 70E, Electrical Safety Requirements for Employee Workplaces when wiring the PV550 and PV900 terminals. In addition to the NFPA general guidelines:

- route communication cables to the terminals by a separate path from incoming power.



ATTENTION: Do not run signal wiring and power wiring in the same conduit.

- where power and communication lines must cross, they should cross at right angles. Communication lines can be installed in the same conduit as low level DC I/O lines (less than 10 volts).

DH-485 Connectors

The DH-485 versions of the PanelView 550 and 900 (monochrome and color) terminals are available with either two DH-485 ports or two DH-485 ports and one RS-232 printer port.

The A2 versions (2711-B5A2, -K5A2, -T9A2, -K9A2) of the DH-485 terminals have two DH-485 ports.

- **DH-485 Communications Port**

Use to communicate with single or multiple SLC controllers over a DH-485 network.

- **DH-485 SLC Programming Connector**

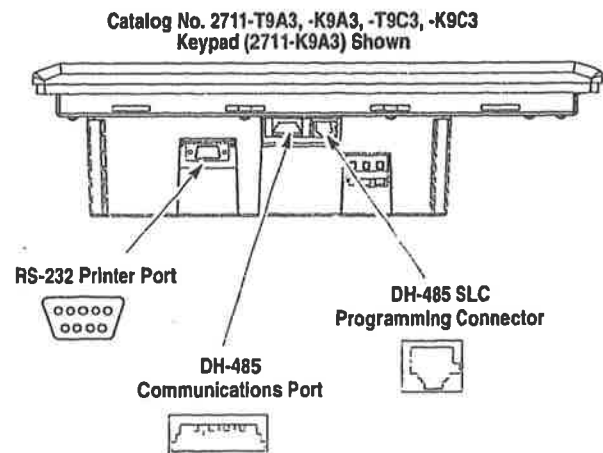
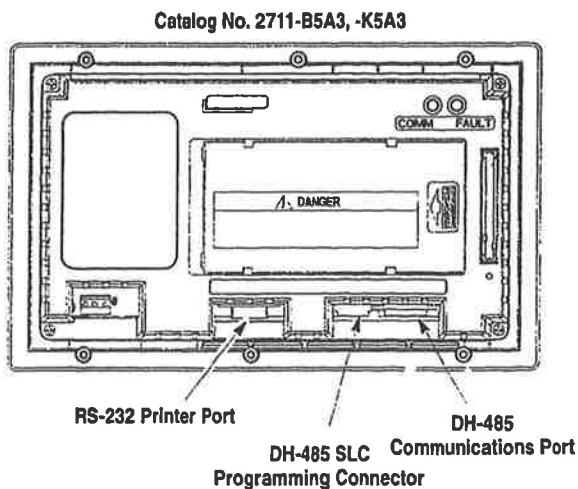
Use to upload / download applications with a computer through a Personal Computer Interface Converter Kit (Catalog No. 1747-PIC). Also connects an SLC programming device such as Hand-Held Terminal (Catalog No. 1747-PT1).

Both connectors are daisy chained together, the difference is in the connector types.

The A3 and C3 versions (2711-B5A3, -K5A3, -T9A3, -K9A3, -T9C3, -K9C3) of the DH-485 terminals have two DH-485 ports and one RS-232 printer port.

- **RS-232 Printer Port**

Use to connect a printer to the terminal.

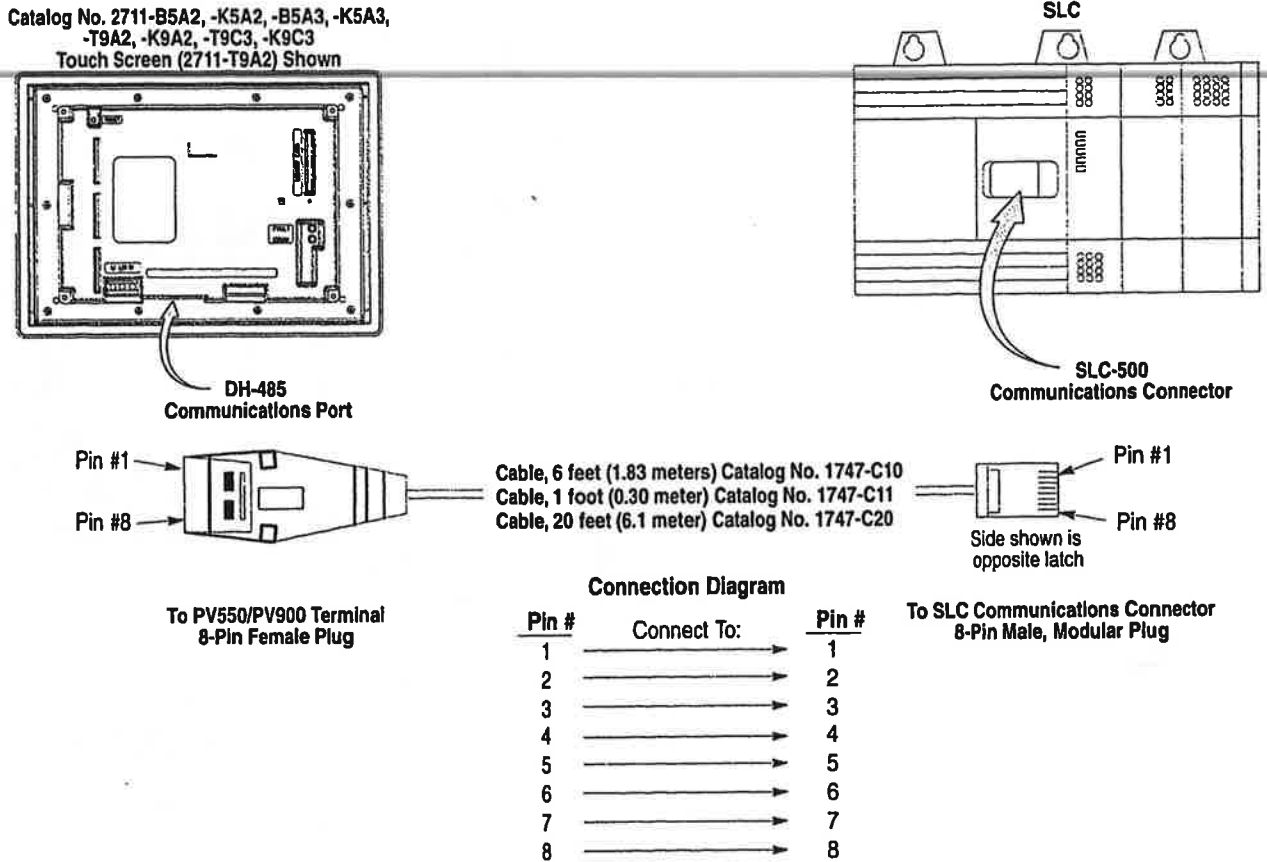


Connecting to Single SLC (Point-to-Point)

If connecting the terminal to a single SLC use one of these cables:

- 1 foot (0.30 meter) Catalog No. 1747-C11
- 6 foot (1.83 meter) Catalog No. 1747-C10
- 20 foot (6.1 meter) Catalog No. 1747-C20

Figure 8.1
DH-485 Connection to SLC (Point-to-Point)



The DH-485 connectors are not electrically isolated. If electrical isolation is required, use Link Couplers (Catalog No. 1747-AIC) shown in Figure 8.2.

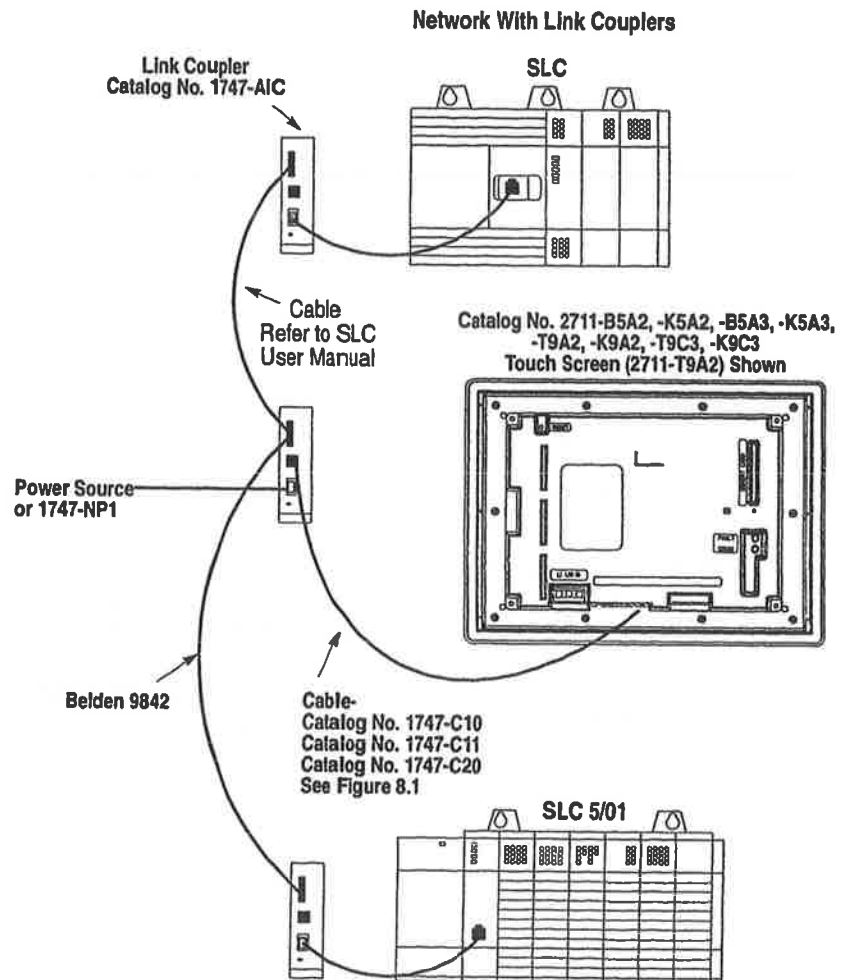


ATTENTION: Electrical isolation using Link Couplers (Catalog No. 1747-AIC) is required where the distance between the PV550/PV900 terminal and the SLC is greater than 20 feet (6.1 meters).

Connecting to DH-485 Network

Figure 8.2 shows how to connect the terminal to multiple SLC controllers over a DH-485 network.

Figure 8.2
DH-485 Connections to an SLC Network



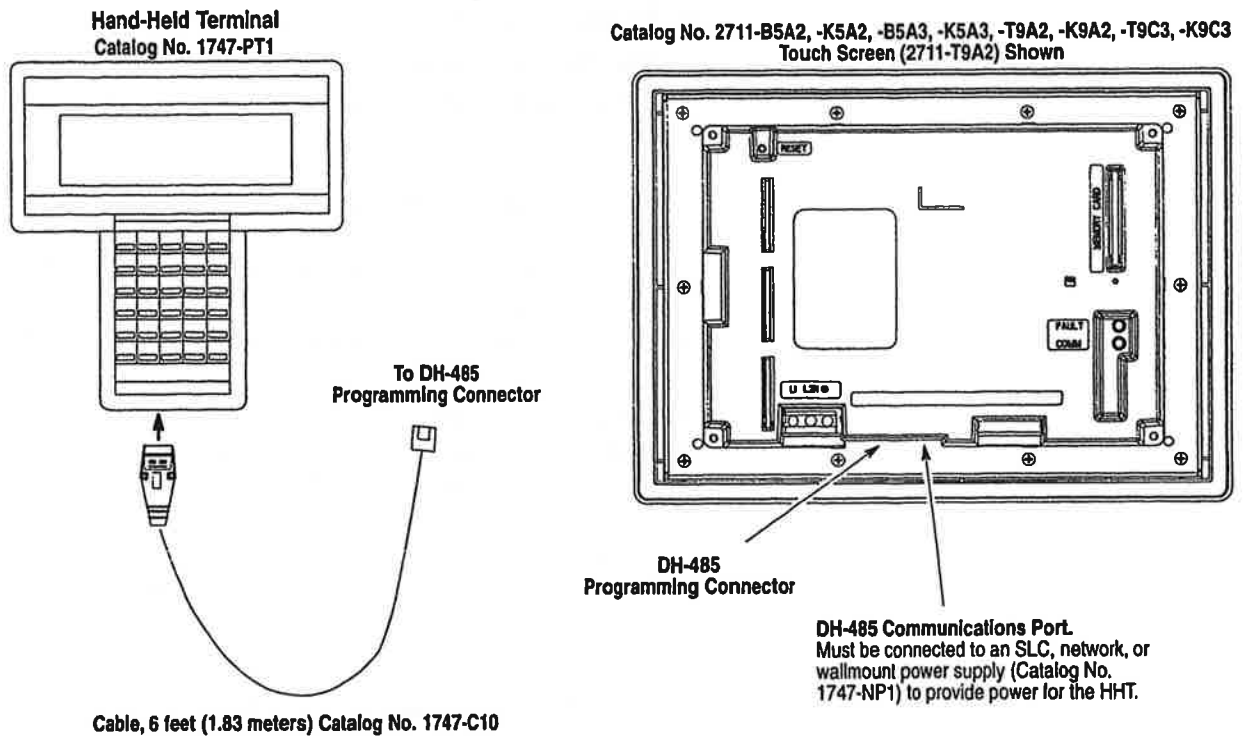
Important: The DH-485 network cable requires proper shielding, grounding, and termination. Refer to Data Highway / Data Highway Plus / Data Highway-485 Cable Installation Manual (Publication No. 1770-6.2.2).

Connecting a Hand-Held Terminal

To connect a Hand-Held terminal (HHT) to the PV550 or PV900 terminal, use cable (Catalog No. 1747-C10). One end of the cable connects to the HHT connector and the other end connects to the DH-485 programming connector on the terminal. All power is supplied to the HHT through the cable.

Important: The PV550/PV900 terminal must be connected to an SLC, DH-485 network, or power supply. This connection provides power for the HHT. See Figure 8.4.

Figure 8.3
DH-485 Connection to Hand-Held Terminal



Connecting a Computer

On DH-485 terminals, PanelView applications are transferred:

- through the DH-485 programming connector directly to the PV550/PV900 terminal.
- through any node on a DH-485 network.

To connect a computer to the PV550/PV900 terminal, use:

- one of these cables (same cables used to transfer applications from APS Software to an SLC)
 - 1 foot (0.30 meter) Catalog No. 1747-C11
 - 6 feet (1.83 meters) Catalog No. 1747-C10
 - 20 feet (6.1 meters) Catalog No. 1747-C20
- Personal Computer Interface Converter (Catalog No. 1747-PIC)

The PIC connects to the computer. The cable connects the PIC to the DH-485 programming connector.

Interface Converter Operation

The Personal Computer Interface Converter (Catalog No. 1747-PIC) receives power from a controller through the DH-485 connections. When connecting a personal computer directly to a PV550/PV900 terminal without a controller connected, you need a power supply (Catalog No. 1747-NP1). The power supply connects to the DH-485 communications connector with the same cables used to connect an SLC (see Figure 8.4).

Important: The terminal must be connected to an SLC, DH-485 network, or power supply (Catalog No. 1747-NP1). This connection provides power for the PIC.

Connecting Earth Ground on PV900 Color Terminals

When using the 1747-PIC converter with the PV900 color terminals, you must connect the Earth Ground terminal on the back of the color terminal to Earth Ground.

Connect the Earth Ground terminal using 14 Gauge stranded wire no longer than 1 meter (40 inches).

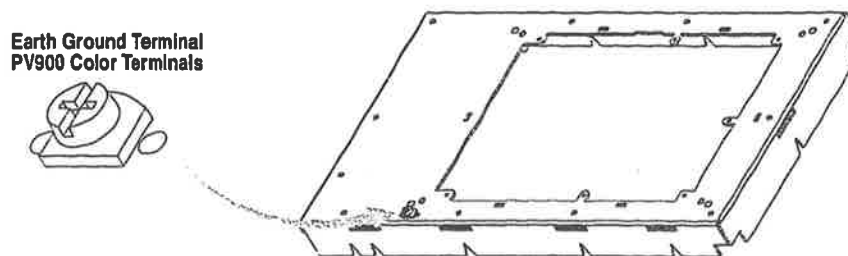


Figure 8.4
Connecting a Computer to DH-485 Connector
Using a Power Supply

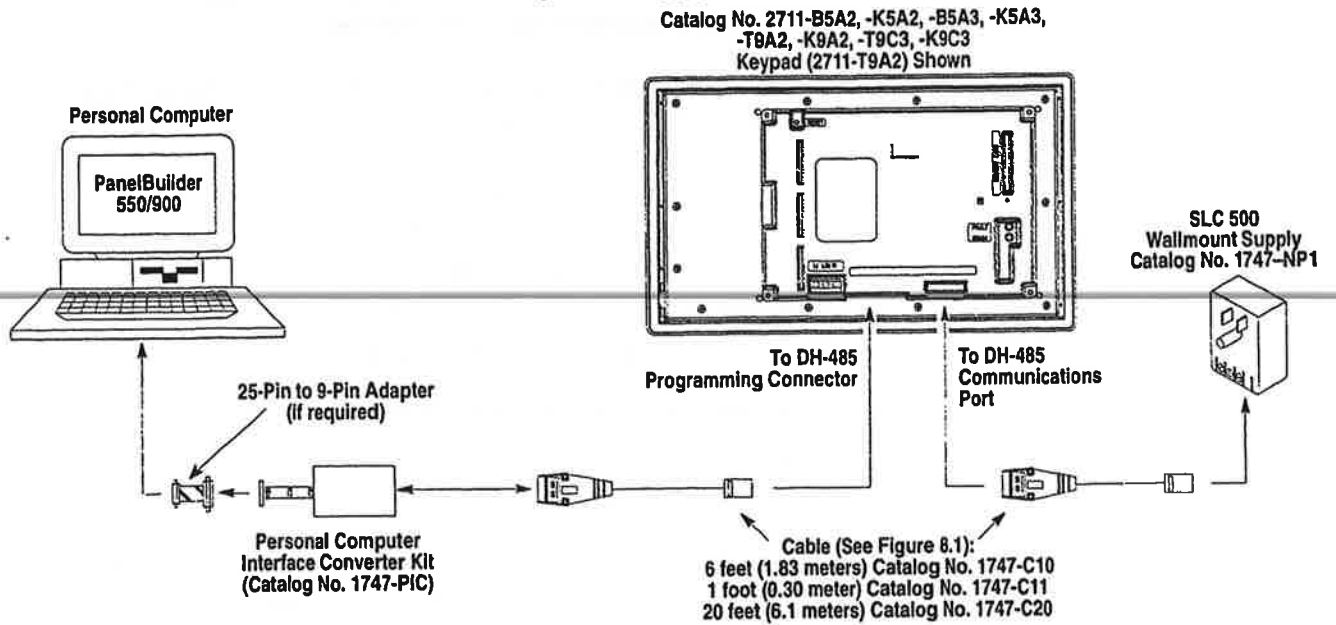
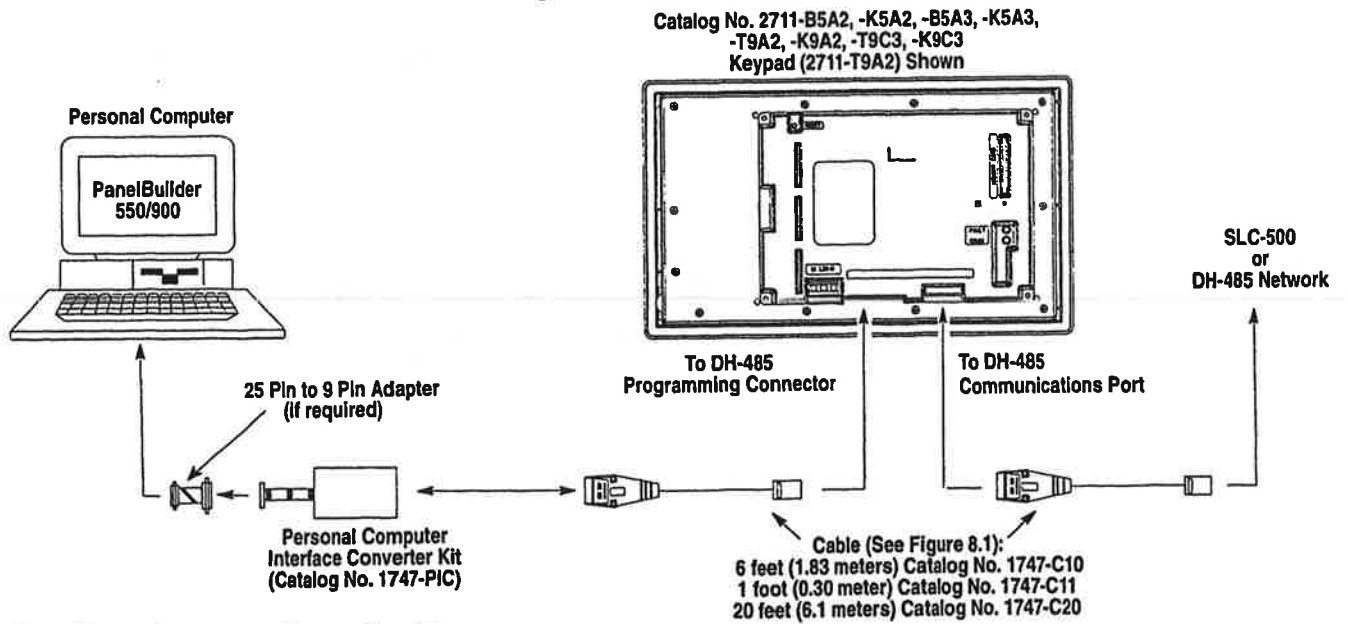


Figure 8.5
Connecting a Computer to DH-485 Connector
Using a DH-485 Powered Device



Note: The computer can connect to any node on the network. It is not necessary to directly connect the computer to the PV550 or PV900 terminal.

Connecting a Printer

The A3 and C3 versions of the (2711-B5A3, -K5A3, -T9A3, -K9A3, -T9C3, -K9C3) of the DH-485 terminals have an RS-232 printer port. Use this port to connect a printer that supports the IBM enhanced character set to the terminal.

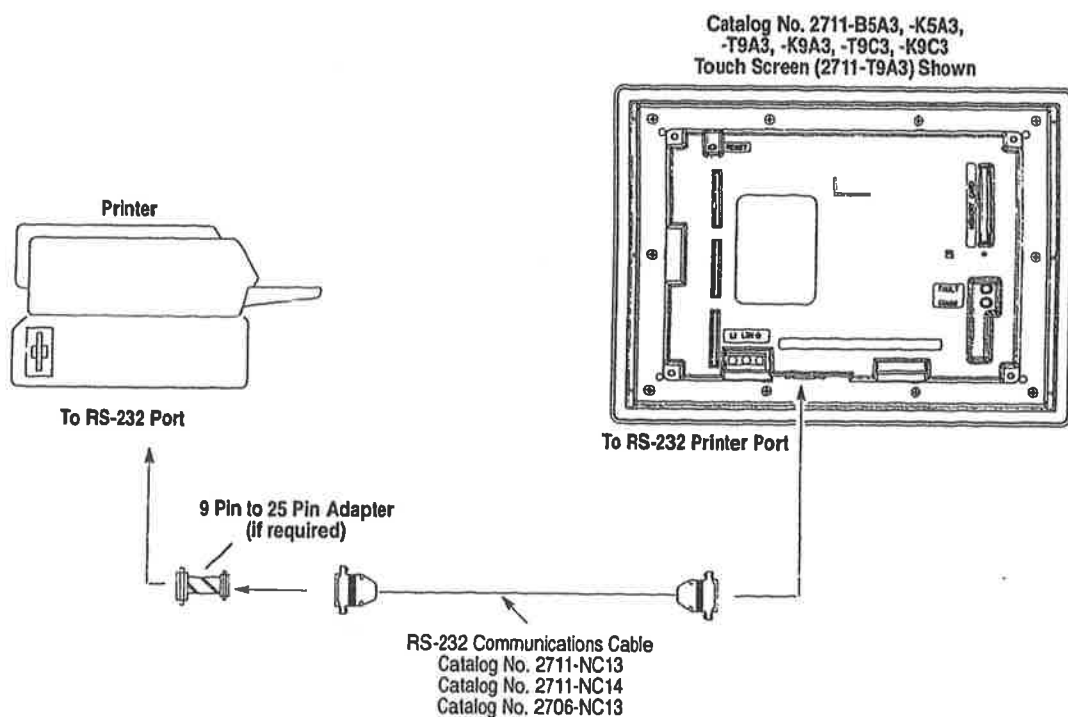
Communication parameters for the RS-232 printer port are set on Printer Setup Screen of the Configuration Mode menu.

To connect a printer to the RS-232 printer port of the the A3 or C3 terminals, use one of these cables:

- 16.4 foot (5 meter) Catalog No. 2711-NC13
- 32.7 foot (10 meter) Catalog No. 2711-NC14
- 10 foot (3 meter) Catalog No. 2706-NC13

Figure 8.6 shows the printer connection.

Figure 8.6
Connecting a Printer to a DH-485 Terminal



RS-232 Terminal Connections

Chapter Objectives

This chapter describes connections for the RS-232 versions of the PV550 and PV900 (monochrome and color) terminals.

- wiring and safety guidelines
- RS-232 ports
- connecting to a SLC 5/03, 5/04 (Point-to-Point)
- connecting a computer
- connecting to a DH Plus network
- connecting a printer

Wiring and Safety Guidelines

Use publication NFPA 70E, Electrical Safety Requirements for Employee Workplaces when wiring the PV550 and PV900 terminals. In addition to the NFPA general guidelines:

- route communication cables to the terminals by a separate path from incoming power.



ATTENTION: Do not run signal wiring and power wiring in the same conduit.

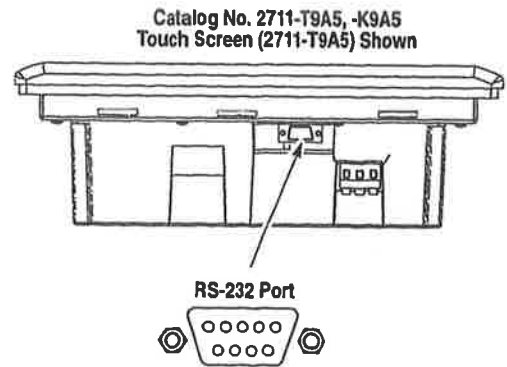
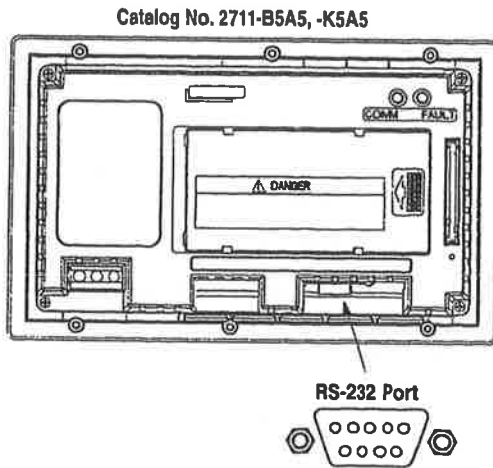
- where power and communication lines must cross, they should cross at right angles. Communication lines can be installed in the same conduit as low level DC I/O lines (less than 10 volts).
- grounding minimizes noise from Electromagnetic Interference (EMI) and is a safety measure in electrical installations. To avoid EMI, shield and ground cable at one end.
- use the National Electric Code published by the National Fire Protection Association of Boston as a source for grounding.

RS-232 Ports

The RS-232 versions of the PV550 and PV900 (monochrome and color) terminals are available with either one or two RS-232 ports.

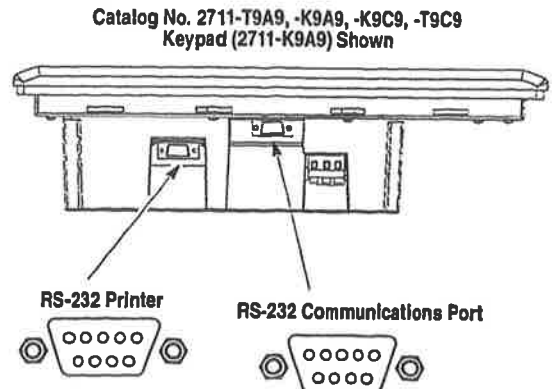
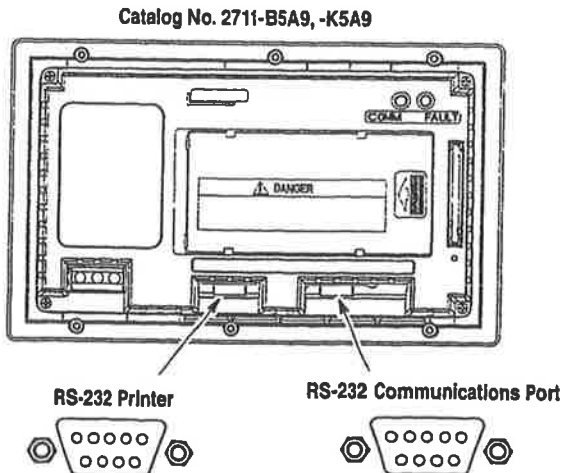
The A5 versions (2711-B5A5, -K5A5, -T9A5, -K9A5) of the RS-232 terminals have one RS-232 port. This single port:

- **Communicates with a single SLC 5/03, 5/04 Controller**
The RS-232 port connects to the Channel 0 port of an SLC 5/03, 5/04 controller for point-to-point communications.
- **Uploads/Downloads Applications**
Applications are transferred between the RS-232 port of the terminal and the RS-232 port of a computer.



The A9 and C9 versions (2711-B5A9, -K5A9, -T9A9, -K9A9, -T9C9, -K9C9) of the RS-232 terminals have two RS-232 ports.

- **RS-232 Communications Port** communicates with a single SLC 5/03 or 5/04 controller (Channel 0 Port)
- **RS-232 Printer Port** connects to any printer that supports the IBM enhanced character set.



Connecting to SLC 5/03, 5/04 (Point-to-Point)

Figure 9.1 shows how to connect an SLC 5/03, 5/04 controller to the RS-232 versions of the PV550/PV900 terminals for point-to-point communications.

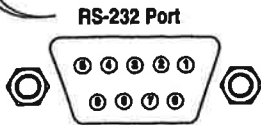
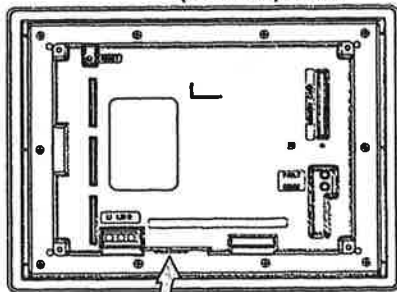
- On A5 versions of the RS-232 terminals, use the single RS-232 Communications port.
- On A9 and C9 versions of the RS-232 terminals, use the RS-232 Communications port.

Use one of these cables:

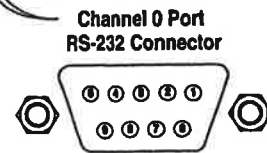
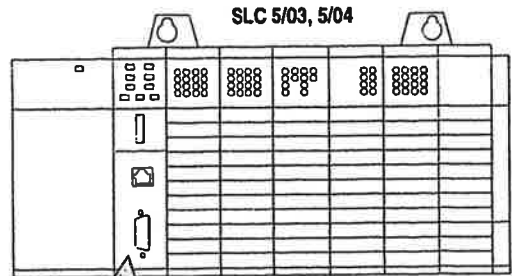
- 16.4 foot (5 meter) Catalog No. 2711-NC13
- 32.7 foot (10 meter) Catalog No. 2711-NC14
- 10 foot (3 meter) Catalog No. 2706-NC13

Figure 9.1
RS-232 Connection to SLC 5/03, -5/04 (Point-to-Point)

Catalog No. 2711-K5A5, -B5A5, -T9A5, -K9A5, -K5A9, -B5A9, -T9A9, -K9A9, -T9C9, K9C9
Touch Screen (2711-T9A5) Shown



To PanelView 900 Terminal
9 Pin Male D-Shell Connector



To SLC 5/03, 5/04 Channel 0 Port
9 Pin Male D-Shell Connector

Cable, Catalog No. 2711-NC13
Cable, Catalog No. 2711-NC14
Cable, Catalog No. 2706-NC13

Connection Diagram

Pin #	Connect To:	Pin #
1		1
2 Data Out (TXD)	→	2 Data In (RXD)
3 Data In (RXD)	→	3 Data Out (TXD)
4		4
5 Signal Common	→	5 Signal Common
6		6
7		7
8		8
9		9

Important: You must configure the Channel 0 Port of the SLC 5/03, 5/04 controller for DH485 communications using the APS (Advanced Programming Software) software.

Connecting a Computer

Figure 9.2 shows how to connect a computer to the RS-232 versions of the PV550/PV900 terminals for transferring applications.

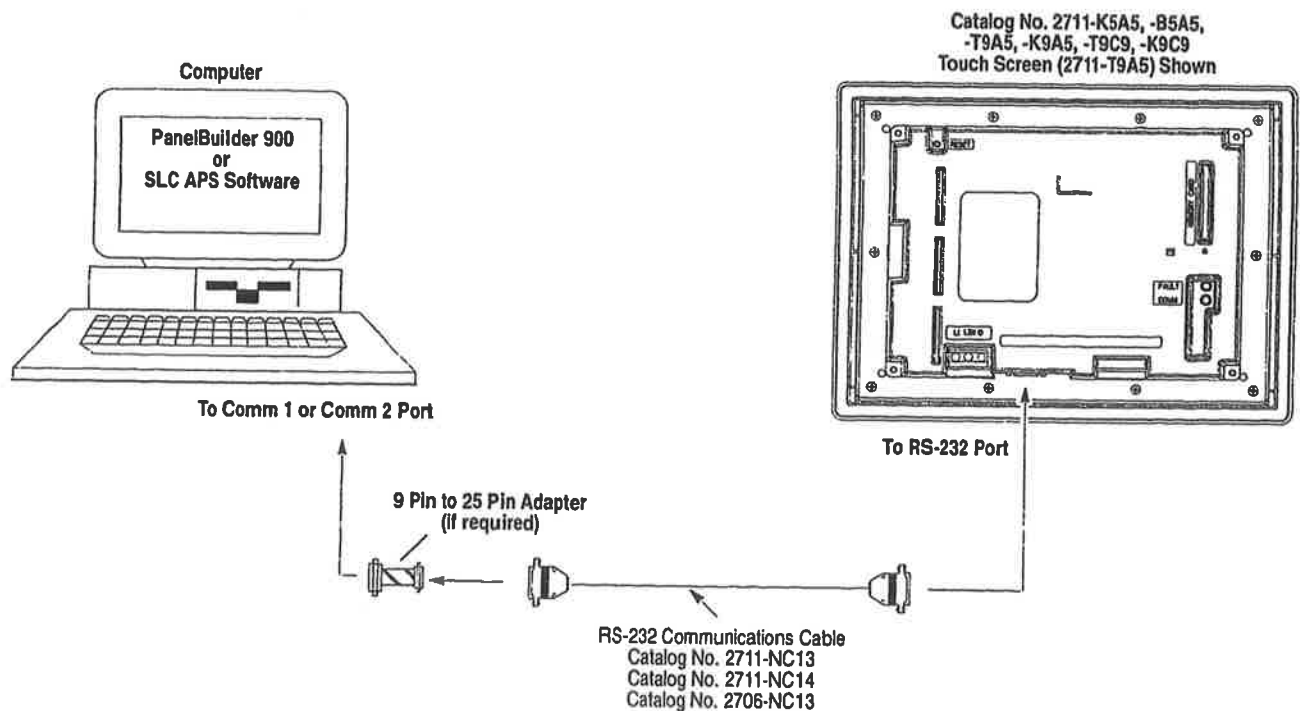
- On A5 versions of the RS-232 terminals, use the single RS-232 Communications port to transfer applications.
- On A9 and C9 versions of the RS-232 terminals, use the RS-232 Communications port to transfer applications.

The same cables are used to connect a computer to both versions of the RS-232 terminals.

- 16.4 foot (5 meter) Catalog No. 2711-NC13
- 32.7 foot (10 meter) Catalog No. 2711-NC14
- 10 foot (3 meter) Catalog No. 2706-NC13

▶ For details on transferring applications between a computer and the PV550/PV900 terminal, see the PanelBuilder 550/900 Configuration Software manual (Publication 2711-6.0).

Figure 9.2
Connecting Computer to an RS-232 Terminal



Connecting to a DH Plus Network

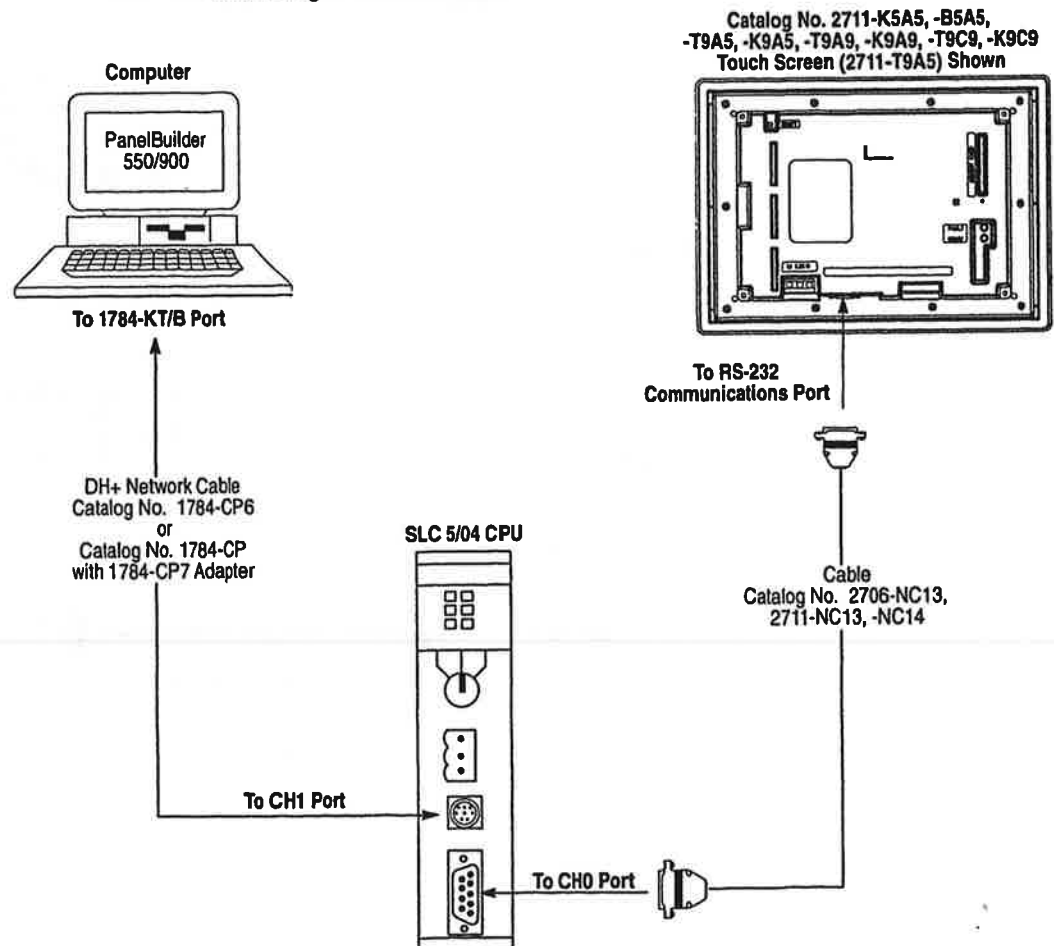
Figure 9.3 shows connections for transferring applications between a computer on the Allen-Bradley DH+ network to the RS-232 versions of the PV550/PV900 terminal, through an SLC 5/04 controller.

- On A5 versions of the RS-232 terminals, the single RS-232 Communications port connects to the CH0 Port of the controller.
- On A9 and C9 versions of the RS-232 terminals, the RS-232 Communications Port connects to the CH0 Port of the controller.

The same cables are used to connect both versions of the RS-232 terminals to the CH0 Port of the controller.

▶ For details on transferring applications between a computer and the PV550/PV900 terminal, see the PanelBuilder 550/900 Configuration Software manual (Publication 2711-6.0).

Figure 9.3
Connecting to a DH+ Network



Connecting a Printer

The A9 and C9 (2711-B5A9, -K5A9, -T9A9, -K9A9, -T9C9, -K9C9) versions of the RS-232 terminals have a separate RS-232 printer port. Use this port to connect any printer that supports the IBM enhanced character set.

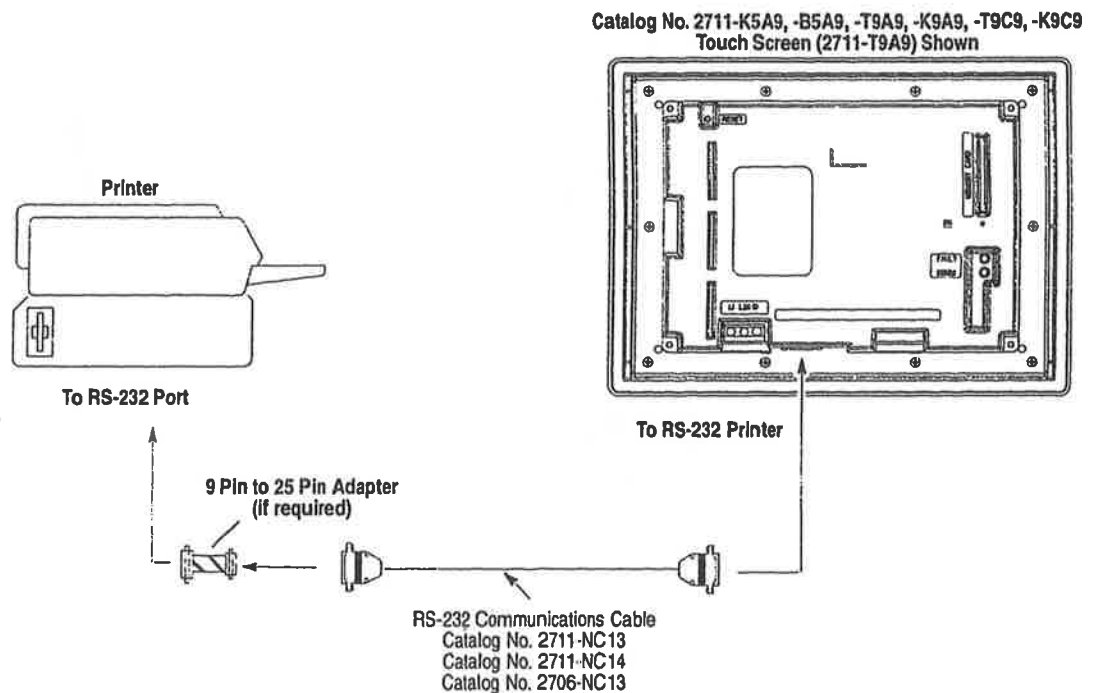
Communication parameters for the RS-232 printer port are set on Printer Setup Screen of the Configuration Mode menu.

To connect a printer to the RS-232 Printer port of the the A9 and C9 terminals, use of these cables:

- 16.4 foot (5 meter) Catalog No. 2711-NC13
- 32.7 foot (10 meter) Catalog No. 2711-NC14
- 10 foot (3 meter) Catalog No. 2706-NC13

Figure 9.4 shows the printer connection.

Figure 9.4
Connecting a Printer to an RS-232 Terminal



Remote I/O Terminal Connections

Chapter Objectives

This chapter describes connections for the Remote I/O versions of the PV550 and PV900 (monochrome or color) terminals.

- wiring and safety guidelines
- Remote I/O port
- supported controllers
- connecting to a Remote I/O port
- connecting a computer
- connecting a printer
- Remote I/O Pass-Through

Wiring and Safety Guidelines

Use publication NFPA 70E, Electrical Safety Requirements for Employee Workplaces when wiring the PV550 and PV900 terminals. In addition to the NFPA general guidelines:

- route communication cables to the terminals by a separate path from incoming power.



ATTENTION: Do not run signal wiring and power wiring in the same conduit.

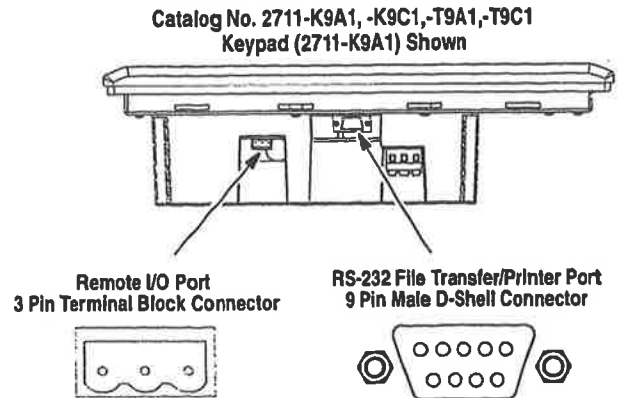
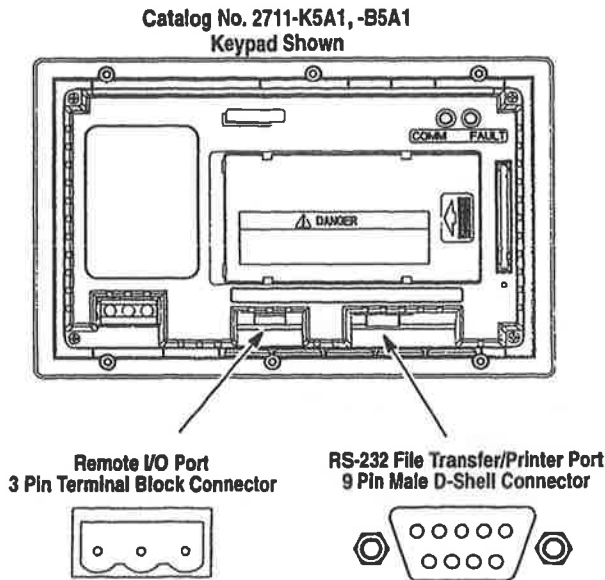
- where power and communication lines must cross, they should cross at right angles. Communication lines can be installed in the same conduit as low level DC I/O lines (less than 10 volts).
- grounding minimizes noise from Electromagnetic Interference (EMI) and is a safety measure in electrical installations. To avoid EMI, shield and ground cables at both ends.
- use the National Electric Code published by the National Fire Protection Association of Boston as a source for grounding.

Remote I/O Port

The Remote I/O versions (Catalog No. 2711-B5A1, -K5A1, -T9A1, -K9A1, -T9C1, -K9C1) of the PanelView 550 and 900 (monochrome and color) terminals have a Remote I/O adapter and an RS-232 File Transfer/Printer Port.

- **Remote I/O Port**
Connects to a Remote I/O network.
- **RS-232 File Transfer/Printer Port**
Connects to the RS-232 port of a computer for transferring applications or connects to a printer.

Remote I/O versions also support Pass-Through for the transfer of applications over a Remote connection.



Supported Controllers

The Remote I/O terminal connects to any Allen-Bradley 1771 Remote I/O link. Applicable host controllers include almost all Allen-Bradley PLCs, personal computers, VME Controllers, and DEC Q-Bus controllers with a remote I/O scanner module. New PLC product releases that support 1771 remote I/O will also work with the PanelView.

When connecting a PV550 or PV900 to a controller, refer to the user manual for the controller or scanner module for connection diagrams and any Remote I/O limitations. The following is a summary of the possible connections.

Controller	Subscanner	Comments
PLC-5/11, 5/15 ^① , 5/20, 5/25, 5/30, 5/40, 5/60, 5/250	PLC Integral 1771-SN	Connect PanelView terminals directly to the Remote I/O port (scanner mode). Connect PanelView terminals through the 1771-SN Subscanner Module.
PLC-5/10, 5/12	1771-SN	Connect PanelView terminals through the 1771-SN Subscanner Module.
PLC-2	1771-SN or 1772-SD2 ^②	Connect PanelView terminals to the PLC-2 family of processors through a 1771-SN I/O Subscanner Module.
PLC-3 and PLC-3/10	None PLC 3/10 Remote I/O Scanner ^③	Connect PanelView terminals directly to a PLC-3. Connect PanelView terminals to the PLC-3/10 through the Remote I/O scanner.
SLC-5/00, 5/02, 5/03, 5/04	1747-SN	Connect PanelView terminals through the 1747-SN Subscanner Module. Each Subscanner Module provides an additional Remote I/O link for up to 4 racks. Important: Only Series B and later versions of the 1747-SN subscanner support block transfers.
IBM PC	6008-SI	6008-SI I/O Scanner is compatible with IBM PC or compatible computers. The scanner provides a computer access to the 1771 Remote I/O link.
VME	6008-SV	6008-SV I/O Scanner provides access to the 1771 Remote I/O link for VME™ controllers.
DEC Q-BUS	6008-SQ	6008-SQ I/O Scanner provides access to the 1771 Remote I/O link for DEC Q-BUS™ controllers.

① If you are using a PLC-5/15 with partial rack addressing and block transfers, you must use Series B, Rev. J or later

② If using a 1775-SD2 Remote Scanner/Distribution Panel, use revision 3 or later.

③ If using a 1775-S4A Remote Scanner/Distribution Panel, use Series B or later.

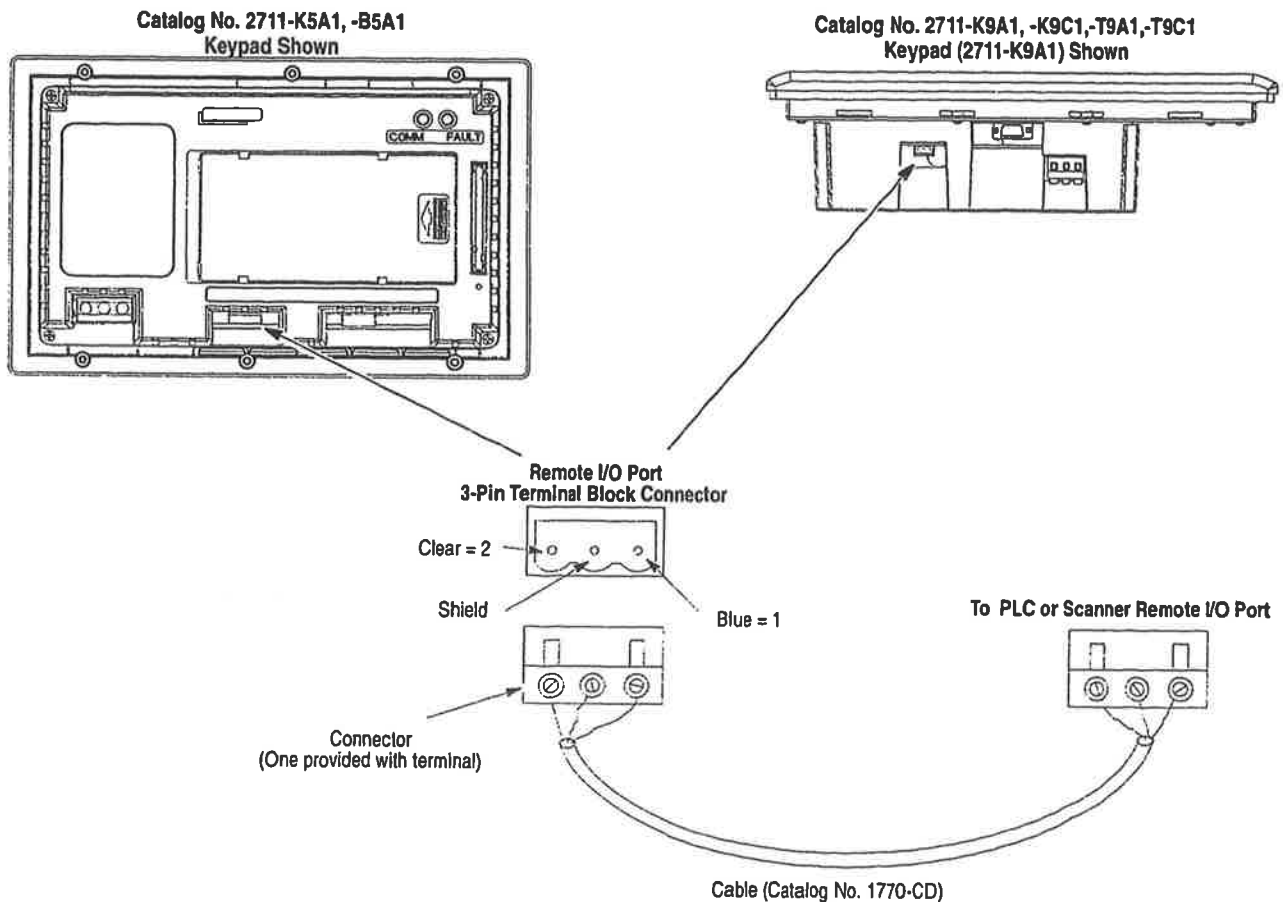
Connecting to a Remote I/O Port

To connect the PV550 or PV900 (monochrome or color) terminal to a remote I/O scanner, use cable Catalog No. 1770-CD (equivalent to Belden 9463). The maximum cable length (link distance) is determined by the baud rate:

- 10,000 feet (2,800 meters) for 57.6K baud
- 5,000 feet (1,400 meters) for 115.2K baud
- 2,500 feet (700 meters) for 230.4K baud

Refer to Programmable Controller Wiring and Grounding Guidelines (Publication No. 1770-4.1). The user manual for the I/O scanner module also provides cabling information.

Figure 10.1
Remote I/O Connections



Note: The polarity of the Remote I/O connector on the PanelView terminal is reversed from the PLC Scanner connector. However, the polarity is the same as the scanner card connection on the SLC.

A connector plug is provided with each terminal. You can order additional connector plugs (Replacement Part No. 22112-046-03).

Connecting a Computer

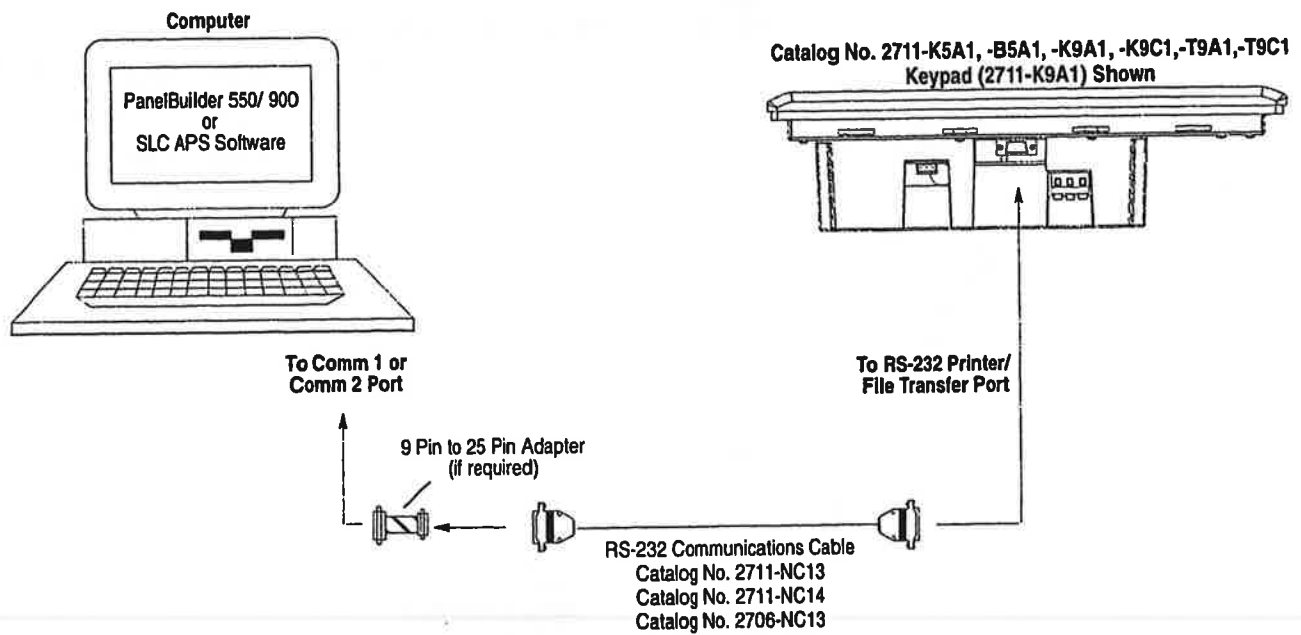
To connect a computer to the RS-232 port of a PV550 or PV900 Remote I/O (monochrome or color) terminal, use one of these cables:

- 16.4 foot (5 meter) Catalog No. 2711-NC13
- 32.7 foot (10 meter) Catalog No. 2711-NC14
- 10 foot (3 meter) Catalog No. 2706-NC13

Figure 10.2 shows the connections required for transferring PanelView applications between a computer and the RS-232 port of a Remote I/O terminal.

▶ For details on transferring applications between a computer and the PV550/PV900s terminal, see the PanelBuilder 550/900 Configuration Software manual (Publication 2711-6.0).

Figure 10.2
Connecting Computer to a Remote I/O Terminal



Connection Diagram

Pin #	Connect To:	Pin #
1	→	1
Data Out (TXD) 2	→	2 Data In (RXD)
Data In (RXD) 3	→	3 Data Out (TXD)
4	→	4
Signal Common 5	→	5 Signal Common
6		6
7		7
8		8
9		9

Connecting a Printer

All versions of the Remote I/O terminals have an RS-232 printer port which can be used to connect a printer or to download/upload applications between a computer and the terminal.

Any printer that supports the IBM enhanced character set can be connected to the RS-232 printer port.

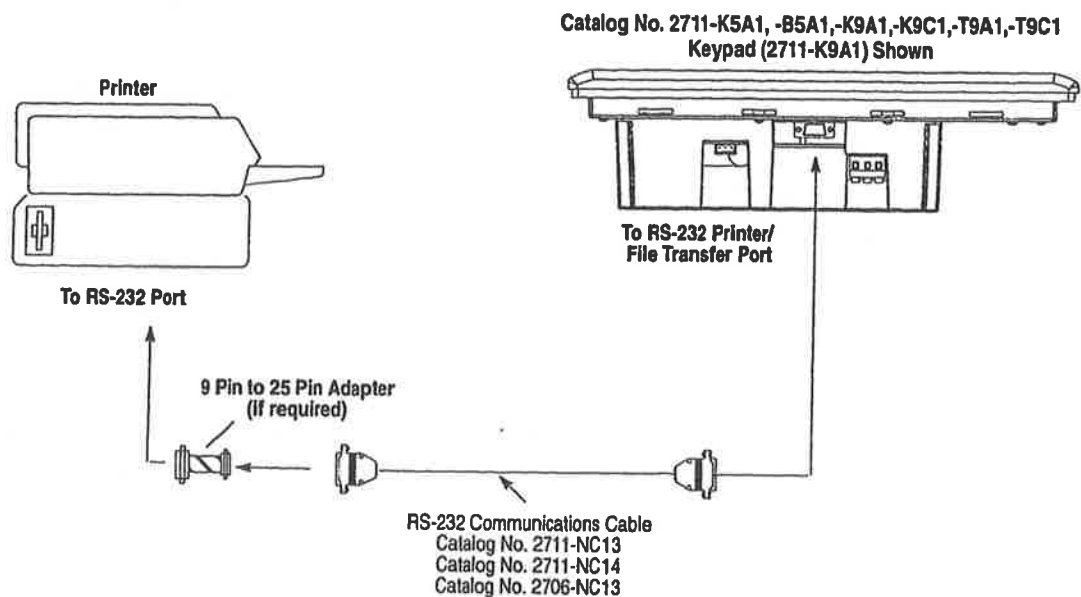
Communication parameters for the RS-232 printer port are set on Printer Setup Screen of the Configuration Mode menu.

To connect a printer to the RS-232 port of the Remote I/O terminals, use of these cables:

- 16.4 foot (5 meter) Catalog No. 2711-NC13
- 32.7 foot (10 meter) Catalog No. 2711-NC14
- 10 foot (3 meter) Catalog No. 2706-NC13

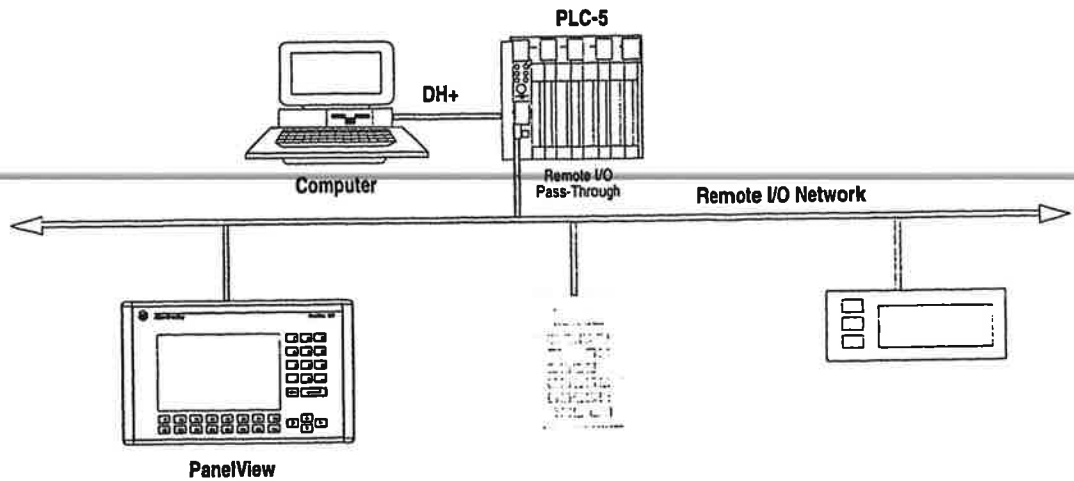
Figure 10.3 shows the printer connection.

Figure 10.3
Connecting a Printer to a Remote I/O Terminal



Remote I/O Pass-Through

Remote I/O terminals (Catalog No. 2711-B5A1, -K5A1, -T9A1, -K9A1, -T9C1, -K9C1) allow the transfer of applications from a computer on the Allen-Bradley DH Plus network to a PLC-5 controller. The controller passes the data to the PanelView terminal over the remote I/O network.



To transfer an application using Remote I/O Pass-Through:

1. A Data Highway Plus Interface Module must be installed in the computer. Allen-Bradley offers a variety of interface cards for a DH+ connection between a personal computer and a PLC.
 - Communication Interface Cards (Catalog No. 1784-KTX, -KTXD)
 - Processor Communication Interface Module (Catalog No. 1784-KT/B, -KT2)
 - PCMK Communication (PCMCIA) Card (Catalog No. 1784-PCMK)
2. The appropriate INTERCHANGE communication driver must be loaded on the computer. Drivers are configured using the INTERCHANGE Device Config. Utility (icon in PanelBuilder group) or the Workstation Setup Command (File menu).
3. Connect the personal computer to the PLC. See the instruction sheets provided with the communications module or card to select the proper cable. Connect the cable between the personal computer and the PLC.
4. Pass-Through must be enabled for the terminal. Check the RIO Configuration screen (page 3-7). Pass-Through is enabled using the out-of-box application provided with the terminal or when defining Remote I/O parameters in the PanelBuilder software.
5. Refer to the PanelBuilder 550/900 Software Manual for procedures on how to transfer applications using Pass-Through.



Troubleshooting and Maintenance

Chapter Objectives

This chapter describes how to isolate and correct common operating problems and perform routine maintenance tasks.

- equipment required
- using troubleshooting chart
- LED indicators
- cleaning the display window
- replacing the clock module
- replacing the PV550 backlight lamp
- replacing the PV900 color backlight

Equipment Required

Other than verifying that the correct power source is connected to the terminal (use a voltmeter), no electronic diagnostic equipment is required for troubleshooting.

Using the Troubleshooting Chart

Table 11.A is the terminal troubleshooting chart. This chart lists the most common operating problems, the probable causes, and steps to correct the problem.



ATTENTION: The PV550 and PV900 contain hazardous voltages. Do not insert objects or let objects fall into the terminal through the ventilation slots. Always disconnect power when checking wiring connections. Failure to take adequate precautions may result in severe electrical shock.

Troubleshooting Chart

Table 11.A
Troubleshooting Chart

Problem	Probable Cause(s)	Corrective Action(s)
Terminal does not power up.	Improper connection to power source.	Verify correct voltage at power terminals on the back of the terminal.
No communications with SLC or PLC controller.	<ol style="list-style-type: none"> 1. Communications (COMM) fault. 2. Baud rates not set properly. 3. Controller is not in run mode. 4. Terminal node and maximum node numbers are not correctly set. 5. Controller fault. 	<ol style="list-style-type: none"> 1. Check status of COMM LED, refer to section "LED Indicators". Verify cable connections using cable diagrams in Chapters 8, 9 or 10. 2. Verify that terminal and controller are set at the same baud rate. 3. Place controller in run mode. 4. Verify node number settings. 5. Refer to user manual for controller.
No communications with PLC but COMM LED is green.	The inhibit bit is set as the default on the Channel 1B Status Screen in the PLC (Channel Overview/Scanner Mode).	Change the setting of the inhibit bit.
No communications with personal computer.	<ol style="list-style-type: none"> 1. Communications (COMM) fault. 2. No SLC, network, or power supply connection at terminal's DH-485 port. 3. Baud rates not set correctly. 4. Terminal node and maximum node numbers are not set correctly. 5. Computer fault. 6. INTERCHANGE driver not properly loaded. 	<ol style="list-style-type: none"> 1. Check status of COMM LED, refer to section "LED Indicators". Verify cable connections using cable diagrams in Chapters 8, 9 or 10. 2. Personal Computer Interface Converter (PIC) receives power from DH-485 connection. Verify that the terminal is connected to an SLC, network, or wallmount power supply as shown on page 8-7. 3. Verify that terminal and computer are set at the same baud rate. 4. Verify node number settings. 5. Refer to computer user manual. 6. Refer to the PanelBuilder 550/900 manual (Publication 2711-6.0).
Clock module Battery Low message is displayed.	<ol style="list-style-type: none"> 1. Clock module needs replacement. 	<ol style="list-style-type: none"> 1. Replace clock module as described in instructions with clock module kit.
Cannot transfer application from memory card.	<ol style="list-style-type: none"> 1. Memory card is not properly installed. 2. Application is too large for terminal memory. 3. Data checksum is incorrect. 4. Invalid file format. 	<ol style="list-style-type: none"> 1. Verify correct installation. 2. Reduce size of application file. 3. Check for loose memory card. Application may be corrupted. 4. Verify file format (.PVA) being transferred.

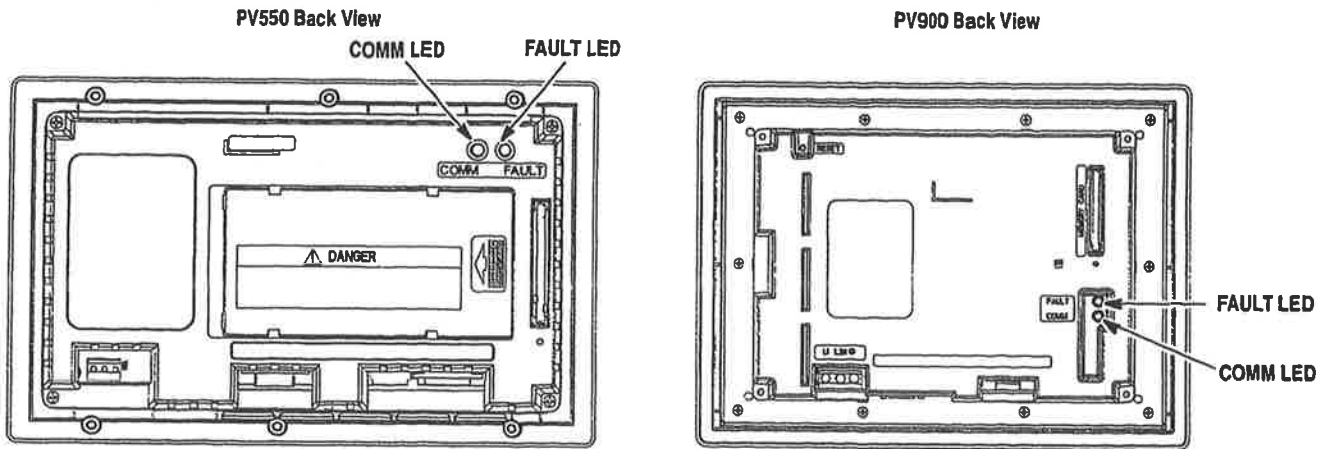
Problem	Probable Cause(s)	Corrective Action(s)
Cannot transfer application to memory card.	<ol style="list-style-type: none"> 1. Memory card is not properly installed. 2. Memory card is write protected.ⓐ 3. File currently exists on memory card.ⓐ 4. Application file is too large, not enough space on memory card. 5. Invalid memory card format.ⓐ 6. Data checksum is incorrect. 7. Application doesn't exist.ⓐ 	<ol style="list-style-type: none"> 1. Verify correct installation. 2. Change memory card protection switch. 3. Erase and reformat card. 4. Reduce size of application file or erase/format memory card. 5. Replace or reformat memory card. If problem continues, try another memory card. 6. Check for loose memory card. If problem continues, try another memory card. 7. Check the terminal information screen to verify that an application exists.
Screen objects do not function.ⓐ	Communications problem.	<p>Check status of Comm LED, refer to LED Indicators section.</p> <p>Refer to problem 'No communications with SLC or PLC controller' for additional troubleshooting instructions.</p>
Application file name appears as on Terminal Info screen.	<ol style="list-style-type: none"> 1. Application is invalid. 2. Application may contain an error making it unusable. 	<ol style="list-style-type: none"> 1. Download application and try again. 2. Download new application.
Area on PV900 color screen appears dark.	One of the tubes in the backlight has burnt out.	Replace PV900 color backlight.
Screen objects are not visible.	<ol style="list-style-type: none"> 1. Correct power is not applied. 2. Contrast 3. PV900 is in Screen Saver Mode. 4. PV550 backlight lamp is not on. 5. PV550 or PV900 backlight is burnt out. 	<ol style="list-style-type: none"> 1. Verify power connections. 2. Access Screen Setup from the Terminal Configuration Mode menu and adjust the contrast. To reset the display configuration on keypad terminals, press the left and right arrow keys simultaneously and then press [F9] on the PV550 or [F15] on the PV900. 3. Access Screen Setup from the Terminal Configuration Mode menu to check if the terminal is set for Screen Saver mode. 4. Access Screen Setup from the terminals Configuration Mode menu and turn on the backlight. 5. Replace backlight.
Values do not update in display but appear as asterisks ****	<ol style="list-style-type: none"> 1. Terminal is not communicating with SLC or PLC controller. 2. The value is invalid or exceeds the field width defined for the object. 	<ol style="list-style-type: none"> 1. Check status of Comm LED, refer to LED Indicators section. 2. Change the field width defined for the object. <p>Refer to problem 'No communications with SLC or PLC controller' for additional troubleshooting instructions.</p>

ⓐ Terminal displays a warning message with instructions if these errors occur.

LED Indicators

Use the two LED indicators to isolate operating problems. Figure 11.1 shows the location of these indicators.

Figure 11.1
LED Indicators



DH-485 LED Indications

LED	State	Indicates
Comm①	On (steady green)	Normal operating state (no communication faults detected).
	Off (power applied)	Fault detected. <ul style="list-style-type: none"> • Make sure controller is in run mode. • Verify baud settings of terminal and controller. • Verify proper terminal to controller connections.
	Blinking	No communications established.
Fault	Off	Normal operating state.
	On (steady red)	Fault detected. Cycle power to the terminal. If the fault still exists, the terminal requires servicing.
	Flashing	Hardware is functioning but no application is loaded or the current application is corrupted.

① Comm LED stays On until power-up self tests are complete.

Remote I/O LED Indications

LED	State	Indicates
Comm①	On (steady green)	Normal operating state (no communication faults detected).
	Off (power applied)	Communications not functioning <ul style="list-style-type: none"> • Verify that the baud rate and rack settings match the PLC settings. • Verify proper terminal to controller connections. • Verify that the PLC enables remote I/O communications.
	Blinking	No communications established. PLC is in program mode.
Fault	Off	Normal operating state.
	On (steady red)	Fault detected. Cycle power to the terminal. If the fault still exists, the terminal requires servicing.
	Flashing	Hardware is functioning but no application file is loaded or the current application is corrupted.

① Comm LED stays On until power-up self tests are complete.

Cleaning the Display Window

To clean the display window:



ATTENTION: Use of abrasive cleansers or solvents may damage the window. Do not scrub or use brushes.

1. Disconnect power from the terminal at the power source.
2. Using a clean sponge or a soft cloth, clean the display with a mild soap or detergent.
3. Dry the display with a chamois or moist cellulose sponge to avoid water spots.

Removing Paint and Grease

Remove fresh paint splashes and grease before drying by rubbing lightly with isopropyl alcohol. Afterward, provide a final wash using a mild soap or detergent solution. Rinse with clean water.

Equipment Hose Downs

Be aware that screen objects on touch cell terminals may activate during equipment hose downs.



ATTENTION: Because touch cell terminals have sensitive touch cell regions, it is possible for screen objects to activate during equipment hose downs.

Replacing the Clock Module

The Real Time Clock (RTC) module contains a small lithium battery used only by the real time clock. The battery is not used for application backup or input retention. The clock module has a typical life expectancy of 7 years.

The clock module replacement kits for the PV550 terminals are:

- Catalog No. 2711-NB2 (Series D or earlier)
- Catalog No. 2711-NB3 (Series E or later)

The clock module replacement kit for the PV900 terminals is Catalog No. 2711-NB3.

Instructions for replacement are included in the kit.



ATTENTION: The clock module contains lithium. Do not attempt to dispose of the module in a fire or incinerator. Doing so may cause the clock module to explode. Follow disposal regulations in your area for lithium battery disposal.

Replacing the PV550 Backlight Lamp

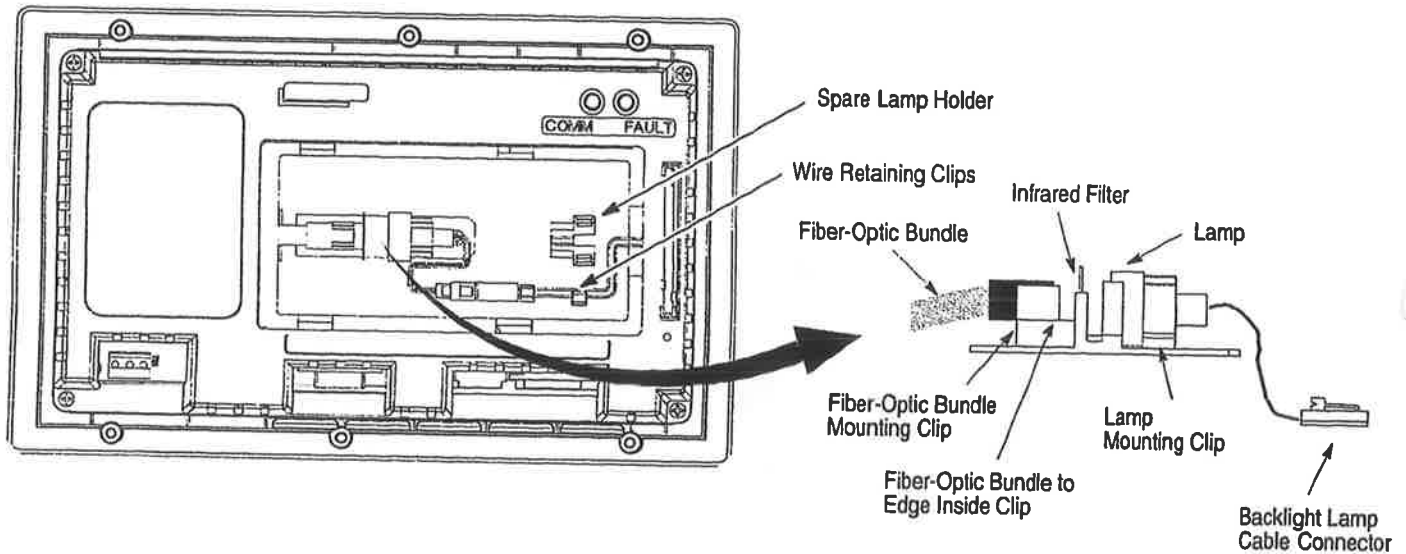
A replacement halogen lamp is available for the PV550 terminal (Catalog No. 2711-NL1). The halogen lamp illuminates the LCD display of the PV550 Terminal. Light from the lamp is transferred to the front panel through a fiber-optic bundle. An infrared filter prevents heat from damaging the fiber-optic cable.

Important: Make sure that the lamp and / or fiber-optic cable do not touch the infrared filter.



ATTENTION: When operating, the backlight lamp is extremely hot. Do not touch the lamp or the mounting clip when lamp is on. Allow lamp to cool to avoid personal injury.

Refer to the illustration below when replacing the backlight lamp.

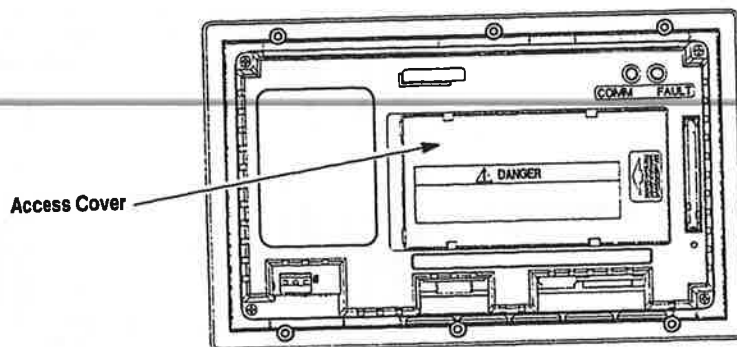


To replace the PV550 backlight lamp:

1. Turn off the power to the PV550 terminal.

Important: Turning off the power provides a standard reset. Changing the lamp with power applied may result in an unintentional reset.

2. Slide lamp access cover to the left and remove.



ATTENTION: Lamp may be hot. Allow lamp to cool before proceeding to avoid personal injury.

3. Disconnect backlight lamp cable connector. The connector has a locking tab that you must press to separate the connector.
4. Remove lamp from mounting clip. Avoid contact with the infrared filter.
5. Insert new lamp into holder.



ATTENTION: Do not touch the reflecting surface or halogen bulb when handling new lamp to avoid damaging lamp.

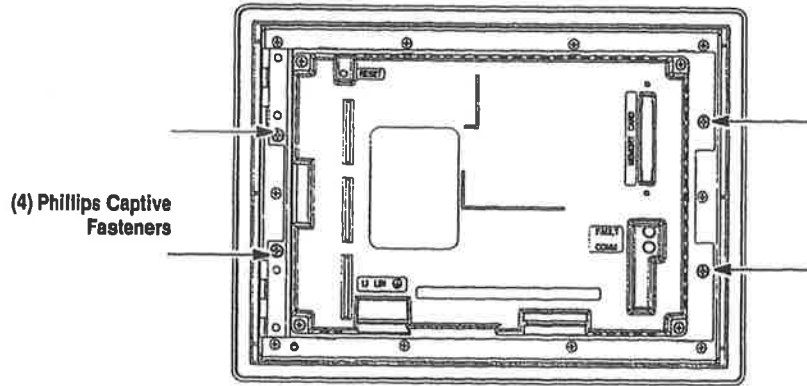
6. Connect lamp cable to connector. Make sure the cable is held in place by the wire retaining clips.
7. Replace lamp access cover.
8. Apply power to the terminal.
9. If new lamp does not light, refer to troubleshooting chart.

Replacing the PV900 Color Backlight

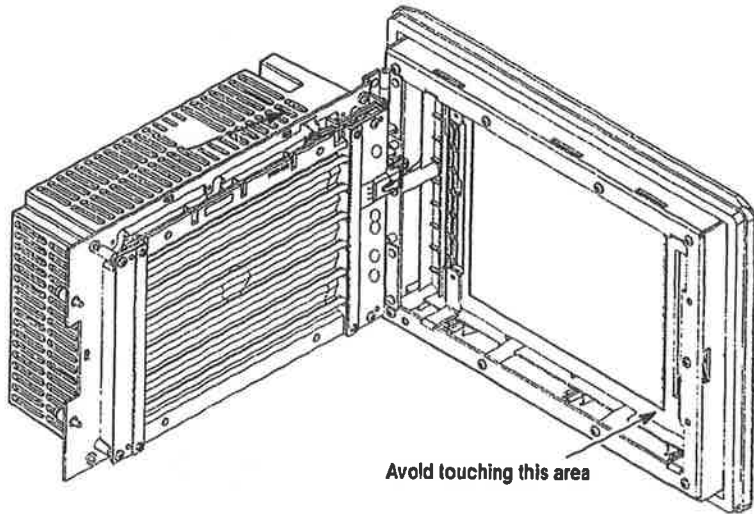
A replacement backlight is available for the PV900 color terminal (Catalog No. 2711-NL2). The backlight uses Cold Cathode Fluorescent (CCF) tubes to illuminate the color display.

To replace the PV900 backlight:

1. Turn off the power to the PV900 color terminal.
2. Loosen the 4 Phillips captive fasteners.

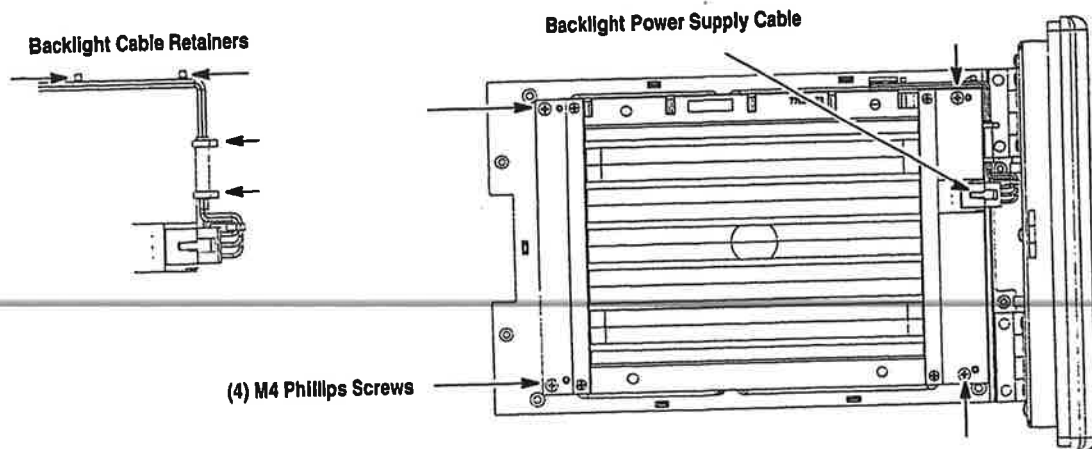


3. Open the back of the PanelView 900 color terminal by swinging the unit open about 90°.

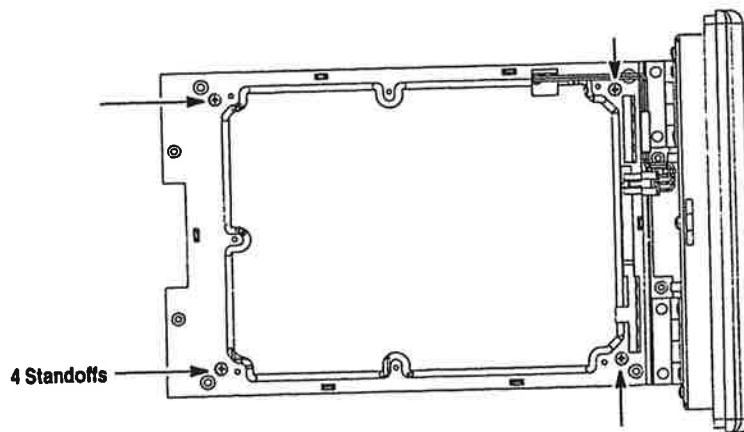


ATTENTION: Do not touch any of the exposed electronics to prevent damage from electrostatic discharge (ESD).

4. Unplug the backlight power supply cable and remove it from the molded cable retainers on the backlight reflector and set aside.



5. Remove the four (4) M4 Phillips screws and set aside.
6. Remove the backlight from the unit.



7. Place the new backlight on the 4 standoffs.
8. Replace the four (4) M4 Phillips screws that were set aside (in step 5) to a torque of 6 to 8 inch-pounds.
9. Place the backlight power supply cable under the cable retainers on the back light reflector and plug into the new backlight.
10. Close the back of the PanelView 900 Color terminal by swinging the unit closed.
11. Tighten the four (4) Phillips captive fasteners to a torque of 6 to 8 inch-pounds.
12. Apply power to the terminal.
13. If the display does not illuminate, refer to the troubleshooting chart.

Specifications

Electrical

AC Power

PV550

Supply Voltage Limits	85 to 264V ac, 47 to 63 Hz
Power Consumption	45 VA maximum

PV900M

Supply Voltage Limits	85 to 264V ac, 47 to 63 Hz
Power Consumption	110 VA maximum

PV900C

Supply Voltage Limits	85 to 264V ac, 47 to 63 Hz
Power Consumption	110 VA maximum

DC Power

PV550

Supply Voltage Limits	18 to 30V dc (24V dc nominal)
Power Consumption	12 Watts max. (0.5A @ 24V dc)

PV900M

Supply Voltage Limits	18 to 30V dc (24V dc nominal)
Power Consumption	58 Watts max. (2.7A @ 24V dc)

Mechanical

Enclosure

NEMA Type 12/13, NEMA Type 4X (indoor use only)
IP54, IP65

LED Indicators

COMM	Green
FAULT	Red

Weight

PV550

Keypad and Keypad & Touch	1.2 kg (2.7 lbs)
---------------------------	------------------

PV900M

Keypad	3.14 kg (6.9 lbs)
Touch Screen	2.91 kg (6.4 lbs)

PV900C

Keypad	3.18 kg (7.0 lbs)
Touch Screen	2.95 kg (6.5 lbs)

Dimensions

PV550 Keypad & Touch	mm	167 (H) x 266 (W) x 106 (D)
	inches	6.57 (H) x 10.47 (W) x 4.17 (D)
PV900M & C Keypad	mm	249 (H) x 406 (W) x 112 (D)
	inches	9.80 (H) x 15.97 (W) x 4.40 (D)
PV900M & C Touch Screen	mm	249 (H) x 336 (W) x 112 (D)
	inches	9.80 (H) x 13.24 (W) x 4.40 (D)

Mechanical**Installed Depth**

PV550	86 mm (3.39 inches)
	200 mm (7.8 inches) with memory card
PV900M	97 mm (3.81 inches)
	210 mm (8.27 inches) with memory card
PV900C	99 mm (3.89 inches)
	212 mm (8.35 inches) with memory card

Terminal Memory**PV550 (Series E or later)**

System RAM	320K bytes (volatile) 8K bytes (battery backed)
Application EEPROM (Flash)	240K bytes (application screens)

PV550 (Prior to Series E)

System RAM	256K bytes (volatile) 4K bytes (battery backed)
Application EEPROM (Flash)	112K bytes (application screens)

PV900M

System RAM	512K bytes (volatile) 8K bytes (battery backed)
Application EEPROM (Flash)	240K bytes (application screens)

PV900C

System RAM	512K bytes (volatile) 8K bytes (battery backed)
Application EEPROM (Flash)	240K bytes (application screens) 768K bytes (text and bitmaps)

Display**PV550**

Type	Liquid Crystal Display (LCD)
Size	120 x 60 mm (4.75 x 2.38 in.)
Pixels	256 x 128
Touch Cells (Touch Screen)	128 (16 columns x 8 rows)
Touch Cell Size	16 x 16 pixels

PV900M

Type	AC gas plasma
Size	210 x 131 mm (8.27 x 5.17 in.)
Pixels	640 x 400
Touch Cells (Touch Screen)	384 (24 columns x 16 rows)
Touch Cell Size	26 x 25 pixels

PV900C

Type	Active Matrix Thin-Film Transistor (TFT) with Cold Cathode Fluorescent (CCF) Backlight
Size	171 x 130 mm (6.73 x 5.12 in.)
Pixels	640 x 480
Touch Cells (Touch Screen)	384 (24 columns x 16 rows)
Touch Cell Size	26 x 30 pixels

Real Time Clock

Battery-backed clock	Timestamps critical data
----------------------	--------------------------

Character Size – PV550

Size Height x Width	Characters/ Row	Maximum Rows	Dimensions Inches (mm)
1H x 1W	40	16	.15H x .11W (3.8H x 2.8W)
1H x 2W	20	16	.15H x .22W (3.8H x 5.6W)
1H x 3W	13	16	.15H x .33W (3.8H x 8.4 W)
2H x 1W	40	8	.30H x .11W (7.6H x 2.8W)
2H x 2W	20	8	.30H x .22W (7.6H x 5.6W)
2H x 3W	13	8	.30H x .33W (7.6H x 8.4W)
3H x 1W	40	5	.44H x .11W (11.2H x 2.8W)
3H x 2W	20	5	.44H x .22W (11.2H x 5.6W)
3H x 3W	13	5	.44H x .33W (11.2H x 8.4W)

Character Size – PV900M

Size in Pixels ^① Height x Width	Characters/ Row	Maximum Rows	Cell Dimensions Inches (mm)
8 x 16	79	24	.104W x .208H (2.64 x 5.28)
8 x 24	79	16	.104W x .312H (2.64 x 7.92)
16 x 24	39	16	.208W x .312H (5.28 x 7.92)
24 x 32	26	12	.312W x .416H (7.92 x 10.56)
32 x 40	19	9	.416W x .52H (10.56 x 13.2)

① Pixel size = .013 x .013 inches (.33 x .33 mm)

Character Size – PV900C

Size in Pixels ^① Height x Width	Characters/ Row	Maximum Rows	Cell Dimensions Inches (mm)
8 x 16	79	29	.104W x .208H (2.64 x 5.28)
8 x 24	79	19	.104W x .312H (2.64 x 7.92)
16 x 24	39	19	.208W x .312H (5.28 x 7.92)
24 x 32	26	14	.312W x .416H (7.92 x 10.56)
32 x 40	19	11	.416W x .52H (10.56 x 13.2)

① Pixel size = .013 x .013 inches (.33 x .33 mm)

Communications**DH-485 Network**

Baud Rates 1200, 2400, 9600, 19.2K
Distance Maximum 4000 feet (1219 meters)

RS-232 or DH-485 Point-to-Point

Baud Rates 1200, 2400, 9600, 19.2K
Distance Maximum 20 feet (6.1 meters)

Remote I/O

Baud Rates 57.6K, 10,000 feet (2,800 meters)
115.2K, 5,000 feet (1,400 meters)
230.4K, 2,500 feet (700 meters)

Communications**RS-232 Printer Port**

Baud Rate	1200, 2400, 9600, 19.2K
Parity	None, Even, Odd
Data Bits	7 or 8
Stop Bits	1 or 2
Handshaking	None, Software (XON/XOFF), Hardware

Environment**Operating Temperature**

PV550	0 to 55° C (32 to 131° F)
PV900M	0 to 50° C (32 to 122° F)
PV900C	0 to 55° C (32 to 131° F)

Storage Temperature

PV550	-20 to 70° C (-4 to 158° F)
PV900M	-25 to 70° C (-13 to 158° F)
PV900C	-25 to 70° C (-13 to 158° F)

Relative Humidity

PV550 (non-condensing)	5 to 95% at 0 to 30° C (32 to 86° F) 5 to 75% at 31 to 40° C (88 to 104° F) 5 to 50% at 41 to 55° C (106 to 131° F)
PV900M (non-condensing)	5 to 85% at 0 to 30° C (32 to 86° F)
PV900C (non-condensing)	5 to 95% at 0 to 55° C (32 to 131° F)

Heat Dissipation

PV900	50 Watts (170 BTU/HR)
-------	-----------------------

Shock and Vibration**Impulse Shock**

(operating/non-operating) 15G/30G

Vibration (operating) 1G up to 2,000 Hz

Real Time Clock Module**Replacement Kit**

PV550 (Series E or later)	Catalog No. 2711-NB3
PV550 (Prior to Series E)	Catalog No. 2711-NB2
PV900	Catalog No. 2711-NB3

Backlight Lamp**Replacement Kit**

PV550	Catalog No. 2711-NL1
PV900C	Catalog No. 2711-NL2

Agency Certifications

CSA Certified
 CSA Class I, Division 2
 Groups A, B, C, D certified
 UL Listed
 CE marked for all applicable directives

Terminal Messages and Self-Test Numbers

This appendix lists messages that may appear during terminal operation and provides descriptions of self-test numbers.

- types of terminal messages
- listing of messages
- Remote I/O communication loss
- self-test numbers

Types of Terminal Messages

The 4 types of terminal messages are:

Status Messages

Indicate the terminal is performing an operation that may limit access to the terminal (such as an application file download) or a communication problem. The message disappears when the terminal completes the operation or when the condition is satisfied.

Reminder Messages

Indicate a minor fault or mistake. Reminder messages appear when an invalid operation is attempted (such as entering an out of range value). Pressing any key removes the message.

Warning Messages

Indicate the operation may produce undesirable results. You must respond to warning messages as indicated in the message.

Fault Messages

Indicate the terminal has detected a condition which prevents further operation. The current application will halt. The terminal must be reset (power cycled) to recover from this type of error.

Listing of Messages

Terminal messages are listed alphabetically.

Terminal System Message:	Type:	Means:	Recommended Action Is:
Aborted.	Reminder/ File Transfer Status	The terminal received an abort command during a file transfer.	Try again.
A fault has occurred. Error = X	Minor Fault or Terminal Fault	A minor fault was detected that could impact terminal operation or a terminal fault was detected.	Contact Allen-Bradley for technical support with error code. You may recover from a minor fault by pressing any key. If fault reoccurs, contact Allen-Bradley with the error code.
Application file contains errors.	Terminal Fault	Application contains incompatible data.	Check application and try again.
Application file: Insufficient RAM	Terminal Fault	The application file may be too large.	Try again. If possible, reduce the size of the application.
Application file: Too many retained memory devices.	Terminal Fault	The battery-backed RAM is too full to hold all devices requiring presets.	Reduce the number of control devices. Use global objects.
Check card status.	Reminder/ File Transfer Status	Problem found when formatting a memory card.	Try a new memory card.
Comms transfer error.	Reminder/ File Transfer Status	Communication error was detected.	Check for poor electrical connections or momentary cable removal. Try the file transfer again.
Data corrupted. Verify file and retry.	Reminder/ File Transfer Status	The checksum of data in a file transfer has failed.	Check for poor electrical connections or momentary cable removal. Try the file transfer again.
File exists. Cannot overwrite.	Reminder/ File Transfer Status	See message "The PVA File Exists:" Message only occurs when the file cannot be renamed.	Change file name or save to a new memory card.
File read access error.	Reminder	Error when reading the source file from a source device.	Try again. If problem continues, contact Allen-Bradley for technical support.
File too large.	Reminder/ File Transfer Status	The terminal could not transfer the file to its internal memory, because the file is too large. In a memory card transfer to card, the card does not have enough space for file.	Reduce size of application if \geq than what is allowed for terminal. See Appendix A. If copying to a card, verify card memory is sufficient.
File not supported.	Reminder/ File Transfer Status	The file does not load into terminal because the file is incompatible with the terminal's firmware.	Terminal firmware must be compatible with application. Contact Allen-Bradley if you need to verify compatibility. Verify that file is a PanelView 550/900 application (.PVA).
File write access error.	Reminder	Error when writing the source file.	Try again. If problem continues, contact Allen-Bradley for technical support.
Format erases entire card: 0 or F1 - Abort 1 or F2 - Continue	Warning	The operator pressed [F4] Erase / Format Card on the memory card configuration screen.	Enter appropriate response. 0 or F1 to abort 1 or F2 to continue
Hardware configuration is corrupted.	Terminal Fault	The terminal hardware configuration is corrupt.	Contact Allen-Bradley for technical support.
Logic Controller has screen control.	Reminder	Attempt to change application screen failed because the screen is configured for controller access only.	No action required, controller will change screens when necessary.

Terminal System Message:	Type:	Means:	Recommended Action Is:
No application on PV550/PV900.	Reminder/ File Transfer Status	Attempt to transfer an application to a memory card failed because no application is loaded in the terminal.	Use Terminal Info screen to check if application is loaded in terminal.
No files.①	Reminder	Attempt to transfer data from the memory card failed because no files were on the card.	Use memory card containing application (.PVA) files.
No Card Inserted.①	Reminder	Attempt to transfer data to/from a memory card failed because the card slot does not contain a memory card.	Install memory card. Try transfer again.
Proceed with download? 0 or F1 - Abort 1 or F2 - Continue	Warning	The [F2] Restore From Card on the memory card configuration screen was pressed.	Enter appropriate response. 0 or F1 to abort, 1 or F2 to continue.
Retained memory lost. Presets were loaded.	Reminder	The battery backed memory was detected as invalid during startup, and the system has defaulted to the preset values instead of the "last states."	
The PVA File exists. 0 or F1 - Abort 1 or F2 - Upload with new PVA file name	Reminder/ File Transfer Status	The [F3] Save To Card on the memory card configuration screen was pressed when the file exists on the card.	Enter appropriate response. 0 or F1 to abort, 1 or F2 to upload with new PVA file.
Timeout.	Reminder/ File Transfer Status	The terminal was waiting for the partner device in a file transfer, but timed out before the expected data or reply was received.	Check for pulled cables or severe data corruption with noise on the cable. Check to see that the personal computer was not reset. Try again.
Unformatted card.①	Reminder	The memory card is unformatted, contains an unrecognized format or may be corrupted.	Reformat the memory card or replace with a new memory card if card is corrupted. Try again.
Unknown device.①	Reminder/ File Transfer Status	The destination or source device is invalid for a read or write application transfer.	Verify the file type entered. Try again.
Value not in range.	Reminder	The entered value is out of the acceptable range.	Enter a value within acceptable ranges.
Write Protected Card.	Reminder/ File Transfer Status	Attempt to issue a card write command failed because the memory card switch is in the protected mode.	Select write mode by changing the switch on the top edge of the card. Try again.
Write to logic controller failed.	Comm Status	Controller does not accept data from the terminal.	Check connections (on Remote I/O units). This message appears if controller is not connected. Verify that controller is in run mode and not busy. Check that controller files being written are not in use by other controller operations.

① Message may also appear at the top of the memory card file transfer screen.

DH-485 Terminal Messages:	Type:	Means:	Recommended Action Is:
Data errors on the link.	Comm Status	Corrupt data packets were detected on the DH-485 network.	Verify controller addressing and baud rate settings. Check for loose or reversed wiring.
Duplicate node address.	Comm Status	More than one node was assigned the same address.	Verify all device nodes.
No active node(s) found on network.	Comm Status	No other DH-485 devices can be located on the network.	Check to see that PV550/900 and SLC are correctly connected to the system. If the error occurs again, the node addresses, baud rates, and maximum node addresses should be checked. Reset (cycle power to) the terminal.
Required network node(s) not found	Comm Status	<ol style="list-style-type: none"> If the message is flashing, the terminal is trying to access (read or write) one or more SLC files that are unavailable. The network is active, but SLCs are not located at the expected nodes. Node and maximum node numbers may not be set correctly. 	<ol style="list-style-type: none"> The files do not exist on SLC. Create the files on the SLC. Verify that the SLC(s) required by the application are at the expected node address(es) with the communication parameters set properly.

Remote I/O Terminal Messages:	Type:	Means:	Recommended Action Is:
Invalid rack configuration	Status	Invalid rack configuration for remote I/O communication. No communication can occur.	Correct the rack configuration.
No PLC communication	Comm Status	The PLC is not communicating. Possible causes are disconnected cable, no power to PLC, incorrect baud rate or rack settings for PLC configuration. COMM LED is off.	Check for pulled cables and PLC power. Also check settings for baud rate and rack configurations. Check for incorrect wiring of connector. Communication resumes when problem is corrected.
PLC in program mode.	Comm Status	The PLC is offline (in Program Mode). The COMM LED on the Configuration Mode menu and the back of the terminal are flashing.	Place the PLC in run mode to resume communication.
Remote I/O Hardware Failed.	Comm Status	During startup, the terminal detected a missing, corrupted or non-functional remote I/O card. The terminal will run but not communicate.	Contact Allen-Bradley for technical support and provide the specific terminal message.
Timeout - No Block Transfer Reads	Comm Status	The PLC is communicating with the terminal, but the PanelView is not receiving Block Transfer Read requests required by the application.	Check ladder logic for missing BTR instructions (instructions that aren't enabled) or addressing errors.
Timeout - No Block Transfer Requests	Comm Status	The PLC is communicating with the terminal, but the PanelView is not receiving Block Transfer Read or Write requests required by the application.	Check ladder logic for missing BTR or BTW instructions (instructions that aren't enabled) or addressing errors.
Timeout - No Block Transfer Writes	Comm Status	The PLC is communicating with the terminal, but the PanelView is not receiving Block Transfer Write requests required by the application.	Check ladder logic for missing BTW instructions (instructions that aren't enabled) or addressing errors.

Remote I/O Communication Loss

When communication fails on a Remote I/O network:

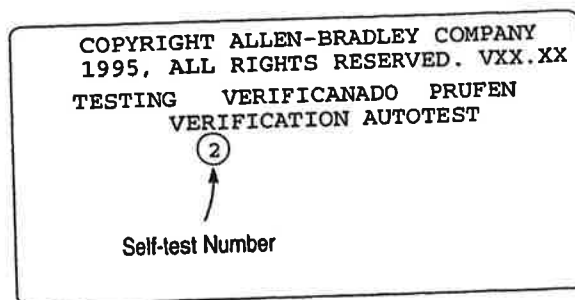
- Object states are maintained and the message "No PLC Communication" is displayed on the terminal screen.
- If Block Transfers are defined for the application, but no BTR or BTW instructions are received, another message is displayed when the Block Transfer Timeout occurs.

These messages continue to display until communications is established. If a write operation is attempted to the logic program controlling the PanelView objects, the terminal will display the message "Error: Write to Logic Controller failed".

If a PanelView object is activated during a communication loss, the object retains its new state and sends this state value to the controller when communications is established.

Self-Test Numbers

The self-test numbers appear on the screen during powerup.



Test Number	Indicates:
1	Static RAM test.
2	Terminal searching for a file to download.
10	Erase boot flash area.
11	Copy boot code.
12	Boot code copy successful.
13	Boot code copy failed. Check for error after boot code is copied to the on board flash EPROM.
20	Erase firmware from flash EPROM.
21	Copy firmware to firmware flash memory.
22	Firmware copy successful.
23	Firmware copy failed.
24	Performed CRC firmware check.
25	Firmware not compatible with boot code.
26	Firmware not compatible with hardware.
30	Watchdog test.
31	Stuck key test.
32	Real time clock test.

Note: You may not see all of these test numbers during a power-up.

If a test fails, the terminal displays:

ERROR! FEHLER! ERREUR! ERRORE!

The following test numbers appear only if a problem occurs.

Test Number	Indicates:
33	LCD RAM failed
40	No executable code to run after boot.
50	Wrong memory card format.
60	CPU could not execute code.

The table below shows fault conditions that may occur during power-up and the status of the Fault indicator.

Fault Indicator	Meaning
Sold Red	Static RAM Test Failed. Contact Allen-Bradley.
Blinking Red (blink rate is 6 times per second)	Checksum test on boot code failed. Contact Allen-Bradley.
Blinking Red (blink rate is 5 seconds on/5 seconds off)	Boot code is incorrect for terminal type (touch screen or keypad). Contact Allen-Bradley.

European Union Directive Compliance

European Union Directive Compliance CE

If the PanelView 550 or 900 Operator Terminal is installed within the European Union or EEA regions and has the CE mark, the following regulations apply.

EMC Directive

PanelView 550 and 900 Monochrome Terminals

This apparatus is tested to meet Council Directive 89/336/EEC Electromagnetic Compatibility (EMC) using the following standards, in whole or in part:

- EN 50081-2:1993 EMC – Generic Emission Standard, Part 2 – Industrial Environment
- EN 50082-2:1995 EMC – Generic Immunity Standard, Part 2 – Industrial Environment

The product described is intended for use in an industrial environment.

PanelView 900 Color Terminals

This apparatus is tested to meet Council Directive 89/336/EEC Electromagnetic Compatibility (EMC) using the following standards, in whole or in part:

- EN 50081-1:1992 EMC – Generic Emission Standard, Part 1 – Residential, Commercial and Light Industry
- EN 50082-2:1995 EMC – Generic Immunity Standard, Part 2 – Industrial Environment

The product described is intended for use in an industrial, light industrial or commercial environment.

Intended Use of Product

According to these Standards, the factor which determines, for EMC purposes, whether an apparatus is deemed to be "Industrial" or "Residential, commercial and light industrial", is given in Clause 1 of EN50081-2 as follows:

Apparatus covered by this standard is not intended for connection to a public mains network but is intended to be connected to a power network supplied from a high- or medium-voltage transformer dedicated for the supply of an installation feeding a manufacturing or similar plant.

The PanelView 550/900 monochrome terminals are intended for use solely in an industrial environment as defined above. When installed in Europe, any other application is in contravention of European Union Directives, and a breach of these laws.

Wiring Recommendations

To reduce electrical noise, connect the PanelView 550/900 terminal to its own branch circuit. The input power source should be protected by a fuse or circuit breaker rated at no more than 15 Amps. Route incoming power to the PanelView 550/900 terminal by a separate path from the communications cable.

Where power and communications lines must cross, they should cross at right angles. Communications lines can be installed in the same conduit as low level DC I/O lines (less than 10 Volts).

Declarations of Conformity

Declarations of Conformity are available upon request for the PanelView 550 and PanelView 900 terminals. Contact your local Allen-Bradley representative or distributor and request the following Allen-Bradley Corporate Numbers:

- 43500-218-01 for the PanelView 550 terminals
- 43500-219-01 for the DC power versions of the PanelView 550 terminals
- 43500-177-01 for the PanelView 900 monochrome terminals
- 43500-235-01 for the PanelView 900 color terminals

These documents declare that the terminals conform to the applicable directives.

Glossary

Application – In the context of PanelBuilder, an application is a logical arrangement of screens which replace the functions of a control panel and consist of push buttons, data entry objects, control lists, and indicators. The application runs in a PanelView terminal.

Application File – File containing configuration information for the PanelView 550/900 terminal. Files exist as either a PanelView Application (.PVA extension) or as a PanelBuilder Application (.PBA extension). Files transferred to a terminal are in a .PVA format. Files within PanelBuilder are in a .PBA format.

Baud – A rate at which a transmission occurs, where one baud is the number of code elements per second. If a change in state can assume one of 8 values, then one baud is one 3 bit value per second.

Bit – The smallest unit of information in the binary numbering system. A bit is represented by the digits 0 and 1.

Boot Revision – The revision number of the terminal boot code.

Byte – A sequence of eight consecutive bits treated as a single value.

Controller, Programmable – Refer to programmable controller.

Cursor Keys – Up / down / left / right arrow keys on the terminal keypad used to move a selection cursor or the active object indicator bar.

Download – The process of transferring an application from the computer running PanelBuilder 550/900 Configuration Software, a memory card or the PanelView File Transfer Utility to a PanelView terminal.

DH-485 link – Data Highway 485 link. An Allen-Bradley token-passing carrier-band link for a local area network.

DH+™ link – Data Highway Plus™ link. An Allen-Bradley token-passing baseband link for a local area network.

EMI – Acronym for Electromagnetic Interference. An extraneous signal in a circuit that can interfere with the desired signal.

EPROM – Acronym for Erasable Programmable Read Only Memory. Can be written to and erased.

EPROM (Flash) – Erasable, in -circuit, programmable, non-volatile memory. Used by the PanelView 550/900 to store an application.

Firmware – Instruction code for the PanelView 550/900 terminal that is permanently stored in read only memory.

Function Key – A set of keys that can be used to initiate a function. The PanelView 550 has 10 user defineable function keys. The PanelView 900 has 16 user defineable function keys.

HHT – Acronym for Hand Held Terminal (Catalog No. 1747-PT1). A device used to configure and monitor data within SLC data tables.

ISA – Acronym for Instrument Society of America.

Keypad – The set of 14 keys (numeric 0 → 9, decimal point, backspace, minus, and enter) to the right of the display window on keypad terminals that are used to enter data.

LED – Acronym for Light Emitting Diode. The PanelView 550/900 has two LED indicators (Comm and Fault).

Link Coupler – Connects devices on the Allen-Bradley DH-485 communications network.

Memory Card – A storage medium similar to a floppy disk which can store a PanelBuilder application.

Menu – A list of available commands in the PanelBuilder application. Menu names appear in the menu bar at the top of the window.

NEMA – Acronym for National Electric Manufacturers Association.

Node – A device on a DH-485 network which has a unique address (0 to 31).

Node Address – A unique value (0 to 31) assigned to each device on a DH-485 network. Addressing allows communications between individual devices. All data transfers are assigned a destination address.

PanelBuilder 550/900 Software – A Microsoft Windows based program used to develop an application to run in the PanelView terminal.

PanelView Terminal – An Allen-Bradley keypad or touch screen terminal which runs a PanelBuilder application. The terminal provides the operator interface to the logic controller when the application is executing.

Pass-Through – Means of transferring data between a computer on the DH+ network and a PanelView terminal on the remote I/O network. A PLC5 controller acts as a bridge between the two networks.

PCMCIA – Acronym for Personal Computer Memory Card International Association.

PIC – Acronym for Personal Computer Interface Converter. Converts between RS-232 and RS-485 standard electrical interface signals.

PLC – Acronym for Programmable Logic Controller, an Allen-Bradley trademark.

Preset Value – A value that is loaded into a PLC or SLC controller data table when an application is first started.

Programmable Controller – A device used to replace relay logic used for sequencing, timing, and counting. Instead of physically wired devices such as relays, push buttons and limit switches, a programmable controller tests the state of inputs and sets outputs according to stored programs.

Real Time Clock (RTC) – Internal clock that provides time, day, month and year.

Remote I/O Link – A serial link for carrying I/O data between a PLC or SLC processor/scanner and remote I/O adapters. Also supports data that is moved using block transfer ladder instructions.

Restore – To load an application from a memory (PCMCIA) card.

RS-232 – Standard electrical interface for serial data communications.

RS-485 – Standard electrical interface for data communications.

Save – The process of transferring data to a computer or memory card.

Scratchpad – A window that appears on the center of the display screen that allows data entry using the keypad.

Screen – See application screen or touch screen.

SLC – Allen-Bradley trademark for Small Logic Controllers. See programmable controller.

Touch Cell – One of the rectangular areas on the display window that the PanelView terminal can sense when touched. The PanelView 550 has 128 touch cells. The PanelView 900 has 384 touch cells.

Touch Screen – The display window of the terminal that responds when touched. The screen consists of touch cells.

Upload – The process of transferring an application from a PanelView Terminal or memory card to the computer running PanelBuilder Configuration Software or PanelView File Transfer Utility.

Validate – The process where PanelBuilder checks the validity of an application. Errors, such as incorrect data types, are displayed and must be corrected before an application can be loaded.

Verify – The process where PanelView terminal checks the validity of a downloaded application.

A

- AC Power, Connecting, 2-1-2-4
- Accessories
 - 550 to 900 Upgrade, 1-21
 - Antiglare Overlay, 1-21
 - Backlight Lamp, 1-22
 - Configuration Software, 1-21
 - File Transfer Utility, 1-21
 - Function Key Legend Kit, 1-20, 1-21
 - Memory Card, 1-19, 1-21
 - Mounting Clips, 1-22
 - Personal Computer Interface Converter, 1-21
 - Real Time Clock, 1-22
 - Wallmount Power Supply, 1-21
- Alarms
 - Content, 5-12
 - Description, 1-18
 - History, 1-18
- Allen-Bradley, Contacting for Assistance, P-3
- Antiglare Overlay, 1-21
- Application Files
 - Description, 1-15
 - Running, 5-1
- Application Settings, 3-1
- Audience, Intended, P-2

B

- Backlight Control, 3-12
- Backlight Lamp, 1-22
 - PanelView 550, 1-7
 - PanelView 900C, 1-22
- Backlight Lamp Replacement
 - for PanelView 550, 11-6, 11-7
 - for PanelView 900C, 11-8
- Bar Graphs, 5-10

C

- Cables
 - DH-485, 8-3
 - DH-485 Network Installation, 8-4
 - DH-485 Programming, 1-21
 - Remote I/O, 1-21
 - Remote I/O Connector, 1-22
 - RS-232, 1-21
- Card, Memory, 1-19, 3-5, 4-1, 4-2, 4-3, 4-4
- Certifications, A-4
- Character Size, A-3
- Cleaning, Display Window, 11-5
- Color Display
 - Available Options, 1-2
 - Backlight Replacement, 11-8
 - Description, 1-3
 - PanelView 900, 1-3
- Comm LED, 3-3, 3-7, 11-4
- Communication Ports, Available Options, 1-2
- Configuration Mode Menu, 1-17, 3-2
- Configuration Software, 1-21
- Contacting Allen-Bradley, P-3
- Contents, Manual, P-1
- Contrast Control, 3-12
- Control Lists
 - Active Item, 5-3
 - Active List, 5-3
 - Cursor, 5-4
 - Description, 5-3
 - List Keys, 5-4
 - Piloted Control List, 5-5
 - Selecting an Item, 5-5
 - Vertical Indicator Bar, 5-3
- Conventions, P-2
- Cursor Keys
 - PanelView 550, 1-5
 - PanelView 900, 1-9

D

- Data Entry
 - Field, 5-6
 - Keypad Enable Button, 5-6
 - Numeric Entry Cursor Point, 5-6
 - Range, 5-6
- Date, 5-11
- Date/Time Setup, 3-11
- DC Power , Connecting, 2-4- 2-8
- Declarations of Conformity, C-2
- DH-485 Communications
 - Baud Rate, 3-6
 - Cables, 8-3
 - Connecting a Personal Computer, 8-6
 - Connectors, 8-2
 - DH-485 Communicatons Port, 1-12, 8-2
 - LED Indicators, 3-3, 3-7, 11-4
 - Link Coupler, 8-3
 - Max Node Address, 3-6
 - Network Connection, 8-4
 - Node Address, 3-6
 - RS-232 Port, 1-12
 - RS-232 Printer Port, 8-2
 - Setup Screen, 3-6
 - SLC Connection, 8-3
 - SLC Programming Connector, 1-12
 - Terminals Available On, 1-2
- DH-485 Communications Port
 - PanelView 550, 1-7
 - PanelView 900, 1-11
- DH-485 Programming Connector
 - PanelView 550, 1-7
 - PanelView 900, 1-11
- Display, Using Touch Screen, 1-16
- Display Window, Cleaning, 11-5
- Displays
 - Bar Graph, 5-10
 - Color, 1-2
 - List Indicator, 5-10
 - Message, 5-11
 - Monochrome, 1-2
 - Multistate Indicator, 5-10
 - Numeric Data, 5-11

E

- EMC Directive, C-1
- European Union Directive Compliance, C-1

F

- Fault LED, 3-3, 3-7, 11-4
- Fault Messages, B-1
- Features
 - PanelView 550, 1-4, 1-5, 1-6, 1-7
 - PanelView 900, 1-8, 1-9, 1-10
- File Transfer Port, 1-2
- File Transfer Utility, 1-21
- Files, Application, 1-15
- Format Card, 3-5
- Function Key Legend Kit, 1-16, 1-20, 1-21
- Function Keys
 - PanelView 550, 1-5
 - PanelView 900, 1-9

H

- Hand-Held Terminal, Connection, 8-5
- Hold Time, 5-2

I

- Indicators
 - Bar Graph, 5-10
 - List, 5-10
 - Multistate, 5-10
- Initial Screen, 2-6
- Installing the PanelView 550
 - Ambient Temperature, 6-1
 - Enclosures, 6-1
 - Mounting Clearances, 6-3
 - Mounting Dimensions, 6-2
 - Mounting Procedures, 6-5
 - Panel Cutout Dimensions, 6-4
 - Tools, 6-2
 - Ventilation, 6-1
- Installing the PanelView 900
 - Ambient Temperature, 7-1
 - Enclosures, 7-1
 - Keypad Mounting Dimensions, 7-3
 - Mounting Clearances, 7-4
 - Mounting Procedures, 7-6
 - Panel Cutout Dimensions, 7-5
 - Tools, 7-2
 - Touch Screen Mounting Dimensions, 7-2
 - Ventilation, 7-1
- Intended Audience, P-2
- Intended Uses, 1-1
- Intensity Control, 3-13

K

- Key Repeat
 - Delay, 3-9
 - Rate, 3-9
- Keypad Enable Button, Entering Data, 5-7
- Keypad Terminal
 - Available Options, 1-2
 - Operation, 1-16
- Touch Screen Terminal
 - Available Options, 1-2
 - Operation, 1-16

L

- Language
 - Selection, 3-4
 - Types, 3-4
- Language Button, 3-3
- Last Chassis, 3-8
- LEDs
 - Comm, 3-3, 3-7, 11-4, A-1
 - Fault, 3-3, 3-7, 11-4, A-1
 - PanelView 550, 1-7
 - PanelView 900, 1-11
- Legend Kit, Function Key, 1-16, 1-20
- Link Coupler, 8-3
- List
 - Control, 5-3, 5-6
 - Indicator, 5-10
 - Screen Selector, 5-8
- List Keys
 - Control lists, 5-4
 - screen lists, 5-9

M

- Memory Card, 1-21
 - Applications, 3-5
 - Erase / Format, 3-5
 - Installation, 1-19
 - Listing, 3-5
 - Restore From, 3-5
 - Saving to, 3-5
 - Transferring Applications, 4-1, 4-2, 4-3, 4-4
 - Write Protection, 11-3, B-3
- Menu
 - Configuration Mode, 3-2
 - Terminal Configuration Mode, 3-1, 3-2
- Message Displays, 5-11
- Messages
 - Fault, B-1

- Reminder, B-1
- Status, B-1
- Terminal, B-1
- Warnings, B-1

- Monochrome Display
 - Available Options, 1-2
 - Screen Conditioner, 3-14
- Mounting Clips, 1-22
- Multistate Indicators, 5-10

N

- Numeric Data Displays, 5-11
- Numeric Entry Controls
 - Description, 5-6
 - Entering Data, 5-7
 - Keypad Enable Button, 5-7
 - Numeric Entry Cursor Point, 5-6, 5-7
 - Scratchpad, 5-6
- Numeric Entry Keys
 - PanelView 550, 1-5
 - PanelView 900, 1-9

O

- Operations List, 3-3

P

- PanelView 550
 - Backlight Lamp, 1-7
 - Backlight Lamp Replacement, 11-6, 11-7
 - Cursor Keys, 1-5
 - Cutout Dimensions, 6-4
 - DH-485 Communications Port, 1-7
 - DH-485 Programming Connector, 1-7
 - Features, 1-4, 1-5, 1-6, 1-7
 - Function Key Legend Kit, 1-20
 - Function Keys, 1-5
 - Installation, 6-5
 - LEDs, 1-7
 - Mounting Clearances, 6-3
 - Numeric Entry Keys, 1-5
 - PCMCIA Slot, 1-7
 - Power Connection Terminals, 1-7
 - Power Connections, 2-2
 - Printer / File Transfer Port, 1-7, 1-11
 - Ratings, 6-1
 - Remote I/O Port, 1-7
 - Reset, 2-8
 - RS-232 Communications Port, 1-7
 - Screen Setup, 3-12
 - Touch Cells, 1-5

- PanelView 900
 - Backlight Replacement, 11-8
 - Clearances, 7-4
 - Color Display, 1-3
 - Cursor Keys, 1-9
 - DH-485 Communications Port, 1-11
 - DH-485 Programming Connector, 1-11
 - Features, 1-8, 1-9, 1-10
 - Function Key Legend Kit, 1-20
 - Function Keys, 1-9
 - Installation, 7-6
 - Key Repeat Delay, 3-9
 - Key Repeat Rate, 3-9
 - LEDs, 1-11
 - List Keys, 5-4
 - Monochrome Display Adjustments, 3-14
 - Mounting Dimensions, 7-2, 7-3, 7-5
 - Numeric Entry Keys, 1-9
 - PCMCIA Slot, 1-11
 - Power Connection Terminals, 1-11
 - Power Connections, 2-3
 - Printer / File Transfer Port, 1-11
 - Ratings, 7-1
 - Remote I/O Port, 1-11
 - Reset, 2-8
 - Reset Button, 1-11
 - Reset Video, 3-3
 - RS-232 Communications Port, 1-11
 - Screen Setup, 3-13
 - Touch Cells, 1-9
- PanelView Terminal
 - Operation, 1-16
 - Types, 1-2
- Pass-Through, 2-7, 3-8, 10-7
- PCMCIA Slot
 - PanelView 550, 1-7
 - PanelView 900, 1-11
- Personal Computer Interface Converter, 1-21, 8-5, 8-6
- Piloted Control Lists, 5-5
- Power Connection
 - AC power, 2-1- 2-4
 - Connecting Power, 2-2, 2-3
 - DC power, 2-4- 2-8
 - PanelView 550, 2-2
 - PanelView 900, 2-3
 - Terminals, 2-2, 2-3
- Power Connection Terminals
 - PanelView 550, 1-7
 - PanelView 900, 1-11
- Power Supply, 1-21
 - Wallmount, 8-5, 8-6
- Power-up Sequence, 2-6
- Preset Operations Screen
 - Initial Values, 3-8
 - Power-Up Screen, 3-9
 - Preset Values, 3-8
 - Restart and Load Presets, 3-9
- Printer
 - Baud Rate, 3-15
 - Communication Settings, 3-15
 - Connecting, 8-8, 10-6
 - Port Mode, 3-16
 - Setup, 3-15
- Printer / File Transfer Port, 1-2
 - PanelView 550, 1-7, 1-11
 - PanelView 900, 1-11
- Printing, 1-17
 - Printout Contents, 5-12
- Publications, Related, P-2
- Push Buttons
 - Description, 5-2
 - Hold Time, 5-2
 - Operation, 5-2

R**Rack**

- Number, 3-8
- Size, 3-8
- Starting Group, 3-8

Real Time Clock, 1-22

- Real Time Clock Module, A-4
- Replacement, 11-5

Related Publications, P-2**Reminder Messages, B-1****Remote I/O Communications**

- Baud Rate, 2-7, 3-8
- Block Transfer Timeout, 2-7
- Cable, 10-4
- Communication Parameters, 3-7
- Computer Connection, 10-5
- Configuration Screen, 2-7, 3-7
- Connector, 1-14
- Last Chassis, 2-7, 3-8
- LED Indicators, 3-3, 11-4
- Out-of-Box Configuration, 2-7
- Pass-Through, 2-7, 3-8, 10-7
- Printer Connection, 10-6
- Rack Number, 2-7, 3-8
- Rack Size, 2-7, 3-8
- Remote I/O Device Connection, 10-4
- Remote I/O Port, 10-2
- RS-232 Port, 10-2
- Starting Module Group, 2-7, 3-8
- Supported Controllers, 10-3
- Terminals Available On, 1-2
- Transferring Applications, 10-2

Remote I/O Port

- PanelView 550, 1-7
- PanelView 900, 1-11

Reset

- PV550 terminal, 2-8
- PV900 terminal, 2-8

Reset Button, PanelView 900, 1-11**Reset Video, 3-3, 3-12****Restore From Card, 3-5****Reverse Video, 3-12****RS-232 (DH-485) Communications**

- RS-232 Printer Port, 9-2
- Cables, 9-3
- Communications Port, 1-13, 1-14
- Computer Connection, 9-4
- DH+ Network Connection, 9-5
- Printer Connection, 9-6
- RS-232 Communications Port, 9-2
- RS-232 Printer Port, 1-13, 1-14
- SLC Connection, 9-3
- Terminals Available On, 1-2
- Transferring Applications, 9-2

RS-232 Communications Port

- PanelView 550, 1-7
- PanelView 900, 1-11

Run Mode Button, 3-3**S****Scale, Bar Graph, 5-10****Scratchpad, 5-6**

- Cancelling, 5-7
- Entering Data, 5-7

Screen

- DH-485, 3-6
- Initial, 2-6
- Language Selection, 3-4
- Memory Card Transfer, 3-5
- Power-Up, 3-9
- Preset Operations, 3-8
- Remote I/O Setup, 2-7
- RIO Configuration, 3-7
- Saver, 3-13
- Screen Adjustments, 3-12
- Terminal Information, 3-10
- Time and Date Settings, 3-11

Screen Adjustments

- Contrast Control, 3-12
- Reset Video, 3-12, 3-14
- Reverse Video, 3-12, 3-13
- Screen Conditioner, 3-14
- Screen Conditioner Hour, 3-14
- Screen Conditioner Time, 3-14
- Screen Intensity, 3-13
- Screen Saver, 3-13
- Screen Saver Intensity, 3-14
- Screen Saver Timeout, 3-13
- Backlight Control, 3-12

- Screen Selectors
 - Cursor, 5-9
 - Description, 5-8
 - List Keys, 5-9
 - Selecting an Item, 5-9
 - Vertical Indicator Bar, 5-9
- Self Test Numbers, 2-6, B-5
- Set Time/Date
 - Setting Date, 3-11
 - Setting Time, 3-11
- Settings, Application, 3-1
- SLC Programming Device, Connecting a HHT, 8-5
- Specifications
 - Electrical, A-1
 - Environment, A-4
 - LCD Display, A-1
 - Mechanical, A-1
 - Memory, A-1
- Status Messages, B-1

T

- Terminal Configuration Mode Menu, 3-1, 3-2
 - Accessing, 3-2
 - Comm and Fault LED, 3-3
 - Date/Time Setup, 3-11
 - Language Button, 3-3
 - LEDs, 3-3, 3-7
 - Memory Card, 3-5
 - Operations List, 3-3
 - Preset Operations, 3-8
 - Run Mode Button, 3-3
 - Screen Adjustments, 3-12
 - Serial Communications, 3-7

- Terminal Information, 3-10
- Terminal Information
 - Application File, 3-10
 - Boot Revision, 3-10
 - Firmware Revision, 3-10
 - Hardware Configuration, 3-10
- Terminal Messages, 1-17, B-1
- Terminal Types, 1-2
- Terminology, P-2
- Time, 5-11
- Time/Date Setup, 3-11
- Touch Cells
 - PanelView 550, 1-5
 - PanelView 900, 1-9
- Troubleshooting
 - Chart, 11-1
 - Contacting Allen-Bradley, P-3

U

- Upgrade Software, 1-21
- Upload / Download Utility, User Manual, P-2

W

- Wallmount Power Supply, 8-5, 8-6
- Wallmount Power Supply, 1-21
- Warning Messages, B-1
- Wiring and Safety Guidelines, 8-1, 9-1, 10-1
- Wiring Recommendations, C-2
- Write Protection, Memory Card, 11-3, B-3



Allen-Bradley, a Rockwell Automation Business, has been helping its customers improve productivity and quality for more than 90 years. We design, manufacture and support a broad range of automation products worldwide. They include logic processors, power and motion control devices, operator interfaces, sensors and a variety of software. Rockwell is one of the world's leading technology companies.

Worldwide representation.



Argentina • Australia • Austria • Bahrain • Belgium • Brazil • Bulgaria • Canada • Chile • China, PRC • Colombia • Costa Rica • Croatia • Cyprus • Czech Republic • Denmark • Ecuador • Egypt • El Salvador • Finland • France • Germany • Greece • Guatemala • Honduras • Hong Kong • Hungary • Iceland • India • Indonesia • Ireland • Israel • Italy • Jamaica • Japan • Jordan • Korea • Kuwait • Lebanon • Malaysia • Mexico • Netherlands • New Zealand • Norway • Pakistan • Peru • Philippines • Poland • Portugal • Puerto Rico • Qatar • Romania • Russia-CIS • Saudi Arabia • Singapore • Slovakia • Slovenia • South Africa, Republic • Spain • Sweden • Switzerland • Taiwan • Thailand • Turkey • United Arab Emirates • United Kingdom • United States • Uruguay • Venezuela • Yugoslavia

Allen-Bradley Headquarters, 1201 South Second Street, Milwaukee, WI 53204 USA, Tel: (1) 414 382-2000 Fax: (1) 414 382-4444

Publication 2711-6.1 – June 1996

Supersedes Publication 2711-616 – March 1995

Supersedes Publication 2711-616.1 – June 1995

Supersedes Publication 2711-616.2 – February 1996

Supersedes Publication 2711-602 – November 1994

Supersedes Publication 2711-602.1 – October 1995

Supersedes Publication 2711-602.2 – February 1996

Supersedes Publication 2711-602.3 – March 1996

40061-360-01(A)

Copyright 1996 Allen-Bradley Company, Inc. Printed in USA

ATTENTION

**THE FOLLOWING MODEL NUMBERS MUST USE
QUICKDESIGNER VERSION 2.0 OR GREATER**

QPI21100C2P
QPI21100E2P
QPI21100S2P
QPI2D100C2P

QPI2D100E2P
QPI2D100S2P
QPJ2D100L2P
QPJ2D100S2P

**THE FOLLOWING MODEL NUMBERS MUST USE
QUICKDESIGNER VERSION 2.2 OR GREATER**

QPI2D100L2P
QPK2D100L2P
QPK2D100S2P

**THE FOLLOWING MODEL NUMBERS MUST USE
QUICKDESIGNER VERSION 3.1 OR GREATER**

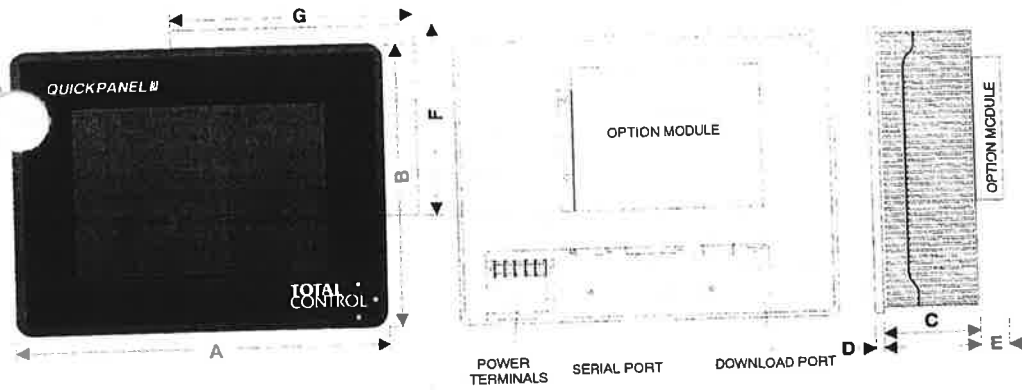
QPI211V0C2P
QPH2D100S2P
QPH2D100L2P
QPL21100C2P

**ALL ABOVE UNITS WILL NOT WORK WITH
QUICKDESIGNER SOFTWARE 1.06 OR BELOW.**

If you are a current owner of QUICKDESIGNER Software and require an update,
please contact Inside Sales at 708-345-5500 to obtain purchasing information.



QUICKPANEL 12.1" (QPL-21100-C2P), 10.5" (QPI-2xxxx-Sxx, QPI-2xxxx-Cxx, QPI-2xxxx-Lxx) & 9" (QPI-2xxxx-Exx)

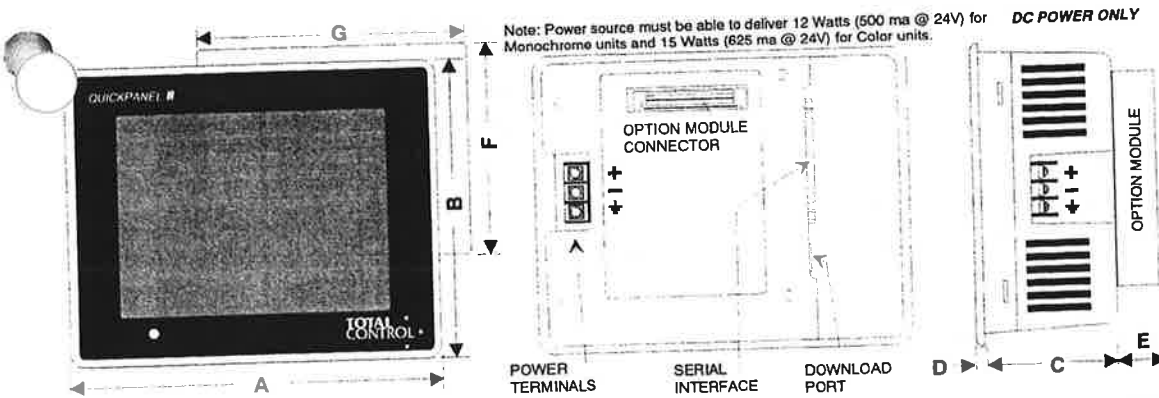


The following option modules may be used with these displays:

QPI-ABD-201
 QPI-ABR-201
 QPI-MBP-201
 QPI-GEG-201

Model	Dim A	Dim B	Dim C	Dim D	Dim E	Dim F	Dim G
QPI-2xxxx-Sxx	12.480(317mm)	9.570(243mm)	3.05(77.5mm)	.3(7.5mm)	1.25(32mm)	8.98(228+/-0.5mm)	11.89(302+/-0.5mm)
QPI-2xxxx-Cxx							
QPI-2xxxx-Lxx						7.92(201+/-1mm)	10.20(259+/-1mm)
QPI-2xxxx-Exx	10.79(274mm)	8.5(216mm)	1.93(49mm)	.3(7.5mm)	1.25(32mm)	10.16(258+/-1mm)	13.07(332+/-1mm)
QPL-2xxxx-C2P	13.62(346mm)	10.70(272mm)	2.90(73.5mm)	.3(7.5mm)	1.25(32mm)	8.98(228+/-0.5mm)	11.89(302+/-0.5mm)
QPI-2xxVx-Cxx (Video)	12.480(317mm)	9.570(243mm)	3.05(77.5mm)	.3(7.5mm)	1.25(32mm)	8.98(228+/-0.5mm)	11.89(302+/-0.5mm)

QUICKPANEL jr. 5" Displays (QPJ-2xxxx-Lxx, QPJ-2xxxx-Sxx) & 6" Displays (QPK-2xxxx-Lxx, QPK-2xxxx-Sxx)



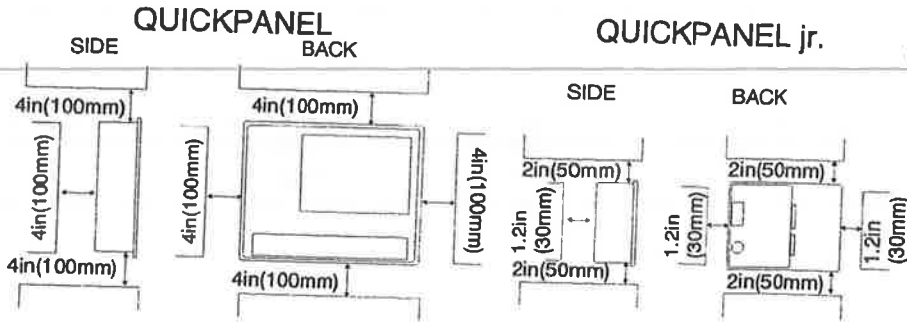
The following option modules may be used with these displays:

QPJ-ABD-201
 QPJ-ABR-201
 QPJ-MBP-201
 QPJ-GEG-201

Model	Dim A	Dim B	Dim C	Dim D	Dim E	Dim F	Dim G
QPJ-2xxxx-Lxx	6.75(172mm)	5.00(127mm)	2.125(54mm)	.197(5mm)	1(25mm)	4.45(113+/-0.5mm)	6.22(158+/-0.5mm)
QPJ-2xxxx-Sxx							
QPK-2xxxx-Lxx	6.71(170.5mm)	5.43(138mm)	2.24(57mm)	.197(5mm)	1(25mm)	4.86(123.5+/-0.5mm)	6.10(155+/-0.5mm)
QPK-2xxxx-Sxx							

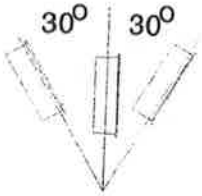
Installation information for QUICKPANEL and QUICKPANEL jr.

NOTICE: The panel clamps are packed in the carton.



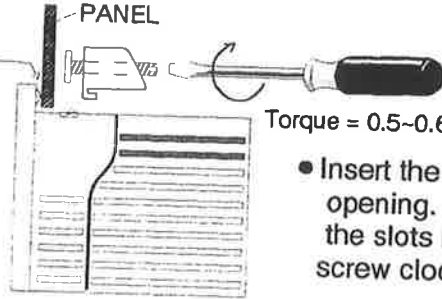
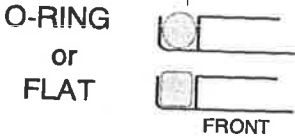
- For easier maintenance and proper ventilation, ensure the display is mounted away from surrounding objects.

Precautions



- When installing the display on a slanted panel, the slope of the panel should be within 30 degrees from the vertical position. If the slope is greater than 30 degrees, provide fan cooling.
- Ensure heat from other equipment does not interfere with the display.
- For proper ventilation, provide 4" of clearance around the QUICKPANEL and 2" of clearance around the QUICKPANEL jr.
- Ground the display to earth ground.
- Panel thickness = (1.6mm~10mm) .063in~.394in for QUICKPANEL (1.6mm~5mm) .063in~.197in for QUICKPANEL jr.

- Install the gasket in the slot in the faceplate.



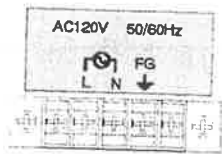
- Insert the display through the panel opening. Insert the panel clamps into the slots in the display body. Turn screw clockwise to tighten.

Units Marked UL and c-UL

Use No. 14 to 18 AWG, solid or stranded copper conductors and note the following precautions.

1. Suitable for use in Class I, Division 2, Groups A, B, C and D hazardous locations, or nonhazardous locations only.
2. WARNING: Explosion hazard - substitution of components may impair suitability for Class I, Division 2.
3. WARNING: Explosion hazard - do not disconnect equipment unless power has been switched off or the area is known to be nonhazardous.
4. WARNING: Explosion hazard - when in hazardous locations, turn off power before replacing or wiring modules.

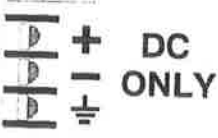
AC Power (QPX-21xxx-xxx)



MAKE SURE THE POWER IS OFF

- Remove the protective cover on the AC terminal strip. Remove 1/4" of insulation from the supply wires and insert them under the terminal clamps. Tighten the clamp screws to secure the wires. Replace the protective cover.

DC Power (QPX-2Dxxx-xxx)

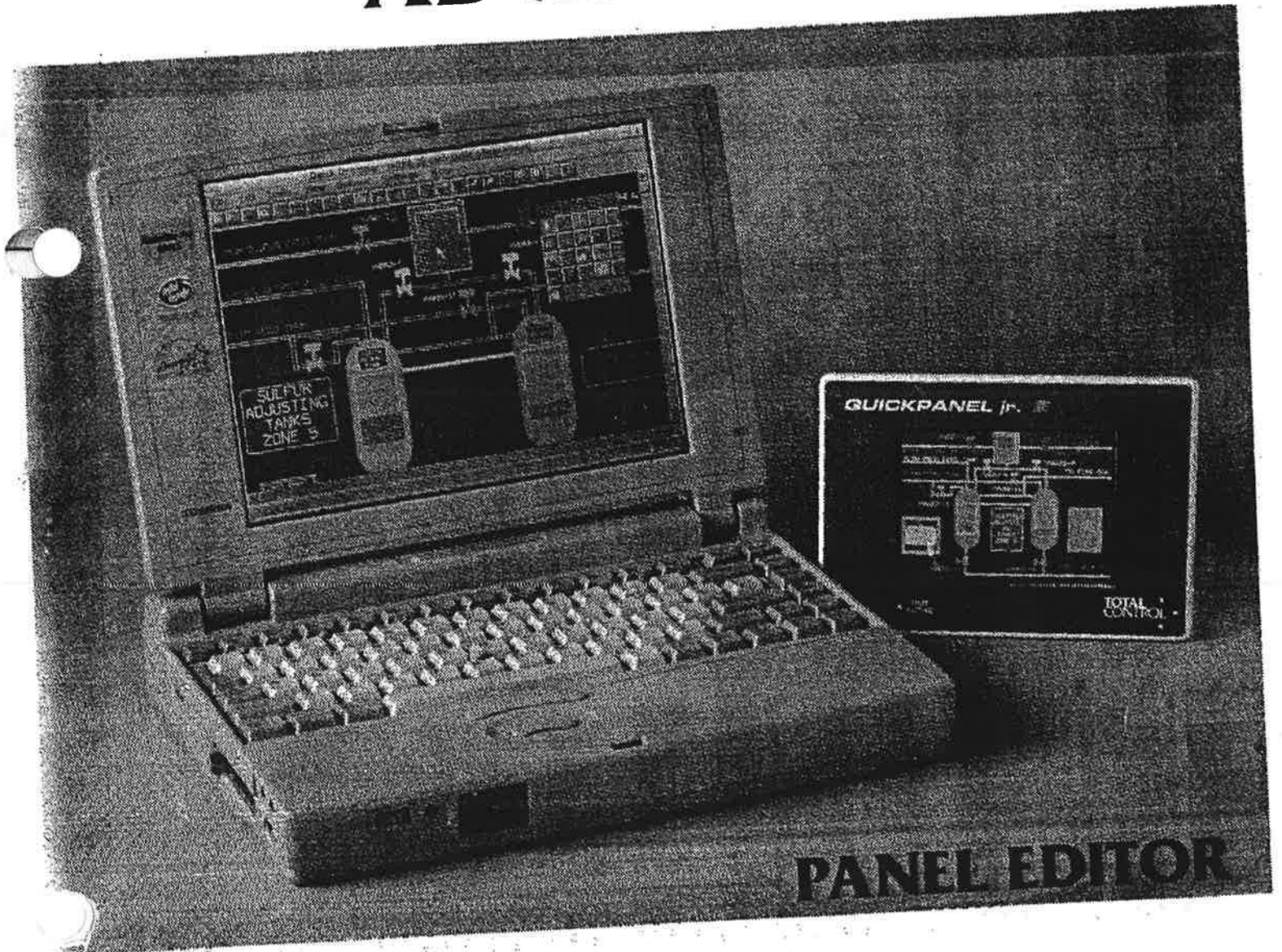


MAKE SURE THE POWER IS OFF

- Remove the protective cover on the DC terminal strip. Remove 1/4" of insulation from the supply wires and insert them under the terminal clamps. Tighten the clamp screws to secure the wires. Replace the protective cover.

**TOTAL
CONTROL**

**QUICKDESIGNER
ADVANCED**





44

QUICKDESIGNER

Panel Editor User Manual



**TOTAL
CONTROL**

Panel Editor User Manual
800-1000-091
Revision A
Version 3.1

This manual was produced by Total Control Products, Inc., Melrose Park, Illinois,

Copyright 1995, Total Control Products, Inc. All rights reserved.
Manual design and implementation by Glenn Rodgers.
QUICKDESIGNER splash screen by Dan Schless.

The following are trademarks of Total Control Products, Inc.: *QUICKPANEL*™ and *QUICKPANEL jr.*™

Windows™ is a trademark of Microsoft Corporation.

Information in this document is subject to change without notice and does not represent a commitment on the part of Total Control Products, Inc. The software described in this document is provided under a license agreement. The software may be used or copied only under the terms of the agreement. Only one copy of the software may be made for a backup.

Total Control Products, Inc. makes no warranty, either expressed or implied, including but not limited to any implied warranties of merchantability or fitness for a particular purpose, regarding these materials and makes such materials available solely on an "as-is" basis.

In no event shall Total Control Products, Inc. be liable to anyone for special, collateral, incidental, or consequential damages in connection with or arising out of purchase or use of these materials. The sole and exclusive liability to Total Control Products, Inc., regardless of the form of action, shall not exceed the purchase price of the materials described herein.

No part of this manual may be reproduced or transmitted in any form or by any means, electronic or mechanical, including photocopying, recording, or information storage and retrieval systems, for any purpose other than the purchaser's personal use, without the express written permission of Total Control Products, Inc.

The following logo is registered to Total Control Products, Inc.

**TOTAL
CONTROL** ■ ■ ■

Total Control Products, Inc.
2001 N. Janice Ave., Melrose Park, IL 60160 USA
Phone (708) 345-5500 FAX (708) 345-5670

Contents

Introduction	1
Panel Editor	1
Basic Panel Objects	2
Core Components	2
Bezel	3
Legend plate	3
Lens	3
Data Display	3
Installation	4
Notes	4
Basic Requirements	4
Backing up and Restoring your data	5
Installing Quick System	5
Installation Procedures	5
Starting QUICKPANEL Editor	5
Technical Support	5
Quick Tour	6
Overview	6
Quick Project Setup	7
New Project	7
Project Setup	10
QUICKDESIGNER	11
Create a Panel	12
Push Button Tag Variable	12
Pilot Light Tag Variable	12
Bezel	13
States	13
Action	14
Tags	14
Download Panel	15

QUICKMANAGER

	17
QUICKMANAGER Window	17
Menu Bar	17
Tool Bar	18
Menu Buttons	18
Project File List	18
Status Bar	18
Project Menu	19
Project - New	19
Project - Setup	20
Display Button	22
Touch Button	22
Print Button	23
Port Button	24
Protocol Button	24
System Button	25
Project - Delete	26
Project - Store Project in QuickPanel	27
Project - Download	27
Project - Upload	27
Project - Compile to File	27
Project - Download from File	27
Project - Import	28
Project - Export	28
Project - Print	28
Project - Print Setup	32
Project - Exit	32
Changing Panels	32
Components Menu	34
Panels	34
Tags	35
Alarms	35
Options Menu	36
Preferences	36
Window Menu	36
Toolbar	36
Status Bar	36
Buttons	36
Active Window	36
Help Menu	37
Index	37
Using Help	37
About	37
QUICK Help	37
Error Message	37
Project in Use	37

Tags

	40
Introduction to Tags.....	40
Selecting Tags.....	41
Tag Buttons.....	41
Add Tag.....	42
Delete Tag.....	42
UnDelete.....	42
Purge.....	43
Tag Attributes.....	45
Tag Validation.....	45
Tag Import.....	45
Tag Export.....	45
Close.....	45

Internal Tags

	46
Introduction to Internal Tags.....	46
Review of Tags.....	46
Internal Tags.....	46
System Tags.....	47
System Variables.....	47
Clock System Variables.....	48
Date System Variables.....	48
Contrast System Variable.....	48
Communication Status.....	48

Alarms

	49
Introduction to Alarms.....	49
Bit and Word Address Tags.....	50
Alarms Configuration.....	51
File menu.....	51
File Menu Buttons.....	51
File - New (Word or Bit).....	51
File - Open.....	52
File - Save.....	52
File - Save As.....	52
File - Delete.....	52
File - Import.....	52
File - Export.....	52
File - Configuration.....	52
File - Close.....	52

Edit Menu	53
Edit Buttons	53
Edit - Add	5
Maximum Alarms in a Project	55
Edit - Delete	55
Entering and Editing Alarm Messages	55
Edit - Cut Message	56
Edit - Copy Message	56
Edit - Paste Message	56
Edit - Free Form Addressing	56
Config Button	56

Alarms Guided Tour

	61
Introduction	61
Create the Alarm Table	62
Alarm Configuration	63
Selecting the Message Format	63
Configuring the Alarm Queues	64
Selecting Advanced Settings	64
Creating the Alarm Window	66

QUICKCOURIER

	68
Introduction to QUICKCOURIER	68
Download Files	68
Download Operation	69
Setup for a Download/Upload	69
Target Display Condition	70
Download Cable	70
Compiler	70
QUICKCOURIER	71
Communication Problems	72
Download Trouble Shooting Guide	73

QUICKDESIGNER

	74
QUICKDESIGNER Window	74
Menu Bar	74
Button Bar	75
Status Bar	75
Right Mouse Button	75

Creating a Panel	76
Tool Box	76
Dialog Box	77
Sizing an Object	77
Editing the Object	78
Grouping objects	79
Object Tag Display	79
Keypad Tag Display	79
Changing the Window View	80
Panel Preview	80
Menu Commands	84
File Menu	87
Edit Menu	87
Tools Menu	90
View Menu	92
Options Menu	93
Settings Menu	94
Help	96
Contents	96
Getting Started	96
Learning QUICKDESIGNER	97
About QUICKDESIGNER	97
Master Help	97

98

Library Tour

Library Browser

101

Quick Designer Library Window	101
Library	102
New	102
Edit	103
Cut	103
Copy	103
Paste	103
View	103
Toolbar	103
Browser Properties	104
Drag 'n Drop	104
Appearance	105
Text Colors	105
Folder	105
New Folder	105
Transfer	106
Delete Folder	106
Folder Properties	106

Object	106
Transfer Object	106
Delete Object	10
Object Properties	107
Right Mouse Button Options for Objects	107
Right Mouse Button Options for Folders	108

Polyline Tool

109	
Creating a Polyline Drawing	109
Moving a Polyline Object	110
Editing Nodes	110
Sizing a Polyline Object	111
Cautions	111
Polyline Settings	111

Text Tool

113	
Creating Text	113
Moving Text	113

Bitmap

114	
Creating a Bitmap	114
Horizontal Justify	115
Vertical Justify	115
Options	115
Bitmap Statistics	115
Edit	116
Import	116
Export	116
OK	117
Cancel	117
Make Default	117
Help	117
Bitmap Size	117
Notes	117

Circle Tool

119	
Creating a Circle	119
Moving a Circle	119
Sizing a Circle	119

Rectangle Tool

120	
Creating a Rectangle	120
Moving a Rectangle	120
Sizing a Rectangle	120

Legend Plate	121
Creating a Legend Plate	121
OK	122
Cancel	122
Make Default	122
Examples	122
Push Button	123
Creating a push button	123
Tag Variable	124
Action	124
Style	126
Bezel	126
Legend Plate	127
OK	127
Cancel	127
Make Default	127
Advanced Button	127
Help	127
Illuminated Push Button	128
Creating an Illuminated Push Button	128
Push Button Tag Variable	129
Action	129
Pilot Light Tag Variable	129
Bezel	130
States	130
OK	130
Cancel	130
Make Default	130
Advanced Button	130
Help	130
Print Button	131
Creating a print button	131
Style	132
Bezel	133
Legend Plate	133
OK	134
Cancel	134
Make Default	134
Advanced Button	134
Help	134

Word Button

Creating a Word Button.....	135
Tag Variable	135
Style.....	136
Action	136
Mode	137
Value	138
Bezel.....	138
Legend Plate	138
OK.....	139
Cancel.....	139
Make Default	139
Advanced Button	139
Help	139

Pilot Light

Creating a pilot light.....	140
Tag Variable	140
Style.....	141
Standard Pilot Light.....	141
Circular Pilot Light	141
OK.....	142
Cancel.....	143
Make Default	143
Help.....	143

Local Message Display

Creating a Local Message Display	144
Tag Variable.....	144
States	145
Import.....	145
Export.....	146
OK.....	149
Cancel.....	152
Make Default	152
Help.....	152
Alarms and Prompts	152

Local Image Display **153**

Local Image Display	153
Creating States	153
Creating a Local Image Display	154
Tag Variable	154
PLC Value	154
States	155
OK	155
Cancel	155
Library	155
Help	155

Selector Switch **156**

Creating a selector switch	156
Number of Positions	157
Position Selector	157
Position Tag Variable	157
States	158
Bezel	158
Legend Plate	159
OK	159
Cancel	159
Make Default	159
Advanced Button	159
Help	159

Goto Panel Push Button **160**

Creating a Goto Panel push button	160
Panel Name	161
Using Goto Panel Buttons	161
Bezel	162
Legend Plate	162
OK	163
Cancel	163
Make Default	163
Advanced Button	163
Help	163

Numeric Data Display

164

Creating a Numeric Data Display	164
Tag Variable	164
Legend Plate	165
Data Format Settings	165
OK.....	165
Cancel.....	166
Make Default	166
Help.....	166

Numeric Data Entry

167

Creating a Data Display with Keypad Entry.....	167
Tag Variable	168
Trigger Tag.....	168
KeyPad Title Off.....	168
Input Range	168
Bezel.....	168
Legend Plate	169
Data Format Settings	169
Data Entry Panel.....	170
OK.....	171
Cancel.....	171
Make Default	171
Advanced Button	171
Help.....	171

Text Display

172

Creating a Text Display	172
Tag Variable	173
Legend Plate	173
Text Format Settings.....	174
OK.....	174
Cancel.....	174
Make Default	174
Help.....	174

Clock

175

Creating a clock display.....	175
Setting the target display time	176

Bar Graphs

177

Creating a bar graph	177
Tag Variable	178
Orientation	178
Face Plate	179
Scale	179
Simulate	179
OK	179
Cancel	180
Make Default	180
Advanced	181
Help	181
Examples	181

182

Trend

Creating a Trend Display	182
Face Plate	183
Time Axis	184
Scale Settings	184
Pens	185
OK	185
Cancel	185
Make Default	185
Help	185

186

Alarm Window

Creating an Alarm Window	186
Queue	187
Scroll Direction	188
Bezel	188
Legend	189
Text	189
OK	189
Cancel	189
Make Default	189
Advanced Button	189
Help	189
Using the Alarm Window	189

190

Analog Meter

Analog Meter	190
--------------------	-----

Keypads

Keypads Overview	194
Keypad Layout	194
Keypad Names	195
Assigning Keypads	195
Keypads and Numeric Data Entry	196
Keypads and Alarms	196
Simulating Panel Objects with Keypads	197
Keypad Assignments	197
Viewing Keypad Assignments	198

Appendix A

Compiler INI Settings	199
Format of the SSC.INI File	199
How to Read the Listings in This Document	200
Changing Settings	200
[ssc-option] Section Settings	200
[ssc-logger] Section Settings	201
[ssc-generate] Section Settings	202
Sample SSC.INI File	203

Appendix B

Character Map	204
---------------------	-----

Index

207

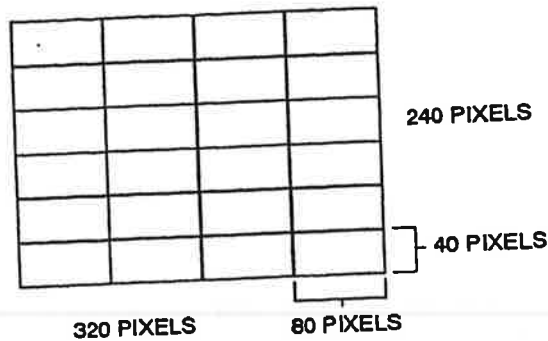
Introduction

Panel Editor

























Basic Panel Objects

A basic panel object is a push button, pilot light, illuminated push button, selector switch, or any type of operator control mechanism typically found on a control panel. The *QUICKDESIGNER* editor allows the novice Windows™ operating system user to easily create basic panel objects and group them in panels. When the design project is completed in Windows™, a project file is transferred to a target display. Using the editor and display combination, you can quickly create and modify a custom control panel for a PLC control application.

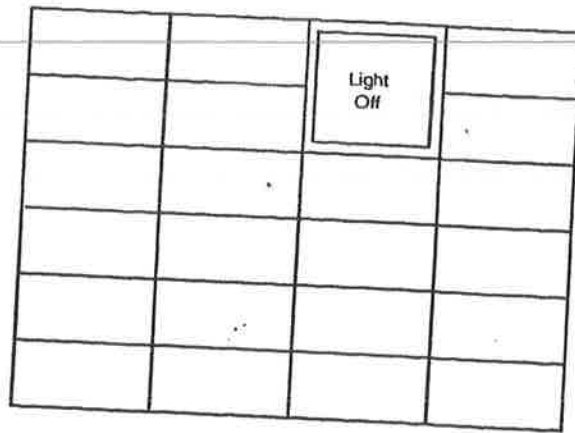
The *QUICKPANEL jr.* display is 320 x 240 pixels, which is divided into 24 cells of 80 x 40 pixels. The *QUICKPANEL*, Series A display is 640 x 400 pixels, which is divided into 80 cells of 80 x 40 pixels. The *QUICKPANEL*, Series B display is 640 x 480 pixels, which is divided into 96 cells of 80 x 40 pixels. The *QUICKPANEL jr.* display is shown below. The size of the cells and the grid can be changed. The grid is an aid for placing objects on the panel.



The editor presents you with a group of panel object design tools. You simply select one of the tools from the tool box and place it on the screen. Some objects require a PLC word or bit to make them active. Some objects are for internal use, such as the GOTO panel, which is used to move from one panel to another. The pointer is a special tool, used to select objects already on the screen.

- | | | | | | | | | | |
|---|-------------------------|---|--------------|---|-----------------|--|-----------------|---|---------------|
|  | Pointer |  | Bitmap |  | Legend Plate |  | Push Button |  | Analog Meter |
|  | Illuminated Push Button |  | Word Button |  | Pilot Light |  | Message Display |  | Image Display |
|  | Selector Switch |  | Goto Panel |  | Numeric Display |  | Numeric Entry |  | Print Panel |
|  | Text Display |  | Time Display |  | Bar Graph |  | Alarms |  | Trend |
|  | Polyline |  | Circle |  | Rectangle |  | Text | | |

In the beginner mode, the editor draws the object in a two cell field. The objects can be resized to suit the panel design. In the following drawing, a Pilot Light object has been placed on the panel.



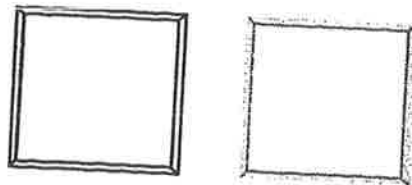
Once the object appears on the screen, an edit dialog box appears. In the case of the Pilot Light, you can change the text size and color, change background and outline color, and assign a discrete bit in PLC memory to control the light.

Each type of object can be customized to fit a wide range of applications. It therefore becomes very easy to place an object on the screen, modify it for your application and load the project into a target display.

Core Components

Core components are the basic building blocks that will allow you to configure the *QUICKDESIGNER* objects. These core components are used in the creation of the basic objects like push buttons, pilot lights, illuminated push buttons, and selector switches.

Bezel



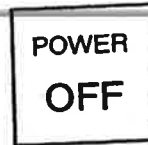
The bezel presents a visual indication to the operator that the button has been pressed. The bezel, bezel outline, and touch color can be changed to suit your application. The above example shows the bezel in two colors. A bezel is used with a touch button such as Push Button, Illuminated Push Button, Goto Panel Button and Numeric Data Entry Button.

Legend plate



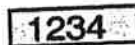
The legend plate is used to provide text information to the operator. The text size can be changed, and the text will automatically center itself both vertically and horizontally. The text color, background color and outline color can be modified for your application. Legend plate information is static. Legend plates are used with Legend Plates, Push Buttons, Goto Panel Buttons, Numeric Data Display Buttons and Numeric Data Entry Buttons.

Lens



The lens presents a visual indication to the operator of the current status of a bit in the PLC. The lens is typically presented as a pair of functions, usually an OFF lens and an ON lens. Text in the lens is used to describe to the operator what the bit status means. Text size is variable and will automatically center itself both vertically and horizontally. The text color, lens color, and outline color can be changed to suit your application.

Data Display



A numeric readout provides a mechanism to display the numeric contents of PLC data registers.

Installation

Notes

Basic Requirements

1. MS-DOS 5.0 or greater.
2. 386SX or better CPU, 4.0 Mbytes RAM, 17 Mbytes (full install) of free disk space.
3. Basic knowledge of how to use the Microsoft Windows™ operating system.
4. Microsoft Windows™ 3.1 running in 'Enhanced Mode'. You may interrogate the mode by inspecting the ABOUT box of the Program Manager. If you are currently running in Real or Protected mode, exit Microsoft Windows™ and start it up by typing WIN /3 at the DOS prompt (typically C:\>).
5. SHARE.EXE supplied with MS-DOS™. (The installation will add SHARE.EXE to your AUTOEXEC.BAT file)

Backing up and Restoring your data

If you are upgrading your QUICKDESIGNER software, your data files will not be changed.

We recommend that you backup your data files often. If someone were to steal your computer or if your hard drive breaks down, you will have a 'backup copy' of your important data files. You can use the project export feature to copy complete project data to a floppy disk.

You may also backup your data by copying the files in your data directory to a safe place. A simple backup procedure from DOS would be to copy all the files from the data directory to a floppy disk. For example: "copy C:\QUICK\DATA*.* b:\ /v".

To restore the data, simply copy the data files from the floppy disk back to your data directory. For example: "copy B:*.* C:\QUICK\DATA /v".

If you are familiar with the 'MS-Windows™ File Manager' you may use it to 'copy' your files, too. For more information about the 'MS-Windows™ File Manager' consult your MS-Windows™ documentation.

Installing Quick System

Installation Procedures

1. Start Windows™ (type "win" at the DOS prompt).
2. Insert Disk 1 into drive A or B.
3. Open the Program Manager File menu and choose the Run command.
4. Type A:setup (type B:setup if you are using drive B) in the Command Line text box.
5. Press ENTER or click OK to start the installation.
6. Follow the instructions on the screen. The installation wizard will guide you through the install process.

The installation program allows for complete or custom installation. The custom installation allows you to select only the display device(s) and PLC drivers you need. A custom installation typically requires about 12 Mbytes. The custom installation may not use all the disks in the distribution set.

Starting QUICKPANEL Editor

To start the *QUICKPANEL* editor:

1. Start Windows™ (type "win" at the DOS prompt).
2. Open the Program Manager and locate the Total Control Products program group.
3. Double-click the group icon. When the Total Control Products window opens, double-click the QUICK icon.
4. Click the Help menu and select the About option. The About box will contain the software serial number. Transfer the serial number to the registration card, complete the registration card and mail it to Total Control Products, Inc.
5. Go to the Quick Tour section for a tutorial. (Quick Tour is the next section)



Please fill out and mail in your registration card.

Technical Support

QUICKPANEL technical support phone number: (708) 345-5730. FAX: (708) 345-5670.
BBS: (708) 345-5880. Select area 8 for QUICKPANEL information.

Quick Tour

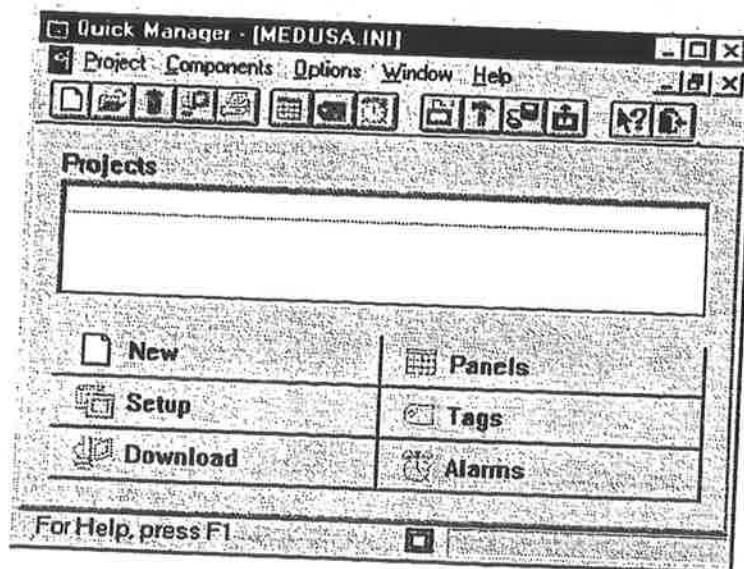
Overview

The Quick Tour section is designed to take you through a simple project using a Modicon PLC and a *QUICKPANEL jr.* as the target display. This project contains the basic elements of all projects. You can substitute your PLC type for those instances where Modicon is used. You will be shown most of the dialog boxes but only a few require any input or changes.

We strongly suggest that you read the Quick Tour section and attempt a simple project. Make sure you are able to design a simple panel and download it to the target display. When you have the target display communicating with your PLC, then proceed to designing more panels. You should download each panel and test it before designing the next.

Quick Project Setup

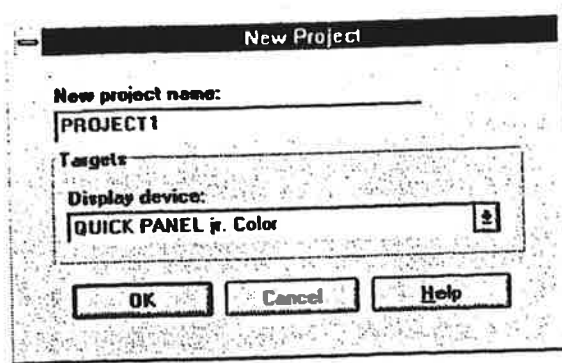
Click the *Quick* icon to start the editor. The following dialog is displayed. We assume this is the first time you are using the software and there are no projects previously created.



Note that there are no projects listed in the window and several menu buttons and tools are greyed out (inactive). Click the New button to display the New Project menu.

New Project

The New Project dialog is used to enter a title for a new project and pick a target display device.



Type "PROJECT1" for the project name and press TAB to move the cursor to the Display device pull-down selector (the down arrow to the right of the text field).

Select **QUICKPANEL jr. Color** as the display device. If your target device is different, select it from the display device list. This example assumes you are using the *QUICKPANEL jr. color* display.

Click OK and the Project Setup dialog will appear.

Project Setup

The project name will appear in the project name text field at the top of the dialog box. You can change it by typing a new name. If you click the More button, the Additional Project Setup dialog box will appear. The Additional Project Setup dialog box is used to enter the Author name and project notes.

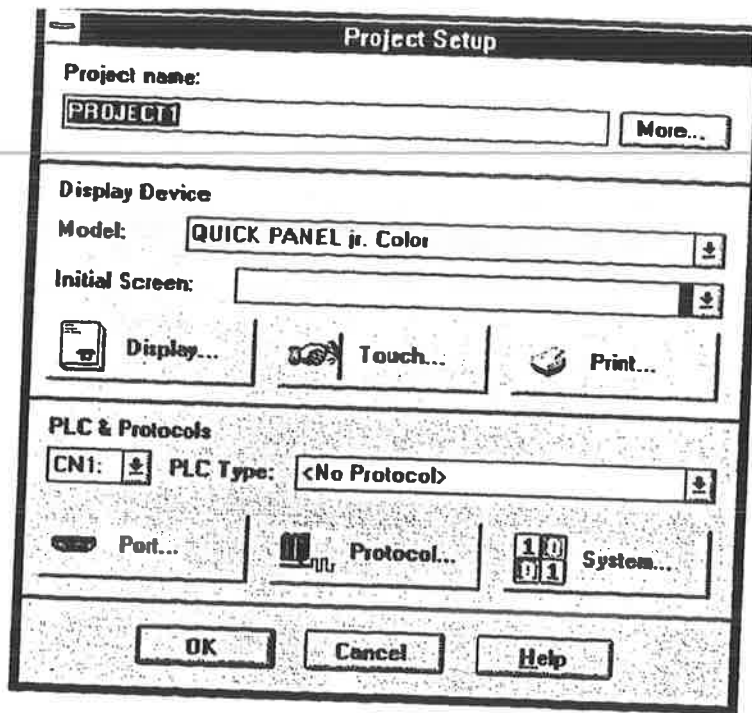
The next section of the Project Setup dialog box is labeled Display Device. The model selected is shown in the Model list box. You can change the display device by clicking the down arrow button and picking a new target display.

The Initial Screen is the first panel displayed when the power is cycled. Leave this blank for now.

The Display button brings up the Display Configuration dialog box, which is used to select the initial screen and the Screen Saver timeout. The initial screen is the one that appears after a power cycle. Screen saver timeout is a timer that starts after someone touches the screen. If the screen is not touched again before the timeout period, the screen goes blank. A setting of 0 will keep the display on constantly. Click Cancel.

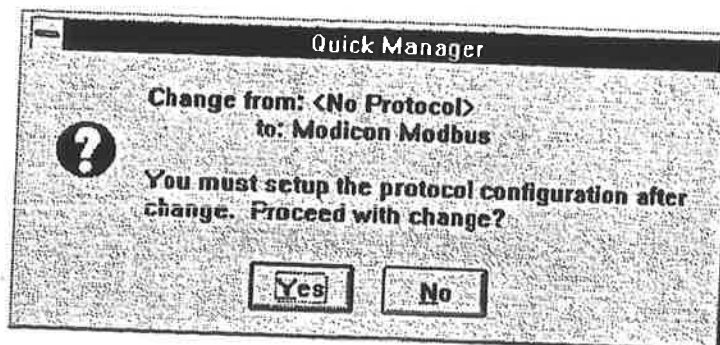
The Touch button brings up the Touch Screen Configuration dialog box. You can turn the beeper ON(Enable) and OFF(Disable). (You may want to turn it OFF when using the display in an office environment). Click OK. The Touch button is also used to enable the operation of the external keypad.

The Print button sends the panel image to a printer. Leave this alone for now.

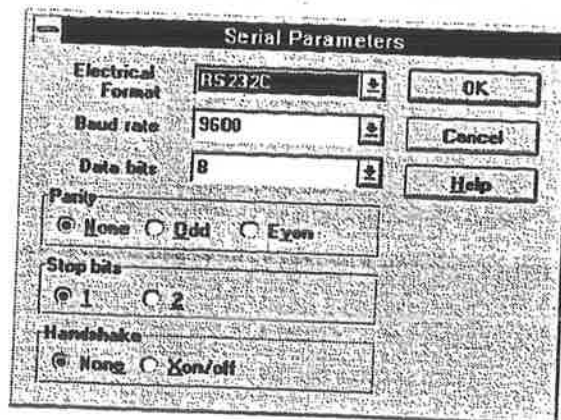


The next section of the Project Setup dialog box is labeled PLC & Protocols. This section is used to select the PLC protocol and setup the communications for the display. There is only one choice for the main serial interface port, which is designated SIO/CN1. Click on the down arrow located on the right side of the PLC Type field to display a list of PLC types. Click on Modicon Modbus.

When you change protocols, the following prompt is displayed. The prompt reminds you that the protocol you have just selected must be setup after the change. Click Yes to acknowledge the prompt.

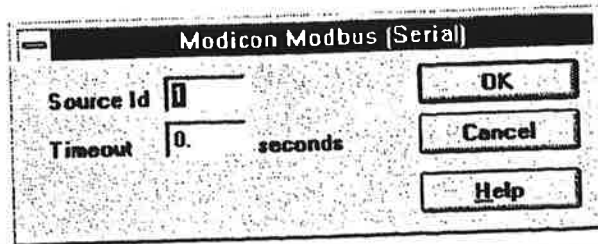


Click the Port button to setup the main serial port (CN1) on the display. The Serial Parameters dialog is displayed. This dialog box is one of the most important, because it defines the communication settings between the display and your PLC.

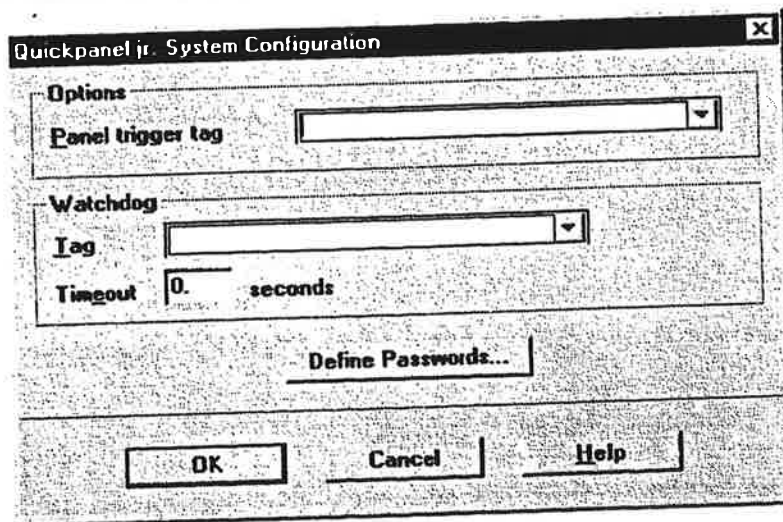


The settings **MUST** match those of your PLC. The settings shown in the dialog box are *default* settings and may not be correct for your project. When you start a real project, you may want to write down the settings and verify they are the same as those on your PLC. Click OK.

Click the Protocol button to setup the optional parameters for a particular PLC type. These parameters **MUST** also match those of your PLC. The settings shown in the dialog box are *default* settings and may not be correct for your project. The Modicon Modbus dialog box is shown below. Click OK.



Click the System button to open the System Configuration dialog box.

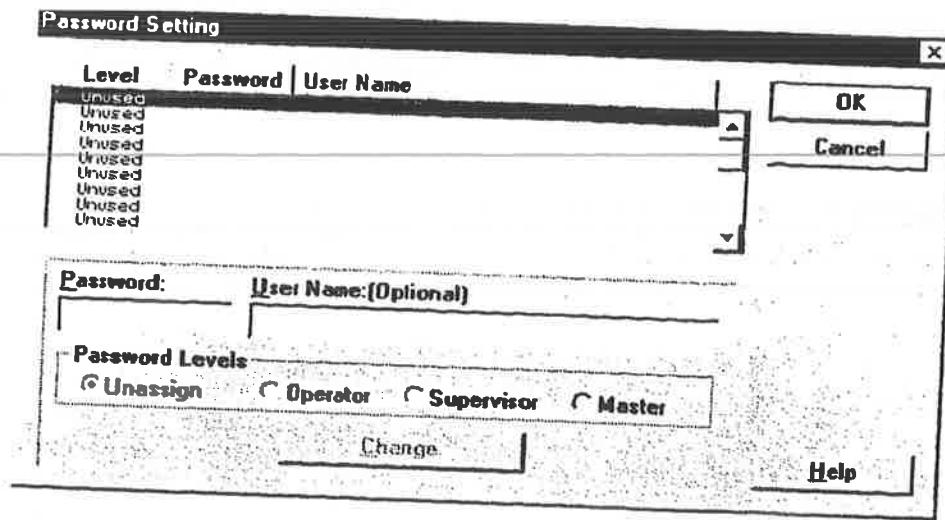


The panel trigger tag allows a register in your PLC to control the selection of panels. You can allow the operator to select panels, the PLC to select panels, or a combination of the two.

The watchdog is a register in your PLC that is periodically checked to determine if the communication link is still operational. Each timeout period, the display sends a value to the watchdog register. The PLC waits for a specified period, then checks the contents of the register. If there is a value in the register, the link is working. The PLC then clears the register and begins waiting again. The watchdog operation requires some PLC ladder logic for proper operation.

Pressing the Define Passwords button will display the Password Setting dialog box. You can password protect one or more panels in a project. You can setup passwords for up to 16 users. The password is a numeric value from 0 to 65535 with up to three levels of security. For each protected panel in a project, a security level of Operator, Supervisor, or Master is selected. During run time when a protected panel is selected, a numeric data entry panel is displayed prior to accessing the panel. A proper numeric password must be entered which is equal to or greater than the assigned security level, otherwise access is denied. The Master level can access all panels.

To assign a password, select an unused line, enter the password and optional user name, select a password level, then click the Change button. Edit the password by selecting the line, making required changes and clicking the Change button. Remove password assignments by selecting a line, select Unassign and click the Change button.




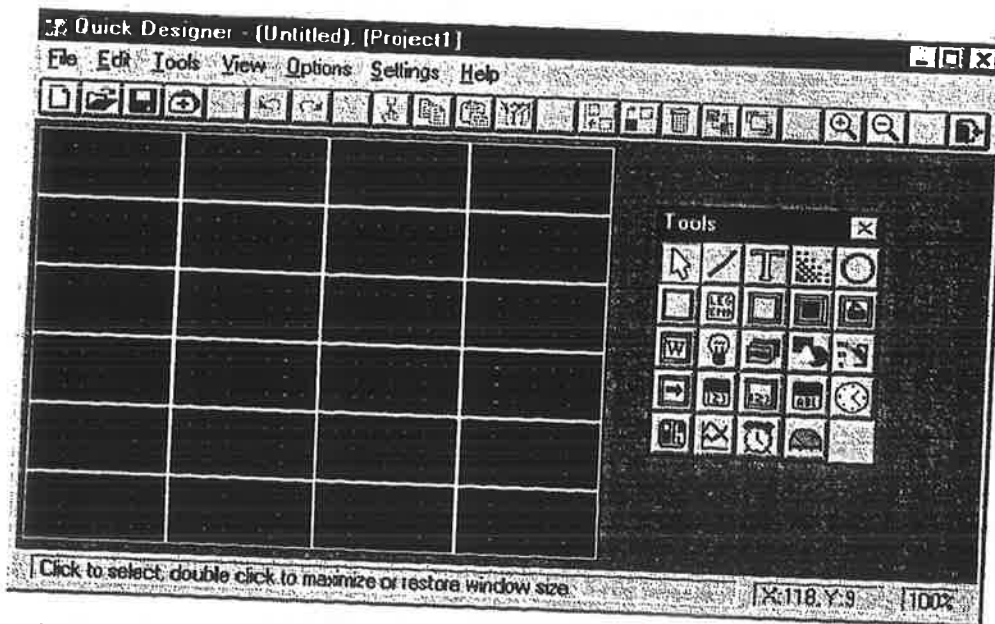
To set the password for a single panel, open the panel then go to the Settings menu and select Panel. The Panel Settings dialog will appear. From the Password Level list box, select No Password, Operator, Supervisor, or Master. More information about assigning passwords can be found in the QuickDesigner section under Settings menu.

You are now done with the Project Setup dialog so click the OK button to return to the QUICKMANAGER dialog.

QUICKDESIGNER

The project now has a title and the necessary configuration information. The next step is to design the panels for the project. Click the Panels button to open the QUICKDESIGNER panel editor window.


You can also click the panels icon  on the toolbar.

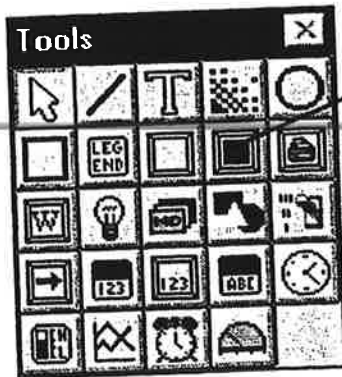


The panel editor window opens with a new panel ready to edit. The panel size depends on the type of display you selected in the setup dialogs. It is a good practice to save the panel as soon as you start working on it.

The first time you open the *QUICKDESIGNER* panel editor menu, the Tools menu may be placed on the grid. Place the cursor over the title of the tool box (Tools), click and hold the left mouse button to move the Tools menu off the grid.

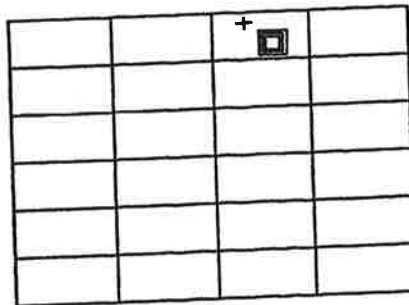
Create a Panel

Click the illuminated push button icon  on the Tools menu or select the illuminated push button from the Tools pull-down menu. The status line at the bottom of the screen will indicate which tool you have selected. The illuminated push button is a combination push button and pilot light.

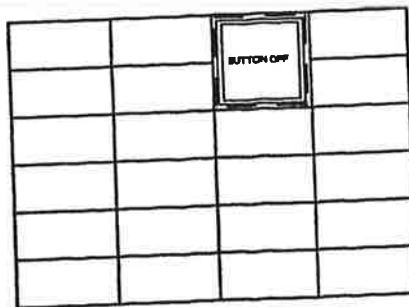


Illuminated Push Button

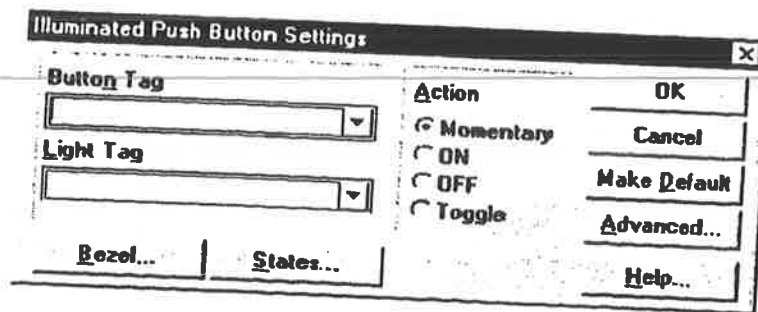
Move the arrow cursor into the grid area. A cross hair will appear with a small image identifying the type of tool selected. Move the cross hair to the cell shown in the drawing and click the mouse. Note the message in the status line at the bottom of the window.



The illuminated push-button object will appear across two cells.



The Illuminated Push Button Settings dialog box will also appear.



Push Button Tag Variable

The illuminated push button consists of two parts; the push button and the pilot-light indicator. When the button is pushed, it changes a bit in a PLC word. Generally, the pilot light is assigned to monitor the bit controlled by the push button.

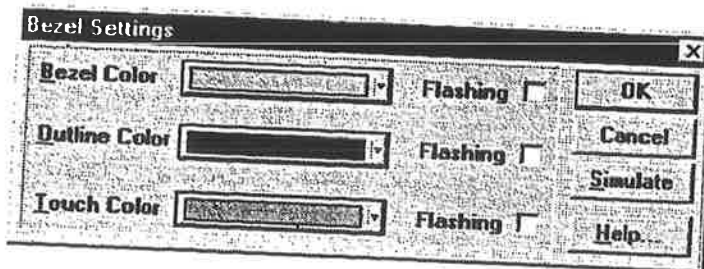
A "tag" variable name must be assigned to the push button. This tag will be a single discrete bit in the PLC memory that the target display can control. Type OD0100 for the button tag and press TAB.

Pilot Light Tag Variable

A "tag" variable name must be assigned to the pilot light. This tag will be a single discrete bit in the PLC memory that the target display can read. When the bit is ON the pilot light is ON. Type OD200 for the Pilot Light tag and press TAB.

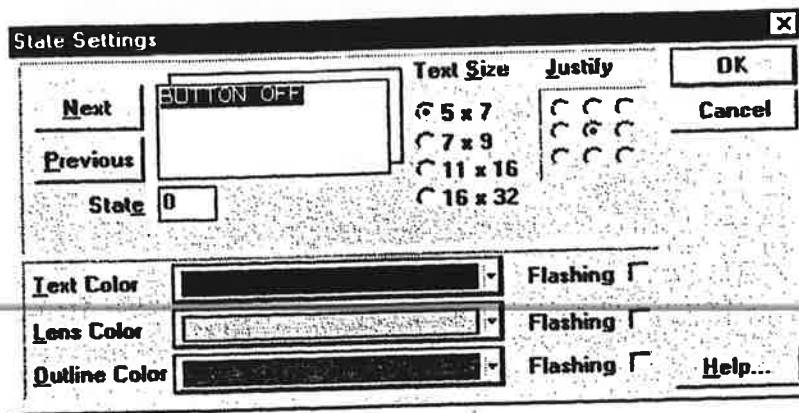
Bezel

The Bezel portion of the push button presents a visual indication to the operator that the button has been pressed. Click the Bezel button to display the Bezel Settings dialog. Click the Simulate button to see how the bezel changes colors. Click OK to return to the main push button dialog.



States

Click on the States button to display the State Settings dialog. A push button has two states; ON and OFF. You can change the text and appearance of each state. Use the Next and Previous buttons to select a different state. The last state selected will be the one displayed when you click the OK button. Click OK to return to the main dialog.




Action

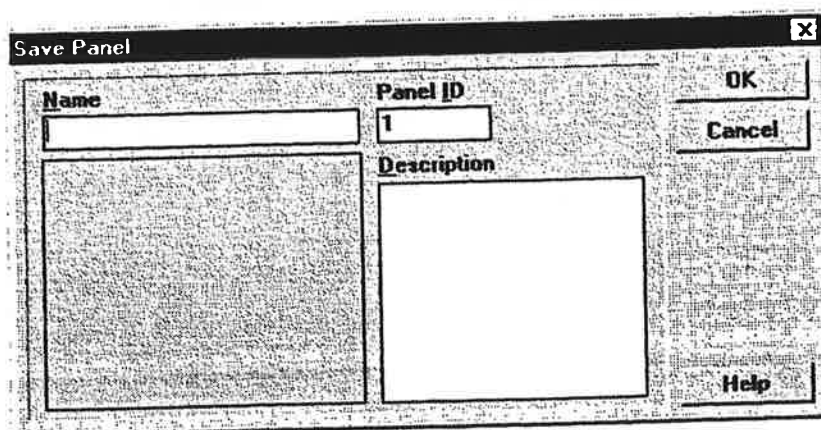
The manner in which the push button tag will be controlled is defined by selecting an "Action". A common action is toggle, where the PLC bit (tag) is turned ON when the push button is pressed and turned OFF when the push button is pressed again. Click the Toggle button.

Action

- Momentary
- ON
- OFF
- Toggle

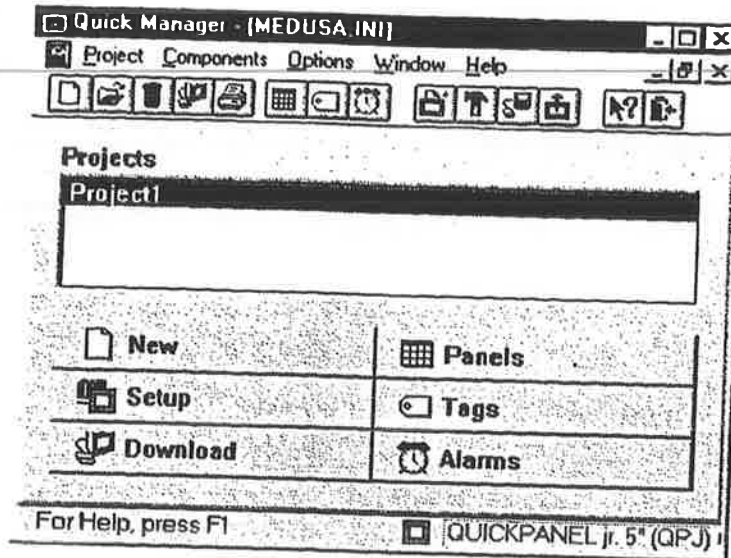
Click the OK button to save the illuminated push button settings.

Click the File menu and select Save from the pull-down menu, or click the save icon.  When the Save Panel dialog appears, type Panel1 for the file name.



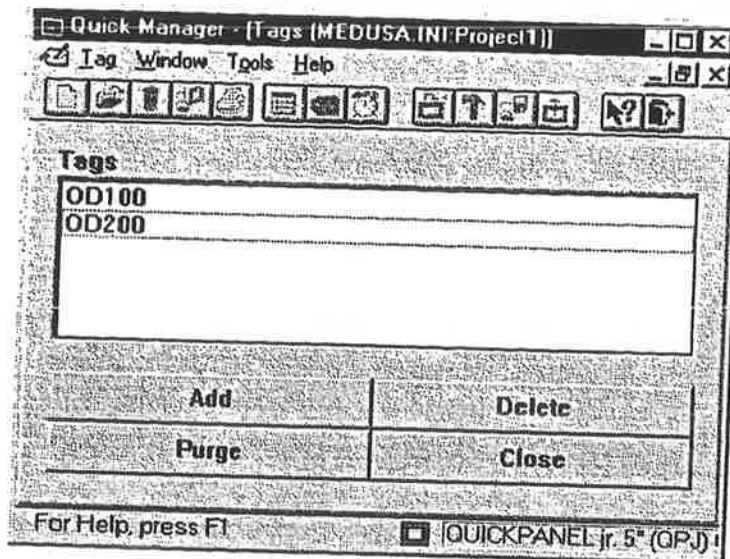
Press TAB until the cursor is located in the Description window. Type SINGLE ILLUMINATED PUSH BUTTON then click the OK button.

Click the File menu and select Exit. The *QUICK MANAGER* window will return.



Tags

The tags menu will allow you to view the tags created for the current project. You can easily add, delete, cut, paste, and copy tags. You can purge (delete) all of the tags from the current project. Click the Tags button for the following menu.




If you select Tag Attributes or double click one of the tag names, the Tag Attributes dialog will appear. Do not change any settings. Click OK to close the Tag Attributes dialog and return to the Tags dialog. Click the Close button to exit Tags.

Tag Attributes


Names		<input type="button" value="OK"/> <input type="button" value="Cancel"/>	
Tag	OD200		
Var	OD200		
Type		Ranges	
<input checked="" type="radio"/> Integer <input type="radio"/> Float <input type="radio"/> String Size <input type="checkbox"/> Period <input type="checkbox"/> 0.			
<input type="checkbox"/> Samples <input type="checkbox"/> Data File Number of elements <input type="checkbox"/>			
		Scale low	0.
		Scale high	1.
		Input low	0.
		Input high	1.

Download Panel

Before you attempt to download a panel, you must connect the HMI-CAB-C49 cable between an unused comm port on your computer and the target display.

Click the Download button or click the Download icon  to download the new panel design to the target display. The first operation that appears on the screen is the compiler (SSC), which compiles the selected project into code the target device can accept. (Your compiler display may look slightly different)

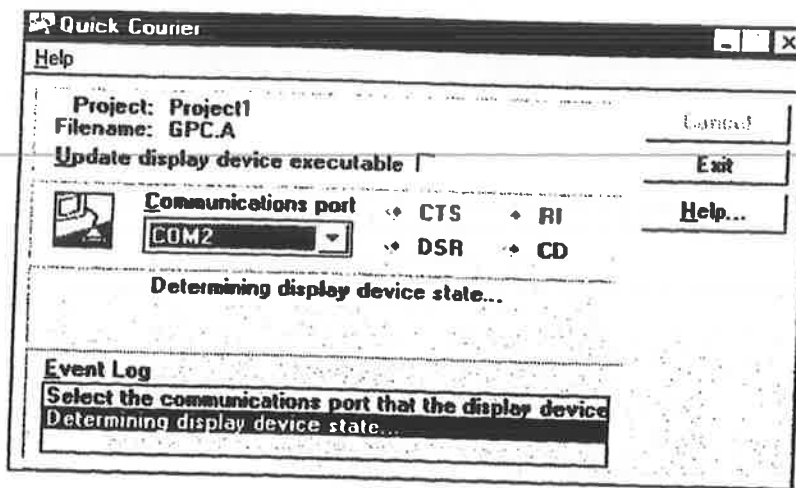
SSC

QUICKPANEL Compiler  1.06 <input type="button" value="Cancel"/>	Project: Project1 Display: QUICK PANEL jr. Monochrome Panel: BARGRAPH Tool: Goto Panel Button <div style="border: 1px solid black; width: 100%; height: 15px; background-color: black; position: relative;"> 47% </div>
--	--

When the compile operation is complete, the *QUICKCOURIER* menu is displayed.

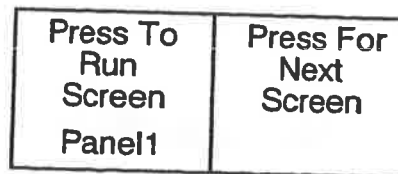
Follow the prompts which are displayed by *QUICKCOURIER*.

QUICKCOURIER will determine the condition of the display and begin loading the required files. A bar graph will display the loading progress.



Below the bar graph will be a display device status information box which gives you some general information about the display. The first time a version 1.06 (or later) bootstrap is loaded into a display, the currently loaded executable file and the version of the executable file will be blank. Free Space is an option that may not be active in this version.

When the application download is complete, *QUICK COURIER* will close and the *QUICK MANAGER* program will return. Since no default panel was selected, the display device will show the following prompt.



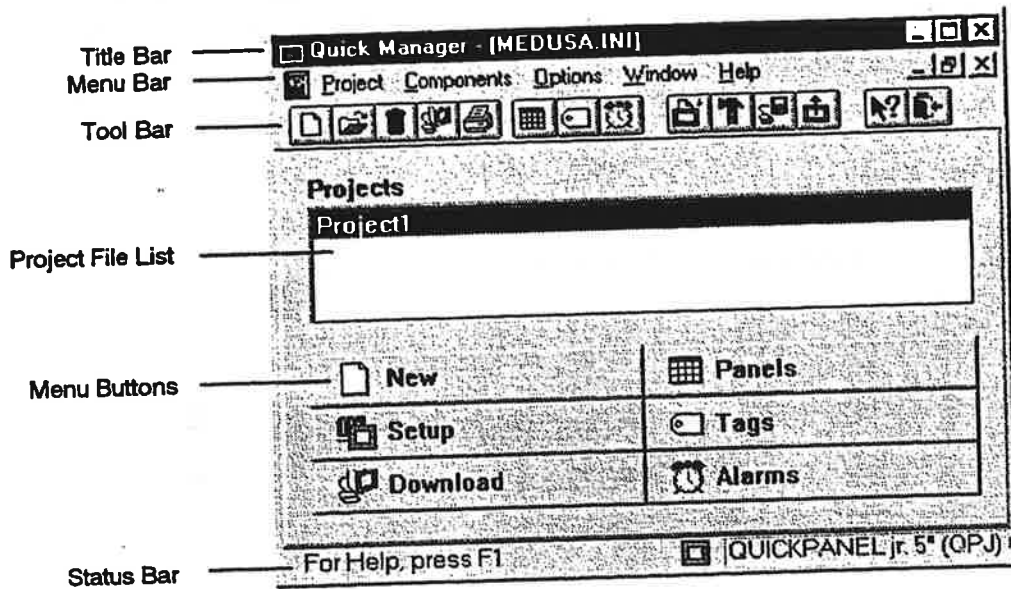
Press the left button to display Panel1. If you had a real Modicon Modbus PLC attached to the *QUICKPANEL jr.* display, the push-button would operate. Pressing the push-button would set OD0100 to a 1. In this tutorial, the ladder logic in the PLC is written so that setting OD0100 to a 1 will cause OD200 to also be set to 1. The Pilot Light tag variable for the push-button is tied to OD200, so it will go on. The push-button was selected to be a toggle type button. Pressing the push-button again will cause OD0100 to be set to 0 and OD200 to be set to 0. The pilot light section of the push-button will go out.

You had to read about ten pages of this tutorial in order to create your first push-button. It might have taken you about ten minutes to complete the exercise. Now that you are familiar with the operations, it should take you a minute or two to create another button or pilot light. Just think how much time and money you have saved! You can add an object to your control panel in less than two minutes with no wiring changes! That's *QUICKPANEL!*

QUICKMANAGER

QUICKMANAGER Window

QUICK MANAGER is used to set up a project file that contains the type of PLC used, the serial communications attributes, and other information required for a project. From the manager window you can jump to the panel editor, which is used to design panels. You can jump to the tag editor to add or modify the tag list. You can jump to the alarm manager to setup the alarm processor. When you have completed a project, you can click the download button to send the completed project to a target display. The *QUICK MANAGER* window is shown below.



Menu Bar

Windows™ commands are listed on menus. Menus are represented by names in the menu bar at the top of each application window. In Windows™, you select a menu, and then choose a command from that menu. Choosing the command carries out the action. The menu bar for the *QUICK MANAGER* is shown below.

Project · Components Options Window Help

The items listed on menus are most often commands that represent actions you can tell the application to carry out. Some menu items appear dimmed, some have check marks next to them, some may have ellipses (...) after their names, and others may have key combinations listed across from them.

Windows™ applications all follow certain conventions when listing items on a menu. These conventions signal that extra information about the menu commands will follow.

MENU CONVENTION

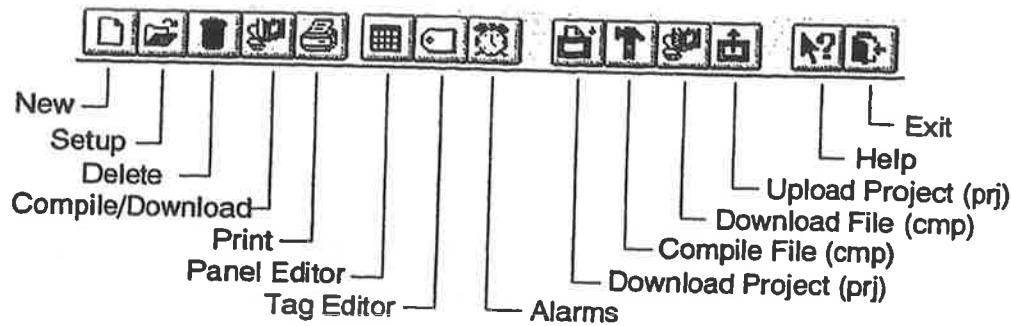
DESCRIPTION

- Dimmed command name The command is not available at this time.
- An ellipsis after the name A dialog box will appear.
- A check mark next to the name The command is active.
- A key combination after the name A shortcut for this command.
- A triangle at the right side The command leads to a cascading menu.

To choose an item from a selected menu, click the item name.

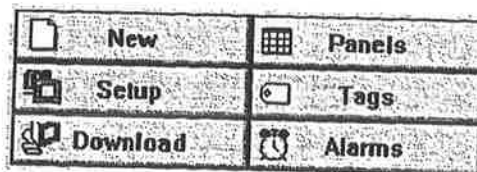
Tool Bar

The tool bar contains icons relating to frequently used commands found in the menu bar. By clicking an icon, you gain instant access to commands. The *QUICK MANAGER* tool bar is shown below.



Menu Buttons

The large menu buttons perform the same functions as the icons in the tool bar, except the buttons are easier to locate and identify their function. The menu buttons also resize when the window is resized. The *QUICKDESIGNER* menu buttons are shown below.



Project File List

The Project File List contains all the projects available to the *QUICK MANAGER*. You can create multiple projects, each with a different target display and PLC type. Projects can use panels from other projects by using the copy and paste functions.

Status Bar

The status bar displays operator prompts to aid you in using the manager and designer tools.

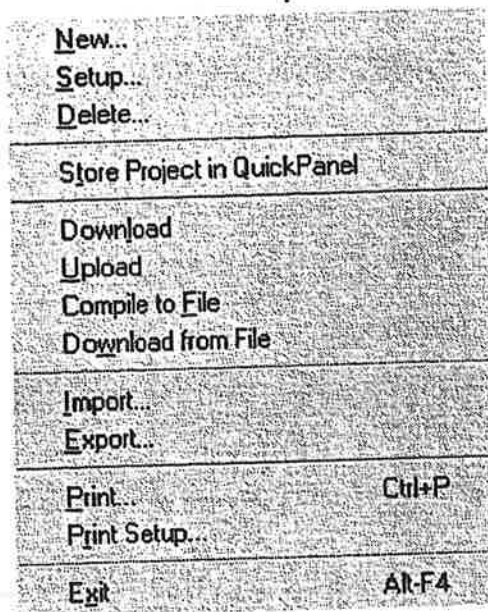
Project Menu

The project menu contains options for creating new projects, changing the setup for existing projects, deleting unwanted projects, and downloading projects to target displays. The import option allows you to use projects created on another system, while the export option allows saving an entire project. There are several new tools which are designed to make the process of compiling and downloading files easier and more flexible.


The new tool bar buttons have corresponding entries in the Project menu. Selecting *Store Project in QuickPanel* is the same as clicking the Download Project button on the tool bar. However, if you open the Project menu again, you will notice a check mark next to *Store Project in QuickPanel*. This indicates the option is enabled and will be reset the next time a compile is started.

The *Download* option is the same as before, where the current project is compiled and downloaded. *Upload* is the same as the Upload Project button, *Compile to File* is the same as the Compile File button and *Download from File* is the same as the Download File button. A description of these new items is found in the next section.

You can exit the project menu by clicking the exit option or by clicking the exit icon in the tool bar. Note that you can quickly exit the project menu by using the ALT-F4 key combination.



Project - New

There are three ways to start a new project; click the New icon  in the tool bar, select New from the Project menu, or click the New button.

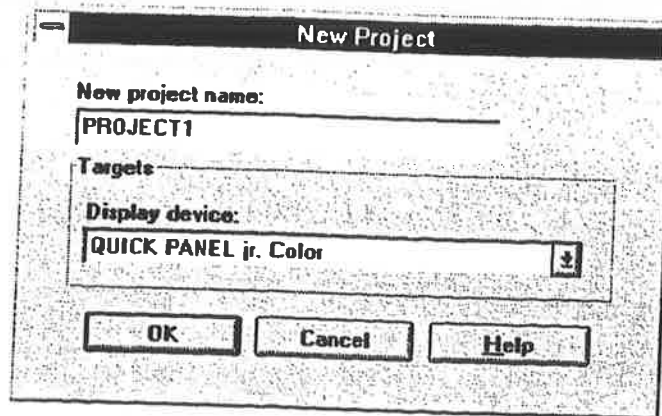
The New Project dialog box is shown below.

New Project Name


Enter the project name then use the TAB key to move to the Display device list box.

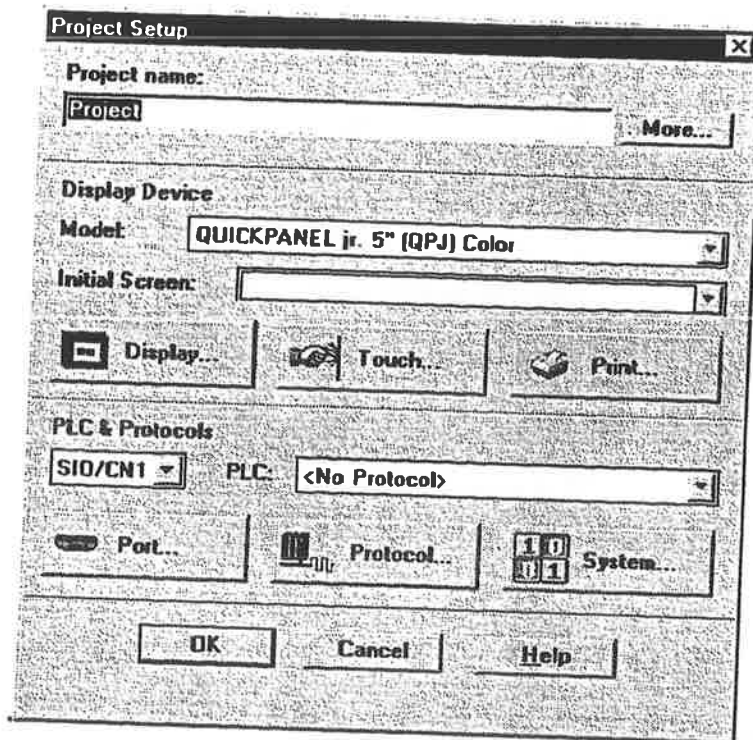
Display Device

Select a target display device by clicking the drop-down list box and selecting the target display type. Click OK to continue.



Project - Setup

The Project Setup dialog box can be selected in three ways; click the Setup icon  in the tool bar, select Setup from the Project menu, or click the Setup button.

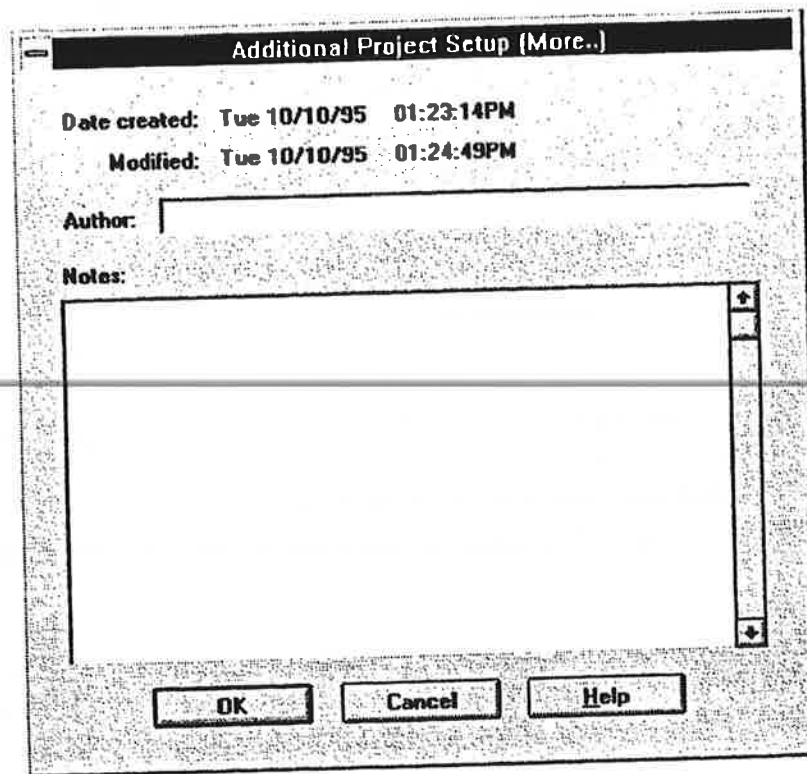


Project Name

The Project Setup dialog box will display the name of the project to remind you of which project you are working on. You can change the name of the project by deleting the old name and entering a new name.

More Button

If you click the More button, the Additional Project Setup dialog box will appear. This dialog box is used to enter the Author name and project notes.



Model

The Display Device section will indicate which target display model you selected for the current project. You can change the display device model by clicking the arrow button and picking a new target display. The following is a sample of the display list. The list changes for different versions of software.

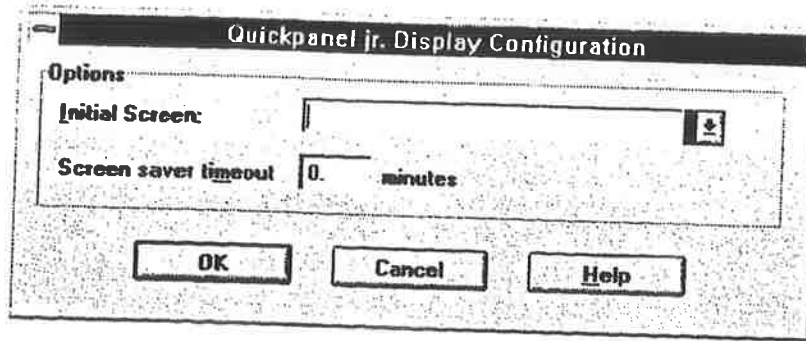
- | | |
|------------------------------------|---|
| QUICKPANEL jr. 5" (QPJ) Color | ↓ |
| QUICKPANEL 10.5" Color | |
| QUICKPANEL 10.5" LCD Monochrome | |
| QUICKPANEL 12.1" Color TFT | |
| QUICKPANEL 12.1" SuperTwist | |
| QUICKPANEL 6" HandHeld Color | |
| QUICKPANEL 6" HandHeld Monochrome | |
| QUICKPANEL 9" EL Monochrome | |
| QUICKPANEL jr. 5" (QPJ) Color | |
| QUICKPANEL jr. 5" (QPJ) Monochrome | |
| QUICKPANEL jr. 6" (QPK) Color | |
| QUICKPANEL jr. 6" (QPK) Monochrome | |

Initial Screen

The Initial Screen is the first panel displayed when the power is cycled. See Initial Screen in the next section.

Display Button

The Display button brings up the Display Configuration dialog box, which is used to select the initial screen and the Screen Saver timeout.



Initial Screen

This is the panel that will appear after a power cycle has occurred on the target display. When you first begin a project, this list box will be empty. If you know the name of the power-up panel, enter it now. You can come back to this dialog box after all your panels are completed. If you leave the *Initial Screen* entry blank, the target display will prompt the operator to choose a panel when the power is cycled.

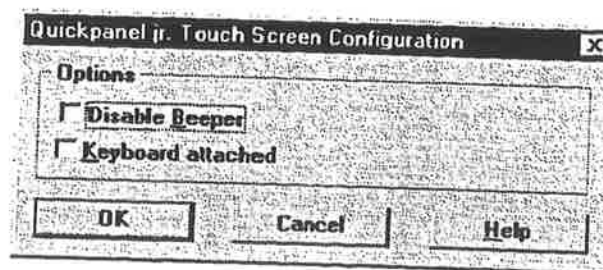
NOTE: If the *Initial Screen* name does not match a name in the drop-down list box, the display screen will go black after the panels are downloaded. Choose the initial screen name from the list box to insure you have the correct name. Panel names are case sensitive.

Screen Saver Timeout

The screen saver feature will turn off the screen after a selected time period. Simply touch the screen to turn the display back on. The touch will not affect panel objects. Enter the timeout period in minutes. The range is 0 to 255 minutes. A value of 0 (0=default) will force the screen to remain on.

Touch Button

The Touch button brings up the Touch Screen Configuration dialog box.



Disable Beeper

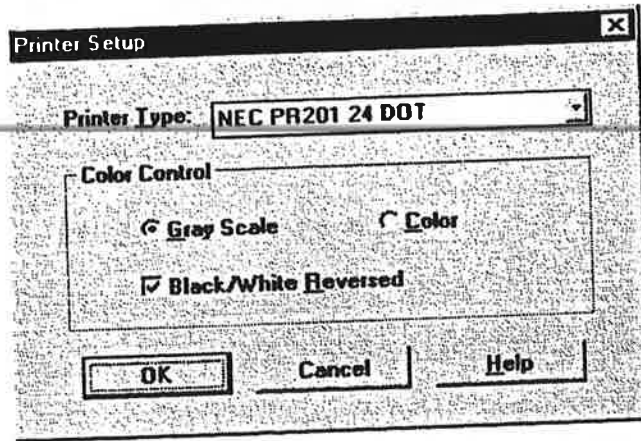
The beeper sounds each time an active screen operator is touched. You can disable the beep by checking the Disable Beeper checkbox. If you are developing a project in an office environment, it would be courteous to turn the beeper OFF.

Keyboard Attached

If you have installed an optional keypad such as the HMI-KPN-201, click this checkbox. If the display type you are using does not have an available keypad option, this dialog box message will appear disabled (greyed out).

Print Button

The Print button brings up the printer setup dialog box. Select the printer type from the list box. Other printers may work if they are compatible to one of the printers in the list box. See the Print option on page 28.



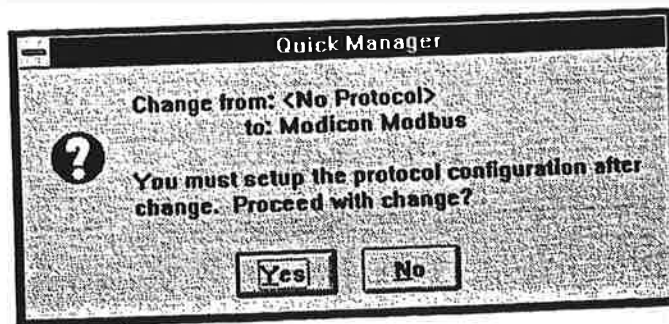
Port Selector

The port selector is a list box that indicates which port is currently being setup. This list box has only one entry now, but may have more in the future. The main serial port is generally called the CN1 or SIO port.

PLC Type

The PLC Type list box shows which protocol you selected for the current project. Click the down arrow on the right side of the list box to view the entire list of protocols. Select a new protocol by clicking on the desired name.

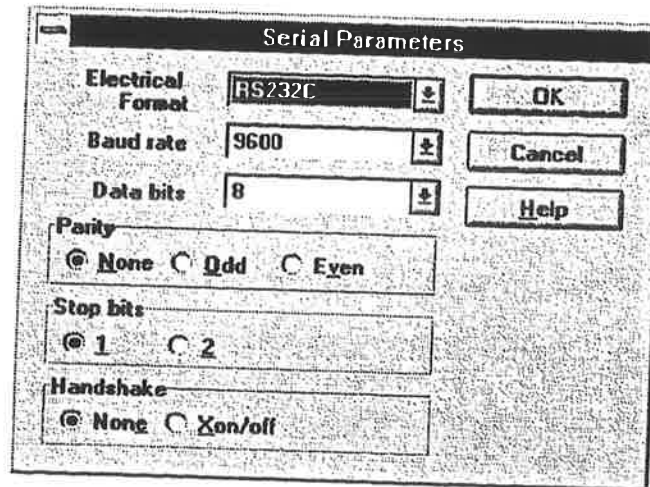
If you select a protocol different from the current protocol shown in the PLC Type list, the following prompt is displayed. The prompt reminds you that the protocol you have just selected must be setup after the change. Click Yes to acknowledge the prompt.



Port Button

The Port button will display the Serial Parameters dialog box. Select RS232 or RS422/485 Half or Full Duplex protocol for the target display serial port. Make sure the communication settings are the same as those for your PLC. The settings shown in the dialog box are default settings and may not be correct for your PLC type.

Make sure the target display and PLC have the same communication parameters. A majority of interface problems are related to improper communication settings and cables.



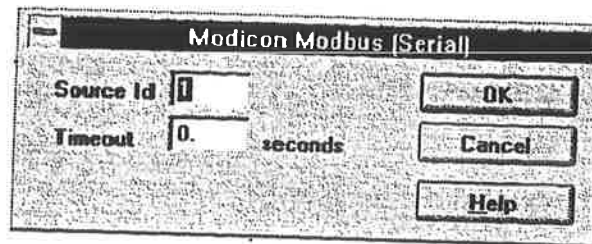
The image shows a dialog box titled "Serial Parameters". It contains several settings:

- Electrical Format:** A dropdown menu set to "RS232C".
- Baud rate:** A text input field set to "9600".
- Data bits:** A text input field set to "8".
- Parity:** Radio buttons for "None" (selected), "Odd", and "Even".
- Stop bits:** Radio buttons for "1" (selected) and "2".
- Handshake:** Radio buttons for "None" (selected) and "Xon/off".

On the right side of the dialog box, there are three buttons: "OK", "Cancel", and "Help".

Protocol Button

The Protocol button will display the unique protocol dialog box for the protocol selected in the PLC Type list box. Make sure the settings match those of your PLC. An example protocol is shown below. Each supported PLC has a dedicated chapter in the Communications User manual.



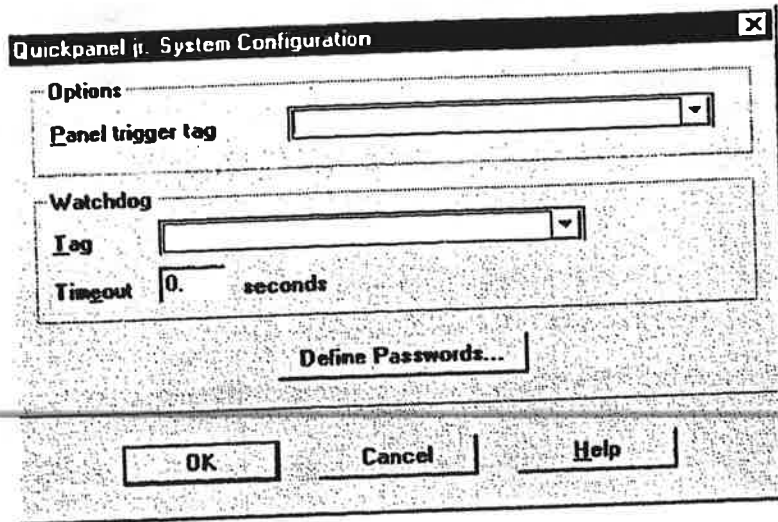
The image shows a dialog box titled "Modicon Modbus [Serial]". It contains two settings:

- Source Id:** A text input field set to "1".
- Timeout:** A text input field set to "0." followed by the label "seconds".

On the right side of the dialog box, there are three buttons: "OK", "Cancel", and "Help".

System Button

The System button will display the System Configuration dialog box.



Panel Trigger Tag

The *Panel trigger tag* is a register in the PLC that can be used to select a panel for display. Each panel has a unique Panel ID number which is displayed when you save or open a panel.

When the panel ID number is put in the PLC trigger register, the selected panel will be displayed. The panel change occurs **ONLY** when the value in the register changes and the change overrides anything else being displayed. If you leave *Panel trigger tag* blank, panel selection is done using the GOTO PANEL button .

Do not use Block Transfer tag variables for the Panel trigger tag.

You can use a combination of Panel trigger tag and GOTO PANEL buttons. The operator can select different panels by pressing a GOTO PANEL button, and the PLC can select a panel by changing the panel ID number in the Panel trigger register. In this situation, the GOTO PANEL button will write the panel ID number to the Panel trigger register to initiate the panel change. The important point to remember is that a new panel is displayed when a change occurs in the PLC trigger register.

If you use Panel Trigger Tag, you should also select a Default Panel. If the Panel Trigger Tag in your PLC is equal to 0 or an unused panel ID number, and you don't use a Default Panel, the target display screen will be blank.

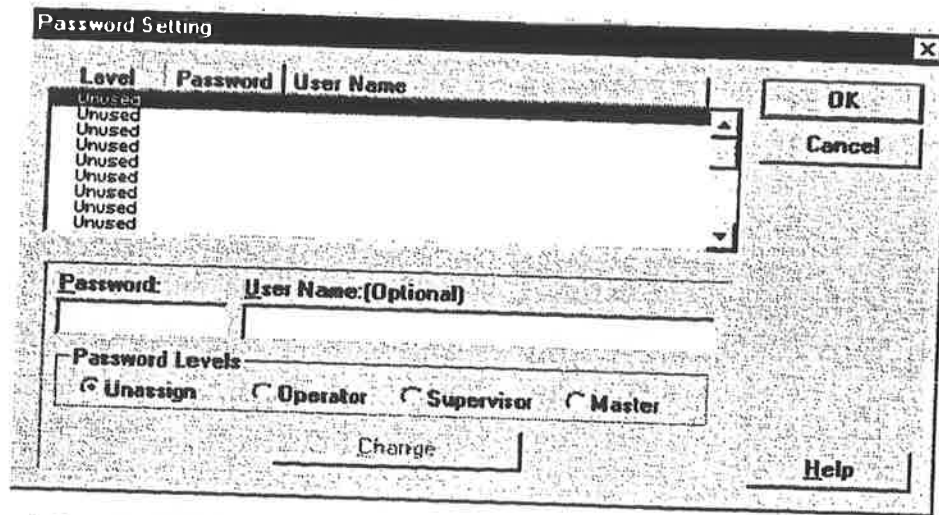
Watchdog Tag

The Watchdog tag selection is a register in the target PLC that is written to in intervals determined by the Timeout setting. The target display will write this register in the selected time period. Your PLC requires additional logic to examine and test the data in order to determine if a communication fault has occurred. A common technique is to set the watchdog register to 0, then examine it after the timeout period has elapsed. If the communication link is good, the watchdog register will have a value other than 0. Continue the cycle of setting the PLC register to 0 and testing the register. At any time after the timeout period the register is still set to 0, then there is a possible communication link problem. The target display will attempt to write an FF to the PLC watchdog register.

Define Password Button

Pressing the Define Passwords button will display the Password Setting dialog box. You can password protect one or more panels in a project. You can setup passwords for up to 16 users. The password is a numeric value from 0 to 65535 with up to three levels of security. For each protected panel in a project, a security level of Operator, Supervisor, or Master is selected. During run time when a protected panel is selected, a numeric data entry panel is displayed prior to accessing the panel. A proper numeric password must be entered which is equal to or greater than the assigned security level, otherwise access is denied. The Master level can access all panels.

To assign a password, select an unused line, enter the password and optional user name, select a password level, then click the Change button. Edit the password by selecting the line, making required changes and clicking the Change button. Remove password assignments by selecting a line, select Unassign and click the Change button.

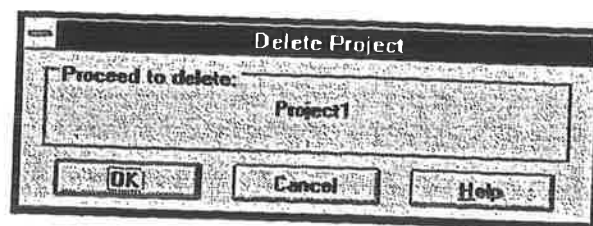


To set the password for a single panel, start the panel editor then go to the Settings menu and select Panel. The Panel Settings dialog will appear. From the Password Level list box, select No Password, Operator, Supervisor, or Master.

Project - Delete


This option will delete the selected project from the *QUICK MANAGER* project list. The name of the project appears in the information box. Select OK to delete the project or Cancel to abort the delete operation.

Once you delete a project, it is GONE! Be careful when deleting projects!



Project - Store Project in QuickPanel

Selecting *Store Project in QuickPanel* is the same as clicking the Download Project button on the tool bar. However, if you open the Project menu again, you will notice a check mark next to *Store Project in QuickPanel*. This indicates the option is enabled and will be reset the next time a compile is started.


The Download Project button  is used to create a project file and hold it for later use. Press this button then the standard download button and the current project will be compiled along with the project file and sent to a QuickPanel. Press this button then the new Compile File button, and the current project will be compiled and saved with a project file. The button is reset after a compile is completed.

The memory required to save the project file should be about 10 to 15 percent of the downloaded file. This means that for most applications, there will be room to store a project file. QPI and QPK platforms have 1000K of storage, while the QPJ has 256K of storage.


Project - Download

This option is used to send a file from the computer system running the *QUICKDESIGNER* software to a target display, such as the *QUICKPANEL jr.* Monochrome display. See the *QUICKCOURIER* chapter on page 68 for details.


Project - Upload

Selecting *Upload* is the same as clicking the Upload Project button.  The Upload Project button is used to upload a *project* file from a QuickPanel. The project file must have been saved with the downloaded file, otherwise an error message will appear. When the project file is uploaded, it is saved the same way as an imported project. The project can then be edited using QuickDesigner software. The file can be compiled and downloaded back to the QuickPanel or saved for other purposes.

Project - Compile to File

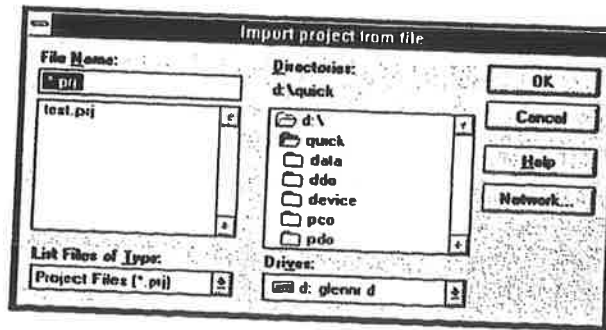
Selecting *Compile to File* is the same as clicking the Compile File button.  The Compile File button will compile the current project and allow saving it to a selected directory. This allows saving compiled files without having to download to a connected QuickPanel. You can then use the Download File button to send a compiled file (*.cmp) to one or more QuickPanels. You can add the current project file to the compile file by clicking the Download Project button before clicking the Compile File button.

Project - Download from File

Selecting *Download from File* is the same as clicking the Download File button.  The Download File button allows the user to select a compiled file (*.cmp) and send it to a QuickPanel. You do not have to compile a file prior to a download, if a compiled version of the project is available. The current download button will still support the standard compile and download operation.

Project - Import

This feature will allow importing project (*.prj) files. These files contain the entire project information, including target display type, PLC setup and all panels. Files can be imported from floppy disk.

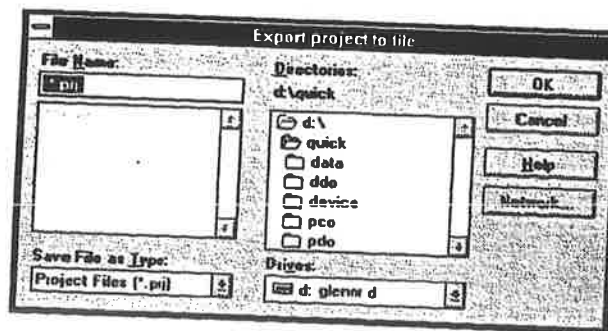


Project - Export

This feature will allow exporting project (*.prj) files. These files contain the entire project information, including target display type, PLC setup and all panels. Files can be exported to floppy disk.

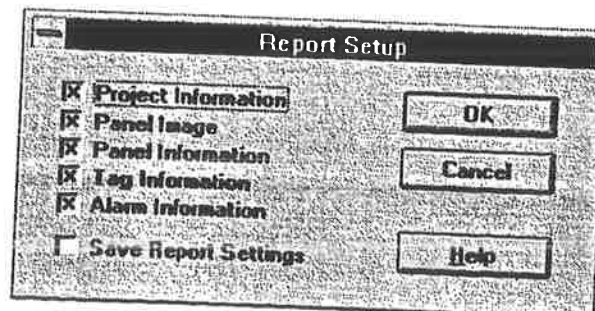
! CAUTION

Do NOT export projects for use in early versions of QuickDesigner software. For example, exporting projects from 3.1 will NOT work in 2.3.

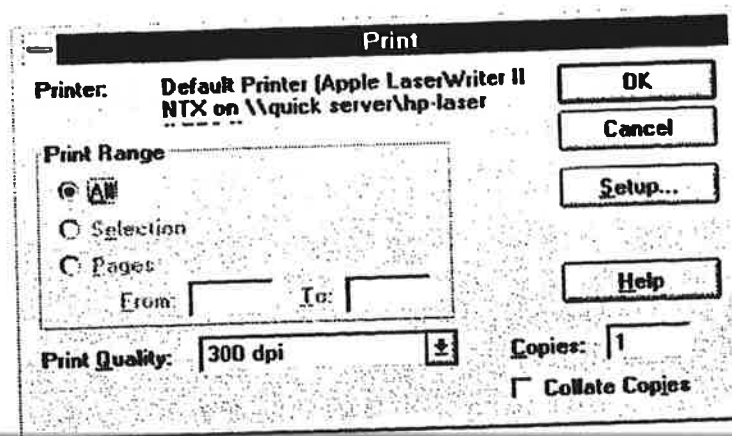


Project - Print

The print function allows printing summary information and panel images for all or part of a selected project. Selecting Print from the File menu or clicking the Print icon will display the following dialog box. Select the parts of the report you want printed by clicking the checkbox next to the item.



Click OK and a Print dialog box will appear. The dialog box will display the current Windows™ driver for your system. Use the Print button in Setup to configure your printer.



Project Information

A sample Project Information page is shown below.

PROJECT NAME

PROJECT INFORMATION

PROJECT: ABSLC500

Author: name

Created: date

Last Modified: date

Notes:

TARGET DEVICE : QUICK PANEL jr. Color

Default Panel Name: name

Panel Trigger Tag: tag name

Screen Saver Timeout: 1.00 minute(s)

Save to FLASH ROM: No

Beeper: Enabled

Watchdog Tag: None

Watchdog Timeout: 1.00 second(s)

Communication Setting: RS422/485 Full duplex

Baud Rate: 9600

Data Bits: 8

Parity: None

Stop Bits: 1

Handshake: None

PROTOCOL: AB SLC 500

Source ID: 0

Destination ID: 1

Maximum ID: 31

Timeout(sec): 1.00

Panel Image

A bitmap image of the panel will be printed at the top of each panel information sheet.

Panel Information

The name of the panel, the panel ID and all panel objects are listed with their attributes. A sample is shown below.

PANEL: name

Panel ID: 1

Panel Size: 320 x 240

Grid Size: 80 x 40

Grid Display: Boxes

notes:

Push Button

Position	Size	Tag	Style	Action	Bez	Botl	Tch	Ltxt	Lbkr	Lotl	LFont	Legend Text
240,160	320,240	N7:100	Standard	Momentary	wht	blk	gm	yel	blu	wht	7x9	Motor
0,80	80,80	B3:20/7	Circular	Toggle	red	wht	wht	blu	gm	blk	11x16	Light

Pilot Light

Position	Size	Tag	Stxt	Slen	Sotl	SFont	State Text
240,160	320,240	N7:100	wht	blk	wht	7x9	REMOTE CONTROL
0,80	80,80	B3:20/7	blk	wht	wht	7x9	LOCAL CONTROL

Tag Information

All of the tags used for the project are sorted and printed by Tag Name. A sample is shown below.

Project name:

TAG INFORMATION

Tag Information Sorted by Tag Name

Name	I/O	Elements	Type	Size	Scale Range Low	Scale Range High
N7:100	N7:100	1	Integer	1	-32768.000000	32767.000000
B3:20/1	B3:20/1	1	Integer	1	0.000000	1.000000
~System_Second	~System_Second	1	Integer	1	0.000000	59.000000

Alarm Information

All of the information for the alarm configuration, queue setup and alarm file are included in the list.
A sample alarm information page is shown below.

- roject name:

ALARM INFORMATION

ALARM CONFIGURATION

Message Column: 16
Trigger Date Stamp Column: 1
Trigger Time Stamp Column: 10
Acknowledge Time Stamp Column: 37
Clear Time Stamp Column: 44
Date Format: MM/DD/YY
Time Format: 24 Hour
Assume Initial State: Same
Printer: None

Active Queue: On

Size: 10
Font: 7x9
Trigger Text - Text Color: blk, Background Color: wht
Acknowledge Text - Text Color: wht, Background Color: blk
Cleared Text - Text Color: wht, Background Color: blk

Historic Queue: On

Size: 10
Font: 7x9
Trigger Text - Text Color: blk, Background Color: wht
Acknowledge Text - Text Color: wht, Background Color: blk
Cleared Text - Text Color: wht, Background Color: blk

Logged Queue: On

Size: 10
Font: 7x9
Trigger Text - Text Color: blk, Background Color: wht
Acknowledge Text - Text Color: wht, Background Color: blk
Cleared Text - Text Color: wht, Background Color: blk

SYSTEM TAGS

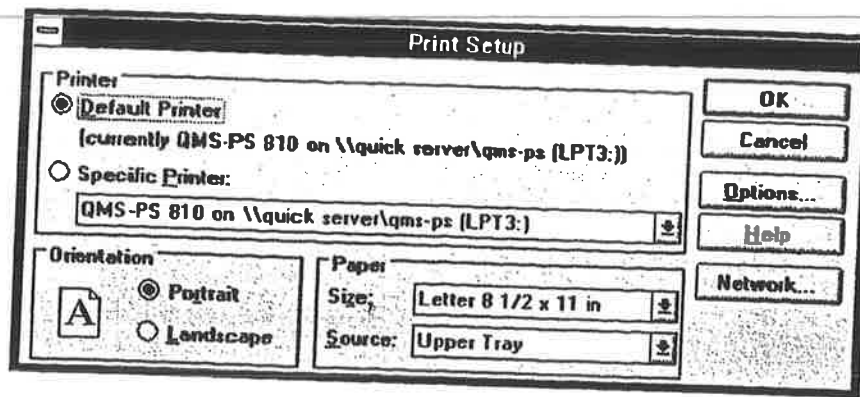
Individual Acknowledge: None
Global Acknowledge: N7:200
Individual Erase: None
Global Erase: None

Global Alarms

<u>Address</u>	<u>Value</u>	<u>Message</u>
IR0:B8	1	Bit 8 Alarm
IR0:B9	1	Bit 9 Alarm

Project - Print Setup

Displays the standard Print Setup dialog box for Windows™.



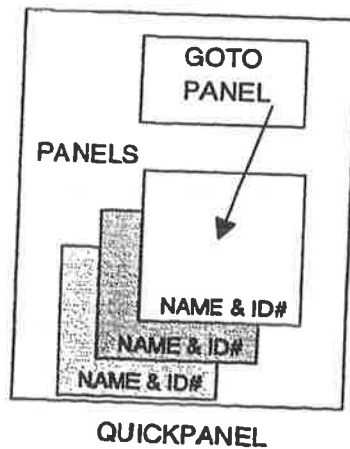
Project - Exit

Closes the *QUICK MANAGER* window and returns to the Windows™ operating system Program Manager.

Changing Panels

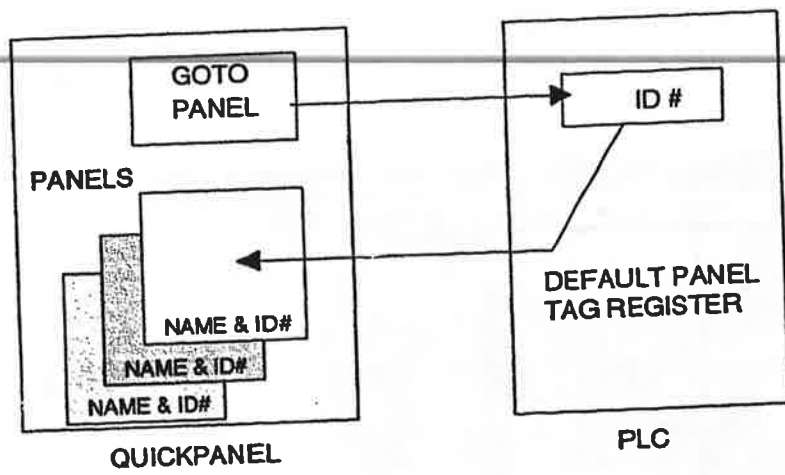
There are two basic ways to change a panel. The first method is to use the GOTO panel button on a panel. When the operator presses the GOTO button, a different panel is displayed. The second method uses a register in your PLC to control which panel is displayed. Each panel has a unique ID number. By moving the desired ID number into the PLC register, a new panel is displayed. There are several methods of moving the desired ID number into the PLC register and each will be discussed in this section.

To create a GOTO button, select the GOTO panel button tool from the tool menu and place it on the panel. When the GOTO panel settings dialog box appears, the Panel Name is typed or selected from the drop-down list box. This is the panel that will be displayed when the GOTO button is pressed. Changing panels is handled by the resident software in the *QUICKPANEL*. You do not have to be connected to your PLC to change panels. The PLC does not know which panel is displayed and cannot control which panel is displayed.



To allow your PLC to control which panel is displayed, *QUICK DESIGNER* software has a feature called "Panel Trigger Tag." The panel trigger tag is a register in your PLC that the *QUICKPANEL* reads and writes. The panel trigger tag is an option when you click the display device setup button and the configuration dialog appears.

When you elect to use a panel trigger tag register, the operation of the GOTO button is modified. Instead of the *QUICKPANEL* handling the changing of the panels, the task is now shared between the *QUICKPANEL* and the PLC. When a GOTO panel button is pressed, the ID number of the desired panel is written to the panel trigger tag register in the PLC. The *QUICKPANEL* immediately reads back the register and changes the panel to the one corresponding to the ID number in the PLC register. You can also move a value into the panel trigger tag register to force the *QUICKPANEL* to change to a new panel. When the *QUICKPANEL* sees a change in the panel trigger tag register, it loads the desired panel. In this situation, you *must* be connected to your PLC to change panels. If your panel trigger tag register in the PLC contains a value of 0, then the *QUICKPANEL* will display a blank screen, since 0 is an invalid panel number.



There are other methods available to write the ID number into the panel trigger tag register. The Word button and the Numeric Data Entry button can both write a value into the panel trigger tag register.

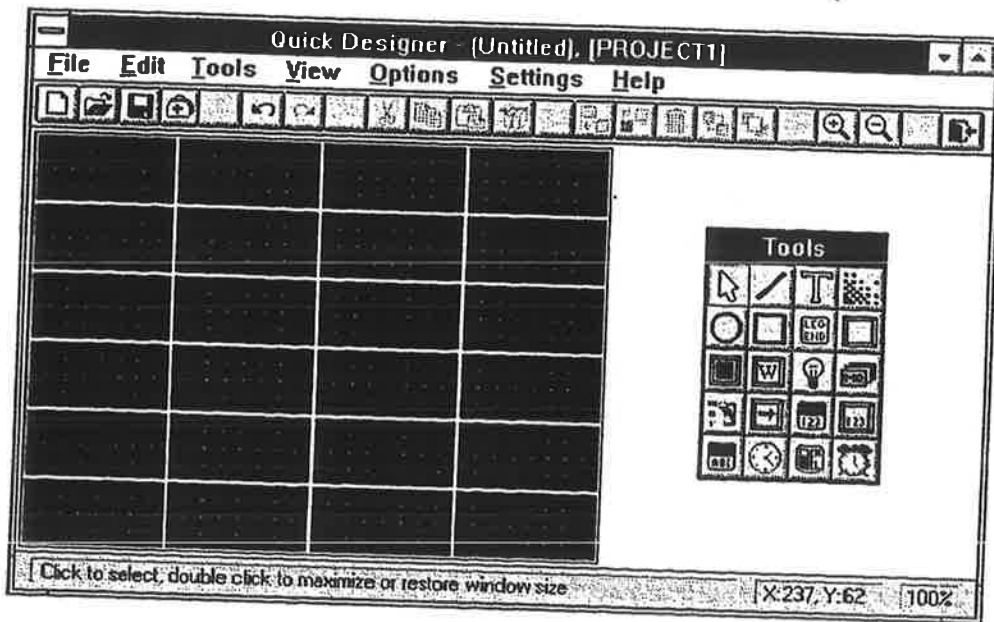
Components Menu

The Components menu contains the same selections as the large buttons in the *QUICKMANAGER* window. You can select Panels to create and edit project panels, select Tags to create and edit tag variables, or select Alarms to create alarm files.



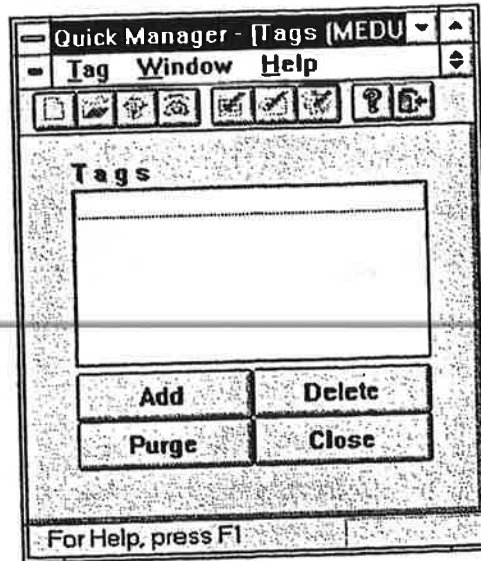
Panels

Selecting Panels will open the *QUICKDESIGNER* window. This window is used to create and edit project panels. This window and all the options are explained in the *QUICKDESIGNER* chapter on page 74.



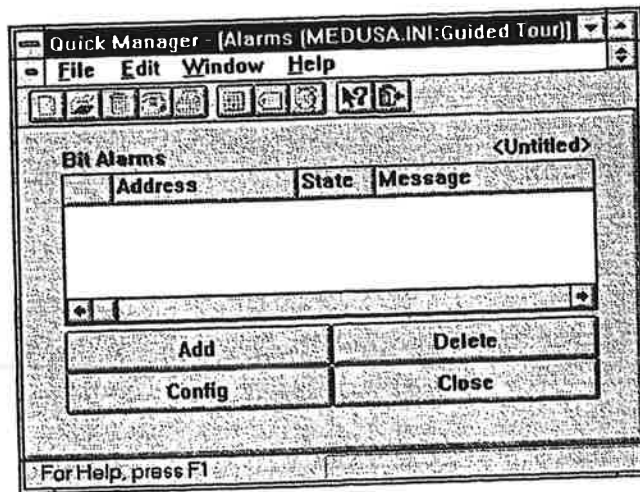
Tags

Selecting Tags will open the Tags window. This window is used to create and edit project tags. This window and all the options are explained in the Tags chapter on page 40.



Alarms

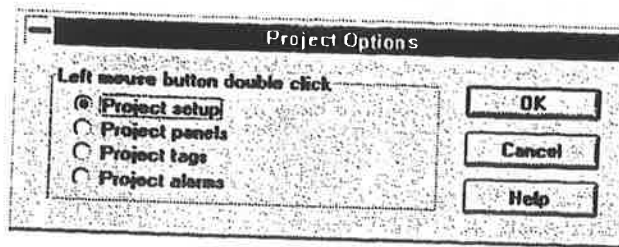
Selecting Alarms will open the Alarms window. This window is used to create and edit alarm files. The Alarm window and all the options are explained in the ALARMS chapter on page 49. See also the Alarms Guided Tour on page 61 for an overview and guided tour of alarms.



Options Menu

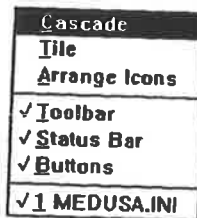
Preferences

Selecting Preferences will display the Project Options dialog box. When you double click on a project name, the default operation is to display the Project Setup dialog box. You can select a different operation in the Project Options dialog box.



Window Menu

Cascade, Tile and Arrange Icons are the standard window options for arranging your desktop. See the Appendix for information about using Windows™.



Toolbar

The Toolbar is normally displayed below the menu bar. Clicking one of the tools is the same as selecting the option from a menu. To remove the toolbar from the window, click the Toolbar option. When the check mark in front of the menu is removed, the toolbar will be removed.

Status Bar

The status bar is displayed at the bottom of the window. It gives you information about the selected menu option and displays the current project name. You can remove the Status Bar from the window by clicking the Status Bar option. When the check mark in front of the menu is removed, the status bar is removed.

Buttons

The large buttons shown in the *QUICK MANAGER* window can be removed to provide more room for project names. When the large buttons are removed, you will have to use the toolbar or menu selections to perform the desired operation. The New, Setup, and Download functions are found in the Project menu. The Panels, Tags, and Alarms functions are found in the Components menu. See Tool Bar for a description of the toolbar functions.

Active Window

The bottom section of the Windows menu shows the current active window.

Help Menu

The on-line Help system gives you quick, easy-to-use information about the *QUICK MANAGER* and *QUICKDESIGNER* features. To request Help:

- Choose a Help category from the Help menu. Some categories take you directly to the information while others select the topic you want from a list of topics about the category you chose.
- Press F1 and choose an item from the main Help Index. You can also search for a topic using the Search command.
- Click the Help button you'll find in many dialog boxes.

Index

An alphabetical list of all Help topics that are available.

Using Help

A short tutorial and other information about using Windows™ Help.

About

This menu selection will display the About information box which shows the software name, software revision level, software serial number and copyright information.

Transfer the software serial number to the registration card, complete the registration card and mail it to Total Control Products, Inc.

QUICK Help

Once you enter the help system from any point, you can gain access to any other help topic by clicking the *Quick Help* button at the top of the help screen.

Error Message

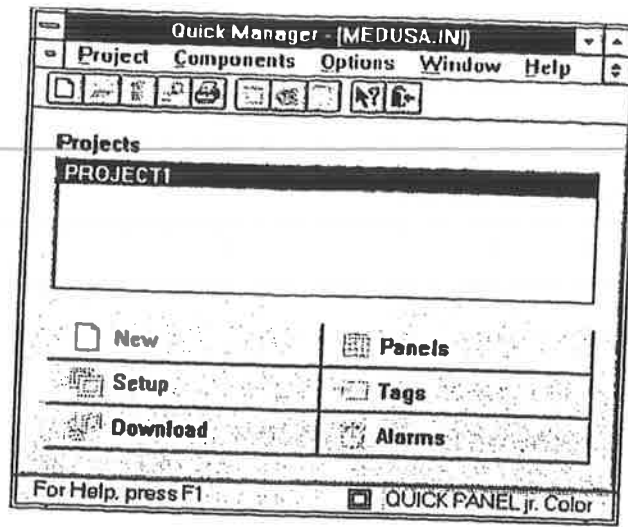
Project in Use

The following warning message appears when *QUICK MANAGER* believes another task or user is working with a project. You will get this message when you try to access one of your projects and all the buttons are greyed out. The message indicates the database is locked.



The *QUICK MANAGER* window appears similar to the one below, with many of the icons and option buttons greyed out.

Note that the project database, named MEDUSA.INI, has been maximized in the *QUICK MANAGER* window. This can be confirmed by the presence of the min/max button located to the right of the word "Help."

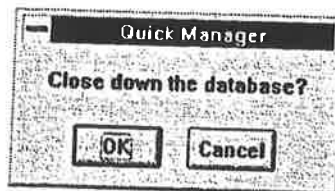


The first step in unlocking the database is to close the database. Make sure no other tasks or users are using the database. Click the control button located to the left of the word "Project" to display the control menu.

NOTE: If there is no control button next to the word "Project", your project window has been minimized. Click the control button on the minimized window to display the control menu.



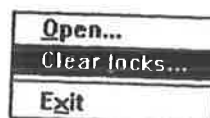
Select Close from the menu and the following dialog box will appear.



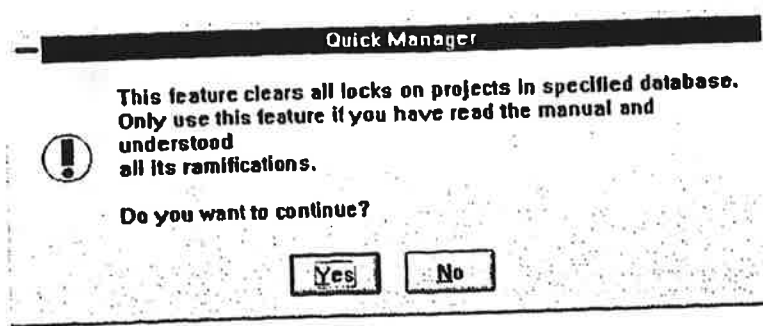
Click OK to close the project database. The *QUICK MANAGER* window appears similar to the one below.



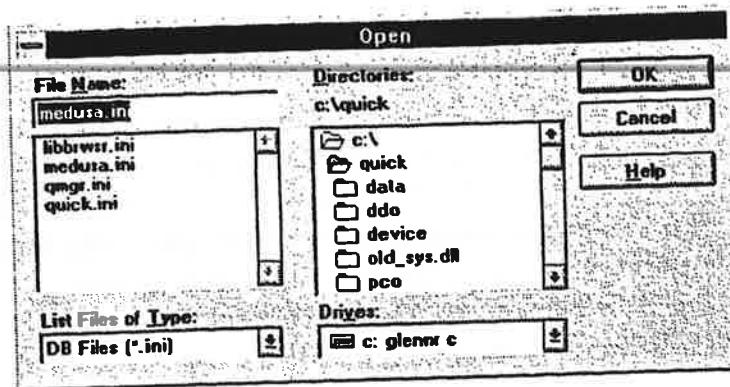
Click on the Database menu option and select Clear Locks.



The following prompt is displayed.



Click Yes to clear all locks on projects in the database. The Open dialog box is displayed.



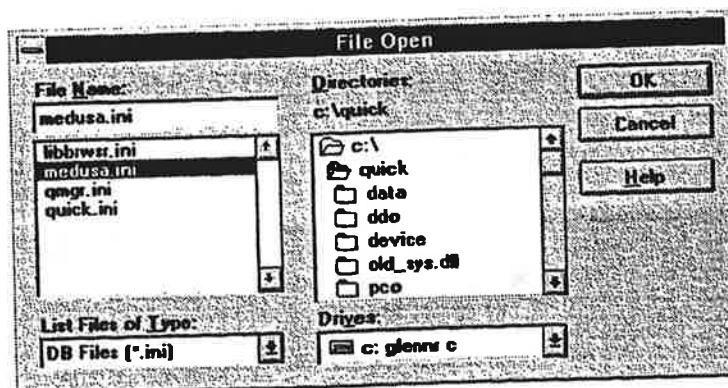
Make sure "medusa.ini" is selected then click OK. When the locks are cleared, the following prompt is displayed.



Click OK to remove the prompt. Select Open from the Database menu.



The File Open menu is displayed.



Select "medusa.ini" and click OK. When you select a project, the buttons will again be active.

Tags

Introduction to Tags

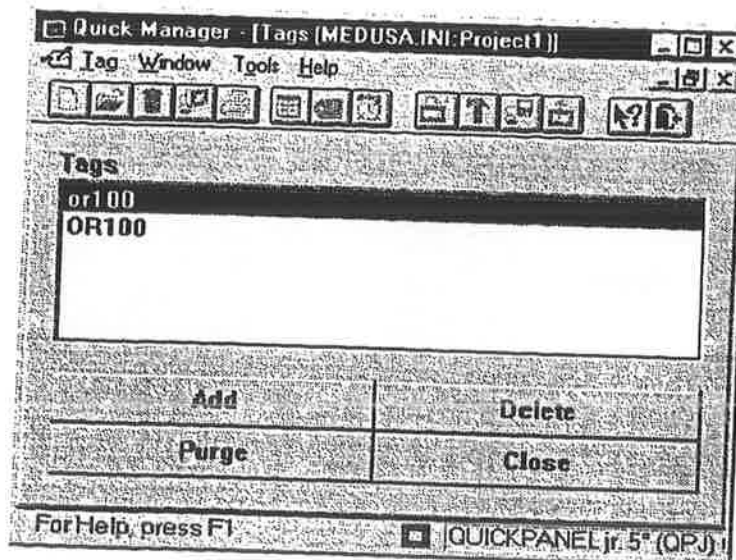
Tags are the names of control elements in your host device, either words or bits. For example, if you have a pilot light, there must be a control element in your PLC that is used to turn the pilot light ON and OFF. Since a pilot light has only two states, you can assume the control element is a bit. Bits have specific names, such as B3:100 or IR2:B2. In this manual, the name of the control element is called a tag. Therefore, every panel operator that is active requires a tag. The tag *MUST* be a legal tag name for the selected PLC type. These tags are external to the display, which means the display will have to read the tag information from the PLC. You can create internal tags, which are variables that are controlled and contained within the display. There are internal tags with specific names, such as the internal clock with the tag name ~System_Clock. Internal tags are explained in the next chapter on page 46.

Selecting Tags

To select Tags, click the Tag icon  or select Tags from the Components menu. The tag icon is found in the tool bar and on the Tags button.

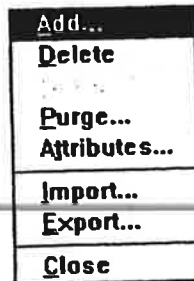
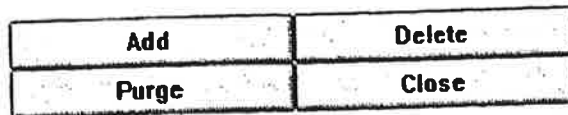
Selecting Tags will open the Tags window. This window allows adding new tags, viewing tag attributes and deleting tags. Tags are the names of PLC variables and special internal variables. Each PLC supported by *QUICKDESIGNER* has a dedicated chapter in the Communications manual.

Tag names are case sensitive. OR100 and or100 read the same data from the PLC but each is a separate and distinct variable in the QUICKPANEL.



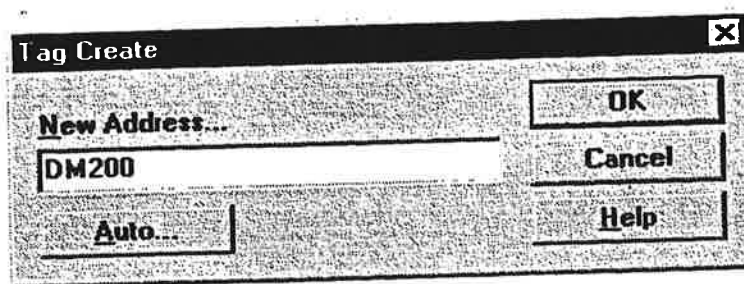
Tag Buttons

Some of the selections in the Tag menu have been duplicated in large buttons. You can use the large buttons or select the option from the tag menu.



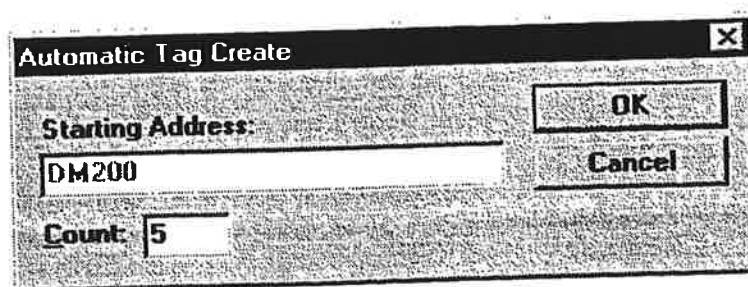
Add Tag

You can create a new tag by selecting Add from the Tag menu or clicking the ADD button. Enter the tag name in the following data entry box. Tag names are tested to insure they are valid for the PLC you selected. Tags that do not fit the format specified for a particular PLC type can be designated as internal tags, which are described in the Internal Tags chapter on page 46. You can create a contiguous group of tags by using the Auto button.



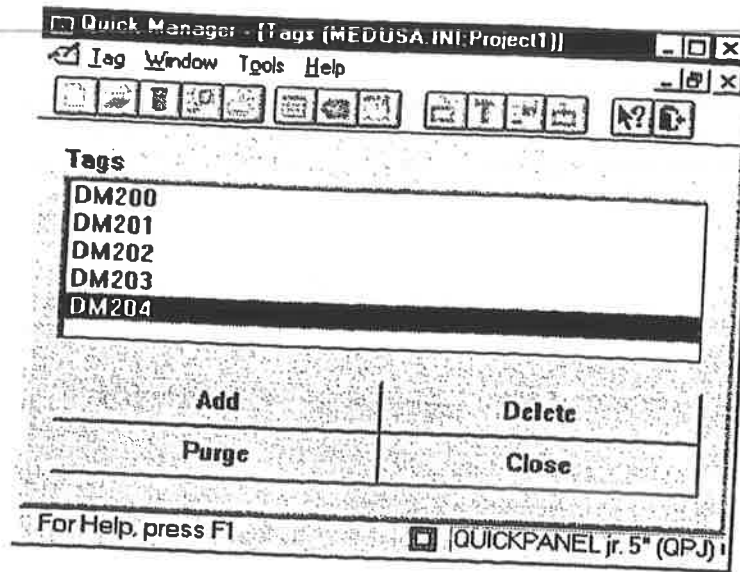
Auto...Button

Use the Auto button to generate a list of tags that have a common name and span a given range. Instead of typing a long list of tag names that all appear the same except for the last numbers, you can automatically generate the list. Enter the common tag name in the Tag Create dialog box and click the Auto button. The following dialog box appears.



Enter the count and press OK to automatically generate the list. For example, if the starting address was DM200 and the final address is DM204, you would enter the count as 5.

The picture below illustrates how the tags would appear when the Auto button is used to create a list of tags.



Delete Tag

To delete a tag from the list, click the tag to highlight it, then click the Delete button.

UnDelete

Replaces the previously deleted tag.

Purge

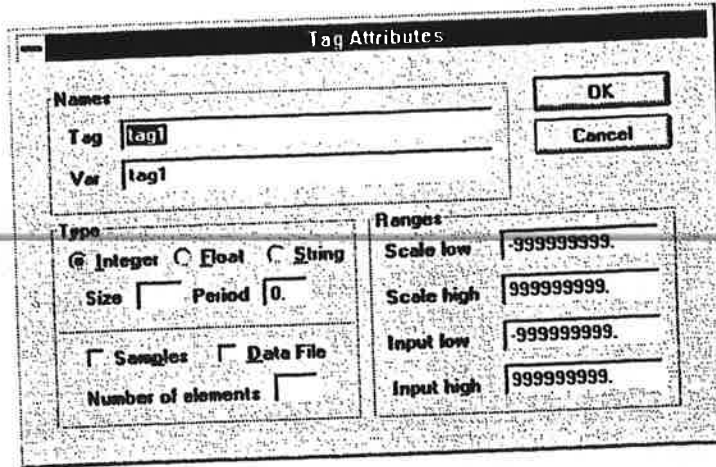
To purge **ALL** tags from the project list, click the Purge button. Use caution with this button since the operation will remove all tags.

Purging ALL tags from a project will remove all tags!

Tag Attributes

Tags can have attributes, such as type and range. Assigning attributes to a tag allows you to customize the tag to a particular application. For example, you can scale a tag so that when the data is displayed, a scaled range is displayed.

You can view the attributes of a tag by selecting Attributes from the Tag menu or by double-clicking the tag name. The three sections of the tag attributes menu are Names, Type and Ranges.



Names	
Tag	tag
Var	tag1

Type		
<input checked="" type="radio"/> Integer	<input type="radio"/> Float	<input type="radio"/> String
Size <input type="checkbox"/>	Period <input type="checkbox"/> 0	
<input type="checkbox"/> Samples	<input type="checkbox"/> Data File	
Number of elements <input type="checkbox"/>		

Ranges	
Scale low	-999999999
Scale high	999999999
Input low	-999999999
Input high	999999999

Tag Attributes-Names

This section of the Tag Attributes dialog box shows the name of the Tag. The Var name is for internal use and cannot be changed.

Tag Attributes-Type

This section of the Tag Attributes dialog box indicates the type setting and other attributes of the tag variable. The default setting for tags is Integer.

Type
 Integer Float String

Size Period

Samples Data File

Number of elements

Set the type to **Float** when reading Floating Point variables. Set the type to **String** when reading ASCII characters. The Text Display object will display text characters only when the tag type is set to String. Selecting the String type will activate the Size entry box. The Size is used to select the number of words to be read from the PLC. For example, if the starting address is DM100 and the length is 5, then the last address read will be DM104.

If the tag variable type in your PLC is not a string type, you may get only one character for each register location. PLC's that support string types will generate two characters for each register location.

Period is inactive and is intended for a future option.

Samples is intended for a future option. Do not check this box at this time.

A **Data File** is automatically created when you create a Block Transfer file for Allen-Bradley Remote I/O applications. The number of Elements in the Data File is the same as the number of words selected for the Block Transfer.

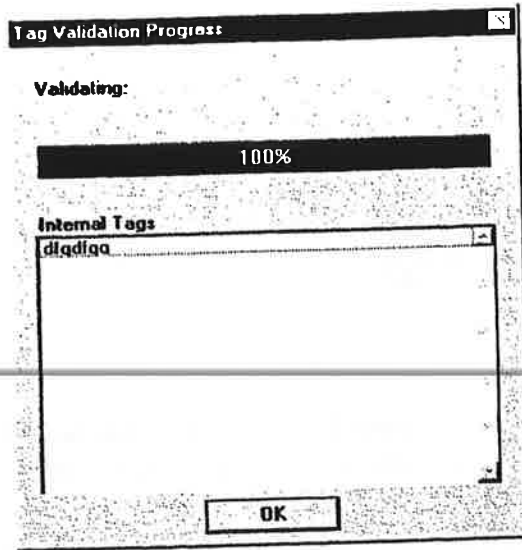
Tag Attributes-Ranges

This section of the Tag Attributes dialog box indicates the ranges of the variable. The ranges are automatically set for each tag type. By changing the scale ranges, you change the ratio of the input value to the displayed value. In the following example, if you changed the Scale low to 0 and the Scale high to 100, when the Input value is -32768 the displayed value would be 0, and when the Input value is 32767, the displayed value would be 100.

Ranges	
Scale low	<input type="text" value="0"/>
Scale high	<input type="text" value="100"/>
Input low	<input type="text" value="-32768"/>
Input high	<input type="text" value="32767"/>

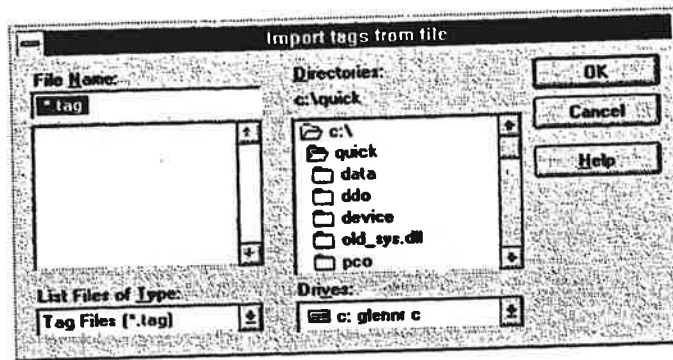
Tag Validation

You can validate the entire tag list by selecting Validate Tags from the Tools menu. The process is displayed in the Tag Validation Progress dialog box. Internal tags are displayed in a list box.



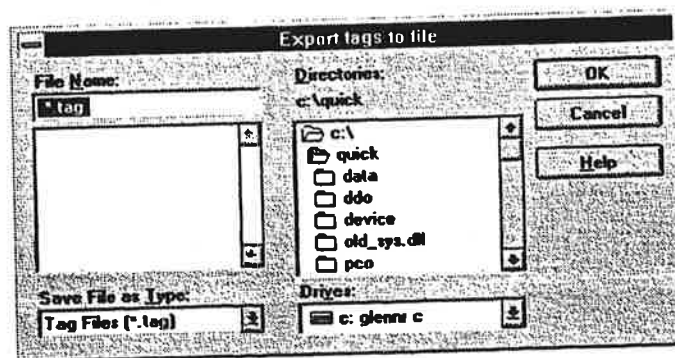
Tag Import

Import tags saved in *.tag format. Do not use a word processor to create or modify these files.



Tag Export

Save the tag information in a file using the *.tag format.



Close

Close the tag window and return to the *QUICK MANAGER*.

Internal Tags

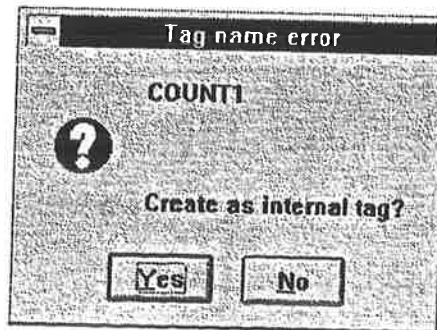
Introduction to Internal Tags

Review of Tags

Tags are the names of control elements in your host device, either words or bits. Every panel operator that is active requires a tag. The tag is usually a legal tag name for the selected PLC type. These tags are external to the display, which means the display will have to read the tag information from the PLC. You can create internal tags, which are variables that are controlled and contained within the display. There are internal tags with specific names, such as the internal clock with the tag name `~System_Clock`.

Internal Tags

In certain projects, you may want to have an internal storage register, to store some values or act as a temporary counter. You can create an internal tag by entering a tag name that is not valid for the assigned PLC. For example, if you entered the name `COUNT1` as a tag name, the tag editor would display the following prompt.



Click the Yes button to create the internal tag. You can read and write the internal tag in the same manner as external PLC tags.

System Tags

The target display has several support functions designed into the hardware, such as the clock. One of the tools available to the panel designer is a Clock operator. The method used to connect the Clock operator to the hardware clock is a series of internal tags called SYSTEM tags. The Clock operator is connected to three SYSTEM tags, which supply the data for seconds, minutes and hours. The tags are called `~System_Second`, `~System_Minute`, and `~System_Hour` respectively. Note the names of the tags that are designated SYSTEM tags all begin with a tilde (~) and the word "System." Note also that there is an underscore symbol between the word "System" and the name of the tag.

In order to use a SYSTEM tag, you must always specify the name of the tag exactly as it appears in this reference section. To display system seconds, you can select a Numeric Data Display operator and specify the tag name as ~System_Second. You may get an error message indicating that the tag name is not valid for a particular PLC type, but that is normal, since you can create internal tags using any name. However, to use the SYSTEM tags, the name must be entered exactly. If you entered the tag name as "Second", the target display will create an internal variable called "Second", but it will not be connected to the internal clock.

System Variables

This section contains the list of current supported system variables.

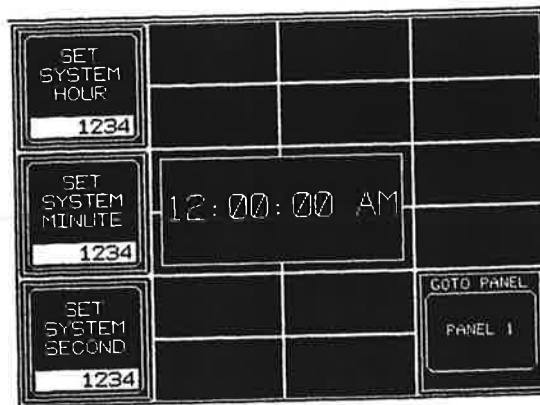
~System_Second	Internal clock seconds.
~System_Minute	Internal clock minutes.
~System_Hour	Internal clock hours
~System_Day	Internal clock day
~System_Month	Internal clock month
~System_Year	Internal clock year
~System_Contrast	LCD panel contrast setting.
~System_Comm_Status	Communication Status

Clock System Variables

The *QUICKDESIGNER* software includes a tool for displaying the system time. The tool currently does not include a dialog box for setting the time.

We have developed an interim method for setting the clock. When the final design of the dialog box for setting the clock is done, there will be an easier method for setting the clock.

Create a new panel and use any name you like for the panel. The panel will consist of three Numeric Data Entry operators and one Numeric Data Display. The three data entry operators will be used for setting the hours, minutes and seconds. The data display will be used to display the clock setting.



Select the Numeric Data Entry operator and place it on the panel. When the Numeric Data Entry Settings dialog box appears, enter the tag name as ~System_Hour. You must type the tag name exactly as shown, including the tilde (~) at the beginning. Remember to enter the desired text in the legend plate to identify the operator as system hour.

Create two more Numeric Data Entry operators, using the tag names ~System_Minute and ~System_Second. Remember to enter the desired text in the legend plates to identify system minute and system second.

Select the CLOCK operator and place it on the panel. Click the seconds box so the clock displays hours, minutes and seconds. Military time refers to the 24 hour format.

Save the panel and download it to the target display. Use the data entry operators to set the clock for your display. The target display maintains the system time between power cycles.

Date System Variables

The *QUICKDESIGNER* software includes a tool for creating an alarm display. One of the options in the alarm message is the display of a date stamp. The method for setting the correct date is similar to setting the time.

Select a Numeric Data Entry operator and place it on the panel. When the Numeric Data Entry Settings dialog box appears, enter the tag name as `~System_Day`. You must type the tag name exactly as shown, including the tilde (~) at the beginning. Remember to enter the desired text in the legend plate to identify the operator as system day. Repeat the procedure for `~System_Month` and `~System_Year`.

Contrast System Variable

The contrast of the target display can be changed to suit different viewing conditions.

To adjust the contrast, the system variable `~System_Contrast` must be set to a value from 1 to 7. This can easily be done by using two Word Buttons: one to increment and one to decrement the value of `~System_Contrast`. You can see the contrast change as the value is increased or decreased.

Select the Word Button operator and place it on the panel. When the Word Button Settings dialog box appears, enter the tag name as `~System_Contrast`. You must type the tag name exactly as shown, including the tilde (~) at the beginning. Select the Action as Add and set the value to 1. Remember to enter the desired text in the legend plate to identify the operator. Place a second Word Button on the panel with the same tag name and select the Action as Subtract and the value as 1.

Communication Status

The communication status is a bit that can be used to turn a pilot light ON or OFF to indicate the status of the communication protocol. When the bit is equal to 0, the communication protocol is normal. The tag variable is `~System_Comm_Status`.

Select the Pilot Light operator and place it on the panel. When the Pilot Light Settings dialog box appears, enter the tag name as `~System_Comm_Status`. You must type the tag name exactly as shown, including the tilde (~) at the beginning. Use the STATES button to change the text for the ON and OFF states.

System Comm Status is an internal variable that is available ONLY on QPJ-1 and QPI-1 models. All QPJ-2, QPK-2, and QPI-2 models do not support System Comm Status.

Alarms

Introduction to Alarms

Alarms are messages that appear on the display in response to a specific condition in the host control system. The alarm message informs the operator of a condition that requires immediate attention. A typical alarm message is shown below.

DATE	TIME	MESSAGE	ACK	CLEAR
09/18	22:48	HIGH TEMPERATURE ALARM		

There are two procedures involved in creating an alarm display. The first procedure is to configure the alarm manager. You create a table of PLC address bits or words and enter the alarm text for each table entry. The alarm manager reads data from the host and determines if an alarm condition exists.

You select the format for the alarm message, date stamp and time stamp. You can change the size and format of the queues (buffer area) where the alarm messages are stored. When alarm messages exceed the size of the queue, the oldest alarm messages are deleted. You can select a bit or group of bits in your PLC that will be set when the alarm Acknowledge and Delete buttons are used. The alarm table and configuration information are saved in an alarm file.

For each alarm condition, the alarm manager creates an alarm message string. The alarm manager adds date and time stamps, add the alarm text from the alarm table, formats the entire alarm message, and stores the alarm message in the Active Alarm queue (buffer area). The alarm manager keeps track of when the alarm was acknowledged and cleared and stores this information in the Historic queue. The alarm manager also tracks every alarm activity in a Logged Alarm queue.

Creating an alarm window is the second procedure required to view alarms. The alarm window is a tool, similar to other tools, like pilot lights and push buttons. The alarm window is placed on a panel and is used to view alarm information from a selected alarm buffer. If the operator touches the alarm window, the alarm manager screen is displayed. This screen allows the operator to acknowledge one or all alarms, clear one or all alarms, or view any alarm message stored in the alarm buffer.

This chapter is designed as a reference section. Before attempting to configure alarms, you should follow the procedures in the Alarms Guided Tour on page 61.

This chapter will describe how to:

- Open the Alarms window
- Add a new word or bit alarm file.
- Assign words or bits in your host device as alarm elements.
- Setup the alarm message format.
- Configure the alarm manager so the Acknowledge and Del buttons set bits in the host.
- Connect a serial printer for printing alarm messages.

Bit and word Address Tags

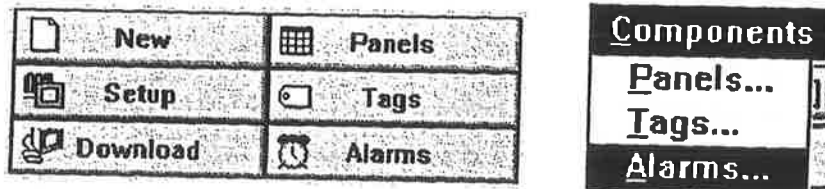
The alarm manager is the control center for alarm operations. The alarm manager must read the PLC address you have assigned as the alarm bit or word. The read operation will cycle very quickly if you have only one bit or word to read. If you try to read alarm bits that are scattered throughout the PLC memory, the response time will tend to become slow. The best method of reading alarm bits or words is to read consecutive PLC bits and words.

When you first add an alarm table, you select a starting address and then enter the number of consecutive bits or words. The alarm table is built automatically. This is the fastest and most efficient way of reading alarm data from the PLC. When you are done creating the alarm address table and entering the alarm messages, the alarm table is saved to an alarm file. There are several examples of the alarm table in this section.

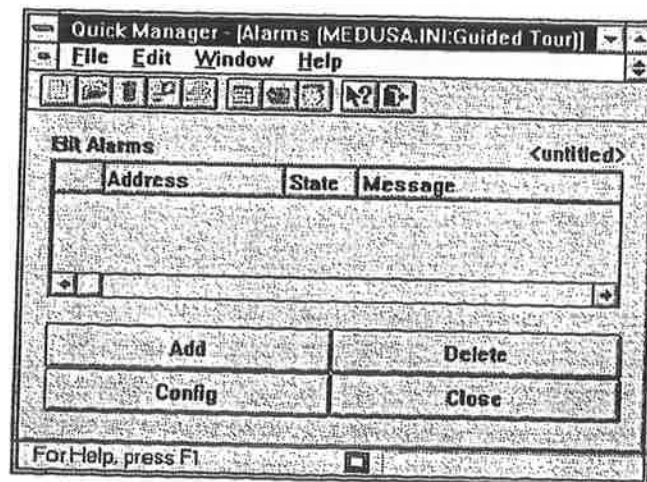
If for some reason you are unable to create a consecutive alarm table, you can still enter a single alarm address by setting the number of bits or words to 1. You can also set the number of bits or words to the maximum size of the alarm table, and let the alarm manager build the alarm table. Go to the Edit menu and click the Free Form Address option, which will allow you to edit any address in the table. You must be careful to enter only valid PLC addresses. Entering a name like JOE will create an invalid address. The alarm file is sent to the target display during the download operation.

Alarms Configuration

To configure Alarms, click the Alarms button or select Alarms from the Components menu.



Selecting Alarms will open the *Alarms* window and the *New bit alarms* dialog. (See *New bit alarms* in the Edit Menu section). The Alarms window is used to create and edit alarm files and configure the alarm message and buffers. The *Alarms* window appears below.



The default setting for the window is Bit Alarms. Bit alarms are controlled by a bit going ON or OFF. You can create a word alarm file by selecting New-Word from the File menu. Word alarms are based on the value of the word.

The large buttons at the bottom of the window are convenience buttons, which allow rapid access to menu selections. The Config and Close buttons are File menu options, while the Add and Delete buttons are Edit menu options.

See the Alarms Guided Tour on page 61 for an overview and guided tour.

File menu

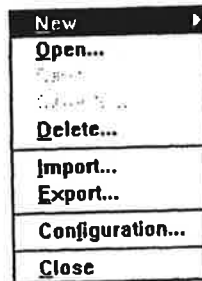
The file menu option is used to create new word or bit alarm files, to open existing alarm files, to save new or edited files, to delete unwanted files, to configure alarm files or to close the alarms manager window.

File Menu Buttons

The Config and Close buttons shown in the Alarms window perform the same function as the Config and Close options in the File menu. The Config button will open the Configuration dialog and the Close button will close the alarm window.



You can display the Configuration dialog box by selecting Configuration from the File menu or by clicking the **Config** button. You can close the alarm window by selecting Close from the File menu or by clicking the **Close** button.



File - New (Word or Bit)

Create an alarm file based on a bit or a word in the PLC. Bit alarms are controlled by a bit going ON or OFF, while word alarms are based on the value of the word.

File - Open

Open an existing alarm file. The Open Alarm File dialog box appears. Select a file name from the list or type in the file name.

File - Save

Saves the current alarm file with all the option settings. You must have an alarm file saved for alarms to work. The Save Alarm File As dialog box appears. Enter a new file name or select an existing file name to overwrite.

File - Save As

Saves the current alarm file using the specified file name. The Save Alarm File As dialog box appears.

File - Delete

Delete an existing alarm file. The Delete Alarm File dialog is displayed. Select the filename from the list or type in the filename. Once you delete the file, it is gone.

File - Import

Import an existing alarm file. After the file is imported, Open the file to view the alarm table.

File - Export

Export the current alarm file using the *.alm file extension. Note: When using the export file feature, ALL alarm files are included in the export file.

File - Configuration

Displays the Alarm Configuration dialog box. See Config Button on page 56.

Message Format	
Message Column	118
Trigger Date Stamp Column	1
Trigger Time Stamp Column	10
Acknowledge Time Stamp Column	37
Clear Time Stamp Column	44

Date & Time Format	
Date	mm/dd/yy
Time	24:00

Printer Port: None

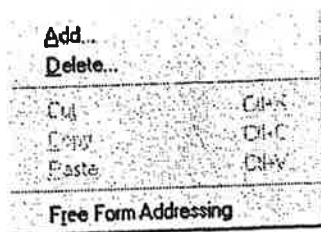
Buttons: OK, Cancel, Queue..., Advanced..., Help

File - Close

Close the current alarm file. If the alarm table is new or changes were made to the table, a prompt will appear reminding you to save the file. You MUST have an alarm file saved for alarms to work.

Edit Menu

You can create an alarm table by selecting Add from the Edit menu or by clicking the Add button. You can delete elements from the alarm table by selecting Delete from the Edit menu or by clicking the Delete button. Use Cut, Copy and Paste to edit alarm text. Select a bit alarm address and the Bit option will toggle the State setting. Free Form Addressing allows editing the alarm address.



Edit Buttons

The Add and Delete buttons shown in the Alarms window perform the same function as the Add and Delete options in the Edit menu.

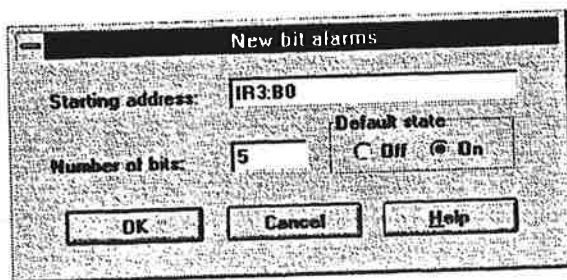


Edit - Add

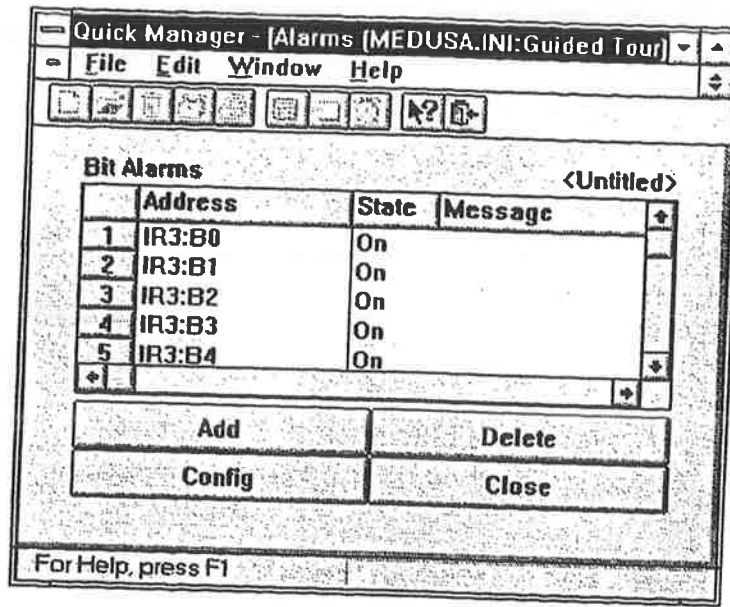
Adds bit or word address tags. Allows single or multiple tag creation in contiguous blocks. Used to create the alarm address table and alarm messages.

Adding Bit Alarms

When adding bit alarms, enter the starting address and the number of bits. The alarm processor will automatically create a contiguous string of addresses, starting at the specified address.

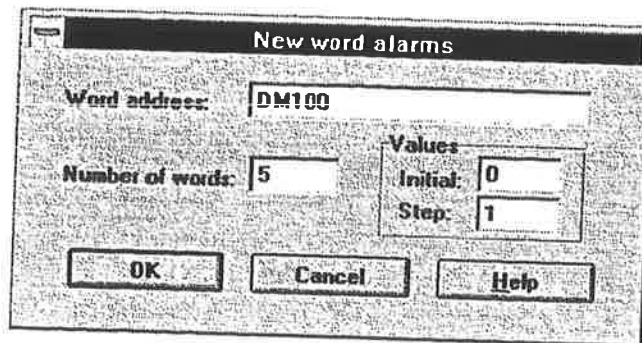


For example, if you enter IR3:B0 as the starting address and the number of bits as 5, the alarm processor will create the following alarm table. The first entry is IR3:B0 with the State set to ON. That means when IR3:B0 goes to a 1 (ON), an alarm will be generated. You can change the State condition by double clicking the State field to change the ON to OFF.

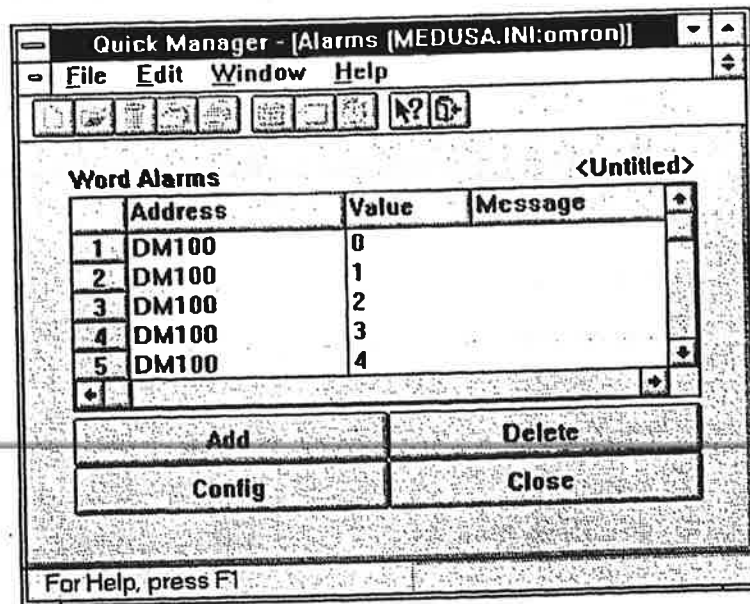


Adding Word Alarms

When adding word alarms, enter the word address and the number of words. The alarm processor will automatically create the alarm table, using the specified word address. Each table entry will show the word address with a different value, based on the initial and step settings. The number of table entries is based on the number of words selected. You can set the initial value and the number of steps the table will be incremented.



For example, if you enter DM100 as the starting address and the number of words as 5, the alarm processor will create the following alarm table.



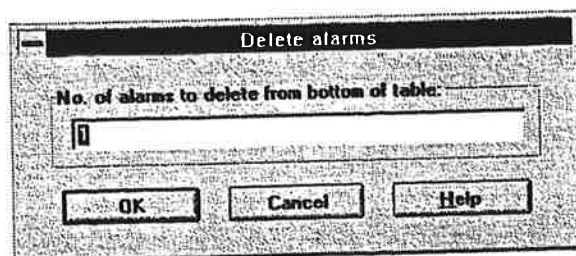
The first entry in the above table is DM100 with a value of 0. That means when DM100 is equal to 0, an alarm condition exists. Registers in a PLC are often reset to 0 during power cycles. You may not want a value of 0 to produce an error condition. To prevent this situation, change the Initial setting in the New Alarms dialog box to 1.

Maximum Alarms in a Project

The maximum number of alarms for a project depends on the display model. For QPJ models, the maximum is 512 alarms, consisting of two files of 256 alarms. For QPI models, the maximum is 768 alarms, consisting of three files of 256 alarms. When you first create an alarm, the first file of 256 is allocated. When you exceed 256, the next file is opened.

Edit - Delete

Deletes the selected number of alarms from the *bottom* of the table. You can delete all the alarms by entering a number larger than the table size.



Entering and Editing Alarm Messages

The alarm table is created without any alarm messages. You must enter an alarm message for each entry in the alarm table. To enter text in the Message field, move the mouse pointer to the field and click. The field is selected and you can begin to type the alarm message, up to 127 characters. See the Message Format description on page 56 to determine the practical limit to the number of characters in the message.

You can enter text in a blank message field by clicking on the field and typing. While typing, you are in the text edit mode. You can use DEL, BACKSPACE, and cursor keys to edit the text. If you double click a message field that has text in it, or select a field and press F2, you will be in the text edit mode. Use ESC to undo typing errors.

Edit - Cut Message

To cut an entire message, click the message field and use CTRL+X or select CUT from the Edit menu.

Edit - Copy Message

To copy an entire message, click the message field and use CTRL+C or select COPY from the Edit menu.

Edit - Paste Message

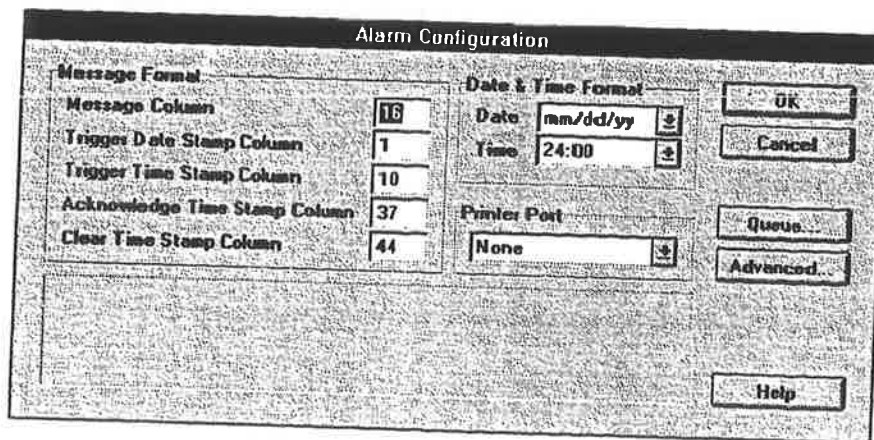
Messages copied or cut can be pasted to other alarm text message fields. Click the message field and use CTRL+V or select PASTE from the Edit menu.

Edit - Free Form Addressing

When checked, free form addressing allows you to edit the address field of the alarm table. Make sure you enter a valid PLC address. When unchecked, you cannot edit the address field.

Config Button

Selects the Alarm Configuration dialog box.



Message Format

This section is used to select the default column where each portion of the alarm message will begin. Column position is dependent on the type of target display and the size of the text. See the following chart for text layout guidelines. The large 16 x 32 character size was not included in the chart.

Display Type	5x7 Characters	7x9 Characters	11x16 Characters
QUICKPANEL jr.	49	37	23
QUICKPANEL 10"	103	77	47

Use a columnar tablet to help you design the alarm message panel. The column count begins at column 1. Enter a 0 in the column field to effectively turn off the feature. For example, if you do not want a Trigger Date Stamp, enter a 0 in the column field.

Remember to put a space between text elements for easier viewing. The date format can be 8 characters (mm/dd/yy) or 5 characters (mm/dd). The time stamp is 5 characters (12:00).

In the following example, the display type is a *QUICKPANEL jr*. The Date Format has been set to mm/dd (month/day). The sample format allows for 25 characters in the message text.

Message Column: 13
 Trigger Date Stamp Column: 1
 Trigger Time Stamp Column: 7
 Acknowledge Time Stamp Column: 38
 Clear Time Stamp Column: 44

DATE	TIME	MESSAGE	ACK	CLEAR
09/18	22:48	ALARM MESSAGE TEXT	22:50	22:52

Date Format

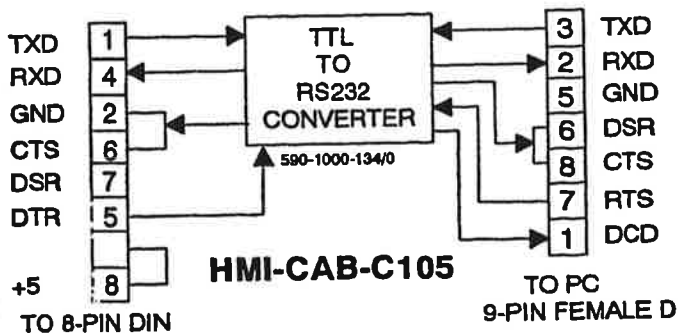
The date format can be mm/dd/yy or mm/dd format. Each character in the date stamp requires a space in the alarm message. Therefore, mm/dd/yy will take 8 spaces, plus an additional space for separation between columns. The mm/dd format requires only 5 spaces, plus one for column spacing. See the Internal Tags section for information about setting the date.

Time Format

The time can be displayed in 12 hour or 24 hour format. In 12 hour format, the lowest number is 1:00 and the highest number is 12:59 (AM or PM). In 24 hour format, the clock starts at 00:01 and counts the hours and minutes up to 23:59. The 24 hour format is sometimes referred to as military or international time. See the Internal Tags section for information about setting the time.

Printer Port

The download port, also known as the Tool/CN3 port, has two functions. The primary use is to download application files from a computer to the target display. The secondary use is to print alarm messages to a serial printer. The Printer Port option in the Alarm Configuration dialog is used to enable the download port (Tool/CN3) as a serial printer port. The download port uses TTL signal levels and requires conversion to RS232. The HMI-CAB-C105 cable will convert the TTL signals to RS232. This cable is equipped with a 9-pin D connector that is AT compatible. The download port connector is an 8-pin mini-DIN style. The port settings are fixed at 9600 Baud, 8 bits, no parity. The pin assignments are shown in the following drawing.



PROPRIETARY INFORMATION

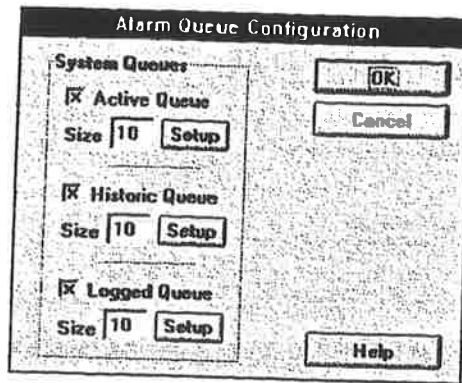
THIS INFORMATION IS PROVIDED AS A CONVENIENCE TO OUR CUSTOMERS. YOU ARE NOT AUTHORIZED TO CONSTRUCT THIS CABLE. UNAUTHORIZED CABLES ARE NOT SUPPORTED BY TOTAL CONTROL.

To configure a printer port, go to Alarm Configuration dialog box. Select NONE for parallel printing and Tool/CN3 for serial printing.

Queue Button

The Queue button is one of the option buttons in the Alarm Configuration dialog box. Queues are internal storage buffers for alarm messages. The three possible alarm queues are Active, Historic and Logged. Each queue has a default setting of ten messages which means the display will store ten messages. Excess alarms are dumped, oldest alarms first. If you want more messages stored, increase the size of the queue.

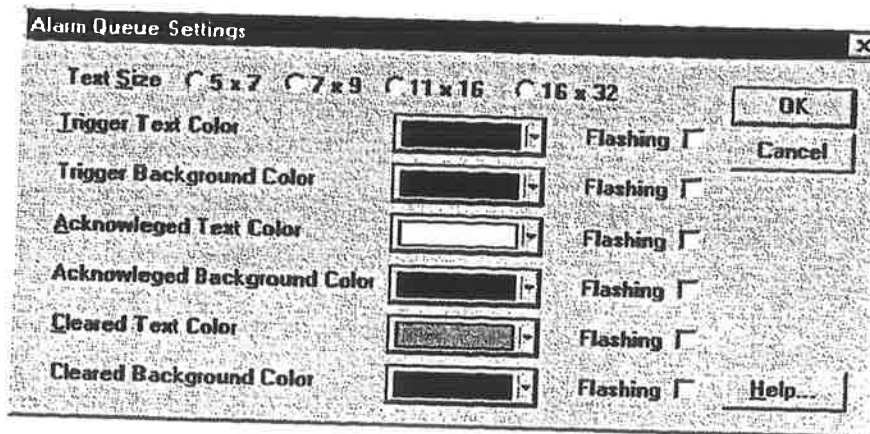
Messages are lost on a power cycle.



Alarm Queue Setup

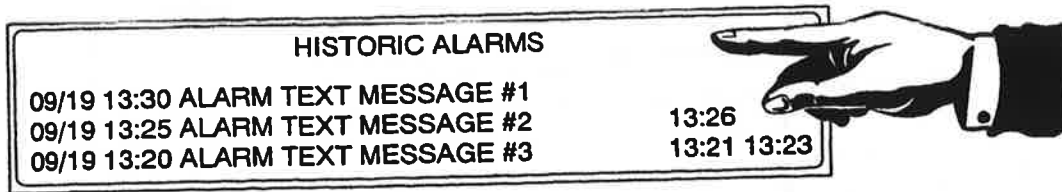
Each alarm queue has a setup button to allow selection of the text size and color for the alarm management page. See Alarm Page Display in the next heading.

When an alarm occurs, the message appears in the Alarm Window. When the operator touches the display over the Alarm Window, the current panel is removed and the alarm management page is displayed. The Alarm Queue Settings dialog is used to select the colors and size of the text displayed on the alarm page.



Alarm Page Display

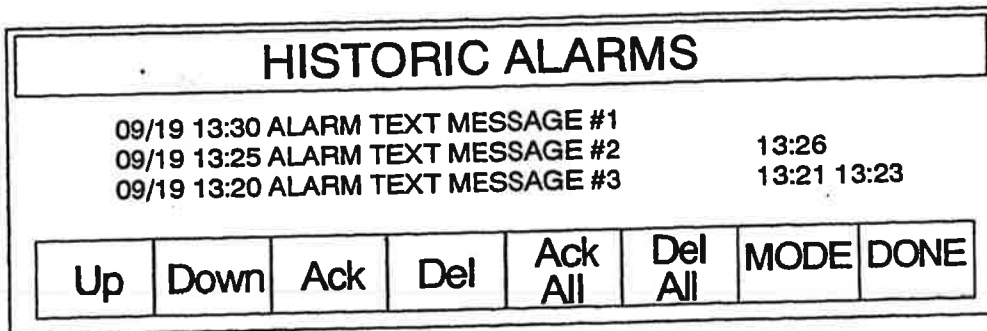
In the following example, the alarm window is showing three Historic alarm messages. The Active and Logged alarm windows are similar. The example shows only three message lines, but there may be more messages in the historic alarm queue. The first alarm is a triggered alarm, the second has been acknowledged and the third alarm has been acknowledged and cleared. See "Creating an Alarm Window" on page 186.



When the operator touches the display panel over the alarm window, the alarm queue will be displayed on the alarm management page. The buttons on the bottom of the alarm management page are activated by pressing the MODE button. Pressing the MODE button also displays the two horizontal lines that are used as a cursor. The DONE button is always active.

CAUTION Do NOT press the MODE button more than once. If you do, the panel will freeze and no further operations will be displayed. Press DONE to exit.

Once the buttons are activated, they can be used to view and modify the contents of the alarm queue. The Up and Down buttons move the cursor. Remember that the alarm management page may only show a portion of the messages in the queue. The Up and Down buttons allow scrolling the alarm queue messages to the alarm page. Move the cursor to a message line and use the Ack button to Acknowledge the alarm, or use the Del button to delete the message. Use Ack All to Acknowledge all messages or Del All to delete all messages in the associated queue. Return to the panel where the alarm window is located by pressing the DONE button.



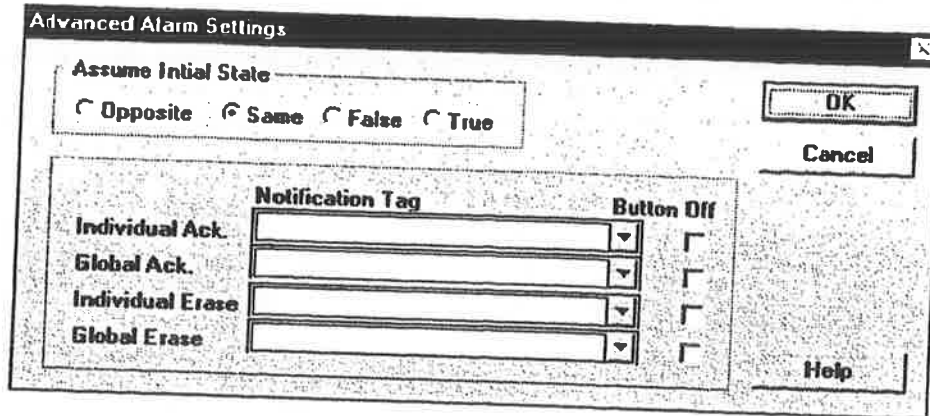
To activate the small buttons on the bottom of the alarm management page, touch the MODE button only ONCE. The DONE button is always active.

The small buttons on the bottom of the alarm management page can also be used to set a bit in a PLC, so the PLC is notified when an alarm is acknowledged or erased. See Advanced Button in the next section.

If you have installed the optional HMI-KPN-201 keypad, the alarm management page will appear with an additional row of keypad assignments. See Keypads for details.

ADVANCED BUTTON

The Advanced button is one of the option buttons in the Alarm Configuration dialog box. See *Assume Initial State* and *Notification Tags* in the following sections.



Assume Initial State

When the power is turned on, the alarm processor does not know the state of the alarm bits or words. By assuming an initial state, the alarm processor can deal with the alarm states until the true states are read from the PLC. The default setting is Same, which assumes no alarm transitions have occurred.

- Opposite: Assume an alarm transition has occurred.
- Same: Assume no alarm transition has occurred.
- False: Test for true alarm state and process the alarm if true. No action if FALSE.
- True: Test for false alarm state and process the alarm if false. No action if TRUE.

Notification Tags

The small buttons on the bottom of the alarm management page can also be used to set a bit in a PLC, so the PLC is notified when an alarm is acknowledged or erased. To activate the buttons for PLC notification, a tag variable is assigned to the button function. The notification tags are configured in the Advanced Alarm Settings dialog box.

HISTORIC ALARMS							
09/19 13:30 ALARM TEXT MESSAGE #1							
09/19 13:25 ALARM TEXT MESSAGE #2							
09/19 13:20 ALARM TEXT MESSAGE #3							
				13:26 13:21 13:23			
Up	Down	Ack	Del	Ack All	Del All	MODE	DONE

The notification tag buttons are Individual Acknowledge (ACK), Global Acknowledge (ACK ALL), Individual Erase (DEL) and Global Erase (DEL ALL). Assign a notification tag the same way you assign other tags. For example, the Allen-Bradley PLC-5 has bit addressing available in the format B3:00/00. If you assign Individual Acknowledge (ACK) to B3:00/00, the bit will be set when the ACK button is pressed and reset when the button is released.

Button Off

The buttons on the bottom of the alarm management page can be deactivated by clicking the associated Button Off checkbox.

Alarms Guided Tour

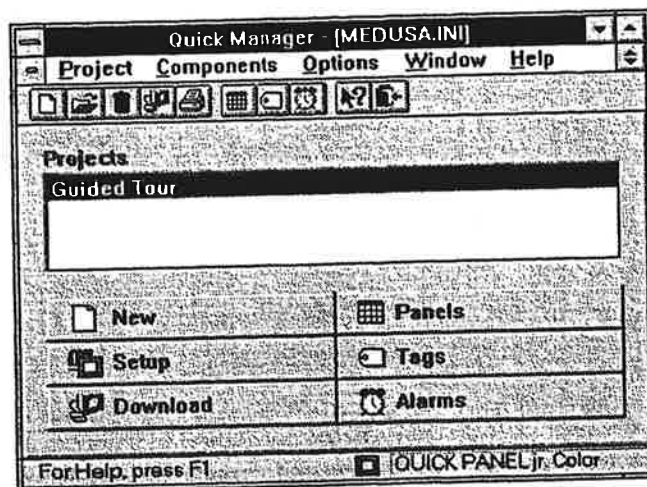
Introduction

The guided tour section is a step-by-step introduction to Alarms. It will introduce you to the procedures needed to create an alarm display. The tour references a particular PLC in order to demonstrate some of the procedures. If you take the tour, remember that the PLC variable names in the text may be different than those used in your PLC. For example, the tour references IR3:B3 as a bit in the image table. Your PLC will most likely use a different format for addressing bits.

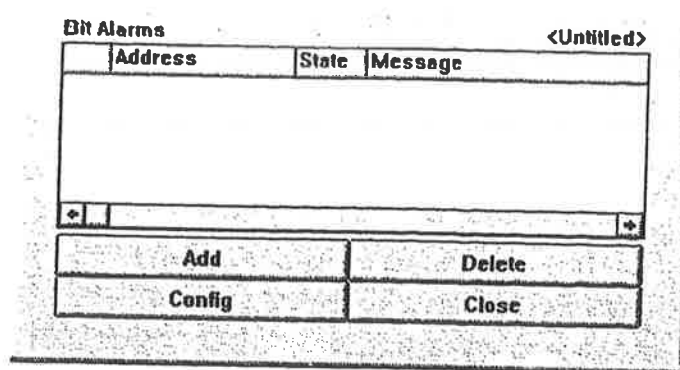
The tour starts by assuming that you know how to use the *QUICKDESIGNER* software to create projects, design panels, and download panels to a display. If you are not familiar with *QUICKDESIGNER*, take the Quick Tour on page 6. All of the steps for a complete project are included in the tour, but all steps are not discussed in detail.

As your tour guide, I will take you through the tour quickly, stopping to explain points of interest. You can explore all the aspects of Alarms by going to the Alarms chapter on page 40. The first step of the tour is to go to the Project Manager dialog and create a new project called *Guided Tour* and select *QUICKPANEL jr.* Color display as the display device. In the Project Setup dialog, I selected Omron for the PLC Type. (Omron was selected because there is one in my office attached to my testing system). Once you have completed the tour, you can go back and change the display type and PLC to match your system configuration.

The *QUICK MANAGER* dialog box should look similar to the one below.

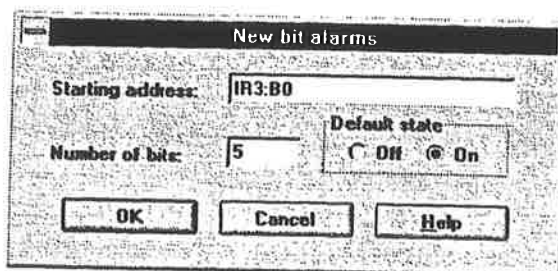


Click the Alarms button to display the alarm project manager dialog box. A blank alarm table for Bit Alarms is displayed. Each entry in the table consists of a bit Address, a bit State to trigger the alarm, and the alarm Message.

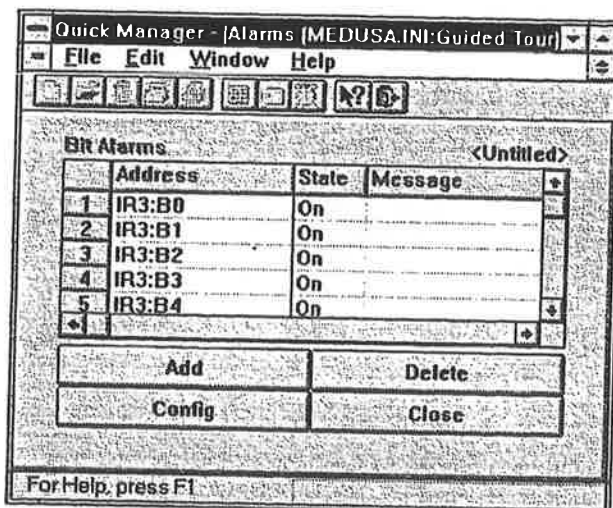


Create the Alarm Table

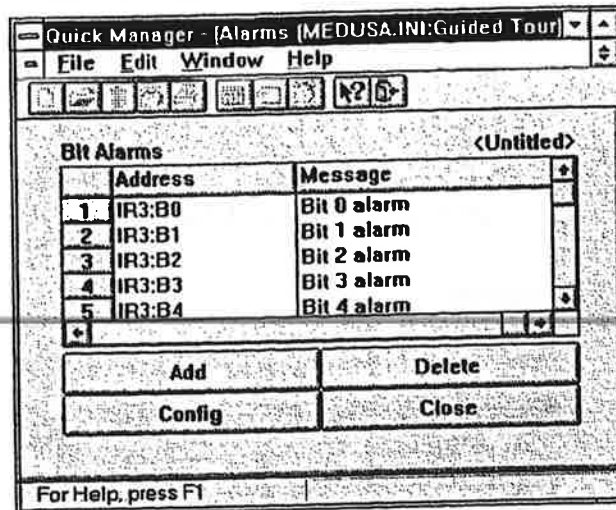
Click the Add button to display the New bit alarms dialog box.



Enter the starting address as IR3:B0 (Image Register 3, Bit 0). Enter the number of bits as 5 and make sure the Default state is set to On. Click OK and the alarm table is created.

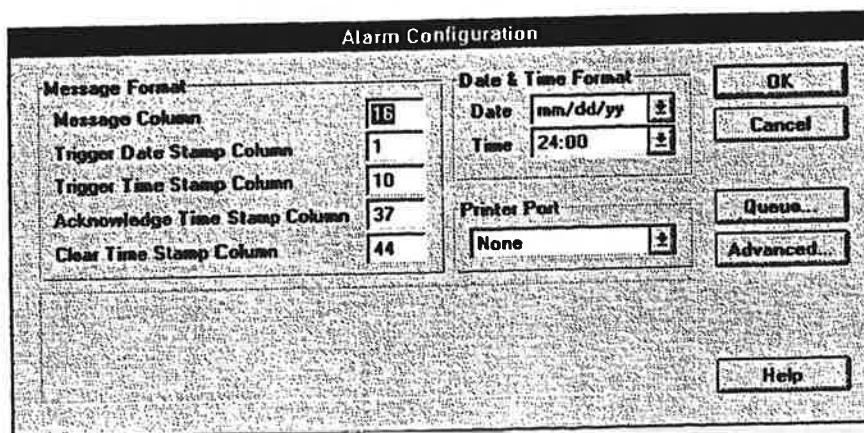


The *QUICKDESIGNER* software created the table starting at IR3:B0 and extending to IR3:B04, for a total of 5 bit addresses. The State column indicates that the alarm is triggered when the bit is turned On. Move the mouse cursor to the first empty space in the Message column and click the mouse. The space is highlighted, indicating that you can now enter message text. Type in the alarm message and use the Enter key to complete the operation. Enter the alarm messages shown in the next picture.



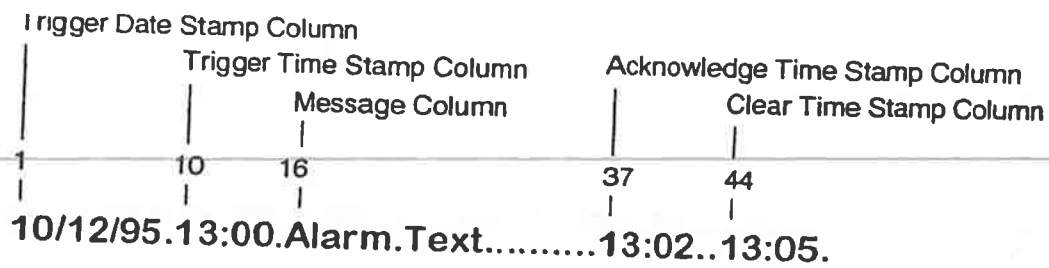
Alarm Configuration

The next step is to select the configuration options that determine how the alarm message is displayed in the alarm window. Click the Config button to display the Alarm Configuration dialog box.



Selecting the Message Format

The *QUICKPANEL jr.* Color display can show 49 5x7 characters in one line of the alarm window. The alarm message, date stamp and time stamps must fit in the forty-nine character space. The next drawing shows how a forty-nine character alarm window message might be formatted. The beginning of each column is indicated.

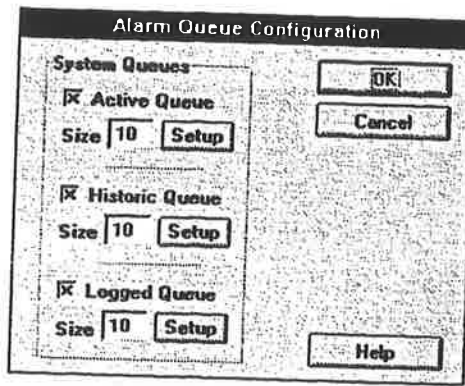


The Message Format section of the Alarm Configuration dialog box is used to select the starting column number of each portion of the alarm message. If you leave the settings in the default condition, the alarm message will appear on the display like the example.

Leave the Date format selection as mm/dd/yy. Leave the Time format set to 24:00. See the Internal Tags on page 40 for information about setting the time and date.

Configuring the Alarm Queues

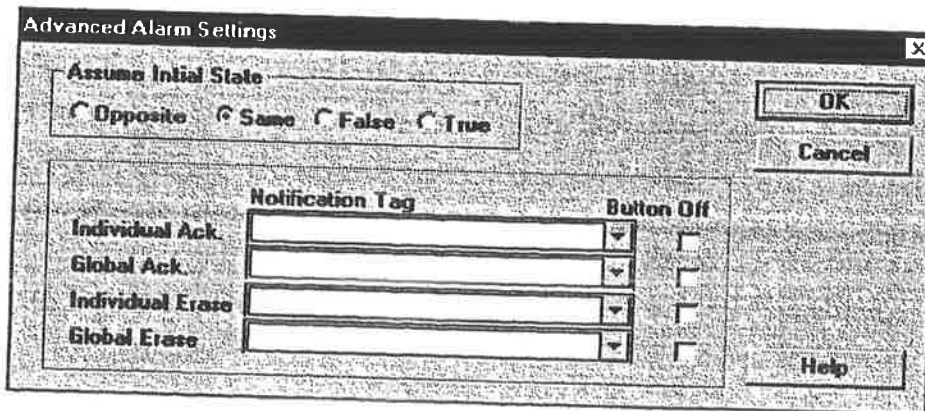
Click the Queue button to display the Alarm Queue Configuration dialog box.



The system queues hold the Active, Historic and Logged alarm messages and make them available to the alarm window. The default size of each queue is ten messages. If you do not need one or more of the alarm types, you can uncheck the boxes next to the queue name. When the number of messages exceeds the size of the buffer, the oldest message is deleted. Each queue has a setup button for changing the text size and color. If you are curious about what the Setup dialog looks like, click the Active Queue Setup button. You can change the colors if you want, but for this tour, I left them set to the default settings. Click the Cancel button in the Alarm Queue Configuration dialog box to return to the Alarm Configuration dialog box.

Selecting Advanced Settings

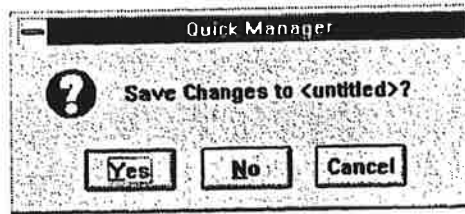
Click the Advanced button to display the Advanced Alarm Settings dialog box.



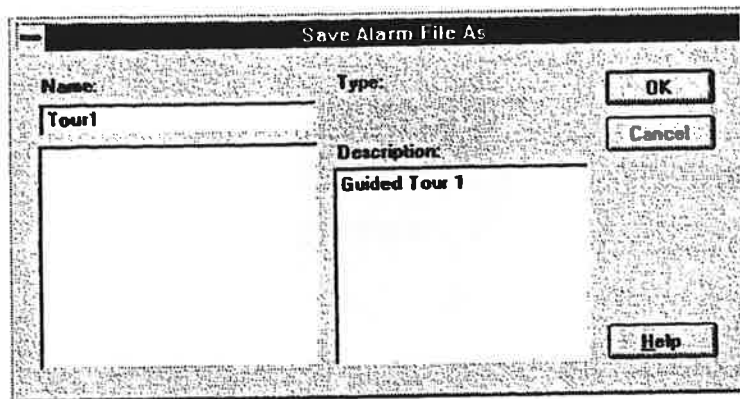
Make sure the Assume Initial State selection is set to Same. This is the correct setting for most applications.

The Notification Tags are bits in your PLC that are set when the Acknowledge or Delete buttons on the bottom of the alarm manager screen are pressed. You do not have to set these up now, so click Cancel and return to the Alarm Configuration dialog box.

Click OK to return to the Alarms screen. Click the Close button and the following prompt appears.



Click Yes to display the Save Alarm dialog box. Enter the filename as *Tour1* and the description as *Guided Tour 1*.




Click OK to save the alarm file and return to the Quick Manager dialog box.

Creating the Alarm Window

The Alarm window is used to display the formatted alarm message on a panel. For the next series of operations, you will use the Panel editor to create a panel with an alarm window.

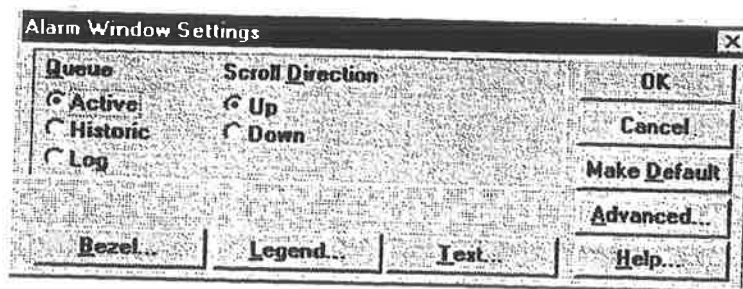
Click the Panels button in the Project Manager dialog box. The *QUICKDESIGNER* window appears with a blank panel and the Tools menu. The Tools menu is shown below.



Click the Alarm Window tool  and drag the alarm icon to the panel. Click the mouse over the desired panel location and the Alarm Window will appear.



The Alarm Window Settings dialog box will appear next to the Alarm Window. Set the Queue to Active, so that alarm messages from the Active Alarm queue will be displayed in the alarm window. As new messages are triggered, they will scroll into the alarm window either from the top or the bottom. The default setting of *scroll up* will show the latest alarm message on the bottom of the alarm window. I prefer the Scroll Direction as Down, where the latest alarm message appears at the top of the alarm window. Take your pick.



You can select the outline and bezel colors for the Alarm Window by clicking the Bezel button. The touch color appears when the operator touches the alarm window.

You can change the alarm window title by clicking the Legend button. You can select the text color, text size, background, and outline colors.

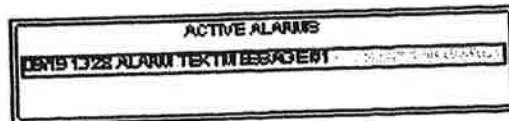
You can select the text color, background color, and text size of the alarm message as it will appear in the alarm window by clicking the Text button. I will leave the color selections up to you. When you are done, click the OK button to accept the changes and close the dialog box.

The alarm window that is now on your panel is too small to be of any use. Click on the alarm window and use the sizing handles to enlarge the window over four cells. This will allow you to see 49 characters across the display. Your alarm window should look like the one below.

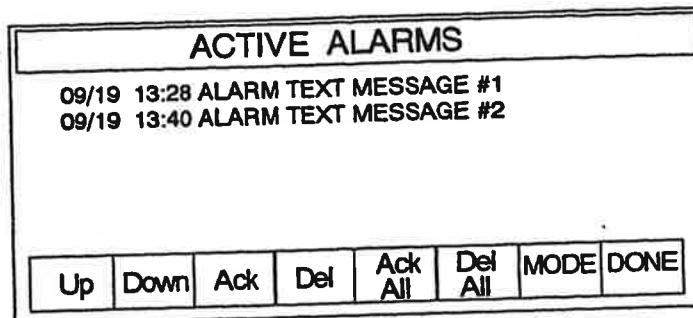


Select File/Save to save the panel using any name you like. Select File/Exit to exit the **QUICKDESIGNER** program and return to the Project Manager.

Download the panel to the **QUICKPANEL jr.** When the download is complete, select the alarm panel. My test PLC has a row of switches wired to inputs that correspond to the address settings in the alarm table. When a switch is thrown, an alarm bit is set ON and the alarm message will appear in the alarm window. The format of the alarm message will determine how it is displayed. A sample alarm window is shown below.



Touch the alarm window to bring up the alarm manager page and the Active Alarm queue.



The alarm manager page looks different when you are using a keypad option. See Keypads, page 194 and Keypad Assignment, page 91, for additional information.

You **MUST** touch the **MODE** button to activate the small buttons on the bottom of the panel. The **DONE** button is always active. Press the **Ack** button to Acknowledge the alarm and the acknowledge time stamp will appear. If there are multiple alarms, you can acknowledge all of them by pressing the **Ack All** button.

You can delete individual or all of the alarms in the queue by using the **Del** or **Del All** buttons. Use the **Up** and **Down** keys to move the cursor to different alarms. Press the **DONE** button to return to the alarm panel. The alarm window will show if the alarm has been acknowledged. If the alarm is cleared or deleted, the Active Alarm window will not show the alarm. However, the alarm message is stored in the Historic and Logged alarm queues.

QUICKCOURIER

Introduction to QUICKCOURIER

Quickcourier is a software module that is responsible for sending or receiving data between your computer and a QuickPanel display.

A download is defined as sending a file from the computer to the display. When you start a normal download, all panels are tested for proper format. Any errors in the panels must be corrected before a download operation can begin.

The panels, the alarm file, the PLC setup file, the display setup file, and any other files necessary to create the project in the display are *compiled* into a download file. The file is then handed over to QUICKCOURIER, which is responsible for communications with the display. You can download a previously compiled file, which will be discussed later.

QUICKCOURIER sends a message from the selected COMM port to see if it can communicate with the display. Once the communication link is established, it will determine the state of the display and if it is ready to receive the download file. It checks for the correct type of display and identifies files that were previously loaded. The QUICKCOURIER dialog displays prompts for the operator, indicating the current operation or problems.

The download operation should begin automatically and continue without manual intervention. When complete, the display will prompt the operator to select a panel or automatically display a selected panel. QUICKCOURIER will detect the end of a successful download and automatically terminate.

Download Files


A download file is *compiled* from several other files which were created by different software modules. The first file is a configuration file, used to configure a target display for operation with your PLC. The configuration information includes the name of the panel that appears after a power cycle, screen saver timeout, the serial port parameters, and other option settings. Without the proper configuration information, the target display will not communicate with your PLC.


Other files include panels that will be displayed on the target display. Panels contain objects such as push buttons, pilot lights and bar graphs.


For each PLC there is a unique protocol driver file. You must have the correct protocol driver loaded into the target display in order to communicate with your PLC. The protocol file is called a display device executable file. During the download operation, the target display is tested to determine if a new display device executable file is needed.


Additional files, including alarm files, may also be included in the compiled download file.

There is one last file type that can be downloaded which is not part of the *compiled* download file. This file is called a *project* file and contains all the project information in raw format. It is similar to an exported project file. This file can later be uploaded and used like an imported project file.



The Download Project button  is used to create a project file and hold it for later use. Press this button then the standard download button and the current project will be compiled along with the project file and sent to a QuickPanel. Press this button then the new Compile File button, and the current project will be compiled and saved with a project file. The button is reset after a compile is completed.

Selecting *Upload* is the same as clicking the Upload Project button.  The Upload Project button is used to upload a *project* file from a QuickPanel. The project file must have been saved with the downloaded file, otherwise an error message will appear. When the project file is uploaded, it is saved the same way as an imported project. The project can then be edited using QuickDesigner software. The file can be compiled and downloaded back to the QuickPanel or saved for other purposes.

Selecting *Compile to File* is the same as clicking the Compile File button.  The Compile File button will compile the current project and allow saving it to a selected directory. This allows saving compiled files without having to download to a connected QuickPanel. You can then use the Download File button to send a compiled file (*.cmp) to one or more QuickPanels. You can add the current project file to the compile file by clicking the Download Project button before clicking the Compile File button.

Selecting *Download from File* is the same as clicking the Download File button.  The Download File button allows the user to select a compiled file (*.cmp) and send it to a QuickPanel. You do not have to compile a file prior to a download, if a compiled version of the project is available. The current download button will still support the standard compile and download operation.

Download Operation

Click the Download icon  or the Download File icon  in the toolbar. You can also select Download or Download File from the Project menu.

Setup for a Download/Upload

1. Install power to the target display device. See the Hardware Reference manual for details.
2. Connect the download cable between the serial comm port on your computer and the target display download port. See the example in the Download Cable section.
3. Make sure the settings in the Setup dialog boxes are correct for your serial port. Make sure you have at least one panel with valid operators.
4. Turn on the power to the display. Click the download button and note the operator prompt messages. If you run into problems, see the *Communication Problems* and *Download Trouble Shooting Guide* in a later section.

Target Display Condition

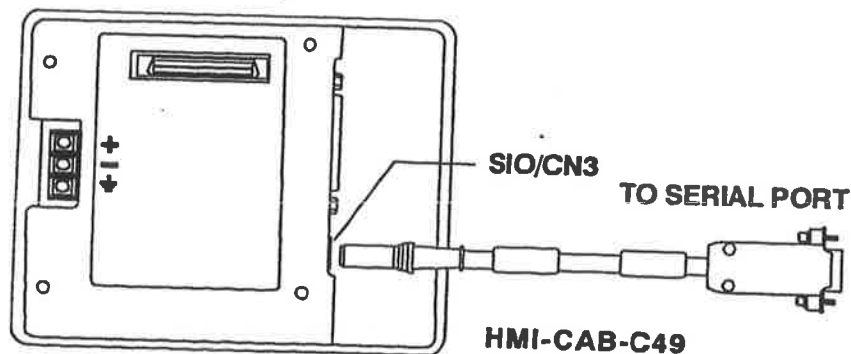
QUICKCOURIER (version 1.06 or later) software has the ability to read the display device status and determine which protocol has been loaded. Once **QUICKCOURIER** reads the status, it can automatically download a new application, including a new display device executable file if necessary. To enable this feature in **QUICKCOURIER**, you **MUST** have a version 1.06 (or later) device executable driver loaded in the target display.

*If you are upgrading to a new version software, you **MUST** download a new display device executable file.*

New factory units do not have a display device driver installed. When you apply power to a new unit, it will display a message indicating it is ready to receive a display device executable file.

Download Cable

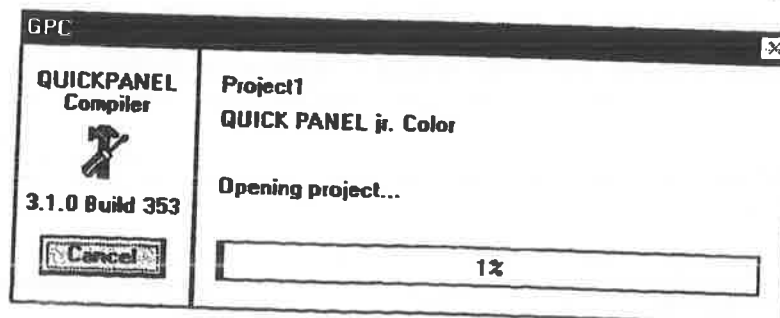
Connect the **HMI-CAB-C49** cable from your computer port to the target display. The following drawing shows a **QUICKPANEL jr.** and a **HMI-CAB-C49** cable connected to the download port.



DO NOT USE A HMI-CAB-C50 CABLE

Compiler

When the download operation is selected, a compiler program starts automatically. This program checks the panel designs for possible errors, then assembles the panel information for the download operation. All of the other files required for a download, except a *project* file, are included in the compile. A sample compile operation information box is shown below. If the compiler finds an error, it will stop and display the name of the panel and the error condition. Click the Cancel button to exit the compiler program. See the Appendix for more information about the compiler.

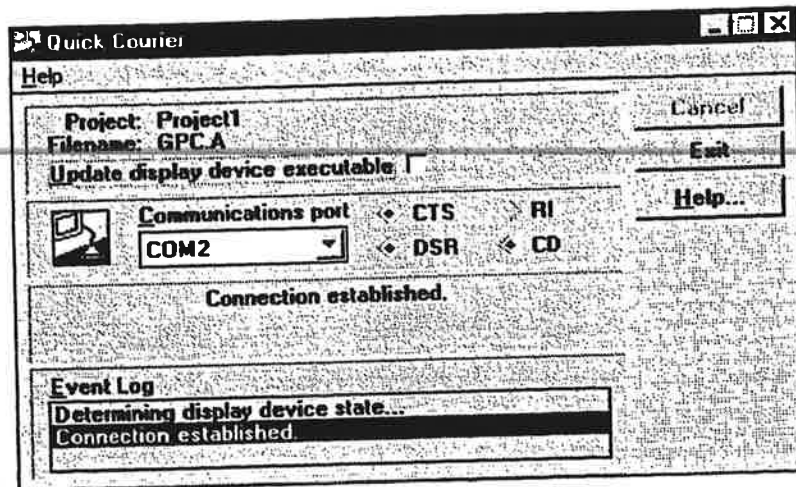


QUICKCOURIER

When the compiler completes assembling the files, it hands the *compiled* file over to *QUICKCOURIER*, which will handle sending all files to the target display.

QUICKCOURIER has the ability to read the display device status and determine which protocol has been loaded. Once *QUICKCOURIER* reads the status, it can automatically download a new application, including a new display device executable file if necessary.

The *QUICKCOURIER* dialog box is shown below.



Update Display Device Executable

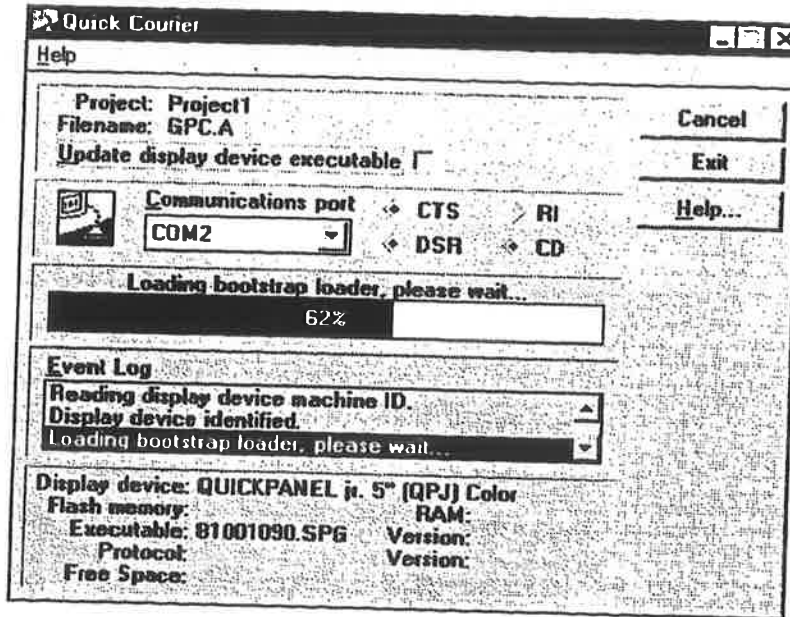
You can force *QUICKCOURIER* to download a display device executable file by checking the *Update display device executable* box. Downloading a new display device executable file is generally handled by *QUICKCOURIER*, because it can determine the state of the display and load any necessary files. See Target Display Condition for more information.

Communications Port

The first time you use *QUICKCOURIER*, you will have to select an *unused* communication port on your computer. *QUICKCOURIER* will look for and display unused ports, but you must make the final choice. Once you select the port, *QUICKCOURIER* will attempt to use the port to connect to the target display. The status of some of the signal lines from the target display are shown next to the comm port list box. The dialog box will expand to show additional information about the target display. See the example dialog box in the following drawing.

Event Log

QUICKCOURIER will keep track of all operator prompt messages and allow you to view them in a scrollable window. See the Event Log in the following dialog box.



When the application download is complete, *QUICKCOURIER* will close and the *QUICK MANAGER* program will return. If you have a default panel selected, the panel will be displayed when the download is done. If no default panel is selected, the display device will show the following prompt.

Press To	Press For
Run	Next
Screen	Screen
'filename'	

Communication Problems

If you experience problems running *QUICKCOURIER* on systems with a FAX/MODEM card, it may be due to the corruption of the Windows™ 3.1 COMM.DRV driver. The software for your FAX/MODEM card may have replaced the original communication driver with a non-standard driver. To install the correct Windows™ communications driver, edit the SYSTEM.INI file and comment out the existing COMM.DRV line by placing a semicolon at the beginning of the line. Add the following line:

COMM.DRV = COMM.DRV

Some software may modify more of Windows™ and may require a complete reinstallation of Windows™.

To enhance our commitment to customer support, we have installed the TCP Bulletin Board, which can be reached by dialing (708) 345-5880. The Bulletin Board is divided into product groups. There is additional information concerning communication problems located in the *QUICKPANEL* product group.

Download Trouble Shooting Guide

1. Are you using a C49 cable manufactured by TCP? The C49 cable converts RS232 from your PC to TTL levels that the QUICKPANEL can accept through the download port. C50 cables will *not* work with QUICKPANELS.

Solution: Acquire TCP C49 cable.

2. Is your PC at least a 386DX/25 with 4M of RAM? If you are using anything less it is possible that it is taking too long for your PC to respond to the QUICKPANEL when downloading the executable. The executable download is very timing dependent.

Solution: Try a faster computer.

3. Are you using the Standard Windows communication driver? Open your C:\WINDOWS\SYSTEM\INI file. Look for a line that starts out "comm.driv =". If you are using the standard Windows comm driver the line will say comm.driv = comm.driv. If this line says anything else, you are not using the standard Windows comm driver and this driver may not be directly compatible with all windows applications.

Solution: Comment out this line with a semicolon and insert another line that reads "comm.driv = comm.driv". Now restart windows and try the download again.

4. Are your Comm ports OK? Exit windows and at the DOS Prompt in the Windows directory, type MSD<Return>. Once MSD examines your system, zoom into the report on comm ports and note the following.

a. You must have only 2 comm ports available. If you have more than 2 comm ports, you may have an IRQ conflict.

Solution: Reconfigure your PC until this condition goes away.

b. Is the UART Chip for these comm ports a 16550? If your PC uses this chip, there is a bug in Microsoft windows V3.1 and V3.11 that may not allow you to run communication programs correctly.

Solution: The fix for this bug is available from Microsoft or from TCP's BBS (708-345-5880 -get file W31COM.EXE if using Windows V3.1 or WG1001.EXE if using V3.11. These files are self extracting and includes instructions on installation).

5. Are you using a laptop? If you are using a laptop it is possible that power management is probably shutting down certain devices in your PC during a download.

Solution: Turn off all power management and try again. Consult your PC manufacturer for details.

6. Has your hard disk been damaged? At DOS Prompt run chkdsk.exe. If it reports any problems, areas of your disk may have been damaged. These may include the QUICKPANEL Editor.

Solution: Run chkdsk with /f option or scandisk to repair, then reinstall the QUICKPANEL Editor, try again. If still unable to down load reinstall Windows then try again.

7. Try downloading from another comm port on your PC.

8. Try downloading from another PC.


9. Try a different C49 cable.

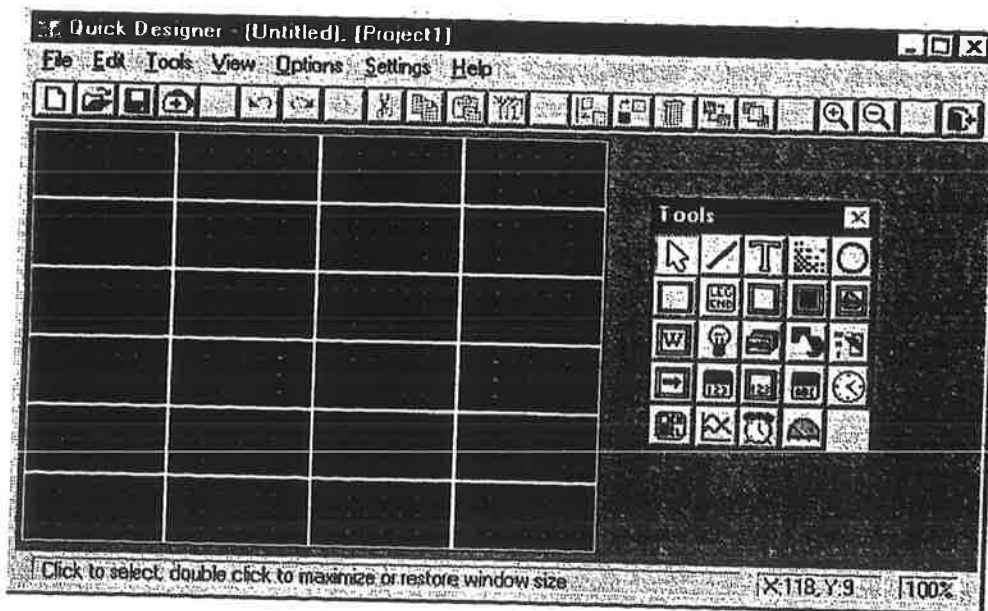
10. Try a different QUICKPANEL.

If all of the above fails or if you are unable to complete any of the above steps, call TCP QUICKPANEL Product Support Services 708-345-5730 x407.

QUICKDESIGNER

QUICKDESIGNER Window

The *QUICKDESIGNER* window is used to create and edit panels for each project. To open the *QUICKDESIGNER* window, select Panels from the Components menu, click the Panels button in the *QUICK MANAGER* window or click the Panels icon  on the toolbar. A *QUICKDESIGNER* window similar to the one below will appear.



Menu Bar

Windows commands are listed on menus. Menus are represented by names in the menu bar at the top of each application window. In Windows, you select a menu, and then choose a command from that menu. Choosing the command carries out the action. The menu bar for the *QUICKDESIGNER* window is shown below.

File Edit Tools View Options Settings Help

The items listed on menus are most often commands that represent actions you can tell the application to carry out. Some menu items appear dimmed, some have check marks next to them, some may have ellipses (...) after their names, and others may have key combinations listed across from them.

Windows applications all follow certain conventions when listing items on a menu. These conventions signal that extra information about the menu commands follows.

MENU CONVENTION

- Dimmed command name
- Ellipsis after the name
- A check mark next to the name
- A key combination after the name
- A triangle at the right side

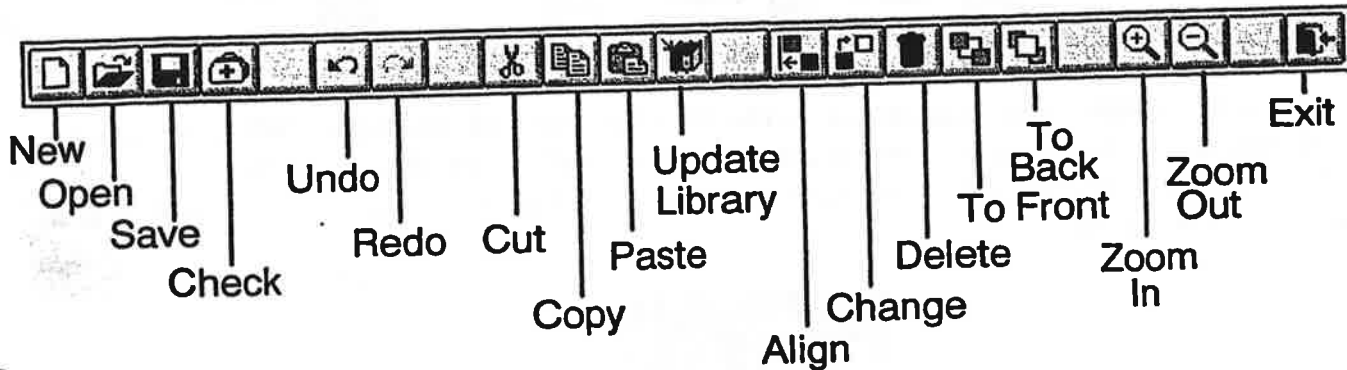
DESCRIPTION

- The command is not available at this time.
- A dialog box will appear.
- The command is active.
- A shortcut for this command.
- The command leads to a cascading menu.

To choose an item from a selected menu, click the item name.

Button Bar

The button bar contains icons relating to commands found in the menu bar. By clicking an icon, you gain instant access to frequently used commands. The *QUICKDESIGNER* button bar is shown below. You can turn off the Button Bar by unchecking the selection in the Options menu.



Status Bar

The status bar is located at the bottom of the window and contains context sensitive status information. The information changes are based on the location of the mouse and mouse selections. You can turn off the Status Bar by unchecking the selection in the Options menu.

The center field of the status bar shows the coordinates of the mouse as it is moved around the panel. The right field shows the view percentage. A 1:1 view is 100%.



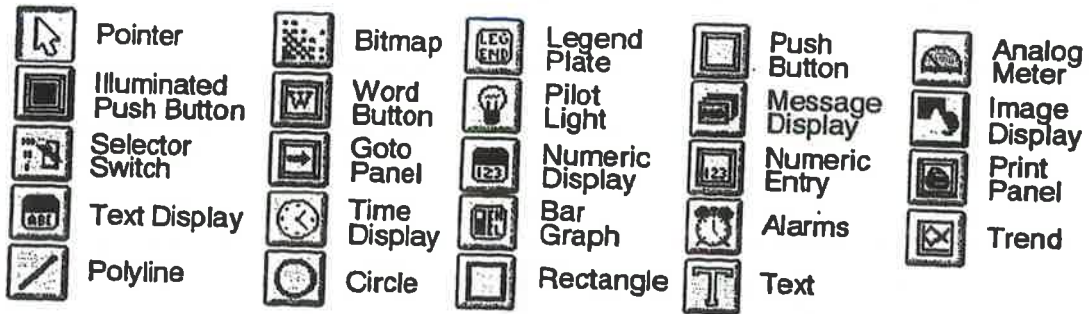
Right Mouse Button

If you click the *right* mouse button while the cursor is in the empty window space, the Options menu will be displayed. If you click the *right* mouse button while the cursor is in the grid area, a combination menu is displayed. The options in this menu include: Undo, Redo, Paste, View, Panel, Grid and Preferences.

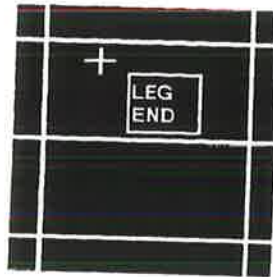
Creating a Panel

Tool Box

When the *QUICKDESIGNER* window opens, you are presented with a blank panel and the Tool box. The Tool box contains the icons for each type of available tool. You can also select a tool from the Tools drop-down menu. The Tool buttons are shown below.



Point with the arrow cursor to the desired icon in the Tool box and click the mouse. When the cursor is moved into the screen area, a cross hair will appear with a small image identifying the type of tool selected. The example below is the Legend Plate tool. The status bar on the bottom of the window will tell you which tool is selected.

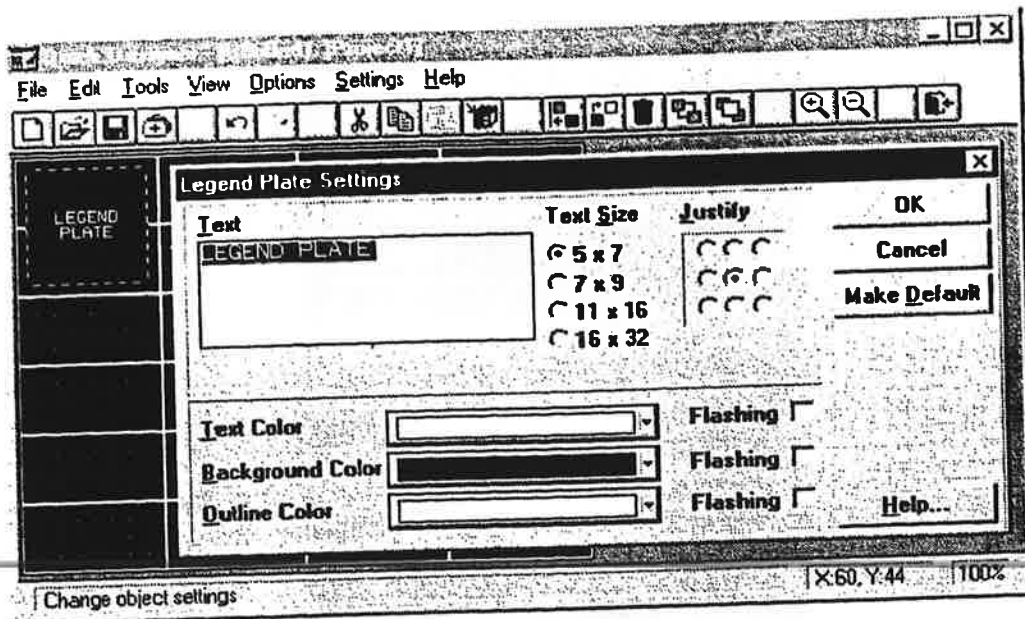


Move the cross hair to the desired cell and click the mouse. Most objects will appear across two cells as shown below.

If you want to size the object immediately, move the cross hair to the desired cell, click and hold the mouse button and drag the mouse to size the object. Release the mouse button and the object is sized.

A dialog box for the selected object will appear. The drawing tools work slightly different.

The object can be placed on the panel in several different modes, based on the selections in the Settings/Preferences dialog box.

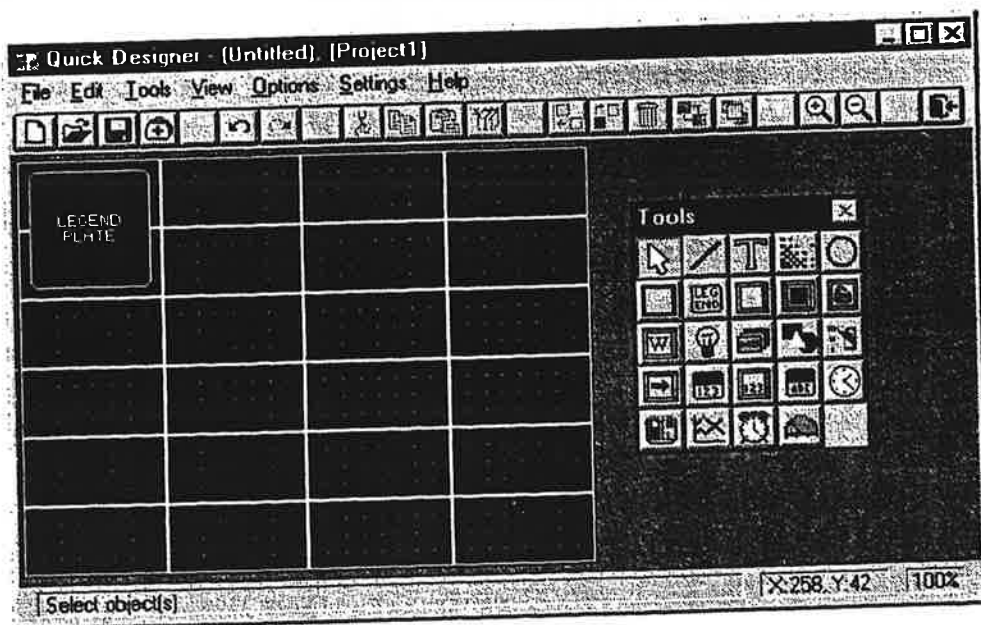


Dialog Box

The dialog box that appears will depend on the type of object selected. When the dialog box for a selected object is active, a dashed box appears around the object. In the previous example, a Legend Plate object was placed on the screen. The dialog box for the Legend Plate allows selecting the legend plate text, text size and color, background color and outline color.

Dialog boxes may contain buttons that open additional dialog boxes.

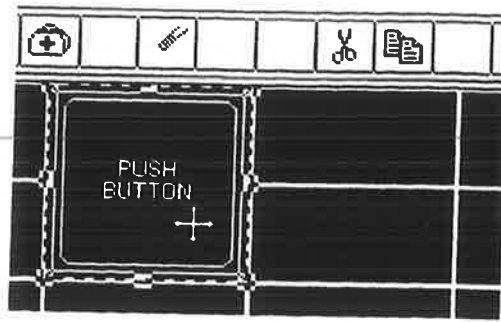
When the dialog box selections are completed, click the OK button and the dialog box is removed.



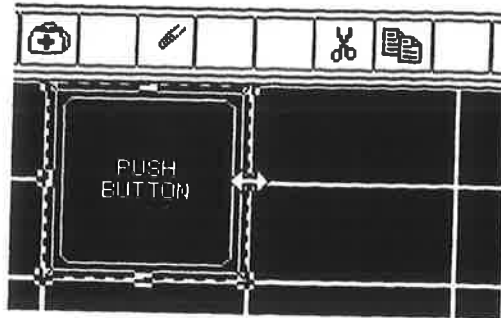
Sizing an Object

You can make objects larger or smaller by following the procedures below.

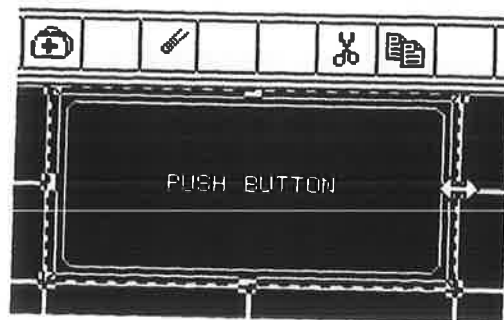
1. Move the cursor over an object and click the left mouse button. Dashed lines around the object indicate it is selected. Moving the cursor inside the dashed lines will change the cursor into a move symbol. Press and hold the left mouse button to move the object.



2. Move the cursor to one of the sizing handles (small boxes on corners and centers of edges). Sizing handles in the centers of the edges allow sizing vertically or horizontally, while corner handles allow diagonal sizing. The cursor will change to a double ended arrow when you are on top of a sizing handle.



3. Click and hold the left mouse button and drag the sizing handle in the direction selected. Click the mouse outside the dashed lines to deselect the object.



When sizing objects, the selections you make in the Grid Settings and Preferences dialog boxes will affect how you can size objects.

To make a small pilot light, turn off the "snap size to grid" option in the Grid Settings dialog box. All objects (except draw objects) have outlines for resizing. When you select an object, the outline first changes to a dashed outline and sizing handles appear. When you touch one of the sizing handles, the object outline changes to solid lines. The solid outlines aid in sizing the object exactly the way you want it.

Editing the Object

When you created an object, a dialog box for that object appeared. You can change the attributes of the object by double-clicking the object, which will display the dialog box. You can also display the dialog box by selecting the CHANGE option in the EDIT menu.

You can delete the object by clicking it, then pressing the DEL key or selecting the DELETE option in the EDIT menu. If you use the CUT option in the EDIT menu, the cut object is placed on the clipboard and saved until a new item is placed on the clipboard. You can delete a group of objects by pressing and holding the left mouse button and drawing a box around the objects to be deleted.

To copy an object, click the desired object, then use the COPY option in the EDIT menu. A copy is placed on the clipboard. Use the PASTE option in the EDIT menu to paste a copy of the clipboard contents to the screen. Remember, the clipboard is a temporary storage area. Items are kept there only until new items are copied to it. You can select multiple objects by clicking the first one, holding the Shift key and clicking additional objects. Use Deselect All in the EDIT menu or press the ESC key to deselect all objects.

When you are done designing a panel, use Save in the File menu to save the panel. Select New to start a new panel. Continue building and saving panels until your project is complete. When you have completed designing all panels, exit *QUICKDESIGNER* and return to *QUICK MANAGER* to download the project to the target display.

Grouping objects

Two or more objects on the panel can be grouped together so that they will act as a single object.

You can use 'select all' to select all objects for grouping. You can select several objects by clicking and holding the left mouse button as you draw a box around the objects. You can select multiple objects by holding down the SHIFT key and clicking the objects you want grouped.

Items remain temporarily grouped only until the next object selection. Select 'Group Objects' from the Edit menu (or use CTRL+G) to maintain the grouping.

Once you have grouped objects, you can use move, delete, library file, copy, etc. When objects are grouped using the 'Group Objects' selection, they remain grouped until they are ungrouped by the 'Ungroup Objects' selection.

Object Tag Display

You can view the Object Tag by enabling the option in the View menu. The sample drawing shows the tag name displayed in the upper left corner.



Keypad Tag Display

The keypad tag display is similar to the object tag display. The keypad tag operates independently of the object tag display. The keypad tag is displayed in the bottom left corner of the operator and provides a quick visual check to see which panel operators have keypads assigned. The keypad tag will appear with a panel print. You can view the Keypad Tag by enabling the option in the View menu.



Changing the Window View

You can change the view in the window from a zoomed out view of 50% to a zoomed in view of 800%. Select Zoom options from the View menu. Zoom buttons are provided for fast-view changes.

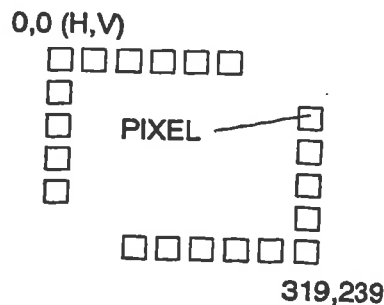
Panel Preview

You can see what the panel will look like on the target display by selecting 'Preview' from the View menu. A 1:1 full screen view is displayed.

Tiling and Drawing Grids

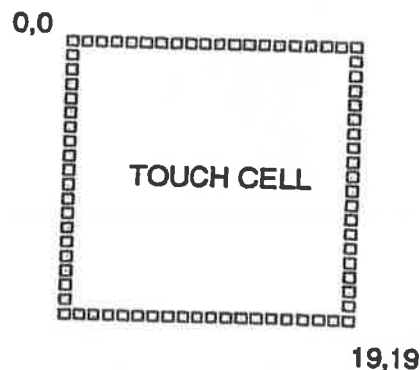
The *QUICKPANEL jr.* display is approximately 4 inches wide by 3 inches high. A pixel is a dot of light on the display panel. The *QUICKPANEL jr.* display is made up of 320 horizontal by 240 vertical pixels. Each dot has a unique address, specified by a horizontal and vertical coordinate. The origin is located in the upper left corner of the display and is designated (0,0). The opposite corner is the maximum pixel position, designated (319,239).

This drawing shows the two corners of the display with the pixels greatly enlarged.



Touch Grid

The touch screen is made up of cells that are 20 pixels on a side. The touch cells share the same coordinate system as the display. The first touch cell uses the pixels from coordinate (0,0) to (19,19). There is no physical display of the touch grid. You cannot change the number of pixels in a touch cell. The drawing shows the first touch grid with only the outline pixels.



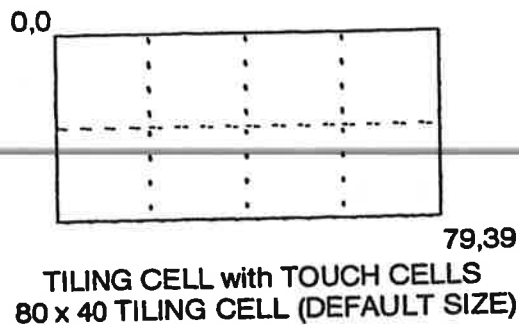
Part Objects

There are two types of part objects: those associated with touch regions and those not associated with touch regions. A push button is an example of an object associated with a touch region. A pilot light is an example of an object not associated with a touch region. Part objects associated with touch regions always occupy a complete touch cell. All touch objects must occupy a minimum of four touch cells.

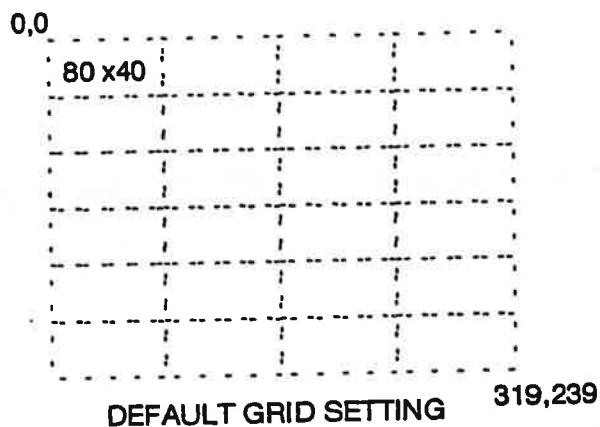
Tiling Grid for Objects

The tiling grid is a series of cells used to assist the designer in placing objects on the display. The tiling grid can appear as dots, lines or boxes. The cells appear only in the editor and not on the target display. Objects can occupy more than one cell as the cells are simply used as a layout guide. The default size of each cell is 80 pixels wide by 40 pixels high. The first cell origin point is located at (0,0) and the opposite corner is located at (79,39).

The default cell size of 80 x 40 pixels corresponds to 8 touch cells. The drawing shows a tile cell of 80 x 40 pixels and 8 touch cells.



The next drawing shows the tile grid for the whole *QUICKPANEL jr.* display. The default setting of 80 x 40 pixels produces 24 cells. The default Preference setting of 'Auto size on create' forces an object to be drawn on two cells (80 x 80).



Tiling Snap System

Another aid for placing objects on the panel is the snap feature. When placing an object on the tiling grid, the upper left corner of the object will snap to the upper left corner of a tiling cell. The remaining corners of the object attempt to come as close as possible to the snap points of the other cells. The object is restrained from snapping to the other cells in order to remain within the cells they occupy.

Snapping to grid points forces the object to be sized to the dimension of the cell. In some cases, the object may cover up the tiling grid. Objects that are associated with touch areas will first attempt to size themselves to complete touch regions. If the tiling grid is not an even multiple of the touch grid, part objects associated with touch areas will size differently than other part objects. Remember that touch areas are 20 x 20 pixels and touch objects must occupy a minimum of four touch areas (40 x 40).

Objects on the panel can be aligned to the grid using the snap feature. When moving an object, the nearest grid line will be the snap point. If you turn off the snap position option, objects can be placed close together and in some cases overlap.

Default Settings

The default settings for the tiling grid and snap are selected with the novice user in mind. These settings make it easy to quickly design a panel. The user selects a part object from the tool box and places it on the panel. The part snaps to a cell location and is drawn automatically. One mouse click for a part object to be created, sized and placed on the panel. The grid and snap system allows the user to create objects whose edges align and vertices intersect.

Drawing Grid

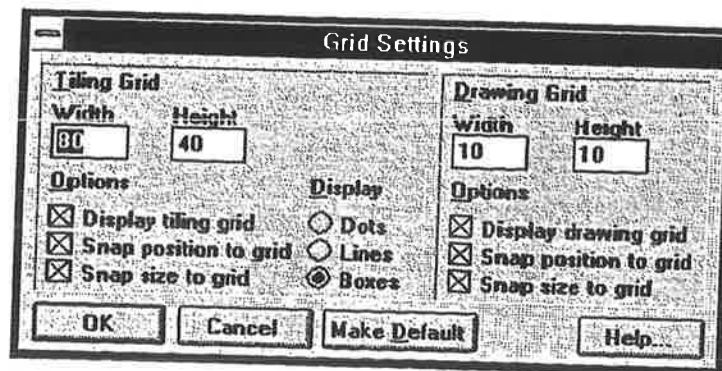
The drawing grid is a series of equally spaced horizontal and vertical dots used to assist the user in placement of objects on the display. Each grid point is a single pixel. The default setting is 10 x 10, which is a dot every ten pixels in both directions. The grid appears only in the editor but not on the target display. Object can overlap the points as they are only a drawing aid.

Drawing Snap System

The drawing snap system uses the drawing grid for locating snap points. When creating a draw object, a grid point nearest the mouse becomes the snap point. For example, if the grid is set to 5 x 5, and the mouse is located at position (4,4), the nearest snap point is (5,5). The snap feature and drawing grid can be turned off.

Grid Settings Dialog Box

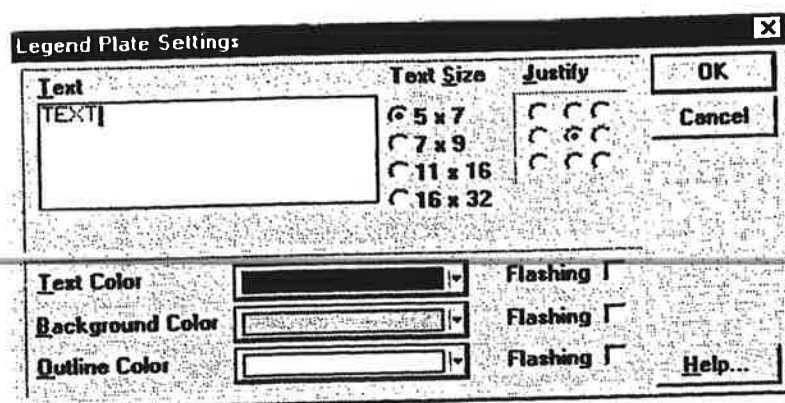
You can change the size and style of the tiling grid in the Grid Settings dialog box. The tiling grid can be dots, lines, or boxes, and can be turned off. The drawing grid is always dots. The drawing grid can also be turned off. The snap option can be turned off for both the tiling and drawing grids.



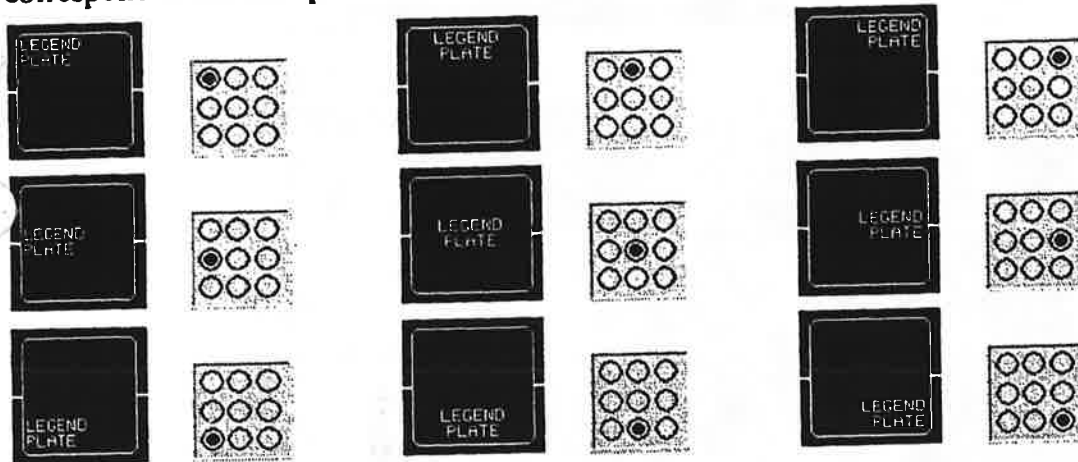
Text Justify

You can now justify text in legends, states, data displays and Alarm windows. Previously the text was automatically centered within the text field.

To change the justification of the text, click the appropriate radio button in the Justify box. The following dialog box shows Justify set to the center position. The dialog box also shows the new style color selection bars.



The following pictures show how text can be justified in a Legend Plate. Note how the radio buttons correspond to the text position.



Text Size

A new text size of 16 x 32 will now appear in the Text Size section of many dialog boxes.

Color Selection

Selecting color was done by clicking on one of the color sections on a color strip. Now it is done by clicking a single color bar, which causes a small color palette to appear. Click the color of your choice and the color bar changes to your selection.

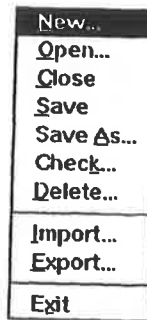
Other Editing Features

The panel editor is designed to operate so that you can quickly design panels. Once you are familiar with the methods used to add objects and create panels, you may want to change the way the editor operates. For example, you may not want the panel tested for overlapped objects. You may not want to see the grid displayed while editing objects. The Settings menu allows changing the panel background color, the settings of the grids, and three levels of user preferences. See Settings on page 94.

Menu Commands

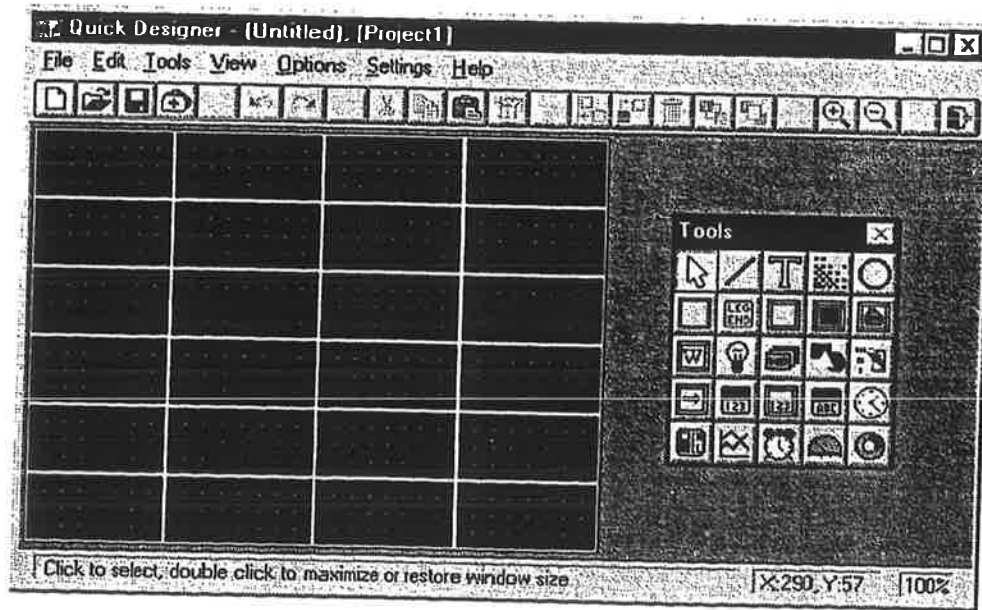
File Menu

The File menu is shown below.



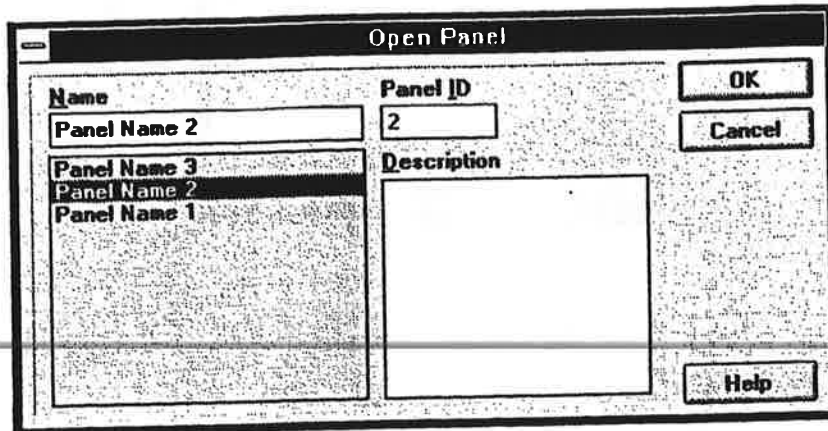
New

Start a new panel editing session. Selecting *New* will display a blank panel ready for editing. The panel size is determined by the type of display device you selected in the Setup dialog.



Open

Open an existing panel for editing. The panel name is shown in the Name box and the panel identification number is shown in the Panel ID box. If you entered a description of the file when it was saved, the text will appear in the Description field.



The 'Open Panel' dialog box features a title bar with the text 'Open Panel'. It contains a list box on the left with three entries: 'Panel Name 3', 'Panel Name 2', and 'Panel Name 1'. To the right of the list box is a 'Name' text field containing 'Panel Name 2'. Further right is a 'Panel ID' text field containing the number '2'. Below the list box is a 'Description' text area, which is currently empty. On the right side of the dialog, there are three buttons: 'OK' at the top, 'Cancel' in the middle, and 'Help' at the bottom.

Close

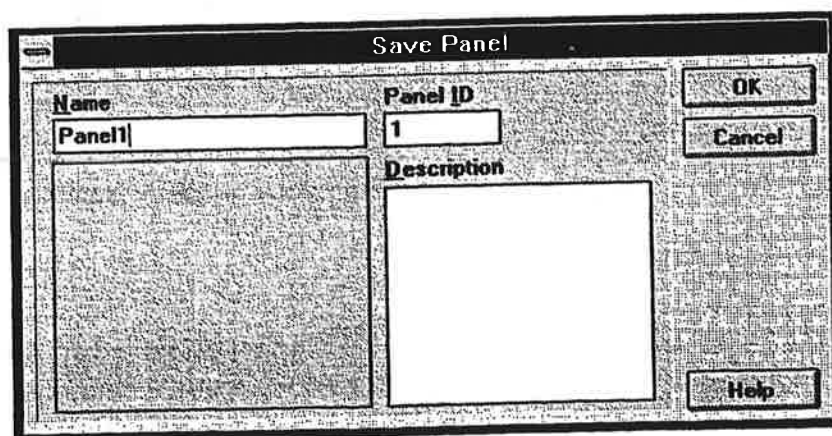
Close the current file.

Save

Save the current panel using the file name already assigned.

Save As

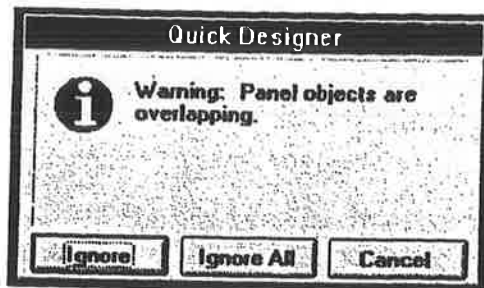
Save the current panel using a new file name. Enter the filename in the Name field. Move the cursor to the Description field and enter a description. The Panel ID is the identification number that can be used by a PLC to select a panel. When the ID number is written to the Panel Trigger Tag register in the PLC the associated panel will be displayed. The Panel Trigger tag is selected in the Quick Panel Configuration dialog box. See the *QUICK MANAGER* section. The system will automatically assign the panel ID when the panel is created. You can change it to any number up to 32766. Panel ID numbers must be unique within a project.



The 'Save Panel' dialog box features a title bar with the text 'Save Panel'. It contains a 'Name' text field with 'Panel1' entered. To its right is a 'Panel ID' text field with the number '1' entered. Below the 'Name' field is a large empty text area. To the right of this area is a 'Description' text area, also empty. On the right side of the dialog, there are three buttons: 'OK' at the top, 'Cancel' in the middle, and 'Help' at the bottom.

Check

Check the panel design for potential errors. Errors are reported in a dialog box and you will have the option of ignoring one or all errors. Error checking is automatic each time you save a panel.



Delete

Delete a panel from the list of panels for the current project.

Importing and Exporting Panels

If you create a custom panel for Project X and you want to use the identical panel for Project Z, the panel can be exported to an external file format and later imported to a new project. The exported panel objects have tag variables that are valid for Project X. When you are working on a different project, the custom panel is first imported. The tag variables for each object must then be changed to match the new project PLC type. The panel is then saved with the modified custom panel.

Procedure:

1. Go to the *QUICKDESIGNER* program and create a custom panel. Each object will have a tag variable that is valid for the project PLC type. Save the panel.
2. Select Export from the file menu and export the panel using a DOS filename. The file will be given the *.pnl extension. Example: filename.pnl
3. Exit the *QUICKDESIGNER* program and return to the *QUICK MANAGER* program. Create a new project or select an existing project. Go to *QUICKDESIGNER* and select Import from the file menu.
4. Import the desired panel. Change the tag variables for each object so that they are valid for the new project PLC type. Save the panel for the new project.
5. Continue to import other panels until the project is complete.

Import

Load a file saved in *.pnl format. When you import a panel with the *.pnl extension, save it with your own panel name. For example, if you import PANEL1.PNL, save it immediately to the new panel name of PANEL1.

Export

Save the panel design in *.pnl format. When you import a panel with the *.pnl extension, save it with your own panel name. For example, if you import PANEL1.PNL, save it immediately to the new panel name of PANEL1.

Exit

Quit the *QUICKDESIGNER* program.

Edit Menu

The Edit Menu is shown below. To the right of each menu option is a key or combination of keys. You can select the option from the menu or use the key/key combinations to perform the function.

Undo add object	Alt+BkSp
Redo add object	Shift+Alt+BkSp
Cut	Ctrl+X
Copy	Ctrl+C
Paste	Ctrl+V
Store Library Object...	Ctrl+L
Select All	
Deselect All	Esc
Align...	Ctrl+A
Change...	Alt+Enter
Change Object Tags...	Ctrl+T
Delete	Del
to Background	Ctrl+B
to Foreground	Ctrl+F
Group Objects...	Ctrl+G
Ungroup Objects...	Ctrl+U

Undo [last operation] (Alt+BkSp)

Undo the last operation. The undo command will indicate what type of operation was last performed.

Redo [last operation] (Shift+Alt+BkSp)

Redo the last operation. The redo command will indicate what type of operation it will perform.

Cut (Ctrl+X)

Remove the selected object and place it on the clipboard.

Copy (Ctrl+C)

Copy the selected object to the clipboard.

Paste (Ctrl+V)

Paste a copy of the contents of the clipboard to the panel. The contents of the clipboard remain until you cut or copy a new object.

Store Library Object (Ctrl+L)

The selected object or group of objects are stored in a library. See Library Browser, page 94 and 101, and Library Tour, page 98.

Select All

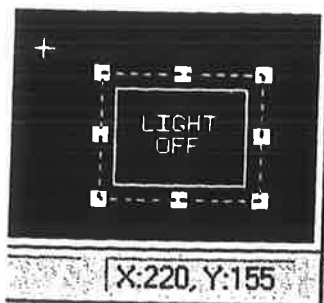
Selects all objects on the panel.

Deselect All (Esc)

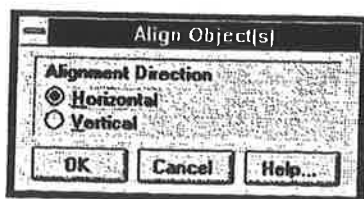
Deselects all objects that are currently selected.

Align (Ctrl+A)

Aligns the selected object to a vertical or horizontal coordinate. First select the object, then select align from the Edit menu. A cross hair cursor will appear on the screen.



The cursor position information box is located in the bottom, right corner of the screen. Move the cursor to the desired position and click the left mouse button. The following dialog box appears. Select Horizontal or Vertical alignment. Click OK and the object will be aligned to the selected coordinates.



Change (Alt+Enter)

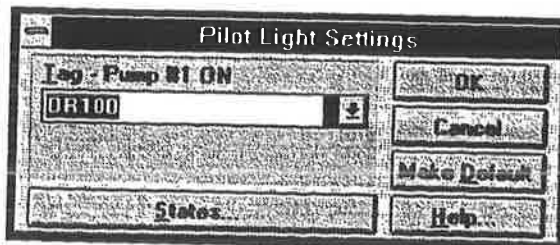
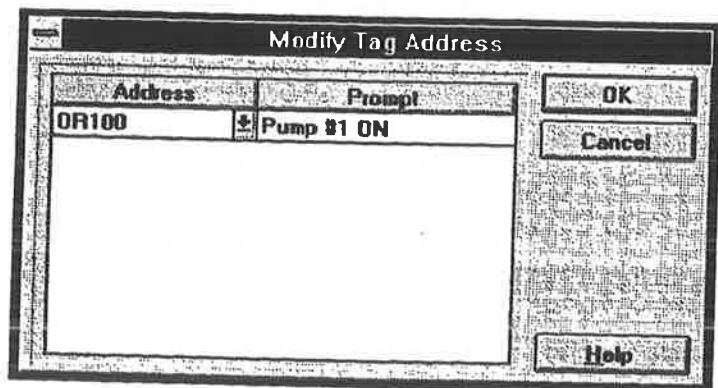
Change the attributes of the selected object. You can also double click an object to display the associated settings menu.

Change Object Tags (Ctrl+T)

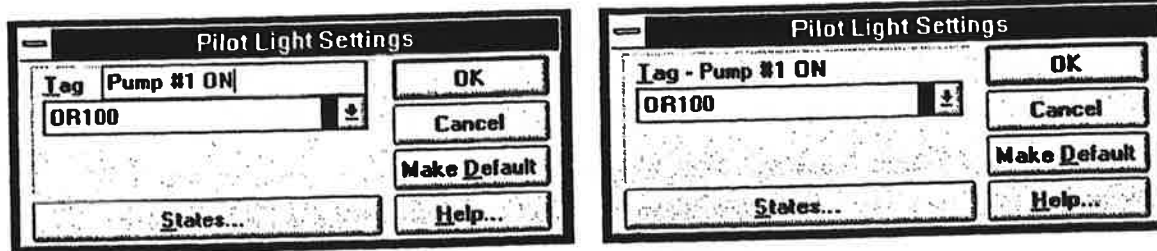
Modify the Tag Attributes of a selected object or group of objects. The Modify Tag Attributes dialog box appears.

You can edit the Address by clicking the name and typing a new name. Double click (F2) the name to enter the edit mode. Use ESC to undo the edit mode. Select a different Address by clicking the down arrow to display a list box.

The Prompt field is used to enter a description of the tag. The prompt will appear in any settings dialog box where the tag is used. You can edit the Prompt text the same way you edit the Address text. The example shows the Prompt text in the Pilot Light Settings dialog box.



You can also enter a new tag prompt by double clicking in the area above the tag field. Enter the prompt and press return.



Delete (Del)

Delete the selected object from the screen. Object is not placed on the clipboard.

to Background (Ctrl+B)

Selected panel objects can be moved from the foreground to the background.

to Foreground (Ctrl+F)

Selected panel objects can be moved from the background to the foreground.

Group Objects (Ctrl+G)

Two or more objects on the panel can be grouped together so that they will act as a single object.

You can use 'select all' to select all objects for grouping. You can select several objects by clicking and holding the left mouse button as you draw a box around the objects. You can select multiple objects by holding down the SHIFT key and clicking the objects you want grouped.

Items remain temporarily grouped only until the next object selection. Select 'Group Objects' from the Edit menu (or use CTRL+G) to maintain the grouping.


Once you have grouped objects, you can use move, delete, library file, copy, etc. When objects are grouped using the 'Group Objects' selection, they remain grouped until they are ungrouped by the 'Ungroup Objects' selection.

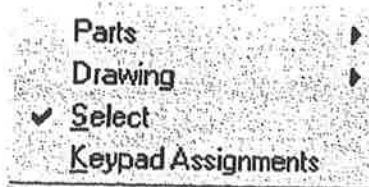
Ungroup Objects (Ctrl+U)

Objects that are temporarily grouped are ungrouped by selecting another object. When objects are grouped using the 'Group Objects' selection, they remain grouped until they are ungrouped by the 'Ungroup Objects' selection.

Tools Menu

The Tools pull-down menu allows selecting Parts (pilot lights, buttons, etc.), Drawing tools (Polyline,

Circle, Rectangle, etc.), or the Select tool . All of the Parts and Drawing tools in the tools pull-down menu are available as icons in the Tools pop-up menu box. The Keypad Assignments selection is used with the Keypad option. See the Keypad section for additional information.



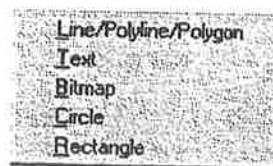
Parts

Parts include all the objects shown in the following list.



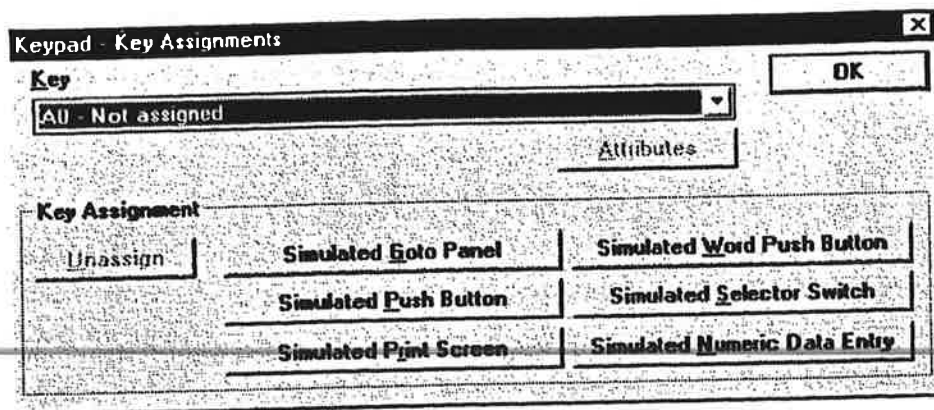
Draw

Draw tools include any tools used to create static pictures. You can use the drawing tools to create a picture of an operation, process, or function. Pictures in BMP format can be added to panels to further enhance the graphic image. Dynamic parts can be added to create a true interactive operator interface.

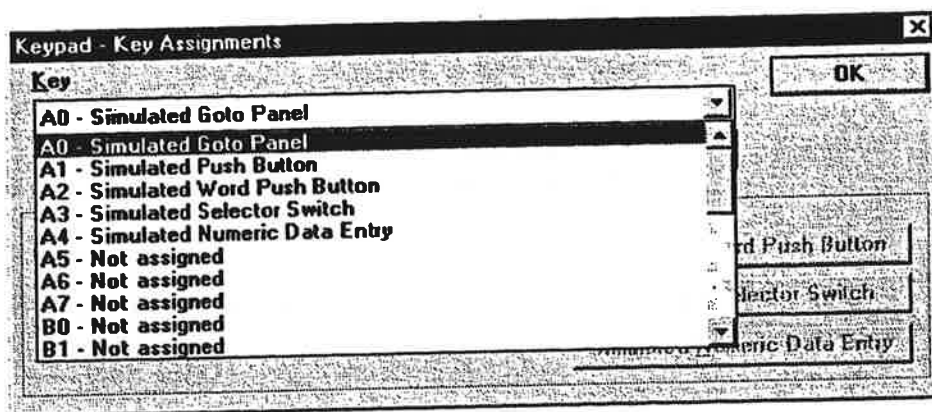


Keypad Assignments

Keypad Assignments is a menu selection used only with the Keypad option. The Keypad Assignment dialog box has a list box for displaying the keypad assignments and a series of buttons for creating simulated operators, such as a simulated push button.



You can view all the keypad assignments by clicking the down arrow in the Key list box. A keypad assignment list similar to the one below will appear. You can change the attributes of any simulated operator by selecting the keypad from the list, then clicking the Attributes button. Note that simulated operators are marked as *Simulated*. To change the attributes of normal operators assigned to keypads, you must use the panel editor and double-click the operator.

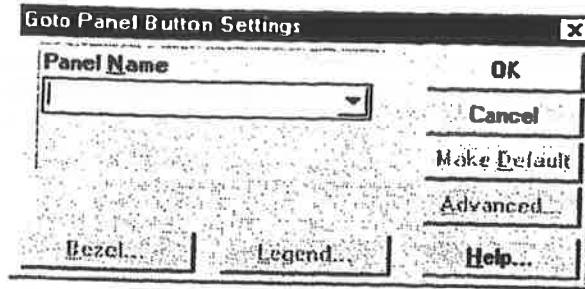


You can assign a keypad to simulate a panel object, even though there is no panel object visible on the screen. You can assign one of the keypads to simulate the following panel operators:

- Push Button
- Goto Panel Button
- Print Button
- Word Button
- Selector Switch
- Numeric Data Entry

The first operation is to select which keypad will be assigned to the simulated panel operator. Click the down arrow in the Key list box then click an unassigned keypad.

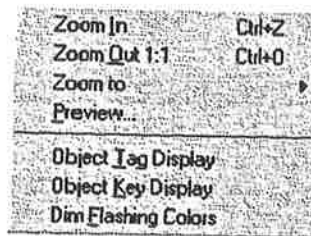
Next, select one of the operators to simulate by clicking a button in the Key Assignment area. When you click one of the simulate keys, the rest of the buttons will be grayed out. Click the Attributes button to display the setup dialog. A simulated Goto Panel dialog box is shown below.



Note that the Bezel, Legend, Make Default and Advanced options are disabled (grayed out). You only have to enter the Panel Name and click the OK button.

When you download the project file to a QuickPanel (with the Keypads option) the keypads can simulate a panel operator. For example, if you press the A0 keypad, which was selected to simulate a Goto Panel, the panel name you selected will be displayed. This is the same operation as the GoTo Panel Button, but without the panel operator taking up screen space.

View Menu



Zoom In

This selection enables the zoom in tool. Click the mouse while the zoom tool is present to zoom to the next level. Click and hold the mouse to draw a box around an area to zoom in. You can also use the zoom in button on the toolbar.

Zoom Out 1:1

Resets the view to a standard 1:1.

Zoom to ...

This option allows selection of several zoom settings.



Preview

The preview mode produces a full-screen image of the panel at a 1:1 viewing ratio. This preview will give you a good idea of what the panel will look like when it is viewed on the target display.

Object Tag Display

You can view the Object Tag by enabling the option in the View menu. The sample drawing shows the tag name displayed in the upper left corner.



Keypad Tag Display

The keypad tag display is similar to the object tag display. The keypad tag operates independently of the object tag display. The keypad tag is displayed in the bottom left corner of the operator and provides a quick visual check to see which panel operators have keypads assigned. The keypad tag will appear with a panel print.



Dim Flashing Colors

When you are creating panels, you have the option of selecting Flashing Colors. Flashing occurs only when the panel has been downloaded to a target display. To see which colors have been selected as Flashing, check the Dim Flashing Colors option in the View menu. Flashing colors will then appear as a different shade, or a dimmed version of the corresponding color.

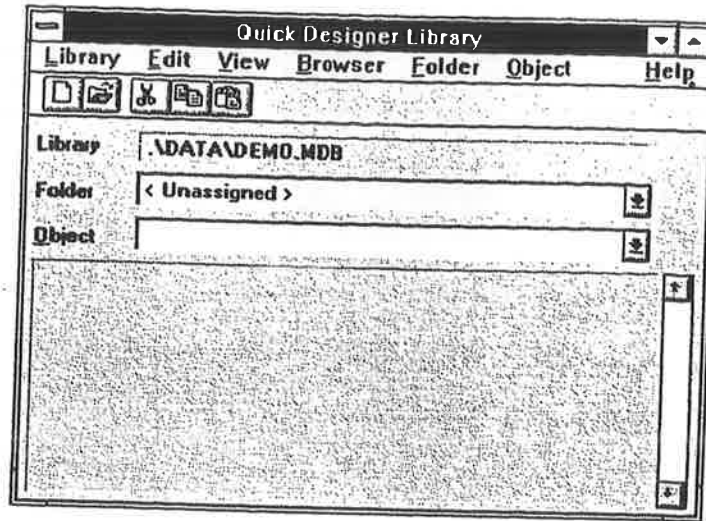
Options Menu

The options menu allows removing or replacing the button bar, status bar or tool box. You can display this menu by clicking the right mouse button when the cursor is in empty window space. If you click the right mouse button when the cursor is in the grid area, a different menu is displayed.



Library Browser

Selecting Library Browser from the Options menu will display the Quick Designer Library window. See Library Tour on page 98 and Library Browser on page 101.

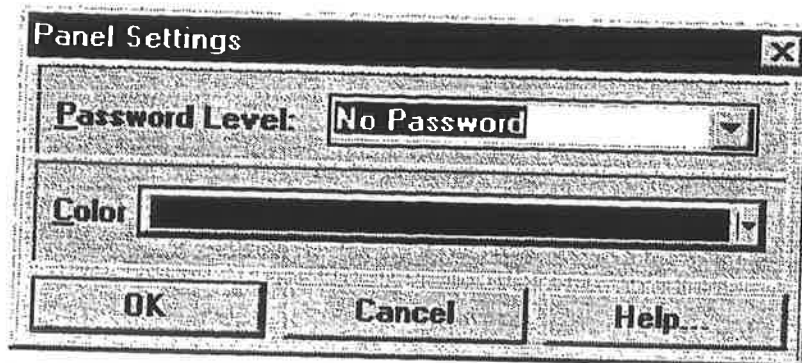


Settings Menu

The Settings menu has three options; Panel Settings for changing the color of the panel, Grid for selecting the grid type, and Preferences for changing object preferences.

Panel Setting

You can change the background color of the *QUICKDESIGNER* panel. The default setting is black. The following dialog box is for color units.

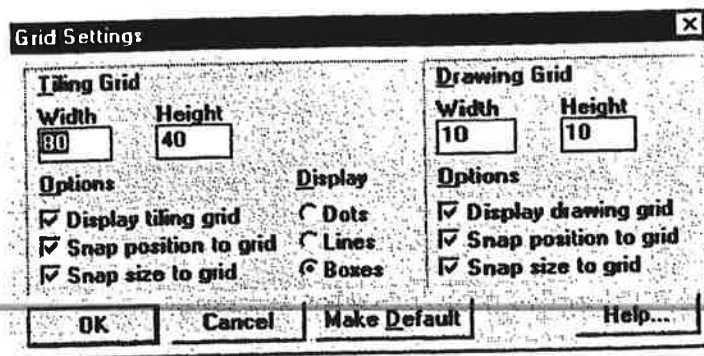


Panel Password

To set the password for a single panel, go to the Settings menu and select Panel. The Panel Settings dialog will appear. From the Password Level list box, select No Password, Operator, Supervisor, or Master.

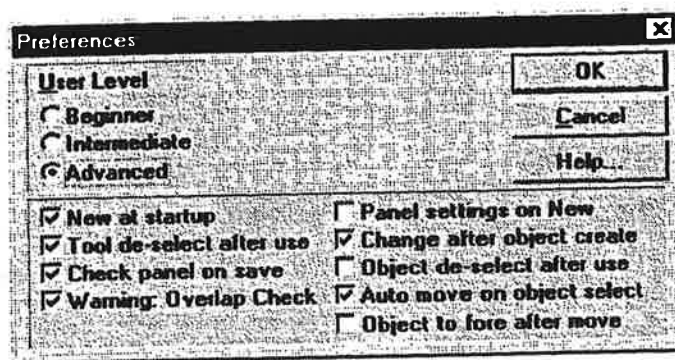
Grid Settings Dialog Box

You can change the size and style of the tiling grid in the Grid Settings dialog box. The tiling grid can be dots, lines, or boxes, and can be turned off. The drawing grid is always dots. The drawing grid can also be turned off. The snap option can be turned off for both the tiling and drawing grids. See Tiling and Drawing Grids on page 80 for more information about grids.



Preferences

The *QUICKDESIGNER* is set up to allow the novice user to quickly design panels. Some of the operations appear automatically, such as deselecting a tool after using it and automatically checking the panel when the file is saved. Some of the automatic operations can be turned off. If you are a beginner, most of the automatic operations are turned on. The intermediate level turns off a few of the automatic operations. The Advanced level allows you to pick the automatic operations you prefer.



Preference Options

New at startup: opens a new panel when *QUICKDESIGNER* starts.

Auto size on create: If checked, the selected object will be a fixed size when created. For example, a push button would be 80 x 80. Otherwise, the size of the selected object will be determined by the grid size settings. Some objects have a minimum size (push buttons are 40 x 40) and cannot be made smaller. Size also depends on whether the "snap size to grid" option in the grid dialog box is checked.

Tool de-select after use: when you are done using an object, the cursor will change to a pointer. If this box is not checked, the cursor remains the same as the last object selected.

Check panel on save: The panel design is checked for errors when SAVE is selected.

Warning: Overlap Check: warns that objects are overlapped on the panel.

Panel settings on New: displays the Panel Settings menu when a New file is started. Allows selection of black or white panels.

Change after object create: When an object is placed on the panel, a dialog box will appear. The dialog box is used to change settings for the object. If the box is not checked, the object is placed on the panel without the dialog box.

Object de-select after use: When you are done working with an object, it remains selected, indicated by a dashed line around it. Checking this box will de-select the object after using it.

Auto move on object select: You can select and move an object by clicking it and holding down the mouse button as you move it.

Object to fore after move: Places the object in the foreground after it is moved.

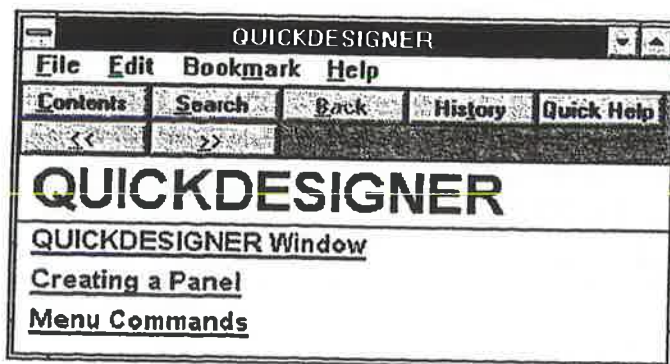
Help

The Help file contains most of the information found in the user manual, except it is in electronic format and in easy reach.



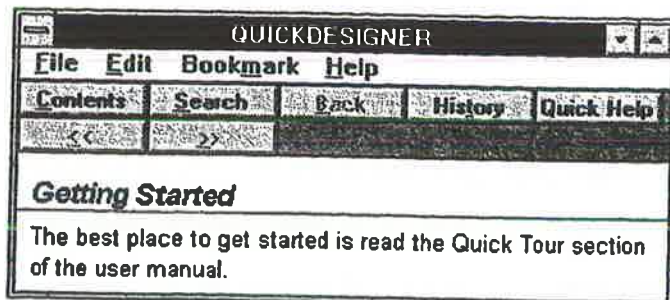
Contents

If you click on Contents, the QuickDesigner help screen is displayed.



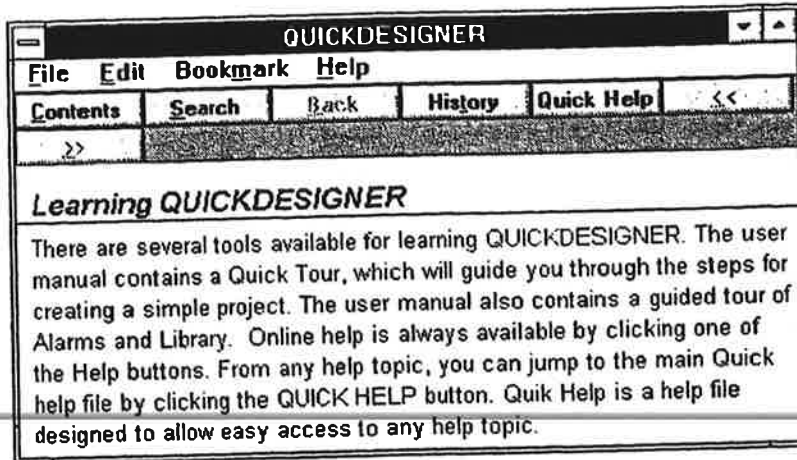
Getting Started

Getting started has been reduced to provide only a message box about the best way to get started using QuickDesigner.



Learning QUICKDESIGNER

A message box describing the tools available to learn QuickDesigner software.



About QUICKDESIGNER

Clicking the About option will display the splash screen for QuickDesigner. This screen will show the current software revision level, the user name and serial number. A new 'QD System Info' button can be used to display information about the QuickDesigner software or Windows. A list box allows selecting different file types.

Master Help

Once you enter the help system from any point, you can gain access to any other help topic by clicking the 'Quick Help' button, which will jump to the main Quick Help screen. This main screen has links to all other help topics, including protocol drivers, alarms, and all panel tools.

Library Tour

Library is a new feature that allows storing an object or group of objects in a database. Each library (you can have more than one) contains folders of neatly stored objects and groups of objects.

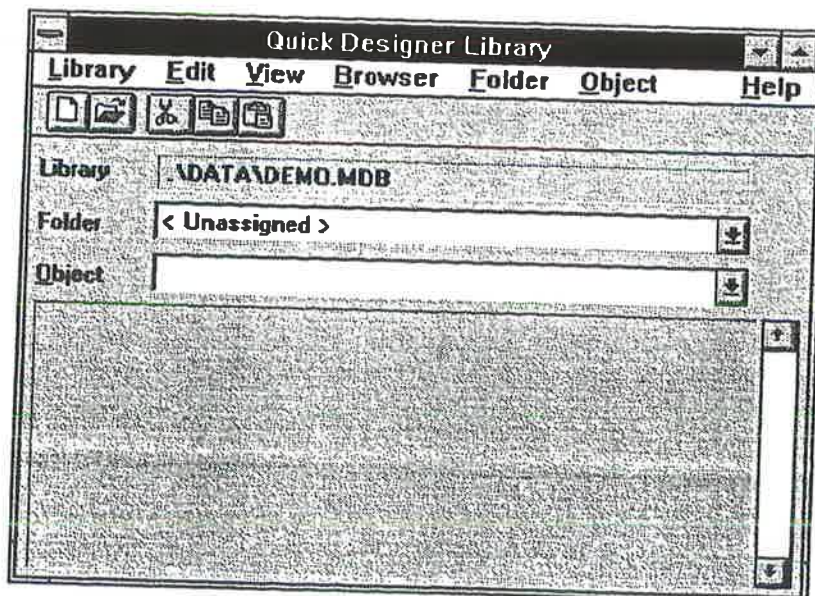
Summary of Features

- Objects and groups of objects can be stored in folders in multiple libraries.
- Drag 'n Drop feature allows fast panel design and saving objects.
- Folders provide for custom design of the database.
- Projects can be quickly built from libraries of objects.

When you create your favorite object, like a pilot light or selector switch, you can save the object in a named library folder. Later, when you want to make a copy of the object, the library feature allows for fast and easy selection and transfer of the object to your panel. You can create templates for panels and store all the objects as one file in a folder. You can design a complete panel and store it in a folder in the library.

This tour will demonstrate how to create objects and store them in a library.

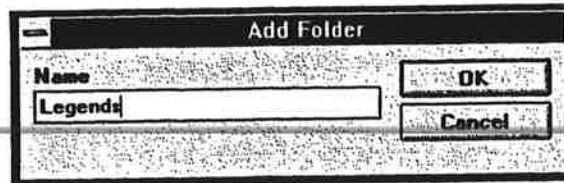
Create a new project and open QUICKDESIGNER. Select Options and click Library Browser to open Quick Designer Library.



Select New from the Folder menu.



Enter the name of the new folder in the Add Folder dialog box. In this example, the name *Legends* was selected. Click OK when done.



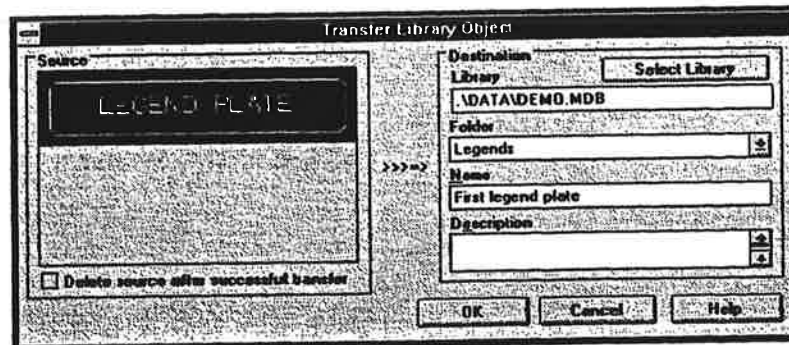
Select Exit from the Library menu to exit the Quick Designer Library.

The first object to create is a legend plate. In this example, all legend plates will have the same appearance but different text. Here is an example of a simple legend plate.



To save the legend plate in a library, click the legend plate to select it, then select Store Library Object from the Edit menu. The Transfer Library Object dialog box appears.

The selected object will be displayed in the Source box on the left side of the dialog box. The right side of the dialog box determines the destination. Select the Legends folder (created earlier) and type in the name of the object. There is an additional text input box for a description of the object. Click OK when done.



When the Transfer Library Object dialog box closes and the Quick Designer Library window stays open, select the Legends folder and the legend plate with a description should appear.

The Library function supports Drag-and-Drop, so that you simply select the object in the library by clicking and holding down the mouse button, then drag the object from the library to the panel. Once the object is on the panel, the setting dialog for that object will appear.

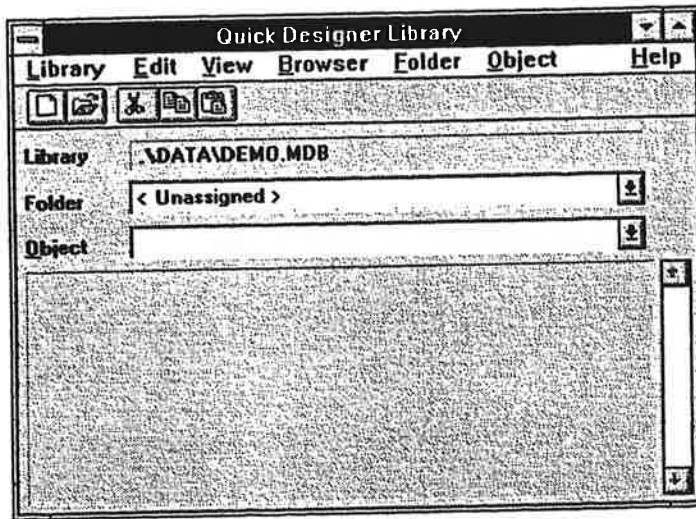
The custom legend plate can be placed on any panel by opening the Library Browser, selecting the folder, then dragging and dropping the desired object.

Quick Designer also supports grouping objects. You can select multiple objects that will act as a single object for moving, sizing, and other editing operations. The grouping can be temporary, as when you select multiple objects with the SHIFT key or by drawing a box around objects with the mouse. Objects that are temporarily grouped can be made permanently grouped by selecting Group Objects from the Edit menu. Grouped objects can also be stored and retrieved in the Library.

Library Browser

Quick Designer Library Window

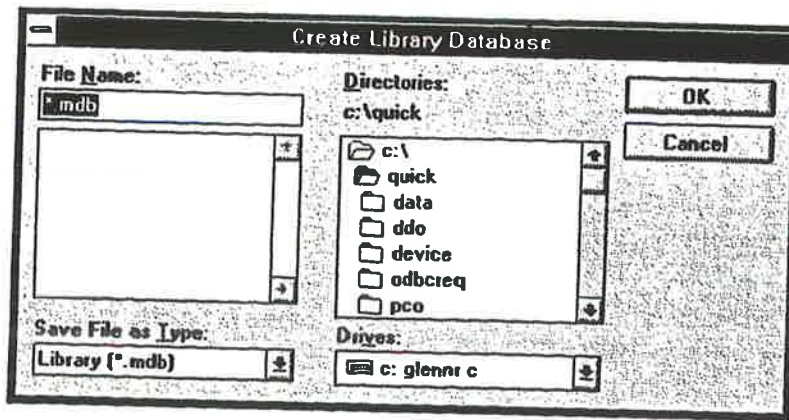
Selecting Library Browser from the Options menu will display the Quick Designer Library window. The tool bar contains icons for creating new libraries and opening an existing library. There are icons for cut, copy and paste. The window displays the contents of the current folder. You can select a different folder and any item within the folder with drop down list boxes.



Library

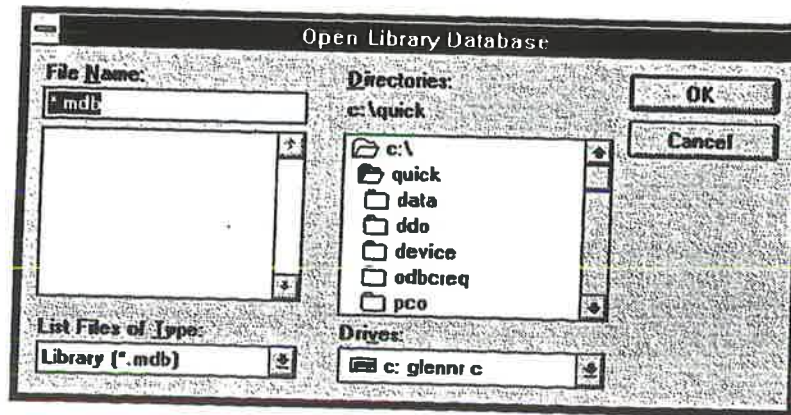
New

Creates a new Library database. Enter the file name and select the destination drive and directory. The default library file name extension is *.mdb. Click OK to complete the operation.



Open

Open a new Library database. Enter the file name and select the destination drive and directory. The default library file name extension is *.mdb. Click OK to complete the operation.



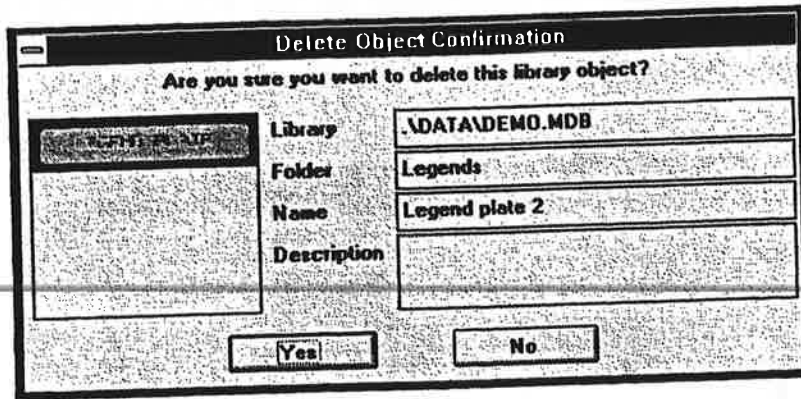
Exit

Close the Quick Designer Library dialog box.

Edit

Cut

Deletes the selected item from the Library. A delete confirmation dialog box appears. Click Yes to delete the object or No to abort the delete operation. There is no UNDO.

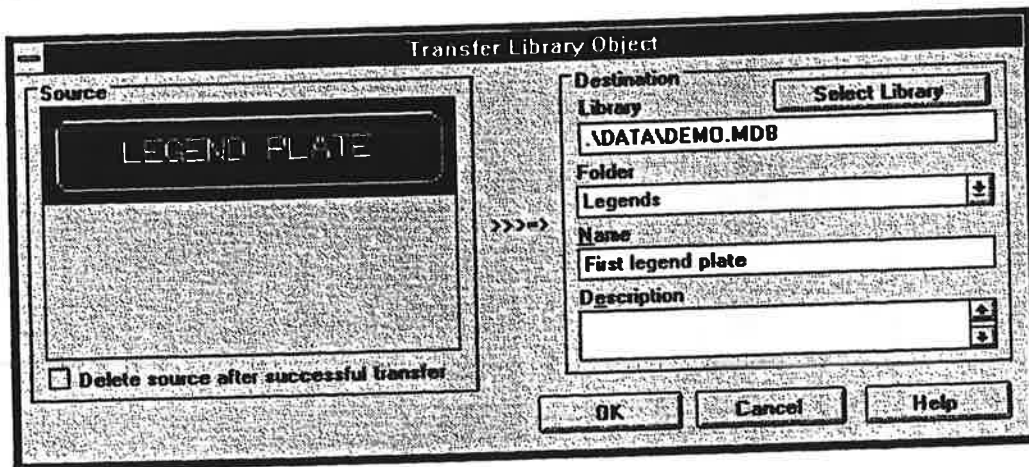


Copy

Copies the selected object to the clipboard.

Paste

Takes the contents of the clipboard and pastes it to a selected library and folder. The Transfer Library Object dialog appears. Select the destination library and folder, enter the name of the object and a description and click OK to complete the transfer.



View

Toolbar

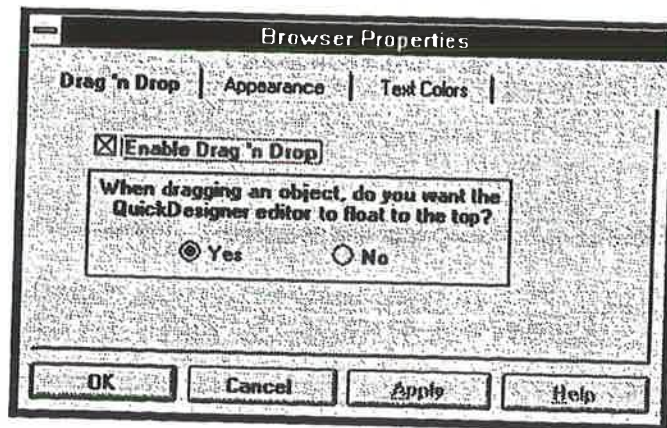
When checked, the toolbar is visible in the dialog box. Unchecking the option removes the toolbar from the window.

Browser Properties

Allows changing the properties of the Library Browser. The properties are arranged in a file box format. The tabs are: Drag 'n Drop, Appearance, and Text Colors.

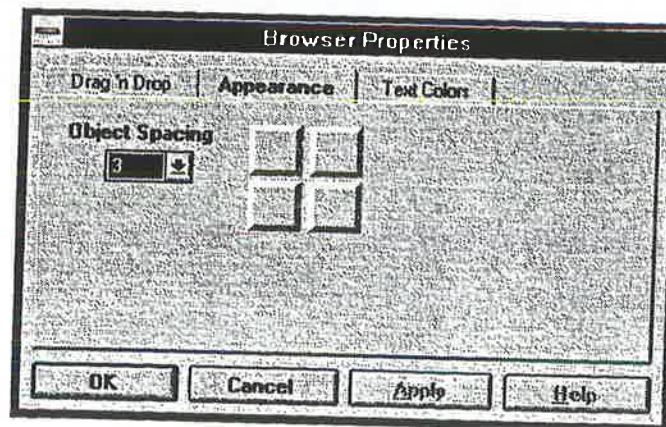
Drag 'n Drop

You can disable the Drag 'n Drop feature by unchecking the box. When an object is dragged from the library to a panel, the QUICKDESIGNER editor floats to the top. You can disable this feature by clicking No.



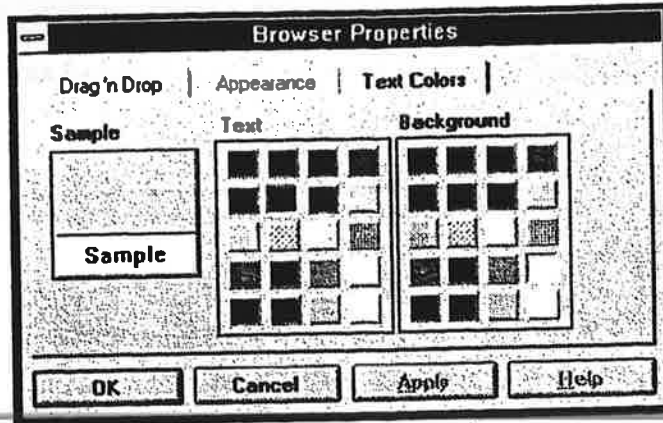
Appearance

You can change the spacing of objects by entering a new value in the selection box. The default setting is 3.



Text Colors

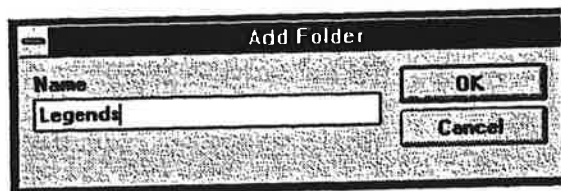
Select the text color and background color for the library objects name.



Folder

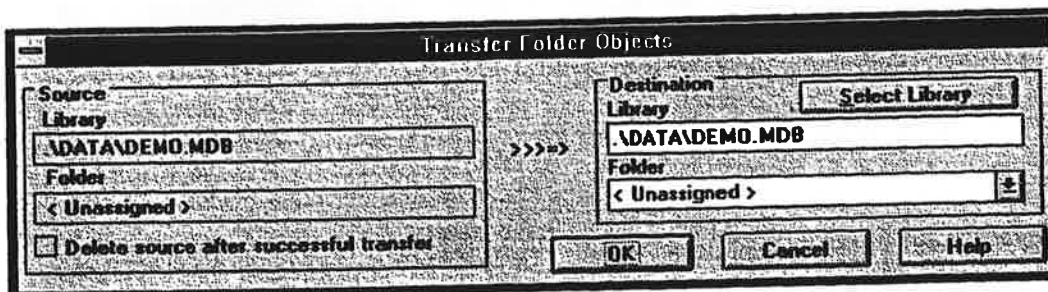
New Folder

Folders provide a convenient way of storing objects that are related in some way. You may want to store all push buttons in a folder, or panels from a project. You can copy objects from one folder to another and copy the entire contents of one folder to another. Enter the folder name and click OK.



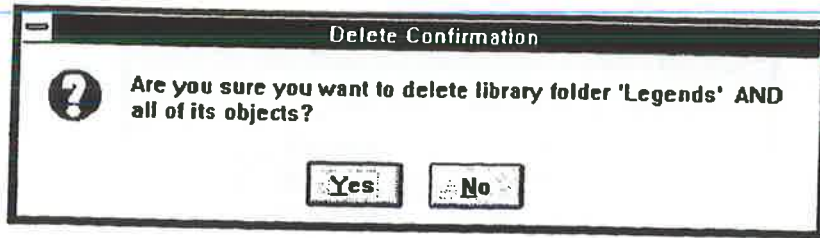
Transfer

Transfer is used to move the contents of the current folder to another. Select the library destination and the folder name and click OK.



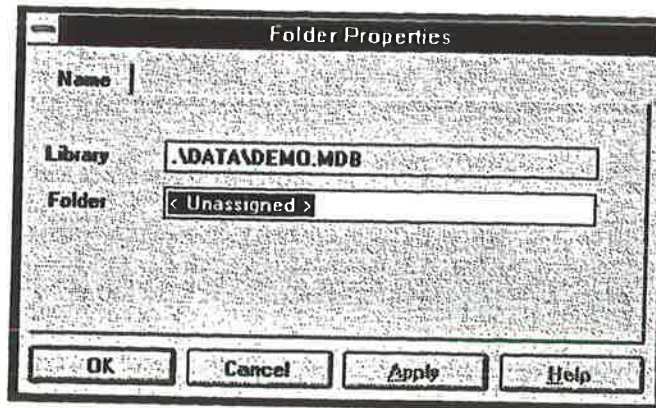
Delete Folder

Deletes the selected folder. A confirmation dialog is presented. Click Yes to delete the folder.



Folder Properties

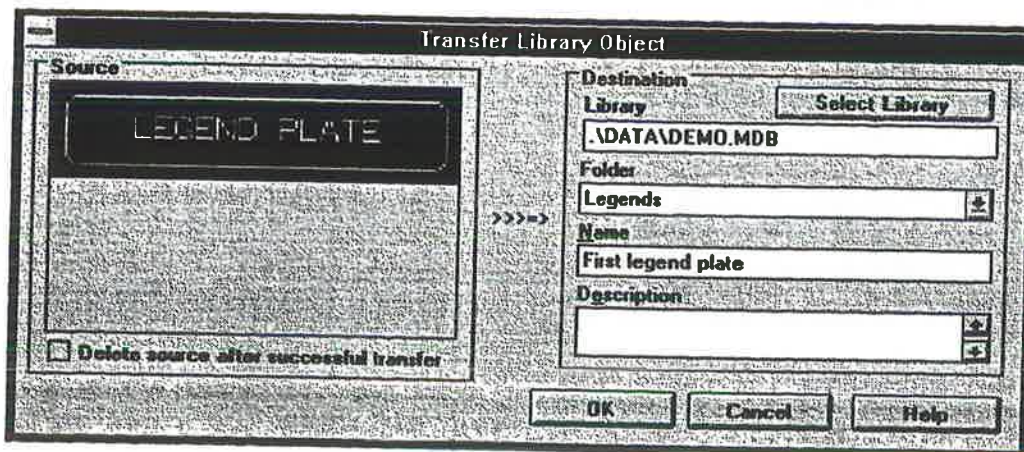
The properties are arranged in a file box format. The name tab allows changing the name of the folder.



Object

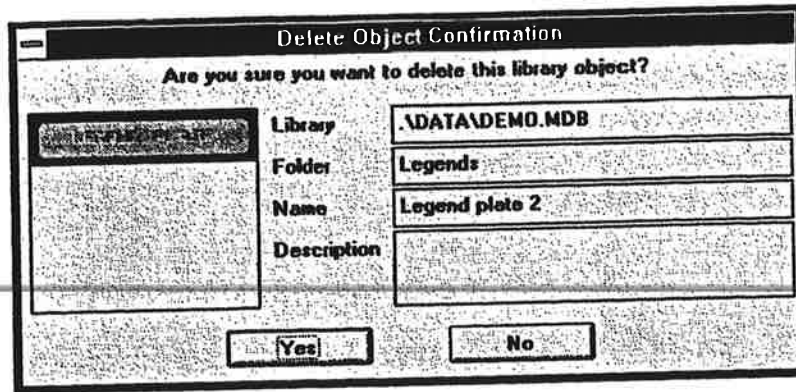
Transfer Object

Moves the selected object to a new destination. Select the destination library and folder, enter the name of the object and a description and click OK to complete the transfer. This is the same operation as an Edit/Paste.



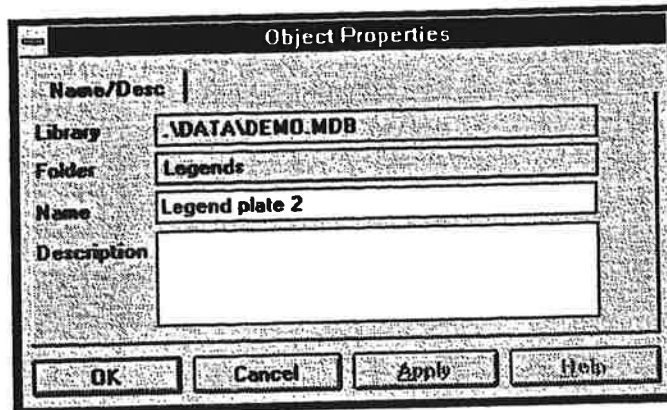
Delete Object

Deletes the selected item from the Library. A delete confirmation dialog box appears. Click Yes to delete the object or No to abort the delete operation. There is no UNDO. This is the same operation as Edit/Cut.



Object Properties

The properties are arranged in a file box format. The Name/Desc tab allows changing the name and description of the object.



Right Mouse Button Options for Objects

Opening a folder in a library will display all objects in the folder. Clicking the right mouse button when the cursor is ON TOP of an object will display the following options menu. The menu is tied to the object directly below the cursor, NOT the selected item.

Adjust size
Cut
Copy
Transfer
Delete
Properties

Adjust Size

Select Adjust Size to display sizing handles on the object below the cursor. Use any of the handles to proportionally size the objects in the folder.

Cut Object

Removes the object below the cursor and places the object on the clipboard. The Delete Object Confirmation dialog box is displayed.

Copy Object

Copies the object below the cursor to the clipboard.

Transfer Object

Transfers the object below the cursor to the selected library and folder. Displays the Transfer Library Object dialog box.

Delete Object

Deletes the object below the cursor from the folder. The object is NOT placed on the clipboard. The Delete Object Confirmation dialog box is displayed.

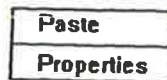
Properties

Displays the Object Properties dialog box.

Right Mouse Button Options for Folders

Browser Properties

Clicking the right mouse button when the cursor is located in the gray area of the object window will display the following options menu. If you had placed an object on the clipboard, the Paste option will be active. (Inactive menu selections are greyed out). Paste will copy the object on the clipboard to the open folder. Selecting Properties will display the Browser Properties dialog box.



Polyline Tool

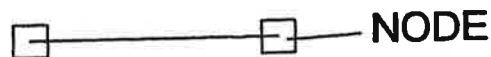
Creating a Polyline Drawing

The polyline tool is used to draw single line segments, multiple line segments, and filled/unfilled polygons.

Click the polyline icon on the tool bar.



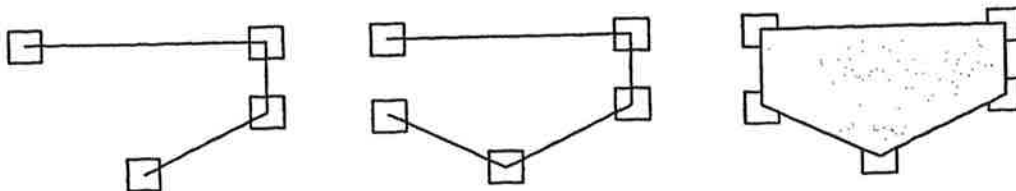
To create a line segment, move the cross hair to the point where you want to begin drawing a line. Click and HOLD the left mouse button. Move the mouse so that the cross hair is now at the second point of the line. Release the left mouse button to complete the line. A small box appears on each end of the line. This small box is called a NODE.



Note that the polyline tool is still active and you can continue to draw additional line segments or add segments to existing lines. You can add segments to existing lines ONLY when the nodes are visible. To add additional segments to the line shown above, move the cross hair over a node, click and hold the left mouse button, move the cursor to a new point and release the mouse button.



You can continue to add line segments to create a polygon. A true polygon is a closed figure bounded by three or more sides. The last leg of a polygon must connect to the node of the first leg so that the figure is closed. The drawing shows the sequence of adding segments to create a filled polygon.



To exit the polyline drawing mode, click on the pointer tool.

Moving a Polyline Object

To move a polyline object, point to the object, then click and hold the left mouse button. The object nodes will appear. Move the object to a new location and release the mouse button. This method of moving polyline objects is the same for all objects. You can also move an object when the sizing handles are visible by moving the cursor inside the object so that crossed arrows appear. Click and hold the left mouse button, then move the object to a new location and release the mouse button.

Editing Nodes

When you click on a polyline object, the object nodes will appear. To move a node, move the cross hair over a node, then click and hold the left mouse button. Move the node to a new location and release the mouse button.

To display the node edit menu, move the cross hair over a node, then click and hold the RIGHT mouse button. Click a menu item to execute the function.

<p>Insert node Append node Delete node Open polygon About Tool...</p>
--

Insert mode adds a node between the current node and the next node in a counter clockwise direction.

Append mode adds a node between the current node and the next node in a clockwise direction.

Delete mode removes the selected node.

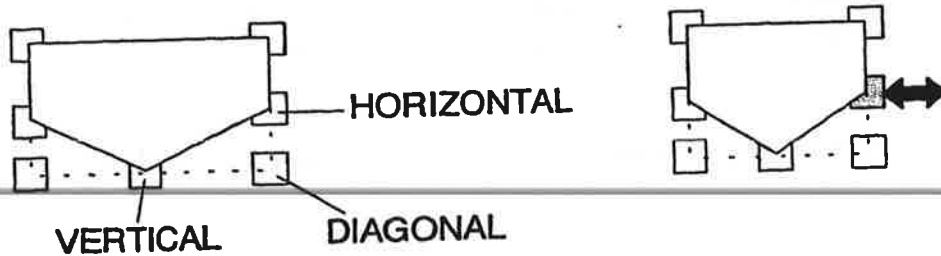
Open polygon removes the line segment between the current node and the next node in a clockwise direction. Removing a segment from a polygon converts it to a polyline. This menu option appears when you select a polygon and changes to *Close polygon* when you are working with a polyline.

Close polygon adds a line segment between the ends of a continuous polyline to form a polygon. This menu option appears when you select a polyline and changes to *Open polygon* when you are working with a polygon.

About Tool is an information box about the polyline tool.

Sizing a Polyline Object

To select the entire object for sizing, click on the object to select it, then click on it again to change from the editing mode to the sizing mode. The sizing handles should appear around the object. If you click too fast, you will get the Line/Polyline/Polygon Settings dialog box. To size an object, select one of the sizing handles and observe the pointer changes into a double end arrow. Click and hold the left mouse button and adjust the size. Sizing handles on the corners are for diagonal sizing. Handles between the corners are for horizontal and vertical sizing. The drawing shows an object resized in the horizontal direction.

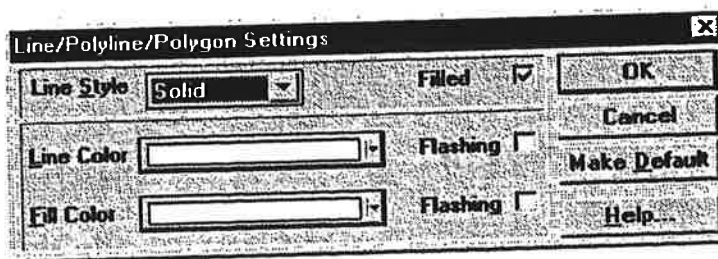


Cautions

When creating a polygon, be careful drawing when the grid is set to snap. The cursor will attempt to snap to the nearest grid point on the drawing grid. The mouse cursor may be in a different location when you start to create the next line. This will cause problems if you attempt to make a polygon. Make sure you draw lines from grid point to grid point, or turn off the snap to grid feature.

Polyline Settings

The dialog box allows changing the line style and color, selecting filled or unfilled polygons, and selecting the polygon fill color. To display the settings dialog, double click on the polyline object. If you double click too slow, you will only display the sizing handles.



Line Style

Solid, dashed, dotted, dash-dot, dash-dot-dot, none.

Filled/Unfilled

Check the *Filled* box to fill the polygon with color.

Line Color

Select the color of the polyline and polygon outline.

Fill Color

Select the color for the inside of the polygon.

OK

Click the OK button to apply the information in the settings menu and close the menu.

Cancel

Cancel all changes to the Line/Polyline/Polygon Settings dialog box and exit the dialog box.

Make Default

If you decide that you want to have all Line/Polyline/Polygon objects appear the same way, you can click the Make Default button in the Line/Polyline/Polygon Settings menu. The current settings in the Line/Polyline/Polygon Settings menu will be saved. The next time you create a Line/Polyline/Polygon, the saved settings will automatically be applied.

Help

Click the Help button to gain access to help files relating to Line/Polyline/Polygon Settings.

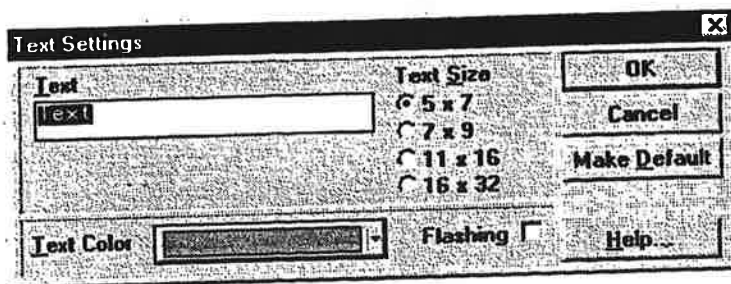
Text Tool

Creating Text

The text tool is used to add text to a panel. Click the text icon on the tool bar.



To add text, move the cross hair cursor to the desired cell and click the left mouse button. The Text Settings dialog box appears. The Text Settings dialog box can also be displayed by double clicking a circle. The dialog box allows changing the text and the text size and color. Text is available in several sizes. Text characters cannot be sized like other objects.



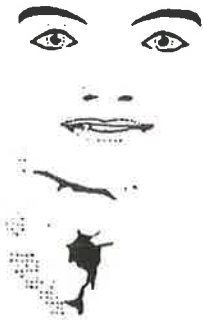
Moving Text

To move text, move the cursor over the text, click and hold the left mouse button, and move the text to the desired location. Text will snap to grid positions like other objects. For fine placement of text, turn of the tiling snap to grid option.

Bitmap

Creating a Bitmap

The bitmap tool is used to place a bitmap image on a panel. The bitmap can be created using Windows™ Paintbrush or imported from another bitmap source. The bitmap becomes a static image on the panel. The following picture is a sample bitmap. For more information about Bitmaps, see the Appendix.



Click the bitmap icon on the tool bar.



Move the cross hair to the cell where you want the bitmap to appear and click the mouse. If you want to size the bitmap immediately, move the cross hair to the desired cell, click and hold the mouse button and drag the mouse to size the bitmap. Release the mouse button and the bitmap is sized.

An empty bitmap frame, similar to the picture below will appear.



The bitmap dialog box will appear next to the bitmap frame. The selections allow you to determine how the bitmap will be placed in the empty frame. The default settings place the bitmap at the top, left corner of the frame. Selecting the 'Stretch fit' option will automatically size the bitmap to the empty frame.



The Edit button is not available for Windows 95 users.

Horizontal Justify

Select Left, Center, or Right to justify the bitmap to the frame. The default setting is Left justify, which forces the bitmap to the left side of the frame.

Vertical Justify

Select Top, Center, or Bottom to justify the bitmap to the frame. The default setting is Top, which forces the bitmap to the top of the frame.

Options

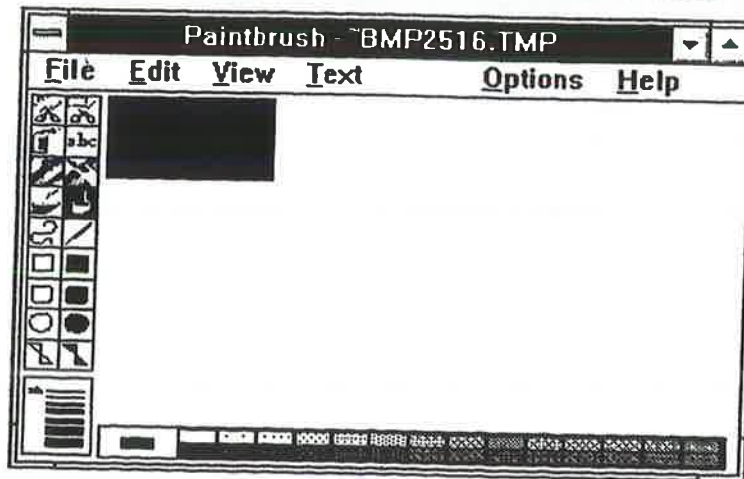
To stretch the bitmap to fit the frame size, click the Stretch fit checkbox. The screen size is 320 x 240 for 5" displays and 640 x 400 for 9" displays. Bitmaps that exceed the screen size can be displayed by clicking the Stretch fit checkbox.

Bitmap Statistics

The statistics for each bitmap are presented in the Bitmap Settings dialog box. The statistics include the Width, Height, Colors, and Size. *QUICKDESIGNER* supports monochrome or 16 color bitmaps. Each object on a panel requires a small amount of memory. The panel can contain any combination of panel objects. Bitmaps that take a lot of memory will limit the number of objects you can place on a panel.

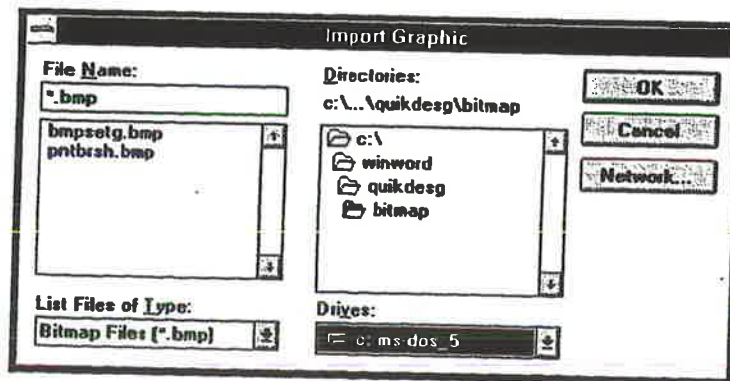
Edit

Clicking the Edit button will launch the Windows™ Paintbrush program. Using the paint and draw tools, you can create a bitmap image that can be placed on a panel. The drawing frame that appears in Paintbrush is the size of the frame on the panel. *Edit is not available under Windows 95.*



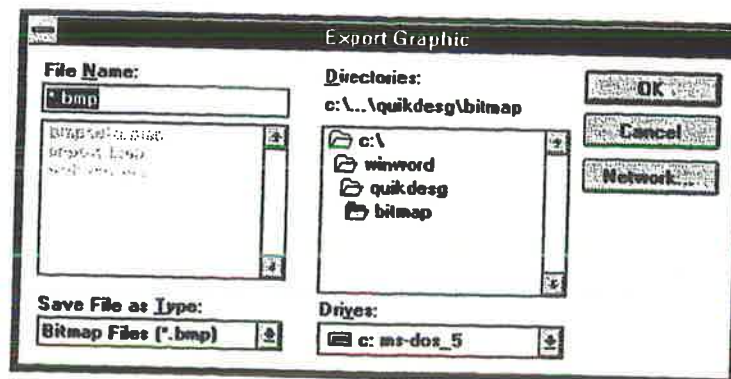
Import

You can import a bitmap image from any program that generates bitmap images. These sources include paint, icon editors, and capture programs. You can import bitmap images from any directory or drive. Click the Import button to display the Import dialog box.



Export

You can export a bitmap image from a panel to any directory or drive. Click the Export button to display the Export dialog box.



OK

Click the OK button to apply the information in the settings dialog box and close it.

Cancel

Cancel all changes to the Bitmap Settings dialog box and exit the dialog.

Make Default

If you decide that you want to have all bitmaps appear the same way, you can click the Make Default button in the Bitmap Settings dialog box. The current settings in the Bitmap Settings dialog box will be saved. The next time you create a bitmap, the saved settings will automatically be applied.

Help

Click the Help button to gain access to help files relating to Bitmap Settings.

Bitmap Size

Before you attempt to place a bitmap on a panel, use the following approximations to determine the size of the bitmap.

Monochrome Bitmap: $(\text{Width} / 8) \times \text{Height}$

Example: 80×80 mono bitmap = $(80 / 8) \times 80 = 800$ bytes.

16 Color Bitmap: $(\text{Width} / 2) \times \text{Height}$

Example: 80×80 16 color bitmap = $(80 / 2) \times 80 = 3200$ bytes.

256 Color Bitmap: $\text{Width} \times \text{Height}$

Example: 80×80 256 color bitmap = 6400 bytes.

To determine the size of your bitmap, open Paintbrush and select View/Cursor Position. Move the cursor to the corner of the bitmap and note the coordinates. Example, 80, 80. Use the equations above to calculate the approximate size of the bitmap.

Notes

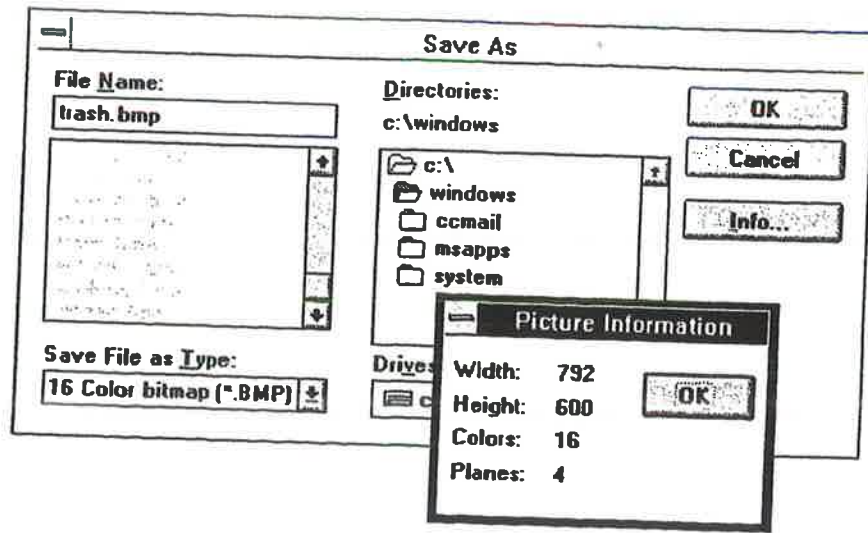
The disadvantage to using bitmap pictures in your *QUICKPANEL* application is that they require a lot of memory. As the number and size of bitmap graphics increase in your application, the amount of memory left for other objects will quickly disappear. The amount of memory that a bitmap requires is dependent on its size and type. For example, a monochrome bitmap will require 1/4 the memory of the same sized 16 color bitmap. Another disadvantage is that the draw time of the panel will increase.

Creating a Bit Map

To create a bitmap, select the bitmap icon and place the object on your panel. The initial size of the bitmap is one cell. When the Bitmap Settings dialog box appears, click the Cancel button. Size the bitmap object to the estimated final size for the panel. Double click on the bitmap to reopen the Bitmap Settings dialog box. Click the Edit button to start Windows Paintbrush. When you have completed your drawing, click File/Exit and save the drawing. When Paintbrush closes, the new drawing will be seen on the panel.

Bitmap Size

To determine the actual image size of a bit map, load the file into Paintbrush and select the File /Save As option. Click on the Info.. button. It will display the width and height of the bit map. See the example below.



Circle Tool

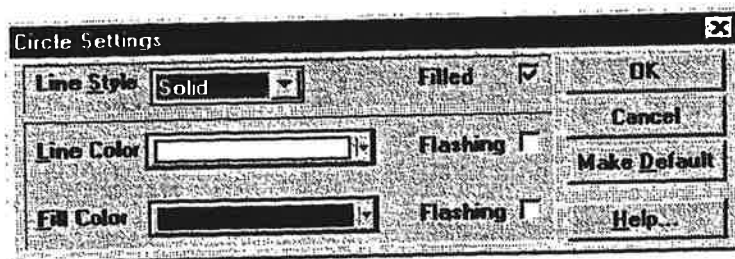
Creating a Circle

The circle tool is used to draw filled or unfilled circles. Click the circle icon on the tool bar.



To create a circle, move the cross hair cursor to the desired cells and click the left mouse button. If you want to size the circle immediately, move the cross hair to the desired cell, click and hold the mouse button and drag the mouse to size the circle. Release the mouse button and the circle is sized. The Circle Settings dialog box appears. The Circle Settings dialog box can also be displayed by double clicking a circle.

The dialog box allows changing the line style and color, selecting filled or unfilled circles, and selecting the circle fill color. The **line style** can be solid, dashed, dotted, dash-dot, dash-dot-dot, and none.

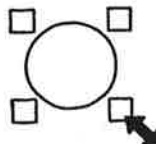


Moving a Circle

To move a circle, move the cursor over the object, click and hold the left mouse button, and move the object to the desired location.

Sizing a Circle

To select an object for sizing, click on the object and sizing handles should appear on the corners. To size an object, move the cursor over one of the sizing handles and observe that the pointer changes into a double end arrow. Click and hold the left mouse button and adjust the size.



Rectangle Tool

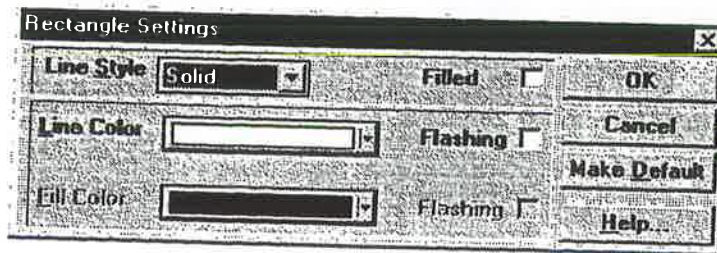
Creating a Rectangle

The rectangle tool is used to draw filled or unfilled rectangles. Click the rectangle icon on the tool bar.



To create a rectangle, move the cross hair cursor to the desired cells and click the left mouse button. If you want to size the rectangle immediately, move the cross hair to the desired cell, click and hold the mouse button and drag the mouse to size the rectangle. Release the mouse button and the rectangle is sized. The Rectangle Settings dialog box appears. The Rectangle Settings dialog box can also be displayed by double clicking a rectangle.

The dialog box allows changing the line style and color, selecting filled or unfilled rectangles, and selecting the rectangle fill color. The **line style** can be solid, dashed, dotted, dash-dot, dash-dot-dot, and none.

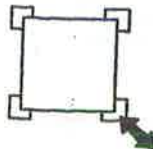


Moving a Rectangle

To move a rectangle, move the cursor over the object, click and hold the left mouse button, and move the object to the desired location.

Sizing a Rectangle

To select an object for sizing, click on the object and sizing handles should appear on the corners. To size an object, move the cursor over one of the sizing handles and observe that the pointer changes into a double end arrow. Click and hold the left mouse button and adjust the size.



Legend Plate

Creating a Legend Plate

A legend plate is a core component that can be placed on the target display to supply text information to the operator. No variables are monitored or controlled by a legend plate. Note the shape of the legend plate symbol.

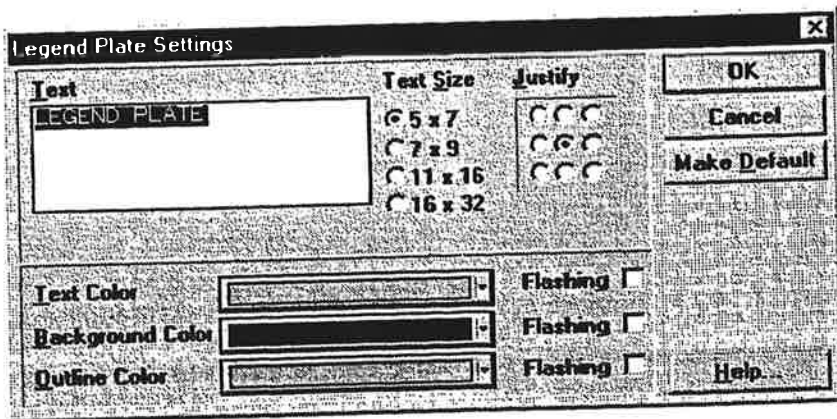


Click the legend plate icon on the tool bar.



Move the cross hair to the top of the two cells where you want the legend plate to appear and click the mouse. If you want to size the legend plate immediately, move the cross hair to the desired cell, click and hold the mouse button and drag the mouse to size the legend plate. Release the mouse button and the legend plate is sized.

The following legend plate dialog box will appear.



The legend plate allows you to provide text information to the operator. The legend plate differs from the text tool in that the legend plate allows multiple lines of text and options for outline and background color. The justify radio buttons justify text to any area of the legend plate.

OK

Click the OK button to apply the information in the settings dialog box and close it.

Cancel

Cancel all changes to the Legend Plate Settings dialog box and exit the dialog box.

Make Default

If you decide that you want to have all legend plates appear the same way, you can click the Make Default button in the Legend Plate Settings dialog box. The current settings in the Legend Plate Settings dialog box will be saved. The next time you create a legend plate, the saved settings will automatically be applied.

Examples



Push Button

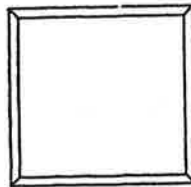
Creating a push button

Pressing a push button performs a write operation on a PLC variable. On a standard push button, the bezel changes color to indicate the button has been pressed. The push button action can be selected as Momentary, ON, OFF, or Toggle. The three button styles are standard, circular and simple. A standard push button is shown below.

LEGEND PLATE



+ BEZEL



= PUSH BUTTON

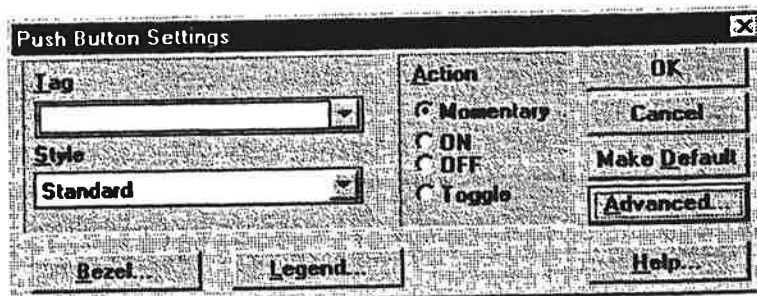


Click the push button icon on the Tools menu.



Move the cross hair to the top of the two cells where you want the push button to appear and click the mouse. If you want to size the push button immediately, move the cross hair to the desired cell, click and hold the mouse button and drag the mouse to size the push button. Release the mouse button and the push button is sized.

The following Push Button Settings dialog box will appear. The Bezel and Legend buttons will display additional dialog boxes.



Tag Variable

The Tag is a single discrete bit in the PLC memory that the target display can control. A list of valid PLC tags can be found by locating your PLC type in the Communications User manual. Tags can be edited by clicking the object and selecting Change Object Tags (Ctrl+T) from the Edit menu. Tag prompts can be added in the Modify Tag Attributes dialog box. You can also add or edit tag prompts by double clicking above the tag field.

Action

The manner in which the tag variable will be controlled is defined by selecting an "Action". The most common action is Momentary, where the bit is turned ON when the push button is pressed and turned OFF when the push button is released. The ON selection will turn the bit ON when the push button is pressed and no action is taken when the push button is released. The OFF selection will turn the bit OFF when the push button is pressed and no action is taken when the push button is released. Toggle is used to change the bit to the opposite state when the push button is pressed and no action is taken when the push button is released.

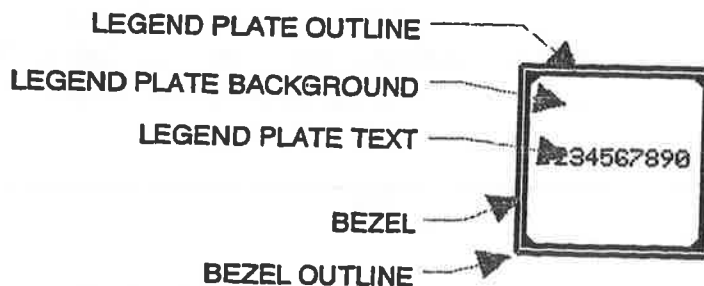
Use caution when implementing the Momentary push button for critical applications such as ramping a motor. Pressing the button sets a bit and releasing the button clears the bit. If at any time during the press and release cycle a communication fault occurs, the bit clear action may not occur. Instead of relying on a bit set or clear, use multiple Word buttons to increment and decrement a counter.

Style

The style list box is used to select the style of the push button. Select Standard, Circular or Simple.

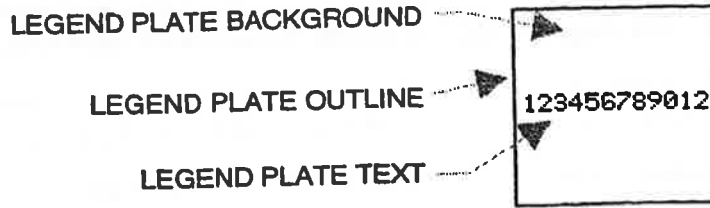
Standard Push Button

The elements of the standard push button are shown below. The standard push button consists of a bezel and legend plate. The bezel is the frame around the legend plate. The bezel can be one color when the button is idle and a different color when the button is touched. The bezel color, the touch color and the bezel outline color can be changed. The legend plate contains the text and the background. The text color, legend plate background color and legend plate outline colors can be changed. There are three text sizes available.



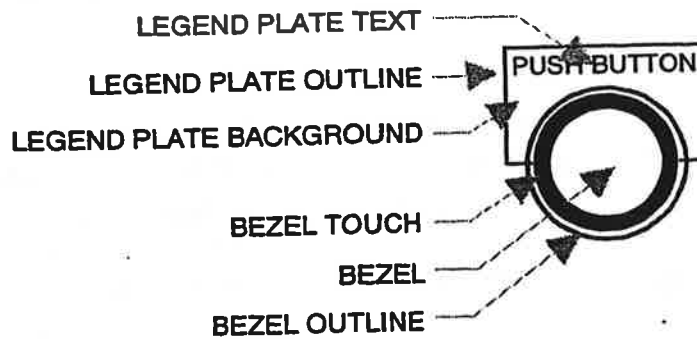
Simple Push Button

The elements of the simple push button are shown below. The simple push button is similar to the standard push button except it has no bezel. The simple push button is a legend plate and text. The text color, legend plate background color and legend plate outline colors can be changed. There are three text sizes available. The simple push button has more room for text characters than the standard push button.



Circular Push Button

The elements of the circular push button are shown below. The circular push button consists of a bezel and legend plate. The bezel is the circular section in the center of the button. The ring around the bezel is the touch indicator. The touch indicator can be one color when the button is idle and a different color when the button is touched. The bezel color, the touch color and the bezel outline color can be changed. The legend plate contains the text and the background. The text color, legend plate background color and legend plate outline colors can be changed. There are three text sizes available.



Bezel

The simple push button has no bezel so the bezel dialog box should be ignored.

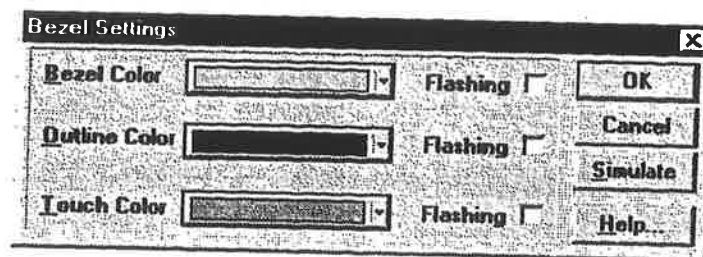
The bezel on a standard push button serves both as a bezel indicator and a touch indicator. When using a standard push button, the bezel portion of the push button can change color when the button is pressed.

A circular push button has a separate bezel and touch indicator. The bezel on a circular push button is the center area of the button. The ring around the center is the touch indicator.

The bezel, outline, and touch color can be modified to enhance the visual impact of the push button. The outline color remains constant whether the push button is pressed or not.

Press the Simulate button to observe the action of the bezel color change.

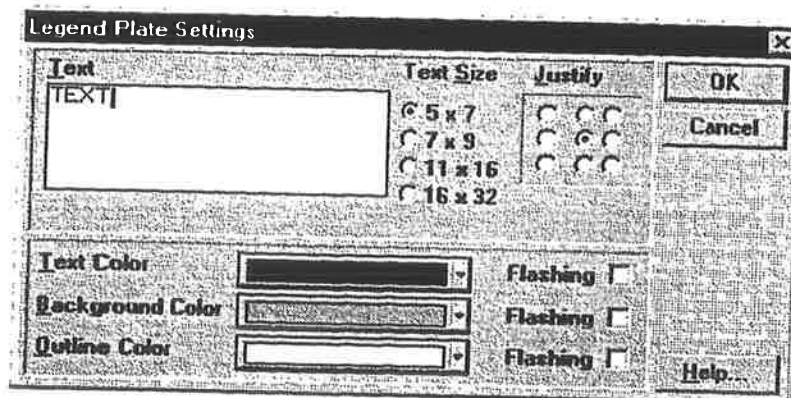
If you load a color project into a monochrome unit, Red, Green and Blue will be converted to Black, and Yellow, Magenta, and Cyan will be converted to white.



Legend Plate

The legend plate allows you to provide text information to the operator on the action that will occur when the push button is pressed. This text is constant and will not change when the push button is pressed. The justify radio buttons justify text to any area of the legend plate. The text color, background color, and outline color can be modified in appearance to enhance the application. There is more room for text on a simple push button than on a standard push button.

If you load a color project into a monochrome unit, Red, Green and Blue will be converted to Black, and Yellow, Magenta, and Cyan will be converted to white.



OK

Click the OK button to apply the information in the settings dialog box and close it.

Cancel

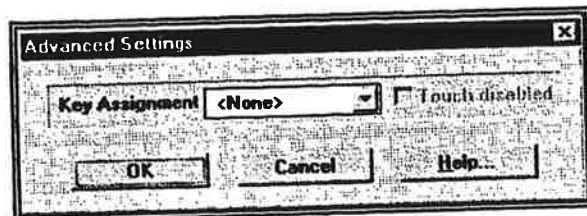
Cancel all changes to the Push Button Settings dialog box and exit the dialog box.

Make Default

If you decide that you want to have all push buttons appear the same way, you can click the Make Default button in the Push Button Settings dialog box. The current settings in the Push Button Settings dialog box will be saved. The next time you create a push button, the saved settings will automatically be applied.

Advanced Button

Clicking the Advanced button will display the Advanced Settings Dialog box. The Push Button operation can be assigned to an external keypad. See Keypads, page 194 and Keypad Assignment, page 91, for additional information. Once a keypad is assigned, you can disable the touch screen by checking the *Touch disabled* box. If you leave the touch disable box unchecked, then the touch screen and the keypad can both operate the push button.



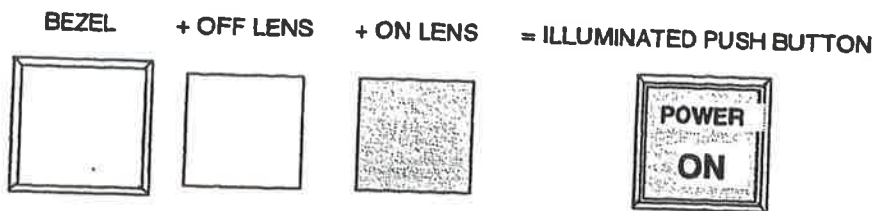
Help

Click the Help button to gain access to help files relating to Push Button Settings.

Illuminated Push Button

Creating an Illuminated Push Button

An illuminated push button consists of a bezel, an OFF lens, and an ON lens. The illuminated push button requires two PLC variables; one for the lens and one for the push button. The push button action can be selected as momentary, ON, OFF, or toggle.

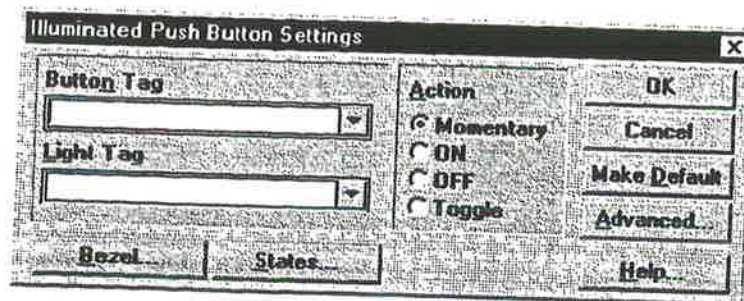


Click the illuminated push-button icon on the Tools menu.



Move the cross hair to the top of the two cells where you want the illuminated push button to appear and click the mouse. If you want to size the illuminated push button immediately, move the cross hair to the desired cell, click and hold the mouse button and drag the mouse to size the illuminated push button. Release the mouse button and the illuminated push button is sized.

The following Illuminated Push Button Settings dialog box will appear. The Bezel and States buttons bring up additional dialog boxes. Note also there is a tag setting for the Push Button and one for the Light (lens).



Push Button Tag Variable

A "tag" variable name must be assigned to the push button. This tag will be a single discrete bit in the PLC memory that the target display can control. A list of valid PLC tags can be found by locating your PLC type in the Communications User manual. Tags can be edited by clicking the object and selecting Change Object Tags (Ctrl+T) from the Edit menu. Tag prompts can be added in the Modify Tag Attributes dialog box. You can also add or edit tag prompts by double clicking above the tag field.

Action

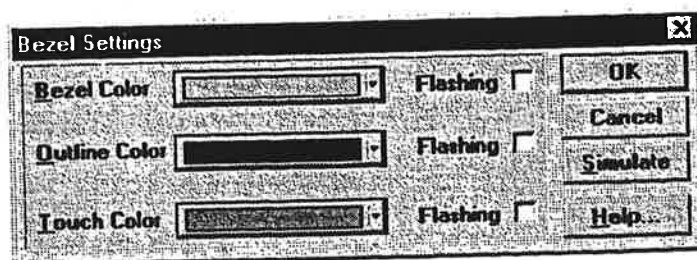
The manner in which this tag will be controlled is defined by selecting an "Action". The most common action is Momentary, where the bit is turned ON when the push button is pressed and turned OFF when the push button is released. The ON selection will turn the bit ON when the push button is pressed and no action is taken when the push button is released. The OFF selection will turn the bit OFF when the push button is pressed and no action is taken when the push button is released. Toggle is used to change the bit to the opposite state when the push button is pressed and no action is taken when the push button is released.

Pilot Light Tag Variable

A "tag" variable name must be assigned to the pilot light. This tag will be a single discrete bit in the PLC memory that the *QUICKPANEL* can read. The condition of this bit will determine whether the ON or OFF state is displayed. A list of valid PLC tags can be found by locating your PLC type in the Communications User manual. Tags can be edited by clicking the object and selecting Change Object Tags (Ctrl+T) from the Edit menu. Tag prompts can be added in the Modify Tag Attributes dialog box. You can also add or edit tag prompts by double clicking above the tag field.

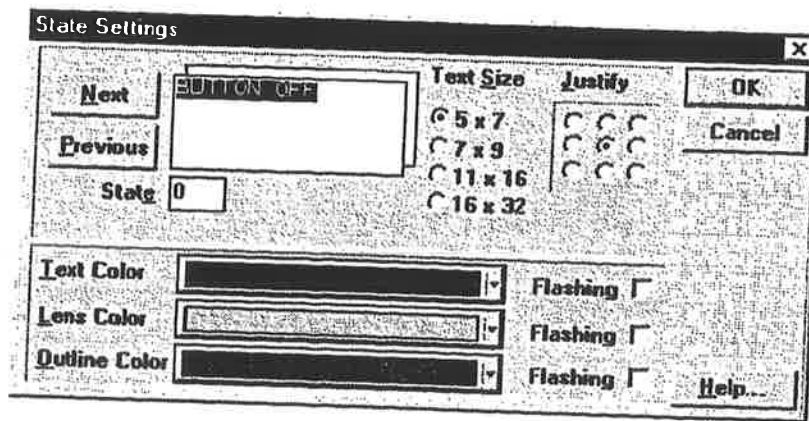
Bezel

The Bezel portion of the push button is used to give a visual indication to the operator that the button was pressed. The bezel, outline, and touch color can be modified to enhance the visual impact of the push button. When the push button is not pressed the bezel color is displayed, but when the push button is pressed the touch color will be displayed. The outline color remains constant whether the push button is pressed or not pressed. Press the Simulate button to observe the action of the bezel color change. If you load a color project into a monochrome unit, Red, Green and Blue will be converted to Black, and Yellow, Magenta, and Cyan will be converted to white.



States

The States button will display the State Settings menu. An illuminated push button has two states, ON and OFF. You can change the text size and colors for each state. Click one of the Justify radio buttons to justify text. Use the Next and Previous buttons to select a different state. The last state selected will be the one displayed when you click the OK button. If you load a color project into a monochrome unit, Red, Green and Blue will be converted to Black, and Yellow, Magenta, and Cyan will be converted to white.



OK

Click the OK button to apply the information in the settings dialog box and close it.

Cancel

Cancel all changes to the Illuminated Push Button Settings dialog box and exit the dialog box.

Make Default

If you decide that you want to have all push buttons appear the same way, you can click the Make Default button in the Illuminated Push Button Settings dialog box. The current settings in the Illuminated Push Button Settings dialog box will be saved. The next time you create a push button, the saved settings will automatically be applied.

Advanced Button

Clicking the Advanced button will display the Advanced Settings Dialog box. The Illuminated Push Button operation can be assigned to an external keypad. See Keypads, page 194 and Keypad Assignment, page 91, for additional information. Once a keypad is assigned, you can disable the touch screen by checking the *Touch disable* box. If you leave the touch disable box unchecked, then the touch screen and the keypad can both operate the button.

Help

Click the Help button to gain access to help files relating to Push Button Settings.

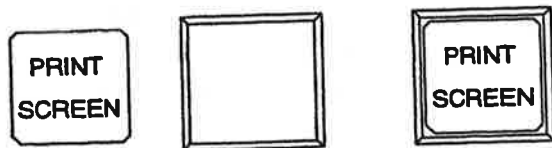
Print Button

Creating a print button

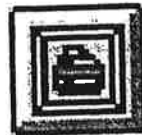
The print button prints the current panel to a printer attached to the serial (download) or parallel port. For information about hardware connections, see the Communications reference manual and Printer Port in the Alarms chapter. The button works like a push button, except that you do not need to set a tag variable. The button is permanently assigned an internal variable that controls printing.

There are three styles of the print button available. The three button styles are standard, circular and simple.

LEGEND PLATE + BEZEL = PRINT SCREEN BUTTON

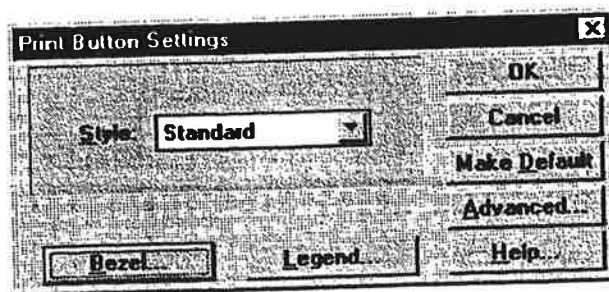


Click the print button icon on the Tools menu.



Move the cross hair to the top of the two cells where you want the print button to appear and click the mouse. If you want to size the print button immediately, move the cross hair to the desired cell, click and hold the mouse button and drag the mouse to size the button. Release the mouse button and the button is sized.

The following Print Button Settings dialog box will appear. The Bezel and Legend buttons will display additional dialog boxes.

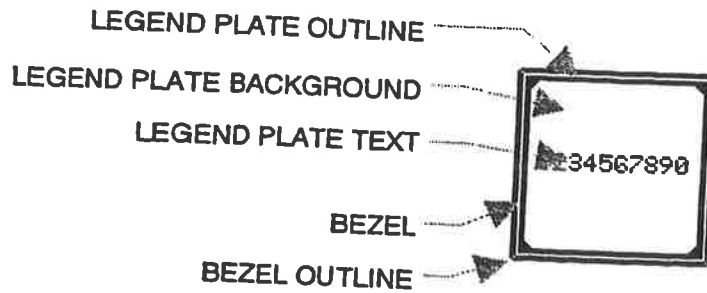


Style

The style list box is used to select the style of the button. Select Standard, Circular or Simple.

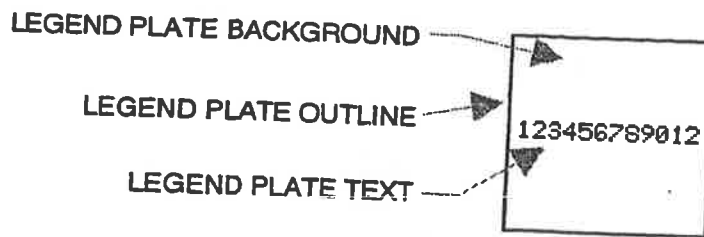
Standard Print Button

The elements of the standard print button are shown below. The standard print button consists of a bezel and legend plate. The bezel is the frame around the legend plate. The bezel can be one color when the button is idle and a different color when the button is touched. The bezel color, the touch background. The text color, legend plate background color and legend plate outline colors can be changed. There are several text sizes available.



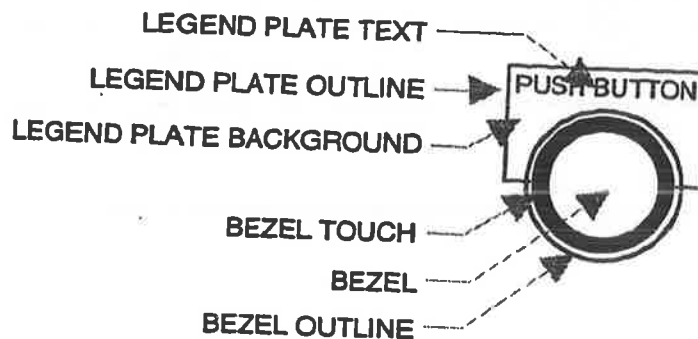
Simple Print Button

The elements of the simple print button are shown below. The simple button is similar to the standard button except it has no bezel. The simple button is a legend plate and text. The text color, legend plate background color and legend plate outline colors can be changed. There are several text sizes available. The simple button has more room for text characters than the standard button.



Circular Print Button

The elements of the circular print button are shown below. The circular button consists of a bezel and legend plate. The bezel is the circular section in the center of the button. The ring around the bezel is the touch indicator. The touch indicator can be one color when the button is idle and a different color when the button is touched. The bezel color, the touch color and the bezel outline color can be changed. The legend plate contains the text and the background. The text color, legend plate background color and legend plate outline colors can be changed. There are several text sizes available.



Bezel

The simple button has no bezel so the bezel dialog box should be ignored.

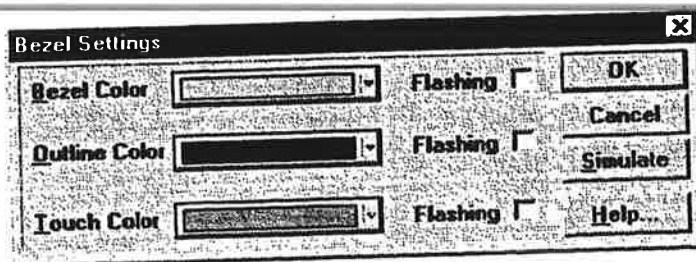
The bezel on a standard button serves both as a bezel indicator and a touch indicator. When using a standard button, the bezel portion of the button can change color when the button is pressed.

A circular button has a separate bezel and touch indicator. The bezel on a circular button is the center area of the button. The ring around the center is the touch indicator.

The bezel, outline, and touch color can be modified to enhance the visual impact of the button. The outline color remains constant whether the button is pressed or not.

Press the Simulate button to observe the action of the bezel color change.

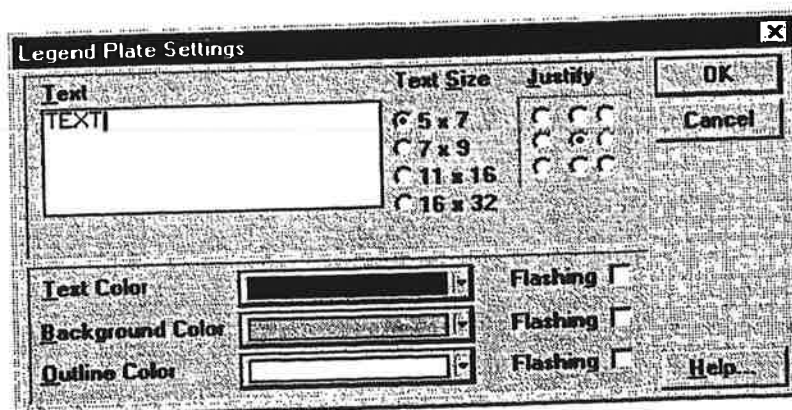
If you load a color project into a monochrome unit, Red, Green and Blue will be converted to Black, and Yellow, Magenta, and Cyan will be converted to white.



Legend Plate

The legend plate allows you to provide text information to the operator on the action that will occur when the print screen button is pressed. This text is constant and will not change when the button is pressed. The text size can be changed, and you can justify text by clicking one of the Justify radio buttons. The text color, background color, and outline color can be modified in appearance to enhance the application. There is more room for text on a simple button than on a standard button.

If you load a color project into a monochrome unit, Red, Green and Blue will be converted to Black, and Yellow, Magenta, and Cyan will be converted to white.



OK

Click the OK button to apply the information in the settings dialog box and close it.

Cancel

Cancel all changes to the dialog box and exit the dialog box.

Make Default

If you decide that you want to have all the settings in the dialog box the same way every time the dialog box is opened, you can click the Make Default button. The current settings in the dialog box will be saved. The next time you open the dialog box, the saved settings will automatically be applied.

Advanced Button

Clicking the Advanced button will display the Advanced Settings dialog box. The Print Button operation can be assigned to an external keypad. See Keypads, page 194 and Keypad Assignment, page 91, for additional information. Once a keypad is assigned, you can disable the touch screen by checking the *Touch disable* box. If you leave the touch disable box unchecked, then the touch screen and the keypad can both operate the button.

Help

Click the Help button to gain access to help files relating to the associated dialog box.

Word Button

Creating a Word Button

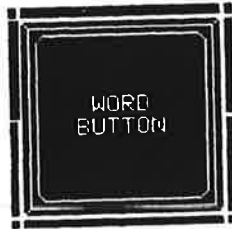
A Word button is a multi-function object that performs Set, Add, Subtract, AND, OR, XOR of a selected value on a PLC word register. For example, if the selected value is 5, then the word button can set a register to the value 5, or add 5 to a register, or subtract 5 from a register. The logical functions of AND, OR and XOR can also be performed using a selected value and a PLC word register.

Click the Word button icon on the tool bar.

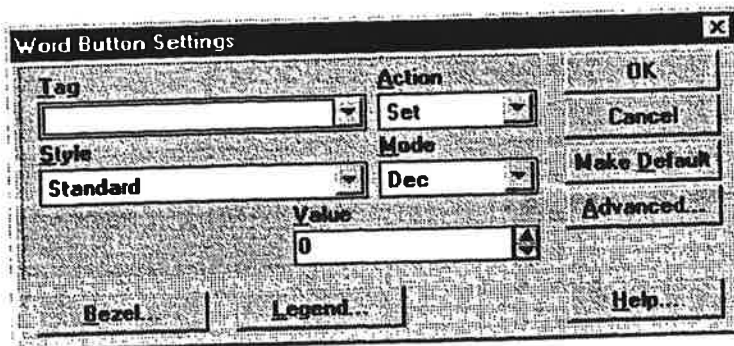


Move the cross hair to the top of the two cells where you want the word button to appear and click the mouse. If you want to size the word button immediately, move the cross hair to the desired cell, click and hold the mouse button and drag the mouse to size the word button. Release the mouse button and the word button is sized.

The Word button will appear similar to the one below.



The Word button dialog box appears next to the word button.



Tag variable

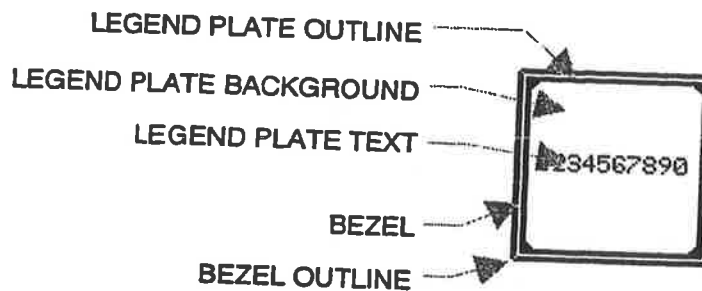
A "tag" variable name must be assigned to the Word Button. This tag will be a word in the PLC memory that the target display can update. A list of valid PLC tags can be found by locating your PLC type in the Communications User manual. Tags can be edited by clicking the object and selecting Change Object Tags (Ctrl+T) from the Edit menu. Tag prompts can be added in the Modify Tag Attributes dialog box. You can also add or edit tag prompts by double clicking above the tag field.

Style

The style list box is used to select the style of the button. Select Standard, Circular or Simple.

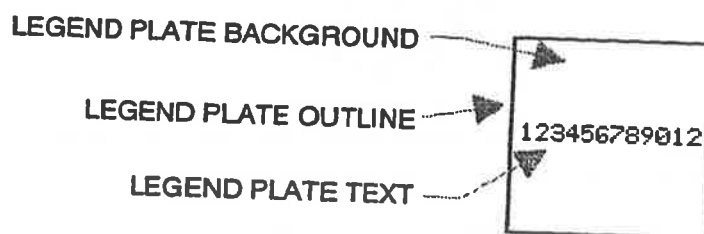
Standard Word Button

The elements of the standard word button are shown below. The standard word button consists of a bezel and legend plate. The bezel is the frame around the legend plate. The bezel can be one color when the button is idle and a different color when the button is touched. The bezel color, the touch color and the bezel outline color can be changed. The legend plate contains the text and the background. The text color, legend plate background color and legend plate outline colors can be changed. There are three text sizes available.



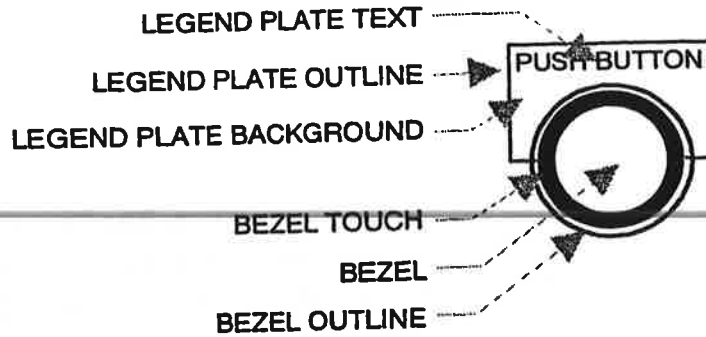
Simple Word Button

The elements of the simple word button are shown below. The simple button is similar to the standard button except it has no bezel. The simple button is a legend plate and text. The text color, legend plate background color and legend plate outline colors can be changed. There are three text sizes available. The simple button has more room for text characters than the standard button.



Circular Word Button

The elements of the circular word button are shown below. The circular button consists of a bezel and legend plate. The bezel is the circular section in the center of the button. The ring around the bezel is touch indicator. The touch indicator can be one color when the button is idle and a different color when the button is touched. The bezel color, the touch color and the bezel outline color can be changed. The legend plate contains the text and the background. The text color, legend plate background color and legend plate outline colors can be changed. There are three text sizes available.



Action

This pull-down list box is used to select the action to be performed on the PLC word register. The available action options are:

Set: Set the register equal to the number in the Value field.

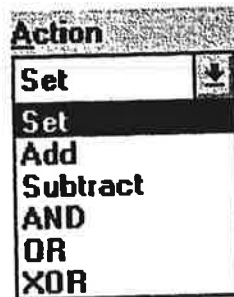
Add: Add the number in the Value field to the PLC word register.

Subtract: Subtract the number in the Value field from the PLC word register.

AND: Perform the logical AND operation between the number in the Value field and the PLC word register.

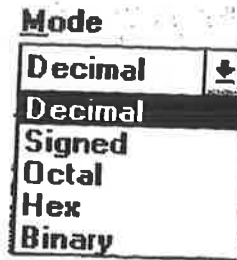
OR: Perform the logical OR operation between the number in the Value field and the PLC word register.

XOR: Perform the logical XOR operation between the number in the Value field and the PLC word register.



Mode

The mode pull-down list box is used to select the number base for the Value field. The default setting is Decimal. The available options are:



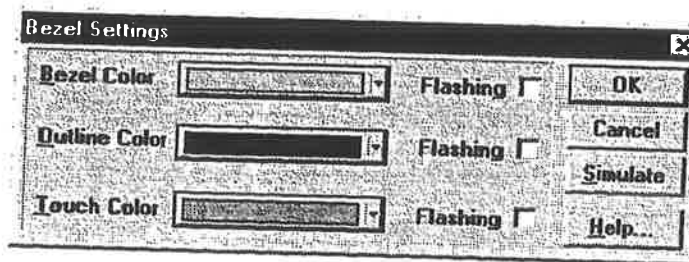
Value

This field contains the number value used in the modes of operation. The base number system for the value represented in the field is selected in the Mode list box. You can use the up and down arrows to increment or decrement the value in the field. You can also enter a value directly in the number field by clicking anywhere in the field.



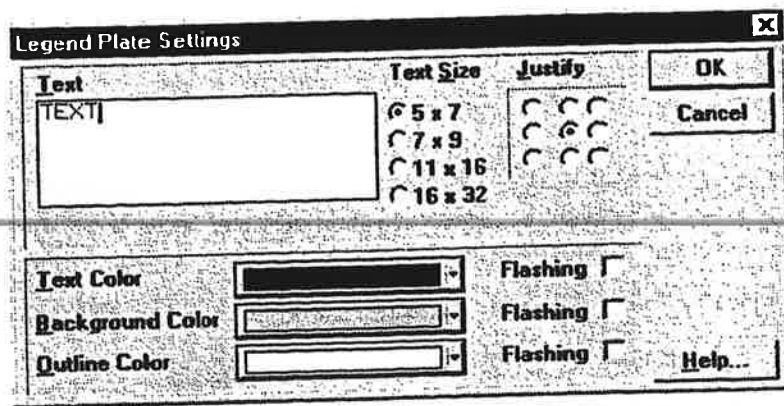
Bezel

The Bezel portion of the word button is used to give a visual indication to the operator that the button was pressed. The bezel, outline, and touch color can be modified to enhance the visual impact of the word button. When the word button is not pressed the bezel color is displayed, but when the word button is pressed the touch color will be displayed. The outline color remains constant whether the word button is pressed or not pressed. Press the Simulate button to observe the action of the bezel color change. If you load a color project into a monochrome unit, Red, Green and Blue will be converted to Black, and Yellow, Magenta, and Cyan will be converted to white.



Legend Plate

The legend plate allows you to provide text information to the operator on the action that will occur when the word button is pressed. This text is constant and will not change when the word button is pressed. The text size can be changed, and you can justify text by clicking one of the Justify radio buttons. The text color, background color, and outline color can be modified in appearance to enhance the application. If you load a color project into a monochrome unit, Red, Green and Blue will be converted to Black, and Yellow, Magenta, and Cyan will be converted to white.



OK

Click the OK button to apply the information in the settings dialog box and close it.

Cancel

Cancel all changes to the Word Button Settings dialog box and exit the dialog.

Make Default

If you decide that you want to have all Word Buttons appear the same way, you can click the Make Default button in the Word Button Settings dialog box. The current settings in the Word Button Settings dialog box will be saved. The next time you create a word button, the saved settings will automatically be applied.

Advanced Button

Clicking the Advanced button will display the Advanced Settings dialog box. The Word Button operation can be assigned to an external keypad. See Keypads, page 194 and Keypad Assignment, page 91, for additional information. Once a keypad is assigned, you can disable the touch screen by checking the *Touch disable* box. If you leave the touch disable box unchecked, then the touch screen and the keypad can both operate the button.

Help

Click the Help button to gain access to help files relating to Word Button Settings.

Pilot Light

Creating a pilot light

A Pilot Light is an indicator that shows the ON or OFF condition of a variable. The Pilot Light tool allows you to create a square (Standard) or circular pilot light. The standard pilot light consists of two square lens, each with its own color and text options. Each lens can have a different text message.

OFF LENS/TEXT + ON LENS/TEXT = STANDARD PILOT LIGHT



The circular pilot light consists of two round lens and a legend plate. The legend plate contains a fixed text message.

OFF LENS + ON LENS + LEGEND PLATE = CIRCULAR PILOT LIGHT



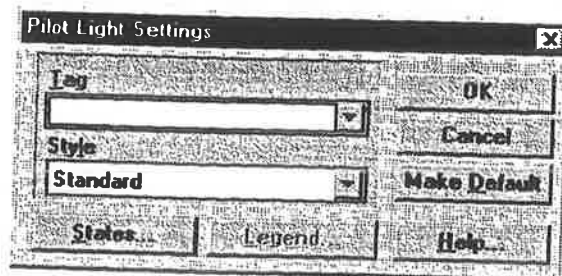
The Pilot Light requires a PLC variable that will be monitored to determine when to display the OFF state and when to display the ON state.

Click the Pilot Light icon on the Tools menu.



Move the cross hair to the top of the two cells where you want the Pilot Light to appear and click the mouse. If you want to size the Pilot Light immediately, move the cross hair to the desired cell, click and hold the mouse button and drag the mouse to size the Pilot Light. Release the mouse button and the Pilot Light is sized.

The following Pilot Light Settings dialog box will appear.

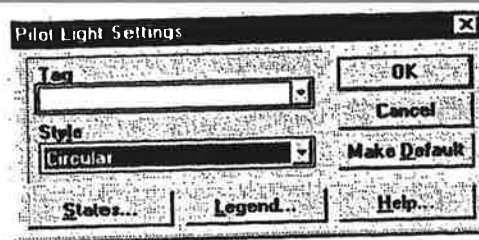


Tag Variable

The Tag is a single discrete bit in the PLC memory that the target display can read to determine the N/OFF status. A list of valid PLC tags can be found by locating your PLC type in the Communications User manual. Tags can be edited by clicking the object and selecting Change Object Tags (Ctrl+T) from the Edit menu. Tag prompts can be added in the Modify Tag Attributes dialog box. You can also add or edit tag prompts by double clicking above the tag field.

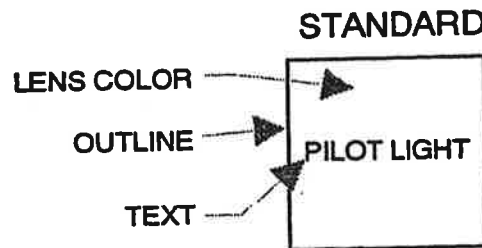
Style

Select either the Standard or Circular style Pilot Light. If you select the Standard pilot light, the Legend button will be greyed out (inactive). If you select the Circular pilot light, both States and Legend buttons will be active.



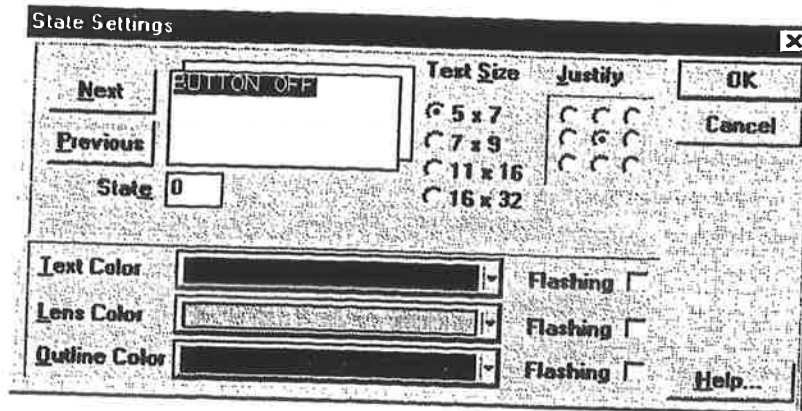
Standard Pilot Light

The elements of the standard pilot light are shown below. The standard pilot light is a square lens with text inside. The lens has two states, either ON or OFF. You can select the lens color, outline color, text color and text size for each state.



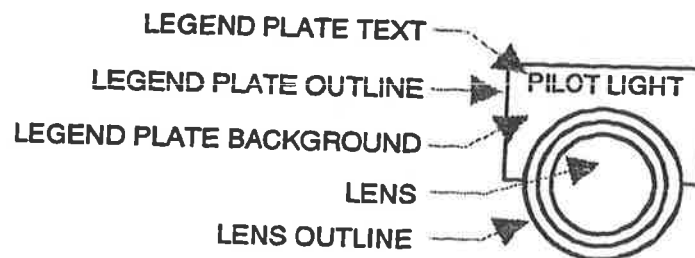
Standard Pilot Light States

The States button will display the State Settings menu. A standard pilot light has two states, ON and OFF. You can change the text size and appearance of each state. Click one of the Justify radio buttons to justify text. Use the Next and Previous buttons to select a different state. The last state selected will be the one displayed when you click the OK button. If you load a color project into a monochrome unit, Red, Green and Blue will be converted to Black, and Yellow, Magenta, and Cyan will be converted to white.



Circular Pilot Light

The elements of the circular pilot light are shown below. The circular pilot light is a round lens and a legend plate. The lens has two states, either ON or OFF. For each state, you can select the lens color and the lens outline color. Although the lens can change color, the legend plate and text remain constant. You can select the legend plate text color and size, legend plate outline color and legend plate background color.



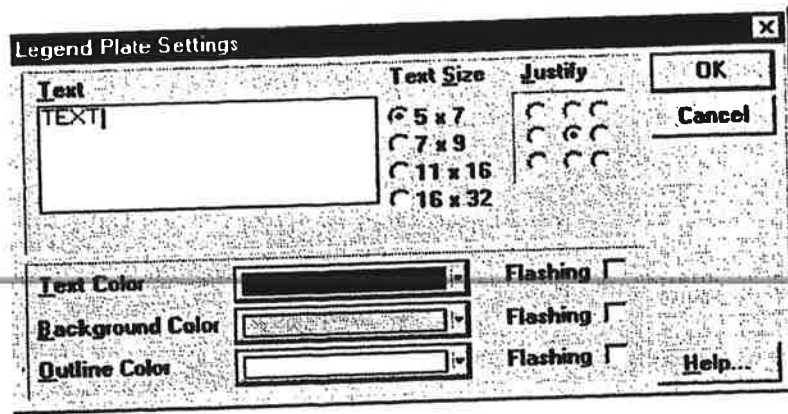
Circular Pilot Light States

The States button will display the State Settings menu. A circular pilot light has two states, ON and OFF. You can change the lens color and lens outline color of each state. Use the Light Off and Light On buttons to select a different state. The last state selected will be the one displayed when you click the OK button. If you load a color project into a monochrome unit, Red, Green and Blue will be converted to Black, and Yellow, Magenta, and Cyan will be converted to white.



Legend Plate

The legend plate describes the operation of the pilot light. This text is constant and will not change when the pilot light changes states. The text color and size, the legend plate background color, and the legend plate outline color can be changed. Click one of the Justify radio buttons to justify text. If you load a color project into a monochrome unit, Red, Green and Blue will be converted to Black, and Yellow, Magenta, and Cyan will be converted to white.



OK

Click the OK button to apply the information in the settings dialog box and close it.

Cancel

Cancel all changes to the Pilot Light Settings dialog box and exit the dialog box.

Make Default

If you decide that you want to have all Pilot Lights appear the same way, you can click the Make Default button in the Pilot Light settings dialog box. The current settings in the Pilot Light Settings dialog box will be saved. The next time you create a pilot light, the saved settings will automatically be applied.

Help

Click the Help button to gain access to help files relating to Pilot Light Settings.

Local Message Display

Creating a Local Message Display

A Local Message Display consists of a two or more stacked lenses. Each lens display is a different message. Only one message is visible at a given time. The local message display requires a single PLC variable. The messages can be controlled by a bit variable or word variable.



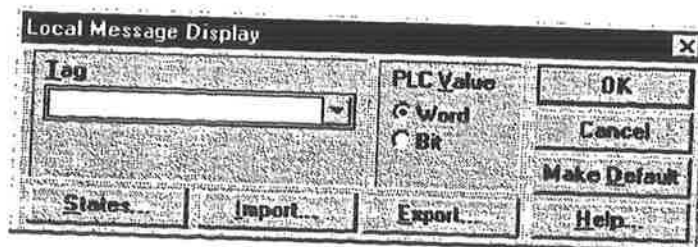
The local message display can be used to show multiple messages or conditions by assigning each message to a variable word or bit. The local message display can be expanded to cover several cells so that the local message display becomes a simple alarm message center.

Click the local message display icon on the Tools menu.



Move the cross hair and local message display image to the top of the two cells where you want the local message display to appear and click the mouse. If you want to size the local message display immediately, move the cross hair to the desired cell, click and hold the mouse button and drag the mouse to size the local message display. Release the mouse button and the local message display is sized.

The following Local Message Display dialog box will appear.

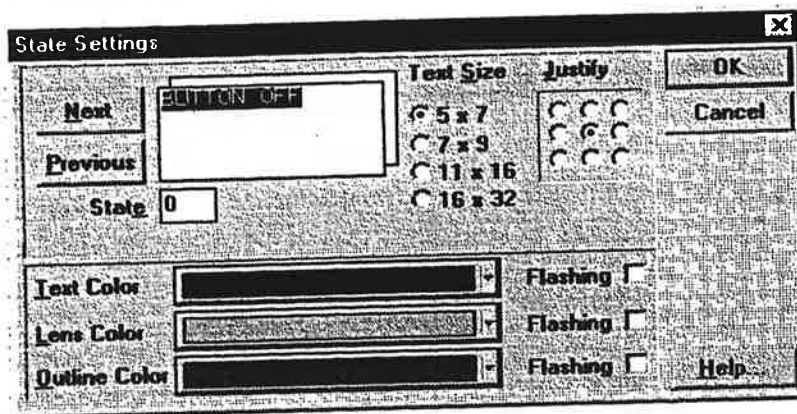


Tag Variable

The Tag is a PLC word variable. You can select whether the word is read as a numeric value (Word) or as discrete Bits (Bit). If you read the variable as a word value, then there will be 255 possible states (0 - 254). When the variable is read as discrete bits, then there are 17 possible states (16 bit positions and 0). When multiple bits are ON, the highest order bit in the ON condition determines the selected state. Enter the tag variable name and click the Word or Bit button. A list of valid PLC tags can be found by locating your PLC type in the Communications User manual. Tags can be edited by clicking the object and selecting Change Object Tags (Ctrl+T) from the Edit menu. Tag prompts can be added in the Modify Tag Attributes dialog box. You can also add or edit tag prompts by double clicking above the tag field.

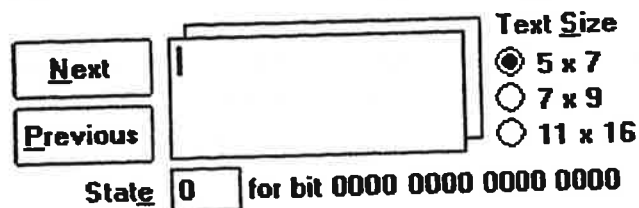
States

The States button will display the State Settings dialog box. A Local Message Display has two or more states, the maximum number depending on whether you selected the PLC variable as a word or a group of bits. You can change the text size and appearance of each state. You can justify text by clicking one of the Justify radio buttons. Use the NEXT and PREV buttons to select a different state. The last state selected will be the one displayed when you click the OK button.

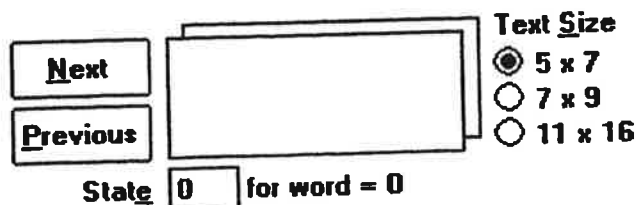


To make a blank state, enter one or more spaces in the state. States should not be completely empty.

The State Settings dialog box will indicate the current state number and the control condition for that state. The following drawing shows the states are controlled by the PLC Value set to Bit.

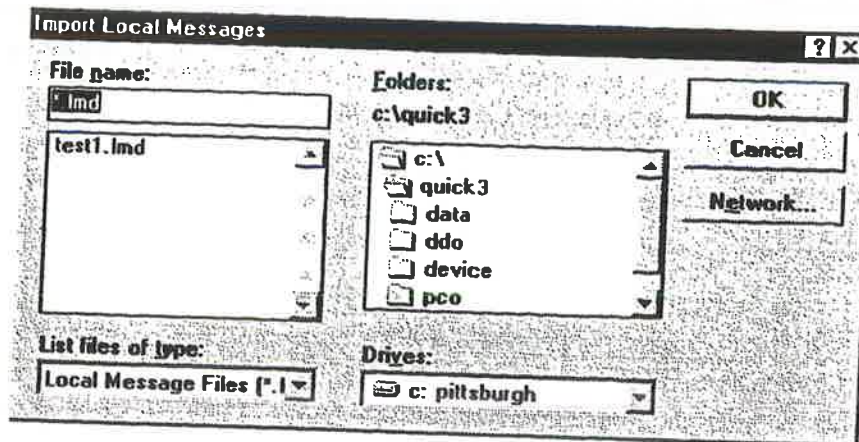


If the PLC Value was set to Word, the state dialog box would appear similar to the following.



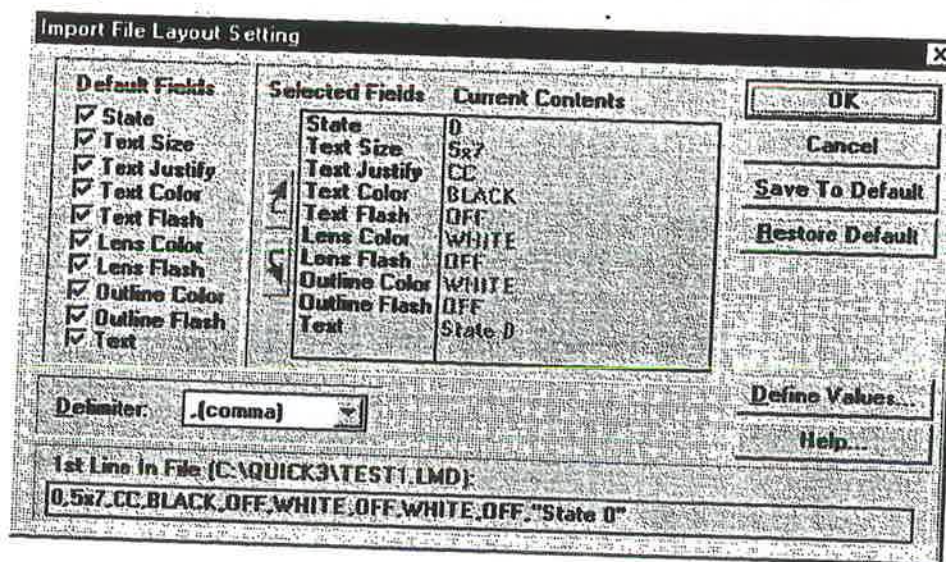
import

Import Local Message Display files (*.lmd). These files are text files saved with the *.lmd extension. A sample file is shown in the Import Local Messages dialog box. Selecting a file to import will display the Import File Layout Settings dialog box.



Import File Layout Settings

The format and layout of the import files are defined in the Import File Layout Settings dialog. A sample text file is used for illustration.



Sample Text File

The following text file contains all of the default fields. The file is comma separated into fields which correspond to the fields shown in the Import File Layout Settings dialog box. A comma separated file is easy to create but you can use any of the delimiters shown in the Delimiter list box.

```
0,7x9,UL,RED,OFF,CYAN,OFF,RED,OFF,"State 0"  
1,7x9,UL,GREEN,OFF,CYAN,OFF,RED,OFF,"State 1"  
2,7x9,UL,BLUE,OFF,CYAN,OFF,RED,OFF,"State 2"
```

Default Fields

Default Fields	
<input checked="" type="checkbox"/>	State
<input checked="" type="checkbox"/>	Text Size
<input checked="" type="checkbox"/>	Text Justify
<input checked="" type="checkbox"/>	Text Color
<input checked="" type="checkbox"/>	Text Flash
<input checked="" type="checkbox"/>	Lens Color
<input checked="" type="checkbox"/>	Lens Flash
<input checked="" type="checkbox"/>	Outline Color
<input checked="" type="checkbox"/>	Outline Flash
<input checked="" type="checkbox"/>	Text

Select which fields will be specified in the import file format. Fields not specified will be set to the default values shown in the table below. You can change the default values by using the Save to Default button. Use the Restore Default button to reset the default values to the original settings.

Default values are:

Text Size, 5x7

Text Justify, Center

Text Color, White

Text Flash, Off

Lens Color, Black

Lens Flash, Off

Outline Color, White

Outline Flash, Off

In the following text file, only the STATE and TEXT fields are used. The default values are used where no field is specified.

0, "State 0"

1, "State 1"

2, "State 2"

Selected Fields

Each field in the Default Fields section that is checked will appear in the Selected Fields section. You can change the sequence of the fields by clicking a field name, then use the up and down arrows to change its position in the list. In the following example, the State, Text Size, and Text fields are used. However, the Text Size field has been moved to the last position. The text file for the example is shown below.

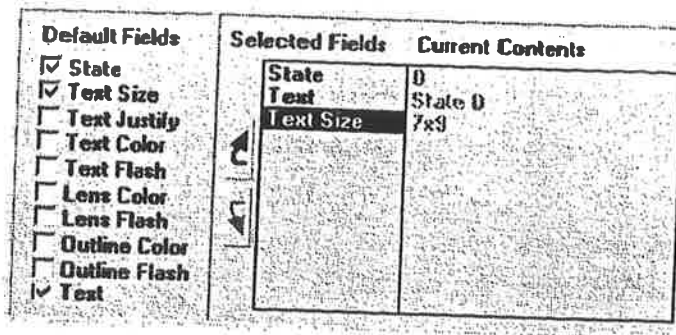
Current Contents

The Current Contents section contains the first group of selected fields.

0, "State 0", 7x9

1, "State 1", 7x9

2, "State 2", 7x9



Once you have selected a layout format for the text file, click the Save to Default button. This will save the format for the next time you import a *.lmd file.

Delimiter



A delimiter is a character that separates items in a file. The most common is a comma separated file, similar to the following example.

Bears, dogs, cats, lions, sheep, whales, elephants

Items can also be separated by Tabs, periods, exclamations, pound, dollar, percent, etc. Items can also be listed in one column with no separators. Design the format of the text file so that it is easy to read and edit.

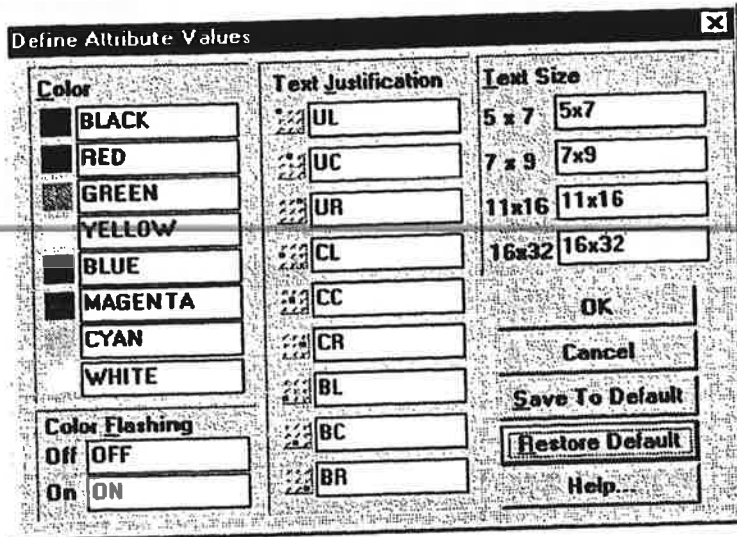
1st Line in File:

The first line of the imported file is shown in this section. You can use this line to check the layout settings for proper format. The path and file name are listed next to the section title.



Define Values

You can further define the attribute values of the text file by clicking the Define Values button. In the Color section, all the colors have their common default names. You can change BLACK to BK or any other attribute. The 5x7 Text Size can be changed from 5x7 to SMALL. Any attribute changed in this dialog box must match attributes in the text file. That is, you cannot use 5x7 in the text file if you change the attribute to SMALL. The dialog box shows the default settings for the Color, Color Flashing, Text Justification and Text Size attribute values.



Save to Default

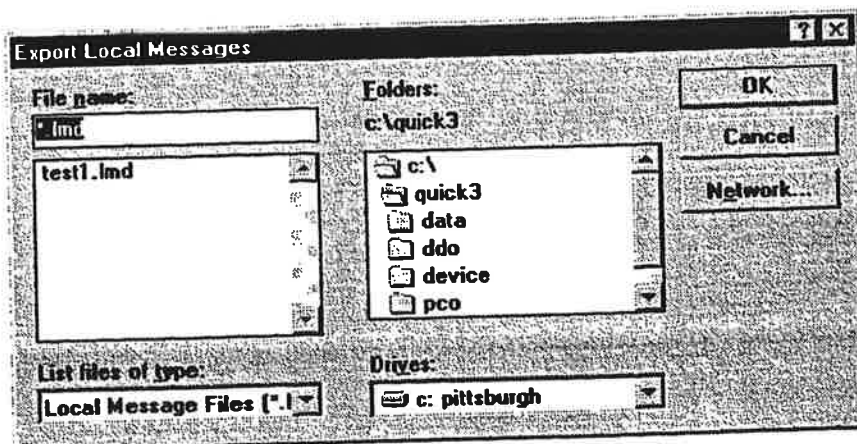
Saves the current selections in the Define Attributes Values dialog box as the new default values.

Restore Default

Changes all selections in the Define Attributes Values dialog box to the default values.

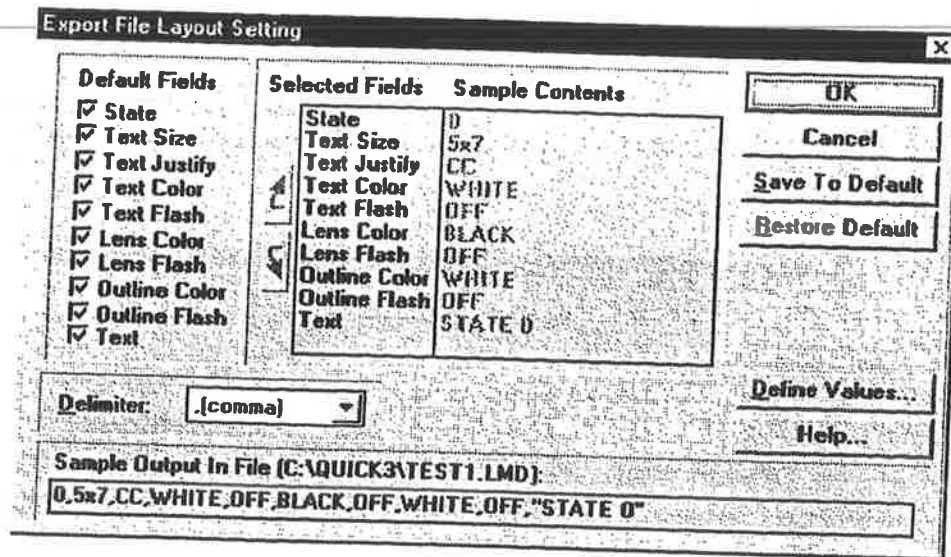
Export

Export Local Message Display files (*.lmd). These files are text files saved with the *.lmd extension. The format and layout of the files are defined in the Export File Layout Settings dialog. When you enter a file name and select a location to export a file, the Export File Layout Setting dialog is displayed.



Export File Layout Setting

The format and layout of the export files are defined in the Export File Layout Settings dialog.



Default Fields



Select which fields will be specified in the export file format. Fields not specified will be set to the default values shown in the table below. You can change the default values by using the Save to Default button. Use the Restore Default button to reset the default values to the original settings.

Default values are:

- Text Size, 5x7
- Text Justify, Center
- Text Color, White
- Text Flash, Off
- Lens Color, Black
- Lens Flash, Off
- Outline Color, White
- Outline Flash, Off

Selected Fields

Each field in the Default Fields section that is checked will appear in the Selected Fields section. You can change the sequence of the fields by clicking a field name, then use the up and down arrows to change its position in the list.

Sample Contents

The Sample Contents section contains a *sample* of what the first group of selected fields might look like.

Default Fields	Selected Fields	Sample Contents
<input checked="" type="checkbox"/> State	State	0
<input checked="" type="checkbox"/> Text Size	Text Size	5x7
<input checked="" type="checkbox"/> Text Justify	Text Justify	CC
<input checked="" type="checkbox"/> Text Color	Text Color	WHITE
<input checked="" type="checkbox"/> Text Flash	Text Flash	OFF
<input checked="" type="checkbox"/> Lens Color	Lens Color	BLACK
<input checked="" type="checkbox"/> Lens Flash	Lens Flash	OFF
<input checked="" type="checkbox"/> Outline Color	Outline Color	WHITE
<input checked="" type="checkbox"/> Outline Flash	Outline Flash	OFF
<input checked="" type="checkbox"/> Text	Text	STATE 0

Sample Output in File:

A *sample* output line for the exported file is shown in this section. You can use this line to check the layout settings for proper format. The path and file name are listed next to the section title.

Sample Output In File (C:\QUICK3\TEST1.LMD):
 0,5x7,CC,WHITE,OFF,BLACK,OFF,WHITE,OFF,"STATE 0"

Define Values

You can further define the attribute values of the text file by clicking the Define Values button. In the Color section, all the colors have their common default names. You can change BLACK to BK or any other attribute. The 5x7 Text Size can be changed from 5x7 to SMALL. Any attribute changed in this dialog box must match attributes in the text file. That is, you cannot use 5x7 in the text file if you change the attribute to SMALL. The dialog box shows the default settings for the Color, Color Flashing, Text Justification and Text Size attribute values.

The dialog box 'Define Attribute Values' contains the following sections:

- Color:** A list of color swatches with labels: BLACK, RED, GREEN, YELLOW, BLUE, MAGENTA, CYAN, WHITE.
- Color Flashing:** Two radio buttons labeled 'Off' and 'On', with 'Off' selected.
- Text Justification:** A list of text justification options: UL, UC, UR, CL, CC, CR, BL, BC, BR.
- Text Size:** A table with two columns for text size attributes. The first column shows the current value, and the second column shows the default value.

Current Value	Default Value
5 x 7	5x7
7 x 9	7x9
11x16	11x16
16x32	16x32

Buttons at the bottom include: OK, Cancel, Save To Default, Restore Default, and Help...

Save To Default

Saves the current selections in the Define Attributes Values dialog box as the new default values.

Restore Default

Changes all selections in the Define Attributes Values dialog box to the default values.

OK

Click the OK button to apply the information in the settings dialog box and close it.

Cancel

Cancel all changes to the Local Message Display Settings dialog box and exit the dialog box.

Make Default

If you decide that you want to have all Local Message Displays appear the same way, you can click the Make Default button in the Local Message Display Settings dialog box. The current settings in the Local Message Display Settings dialog box will be saved. The next time you create a Local Message Display, the saved settings will automatically be applied.

Help

Click the Help button to gain access to help files relating to Local Message Display Settings.

Alarms and Prompts

The primary purpose of the Local Message Display is to present simple alarm messages or operator prompts. The drawing shows a Local Message Display sized to fit across four cells. The display can be sized to fit almost any length message.



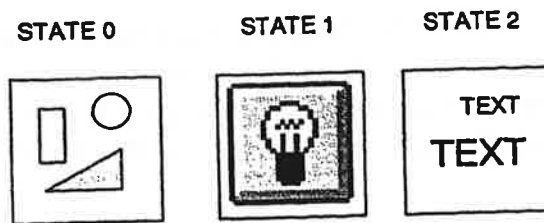
USE THE LOCAL ALARM DISPLAY FOR OPERATOR MESSAGES
AND PROMPTS. THIS MESSAGE IS 5 X 7 TEXT.

Do not confuse alarm messages in a Local Message Display with alarm messages created by the Alarm object.

Local Image Display

Local Image Display

A Local Image Display consists of two or more states. Each state can contain graphic elements such as polylines or rectangles, a bitmap, text, or combinations of graphics and text. Only one state is visible at a given time. The local image display can be used to show a single state from a group of states by assigning each state to a PLC word or bit. The following drawing shows some examples of states.



Creating States

A state can contain a single element, such as a polyline or a bitmap image. States can also contain complex images that are made of bitmaps, text, or polylines. You can think of states as a stack of pictures. States can be created by designing the elements for each state on an unused area of a panel, copying the elements to the clipboard, then pasting the grouped elements to the desired state. Once the elements are pasted, they cannot be edited. If you want to change the state, you must recreate the picture elements. This process works well for a small number of states.

Another method of creating states is to design the elements for each state and save the design in a library. The library feature allows you to view all the designs and make changes before creating the Local Image Display. This method is recommended for a Local Image Display with many states. The States dialog box has a Library button for easy access to your designs.

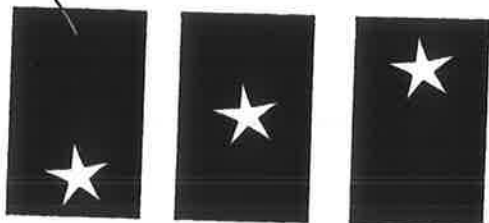
A major design consideration for the Local Image Display is the final size of the display. Once you create all the states, you can size the Local Image Display like other panel objects. When sizing the Local Image Display down, the minimum size is determined by the largest object or group of objects on any one state. For example, if you paste a large bitmap to one of the states, then you cannot size the Local Image Display any smaller than the size of the bitmap. Therefore, consider the size of objects before you begin creating states.

To ensure all states are the same size, you may want to consider using a common graphic element for each state. First, create an unfilled rectangle. Place all elements within the rectangle. Copy the rectangle and all elements to the clipboard or library, then paste them to a state. Do the same procedure for each state. When you size the Local Image Display, the smallest size will be the size of the rectangle, and all states will be exactly the same.

When creating images for the Local Image Display, it is important to remember that the Local Image Display tool draws the graphic associated with each state whenever the variable it is linked to changes. However, the graphics from the previous states are not erased when the new graphic is drawn. So it is important that the new graphic overwrites the old one entirely.

To make a moving image or multiple images, create a background for every state, such as a black box. Copy the background for each new state. Add images to each background for each new state. Now when a new state is triggered, the background will erase all the previous image.

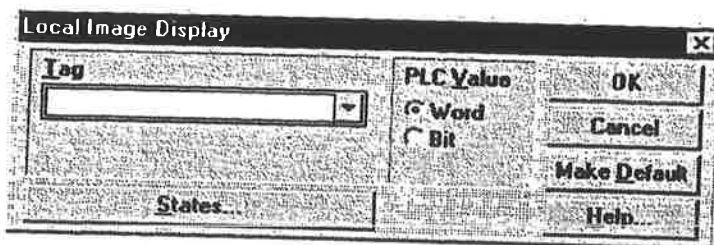
Black Background



Creating a Local Image Display

Click the local image display icon  on the Tools menu.

Move the cross hair to the top of the two cells where you want the local image display to appear and click the mouse. If you want to size the local image display immediately, move the cross hair to the desired cell, click and hold the mouse button and drag the mouse to size the local image display. Release the mouse button and the local image display is sized. The Local Image Display dialog box will appear.



Tag Variable

The Tag is a PLC word variable. You can select whether the word is read as a numeric value (Word) or as discrete Bits (Bit). If you read the variable as a word value, then there will be 256 possible states. When the variable is read as discrete bits, then there are 17 possible states (16 bit positions and 0). Enter the tag variable name and click the Word or Bit button. A list of valid PLC tags can be found by locating your PLC type in the Communications User manual. Tags can be edited by clicking the object and selecting Change Object Tags (Ctrl+T) from the Edit menu. Tag prompts can be added in the Modify Tag Attributes dialog box. You can also add or edit tag prompts by double clicking above the tag field.

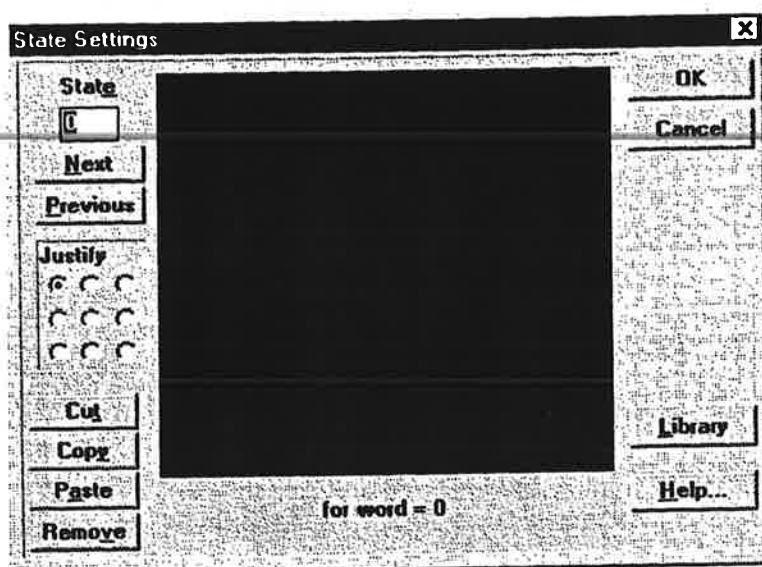
PLC Value

Select Word to control the selection of the state by the value of a PLC word. If the value of the Word is 0, then state 0 will be displayed. When the value changes to 10, then state 10 is displayed. If the PLC Value was set to Word, the state dialog box would appear similar to the following picture. (There are 256 states using Word)

Select Bit to control the selection of the state by the bit assignment of a PLC word. If no bits are set then state 0 is displayed. If bit 4 is set then state 4 is displayed. When multiple bits are ON, the highest order bit in the ON condition determines the selected state. (There are 17 states using Bit)

States

The States button will display the State Settings dialog box. A Local Image Display has two or more states, the maximum number depending on whether you selected the PLC variable as a word or a group of bits. You can change the image of each state. Use the NEXT and PREV buttons to select a different state. The last state selected will be the one displayed when you click the OK button. Empty states have an X in them.



Justify

If the image you paste to the current state does not fill the entire window, it will be forced to a position determined by the Justify selection.

Cut will remove the contents of the current state. **Copy** will duplicate the contents of the state to the clipboard. **Paste** will copy the contents of the clipboard to the current state. If the image you paste to the current state does not fill the entire window, it will be forced to a position determined by the **Justify** selection. **Remove** will remove the selected state. The **Library** button opens the library browser. Select an object from the library and copy it to the clipboard or drag it to the current state. Use the library to store state images prior to creating the Local Image Display.

OK

Click the OK button to apply the information in the settings dialog box and close it.

Cancel

Cancel all changes to the Local Message Display Settings dialog box and exit the dialog box.

Library

The Library button opens the library browser. Select an object from the library and copy it to the clipboard or drag it to the current state. Use the library to store state images prior to creating the Local Image Display.

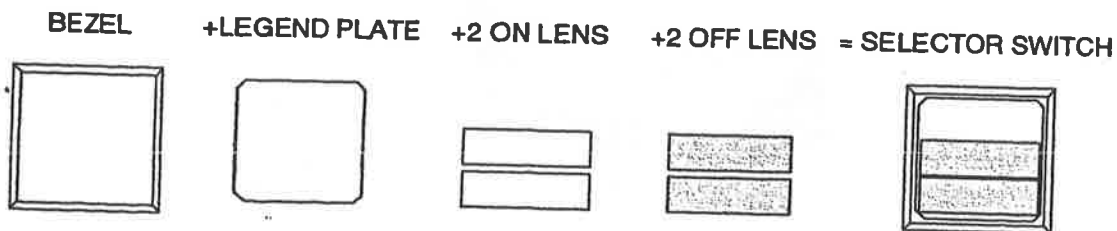
Help

Click the Help button to gain access to help files relating to Local Message Display Settings.

Selector Switch

Creating a selector switch

A Selector Switch consists of a bezel, a legend plate and initially two OFF lenses and two ON lenses. The Selector Switch requires multiple variables, one for each selector switch position. These variables will be interlocked so that only one of them can be turned on. Each time the selector switch is pressed the position that is currently on will be turned off and then the next position will be turned on. The number of positions can be two, three, or four.

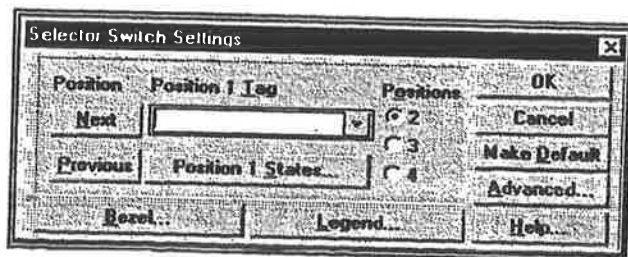


Click the Selector Switch icon on the Tools menu.



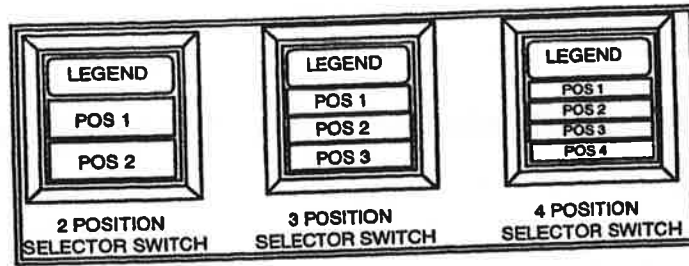
Move the cross hair and Selector Switch image to the top of the two cells where you want the Selector Switch to appear and click the mouse. If you want to size the Selector Switch immediately, move the cross hair to the desired cell, click and hold the mouse button and drag the mouse to size the Selector Switch. Release the mouse button and the Selector Switch is sized.

The following Selector Switch Settings dialog box will appear.



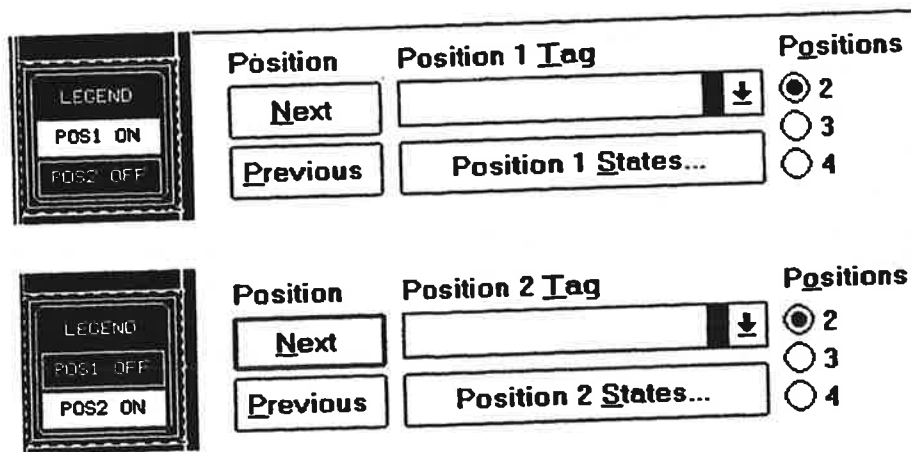
Number of Positions

You can select the number of positions that the selector switch will have by clicking one of the *Positions* option buttons. The default setting is two positions. The following drawing shows the three options.



Position Selector

The current position selector (Next and Previous buttons) allow you to choose which position of the selector switch you are editing. When you choose a position, the tag and states for that position can be edited. To edit other tags and states, change the current position selector. The following drawing shows Position 1 and Position 2 of a two position selector switch.

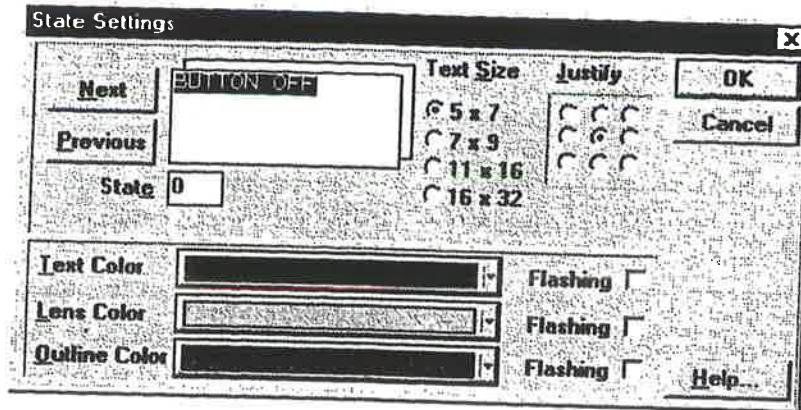


Position Tag Variable

A "tag" variable name must be assigned to each position of the Selector Switch. These tags will be a single discrete bit in the PLC memory that the target display can control. If you have selected a 2 position Selector Switch then you must define a tag bit for position 1 and another tag bit for position 2. If position 1 tag bit is ON and the Selector Switch is pressed, position 1 tag bit is turned OFF and position 2 tag bit is turned ON. Each time the Selector Switch is pressed, the current position tag bit is turned OFF and the next position tag bit will be turned ON. A list of valid PLC tags can be found by locating your PLC type in the Communications User manual. Tags can be edited by clicking the object and selecting Change Object Tags (Ctrl+T) from the Edit menu. Tag prompts can be added in the Modify Tag Attributes dialog box. You can also add or edit tag prompts by double clicking above the tag field.

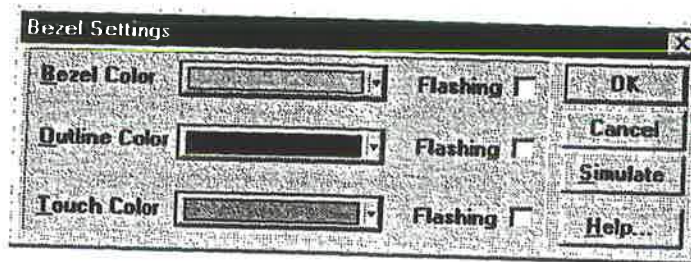
States

The States button will display the State Settings menu. Each position of the Selector Switch has two states, ON and OFF. You can change the text size and appearance of each state. You can justify text by clicking one of the Justify radio buttons. Use the Next and Previous buttons to select a different state. The last state selected will be the one displayed when you click the OK button. If you load a color project into a monochrome unit, Red, Green and Blue will be converted to Black, and Yellow, Magenta, and Cyan will be converted to white.



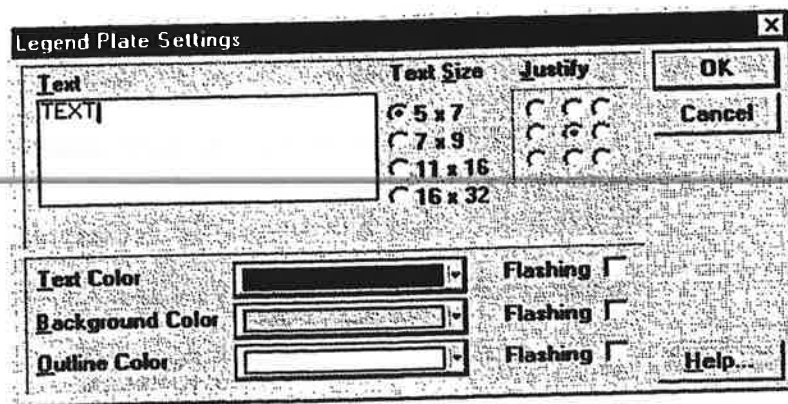
Bezel

The Bezel portion of the Selector Switch is used to give a visual indication to the operator that the button was pressed. The bezel, outline, and touch color can be modified to enhance the visual impact of the Selector Switch. When the Selector Switch is not pressed the bezel color is displayed, but when the Selector Switch is pressed the touch color will be displayed. The outline color remains constant whether the Selector Switch is pressed or not pressed. Press the Simulate button to observe the action of the bezel color change. If you load a color project into a monochrome unit, Red, Green and Blue will be converted to Black, and Yellow, Magenta, and Cyan will be converted to white.



Legend Plate

The legend plate allows you to provide text information to the operator on the action that will occur when the Selector Switch is pressed. This text is constant and will not change when the Selector Switch is pressed. The text size can be changed, and the text can be justified by clicking one of the Justify radio buttons. The text color, background color, and outline color can be modified in appearance to enhance the application. If you load a color project into a monochrome unit, Red, Green and Blue will be converted to Black, and Yellow, Magenta, and Cyan will be converted to white.



OK

Click the OK button to apply the information in the settings dialog box and close it.

Cancel

Cancel all changes to the Selector Switch Settings dialog box and exit the dialog box.

Make Default

If you decide that you want to have all Selector Switches appear the same way, you can click the Make Default button in the Selector Switch Settings dialog box. The current settings in the Selector Switch Settings dialog box will be saved. The next time you create a Selector Switch, the saved settings will automatically be applied.

Advanced Button

Clicking the Advanced button will display the Advanced Settings dialog box. The Selector Switch Button operation can be assigned to an external keypad. See Keypads, page 194 and Keypad Assignment, page 91, for additional information. Once a keypad is assigned, you can disable the touch screen by checking the *Touch disable* box. If you leave the touch disable box unchecked, then the touch screen and the keypad can both operate the button.

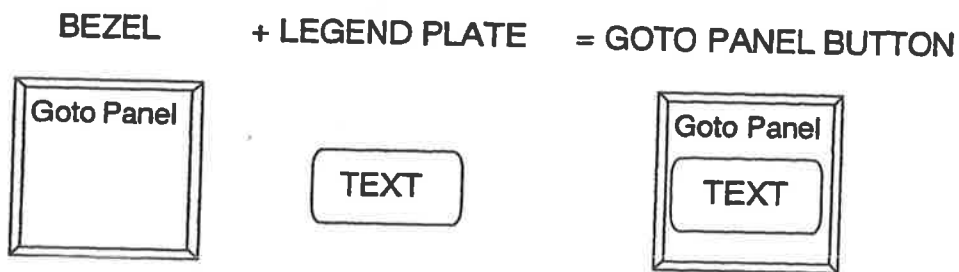
Help

Click the Help button to gain access to help files relating to Selector Switch Settings.

Goto Panel Push Button

Creating a Goto Panel push button

A Goto Panel push button consists of a bezel and a legend plate. The Goto panel push button will allow changing from the currently displayed panel to another selected panel.

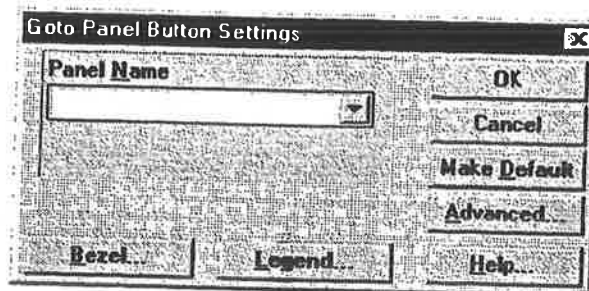


Click the Goto Panel button icon on the Tools menu.



Move the cross hair and Goto Panel button image to the top of the two cells where you want the Goto Panel button to appear and click the mouse. If you want to size the Goto Panel button immediately, move the cross hair to the desired cell, click and hold the mouse button and drag the mouse to size the Goto Panel button. Release the mouse button and the Goto Panel button is sized.

The following Goto Panel Button Settings dialog box will appear.



Panel Name

Use the drop-down list box or type the name of the panel you want to Goto when this push button is pressed.

Each panel you design must be saved with a unique file name. This file name is the only name that is valid for the Goto panel name. You can see a list of current panel names when you select File/Open or File/Save.

There is a dilemma in creating a Goto panel button when the panel you intend to go to has not been created yet. For example, if you are working on your very first panel and you create a Goto push button that will be used to go to the next panel, what name will be used in the Panel Name field? The name you pick must be *exactly* the same name as the panel you intend to go to. For example, assume that you intend to go to the panel called MAIN. You must enter the panel name as "MAIN". You cannot use, "main." When you create the panel called "MAIN", make sure you save it using the name "MAIN."

Using Goto Panel Buttons

The Goto Panel button has two modes of operation. In the local mode, pressing the Goto Panel button will display the designated panel. No connection to the PLC is required. In the PLC mode, a register in the PLC is used to trigger the desired panel. The Goto button writes the Panel Id number to the PLC register. When any new Panel Id is written to the PLC register, the target display reads the value and the new panel will be triggered.

The mode is determined by the Panel Trigger Tag option in the display device Configuration dialog box.

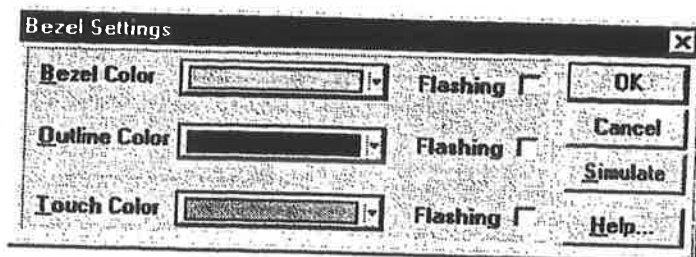
If the Panel Trigger Tag is left blank, then the Goto button works in the local mode. When you press the Goto button, the selected panel will be displayed. You do not have to be connected to a PLC for the Goto button to work properly.

If you designate a Panel Trigger Tag, the target display **MUST** be connected to the PLC for the Goto button to work properly. Pressing the Goto button causes the target display to write the Panel ID number to the Panel Trigger Tag. The target display will then read the Panel Trigger Tag register, and when it sees a change in value, it will trigger the designated panel. You must have a good communication link to the PLC for the Panel Trigger Tag to work correctly.

To reach the display device configuration dialog box, go to Projects and click Setup. In the Project Setup dialog box, click the Setup button for the display device. The target display Configuration dialog will appear.

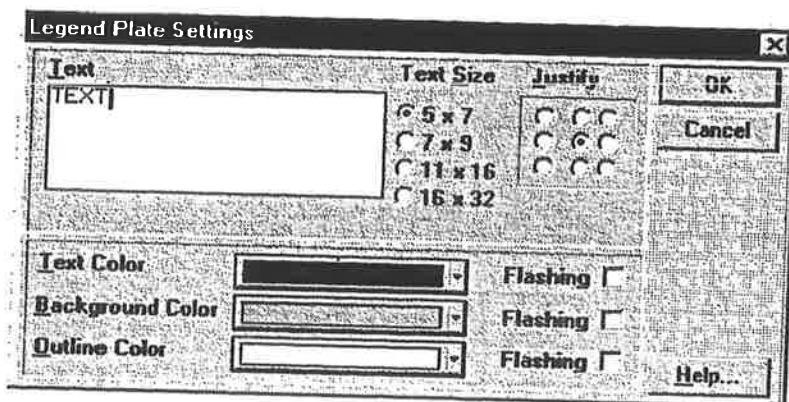
Bezel

The Bezel portion of the Goto Panel push button presents a visual indication to the operator that a new panel will be displayed when it is pressed. The bezel, outline, and touch color can be modified to enhance the visual impact of the Goto Panel push button. When the push button is not pressed the bezel color is displayed, but when the Goto Panel push button is pressed the touch color will be displayed. The outline color remains constant whether the Goto Panel push button is pressed or not. Press the Simulate button to observe the action of the bezel color change. If you load a color project into a monochrome unit, Red, Green and Blue will be converted to Black, and Yellow, Magenta, and Cyan will be converted to white.



Legend Plate

The legend plate allows you to provide text information to the operator about what panel will be displayed when the Goto Panel push button is pressed. This text is constant and will not change when the Goto Panel push button is pressed. The text size can be changed, and the text can be justified by clicking one of the Justify radio buttons. The text color, background color, and outline color can be modified in appearance to enhance the application. If you load a color project into a monochrome unit, Red, Green and Blue will be converted to Black, and Yellow, Magenta, and Cyan will be converted to white.



OK

Click the OK button to apply the information in the Goto Panel Button Settings dialog box and close

Cancel

Cancel all changes to the Goto Panel Button Settings dialog box and exit the dialog box.

Make Default

If you decide that you want to have all Goto Panels appear the same way, you can click the Make Default button in the Goto Panel Button Settings dialog box. The current settings in the Goto Panel Settings dialog box will be saved. The next time you create a Goto Panel, the saved settings will automatically be applied.

Advanced Button

Clicking the Advanced button will display the Advanced Settings dialog box. The Goto Panel Button operation can be assigned to an external keypad. See Keypads, page 194 and Keypad Assignment, page 91, for additional information. Once a keypad is assigned, you can disable the touch screen by checking the *Touch disable* box. If you leave the touch disable box unchecked, then the touch screen and the keypad can both operate the button.

Help

Click the Help button to gain access to help files relating to Goto Panel Settings.

Numeric Data Display

Creating a Numeric Data Display

A Numeric Data Display consists of a numeric readout and a legend plate. The data display requires a PLC tag variable for the numeric data.

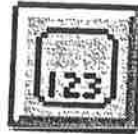
LEGEND PLATE + NUMERIC READOUT = NUMERIC DATA DISPLAY



123.45

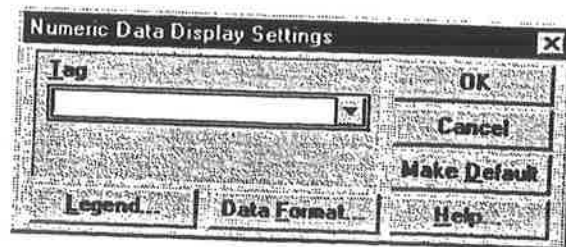


Click the Numeric Data Display icon on the Tools menu.



Move the cross hair and the Numeric Data Display image to the top of the two cells where you want the Numeric Data Display to appear and click the mouse. If you want to size the Numeric Data Display immediately, move the cross hair to the desired cell, click and hold the mouse button and drag the mouse to size the Numeric Data Display. Release the mouse button and the Numeric Data Display is sized.

The following Numeric Data Display dialog box will appear.

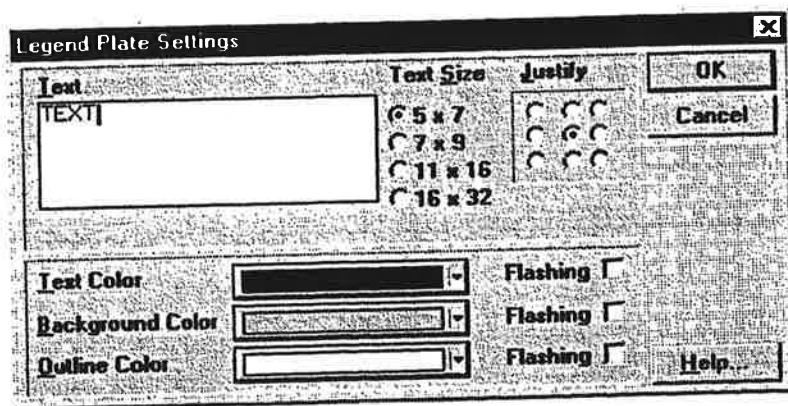


Tag Variable

A "tag" variable name must be assigned to the numeric Data Display. This tag will be a word in the PLC memory that the target display can read. A list of valid PLC tags can be found by locating your PLC type in the Communications User manual. Tags can be edited by clicking the object and selecting Change Object Tags (Ctrl+T) from the Edit menu. Tag prompts can be added in the Modify Tag Attributes dialog box. You can also add or edit tag prompts by double clicking above the tag field.

Legend Plate

The legend plate allows you to provide text information to the operator about the meaning of the current value being displayed. The text size can be changed, and the text can be justified by clicking one of the Justify radio buttons. The text color, background color, and outline color can be modified in appearance to enhance the application. If you load a color project into a monochrome unit, Red, Green and Blue will be converted to Black, and Yellow, Magenta, and Cyan will be converted to white.



Data Format Settings

The Text Size selected will determine the maximum number of digits available for viewing. Smaller text allows more characters in the text field.

Justification determines if the text characters are forced to the Left, Right, or Center.

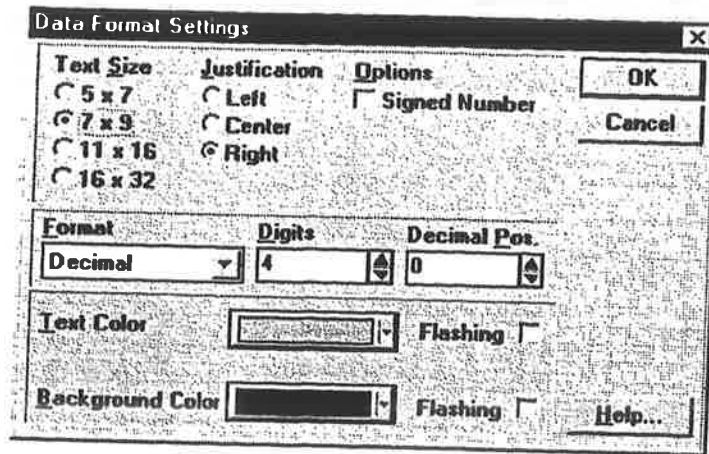
The display can show a Signed Number (+/- sign) if the PLC supports signed values.

The Format of the data can be decimal, binary, hexadecimal, octal, or floating point. The data color and background can be modified to enhance the appearance.

The number of Digits that will be displayed can be selected and will be equal to or less than the maximum allowed because of the text size selected.

The number of Decimal Positions is the number of digits that will be displayed to the right of the decimal point. A decimal point is counted as one of the Digits positions.

If you load a color project into a monochrome unit, Red, Green and Blue will be converted to Black, and Yellow, Magenta, and Cyan will be converted to white.



OK

Click the OK button to apply the information in the settings dialog box and close it.

Cancel

Cancel all changes to the Numeric Data Display Settings dialog box and exit the dialog box.

Make Default

If you decide that you want to have all Numeric Data Displays appear the same way, you can click the Make Default button in the Numeric Data Display Settings dialog box. The current settings in the Numeric Data Display Settings dialog box will be saved. The next time you create a Numeric Data Display, the saved settings will automatically be applied.

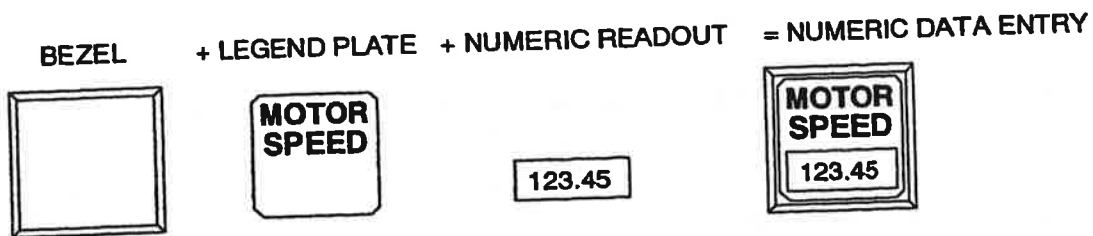
Help

Click the Help button to gain access to help files relating to Numeric Data Display Settings.

Numeric Data Entry

Creating a Data Display with Keypad Entry

A numeric data display with data entry consists of a bezel, numeric readout and a legend plate. The data display also requires a variable that it will read and display the current value. When the bezel is touched, the screen will display a data entry panel.

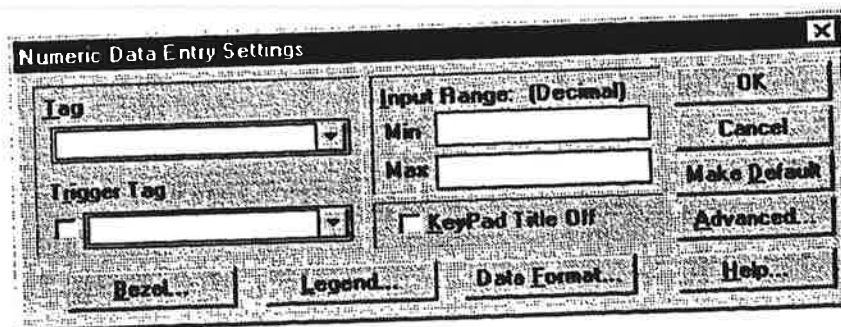


Click the Numeric Data Entry icon on the Tools menu.



Move the cross hair and the Numeric Data Entry image to the top of the two cells where you want the Numeric Data Entry to appear and click the mouse. If you want to size the Numeric Data Entry immediately, move the cross hair to the desired cell, click and hold the mouse button and drag the mouse to size the Numeric Data Entry. Release the mouse button and the Numeric Data Entry is sized.

The following Numeric Data Entry Settings dialog box will appear.



Tag Variable

A "tag" variable name must be assigned to the Numeric Data Entry. This tag will be a word in the PLC memory that the target display can read and update. A list of valid PLC tags can be found by locating your PLC type in the Communications User manual. Tags can be edited by clicking the object and selecting Change Object Tags (Ctrl+T) from the Edit menu. Tag prompts can be added in the Modify Tag Attributes dialog box. You can also add or edit tag prompts by double clicking above the tag field.

Trigger Tag

This tag will be a word/bit in the PLC memory that the target display can write to. A bit is set when the ENTER key is pressed and reset when the ENTER key is released. If a word is selected for the trigger tag, the low order bit is set. A list of valid PLC tags can be found by locating your PLC type in the Communications User manual. Tags can be edited by clicking the object and selecting Change Object Tags (Ctrl+T) from the Edit menu. Tag prompts can be added in the Modify Tag Attributes dialog box. You can also add or edit tag prompts by double clicking above the tag field.

Keypad Title Off

When you touch a Numeric Data Entry button, the current panel is erased and replaced by a numeric data entry panel. The legend text from the Numeric Data Entry button will normally appear at the top of the data entry panel. Checking the Keypad Title Off box will remove the text from the top of the data entry panel. See the *Data Entry Panel* on page 171.

Input Range

The min and max range settings are determined by the PLC type and the tag variable type. You can change the range values to allow only a specific range of values.

If you enter an incorrect value for the min or max range values, an error message will appear. The dialog box will identify the type of error and display the User Defined Range and the Default PLC Range. Buttons in the dialog box allow editing the user defined range values or using the default settings.

Value Out of Range

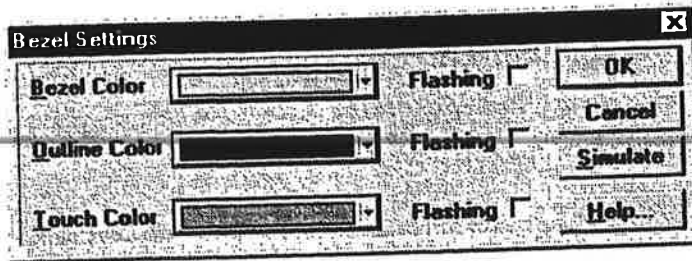
Max is outside the valid input range defined in the PLC. Either go back and edit the Max value so that it is within range or press the "Use Default PLC Range" button to use the PLC's default Max value.

User Defined Range	Default PLC Range
Min 0	Min 0
Max 67000	Max 65535

Edit User Defined Range Use Default PLC Range

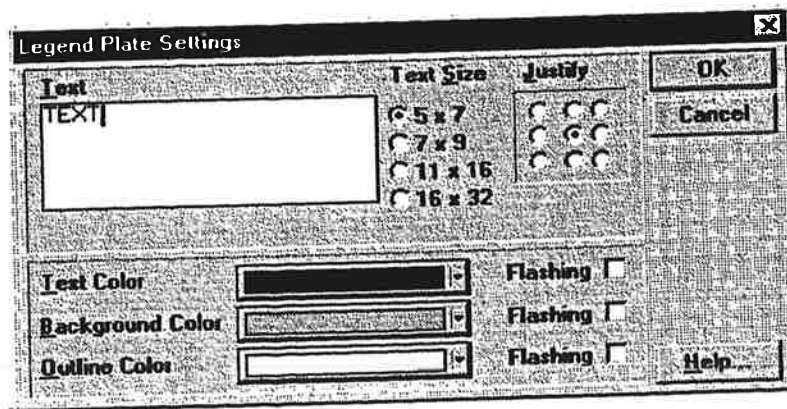
Bezel

The Bezel portion of the Numeric Data Entry is used to give a visual indication to the operator that the button was pressed. The bezel, outline, and touch color can be modified to enhance the visual impact of the Numeric Data Entry button. When the push button is not pressed the bezel color is displayed, but when the push button is pressed the touch color will be displayed. The outline color remains constant whether the push button is pressed or not pressed. Press the Simulate button to observe the action of the bezel color change. If you load a color project into a monochrome unit, Red, Green and Blue will be converted to Black, and Yellow, Magenta, and Cyan will be converted to white.



Legend Plate

The legend plate allows you to provide text information to the operator about the meaning of the current value being displayed. The text size can be changed, and the text can be justified by clicking one of the Justify radio buttons. The text color, background color, and outline color can be modified in appearance to enhance the application. If you load a color project into a monochrome unit, Red, Green and Blue will be converted to Black, and Yellow, Magenta, and Cyan will be converted to white.



Data Format Settings

The data format settings dialog box allows setting up the display information.

The Text Size selected will determine the maximum number of digits available for viewing. Smaller text allows more characters in the text field.

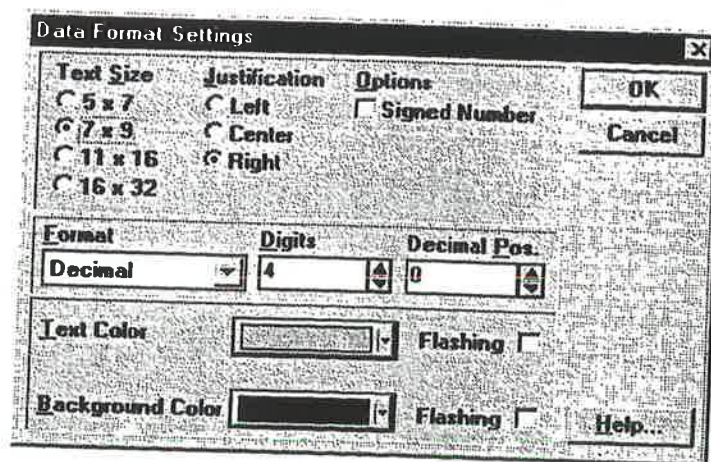
Justification determines if the text characters are forced to the Left, Right, or Center.

The display can show a Signed Number (+/- sign) if the PLC supports signed values.

The Format of the data can be decimal, binary, hexadecimal, octal, or floating point. The data color and background can be modified to enhance the appearance.

The number of Digits that will be displayed can be selected and will be equal to or less than the maximum allowed because of the text size selected.

The number of Decimal Positions is the number of digits that will be displayed to the right of the decimal point. A decimal point is counted as one of the Digits positions.



The screenshot shows a dialog box titled "Data Format Settings" with a close button (X) in the top right corner. The dialog is organized into several sections:

- Text Size:** A vertical list of radio buttons with the following options: 5 x 7, 7 x 9 (selected), 11 x 16, and 16 x 32.
- Justification:** A vertical list of radio buttons with the following options: Left, Center, and Right (selected).
- Options:** A checkbox labeled "Signed Number" which is currently unchecked.
- Buttons:** "OK" and "Cancel" buttons are located in the top right area.
- Format:** A dropdown menu currently set to "Decimal".
- Digits:** A numeric input field containing the value "4".
- Decimal Pos.:** A numeric input field containing the value "0".
- Text Color:** A color selection box with a dropdown arrow.
- Background Color:** A color selection box with a dropdown arrow.
- Flashing:** Two checkboxes, one for "Text Color" and one for "Background Color", both of which are unchecked.
- Help...:** A button located in the bottom right corner.

Data Entry Panel

When the Numeric Data Entry push button is pressed, a data entry panel (keypad) will be displayed. The legend text from the Numeric Data Entry button will be displayed on the top of the panel as the keypad title. You can delete the keypad title by checking the KeyPad Title Off box in the Numeric Data Entry Settings dialog box. Removing the keypad title allows room for larger keypads. Both versions of the keypad are shown below.

The data entry panel will look different if you are using an optional keypad. See Keypads, page 194 and Keypad Assignment, page 91, for additional information.

The current variable value is displayed in the Current Value field. The min and max entry values are displayed. Press the numeric buttons and the ENTER button to enter a new value. If the value is out of range or otherwise incorrect, the display will beep and a warning message will flash. If the data is valid when you press the ENTER button, the value will be sent to the PLC. Press the DONE button to return to the normal display.

NUMERIC DATA ENTRY			
Current Value:		55	
Minimum >>>		65535	
		55	
Minimum >>>		0	
1	2	3	BK SP
4	5	6	ENTER
7	8	9	
+/-	0	.	DONE

Current Value:		55	
Minimum >>>		65535	
		55	
Minimum >>>		0	
1	2	3	BK SP
4	5	6	ENTER
7	8	9	
+/-	0	.	DONE

OK

Click the OK button to apply the information in the settings dialog box and close it.

Cancel

Cancel all changes to the Numeric Data Entry Settings dialog box and exit the dialog box.

Make Default

If you decide that you want to have all numeric data entry buttons appear the same way, you can click the Make Default button in the Numeric Data Entry Settings dialog box. The current settings in the Numeric Data Entry Settings dialog box will be saved. The next time you create a Numeric Data Entry button, the saved settings will automatically be applied.

Advanced Button

The Numeric Data Entry Button operation can be assigned to an external keypad. See Keypads, page 194, and Keypad Assignment, page 91, for additional information. Once a keypad is assigned, you can disable the touch screen by checking the *Touch disable* box. If you leave the touch disable box unchecked, then the touch screen and the keypad can both operate the button.

Help

Click the Help button to gain access to help files relating to Numeric Data Entry Settings.

Text Display

Creating a Text Display

A Text Display consists of an alphanumeric readout and a legend plate. Data is read from a PLC register and displayed as text.

If your PLC supports text variables, the PLC register will be read as two text characters. Otherwise the PLC register will be read as a single text character.

LEGEND PLATE + ALPHANUMERIC READOUT = TEXT DISPLAY

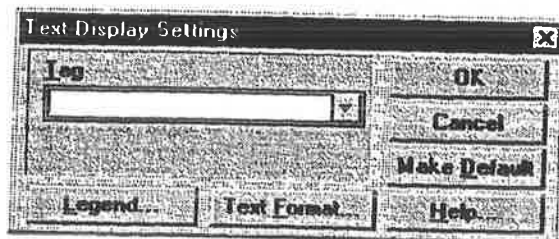


Click the Text Display icon on the Tools menu.



Move the cross hair and the Text Display image to the top of the two cells where you want the Text Display to appear and click the mouse. If you want to size the Text Display immediately, move the cross hair to the desired cell, click and hold the mouse button and drag the mouse to size the Text Display. Release the mouse button and the Text Display is sized.

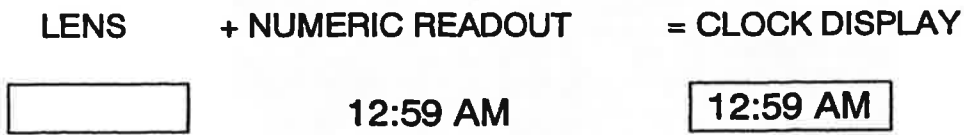
The following Text Display dialog box will appear.



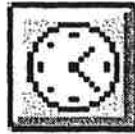
Clock

Creating a clock display

A clock display consists of a bezel and numeric readout.

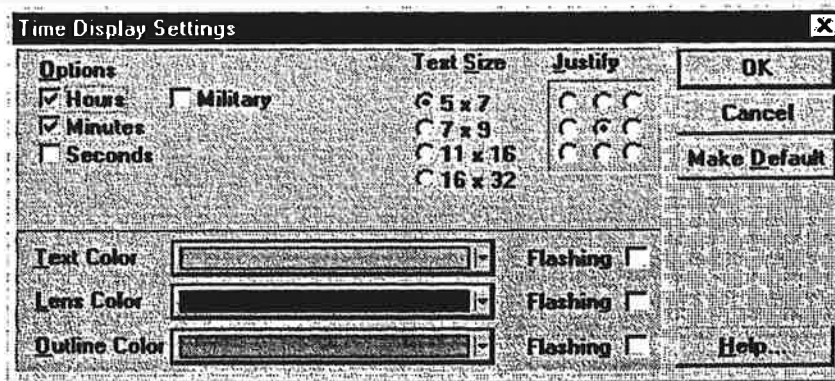


Click the Clock icon on the Tools menu.



Move the cross hair and clock image to the top of the cell where you want the clock to appear and click the mouse. If you want to size the clock immediately, move the cross hair to the desired cell, click and hold the mouse button and drag the mouse to size the clock. Release the mouse button and the clock is sized.

The following Time Display Settings dialog box will appear. The text size can be changed, and the text can be justified by clicking one of the Justify radio buttons. The text color, lens color, and outline color can be modified. If you load a color project into a monochrome unit, Red, Green and Blue will be converted to Black, and Yellow, Magenta, and Cyan will be converted to white.

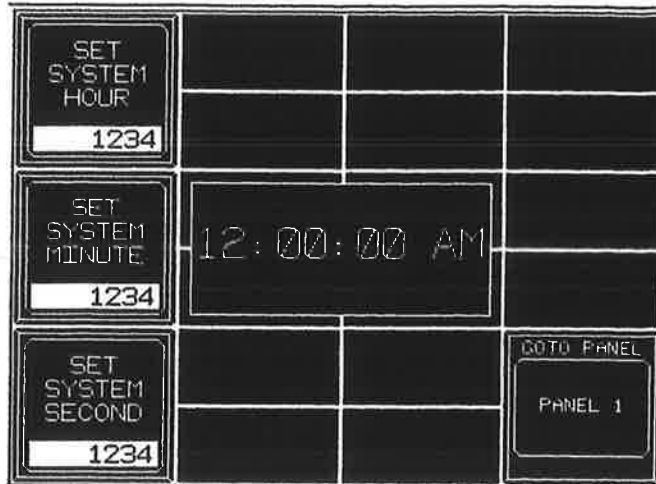


The default settings for time are hours and minutes, in 12 hour format. You can add seconds to the clock display by checking the Seconds box. Military time is displayed in 24 hour format. For example, 2:30PM would be 1430 hours.

Setting the target display time

The *QUICKDESIGNER* software includes a tool for displaying the system time. The tool currently does not include a dialog box for setting the time. To set the time, use the Numeric Data Entry tool to set the hour, minutes, and seconds. (Do not use any other tool to modify the internal clock.)

Create a new panel and use any name you like for the panel. The panel will consist of three Numeric Data Entry objects and one Numeric Data Display. The three data entry objects will be used for setting the hours, minutes and seconds. The data display will be used to verify the clock setting.



Select the Numeric Data Entry object and place it on the panel. When the Numeric Data Entry Settings dialog box appears, enter the tag name as `~System_Hour`. You must type the tag name exactly as shown, including the tilde at the beginning. Remember to enter the desired text in the legend plate to identify the object as system hour.

Create two more Numeric Data Entry objects, using the tag names `~System_Minute` and `~System_Second`. Remember to enter the desired text in the legend plates to identify system minute and system second.

Select the clock operator and place it on the panel. Click the seconds box so the clock displays hours, minutes and seconds. Military time refers to the 24 hour format.

Save the panel and download it to the target display. Use the data entry operators to set the clock for your display. The target display maintains the system time between power cycles.

Bar Graphs

Creating a bar graph

A bar graph consists of a legend plate and a special display that shows data in a bar graph format.

LEGEND PLATE + BAR GRAPH + FACEPLATE = BAR GRAPH

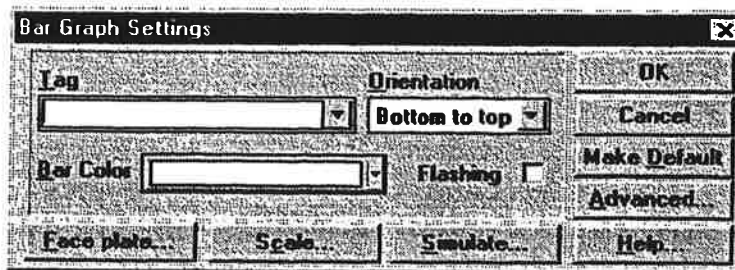


Click the bar graph icon on the Tools menu.



Move the cross hair to the top of the two cells where you want the bar graph to appear and click the mouse. If you want to size the bar graph immediately, move the cross hair to the desired cell, click and hold the mouse button and drag the mouse to size the bar graph. Release the mouse button and the bar graph is sized.

The following Bar Graph Settings dialog box will appear. Note the Face plate, Scale, and Simulate buttons, which when pressed will display the associated dialog box. If you load a color project into a monochrome unit, Red, Green and Blue will be converted to Black, and Yellow, Magenta, and Cyan will be converted to white.



Tag Variable

A "tag" variable name must be assigned to the numeric Bar Graph operator. This tag will be a word in the PLC memory that the *QUICKPANEL* can read. A list of valid PLC tags can be found by locating your PLC type in the Communications User manual. Tags can be edited by clicking the object and selecting Change Object Tags (Ctrl+T) from the Edit menu. Tag prompts can be added in the Modify Tag Attributes dialog box. You can also add or edit tag prompts by double clicking above the tag field.

NOTE: Any variable assigned to a Bar Graph **MUST** be a 16 bit integer type variable.

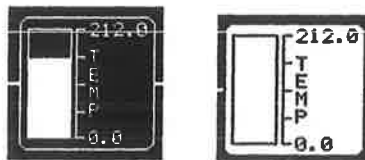
Orientation

There are four ways to orient the bar graph:

- bottom to top: as the value is increased from min to max, the graph will grow from the bottom to the top.
- top to bottom: as the value is increased from min to max, the graph will grow from the top to the bottom.
- left to right: as the value is increased from min to max, the graph will grow from the left to the right.
- right to left: as the value is increased from min to max, the graph will grow from the right to the left.

Face Plate

The face plate settings allow you to select different background and outline colors for the bar graph. A sample is shown below. Text color must be set separately. If you load a color project into a monochrome unit, Red, Green and Blue will be converted to Black, and Yellow, Magenta, and Cyan will be converted to white.



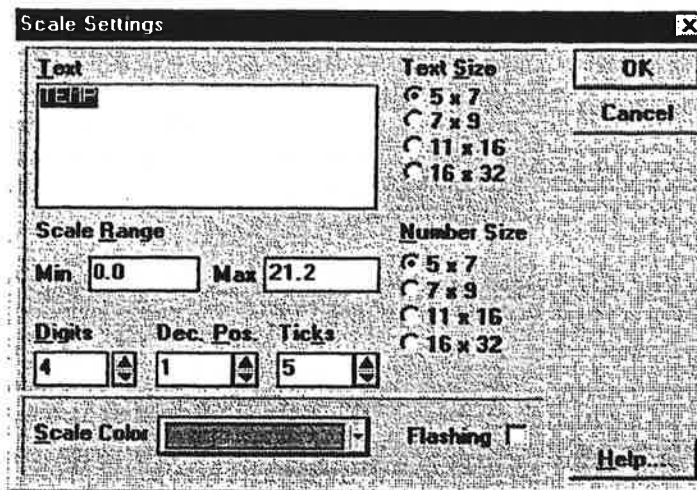
Scale

The Scale Settings menu is used to customize the bar graph. Enter the Text and select the Text Size to appear on the graph. Text is vertical for top-to-bottom and bottom-to-top graphs, and horizontal for left-to-right and right-to-left graphs.

Enter the Scale Range, enter Min (minimum) and Max (maximum) values. Number Size refers to the numbers on the scale. Select the number of number Digits and Decimal Positions. A decimal position is the number of digits to the right of the decimal point. The decimal point counts as a digit.

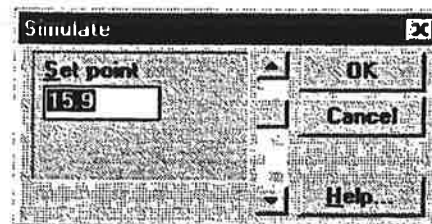
Tick marks are placed next to the bar graph to delineate the graph into equal segments. Select the number of tick marks for the graph.

Select the Scale Color and click OK to complete the bar graph. If you load a color project into a monochrome unit, Red, Green and Blue will be converted to Black, and Yellow, Magenta, and Cyan will be converted to white.



Simulate

Simulate allows viewing the graph as the data value is changed between the minimum and maximum values with the scroll bar.



OK

Click the OK button to apply the information in the settings menu and close the menu.

Cancel

Cancel all changes to the Bar Graph Settings dialog box and exit the dialog box.

Make Default

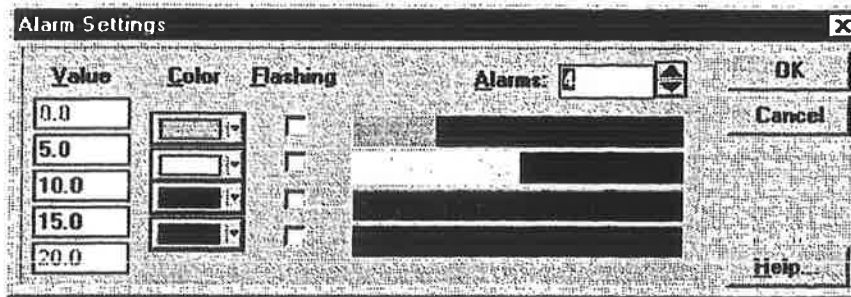
If you decide that you want to have all bar graphs appear the same way, you can click the Make Default button in the Bar Graph Settings menu. The current settings in the Bar Graph Settings menu will be saved. The next time you create a bar graph, the saved settings will automatically be applied.

Advanced

Clicking the Advanced button brings up the Alarm Settings dialog box. The bar graph can be divided into different sections, based on the range value and color. The bar graph can therefore show different colors for different alarm variable values. The following dialog shows a single color for a range of 0 to 20.



To add more alarm ranges, click the up arrow button to the right of the Alarms number box. Each increase will add another Value box and Color selection button. In the following example, there are four ranges selected and each range has a different color and value setting. The ranges are : 0 to 5, 5 to 10, 10 to 15, and 15 to 20. The minimum and maximum range values cannot be changed in this dialog box. You can change them in the Scale Settings dialog.



Use caution when selecting the value for the alarm range. A short review of Bar Graphs is necessary before we discuss alarm values.

You can set the Min and Max scale values to show the full value of the tag variable or some portion of it. For example, if the tag variable has an actual value of 0 to 65535, you can go to the Scale Settings dialog box and set the Min to 0 and the Max to 65535 to display the full variable range. See Figure 1.

If you set the Min to 0 and the Max to 200, then the bar graph will display only the range of the variable from 0 to 200. See Figure 2.

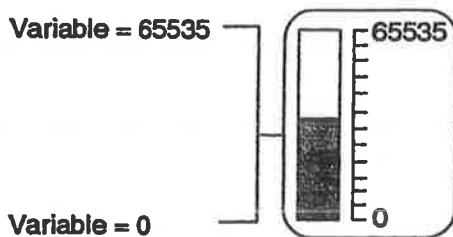


Figure 1

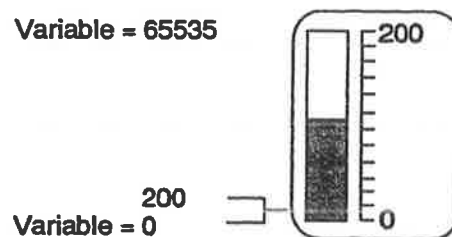


Figure 2

The bar graph is divided into 100 segments which represent 1 percent of the range value. For example, if the Min and Max scale range is 0 to 200, then each increment of the bar graph is 1 percent, or 2. Each time the variable increases by 2, the bar graph will show a change.

The alarm values operate by changing colors at the 1 percent points. In the previous example, the alarm values can change colors at 2, 4, 6, 8, etc.

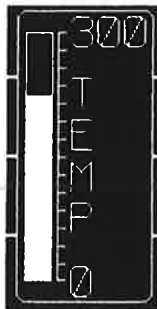
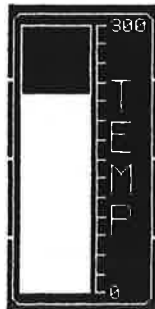
If you set the value for changing colors to 5, it will not work since the changes can only occur at the 1 percent increment points. The bar can change color at 4 and 6, but not at 5. The range value must be divided by 100 to arrive at the true change points. For example, if the Min is set to 0 and the Max is set to 500, then 1 percent of the range is 5. The alarm values in this case can be set to change at increments of 5.

Help

Click the Help button to gain access to help files relating to Bar Graph Settings.

Examples


The following examples illustrate the variety of bar graphs you can easily create. Experiment with different size text, changing the number of ticks, min and max values and other settings to make the desired graph. Remember that you can resize the bar graph to fit more than two cells.

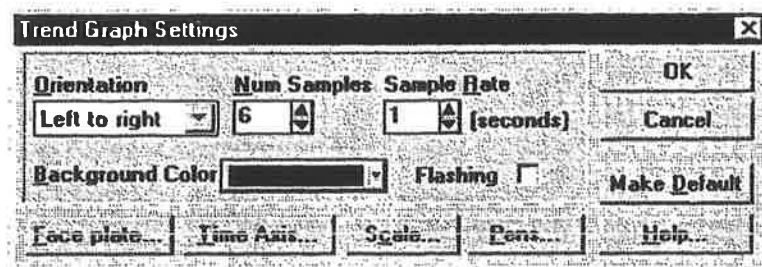


Trend

Creating a Trend Display

When you read a variable from a control device, you have one piece of data that can be displayed in a panel operator, such as a Numeric Display. When you read the same variable over a period of time and save the data, you have collected a data set. When you show all the points in the data set, you have a trend display. If you read a variable over a period of time, collect the data set in a buffer and display the data, you have a QuickPanel trend display. The Trend display is capable of displaying data from multiple data sets.

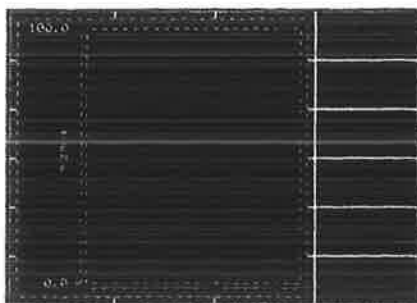
To add a trend display to a panel, click the trend icon  in the floating Tools menu. The Trend Graph Settings dialog box appears. Each of the buttons controls a major section of the Trend Graph design.



Orientation refers to the direction the trend will be displayed. The number of samples determines how many data points will appear on the screen. The sample rate determines how often a new sample is taken. Background color is the color behind the trend display.

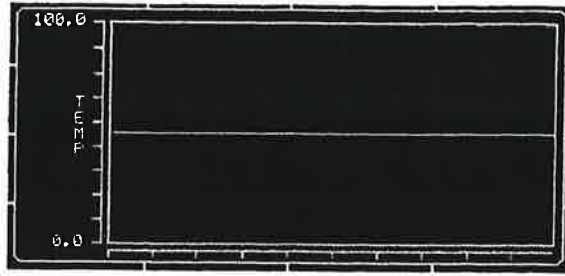
There have been some problems reported when using large trend displays on a 10.5" color and 9" Mono displays. In some cases, a trend display 8 cells wide by 12 cells high, with a sample rate of 1 second, would appear to lockup a panel. When the trend display was reduced to 8 cells wide by 8 cells high, the panel updated normally. If you experience this problem, reduce the sample rate from 1 second to 2 seconds or more, or reduce the size of the trend display.

A sample trend operator is shown below.

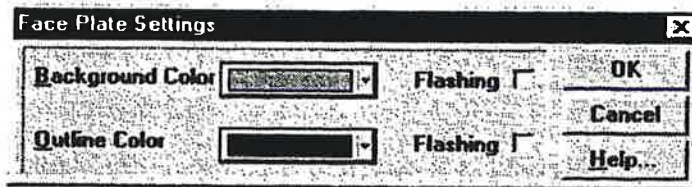


Face Plate

The face plate is the area around the trend display. You can select the faceplate color and the outline color. A sample is shown below.

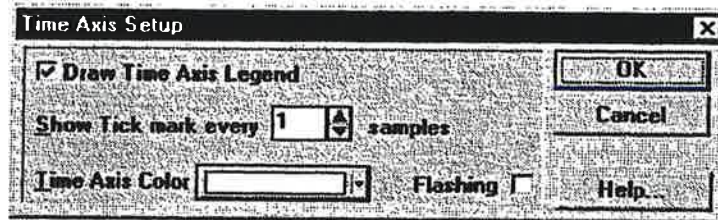


To select the faceplate colors, click the **Face plate** button. Select the desired colors and click **OK**.

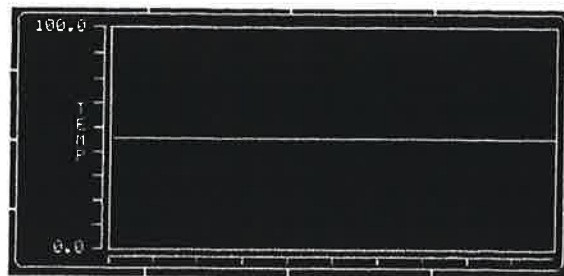


Time Axis

The time axis displays the trend samples as a function of time. If the display is Left-to-right, the time axis will be on the bottom of the display. You can display tick marks to show time marks. For example, you can display a tick mark every 20 samples so the operator can clearly see that 20 samples have been taken. Select the time axis color and click **OK**.



The following example illustrates a display with a time axis. There are 250 samples and the time axis tick marks are set to 25 samples.



Scale Settings

In a Left-to-right display, the scale will be located on the left side of the trend display. The scale settings dialog allows selecting different attributes to customize the scale to suit your application.

The screenshot shows the 'Scale Settings' dialog box. It has a title bar with 'Scale Settings' and a close button 'X'. The dialog is divided into several sections: 'Text' with a text entry field containing 'TEMP' and a 'Text Size' section with radio buttons for 5x7, 7x9, 11x16, and 16x32; 'Scale Range' with 'Min' (0.0) and 'Max' (21.2) input fields; 'Number Size' with radio buttons for 5x7, 7x9, 11x16, and 16x32; 'Digits' (4), 'Dec. Pos.' (1), and 'Ticks' (5) spinners; 'Scale Color' with a color selection box; and a 'Flashing' checkbox. There are 'OK', 'Cancel', and 'Help...' buttons.

Enter the Text and select the Text Size to appear on the trend. Text is vertical for left-to-right and right-to-left trends, and horizontal for top-to-bottom and bottom-to-top graphs. Blank spaces are ignored.

Enter the Scale Range, enter Min (minimum) and Max (maximum) values. The Min and Max values are for the display only and this setting does not automatically scale the input variable. Use the Pens button to setup the input and scale ranges. Number Size refers to the numbers on the scale. Select the number of Digits and Decimal Positions. A decimal position is the number of digits to the right of the decimal point. The decimal point counts as a digit.

Tick marks are placed next to the trend to delineate the graph into equal segments. Select the number of tick marks for the display.

Select the Scale Color and click OK to complete the trend.

Pens

Pens are the plots of the data set samples. The plots produce a trace in the display. Each pen is tied to a single variable so the pen shows the data set for the variable.

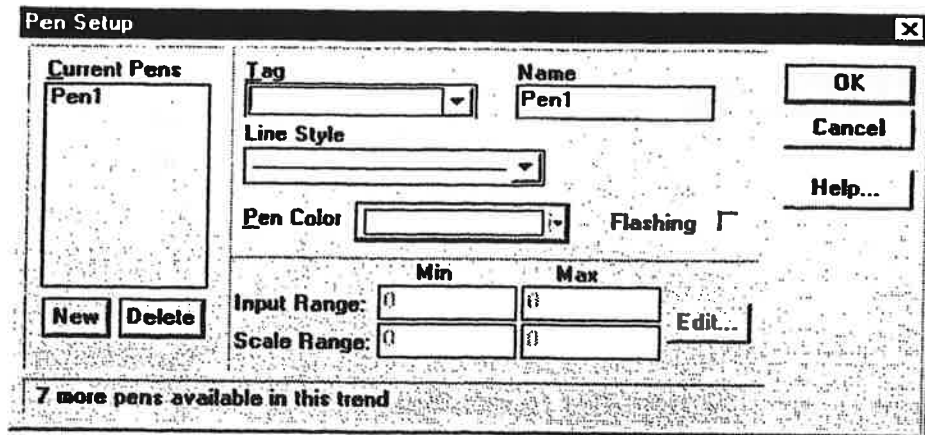
NOTE: Any variable assigned to a Trend **MUST** be a 16 bit integer type variable.

Each pen has a default name that can be changed in the Name data entry box. Enter the tag name and the values for the Input Range and the Scale Range will appear. You can have up to eight pens for each trend display, up to a maximum of 20 pens for an entire project. The number of pens available for the current trend and the number of total pens used is displayed in a status box at the bottom of the dialog box.

To add a new pen, click New and the next available default pen name appears. Remember that the name can be changed.

Select the line style and pen color, then click OK.

Caution: You can edit the values for the ranges by clicking the Edit button. These values represent the Min and Max values for the tag variable assigned to the pen. Once you edit these values, they are changed for any other panel object that may use the same tag variable. However, if you change the tag attributes through the Tag editor, you will not change the settings in the Pen Setup.



OK

Click the OK button to apply the information in the settings dialog box and close it.

Cancel

Cancel all changes to the Trend Settings dialog box and exit the dialog box.

Make Default

If you decide that you want to have all Trend Graphs to appear the same way, you can click the Make Default button in the Trend Graph Settings dialog box. The current settings in the Trend Graph Settings dialog box will be saved. The next time you create a Trend Graph, the saved settings will automatically be applied.

Help

Click the Help button to gain access to help files relating to Trend Graph Settings.

There have been some problems reported when using large trend displays on a 10.5" color and 9" Mono displays. In some cases, a trend display 8 cells wide by 12 cells high, with a sample rate of 1 second, would appear to lockup a panel. When the trend display was reduced to 8 cells wide by 8 cells high, the panel updated normally. If you experience this problem, reduce the sample rate from 1 second to 2 seconds or more, or reduce the size of the trend display.

Alarm Window

Creating an Alarm Window

The alarm window is used to display alarm messages, which consist of the alarm text message and can include time and date stamps. The alarm window can display Active alarms, Historic alarms or Logged alarms. A typical alarm message is shown below.

DATE	TIME	MESSAGE	ACK	CLEAR
09/18	22:48	ALARM MESSAGE TEXT	22:50	22:52

An Alarm Window consists of a legend and multiple lines of alarm text. Touching the alarm window operator causes the alarm manager page to appear. Please refer to the Alarms Guided Tour on page 61 and Alarms on page 49 for more information.



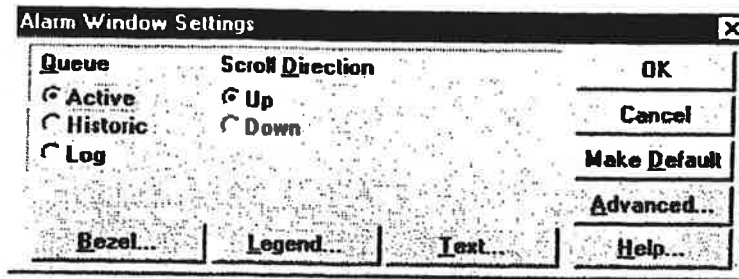
Click the Alarm Window icon on the Tools menu.



Move the cross hair to the top of the two cells where you want the Alarm Window to appear and click the mouse. If you want to size the Alarm Window immediately, move the cross hair to the desired cell, click and hold the mouse button and drag the mouse to size the Alarm Window. Release the mouse button and the Alarm Window is sized. An Alarm Window similar to the one below will appear.



The Alarm Window Settings dialog box will appear next to the alarm window.



Queue

Select Active, Historic, or Logged.

Active Alarms

The alarm is displayed when the trigger event becomes active. The alarm is displayed in the format and color specified in a configuration table. When the alarm is acknowledged, the alarm processor modifies the alarm message with the format and color specified in the configuration table. When the alarm is cleared the message is erased. A common practice is to display the alarm message in red. When the alarm is acknowledged, the alarm color is changed to yellow. For monochrome units, the active alarm is commonly displayed as black text and white background.

Historic Alarms

This type of alarm operates in the same fashion as the active alarm with an important exception. Instead of erasing the alarm message when the trigger event is cleared, the alarm message is modified with the format and the color specified in the configuration table. A common practice is to change the alarm message to green.

Logged Alarms

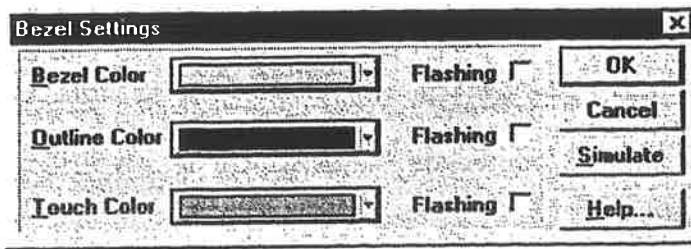
This type of alarm simply copies each alarm event message to a queue using the format and color specified for the alarm. The alarm processor makes no attempt to find and update the previous events for the alarm.

Scroll Direction

The Alarm Window will display messages from the Active, Historic or Logged queues. As new messages are triggered, they will scroll into the alarm window either from the top or the bottom. Setting the scroll direction to *scroll up* will show the latest alarm message on the bottom of the window.

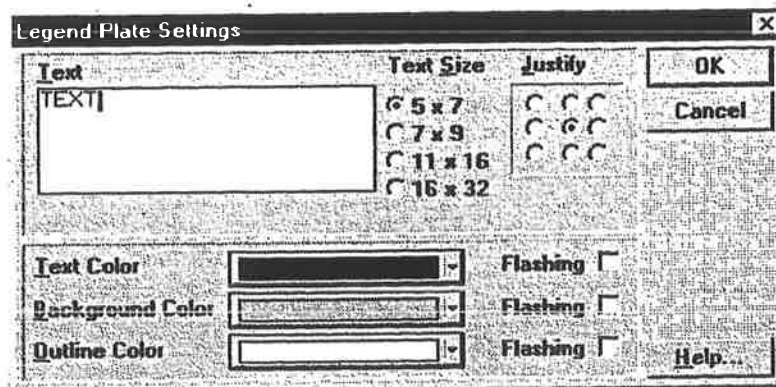
Bezel

You can select the outline and bezel colors for the Alarm Window by clicking the Bezel button. The touch color appears when the operator touches the panel over the Alarm Window. (The alarm processor is so fast, the system screen appears before you get a chance to see the touch color.) Click OK to accept the color selections. If you load a color project into a monochrome unit, Red, Green and Blue will be converted to Black, and Yellow, Magenta, and Cyan will be converted to white.



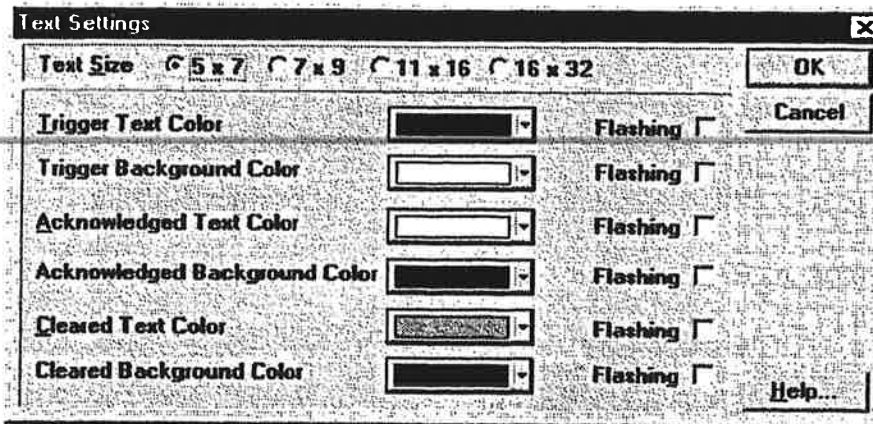
Legend

You can change the title of the Alarm Window by clicking the legend button and entering the new title. You can change the text color, background color and size of the title text. You can justify the text by clicking one of the Justify radio buttons. If you load a color project into a monochrome unit, Red, Green and Blue will be converted to Black, and Yellow, Magenta, and Cyan will be converted to white.



Text

You can select the color and text size of the alarm message as it will appear in the alarm window. A common practice is to display the active alarm in red, the acknowledged alarm in yellow, and the cleared alarm in green. Remember that the active alarm queue will not contain any cleared alarms. Click the text button to display the Text Settings dialog box. If you load a color project into a monochrome unit, Red, Green and Blue will be converted to Black, and Yellow, Magenta, and Cyan will be converted to white.



OK

Click the OK button to apply the information in the settings dialog box and close it.

Cancel

Cancel all changes to the Alarm Window Settings dialog box and exit the dialog box.

Make Default

If you decide that you want to have all Alarm Windows to appear the same way, you can click the Make Default button in the Alarm Window Settings dialog box. The current settings in the Alarm Window Settings dialog box will be saved. The next time you create a Alarm Window, the saved settings will automatically be applied.

Advanced Button

Clicking the Advanced button will display the Advanced Settings dialog box. The Alarm Button operation can be assigned to an external keypad. See Keypads, page 194, and Keypad Assignment, page 91, for additional information. Once a keypad is assigned, you can disable the touch screen by checking the *Touch disable* box. If you leave the touch disable box unchecked, then the touch screen and the keypad can both operate the button.

Help

Click the Help button to gain access to help files relating to Alarm Window Settings.

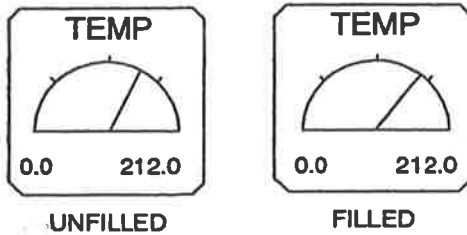
Using the Alarm Window

NOTE: You can force the operator to view the Alarm window by placing the Alarm window on a panel that is controlled by the Panel Trigger Tag. See the Display Device Setup section in the *QUICK MANAGER* chapter. By using this option, the PLC can force the Alarm panel when an alarm is triggered.

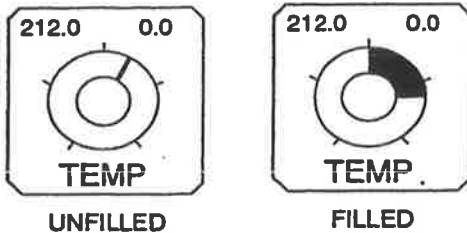
Analog Meter

Analog Meter

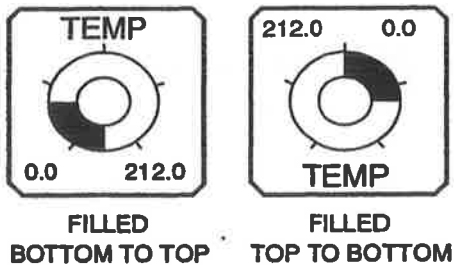
The new Meter tool allows creation of two analog meters. Since the meters share several common dialog boxes, they are combined into one tool. The default shape for a meter is the 180 degree meter shown below. You can click the filled checkbox to fill the area from the min value to the current value.




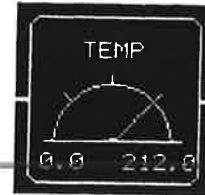
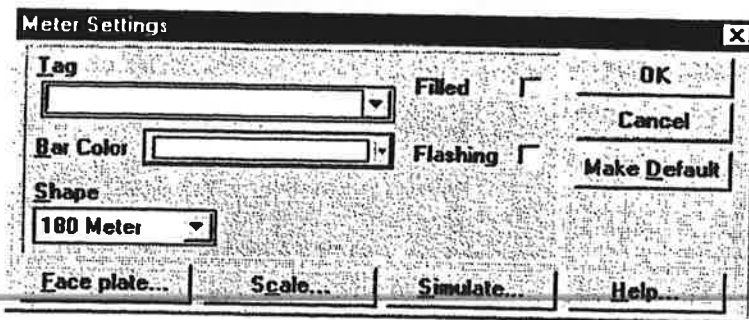
The 360 degree meter is shown below. You can click the filled checkbox to fill the area from the min value to the current value.



When you select the 360 meter, the Orientation list box appears. The 360 degree meter can be selected to have the starting point (min setting) at the top of the meter or the bottom. The bar on the meter face moves clockwise from the min value to the max value.



To add a Meter to a panel, click the Meter icon  in the floating Tools menu. Move the mouse cursor to the panel and observe that the cursor is a cross hair with a meter symbol. Move the cross hair to the cells where you want the meter to appear and click the mouse. The meter face appears on the panel and the Meter Settings dialog appears.



Tag Variable

A "tag" variable name must be assigned to the numeric meter operator. This tag will be a word in the PLC memory that the target display can read.

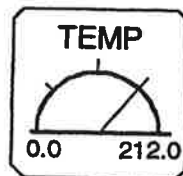
NOTE: Any variable assigned to a Meter MUST be a 16 bit integer type variable.

Bar Color

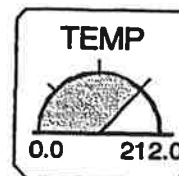
The movable portion of the meter is the bar color, similar to a bar graph. Click the Flashing checkbox for flashing colors.

Filled

The movable portion of the meter is set to be a single line, similar to the needle on a pressure guage. Clicking the Filled checkbox will fill the area from the minimum value to the current value. The fill color is same as the bar color.



UNFILLED



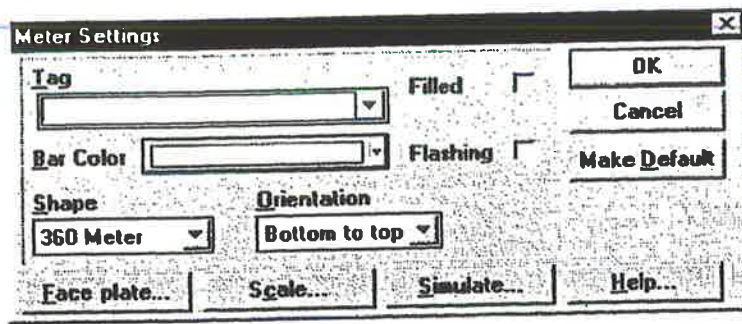
FILLED

Shape

Select either the 180 or the 360 meter. If you select the 360 meter, the Orientation list box appears.

Orientation

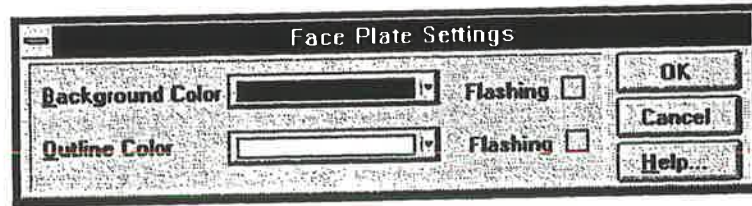
Selecting the 360 meter causes the Orientation dialog to appear.



The 360 degree meter can be selected to have the starting point (min setting) at the top of the meter or the bottom. The bar on the meter face moves clockwise from the min value to the max value. Use Simulate to see the action.

Face Plate

This dialog is used to select a background color and outline color for the meter face plate. The outline color is the outline around the meter face and the outline around the face plate.



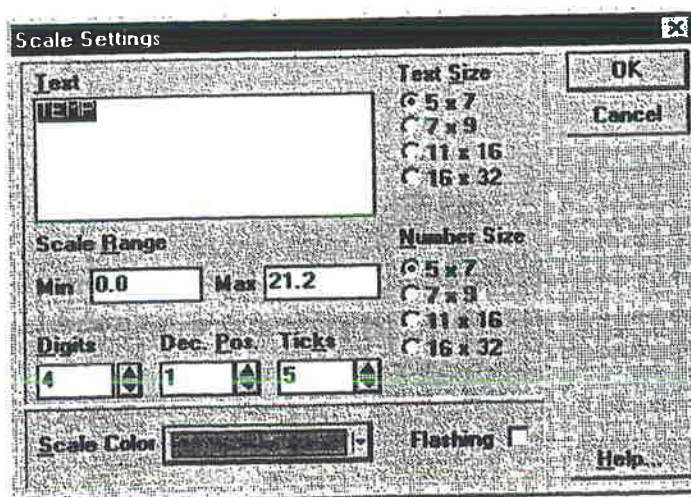
Scale

The Scale Settings menu is used to customize the meter. Enter the Text and select the Text Size to appear on the meter legend. You can have only ONE row of scale text.

Enter the Scale Range, Min (minimum) and Max (maximum) values. Number Size refers to the numbers on the scale. Select the number of Digits and Decimal Positions. A decimal position is the number of digits to the right of the decimal point. The decimal point counts as a digit.

Tick marks are placed around the meter face to delineate the meter into equal segments. Select the number of tick marks for the meter.

Select the Scale Color and click OK to complete the meter.



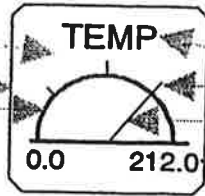
Simulate

Simulate allows viewing the meter as the data value is changed between the minimum and maximum values with the scroll bar.

Colors

BACKGROUND COLOR

OUTLINE



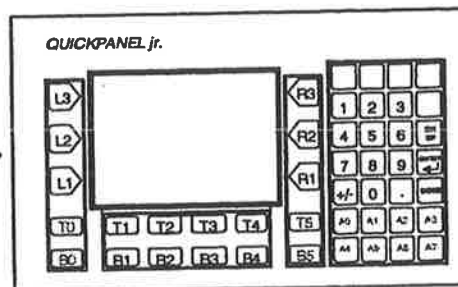
SCALE COLOR

BAR COLOR

Keypads

Keypads Overview

The keypad option adds external keypads that surround the touch screen. The keypads are used in place of the touch screen or along with the touch screen. For example, instead of touching the QuickPanel screen to activate a Push Button, you can press an external keypad. You can also assign an external keypad to simulate a push button, selector switch, goto panel button, numeric data entry, print button or word button. Simulating operators saves screen space.



Keypad installation information can be found in the Hardware Reference manual, part number 800-1000-082. The Keypad option must be installed in order to use the keypad assignments.

The following panel operators (ones with a bezel) can be assigned to external keypads:

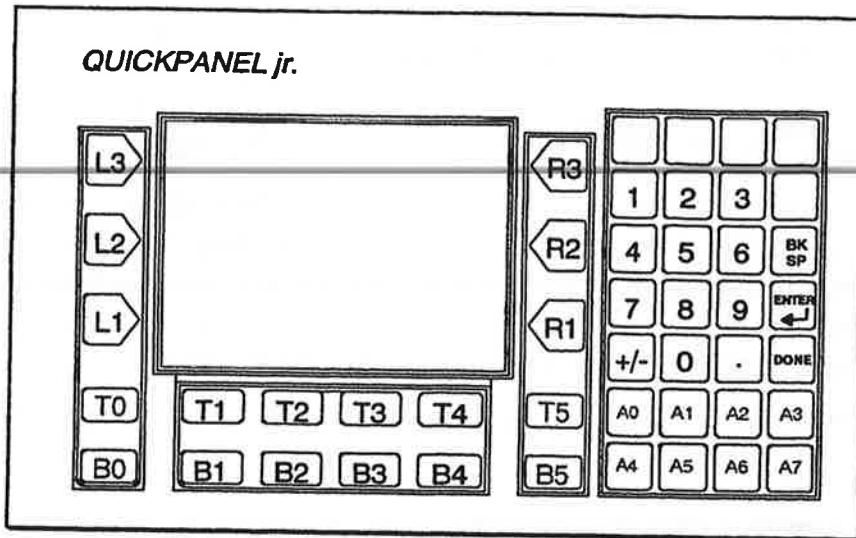
- Push Button
- Illuminated Push Button
- Numeric Data Entry (with external numeric keypad)
- Selector Switch
- Word Button
- Goto Panel Button
- Print Button
- Alarms

The addition of external keypads to the standard touch screen allows several options. For example, a Push Button can:

- work normally without using an external keypad.
- be assigned to an external keypad.
- work normally and with an external keypad.
- be simulated by a keypad but not appear on the touch screen.

Keypad Layout

The diagram below shows the physical layout of the keypads. The keypad designations are PERMANENTLY assigned, but the physical legends can be changed to suit your application. That is, L3 will always be in the same location, but the legend for L3 can be changed. Some of the keypad designations do not appear on the keypads. They are included in the drawing for reference. The unmarked keypads are T0, B0, T5, B5, and A0 through A7.



Keypad Names

The keypads are divided into Reserved keys and Programmable keys.

The first series of keypads are the ones on the LEFT and RIGHT sides of the display. The keypads are designated L1 for LEFT 1, R2 for RIGHT 2, and so on.

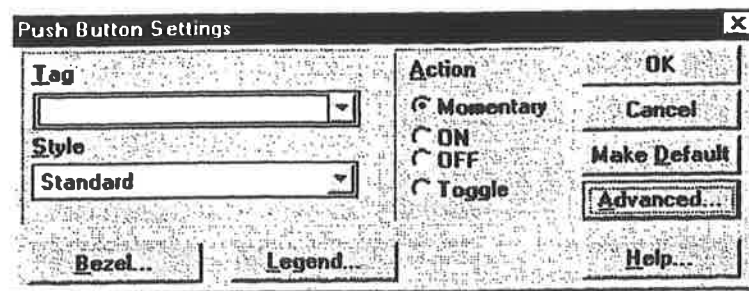
The next series of keypads are two rows of keypads below the display. The top row of keypads are designated T0 for TOP 0, T1 for TOP 1, B0 for BOTTOM 0 and so on.

The final group of programmable keypads are located below the numeric keypads and are designated A0 through A7.

The numeric keypads, including the blank keys above the numeric keypads cannot be assigned and are designated as Reserved.

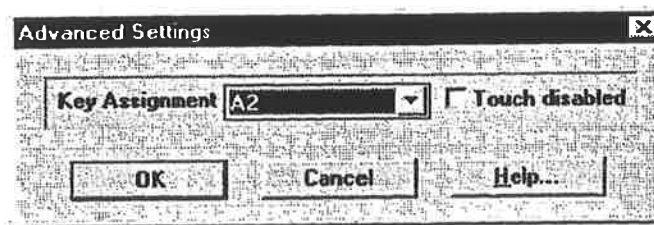
Assigning Keypads

You can assign a keypad to a button by clicking the Advanced button in the settings dialog. Shown below is the Advanced button in the Push Button Settings dialog.



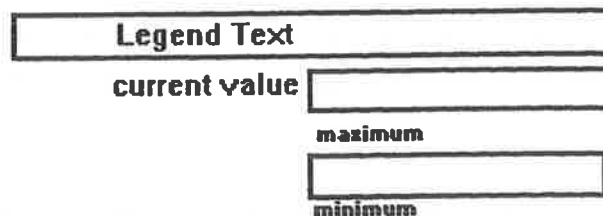
Clicking the Advanced button displays the Advanced Settings dialog box. In the following example, the Push Button was assigned to keypad A2. Once a button is given a Key Assignment, the *Touch disabled* checkbox becomes active. A button object can be connected to the touch screen and the keypad simultaneously. If you check the *Touch disabled* checkbox, the touch screen will be disabled for the button and the button will only work with the assigned external keypad.

A list of all keypad assignments can be displayed by going to the Tools menu and selecting Keypad Assignments.



Keypads and Numeric Data Entry

When a keypad is assigned to a Numeric Data Entry button, the data entry keypad on the touch screen and the external numeric keypad operate the same. If you disable the touch screen, the data entry keypad no longer appears on the touch screen. Only the legend text, data entry fields and the min/max fields appear as illustrated below. You must use the external numeric keypad to enter data.



If you disable the touch screen for the Numeric Data Entry operator, you cannot activate the Numeric Data Entry button by touching the screen. The only way to activate the button is by pressing the assigned keypad. The shortened version of the data entry screen is displayed. The external numeric keypads are used to enter data.

Keypads and Alarms

When an alarm is triggered, the alarm message appears on the panel in an alarm window. The operator touches the MOD button to activate the alarm management page shown below. If you assign a keypad to an Alarm window, the alarm management page will have an additional row showing keypad assignments.

The alarm management page function keys (Up, Down, Ack, etc.) will now have permanent keypad assignments. Up is A0, Del is A3 and so on. The touch screen and the keypads work in parallel. If the touch screen is disabled, only the keypads will operate the alarm page functions.

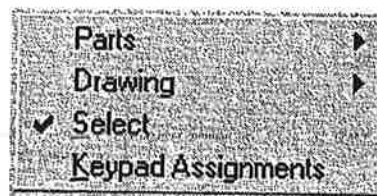
ACTIVE ALARMS							
09/19 13:28 ALARM TEXT MESSAGE #1							
09/19 13:40 ALARM TEXT MESSAGE #2							
Up	Down	Ack	Del	Ack All	Del All	MODE	DONE
A0	A1	A2	A3	A4	A5	A6	A7

Simulating Panel Objects with Keypads

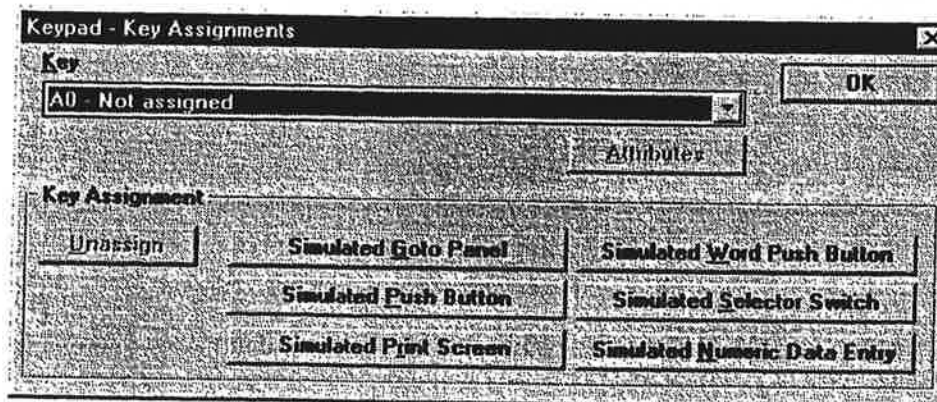
You can assign a keypad to simulate a panel object, even though there is no panel object visible on the screen. You can assign one of the keypads to simulate the following panel operators:

- Push Button
- Goto Panel Button
- Print Button
- Word Button
- Selector Switch
- Numeric Data Entry

To create a simulated panel object, go to the TOOLS menu and select Keypad Assignments.

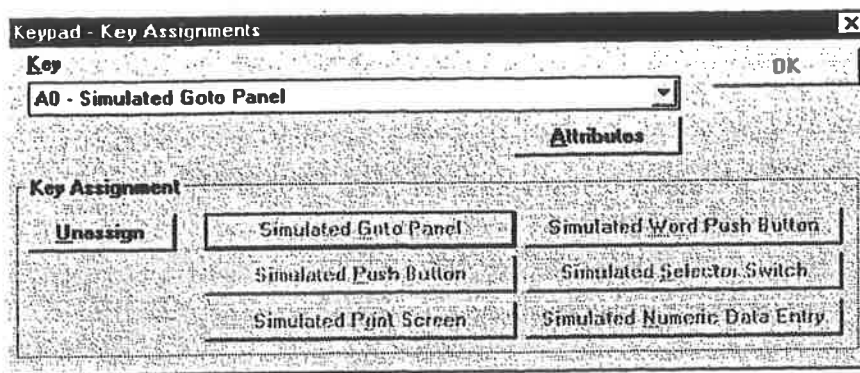


The keypad key assignment dialog box appears.



The first operation is to select which keypad will be assigned to the simulated panel operator. Click the down arrow in the Key list box then click an unassigned keypad.

Next, select one of the operators to simulate by clicking a button in the Key Assignment area. When you click one of the simulate keys, the rest of the buttons will be grayed out.



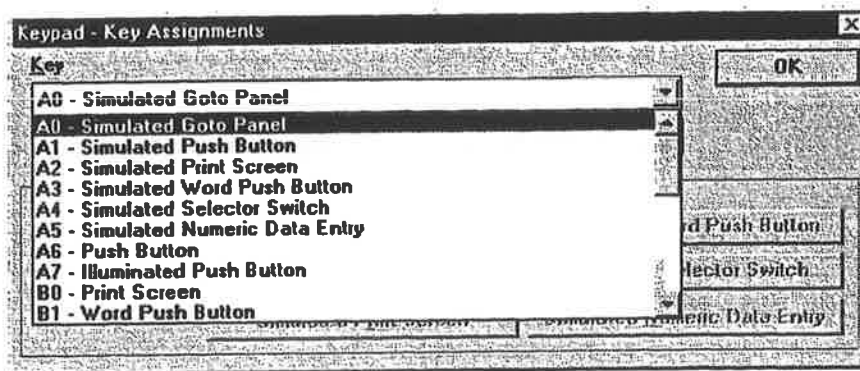
Click the Attributes button to open the settings dialog for the selected item. In this example, clicking the Attributes button will open the Goto Panel settings dialog. Enter the Panel Name and click the OK button.

Now when you press the A0 keypad, the panel name you selected will be displayed. This is the same operation as the Goto Panel Button, but without the panel operator taking up screen space.

Keypad Assignments

You can view all the keypad assignments by going to the Tools menu, selecting Keypad assignments, then selecting the Key list box. You can change the attributes of any simulated operator by selecting the keypad from the list, then clicking to Attributes button.

Note that simulated operators are marked as *Simulated*.



Viewing Keypad Assignments

To view the keypad assignments, go to the View menu and click the Object Key Display. The keypad tag display is similar to the object tag display.



The keypad tag is displayed in the bottom left corner of the operator and provides a quick visual check to see which panel operators have keypads assigned.

Appendix A

Compiler INI Settings

The QUICKPANEL Compiler, SSC, provides a number of generation options. These options allow the user to change the run-time appearance of some of the Quick objects as they are generated. Some of these options also control the execution of the compiler. To change or use these options, the user must create an INI file that specifies the settings for each option. The file must have the name SSC.INI and it must be located in the directory where the Quick applications are installed.

Format of the SSC.INI File

The SSC.INI file contains several sections, each of which consists of a group of related settings. The sections and settings are listed in the SSC.INI file in the following format:

[section name]

keyname=value

In this example, **[section name]** is the name of a section. The enclosing brackets ([]) are required, and the left bracket must be in the leftmost column on the screen.

The **keyname=value** statement defines the value of each setting. A **keyname** is the name of a setting. It can consist of any combination of letters and digits in uppercase or lowercase, and it must be followed immediately by an equal sign (=). The value can be an integer, a string, or a quoted string, depending on the setting.

You can include comments in initialization files. You must begin each line of a comment with a semicolon (;).

How to Read the Listings in This Document

In this document, SSC.INI file settings are listed alphabetically within each section. However, the settings do not appear alphabetically in the SSC.INI file. To change a setting, you need to search for it within the appropriate section of the SSC.INI file.

This document lists the syntax, default value, purpose, and recommended method for changing each setting, using the following format.

SettingName=<value-type>

Default: The default value for this setting.

Purpose: The function of the setting and its default value (if applicable).

To change: The recommended method for changing the value of this setting.

<value-type> indicates whether the value should be an integer, a letter, a range of numbers, or something else.

Changing Settings

When the Setup program creates the SSC.INI file, it assigns default values to the settings. Some settings that are listed in this document may not appear in your SSC.INI file.

You can use a text editor, such as Notepad, to edit the SSC.INI file directly. (Do not use a formatting editor, such as Write; it can corrupt your SSC.INI file.) You must use this method to change the settings that you cannot change by using Control Panel. After you have edited the SSC.INI file, you must restart Quick for the settings to take effect. For more information about Notepad, see Help for Notepad.

Caution: Always back up your SSC.INI file before you make changes, so that you can restore the original file in case you accidentally damage the SSC.INI file or make changes that cause problems when the compiler is executing. Be careful when using a text editor to edit the SSC.INI file. Incorrect changes to the SSC.INI file can cause unexpected results when you run the compiler.

[ssc-option] Section Settings

The [ssc-option] section contains settings that affect general operation of the compiler, such as sound and error file formats. The [ssc-option] section can contain the following settings:

Sound=<0-or-1> **Default: 0**

Purpose: Specifies whether or the compiler will use sound to flag specific events during the compilation cycle. Note that you must have sound support enabled in Windows for this feature to work. The following entries must be specified in the [sounds] section of WIN.INI:

SSCPrimoFinis=<filename>	Smart Screen Compiler Completion (used when the compiler finishes correctly)
SSCError=<filename>	Smart Screen Compiler Error (used when the compiler finds an error)
SSCSnafuFinis=<filename>	Smart Screen Compiler Failure (used when the compiler finishes with errors)
SSCBegin=<filename>	Smart Screen Compiler Start (used when the compiler starts) where filename is the complete path and file specification for the WAV file to be played for the specific event.

Use Notepad to edit the SSC.INI file.

TDFFormat=<format string> Default: %y-%m-%d %H:%M %Z

Purpose: This entry allows the user to control the format of the time and date string used in the error and log files. A percent symbol specifies the start of a code for displaying a specific value. All other character used in the format string are written as is to the time and date string.

Format Description

%a	Abbreviated weekday name
A	Full weekday name
%b	Abbreviated month name
%B	Full month name
%c	Date and time representation appropriate for the locale
%d	Day of the month as a decimal number (01-31)
%H	Hour in 24-hour format (00-23)
%I	Hour in 12-hour format (01-12)
%j	Day of the year as a decimal number (001-366)
%m	Month as a decimal number (01-12)
%M	Minute as a decimal number (00-59)
%p	Current locale's AM/PM indicator for a 12-hour clock
%S	Second as a decimal number (00-59)
%w	Weekday as a decimal number (0-6; Sunday is 0)
%x	Date representation for current locale
%X	Time representation for current locale
%y	Year without the century as a decimal number (00-99)
%Y	Year with the century as a decimal number
%Z	Time zone name or abbreviation
%%	Percent sign

Use Notepad to edit the WIN.INI file.

[ssc-logger] Section Settings

The [ssc-logger] section contains settings that specify how the compiler will notify the user of errors. The [ssc-logger] section can contain the following settings:

SpawnDisplay=<0-or-1-or-2> Default: 0

Purpose: Specifies what to do with the error file when the compiler is finished. A zero means do nothing. A 1 will start up the application specified in DisplayTool to show the error file at the end of the compilation, if, and only if, there are errors in the compilation. A 2 will always start up the application specified in DisplayTool at the end of a compilation to show the error file.

Use Notepad to edit the WIN.INI file.

DisplayTool=<application name> Default: NOTEPAD.EXE

Purpose: This is the application that is used to display the error file at the end of a compilation. The compiler assumes a command line of the form:

“Application ErrorFile”

Use Notepad to edit the WIN.INI file.

Level=<0-or-1> Default: 0

Purpose: Specifies the level of logging. A zero specifies error logging. Only errors will be written to the error file. A one specifies full logging. In addition to errors, each tool encountered will be written to the error file.

Use Notepad to edit the WIN.INI file.

[ssc-generate] Section Settings

The [ssc-generate] section contains settings that affect how the compiler generates certain aspects of Quick objects. These changes are mostly cosmetic. However, a few settings can impact run-time performance. The [ssc-generate] section can contain the following settings:

LegendGeneration=<0-or-1> Default: 0

Purpose: When zero, legend plates are generated as chamfered rectangles. Although they can be distinguished easily, they tend to draw more slowly than normal rectangles, thus slowing panel changes. When this entry is set to one, legend plates are drawn as simple rectangles, improving the draw speed and the panel change times.

Use Notepad to edit the WIN.INI file.

NumericDataGeneration=<0-or-2-or-3> Default: 0

Purpose: This entry allows the user to change the appearance of the dynamic data portion of objects containing dynamic data. When zero, the number of digits in the dynamic data field is extended so that the field covers the entire width of the Quick object. When the value is two or three, the number of digits is held to the value specified by the user in the object's dialog. Since this value may be less than the actual width of the Quick object, two options exist for presentation. When the value is two, the dynamic data field is always centered within the Quick object. When the value is three, the dynamic data field is justified within the Quick object with the justification specified for the Quick object.

Use Notepad to edit the WIN.INI file.

TextDataGeneration=<0-or-2-or-3> Default: 0

Purpose: This entry allows the user to change the appearance of the dynamic text portion of objects containing dynamic text. When zero, the number of characters in the dynamic text field is extended so that the field covers the entire width of the Quick object. When the value is two or three, the number of characters is held to the value specified by the user in the object's dialog. Since this value may be less than the actual width of the Quick object, two options exist for presentation. When the value is two, the dynamic text field is always centered within the Quick object. When the value is three, the dynamic text field is justified within the Quick object with the justification specified for the Quick object.

Use Notepad to edit the WIN.INI file.

Sample SSC.INI File

A sample SSC.INI file is shown below.

[ssc-option]

Sound=1

TDFormat=%y-%m-%d %H:%M %Z

[ssc-logger]

DisplayTool=notepad

SpawnDisplay=1

Level=1

[ssc-generate]

LegendGeneration=1

NumericDataGeneration=2

TextDataGeneration=3

The sample INI file shown does the following:

- It turns on the sound so that the compiler provides audible indication of its current progress.
- The format of the time and date string in the error/log file has been set to produce strings that follow this example: "94-05-04 08:21 cdt".
- At the end of a compilation, the compiler will start the notepad to display the error/log file only if there are errors.
- The compiler will notify the user each time it encounters an error, halting compilation till the user acknowledges the error.
- Legend plates are generated as simple rectangles.
- Quick objects that contain numeric data fields more narrow than the object maintain the user specified size of the data fields. All such fields are centered horizontally in the Quick object.
- Quick objects that contain text data fields more narrow than the object maintain the user specified size of the data fields. All such fields are justified horizontally within the Quick object according to the justification specified for the text.

If you have questions about implementing an application to set the system time, one of our Product Support Services technicians will be glad to assist you. In the United States call (708) 345-5730x407 between 8:00 A.M. and 5:00 P.M. Central time.

Appendix B

Character Map

The QuickPanel has a built-in character set. Many of the special characters available in the character set cannot be entered directly from the keyboard. An easy way to enter the special characters is to open the Windows program Character Map. Select Terminal for the Font. Click a character and the associated Keystroke code is shown in the lower right corner of the dialog box.

Note: The characters shown in the Terminal character map MAY NOT be the same as those in the QuickPanel. In most cases, the characters are the same. The correct characters and codes are shown in the table below. Where no codes are shown, the character is a standard keyboard character.

To enter a special character, locate the character and the associated code in the table below. Find the character in the Terminal character map that has the same code and click it. Click the Select button then the Copy button. The character code is now on your clipboard.

Paste the character into a text field in Quick Designer. The character will NOT appear the same as the one in the table below, but it will appear correctly when the code is downloaded to the QuickPanel.

To create words, simply click a character then the Select button, and continue until all the characters are selected. Then click the Copy button to copy all codes to the clipboard.

The following table shows the character map for a QP2.

Char	Code	Char	Code	Char	Code	Char	Code
!	Keyboard	"	Keyboard	#	Keyboard	\$	Keyboard
%	Keyboard	&	Keyboard	'	Keyboard	(Keyboard
)	Keyboard	*	Keyboard	+	Keyboard	,	Keyboard
-	Keyboard	.	Keyboard	/	Keyboard	0	Keyboard
1	Keyboard	2	Keyboard	3	Keyboard	4	Keyboard
5	Keyboard	6	Keyboard	7	Keyboard	8	Keyboard
9	Keyboard	:	Keyboard	;	Keyboard	<	Keyboard
=	Keyboard	>	Keyboard	?	Keyboard	@	Keyboard
A	Keyboard	B	Keyboard	C	Keyboard	D	Keyboard
E	Keyboard	F	Keyboard	G	Keyboard	H	Keyboard
I	Keyboard	J	Keyboard	K	Keyboard	L	Keyboard
M	Keyboard	N	Keyboard	O	Keyboard	P	Keyboard
Q	Keyboard	R	Keyboard	S	Keyboard	T	Keyboard
U	Keyboard	V	Keyboard	W	Keyboard	X	Keyboard
Y	Keyboard	Z	Keyboard	[Keyboard	\	Keyboard
]	Keyboard	^	Keyboard		Keyboard	`	Keyboard
a	Keyboard	b	Keyboard	c	Keyboard	d	Keyboard
e	Keyboard	f	Keyboard	g	Keyboard	h	Keyboard
i	Keyboard	j	Keyboard	k	Keyboard	l	Keyboard

m	Keyboard	n	Keyboard	o	Keyboard	p	Keyboard
q	Keyboard	r	Keyboard	s	Keyboard	t	Keyboard
u	Keyboard	v	Keyboard	w	Keyboard	x	Keyboard
	Keyboard	z	Keyboard	{	Keyboard		Keyboard
	Keyboard	~	Keyboard	^_ (1)	Ctrl+	Ç	Ctrl+2
ü	Alt+0129	é	Alt+0130	â	Alt+0131	ä	Alt+0132
à	Alt+0133	á	Alt+0134	ç	Alt+0135	ê	Alt+0136
ë	Alt+0137	è	Alt+0138	ï	Alt+0139	î	Alt+0140
ì	Alt+0141	Ä	Alt+0142	À	Alt+0143	É	Alt+0144
æ	Alt+0145	Æ	Alt+0146	ô	Alt+0147	ö	Alt+0148
ò	Alt+0149	û	Alt+0150	ù	Alt+0151	ÿ	Alt+0152
ö	Alt+0153	Ü	Alt+0154	ø	Alt+0155	£	Alt+0156
∅	Alt+0157	x	Alt+0158	f	Alt+0159		
á	Alt+0160	í	Alt+0161	ó	Alt+0162	ú	Alt+0163
ñ	Alt+0164	Ñ	Alt+0165	g	Alt+0166	˙	Alt+0167
¿	Alt+0168	®	Alt+0169	¬	Alt+0170	½	Alt+0171
¼	Alt+0172	¡	Alt+0173	«	Alt+0174	»	Alt+0175
☼	Alt+0176	☼	Alt+0177	☼	Alt+0178		Alt+0179
†	Alt+0180	Á	Alt+0181	Â	Alt+0182	À	Alt+0183
©	Alt+0184	‡	Alt+0185		Alt+0186	¶	Alt+0187
¶	Alt+0188	ç	Alt+0189	¥	Alt+0190	¡	Alt+0191
⌞	Alt+0192	⌞	Alt+0193	⌞	Alt+0194	⌞	Alt+0195
—	Alt+0196	†	Alt+0197	ā	Alt+0198	À	Alt+0199
ℓ	Alt+0200	ƒ	Alt+0201	⌞	Alt+0202	⌞	Alt+0203
	Alt+0204	=	Alt+0205	‡	Alt+0206	¶	Alt+0207
(2)	Alt+0208	Ð	Alt+0209	È	Alt+0210	È	Alt+0211
È	Alt+0212	"	Alt+0213	Í	Alt+0214	Î	Alt+0215
Ï	Alt+0216	¡	Alt+0217	⌞	Alt+0218	■	Alt+0219
■	Alt+0220	¡	Alt+0221	Ï	Alt+0222	■	Alt+0223
Ó	Alt+0224	ß	Alt+0225	Ô	Alt+0226	Ò	Alt+0227
õ	Alt+0228	Õ	Alt+0229	µ	Alt+0230	ƒ	Alt+0231
þ	Alt+0232	ú	Alt+0233	û	Alt+0234	ù	Alt+0235
ÿ	Alt+0236	Ý	Alt+0237	-	Alt+0238	-	Alt+0239
-	Alt+0240	±	Alt+0241	=	Alt+0242	¾	Alt+0243
¶	Alt+0244	§	Alt+0245	÷	Alt+0246	-	Alt+0247
˙	Alt+0248	˙	Alt+0249	·	Alt+0250	˙	Alt+0251
³	Alt+0252	²	Alt+0253	■	Alt+0254		Alt+0255

Note 1. The character created with Ctrl+| is not available as a printable font. The two characters shown in the box can be combined to create a character similar to what is displayed on the QuickPanel.

Note 2. The character created with Alt+0208 is not available as a printable font. The character shown is similar to what is displayed on the QuickPanel.



Index

~
~System_Comm_Status 48
~System_Contrast 47, 48
~System_Day 48
~System_Hour 46, 176
~System_Minute 46, 176
~System_Month 48
~System_Second 46, 176
~System_Year 48

1

6 color bitmaps 115
180 degree meter 190
1st Line in File: 148

2

24 hour format 176

3

360 degree meter 190

A

About QUICKDESIGNER 97
Ack All button 67
Ack button 67
Action 13, 124, 129, 137
Active Alarm queue 67
Active Alarms 187
Active Window 36
Add 53, 137
Add Tag 41
Adjust Size 108
Advanced Alarm Settings 64
Advanced Bar Graph 180
Advanced Button 60, 130, 134, 139,
159, 163, 189

Alarm Configuration 63
alarm manager page 67, 186
Alarm Messages 55
Alarm Page Display 59
Alarm Queue Setup 58
Alarm Queues 64
Alarm Table 62
Alarm Window 67, 186
Alarm Window Settings 66
Alarms 35, 49
Alarms and Prompts 152
Alarms Configuration 50
Alarms Guided Tour 61
Alarms window 50
Align 88
Analog Meter 190
AND 137
Appearance 104
arrow cursor 76
Assigning Keypads 196
Assume Initial State 60
Auto move 96
Auto size 95
Auto...Button 41

B

Bar Color 191
bar graph 177
Basic Panel Operators 1
bezel 2, 126, 129, 133
touchbutton 126, 129, 133
Bit Alarms 53
Bit and Word Address Tags 50
bitmap 114
Bitmap Size 117, 118
Bitmap Statistics 115
Browser Properties 104, 108
Bulletin Board 72
button bar 75
Button Off 60
Buttons 36

C

Cautions 111
cells 1
Change 88
Change after object create 96
Change Object Tags 88
Changing Panels 32
Changing the Window View 80
Character Map 204

- Check 86
- Check panel on save 95
- circle 119
- Circular Pilot Light 142
- Circular Pilot Light States 142
- Circular Print Button 132
- Circular Push Button 125
- Circular Word Button 137
- Clock 46
- clock day 47
- clock display 175
- clock hours 47
- clock minutes 47
- clock month 47
- clock seconds 47
- Clock System Variables 47
- clock year 47
- Color Selection 83
- Communication Problems 72
- Communication Status 48
- Communications Port 71
- Compile to File 27
- Compiler 70
- Compiler INI Settings 199
- components menu 34
- Config Button 56
- Configuration 52
- contrast setting 47
- Contrast System Variable 48
- Copy 87
- Copy Message 56
- Copy Object 108
- Core components 2
- Create a Panel 11
- Creating a Bit Map 117
- Creating a clock display 175
- Creating a Data Display with Keypad Entry 167
- Creating a Goto Panel push button 160
- Creating a Legend Plate 121
- Creating a Local Image Display 154
- Creating a Local Message Display 144
- Creating a Numeric Data Display 164
- Creating a pilot light 140
- Creating a print button 131
- Creating a push button 123
- Creating a selector switch 156
- Creating a Text Display 172
- Creating a Trend Display 182
- Creating a Word Button 135

- Creating an Illuminated Push Button 128

- Creating States 153
- Creating the Alarm Window 66
- Cut 87
- Cut Message 56
- Cut Object 108

D

- Data Display with Keypad Entry 167
- data entry panel 171
- Data Entry Screen 171
- Data File 44
- Data Format Settings 165
- Date Format 57
- Date System Variables 48
- Decimal Positions 166
- Default Fields 147, 150
- Default Settings 82
- Define Password Button 26
- Define Values 149, 151
- Del 67
- Del All button 67
- Delete 55, 86, 89
- Delete Folder 106
- Delete Object 107, 108
- Delete Tag 42
- Delimiter 148
- Deselect All 87
- dialog box 2, 77, 121, 123, 128
 - illuminated push button 128
 - legend plate 121
 - push button 123
- Dim Flashing Colors 93
- Disable Beep 22
- Disable Beeper 22, 23
- display 1
- Display Button 22
- Display Device 20
- display device status 70
- DONE 67
- Down 67
- download 27, 69
- Download Cable 70
- Download from File 27
- Download Operation 69
- Download Panel 15
- Downloading Files 68
- Drag 'n Drop 104
- Draw tools 90
- Drawing Grid 82
- Drawing Snap System 82

E

- edit
 - change 88
 - copy 87
 - cut 87
 - delete 89
 - paste 87
 - redo 87
 - undo 87
- Edit Buttons 53
- Edit Menu 53, 87
- Editing Features 83
- Editing Nodes 110
- Editing the Operator 78
- Elements 44
- ENTER button 171
- Error Message 37
- Event Log 72
- Exit 32
- export 28, 52, 86, 149
- export a bitmap 116
- Export File Layout Setting 150

F

- File Close Plate 178, 192
- file
 - close 85
 - exit 86
 - export 86
 - import 86
 - new 84
 - save 85
- File Close 52
- File Delete 52
- File in Use 37
- File menu 51, 84
- File Menu Buttons 51
- File Open 51
- File Save 52
- File Save As 52
- Fill Color 111
- Filled 191
- Filled/Unfilled 111
- Flashing Colors 93
- Float 44
- Floating Point 44
- Folder 105
- Folder Properties 106
- Free Form Addressing 56

G

- Getting Started 96
- Goto Panel 160
- Goto Panel Buttons, Using 161
- Grid Settings 95
- Grid Settings Dialog Box 82
- Group Objects 89
- Grouping objects 79

H

- Help 37
- Historic Alarms 187
- HMI-CAB-C49 70
- HMI-KPN-201 23
- Horizontal Justify 115

I

- illuminated push button 1, 128
- import 28, 52, 86, 146
- import a bitmap 116
- import bitmap 116
- Import File Layout Settings 146
- Importing and Exporting Panels 86
- Initial Screen 21, 22
- input range 168
- intermediate 95
- Internal Tags 46

J

- Justification 165
- Justify 155

K

- Key Assignment, Push Button 127
- Keyboard Attached 23
- Keypad Assignments 91, 198
- Keypad Layout 195
- Keypad Names 195
- Keypad Tag Display 79, 93
- Keypad Title Off 168
- Keypads 194
- Keypads and Alarms 197
- Keypads and Numeric Data Entry 196
- Keypads Overview 194

L

- Learning QUICKDESIGNER 97
- legend plate 3, 130–39, 126, 133, 130–39
 - core component 3
 - push button 126, 133
- Lens 3
- Library 155
- Library Browser 94
- Library database 102
- Library Tour 98
- Library Window 101
- Line Color 111
- line segments 109
- Line Style 111
- Local Image Display 153
- Local Message Display 144
- Logged Alarms 187

M

- Master Help 97
- Maximum Alarms in a Project 55
- menu bar 17, 74
- menu buttons 18
- Message Format 56, 63
- Meter Colors 193
- Military time 176
- Mode 138
- Model 21
- Modify Tag Attributes 88
- Momentary 123
- monochrome 115
- More Button 21
- Moving a Circle 119
- Moving a Polyline Object 110
- Moving a Rectangle 120
- Moving Text 113

N

- New 84, 102
- New - Word or Bit 51
- New at startup 95
- New factory units 70
- New Folder 105
- New Project 7, 19
- New Project Name 19
- node 109
- Notification Tags 60
- number of Digits 165
- Number of Positions 157

- Numeric Data Display 164
- Numeric Data Entry 167
- numeric readout 3

O

- Object de-select after use 96
- Object Properties 107
- Object Tag Display 93
- Object to fore after move 96
- Open 85, 102
- operator
 - copy 79
 - delete 79
 - edit 79
 - paste 79
- operators 1
- options menu 36, 93
- OR 137
- Orientation 178, 192
- Overlap Check 95

P

- Paintbrush 116
- Panel ID 85
- Panel Name 161
- panel operator 1
- Panel Password 94
- Panel Preview 80
- Panel Setting 94
- Panel settings on New: 96
- panel trigger 25
- Panels 10, 34
- Part Objects 80
- Parts 90
- Paste 87
- Paste Message 56
- Pens 184
- Period 44
- pilot light 1, 12, 140
- pixels 1
- PLC Tags 46
- PLC Type 23
- PLC Value 154
- polygons 109
- polyline 109
- Polyline Settings 111
- Port Button 24
- Port Selector 23
- Position Selector 157
- Position Tag Variable 157
- Preference Options 95

- Preferences 36, 95
- Preview 92
- Print 28
- Print Button 23, 131
- Print Button Settings 131
- Print Setup 32
- Printer Port 57
- Printing Alarm Messages 57
- Program Manager 5
- Project Delete 26
- project file 18
- Project in Use 37
- project menu 19
- Project Name 20
- Project Options 36
- Project Setup 7, 20
- Prompt 88
- Protocol Button 24
- Purge 42
- push button 1, 123

Q

- Queue 187
- Queue Button 58
- Quick Courier 71
- QUICK Help 37
- Quick Manager 17-18
- Quick Tour 6
- QUICKDESIGNER 10
- QUICKDESIGNER Window 74

R

- Readout 3
- rectangle 120
- Redo 87
- Restore Default 149, 151
- Right Mouse Button 75, 107, 108

S

- Sample Output in File: 151
- Sample Text File 146
- Samples 44
- Save As 85
- Save to Default 149, 151
- Scale 44, 192
 - Color 179, 184
 - Range 179, 184
- Scale Settings 179
- screen saver timeout 22
- Scroll Direction 187

- Select All 87
- Selected Fields 150
- Selecting Advanced Settings 64
- selector switch 1, 156
- Set 137
 - setting the hours 176
- Setting the target display time 176
- Settings Menu 94
- Shape 191
- Signed Number 165
- Simple Print Button 132
- Simple Push Button 125
- Simple Word Button 136
- Simulat 179
- Simulating Panel Objects with Keypads 197
- Size 44
- Sizing a Circle 119
- Sizing a Polyline Object 111
- Sizing a Rectangle 120
- Sizing an Object 77
- Sizing handles 78
- Standard Pilot Light 141
- Standard Pilot Light States 142
- Standard Print Button 132
- Standard Push Button 124
- Standard Word Button 136
- States 130, 145, 155, 158
- status bar 18, 36, 75
- Store Library Object 87
- Store Project in QuickPanel 27
- Stretch fit 115
- String 44
- Style 124, 132, 136
- Subtract 137
- System Button 25
- System Tags 46
- System Variables 47

T

- Tag Attributes 43
- Tag Attributes-Ranges 44
- Tag Attributes-Type 44
- Tag Buttons 41
- Tag Display 79
- Tag Export 45
- Tag Import 45
- Tag Validation 45
- Tag Variable 145, 154
- Tags 14, 35, 40
- Target Display Condition 70
- Text Colors 105

Text Display 172
text format 174
Text Justify, 83
Text Size 83
text tool 113
Tick marks 179, 184
Tiling and Drawing Grids 80
Tiling Grid for Objects 81
Tiling Snap System 81
Time Display Settings 175
Time Format 57
to Background 89
to Foreground 89
Toggle 123
tool bar 18
tool box 1, 76
Tool de-select 95
toolbar 36, 103
Tools 11, 45
Tools Menu 90
Touch Button 22
Touch Grid 80
Transfer 105
Transfer Object 106, 108
Trend 182
Trend, Face Plate 183
Trend, Pens 184
Trend, Scale Settings 184
Trend, Time-Axis 183
Trigger Tag 168
Trouble Shooting Guide 73

U

Undo 87
Ungroup Objects 89
Up 67
Update Display Device Executable
71
upgrading 70
Upload 27
Using the Alarm Window 189

V

Value 138
Vertical Justify 115
View 103
View Menu 92
Viewing Keypad Assignments 198

W

warning message 37
watchdog tag 22, 25
window menu 36
Word Alarms 54
word button 135

X

XOR 137

Z

Zoom In 92
Zoom Out 1:1 92
Zoom to ... 92



**The 10 minute panel builder
for Microsoft Windows™**

Total Control Products, Inc.

2001 N. Janice Ave.

Melrose Park, IL 60160

Phone (708) 345-5500

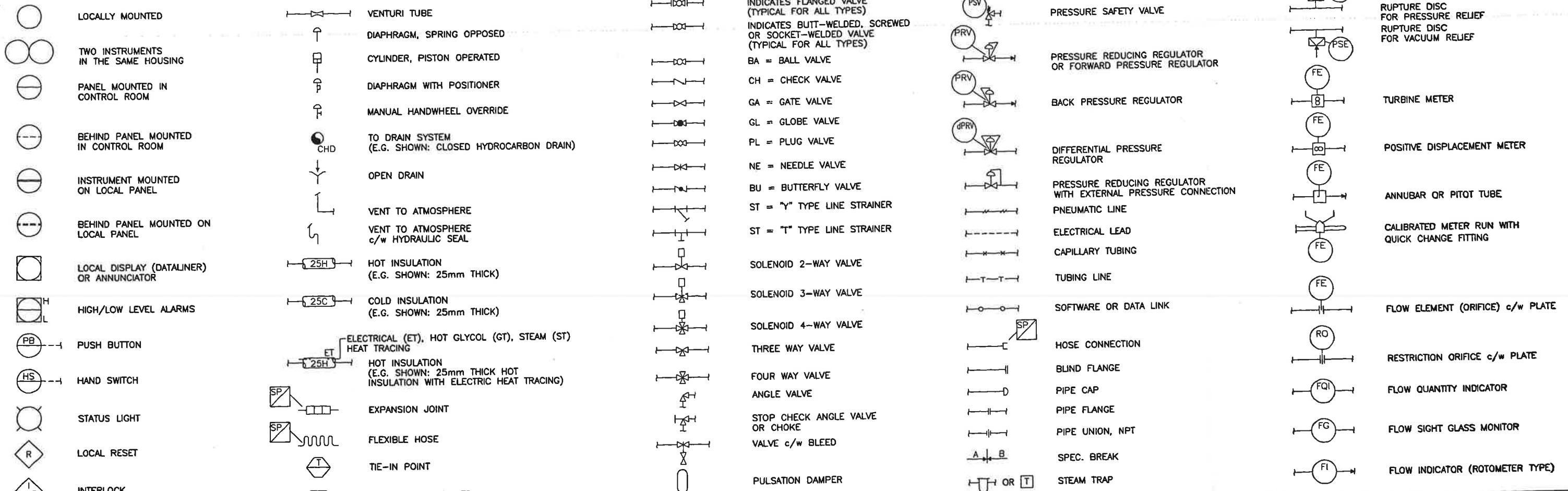
FAX (708) 345-5670

www.total-control.com

800-1000-091/A

THIS DRAWING AND THE DESIGN IT COVERS ARE CONFIDENTIAL AND THE PROPERTY OF PROPAC SYSTEMS LTD. AND SHALL NOT BE DISCLOSED TO OTHERS OR REPRODUCED IN ANY MANNER OR USED FOR ANY PURPOSE WHATSOEVER EXCEPT BY WRITTEN CONSENT OF PROPAC.

PIPING SYMBOLS



	A	AH	AHL	AL	C	CV	DR	DV	E	FIC	G	GM	I	IC	IS	IT	K	L	PH	Q	R	RC	RR	S	SC	SD	SDH	SDL	SE	SH	SL	SLL	SM	SO	SV	T	V	W	Y
A ANALYSIS	AAH	AHL	AAL	AC	ACV	ADR		AE					AI	AIC		AIT					AR	ARC	ARR	AS		ASDH	ASDL		ASH	ASL		ASM			AT		AY		
BJ BURNER FAILURE	BJA												CI	CIC	CIS	CIT		CL			CR	CRC	CRR	CS		CSDH	CSDL		CSH	CSL		CSM			CT		CY		
C CONDUCTIVITY	CAH	CHL	CAL	CC	CCV	CDR		CE			DG		DI	DIC	DIS	DIT	DK	DL			DR	DRC	DRR	DS		DSDH	DSDL	DSE	DSH	DSL		DSM			DT		DY		
D DENSITY	DAH	DAHL	DAL	DC	DCV	DDR		DE					dPI	dPIC	dPIS	dPIT		dPL			dPRC	dPS			dPSD	dPSDH	dPSDL		dPSH	dPSL					ESDV		EY		
dP DIFFERENTIAL PRESSURE	dPAH	dPAHL	dPAL	dPC	dPCV	dPR																			ESD												FY		
E EMERGENCY									FE	FFIC	FG		FI	FIC	FIS	FIT	FK	FL		FQ	FR	FRC	FRR	FS		FSDH	FSDL		FSH	FSL		FSM		FSV	FT				
F FLOW	FAH	FAHL	FAL	FC	FCV	FDR		GE																	GSDH			GSH								HV	HY		
G GAS DETECTION	GAH													HRC										HS												JT	JY		
H HAND (MANUAL)				HC	HCV										JIC																					KT	KV	KY	
J POWER																	KL			KQ				KS													LT	LY	
K TIME	KA			KC	KCV	KDR					LG	LGM	LI	LIC	LIS	LIT		LL			LR	LRC	LRR	LS		LSD	LSDH	LSDL		LSH	LSL	LSSL	LSM				LT	LY	
L LEVEL	LAH	LAHL	LAL	LC	LCV	LDR		LE					MI	MIC	MIS	MIT		ML			MR	MRC	MRR	MS		MSDH	MSDL		MSH	MSL		MSM				MT	MY		
M MOISTURE	MAH	MAHL	MAL	MC	MCV	MDR		ME					PI	PIC	PIS	PIT	PK	PL	PPH		PR	PRC	PRR	PS		PSDH	PSDL	PSE	PSH	PSL		PSM		PSV			PT	PY	
P PRESSURE	PAH	PAHL	PAL	PC	PCV	PDR		PE																														RSDV	RY
R REMOTE				SC	SCV	SDR		SE					SI	SIC	SIS	SIT	SK	SL			SR	SRC	SRR	SS		SSDH	SSDL		SSH	SSL		SSM					ST	SY	
S SPEED	SAH	SAHL	SAL	SC	SCV	SDR		SE					TI	TIC	TIS	TIT	TK	TL			TR	TRC	TRR	TS		TSDH	TSDL	TSE	TSH	TSL		TSM					TT	TW	TY
T TEMPERATURE	TAH	TAHL	TAL	TC	TCV	TDR		TE										UL								USD												VT	VY
U UNIT	UA							UDV													VR	VIR	VIRR	VIS		VSDH			VSH	VISL		VISM				VIT	VY		
V VIBRATION	VAH			VC				VE					VI								VIR	VIRC	VIRR	VIS		VSDH			VSH	VISL		VISM					VIT	VY	
VI VISCOSITY	VIAH	VIAHL	VIAL	VIC	VICV	VIDR		VIE					VII	VIIIC	VIIIS	VIIIT		VIL			VIR	VIRC	VIRR	VIS		VSDH			VSH	VISL		VISM					VIT	VY	
X FIRE DETECTION	XA							XE																		XSD			XSH									ZT	ZY
Z LIMIT OR POSITION	ZAH	ZAHL	ZAL					ZE							ZIS	ZIT	ZL								ZSC	ZSDH	ZSDL		ZSH	ZSL		ZSM	ZSO						ZY

APACHE CANADA LIMITED
1478 HP HAMBURG COMPRESSOR PACKAGE
LEGEND
MECHANICAL FLOWSHEET

APPROVED: MECH/STRUCT. DATE: 00/09/21 BY: J. LINANTUD
DRAWN: J. LINANTUD DATE: DEC. 08/99
ELECTRICAL CHECKED: P. CRAWFORD
PROJECT: P. CRAWFORD DATE: DEC. 30/99
DATE: DEC. 30/99 SCALE:

DWG. No.: D-MFS-99404-100 SHT. 1 OF 11 REV. 5

440 East Lake Road, Postal Bag #2, Airdrie, Alberta, Canada T4B 2C3

No.	REVISION	BY	DATE	CKD	ENG
5	AS BUILT - PER CLIENT REVISIONS	H. LE	00/10/25		
4	CLIENT REVISIONS	H. LE	00/09/21	GW	GW
3	AS BUILT	H. LE	00/08/25	CG	CG
2	RE-ISSUED FOR CONSTRUCTION	J. LINA	00/06/06	SW	SW
1	ISSUED FOR CONSTRUCTION	S. SULZ	99/12/30	PC	PC
A	ISSUED FOR APPROVAL	J. LINA	99/12/08	DHS	DHS

GENERAL NOTES

DATE: 2000.10.25 1:23pm FILE NAME: J:\jobs99\DWG\99404\FLW\MFS-99404-100-01.dwg

THE DESIGN T. COVERS ARE CONFIDENTIAL AND THE PROPERTY OF PROPAC SYSTEMS LTD., AND SHALL NOT BE DISCLOSED TO OTHERS OR REPRODUCED IN ANY MANNER OR USED FOR ANY PURPOSE WHATSOEVER EXCEPT BY WRITTEN CONSENT OF PROPAC.

GENERAL SPECIFICATIONS

CLASS	TYPICAL SERVICE	TEMP. RANGE (°C)	PRESS. RATING (ANSI)
A	SWEET HYDROCARBON, PROPANE REFRIGERANT, FUEL GAS AND FLARE GAS	-29°C TO 260°C	150 # RF
B	SWEET HYDROCARBON, PROPANE REFRIGERANT, FUEL GAS AND FLARE GAS	-29°C TO 260°C	300 # RF
C	SWEET HYDROCARBON, PROPANE REFRIGERANT, FUEL GAS AND FLARE GAS	-29°C TO 260°C	600 # RF
D	SWEET HYDROCARBON	-29°C TO 260°C	900 # RF
E	SWEET HYDROCARBON	-29°C TO 260°C	1500 # RF
F	SWEET HYDROCARBON	-29°C TO 260°C	2500 # RF
H	COMPRESSED AIR AND UTILITY WATER	0°C TO 38°C	150 # RF
J	DRAIN SYSTEM PIPING	5°C TO 95°C	150 # RF
K	GLYCOL	1.21 MPa @ 177°C	150 # RF TO 1500 # RF
AS	SOUR HYDROCARBON, RICH AMINE AND SOUR WATER	-29°C TO 260°C	150 # RF
BS	SOUR HYDROCARBON, RICH AMINE AND SOUR WATER	-29°C TO 260°C	300 # RF
CS	SOUR HYDROCARBON, RICH AMINE AND SOUR WATER	-29°C TO 260°C	600 # RF
DS	SOUR HYDROCARBON	-29°C TO 260°C	900 # RF
ES	SOUR HYDROCARBON	-29°C TO 260°C	1500 # RF
FS	SOUR HYDROCARBON	-29°C TO 260°C	2500 # RF
AL	SWEET HYDROCARBON, PROPANE REFRIGERANT	-46°C TO 66°C	150 # RF
BL	SWEET HYDROCARBON, PROPANE REFRIGERANT	-46°C TO 66°C	300 # RF
CL	SWEET HYDROCARBON, PROPANE REFRIGERANT	-46°C TO 66°C	600 # RF
AC	SWEET HYDROCARBON	-184°C TO 66°C	150 # RF
BC	SWEET HYDROCARBON	-184°C TO 66°C	300 # RF
CC	SWEET HYDROCARBON	-184°C TO 66°C	600 # RF

GENERAL NOTES (ABBREVIATIONS)

- AC - AIR CLOSSES
- AO - AIR OPENS
- AVT - AUTOVENT TRAP
- BD - BLOWDOWN
- BF - BLIND FLANGE
- CBD - CONTINUOUS BD
- CD - CLOSED DRAIN
- CO - CHAIN OPERATED
- CSC - CAR SEAL CLOSED
- CSO - CAR SEAL OPEN
- DC - DRAIN CONNECTION
- EBD - EMERGENCY BD
- ESD - EMERGENCY SHUTDOWN
- ET - ELECTRICAL HEAT TRACE
- FO - FAIL OPEN
- FC - FAIL CLOSED
- FP - FULL PORT
- GT - GLYCOL HEAT TRACE
- HH - HAND HOLE
- HC - HOSE CONNECTION
- L - LOW
- LC - LOCK CLOSED
- LO - LOCK OPEN
- LPD - LOW POINT DRAIN
- ML - MANUAL LOADING
- MW - MANWAY
- NC - NORMALLY CLOSED
- NE - NORMALLY ENERGIZED UNDER OPER. COND.
- NO - NORMALLY OPEN
- ND - NORMALLY DE-ENERGIZED UNDER OPER. COND.
- PC - PISTON CHECK VALVE
- PO - PUMPOUT
- PP - PERSONNEL PROTECTION
- QO - QUICK OPENING
- SC - SAMPLE CONNECTION
- SO - STEAM OUT
- SP - SET POINT
- ST - STEAM HEAT TRACE
- UG - UNDERGROUND
- VB - VACUUM BREAKER
- WC - WATER COLUMN

COMMODITY (ABBREVIATIONS)

- AG - ACID GAS
- AGF - ACID GAS FLARE
- AMD - AMINE DRAIN
- AV - ATMOSPHERIC VENTS
- BD - BLOWDOWN
- C - CAUSTIC
- CCD - CLOSED CRYOGENIC DRAIN
- CHD - CLOSED HYDROCARBON DRAIN
- CSD - CLOSED SOUR DRAIN
- CV - CRYOGENIC VENT
- CWD - CLOSED WATER DRAIN
- DR - DRAIN (ATMOSPHERIC)
- EQL - EQUALIZING
- FG - FUEL GAS
- FL - FLARE
- FO - FUEL OIL
- FW - FIRE WATER
- GD - GLYCOL DRAIN
- GL - GLYCOL
- HC - HIGH PRESSURE STEAM CONDENSATE
- HCL - HYDROCARBON LIQUIDS
- HCV - HYDROCARBON VAPOUR
- HM - HEAT MEDIUM
- HPF - HIGH PRESSURE FLARE
- HS - HIGH PRESSURE STEAM
- I/A - INSTRUMENT AIR
- I/G - INSTRUMENT GAS
- IS - INSTRUMENT SUPPLY
- JW - JACKET WATER
- K - CHEMICALS
- LAM - LEAN AMINE
- LC - LOW PRESSURE STEAM CONDENSATE
- LO - LUBE OIL
- LOD - LUBE OIL DRAIN
- LPF - LOW PRESSURE FLARE
- LPG - LOW PRESSURE GAS
- LS - LOW PRESSURE STEAM
- MC - MEDIUM PRESSURE STEAM CONDENSATE
- MS - MEDIUM PRESSURE STEAM
- P - PROCESS GAS/LIQUID
- PDW - PRODUCED WATER
- POD - PACKING OIL DRAIN/VENT
- POW - POTABLE WATER
- PS - SOUR PROCESS GAS
- PSW - SOUR PROCESS WATER
- PW - PROCESS WATER
- RAM - RICH AMINE
- RLRV - REFRIG. LIQUID, REFRIG. VAPOUR
- ROD - REFRIG. OIL DRAIN
- SO - SEAL OIL
- SOD - SEAL OIL DRAIN
- UW - UTILITY WATER

MISCELLANEOUS EQUIPMENT (ABBREVIATIONS)

- ACT - ACTUATOR
- BLT - BELT
- BUS - BUSHING
- CPL - COUPLING
- EM - HEAT EXCHANGER MOTOR
- ES - EXHAUST SILENCER
- F - FILTER
- FW - FLYWHEEL
- H - HEATER
- INS - INSULATION
- LUB - LUBRICATOR
- MIS - MISCELLANEOUS
- PIP - PIPE
- PM - PUMP MOTOR
- RC - RADIATOR CAP
- SB - SPECTACLE BLIND
- SHF - SHAFT
- SHV - SHEAVE
- SP - SPACER
- STR - STARTER (ELECTRIC/PNEUMATIC)
- T - TANK
- TSS - TEMPORARY SUCTION SCREEN
- TUB - TUBING

TUBING SIZES

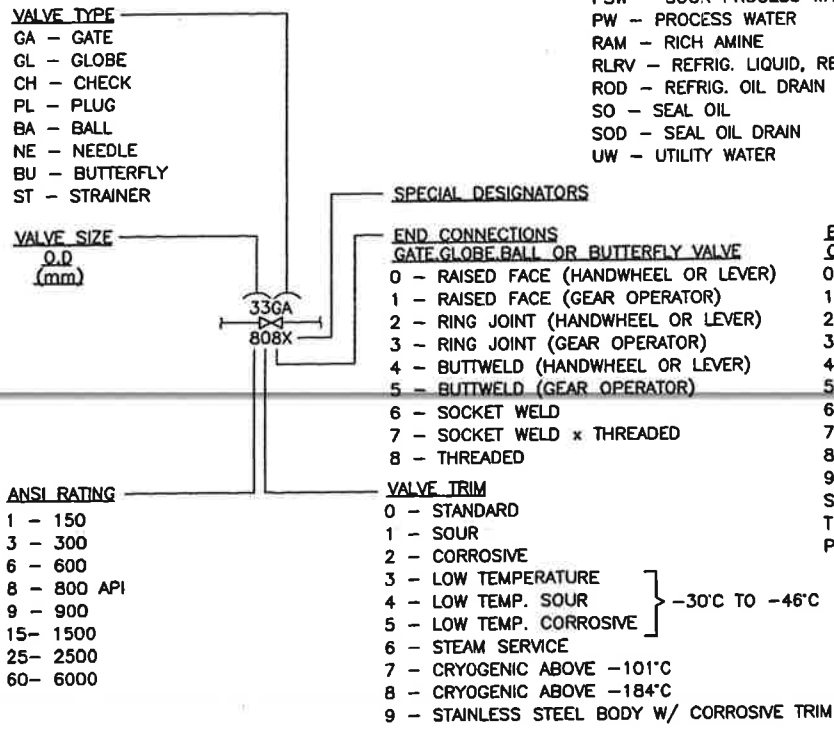
METRIC O.D. (mm)	IMP O.D. (INCH.)	IMP NPS (INCH.)
3	1/8"	1/4"
6	1/4"	3/8"
9	3/8"	1/2"
13	1/2"	3/4"
19	3/4"	1"
25	1"	1-1/2"
		2"
		3"
		4"
		6"
		8"
		10"
		12"
		14"
		16"
		18"
		20"
		24"
		36"
		42"

PIPE SIZES

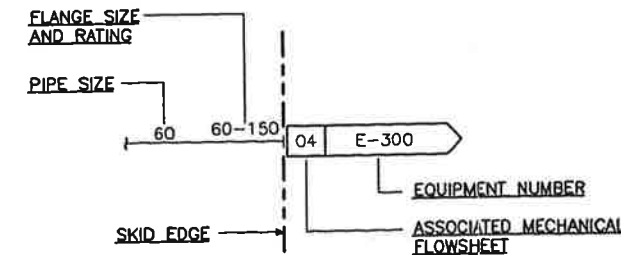
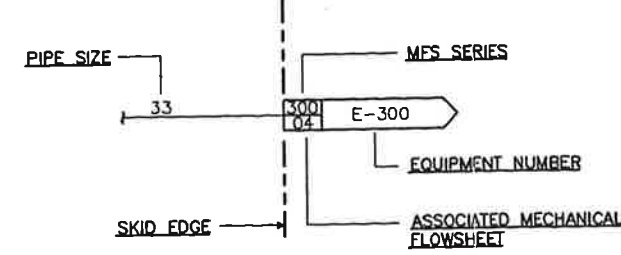
METRIC O.D. (mm)	METRIC DIN (mm)
14	8
17	10
21	15
27	20
33	25
48	40
60	50
89	80
114	100
168	150
219	200
273	250
324	300
356	350
406	400
457	450
508	500
610	600
914	900
1067	1050

NOTES:
NPS - NOMINAL PIPE SIZE

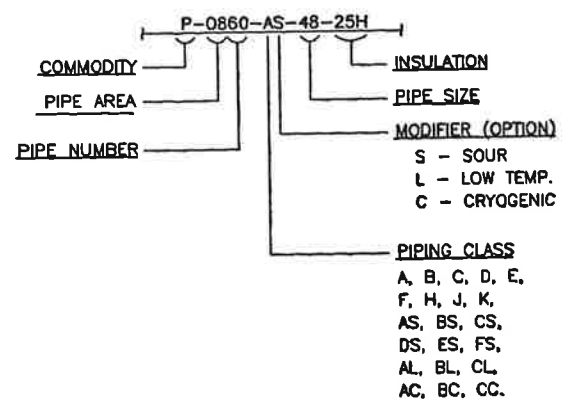
TYPICAL VALVE IDENTIFICATION



TYPICAL PIPE FLAGS



TYPICAL PIPE IDENTIFICATION



TYPICAL EQUIPMENT IDENTIFICATION

TAG No: I-820

DESCRIPTION: DEETHANIZER

DIMENSIONS: ...mm O.D. x ...mm S/S

DESIGN PRESSURE @ DESIGN TEMP., CORROS. ALLOWANCE: ... kPa @ ... °C, ...mm C.A.

GAS FLOW RATES: ... m3/d

LIQUID FLOW RATES: ... m3/h

DUTIES: ... kW

MOTOR POWER: ... kW @ V/φ/Hz

STRESS RELIEVING AND X-RAY: S.R.: YES/NO, X-RAY: FULL/100%/SPOT

MAKE AND MODEL:

No.	REVISION	BY	DATE	CKD	ENG
5	AS BUILT- PER CLIENT REVISIONS	H. LE	00/10/25	SL	SL
4	CLIENT REVISIONS	H. LE	00/09/21	GW	GW
3	AS BUILT	H. LE	00/08/25	CG	CG
2	RE-ISSUED FOR CONSTRUCTION	J. LINA	00/06/06	SW	SW
1	ISSUED FOR CONSTRUCTION	S.SULZ	99/12/30	PC	PC
A	ISSUED FOR APPROVAL	J. LINA	99/12/08	DHS	DHS

APPROVED	DRAWN
MECH./STRUCT. BY: J. LINANTUD	DATE: DEC. 08/99
DATE: DEC. 30/99	CHECKED: P. CRAWFORD
PROJECT: P. CRAWFORD	DATE: DEC. 30/99
DATE: DEC. 30/99	SCALE:

APACHE CANADA LIMITED	
1478 HP HAMBURG COMPRESSOR PACKAGE	
LEGEND	
MECHANICAL FLOWSHEET	
DWG. No.: D-MFS-99404-100	SHT. 2 OF 11
REV. 5	

PROPAK
440 East Lake Road,
Postal Bag #2
Airdrie, Alberta
Canada T4B 2C3

THIS DRAWING AND THE DESIGN IT COVERS ARE CONFIDENTIAL AND THE PROPERTY OF PROPAK SYSTEMS LTD., AND SHALL NOT BE DISCLOSED TO OTHERS OR REPRODUCED IN ANY MANNER OR USED FOR ANY PURPOSE WHATSOEVER EXCEPT BY WRITTEN CONSENT OF PROPAK.

ENGINE CONNECTION INDEX

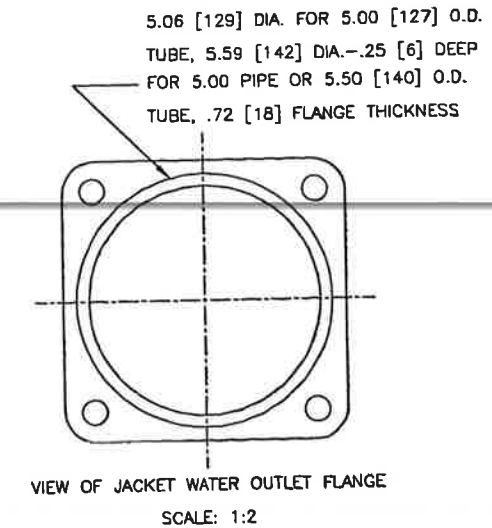
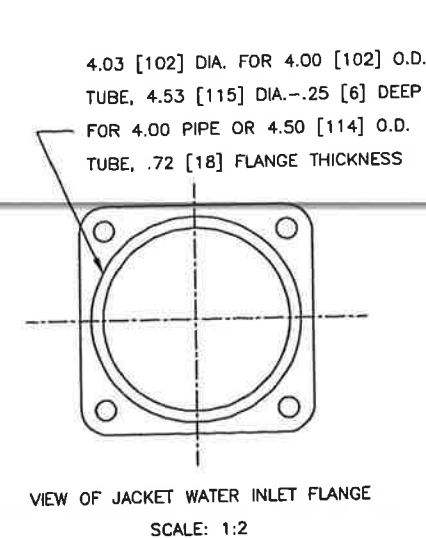
1. NATURAL GAS INLET 2.00-11.5 N.P.T.
NOTE: FLEXIBLE CONNECTION REQUIRED AT THE FUEL INLET LOCATION(S) TO ISOLATE ENGINE VIBRATION FROM FUEL PIPING. LOCATE AS CLOSE TO ENGINE AS POSSIBLE.
2. STARTING MOTOR PAD .625-11 UNC-2B TAP THRU 3 HOLES FOR STARTING MOTOR WITH S.A.E. NUMBER 3 MOUNTING FLANGE.
4. JACKET WATER OUTLET FLANGE. (SEE VIEW OF FLANGE)
5. FRONT LIFTING EYES 3.00 [76] DIA. HOLE.
6. REAR LIFTING EYES 3.00 [76] DIA. HOLE.
8. CRANKSHAFT PULLEY - (2) 9.88 [251] NOMINAL DIAMETER X .500 [13] WIDE S.A.E. AUTOMOTIVE GROOVES.
9. .88 [22] DIAMETER - 12 ENGINE MOUNTING HOLES.
10. LUBE OIL DRAIN 2.00-11.5 N.P.T.
11. .75-10 UNC-2B TAP 1.25 [32] DEEP, 12 HOLES EQUALLY SPACED.
12. .75-10 UNC-2B TAP 1.25 [32] DEEP, 12 HOLES EQUALLY SPACED.
13. .625-11 UNC-2B TAP 1.00 [25] DEEP, 12 HOLES EQUALLY SPACED.
14. .250 [6] NOMINAL DIAMETER TUBE, AIR/GAS VENT CONNECTION.
(SEE VIEW "A") (SEE NOTE 1)
15. .250 [6] NOMINAL DIAMETER TUBE, AIR/GAS SUPPLY CONNECTION.
(SEE VIEW "A")
16. .375-18 N.P.T. AIR/GAS PRELUBE SUPPLY CONNECTION.
17. .250 [6] NOMINAL DIAMETER TUBE, AIR/GAS START CONNECTION.
(SEE VIEW "A")
18. LUBE OIL STRAINER INLET FROM LUBE OIL FILTER.
2.00 RAISED FACE 150 LB. A.N.S.I. WELD NECK FLANGE.
19. JACKET WATER INLET FLANGE, 2 PLACES. (SEE VIEW OF FLANGE)
22. LUBE OIL FILTER INLET FROM LUBE OIL COOLER ASSEMBLY.
2.00 RAISED FACE 150 LB. A.N.S.I. FLANGE.
23. LUBE OIL FILTER OUTLET TO ENGINE LUBE OIL STAINER.
2.00 RAISED FACE 150 LB. A.N.S.I. FLANGE.
24. .56 [14] DIAMETER - 4 PLACES EQUALLY SPACED IN MOUNTING FEET FOR LUBE OIL FILTER MOUNTING.
25. EXHAUST OUTLET FLANGE - FITS 8.00 FLAT FACE 125 LB. A.N.S.I. CAST IRON PIPE FLANGE. NOTE: EXHAUST SYSTEM MUST SUPPORT ITS OWN WEIGHT BEYOND THIS POINT.
27. AUXILIARY WATER INLET FROM COOLING SYSTEM.
2.50 125 LB. A.N.S.I. FLANGE.
28. 375-18 N.P.T. AIR/GAS PRE-LUBE MOTOR EXHAUST.
(SEE NOTE 1)

NOTE 1: ALL GAS VENTED AND/OR DISCHARGED FROM ENGINE EQUIPMENT SHOULD BE PIPED TO A SAFE AREA TO MEET APPLICABLE CODES.
NOTE 2: ROTATIONS ARE VIEWED FROM FLYWHEEL END.

33. LUBE OIL COOLER ASSEMBLY OUTLET TO LUBE OIL FILTER. 2.00 RAISED FACE 150 LB. A.N.S.I. FLANGE.
34. PRESSURE REGULATING VALVE OUTLET ON LUBE OIL COOLER ASSEMBLY TO ENGINE OIL PAN. 1.50 RAISED FACE 150 LB, A.N.S.I. FLANGE.
35. AUXILIARY WATER INLET AT LUBE OIL COOLER ASSEMBLY.
2.50 FLAT FACE 125 LB. A.N.S.I. FLANGE.
36. AUXILIARY WATER OUTLET AT LUBE OIL COOLER ASSEMBLY TO THERMOSTATIC VALVE AND COOLING SYSTEM, 2.50 FLAT FACE 125 LB. A.N.S.I. FLANGE.
37. .69 X 1.25 [18 X 32] SLOT - 4 PLACES FOR LUBE OIL COOLER ASSEMBLY MOUNTING.
38. AUXILIARY WATER BYPASS CONNECTION FROM LUBE OIL COOLER.
2.00 FLAT FACE 125 LB A.N.S.I. FLANGE.
39. .750-14 N.P.T. AUXILIARY WATER CONNECTION FROM EXPANSION TANK.
40. CLEARANCE REQUIRED TO REMOVE LUBE OIL FILTER ELEMENT.
41. AUXILIARY WATER OUTLET TO LUBE OIL COOLER ASSEMBLY.
1.50 FLAT 150 LB. A.N.S.I. FLANGE.
42. LUBE OIL INLET FROM PRESSURE REGULATING VALVE ON LUBE OIL COOLER ASSEMBLY, 1.50 LAP JOINT 150 LB. A.N.S.I. FLANGE WITH STUB END.
43. LUBE OIL OUTLET TO LUBE OIL COOLER ASSEMBLY, 2.00 LAP JOINT 150 LB A.N.S.I. FLANGE WITH STUB END.
44. LUBE OIL COOLER ASSEMBLY INLET FROM ENGINE LUBE OIL PUMP.
2.00 RAISED FACE 150 LB. A.N.S.I. FLANGE.
54. ENGINE PRESSURE BLOCK, OIL AND INTAKE MANIFOLD PRESSURE .125-27 N.P.T. 6 PLACES (4 OIL, 2 AIR.) (SEE VIEW "B")
55. ENGINE IGNITION POWER JUNCTION BOX 24 VOLT DC.
56. ENGINE TEMPERATURE CONNECTION POINTS. THERMOCOUPLE TYPE K, AND CUSTOM CONTROLS JUNCTION BOX.
57. FRONT FACE OF CRANKCASE.
59. DSM FILTER SIGNAL INPUT. INCLUDES 11 FOOT LONG CABLE.
60. DSM FILTER SIGNAL OUTPUT. INCLUDES 15 FOOT LONG CABLE.
61. DSM FILTER POWER INPUT.
62. DSM SIGNAL INPUT. FROM CONNECTION 60.
63. DSM POWER INPUT.
64. DSM SIGNAL OUTPUT. INCLUDES 15 FOOT LONG CABLE.
65. .31-18 UNC-2A 4 PLACES, FOR MOUNTING DSM.
66. .31-18 UNC-2A 4 PLACES, FOR MOUNTING DSM FILTER.

EQUIPMENT INDEX

- A. S.A.E NUMBER 00 FLYWHEEL HOUSING
- B. TIMING HOLE PAD
- C. ENGINE WATER DRAIN
- D. GOVERNOR, HYDRAULIC
- E. SAFETY GUARD
- F. LUBE OIL DIPSTICK (BOTH SIDES)
- G. LUBE OIL FILLER
- H. LUBE OIL STRAINER
- J. AIR/GAS MOTORIZED PRE-LUBE PUMP
- K. LUBE OIL FILTER ASSEMBLY (SHIPPED LOOSE)
- L. CRANKCASE BREATHER (2)
- M. AIR CLEANERS (2)
- P. MANUAL BARRING DEVICE
- Q. ENGINE LEVELING BOLTS (4) 1.00-8 UNC-2B THREAD
- R. 24.00 [610] LONG FLEXIBLE METAL HOSE (SHIPPED LOOSE)
- S. 24.00 [610] LONG FLEXIBLE METAL HOSE (SHIPPED LOOSE)
- T. GOVERNOR SPEED CONTROL HAND LEVER
- U. THROTTLE LEVER
- V. LUBE OIL COOLER ASSEMBLY (SHIPPED LOOSE)
- W. FLEXIBLE EXHAUST CONNECTION (SHIPPED LOOSE)
- X. 24.00 [610] LONG FLEXIBLE METAL HOSE (SHIPPED LOOSE)
- UU. PNEUMATIC CONTROL PANEL CONSISTING OF START, STOP, PRELUBE, AND SAFETY RESET.
- XX. CEC IGNITION MODULE
- BA. DETONATION SENSING MODULE (DSM) (SHIPPED LOOSE)
- CA. DSM FILTER (SHIPPED LOOSE)



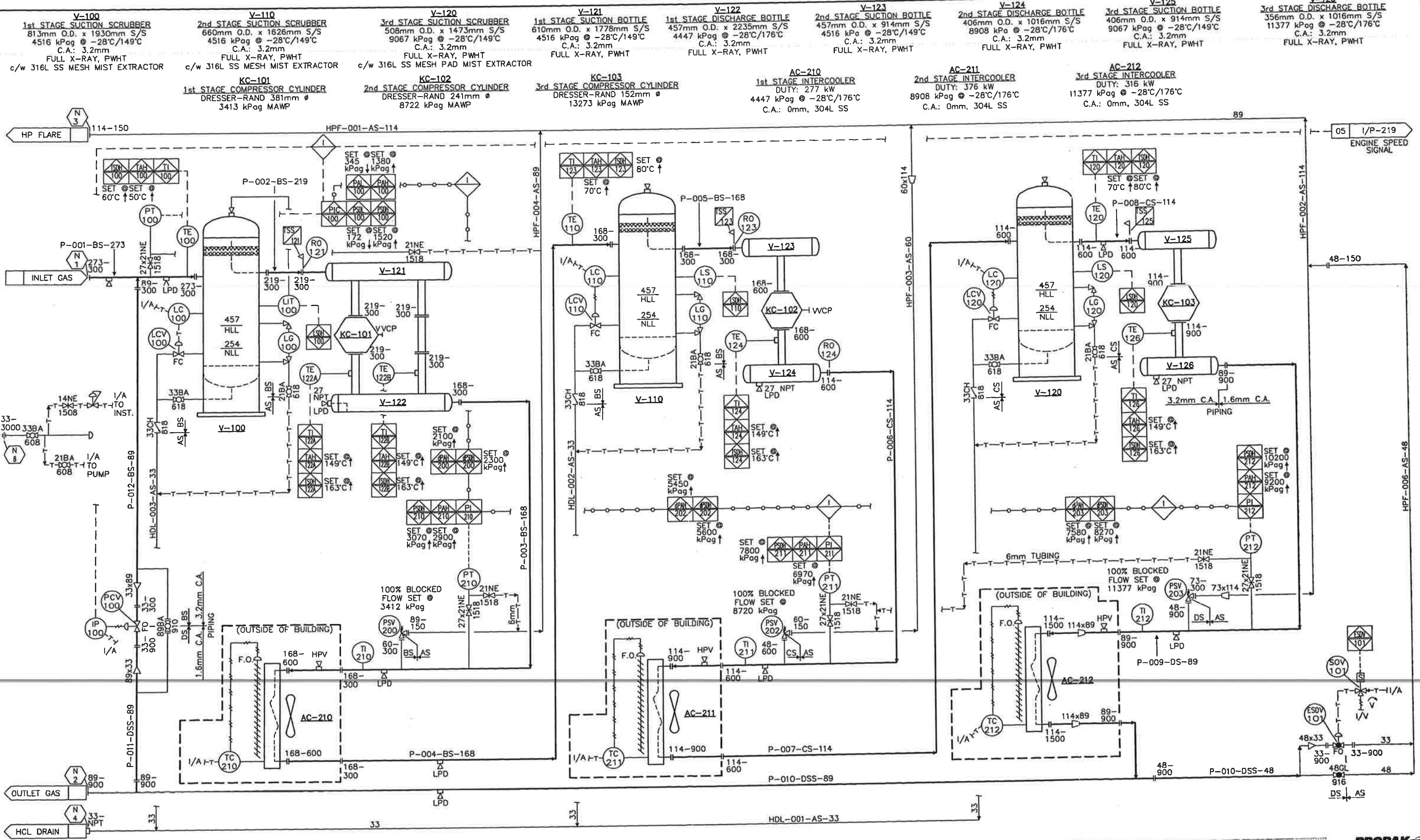
No.	REVISION	BY	DATE	CKD	ENG
5	AS BUILT- PER CLIENT REVISIONS	H. LE	00/10/25	hw	hw
4	CLIENT REVISIONS	H. LE	00/09/21	GW	GW
3	AS BUILT	H. LE	00/08/25	CG	CG
2	RE-ISSUED FOR CONSTRUCTION	H. LE	00/06/06	SW	SW
1	ISSUED FOR CONSTRUCTION	S. SULZ	99/12/30	PC	PC
A	ISSUED FOR APPROVAL	J. LINA	99/12/08	DHS	DHS

APPROVED		DRAWN	
MECH./STRUCT.	BY	J. LINANTUD	DATE
DATE		DEC. 08/99	CHECKED
ELECTRICAL	BY	P. CRAWFORD	DATE
DATE		DEC. 30/99	SCALE
PROJECT	P. CRAWFORD		
DATE	DEC. 30/99		

APACHE CANADA LIMITED			
1478 HP HAMBURG COMPRESSOR PACKAGE EQUIPMENT AND ENGINE CONNECTION INDEX MECHANICAL FLOWSHEET			
DWG. No.:	D-MFS-99404-100	SHT. 3 OF 11	REV. 5

PROPAK
440 East Lake Road,
Postal Bag #2
Airdrie, Alberta
Canada T4B 2C3

THE DESIGN IT COVERS ARE CONFIDENTIAL AND THE PROPERTY OF PROPAC SYSTEMS LTD., AND SHALL NOT BE DISCLOSED TO OTHERS OR REPRODUCED IN ANY MANNER OR USED FOR ANY PURPOSE WHATSOEVER EXCEPT BY WRITTEN CONSENT OF PROPAC.



GENERAL NOTES

- USE XXH NIPPLE ON NPT CONNECT FOR "DS", "CS" & "BS"
- USE SCH 160 NIPPLE ON NPT CONNECT FOR "AS"
- VENT ALL VENTING INSTS TO VENT HEADER.

GENERAL NOTES

No.	REVISION
5	AS BUILT - PER CLIENT REVISIONS
4	CLIENT REVISIONS
3	AS BUILT
2	RE-ISSUED FOR CONSTRUCTION
1	ISSUED FOR CONSTRUCTION
A	ISSUED FOR APPROVAL

REVISION

BY	DATE	CKD	ENG
H. LE	00/10/25	DL	DL
H. LE	00/09/21	GW	GW
H. LE	00/08/25	CG	CG
H. LE	00/06/06	SW	SW
S. SULZ	99/12/30	PC	PC
J. UNWIL	99/12/08	DHS	DHS

APPROVED

MECH/STRUCT.	DATE	BY	DATE	BY	DATE
		J. LINANTUD	DEC. 08/99		
			CHECKED		
		P. CRAWFORD	DEC. 30/99		
			CHECKED		
			DATE		
			SCALE		

APACHE CANADA LIMITED

1478 HP HAMBURG COMPRESSOR PACKAGE
COMPRESSOR
MECHANICAL FLOWSHEET

DWG. No.: D-MFS-99404-100 SHT. 4 OF 11 REV. 5

PROPAC
440 East Lake Road,
Postal Bag #2
Airdrie, Alberta
Canada T4B 2C3

THIS DRAWING AND THE DESIGN IT COVERS ARE CONFIDENTIAL AND THE PROPERTY OF PROPAK SYSTEMS LTD. AND SHALL NOT BE DISCLOSED TO OTHERS OR REPRODUCED IN ANY MANNER OR USED FOR ANY PURPOSE WHATSOEVER EXCEPT BY WRITTEN CONSENT OF PROPAK.

F-220
FUEL GAS FILTER
 HEAD LINE 385-AP-70C-1-1/2"
 1724 kPag @ 93°C
 c/w 70-C FILTER ELEMENT

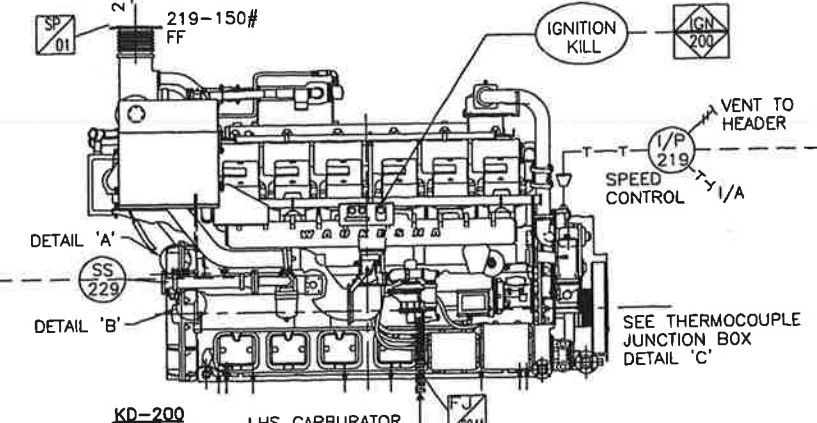
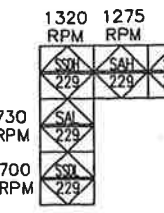
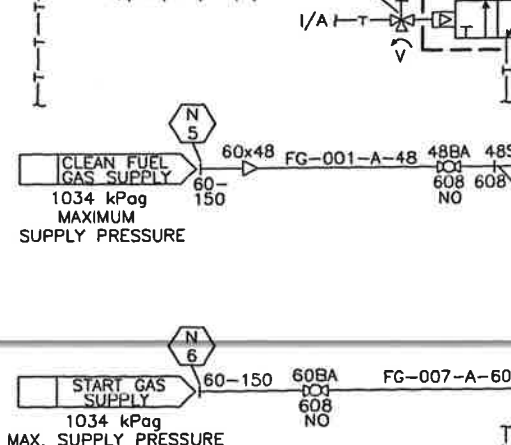
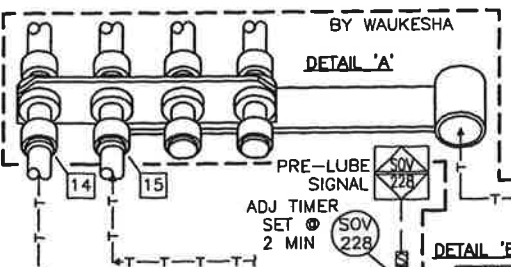
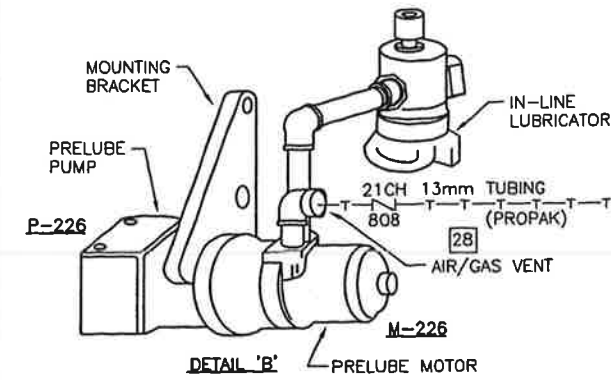
P-226/M-226
ENGINE PRELUBE PUMP
 GAS DRIVEN MOTOR
 c/w ENGINE

KD-200
COMPRESSOR DRIVER
 WAUKESHA 7042GL
 1478 BHP @ 1200 RPM
 54°C INTERCOOLER INLET TEMPERATURE

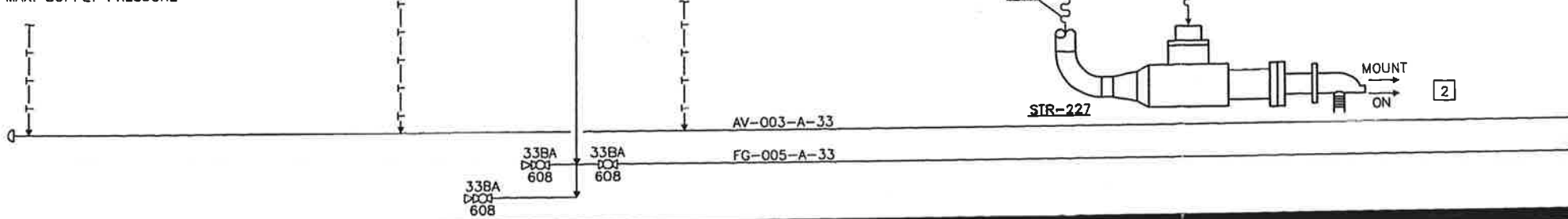
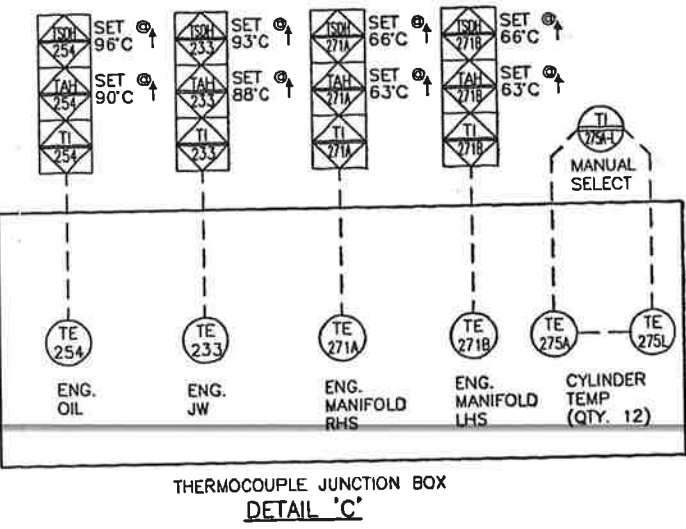
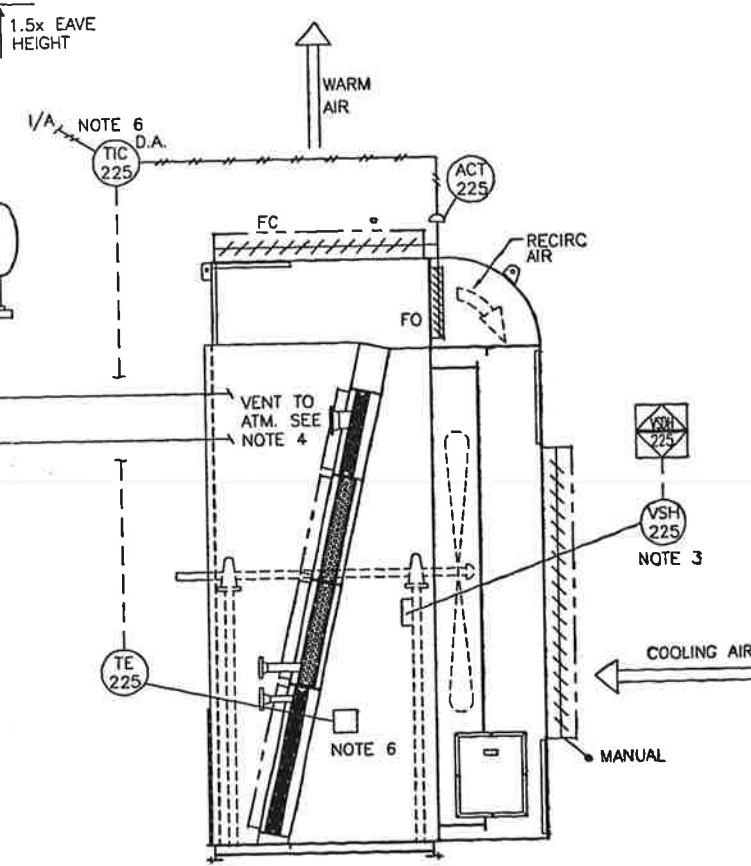
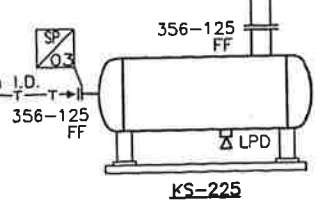
STR-227
ENGINE STARTER
 TDI TURBO TWIN
 M/N T112B PIN T112-60001-BIR
 30.875 sm³/min @ 827 kPag

KS-225
COMPRESSOR SILENCER
 MODEL: JAT-14-S012
 CRITICAL GRADE SILENCER
 356mm-125# IN/OUT

04 PIC-100
 ENGINE SPEED SIGNAL



INSULATION 457mm O.D.
 NOTE 5



GENERAL NOTES	
1. HIGH PRESSURE SOV.	AT 45° AS SHOWN AT APPROXIMATELY THE SAME ELEVATION.
2. ENGINE CONNECTION INDEX SEE 99404-100-03	
3. LOCATE VSH CLOSE TO FAN SHAFT ON BEARING SUPPORT.	5. INSULATE TO BUILDING WALL ONLY.
4. VENTS TO ATM. INSIDE COOLER PLENUM TO TERMINATE HORIZONTALLY WITH PIPE ENDS CUT	6. MOUNT TIC ON COOLER WALL, ELEMENT SENSES INCOMING AIR

No.	REVISION
5	AS BUILT - PER CLIENT REVISIONS
4	CLIENT REVISIONS
3	AS BUILT
2	RE-ISSUED FOR CONSTRUCTION
1	ISSUED FOR CONSTRUCTION
A	ISSUED FOR APPROVAL

BY	DATE	CHKD	ENG
H. LE	00/10/25	DW	027
H. LE	00/09/21	CW	CW
H. LE	00/08/25	CG	CG
H. LE	00/06/08	SW	SW
S.SULZ	99/12/30	PC	PC
J. LINA	99/12/08	DHS	DHS

APPROVED	BY	DATE	SCALE
MECH./STRUCT.	J. LINANTUD	DEC. 08/99	
ELECTRICAL	P. CRAWFORD	DEC. 30/99	

APACHE CANADA LIMITED	
1478 HP HAMBURG COMPRESSOR PACKAGE	
ENGINE FUEL START GAS	
MECHANICAL FLOWSHEET	
DWG. No.: D-MFS-99404-100	SHT. 5 OF 11

PROPAK
 440 East Lake Road,
 Postal Bag #2
 Airdrie, Alberta
 Canada T4B 2C3

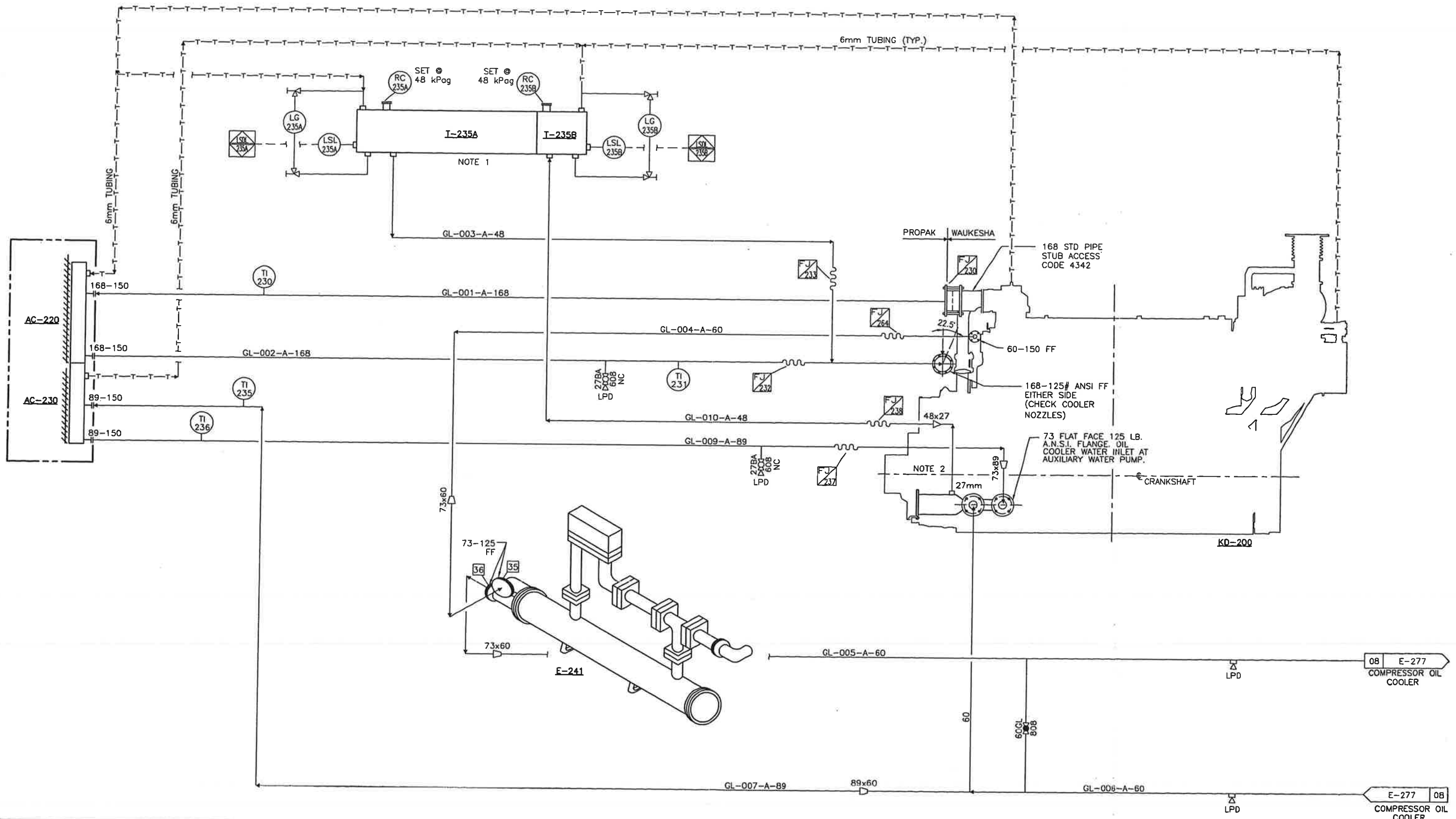
THE DESIGN IT COVERS ARE CONFIDENTIAL AND THE PROPERTY OF PROPAK SYSTEMS LTD., AND SHALL NOT BE DISCLOSED TO OTHERS OR REPRODUCED IN ANY MANNER OR USED FOR ANY PURPOSE WHATSOEVER EXCEPT BY WRITTEN CONSENT OF PROPAK.

AC-220 ENGINE JW COOLER
 96.5 kPag MAWP
 DUTY: 4.01mm BTU/hr (117.4 kW/hr)
 0mm C.A.

AC-230 ENGINE AW COOLER
 96.5 kPag MAWP
 DUTY: 0.775mm BTU/hr (22.7 kW/hr)
 0mm C.A.

T-235A/T-235B ENGINE JW/AW SURGE TANK
 160/74 L CAPACITY
 96.5 kPag MAWP

E-241 ENGINE OIL COOLER
 c/w ENGINE



1. MOUNT T-235A/T-235B ON TOP OF COOLER AS CLOSE AS POSSIBLE TO EDGE.
 2. SHOP DISCRETION TO RUN 19mm TUBING INTO GL-010-A-48

GENERAL NOTES
 DATE: 2000.10.25 1:28pm FILE NAME: J:\jobs99\DWG\99404\FLW\MFS-99404-100-06.dwg

No.	REVISION
5	AS BUILT - PER CLIENT REVISIONS
4	CLIENT REVISIONS
3	AS BUILT
2	RE-ISSUED FOR CONSTRUCTION
1	ISSUED FOR CONSTRUCTION
A	ISSUED FOR APPROVAL

BY	DATE	CHKD	ENG
H. LE	00/10/25	DLW	DLW
H. LE	00/09/21	CW	CW
H. LE	00/08/25	CG	CG
H. LE	00/06/08	SW	SW
S. SULZ	99/12/30	PC	PC
J. LINA	99/12/08	DHS	DHS

APPROVED		DRAWN	
MECH/STRUCT.	BY	BY	DATE
ELECTRICAL		P. CRAWFORD	DEC. 08/99
DATE		DATE	DEC. 30/99
PROJECT	P. CRAWFORD	DATE	DEC. 30/99
DATE	DEC. 30/99	SCALE	

APACHE CANADA LIMITED
 1478 HP HAMBURG COMPRESSOR PACKAGE
 GLYCOL COOLING SYSTEM
 MECHANICAL FLOWSHEET

PROPAK
 440 East Lake Road,
 Postal Bag #2
 Airdrie, Alberta
 Canada T4B 2C3

DWG. No.: D-MFS-99404-100 SHT. 6 OF 11 REV. 5

THE DESIGN IT COVERS ARE CONFIDENTIAL AND THE PROPERTY OF PROPAK SYSTEMS LTD., AND SHALL NOT BE DISCLOSED TO OTHERS OR REPRODUCED IN ANY MANNER OR USED FOR ANY PURPOSE WHATSOEVER EXCEPT BY WRITTEN CONSENT OF PROPAK.

F-253
ENGINE OIL FILTER
c/w ENGINE
SHIPLOOSE

F-241
ENGINE OIL COOLER
c/w ENGINE
SHIPLOOSE

KD-200
COMPRESSOR DRIVER
WAUKESHA L7042GL
1478 HP @ 1200 RPM

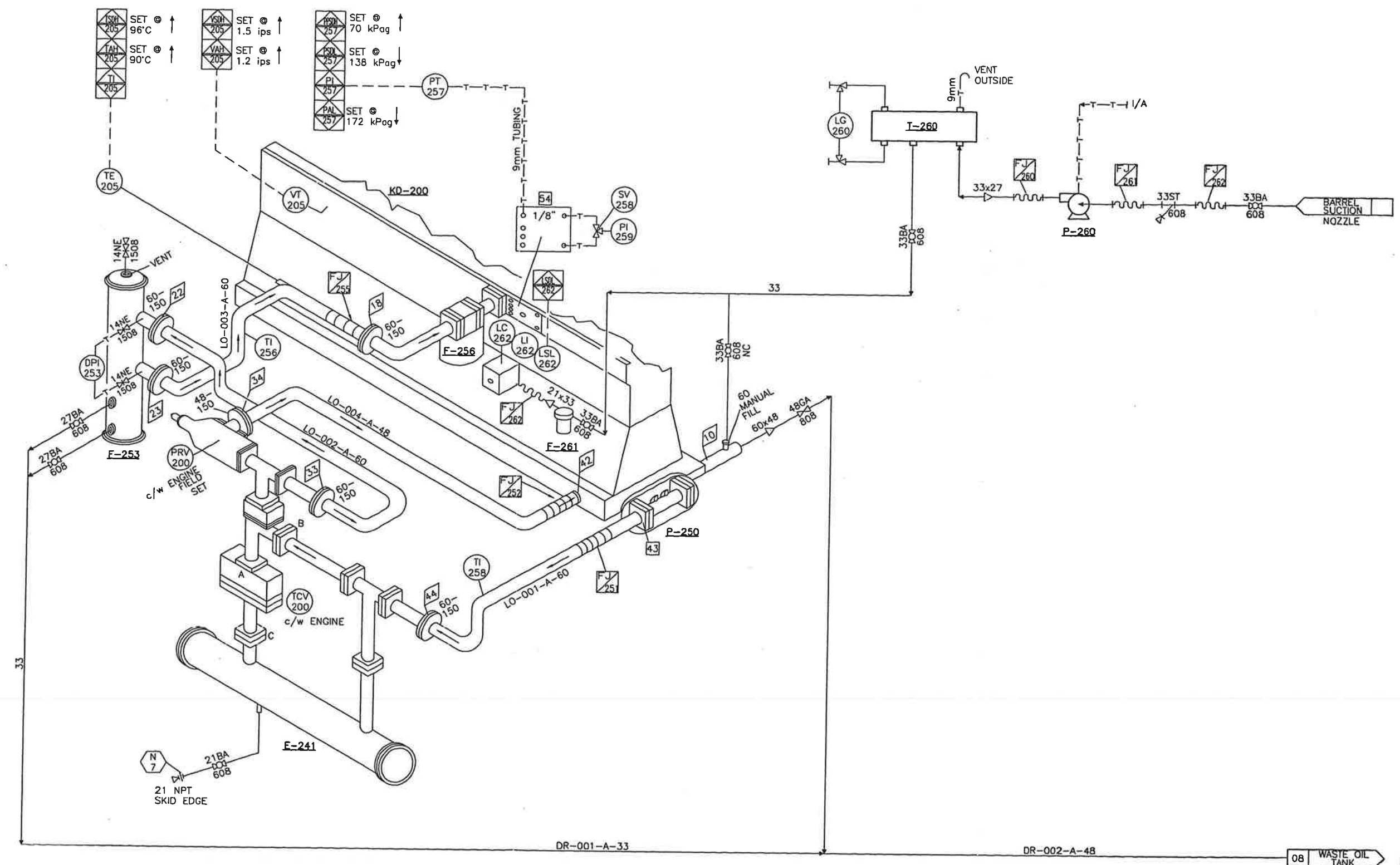
F-256
ENGINE OIL STRAINER
c/w MAGNETIC FILTER ELEMENT
(SEE NOTE 1)

F-261
OIL SUPPLY FILTER
BALDWIN BF914 HOUSING
c/w BALDWIN BF915 FILTER ELEMENT

P-250
ENGINE OIL PUMP
c/w ENGINE

I-260
ENGINE LUBE OIL SUPPLY
TANK INTEGRAL w/ CRANE
STRUCTURE (425L) (RHS)
ATM DESIGN

P-260
PNEUMATIC DIAPHRAGM PUMP
WILDEN T2 M/N: AAAB/BN/BN/ABN
75 L/MIN



1. INSTALL PAPER ELEMENT IN F-256. RUN PRE LUBE PUMP FOR OIL FLUSH PROCEDURE. REPLACE PAPER ELEMENT PRIOR TO FIELD START-UP.
2. ENGINE CONNECTION INDEX SEE MFS-98147-100-P. 10.

GENERAL NOTES	
No.	REVISION

5	AS BUILT- PER CLIENT REVISIONS	H. LE	00/10/25	JL	SLW
4	CLIENT REVISIONS	H. LE	00/09/21	CW	CW
3	AS BUILT	H. LE	00/08/25	CG	CG
2	RE-ISSUED FOR CONSTRUCTION	H. LE	00/06/06	SW	SW
1	ISSUED FOR CONSTRUCTION	J. LINA	99/12/30	PC	PC
A	ISSUED FOR APPROVAL	J. LINA	99/12/08	DHS	DHS

APPROVED		DRAWN	
MECH./STRUCT.	BY	J. LINANTUD	DATE
DATE		DEC. 08/99	
ELECTRICAL	BY	P. CRAWFORD	DATE
DATE		DEC. 30/99	
PROJECT	P. CRAWFORD	DATE	DEC. 30/99
DATE	DEC. 30/99	SCALE	

APACHE CANADA LIMITED
1478 HP HAMBURG COMPRESSOR PACKAGE
ENGINE UTILITIES
MECHANICAL FLOWSHEET

PROPAK
440 East Lake Road,
Postal Bag #2
Airdrie, Alberta
Canada T4B 2C3

THIS DRAWING AND THE DESIGN IT COVERS ARE CONFIDENTIAL AND THE PROPERTY OF PROPAC SYSTEMS LTD. AND SHALL NOT BE DISCLOSED TO OTHERS OR REPRODUCED IN ANY MANNER OR USED FOR ANY PURPOSE WHATSOEVER EXCEPT BY WRITTEN CONSENT OF PROPAC.

P-276
 COMPRESSOR PRELUBE PUMP
 GAS DRIVEN DIAPHRAGM PUMP
 WILDEN T2 M/N: AAAB/BN/ABN
 75 L/MIN

E-277
 COMPRESSOR OIL COOLER
 SHELL & TUBE
 (OIL) SHELL SIDE: 2068 kPag MAWP
 (OIL) TUBESIDE: 1034 kPag MAWP
 DUTY: 21 kW (1230 BTU/MIN)

K-200
 SOUR GAS COMPRESSOR
 DRESSER RAND 6H0S3
 1506 kW, @ 1200 RPM
 60,000 lb MAX ROD LOAD

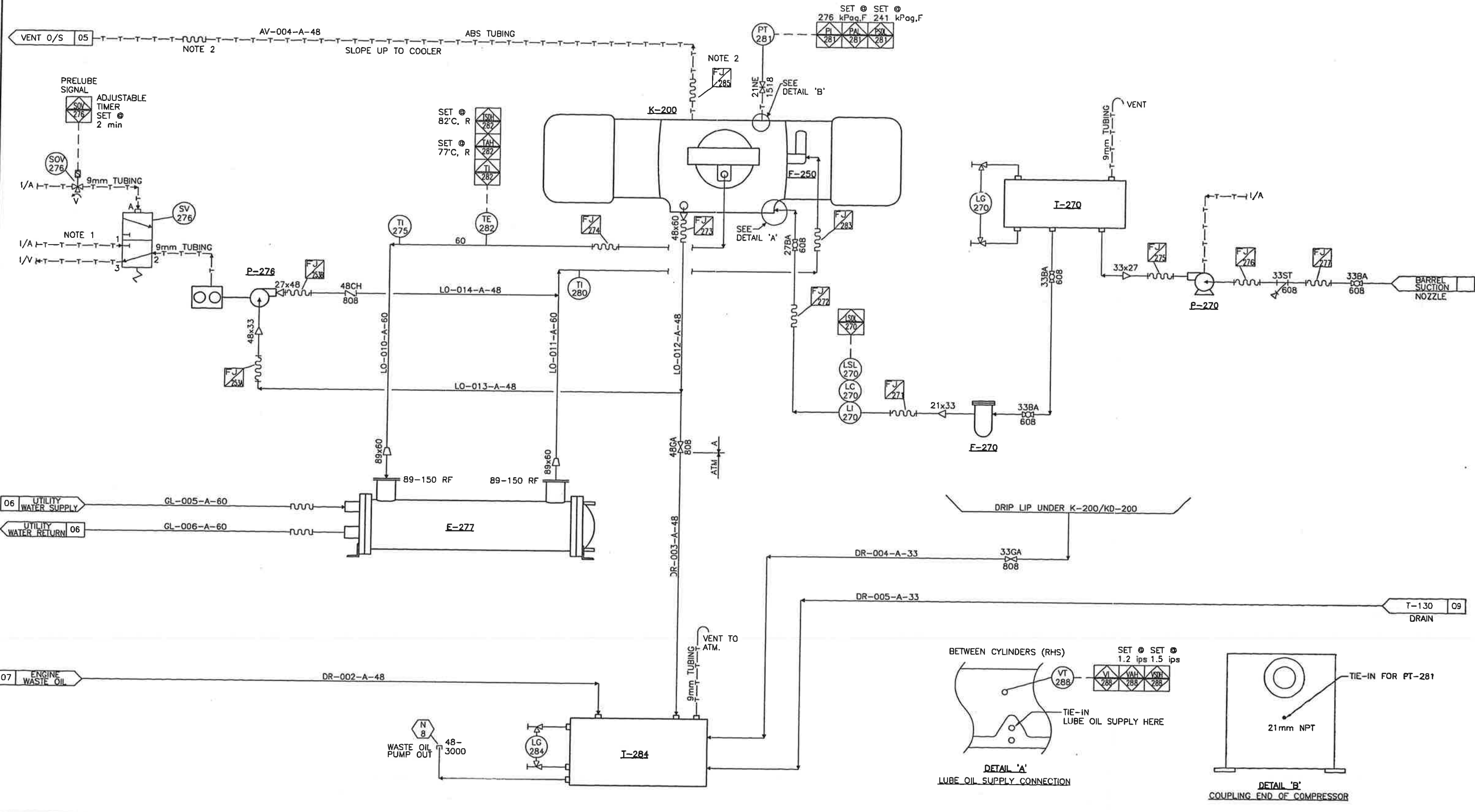
T-284
 WASTE OIL TANK
 800 L
 INTEGRAL WITH SKID

F-250
 COMPRESSOR RUNNING FILTER
 c/w COMPRESSOR
 FULL FLOW CAPACITY

F-270
 LUBE OIL SUPPLY FILTER
 BALDWIN BF914
 c/w BALDWIN BF915 FILTER ELEMENT

I-270
 COMPRESSOR LUBE OIL SUPPLY
 TANK INTEGRAL w/CRANE
 STRUCTURE (425L) (LHS)
 ATM DESIGN

P-270
 PNEUMATIC DIAPHRAGM PUMP
 WILDEN T2 M/N: AAAB/BN/ABN
 75 L/MIN



- 1. NO REGULATOR ON THIS I/S.
- 2. SHOP FIT, RUBBER HOISING

GENERAL NOTES		GENERAL NOTES	
DATE: 2000.10.25 1:31pm	FILE NAME: J:\jobs99\DWG\99404\FLW\MFS-99404-100-08.dwg	No.	REVISION

No.	REVISION	BY	DATE	CHKD	ENG
5	AS BUILT- PER CLIENT REVISIONS	H. LE	00/10/25		
4	CLIENT REVISIONS	H. LE	00/09/21	GW	GW
3	AS BUILT	H. LE	00/08/25	CG	CG
2	RE-ISSUED FOR CONSTRUCTION	H. LE	00/06/06	SW	SW
1	ISSUED FOR CONSTRUCTION	S. SULZ	99/12/30	PC	PC
A	ISSUED FOR APPROVAL	J. LINA	99/12/08	DHS	DHS

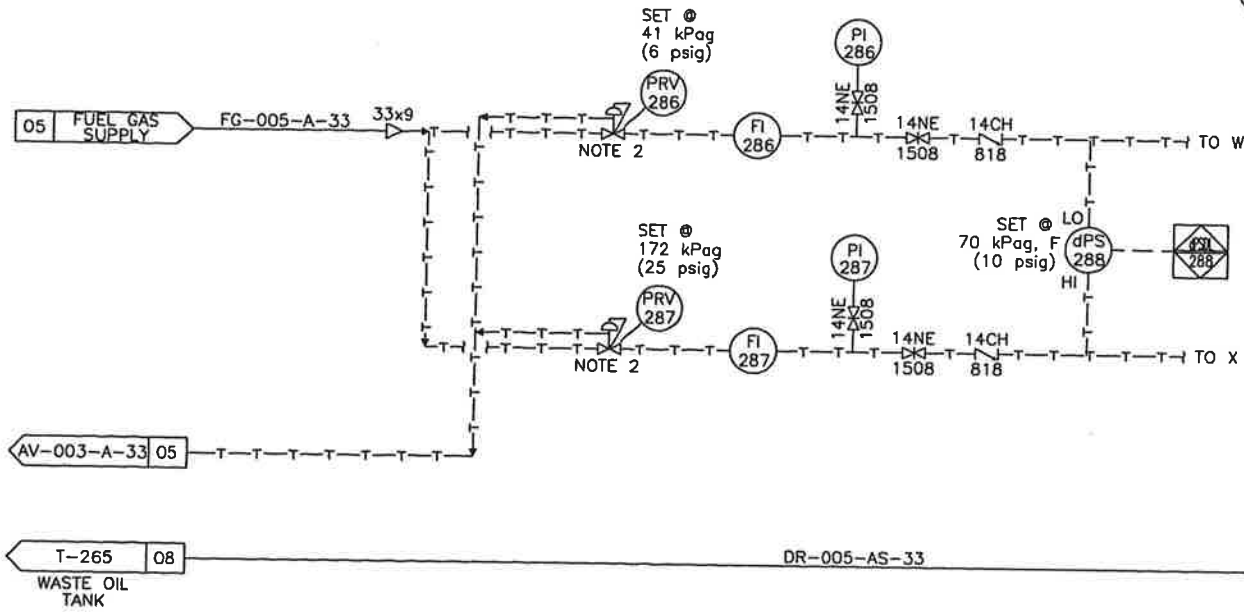
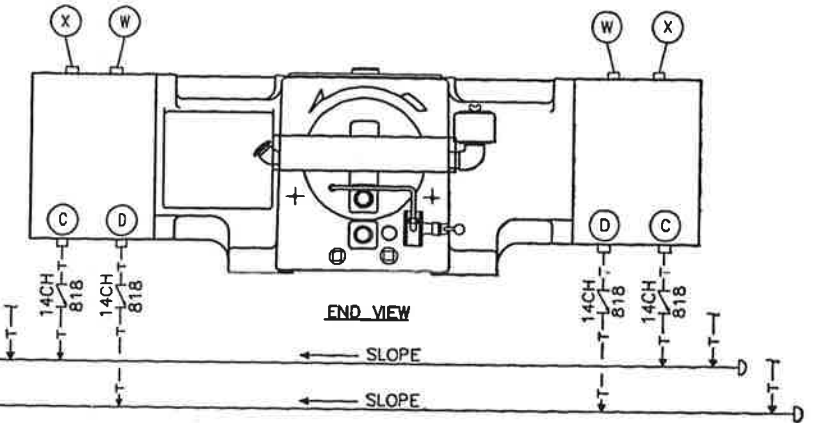
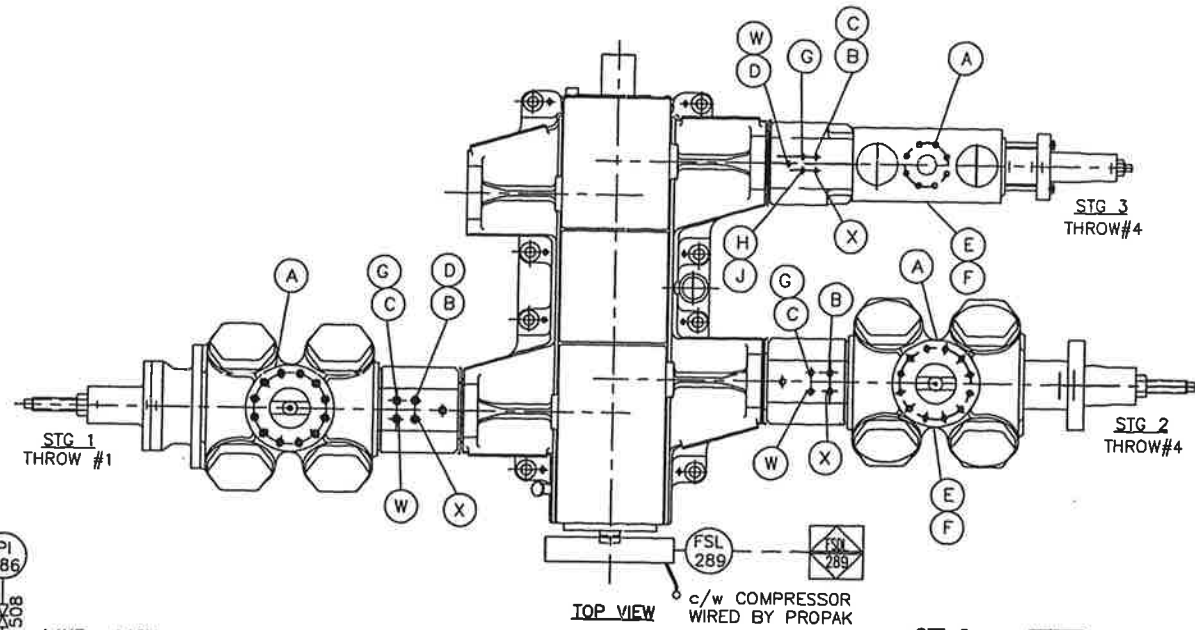
APPROVED		DRAWN	
MECH./STRUCT.	BY J. LINA	DATE	DEC. 08/99
ELECTRICAL	BY P. CRAWFORD	DATE	DEC. 30/99
PROJECT	P. CRAWFORD	DATE	DEC. 30/99
DATE	DEC. 30/99	SCALE	

APACHE CANADA LIMITED	
1478 HP HAMBURG COMPRESSOR PACKAGE	
SOUR GAS COMPRESSOR-COMPRESSOR FRAME OIL & GLYCOL	
MECHANICAL FLOWSHEET	
DWG. No.: D-MFS-99404-100	SHT. 8 OF 11
REV. 5	

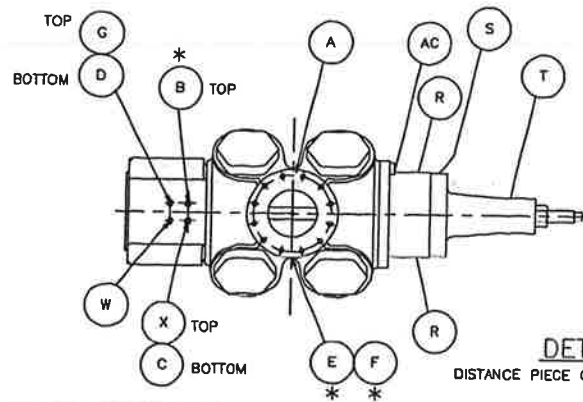
PROPAC
 440 East Lake Road,
 Postal Bag #2
 Airdrie, Alberta
 Canada T4B 2C3

THE DESIGN IT COVERS ARE CONFIDENTIAL AND THE PROPERTY OF PROPAK SYSTEMS LTD., AND SHALL NOT BE DISCLOSED TO OTHERS OR REPRODUCED IN ANY MANNER OR USED FOR ANY PURPOSE WHATSOEVER EXCEPT BY WRITTEN CONSENT OF PROPAK.

T-130
PACKING VENT & DRAIN SEAL POT
 273mm O.D. x 813mm S/S
 101 kPag DESIGN



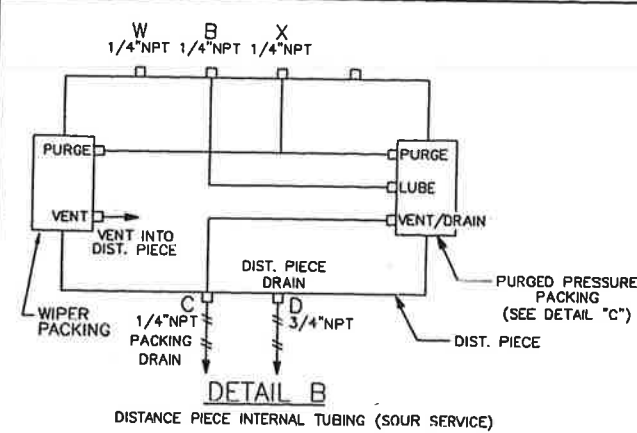
DISTANCE PIECE EVACUATION SYSTEM



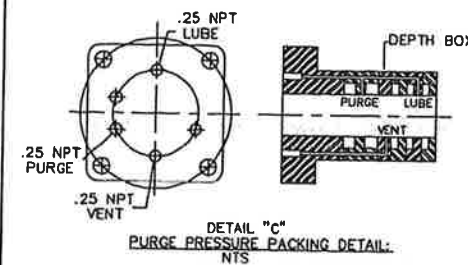
- A) FLANGE CONN-INLET TOP & DISCHARGE BOTTOM.
- * B) 1/4" NPT PACKING LUBE CONN.-TOP.
- C) 1/4" NPT PACKING VENT/DRAIN CONN.-BOTTOM
- D) 3/4" NPT DISTANCE PIECE DRAIN CONN.-BOTTOM.
- * E) 1/4" NPT CYL BORE LUBE CONN.-TOP.
- * F) 1/4" NPT CYL BORE LUBE CONN.-BOTTOM.
- G) 3/4" NPT YOKE VENT CONN.-TOP.
- R) 1/8" NPT VVCP HEAD VENT TO NON-HAZARDOUS AREA-TOP OR BOTTOM.
- S) 1/8" NPT VVCP ROD PKG. VENT TO NON-HAZARDOUS AREA -TOP OR BOTTOM.
- T) 1/8" NPT GREASE FITTING.
- W) 1/4" NPT DISTANCE PIECE PURGE-TOP.
- X) 1/4" NPT PACKING PURGE CONN.-TOP.

NOTE: PROPAK COMP. SERVICEMAN TO DOUBLE CHECK LOCATIONS OF (A-X) PRIOR TO HOOK-UP.
 * BY DRESSER-RAND

DETAIL A
 DISTANCE PIECE CONNECTIONS (TYPICAL)



DETAIL B
 DISTANCE PIECE INTERNAL TUBING (SOUR SERVICE)



1. CHECK VALVES TO BE ADDED TO 'C' AND 'D' CYLINDER CONNECTION POINTS AS CLOSE TO DISTANCE PIECE AS POSSIBLE ON EACH CYLINDER.
2. INTERNAL TUBING TO BE INSPECTED BY PROPAK SERVICE, PRIOR TO HOOKING UP.

DATE: 2000.10.25 1:32pm FILE NAME: J:\jobs99\DWG\99404\FLW\MFS-99404-100-09.dwg

GENERAL NOTES

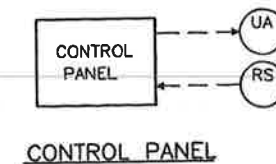
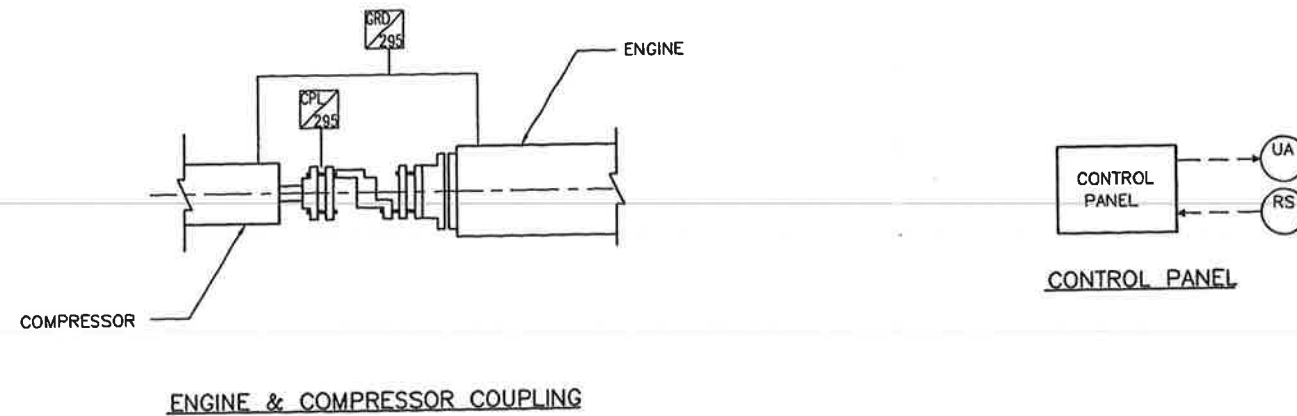
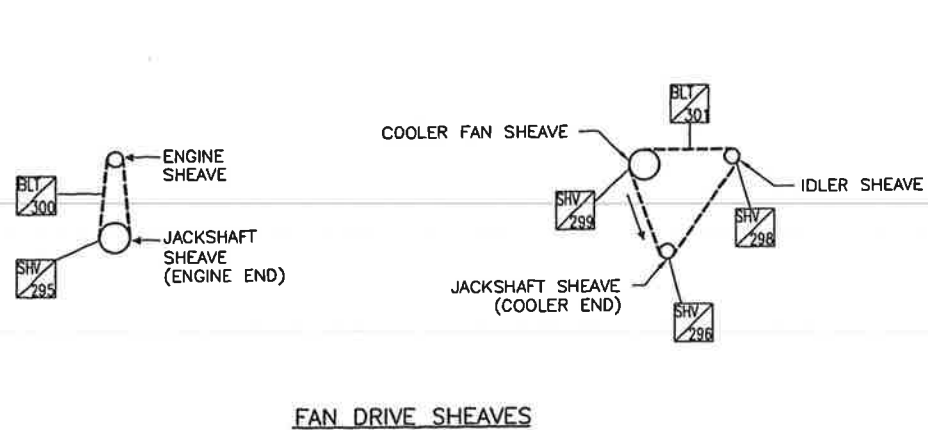
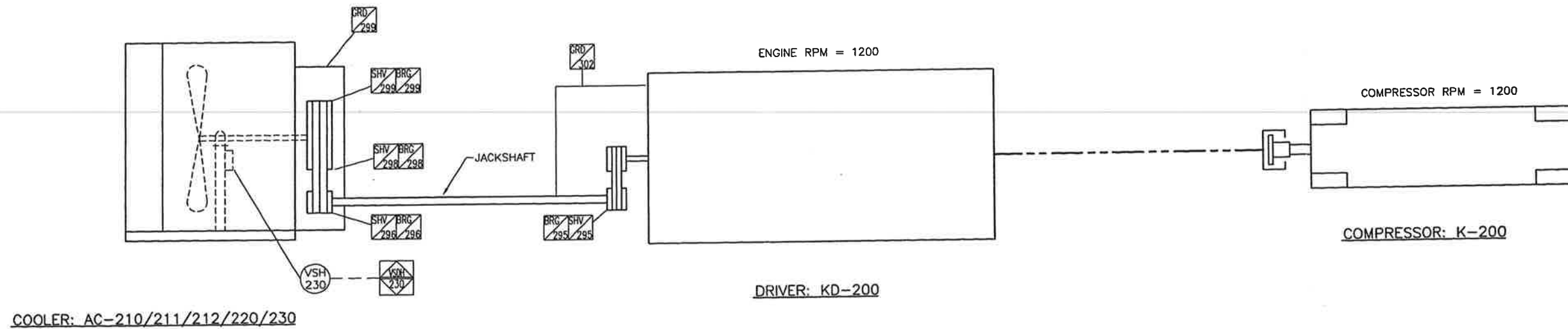
No.	REVISION	BY	DATE	CKD	ENG
5	AS BUILT- PER CLIENT REVISIONS	H. LE	00/10/25	AL	diw
4	CLIENT REVISIONS	H. LE	00/09/21	GW	GW
3	AS BUILT	H. LE	00/08/25	CG	CG
2	RE-ISSUED FOR CONSTRUCTION	H. LE	00/06/06	SW	SW
1	ISSUED FOR CONSTRUCTION	S. SULZ	99/12/30	PC	PC
A	ISSUED FOR APPROVAL	J. LINA	99/12/08	DHS	DHS

APPROVED		DRAWN	
MECH./STRUCT.	BY	J. LINANTUD	
DATE	DATE	DEC. 08/99	
ELECTRICAL	CHECKED		
DATE	BY	P. CRAWFORD	
PROJECT	DATE	DEC. 30/99	
DATE	SCALE		

APACHE CANADA LIMITED
 1478 HP HAMBURG COMPRESSOR PACKAGE
 CYLINDER & PACKING LUBRICATION
 MECHANICAL FLOWSHEET

PROPAK
 440 East Lake Road,
 Postal Bag #2
 Airdrie, Alberta
 Canada T4B 2C3

TO OTHERS OR REPRODUCED IN ANY MANNER OR USED FOR ANY PURPOSE WHATSOEVER EXCEPT BY WRITTEN CONSENT OF PROPAC



GENERAL NOTES		GENERAL NOTES	
No.	REVISION	No.	REVISION
5	AS BUILT- PER CLIENT REVISIONS	5	AS BUILT- PER CLIENT REVISIONS
4	CLIENT REVISIONS	4	CLIENT REVISIONS
3	AS BUILT	3	AS BUILT
2	RE-ISSUED FOR CONSTRUCTION	2	RE-ISSUED FOR CONSTRUCTION
1	ISSUED FOR CONSTRUCTION	1	ISSUED FOR CONSTRUCTION
A	ISSUED FOR APPROVAL	A	ISSUED FOR APPROVAL

BY	DATE	CKD	ENG
H. LE	00/10/25	ALW	AW
H. LE	00/09/21	GW	GW
H. LE	00/08/25	CG	CG
H. LE	00/06/06	SW	SW
J. LINA	99/12/30	PC	PC
J. LINA	99/12/10	DHS	DHS

APPROVED		DRAWN	
MECH/STRUCT.	DATE	BY	DATE
		J. LINANTJUD	DEC. 10/99
ELECTRICAL <td></td> <td>CHECKED</td> <td></td>		CHECKED	
		P. CRAWFORD	DEC. 30/99
PROJECT	P. CRAWFORD	DATE	DEC. 30/99
DATE	DEC. 30/99	SCALE	

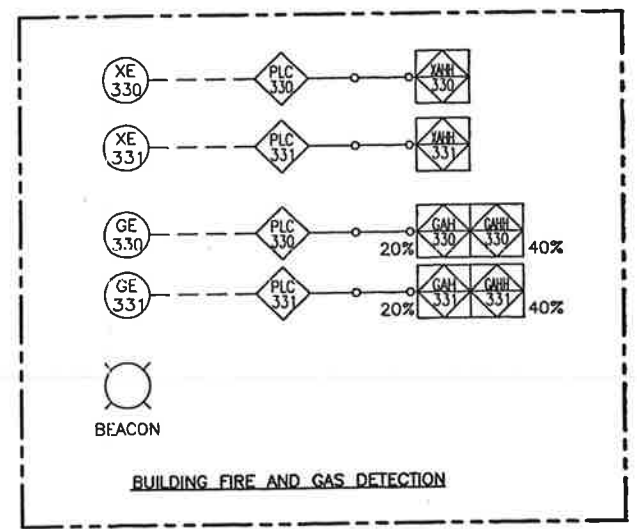
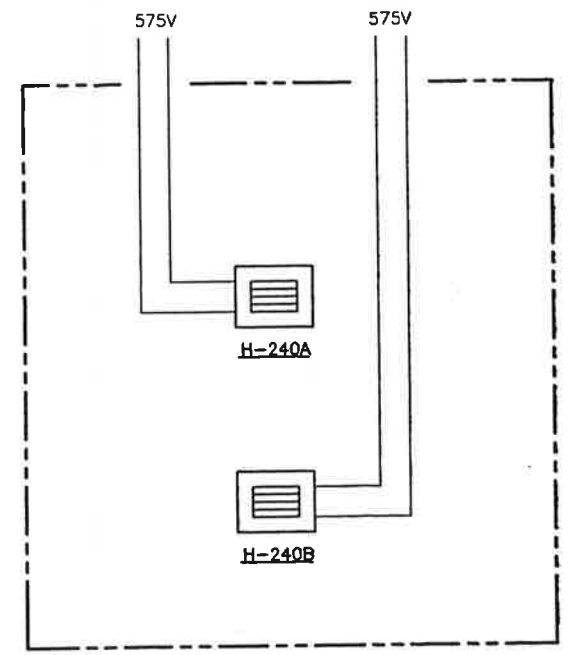
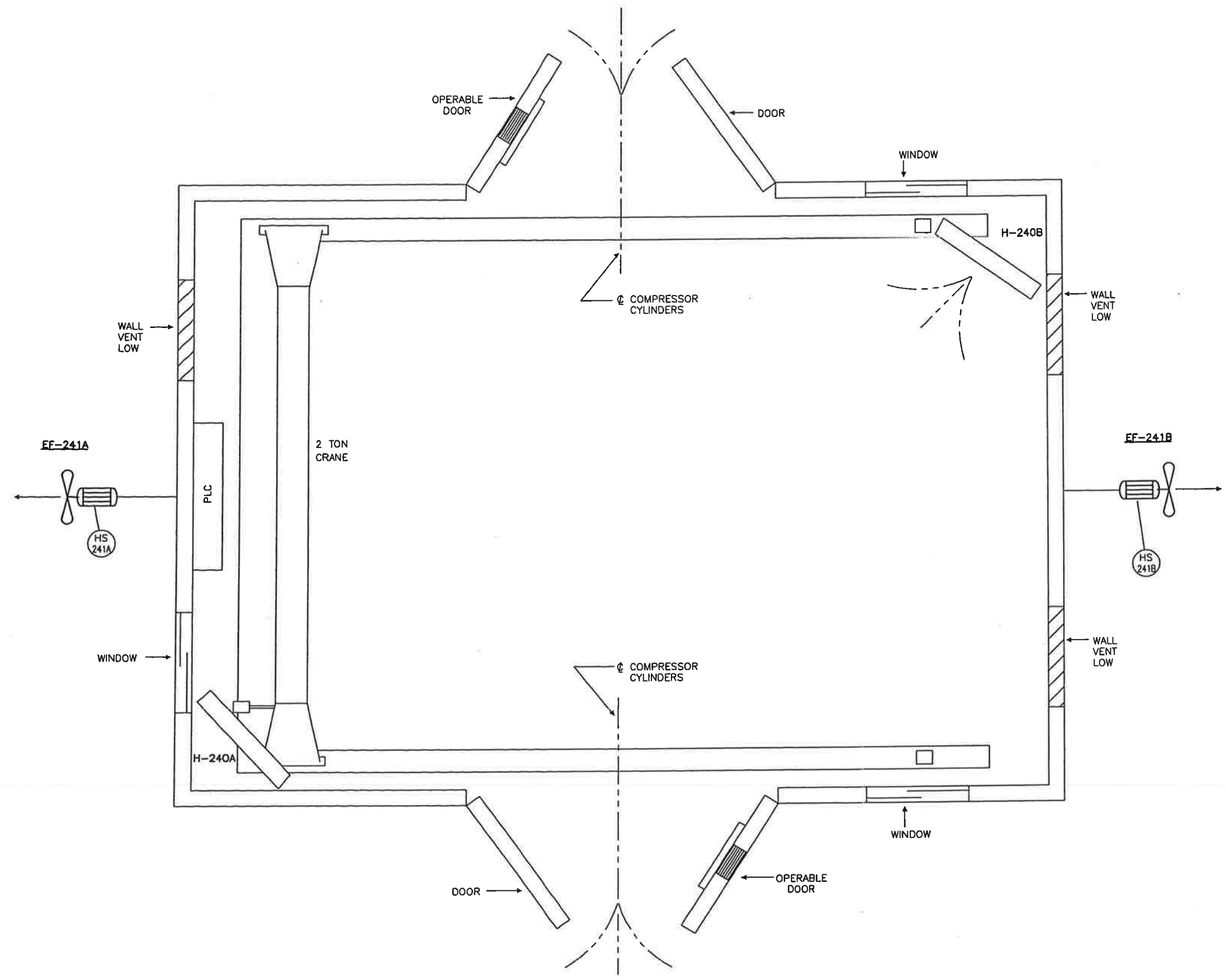
APACHE CANADA LIMITED	
1478 HP HAMBURG COMPRESSOR PACKAGE	
CONTROL PANEL, COUPLING AND DRIVE DETAILS	
MECHANICAL FLOWSHEET	
DWG. No.: D-MFS-99404-100	SHT. 10 OF 11 REV. 5

PROPAK
 440 East Lake Road,
 Postal Bag #2
 Aldrie, Alberta
 Canada T4B 2C3

THE DESIGN IT COVERS ARE CONFIDENTIAL AND THE PROPERTY OF PROPAK SYSTEMS LTD., AND SHALL NOT BE DISCLOSED TO OTHERS OR REPRODUCED IN ANY MANNER OR USED FOR ANY PURPOSE WHATSOEVER EXCEPT BY WRITTEN CONSENT OF PROPAK.

EF-241A/B
EXHAUST FAN
 M/N: ET-12-2
 XP: 120/1/60

H-240A/B
BUILDING HEATERS
 RUFFNECK XL 416-575360-15 kW



GENERAL NOTES		GENERAL NOTES	
No.	REVISION	No.	REVISION
5	AS BUILT - PER CLIENT REVISIONS	5	AS BUILT - PER CLIENT REVISIONS
4	CLIENT REVISIONS	4	CLIENT REVISIONS
3	AS BUILT	3	AS BUILT
2	RE-ISSUED FOR CONSTRUCTION	2	RE-ISSUED FOR CONSTRUCTION
1	ISSUED FOR CONSTRUCTION	1	ISSUED FOR CONSTRUCTION
A	ISSUED FOR APPROVAL	A	ISSUED FOR APPROVAL

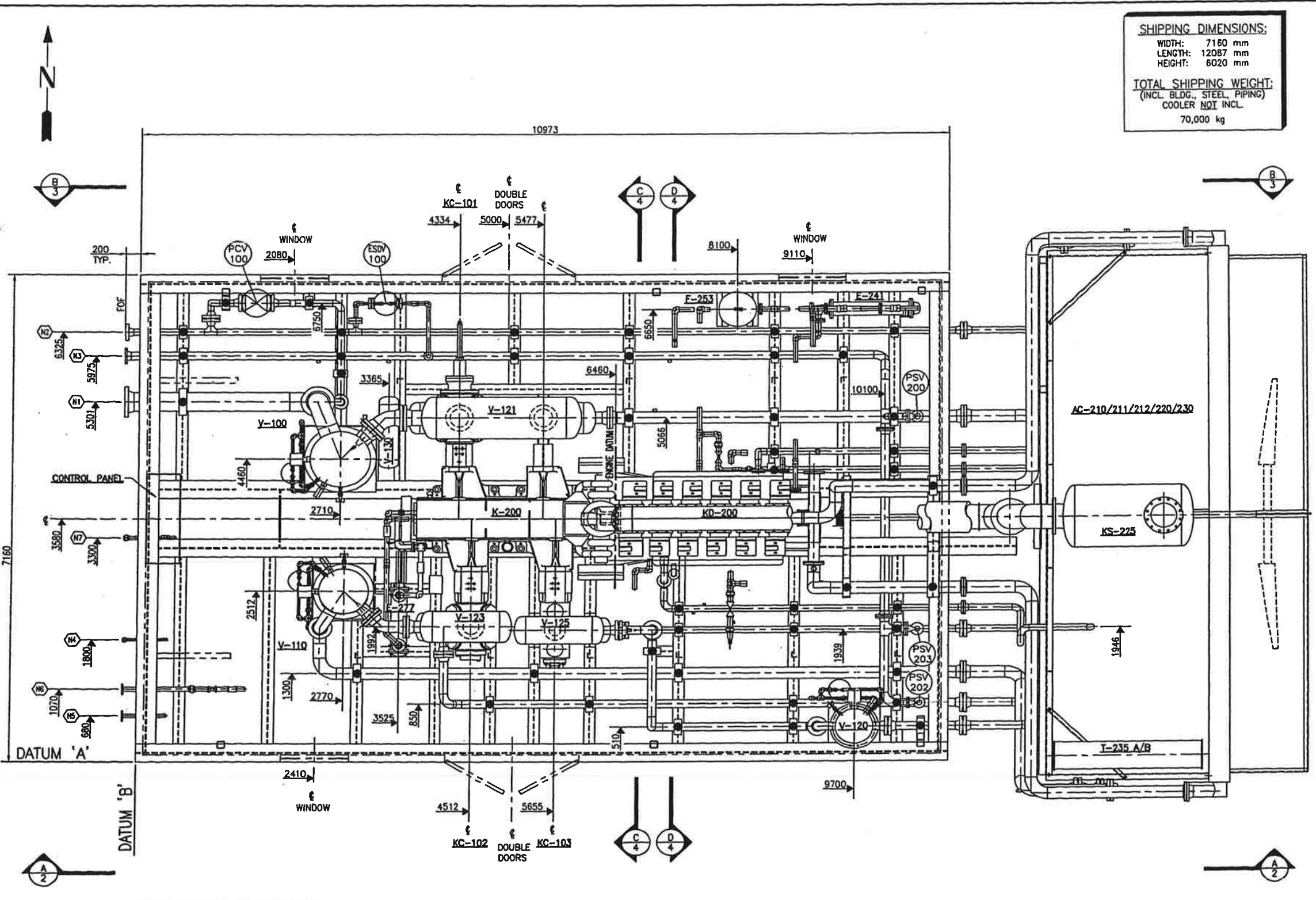
BY	DATE	CHKD	ENG
J. LINA	00/10/25	JLW	JLW
H. LE	00/09/21	GW	GW
H. LE	00/08/25	CG	CG
H. LE	00/06/06	SW	SW
J. LINA	99/12/30	PC	PC
J. LINA	99/12/10	DHS	DHS

APPROVED		DRAWN	
MECH./STRUCT.	DATE	BY	DATE
		J. LINANTUO	DEC. 10/99
ELECTRICAL		CHECKED	
		P. CRAWFORD	DEC. 30/99
PROJECT	P. CRAWFORD	DATE	DEC. 30/99
DATE	DEC. 30/99	SCALE	

APACHE CANADA LIMITED	
1478 HP HAMBURG COMPRESSOR PACKAGE	
BUILDING UTILITIES	
MECHANICAL FLOWSHEET	
DWG. No.: D-MFS-99404-100	SHT. 11 OF 11 REV. 5

PROPAK
 440 East Lake Road,
 Postal Bag #2
 Airdrie, Alberta
 Canada T4B 2C3

THIS DRAWING AND THE DESIGN IT COVERS ARE CONFIDENTIAL AND THE PROPERTY OF PROPAG SYSTEMS LTD., AND SHALL NOT BE DISCLOSED OR REPRODUCED IN ANY MANNER OR USED FOR ANY PURPOSE WHATSOEVER EXCEPT BY WRITTEN CONSENT OF PROPAG.



SHIPPING DIMENSIONS:
 WIDTH: 7160 mm
 LENGTH: 12087 mm
 HEIGHT: 6020 mm

TOTAL SHIPPING WEIGHT:
 (INCL. BLDG., STEEL, PIPING)
 COOLER NOT INCL.
 70,000 kg

NOZZLE SCHEDULE					
MK	SIZE	RATING	FACING	SERVICE	ELEVATION
N1	273	300#	RFWN	INLET	-426
N2	89	900#	RFWN	OUTLET	-518
N3	114	150#	RFWN	FLARE	-505
N4	33	3000#	UNION	HCL DRAIN	-150
N5	60	150#	RFSW	CLEAN FUEL GAS SUPPLY	-150
N6	60	150#	RFSW	CLEAN START GAS SUPPLY	-150
N7	48	3000#	UNION	WASTE OIL PUMP OUT	-150

⊕ ELEVATIONS ARE FROM T.O. WF

MAJOR COMPONENTS		WEIGHTS:
COMPRESSOR:	DRESSER RAND 6HOS 4 THROW, 3 STAGE	8390 kg (INCL. CYLINDERS)
DRIVER:	WAUKESHA L7042GL	9525 kg
COOLER:	AERIAL COOLER PROPAG 1-SV-1-156-312-F	20700 kg
SCRUBBERS:		
V-100	1st STG.: 813ø x 1930 S/S x 4516 kPag	1842 kg
V-110	2nd STG.: 660ø x 1626 S/S x 4516 kPag	1080 kg
V-120	3rd STG.: 508ø x 1473 S/S x 9067 kPag	816 kg
BOTTLES:		
STAGE #1		
V-121	SUCTION: 610ø x 1778 S/S x 4516 kPag	797 kg
V-122	DISCHARGE: 457ø x 2235 S/S x 4447 kPag	586 kg
STAGE #2		
V-123	SUCTION: 457ø x 914 S/S x 4516 kPag	301 kg
V-124	DISCHARGE: 406ø x 1016 S/S x 8908 kPag	460 kg
STAGE #3		
V-125	SUCTION: 406ø x 914 S/S x 9067 kPag	402 kg
V-126	DISCHARGE: 356ø x 1016 S/S x 11377 kPag	393 kg

UNBALANCED INERTIA FORCES ON FOUNDATION

FOUNDATION MUST BE DESIGNED TO RESIST THE FOLLOWING FORCES:

MAXIMUM HORIZONTAL PRIMARY FORCES	347 LBS
MAXIMUM HORIZONTAL SECONDARY FORCES	82 LBS
MAXIMUM VERTICAL PRIMARY FORCES	0 LBS
MAXIMUM VERTICAL SECONDARY FORCES	0 LBS

MAXIMUM HORIZONTAL PRIMARY MOMENT (ABT. AXIS Z-Z) 14,422 FT-LBS
 MAXIMUM HORIZONTAL SECONDARY MOMENT (ABT. AXIS Z-Z) 1118 FT-LBS
 MAXIMUM VERTICAL PRIMARY MOMENT (ABT. AXIS Y-Y) 25,157 FT-LBS
 MAXIMUM VERTICAL SECONDARY MOMENT (ABT. AXIS Y-Y) 0 FT-LBS

ABOVE UNBALANCED FIGURED AT 1200 RPM. 2 LB. MAX. IMBALANCE
 AT OTHER SPEEDS THIS UNBALANCED WILL VARY BY: $(\frac{\text{NEW SPEED}}{\text{CALCULATED SPEED}})^2$

NOTED 1: MOMENT TAKEN ABOUT AXIS THROUGH CENTER OF SHAFT FORCES AS ACTING ON CENTER OF SHAFT.
 NOTED 2: PRIMARY FORCES AND THE MOMENTS CHANGE FROM ZERO TO MAXIMUM GIVEN ABOVE TO ZERO TO SAME MAXIMUM IN REVERSE DIRECTION AND BACK TO ZERO ONCE IN A CRANKSHAFT REVOLUTION. SECONDARY FORCES AND MOMENTS GO THROUGH THIS CYCLE TWICE IN A REVOLUTION. THE SKETCH SHOWS THIS.

NOTED 3: UNIT ORIGIN IS ⊕ DATUM INTERSECTION ⊕ TOP OF SHED
 NOTED 4: UNIT APPROX. CENTRE OF GRAVITY: (X,Y,Z) = (SEE LIFTING DIAGRAM INT.2)

CLAMPING LEGEND
 ● DENOTES HEAVY DUTY CLAMP

PLAN VIEW

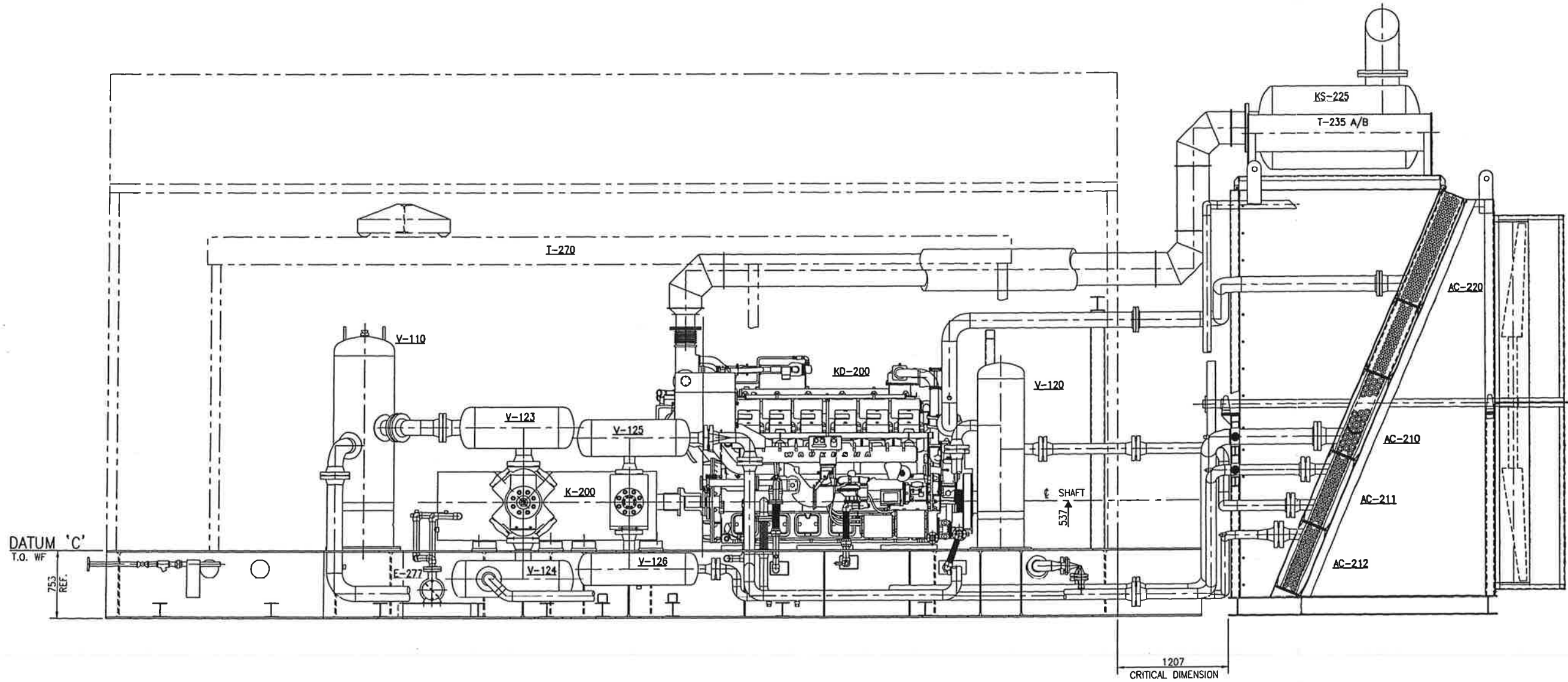
GENERAL NOTES		GENERAL NOTES		REVISION		APPROVED		DRAWN	
4	UNBALANCED FORCES REV'D.	D. SMITH	00/09/21					BY	S. FARWELL
3	ADDED TAG #S TO VESSEL DESCRIPTIONS	S. BRODIE	00/09/01	M.A.	S.W.	DATE	00/01/19	DATE	00/01/19
2	RE-DESIGNED	S. FARWELL	00/05/29	M.I.	S.W.	DATE	00/02/24	CHECKED	
1	ISSUED FOR CONTRUCTION	S. FARWELL	00/02/24	M.I.	T.X.	PROJECT	T. KELLER	BY	M. IWANIUK
				BY	DATE	CKD	ENG	DATE	00/02/24
								SCALE	1:30

PROPAG
 1478 HP STOCK COMPRESSOR PACKAGE
 W1478, 6 HOS 3
 LAYOUT-PLAN VIEW

DWG. No. D-ASY-99404-152 SHEET 1 OF 4 REV. 4

440 East Lake Road,
 Postal Bag #2
 Airdrie, Alberta
 Canada T4B 2C3

THE DESIGN IT COVERS ARE CONFIDENTIAL AND THE PROPERTY OF PROPAK SYSTEMS LTD. AND SHALL NOT BE DISCLOSED TO OTHERS OR REPRODUCED IN ANY MANNER OR USED FOR ANY PURPOSE WHATSOEVER EXCEPT BY WRITTEN CONSENT OF PROPAK



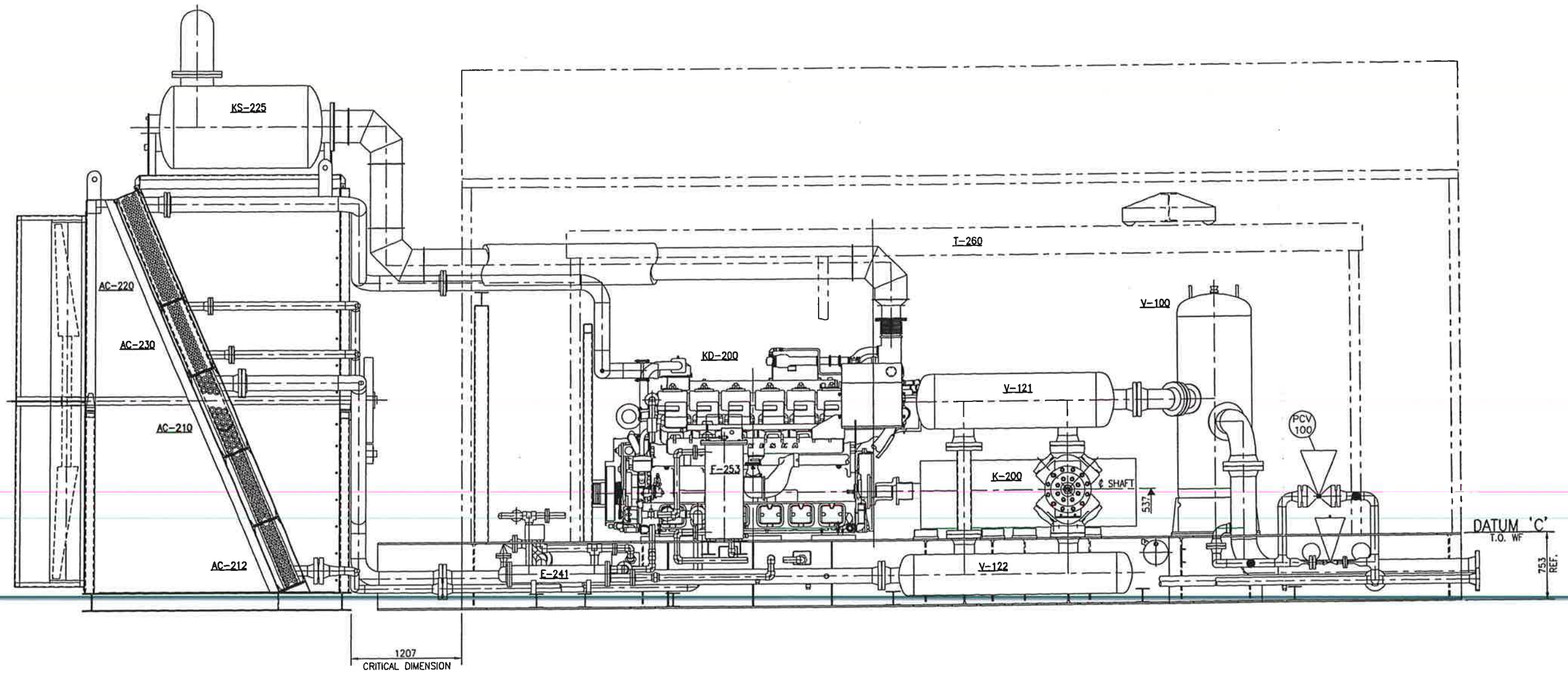
VIEW 'A-A'

GENERAL NOTES	GENERAL NOTES	No.	REVISION	BY	DATE	CKD	ENG
		2	RE-DESIGNED	S.FARWELL	00/05/29	M.L.	S.W.
		1	ISSUED FOR CONSTRUCTION	S.FARWELL	00/02/24	M.L.	T.K.

APPROVED		DRAWN	
MECH./STRUCT.	BY S.FARWELL	BY S.FARWELL	DATE 00/01/19
DATE		DATE	00/02/24
ELECTRICAL	BY M.IWANIUK	BY M.IWANIUK	DATE 00/02/24
DATE		DATE	00/02/24
PROJECT	T.KELLER	DATE	00/02/24
DATE	00/02/24	SCALE	1:25

PROPAK		1478 HP STOCK COMPRESSOR PACKAGE LAYOUT (VIEW 'A-A')	
DWG. No.:	D-ASY-99404-152	SHEET 2 OF 4	REV. 2

PROPAK
 440 East Lake Road,
 Postal Bag #2
 Airdrie, Alberta
 Canada T4B 2C3

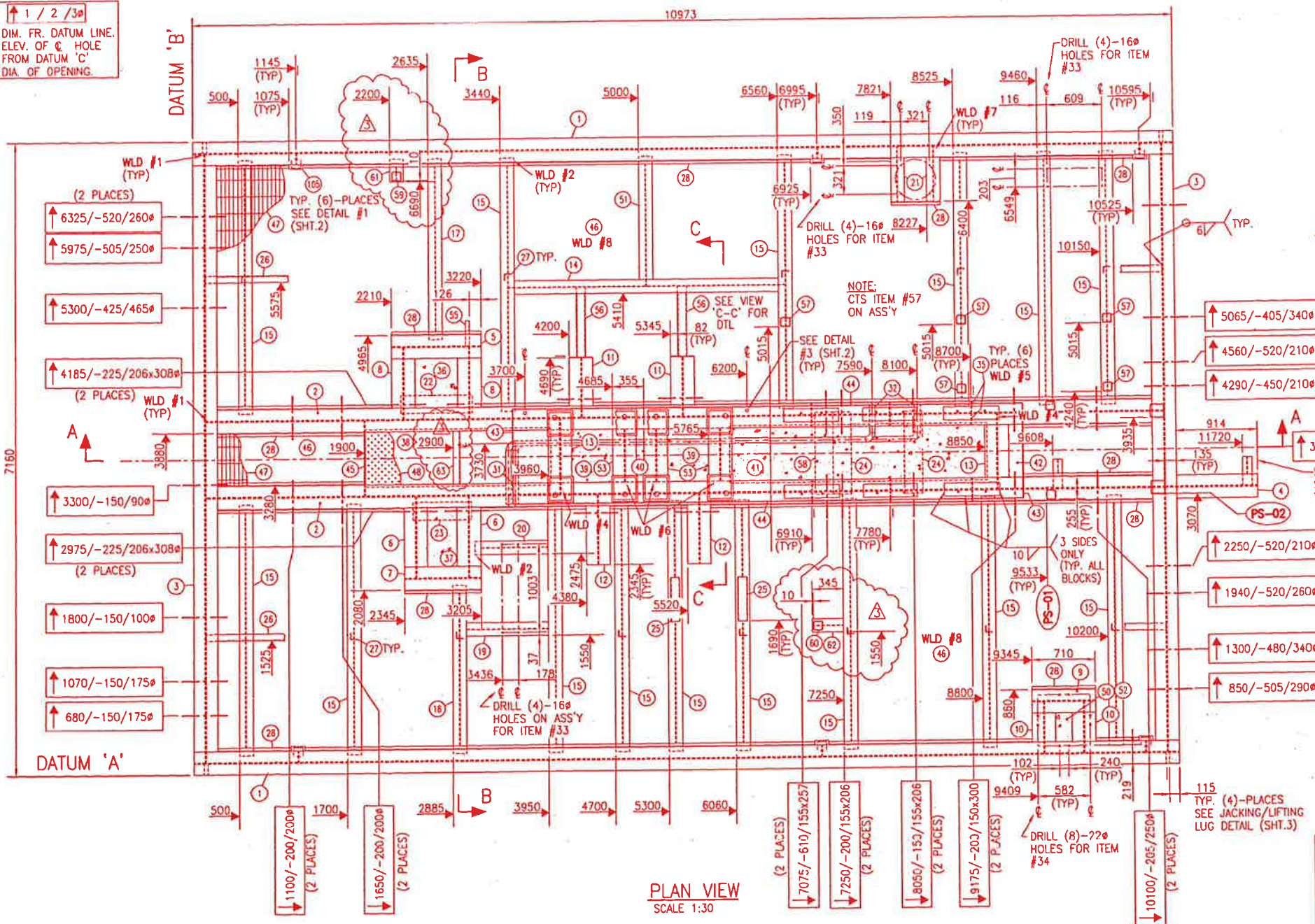


VIEW 'B-B'

GENERAL NOTES		GENERAL NOTES		2 RE-DESIGNED		S.FARWELL 00/05/29 M.L. S.W.		APPROVED		DRAWN		PROPAC		440 East Lake Road,	
		1 ISSUED FOR CONSTRUCTION		1		S.FARWELL 00/02/24 M.L. T.K.		MECH./STRUCT.		BY S.FARWELL		1478 HP STOCK COMPRESSOR PACKAGE		Postal Bag #2	
								DATE		DATE 00/01/19		LAYOUT		Airdrie, Alberta	
								ELECTRICAL		CHECKED		(VIEW 'B-B')		Canada T4B 2C3	
								PROJECT T.KELLER		BY M.IWANIUK		DWG. No.: D-ASY-99404-152		SHEET 3 OF 4	
								DATE 00/02/24		DATE 00/02/24		REV. 2			
								SCALE 1:25							

THIS DRAWING AND THE DESIGN IT COVERS ARE CONFIDENTIAL AND THE PROPERTY OF PROPAK SYSTEMS LTD., AND SHALL NOT BE DISCLOSED TO OTHERS OR REPRODUCED IN ANY MANNER OR USED FOR ANY PURPOSE WHATSOEVER EXCEPT BY WRITTEN CONSENT OF PROPAK.

- 1 / 2 / 3
- DIM. FR. DATUM LINE.
 - ELEV. OF C HOLE FROM DATUM 'C'
 - DIA. OF OPENING.

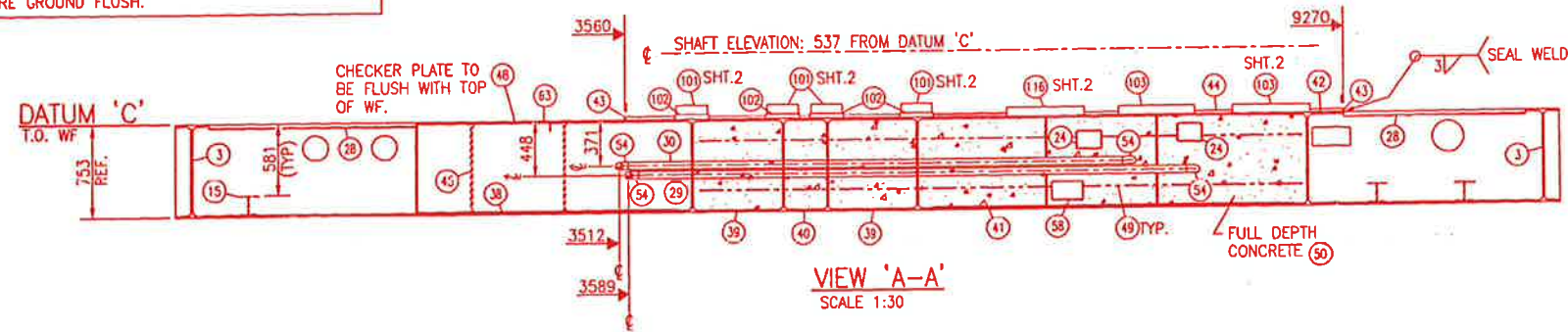


JACKSHAFT SLOT DETAIL
SCALE 1:25

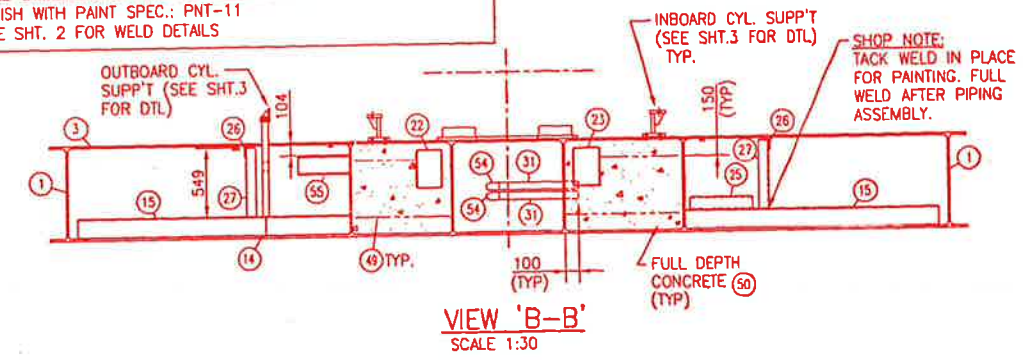
PLAN VIEW
SCALE 1:30

- SHOP NOTES:**
- 9mm ALLOWED FOR SHIMMING ENGINE
 - ALL RE-BAR TO BE SPACED AT 300 mm CENTERS.
 - SHOP TO ENSURE THAT ALL WELDS ON BOTTOM OF SKID ARE GROUND FLUSH.

- GENERAL NOTES:**
- APPROX. WEIGHT OF SKID: STEEL: 21,950 KG
(NOT INCL. CRANE) CONCRETE: 9400 KG
 - COPE MEMBERS WHERE SHOWN.
 - CUT LENGTHS ARE EXACT WITH TOLERANCE OF +0/-3
 - ALL WELDS TO BE 6 mm CONTINUOUS FILLET USING E-7018 OR E-70-T SEMI-AUTOMATIC ELECTRODES UNLESS NOTED OTHERWISE.
 - REMOVE ALL SHARP EDGES AND BURRS.
 - DRILL ALL HOLES <math>< 3/8\text{ inch}</math>, FLAME CUT LARGER HOLES.
 - ALL DIMENSIONS ARE IN MILLIMETRES.
 - FINISH WITH PAINT SPEC.: PNT-11
 - SEE SHT. 2 FOR WELD DETAILS



VIEW 'A-A'
SCALE 1:30



VIEW 'B-B'
SCALE 1:30

BILL OF MATERIAL			
ITEM	QUA	DESCRIPTION	
1	2	W760 x 147 x 10973 LG.	G40.21M-300W
2	2	W760 x 147 x 10695 LG.	G40.21M-300W
3	2	W760 x 147 x 6890 LG.	G40.21M-300W
4	1	W760 x 147 x 1040 LG.	G40.21M-300W
5	1	W760 x 147 x 1010 LG.	G40.21M-300W
6	2	W760 x 147 x 920 LG.	G40.21M-300W
7	1	W760 x 147 x 860 LG.	G40.21M-300W
8	2	W760 x 147 x 805 LG.	G40.21M-300W
9	1	W760 x 147 x 710 LG.	G40.21M-300W
10	2	W760 x 147 x 580 LG.	G40.21M-300W
11	2	W760 x 147 x 670 LG.	G40.21M-300W
12	2	W760 x 147 x 795 LG.	G40.21M-300W
13	2	W760 x 147 x 850 LG.	G40.21M-300W
14	1	W150 x 22 x 3114 LG.	G40.21M-300W
15	15	W150 x 22 x 2900 LG.	G40.21M-300W
16			G40.21M-300W
17	1	W150 x 22 x 2080 LG.	G40.21M-300W
18	1	W150 x 22 x 1965 LG.	G40.21M-300W
19	1	W150 x 22 x 913 LG.	G40.21M-300W
20	1	W150 x 22 x 820 LG.	G40.21M-300W
21	2	W150 x 22 x 620 LG.	G40.21M-300W
22	1	HSS: 203 x 305 x 6 THK. x 810 LG.	G40.21M-350W
23	1	HSS: 203 x 305 x 6 THK. x 660 LG.	G40.21M-350W
24	2	HSS: 152 x 203 x 6 THK. x 930 LG.	G40.21M-350W
25	2	HSS: 102 x 102 x 6 THK. x 500 LG.	G40.21M-350W
26	2	L 76 x 76 x 6 THK. x 10695 LG.	G40.21M-300W
27	12	L 76 x 76 x 6 THK. x 543 LG.	G40.21M-300W
28	1	L 38 x 38 x 6 THK. x 50000 LG. (CTS)	G40.21M-300W
29	1	PIPE: 60 O/D x 5.54 W.T. x 4353 LG.	SMLS SA-106-B
30	1	PIPE: 60 O/D x 5.54 W.T. x 3920 LG.	SMLS SA-106-B
31	2	PIPE: 60 O/D x 5.54 W.T. x 690 LG.	SMLS SA-106-B
32	2	PIPE: 60 O/D x 5.54 W.T. x 390 LG.	SMLS SA-106-B
33	12	BOLTS: 13/8 x 51 LG. c/w (1) HEX NUT EACH (ZINC COATED)	SA-325
34	8	BOLTS: 19/8 x 64 LG. c/w (1) HEX NUT EACH (ZINC COATED)	SA-325
35	12	PLATE: 13 THK. x 125 x 716 LG.	SA-36
36	1	PLATE: 6 THK. x 480 x 555 LG.	SA-36
37	1	PLATE: 6 THK. x 330 x 670 LG.	SA-36
38	1	PLATE: 6 THK. x 650 x 2085 LG.	SA-36
39	2	PLATE: 6 THK. x 460 x 600 LG.	SA-36
40	1	PLATE: 6 THK. x 90 x 600 LG.	SA-36
41	1	PLATE: 6 THK. x 650 x 2870 LG.	SA-36
42	1	PLATE: 6 THK. x 155 x 600 LG.	SA-36
43	2	F/BAR: 6 THK. x 25 x 1110 LG.	G40.21M-300W
44	2	F/BAR: 6 THK. x 25 x 5695 LG.	G40.21M-300W
45	2	PLATE: 13 THK. x 753 x 850 LG. (CTS)	SA-36
46	2	SEAL PLATE: 5 THK. x 2750 x 11050 LG.	SA-36
47	1	GRATING: 32 x 5 (19-4) x 914 WD. x 73200 LG. (CTS)	C.S.
48	1	CHK'R PLATE: 6 THK. x 600 x 2055 LG.	SA-36
49	30m	REBAR: 15M	GRADE 300
50	3.9m3	CONCRETE: 20 MPa	
51	1	W150 x 22 x 1408 LG.	G40.21M-300W
52	1	PLATE: 6 THK. x 180 x 330 LG.	SA-36
53	3	W760 x 147 x 600 LG.	G40.21M-300W
54	4	ELBOW: 60 O/D 90° LR SCH 80 BW	SMLS SA-234-WPB
55	1	C 150 x 16 x 280 LG.	G40.21M-300W
56	2	HSS: 102 x 102 x 6 THK. x 783 LG.	G40.21M-350W
57	5	HSS: 102 x 102 x 6 THK. x 100 LG.	G40.21M-350W
58	1	HSS: 152 x 254 x 6 THK. x 930 LG.	G40.21M-350W
59	1	HSS: 102 x 102 x 6 THK. x 247 LG.	G40.21M-350W
60	1	HSS: 102 x 102 x 6 THK. x 307 LG.	G40.21M-350W
61	1	W150 x 22 x 280 LG.	G40.21M-300W
62	1	W150 x 22 x 345 LG.	G40.21M-300W
63	1	L 76 x 76 x 6 THK. x 600 LG.	G40.21M-300W

GENERAL NOTES

GENERAL NOTES

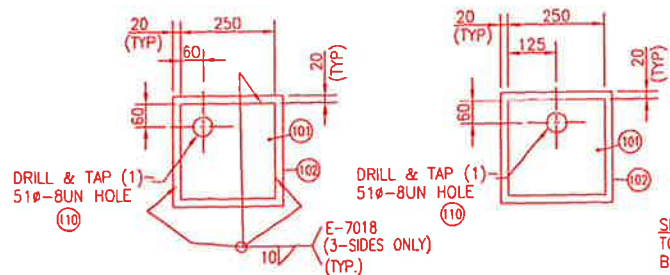
No.	REVISION	BY	DATE	CKD	ENG
3	ADDED ITEMS #59 THRU #63	S.FARWELL	00/05/29	M.L.	S.W.
2	ADDED JACKING/LIFTING LUG LOCATIONS/MOVED JACKSHAFT SUPPORT LOCATIONS	S.FARWELL	00/05/17	S.L.	S.W.
1	ISSUED FOR CONSTRUCTION	S.FARWELL	00/05/09	S.L.	S.W.

APPROVED		DRAWN	
MECH./STRUCT.	BY	S.FARWELL	
DATE	DATE	00/04/25	
ELECTRICAL	BY	CHECKED	
DATE	DATE	S.LESLIE	
PROJECT	DATE	00/05/09	
DATE	00/05/09	SCALE	AS NOTED

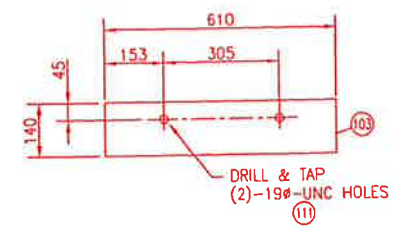
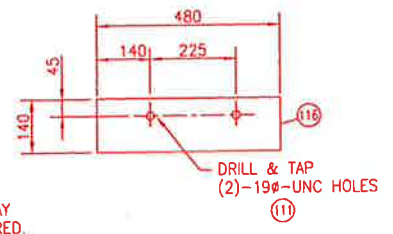
DWG. No.: D-SKD-99404-114A SHEET 1 OF 4 REV. 3

PROPAK
440 East Lake Road,
Postal Bag #2
Airdrie, Alberta
Canada T4B 2C3

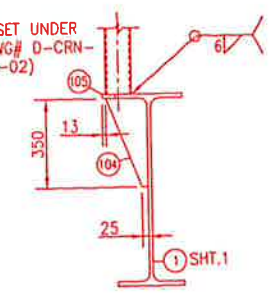
THIS DRAWING AND THE DESIGN IT COVERS ARE CONFIDENTIAL AND THE PROPERTY OF PROPAC SYSTEMS LTD. AND SHALL NOT BE DISCLOSED TO OTHERS OR REPRODUCED IN ANY MANNER OR USED FOR ANY PURPOSE WHATSOEVER EXCEPT BY WRITTEN CONSENT OF PROPAC.



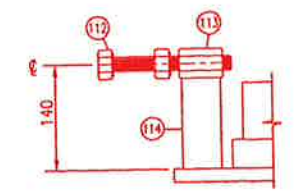
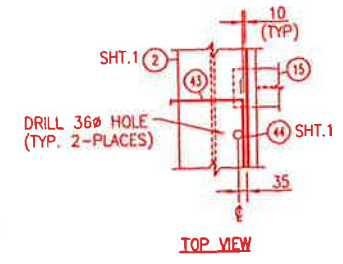
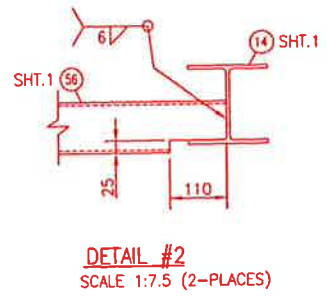
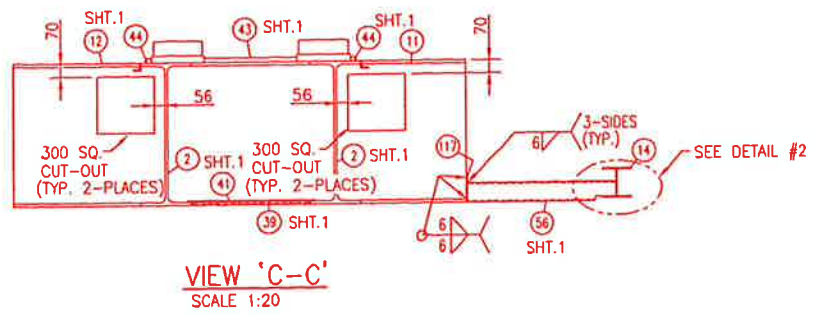
SHOP NOTE:
TOP SURFACE OF BLOCKS MAY BE MACHINED FLAT IF REQUIRED.



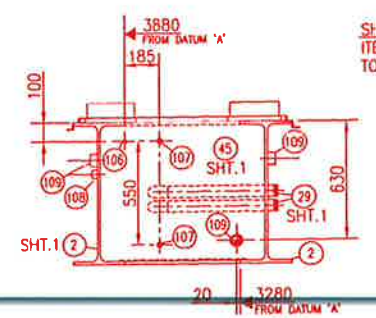
CENTER GUSSET UNDER HSS (SEE DWG# D-CRN-99404-114B-02)



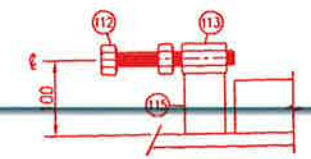
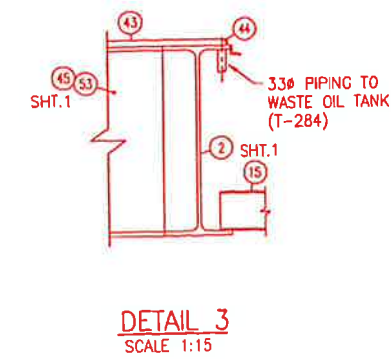
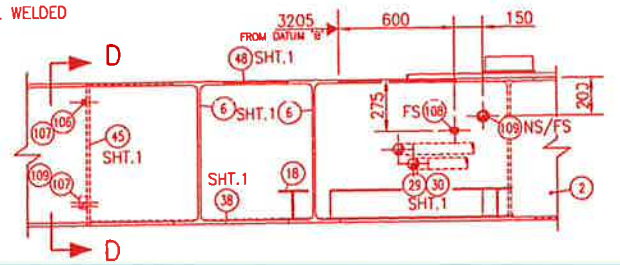
BILL OF MATERIAL		
ITEM	QUA	DESCRIPTION
101	8	PLATE: 76 THK. x 250 SQ. (SEE DETAIL)
102	8	PLATE: 38 THK. x 290 SQ.
103	4	PLATE: 70 THK. x 140 x 610 LG. (SEE DETAIL)
104	6	PLATE: 13 THK. x 163 x 350 LG. (CTS)
105	6	F/BAR: 16 THK. x 51 x 152 LG.
106	1	HALF CPLG: 14-3000# NPT
107	2	HALF CPLG: 21-3000# NPT
108	1	HALF CPLG: 33-3000# NPT
109	3	HALF CPLG: 48-3000# NPT
110	8	BOLTS: 51#-BUN x 159 LG. FULL THREAD c/w (1) WASHER EA.
111	12	BOLTS: 19#-UNC x 89 LG. FULL THREAD c/w (1) WASHER EA.
112	16	BOLTS: 19# x 152 LG. FULL THREAD c/w (1) NUT EA. (ZINC COATED)
113	16	COUPLING NUT: 19# x 57 LG. HEX HEAD
114	8	F/BAR: 13 THK. x 51 x 172 LG. (CTS)
115	8	F/BAR: 13 THK. x 51 x 135 LG. (CTS)
116	2	PLATE: 70 THK. x 140 x 480 LG. (SEE DETAIL)
117	2	F/BAR: 10 THK. x 152 x 265 LG.



NOTE:
LOCATE JACK SCREWS ON ASSEMBLY



SHOP NOTE:
ITEM #38 & #48 TO BE SEAL WELDED TO ITEMS # 13 & #45.



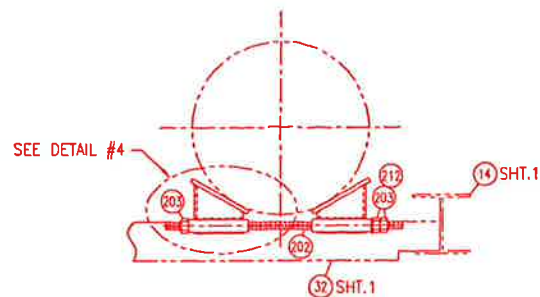
MAIN/CORNER JOINT	SLEEPER JOINT	PIPE/H.S.S. SLEEVE	CONCRETE BARRIER	GUSSET DETAIL	COMMUN. CHAMBER	EQUIP. SUPPORT	SEAL PAN

GENERAL NOTES		GENERAL NOTES		REVISION	
DATE: 2000.05.09 3:01pm FILE NAME: J:\jobs99\DWG\99404\Comp\SKD\SKD-99404-114A-02.dwg		1 ISSUED FOR CONSTRUCTION		BY S.FARWELL	DATE 00/05/09
				CKD S.L.	ENG S.W.

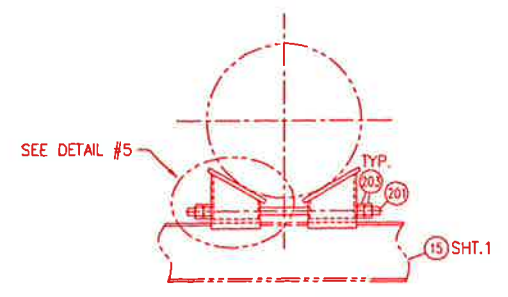
APPROVED		DRAWN	
MECH./STRUCT.	DATE	BY S.FARWELL	DATE 00/04/28
ELECTRICAL	DATE	CHECKED	DATE
PROJECT S.WARD	DATE 00/05/09	BY S.LESLIE	DATE 00/05/09
DATE		SCALE AS NOTED	

PROPAC			
440 East Lake Road, Postal Bag #2 Airdrie, Alberta Canada T4B 2C3			
1478 HP STOCK COMPRESSOR SKID STEEL DETAILS			
DWG. No.: D-SKD-99404-114A	SHEET 2 OF 4	REV. 1	

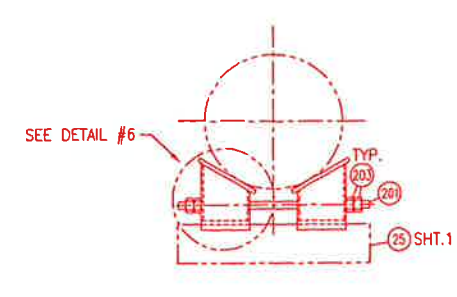
THIS DRAWING AND THE DESIGN IT COVERS ARE CONFIDENTIAL AND THE PROPERTY OF PROPAK SYSTEMS LTD. AND SHALL NOT BE DISCLOSED TO OTHERS OR REPRODUCED IN ANY MANNER OR USED FOR ANY PURPOSE WHATSOEVER EXCEPT BY WRITTEN CONSENT OF PROPAK.



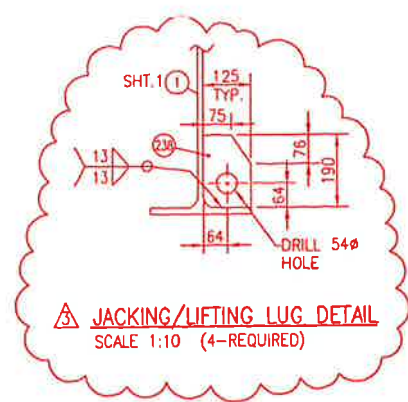
V-122 WEDGE ASSEMBLY
SCALE 1:10



V-124 WEDGE ASSEMBLY
SCALE 1:10

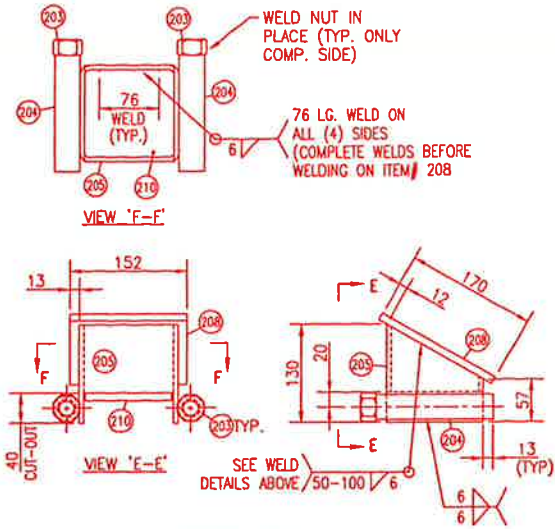


V-126 WEDGE ASSEMBLY
SCALE 1:10



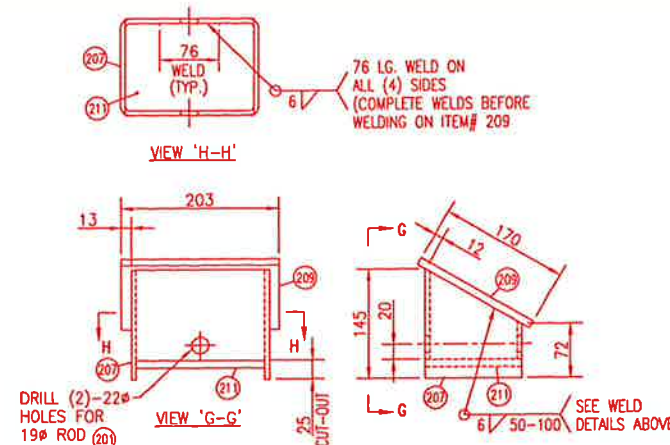
JACKING/LIFTING LUG DETAIL
SCALE 1:10 (4-REQUIRED)

BILL OF MATERIAL		
ITEM	QUA	DESCRIPTION
201	4	ALL THREAD BAR: 19# x 500 LG. SA-36
202	4	ALL THREAD BAR: 19# x 600 LG. SA-36
203	28	HEX NUTS: 19# SA-307
204	4	PIPE: 33 O/D x 4.55 WT. x 155 LG. SMLS SA-106-B
205	4	HSS: 127 x 127 x 6 THK. x 130 LG. (CTS) G40.21M-350W
206	4	HSS: 127 x 127 x 6 THK. x 175 LG. (CTS) G40.21M-350W
207	4	HSS: 178 x 127 x 6 THK. x 145 LG. (CTS) G40.21M-350W
208	8	F/BAR: 10 THK. x 152 x 170 LG. G40.21M-300W
209	4	F/BAR: 10 THK. x 203 x 170 LG. G40.21M-300W
210	8	PLATE: 10 THK. x 112 x 127 LG. SA-36
211	4	PLATE: 10 THK. x 127 x 163 LG. SA-36
212	4	PLATE: 3 THK. x 40 O/D x 22 I/D SA-36
213	3	PLATE: 25 THK. x 110 x 203 LG. SA-36
214	3	PLATE: 25 THK. x 173 x 177 LG. SA-36
215	3	PLATE: 25 THK. x 180 x 203 LG. SA-36
216	3	PLATE: 25 THK. x 60 x 133 LG. (CTS) SA-36
217	12	BOLTS: 16# x 70 LG. c/w (1) NUT & WASHER EA. (ZINC COATED) SA-325
218	6	BOLTS: 16#-UNC x 51 LG. c/w (1) WASHER EA. (ZINC COATED) SA-325
219	2	BOLTS: 16# x 51 LG. c/w (1) NUT & WASHER EA. (ZINC COATED) SA-325
220	2	BOLTS: 19#-UNC x 38 LG. c/w (1) WASHER EA. (ZINC COATED) SA-325
221	8	BOLTS: 16# x 51 LG. c/w (1) NUT & WASHER EA. (ZINC COATED) SA-325
222	1	ANGLE: 76 x 76 x 10 THK. x 250 LG. G40.21M-300W
223	2	HSS: 76 x 51 x 6 THK. x 800 LG. (CTS) G40.21M-350W
224	1	HSS: 76 x 51 x 6 THK. x 450 LG. (CTS) G40.21M-350W
225	2	PLATE: 10 THK. x 60 SQ. (1 MAKES 2) SA-36
226	2	F/BAR: 13 THK. x 76 x 360 LG. G40.21M-300W
227	2	F/BAR: 13 THK. x 152 x 225 LG. G40.21M-300W
228	3	SHIM PLATE: 3 THK. x 180 x 203 LG. SA-36
229	2	SHIM PLATE: 3 THK. x 76 x 360 LG. SA-36
230	4	PLATE: 10 THK. x 70 x 140 LG. SA-36
231	2	W100 x 19 x 310 LG. G40.21M-300W
232	2	C150 x 19 x 687 LG. (CTS) G40.21M-300W
233	2	C150 x 19 x 324 LG. G40.21M-300W
234	2	PLATE: 38 THK. x 76 x 340 LG. SA-36
235	2	BOLT: 19# x 273 LG. FULL THREAD c/w (1) WASHER SA-193-B7
236	2	COUPLING NUT: 19# x 51 LG. HEX HEAD SA-307
237	4	BOLT: 22# x 89 LG. FULL THREAD c/w (1) WASHER (ZINC COATED) SA-193-B7
238	4	PLATE: 38 THK. x 125 x 190 LG. SA-36
239	1	JACKING BOLT: 19#-UNC x 64 LG. FULL THREAD (ZINC COATED) SA-193-B7
240	1	NUT: 19#-UNC HEX HEAD SA-194-2H

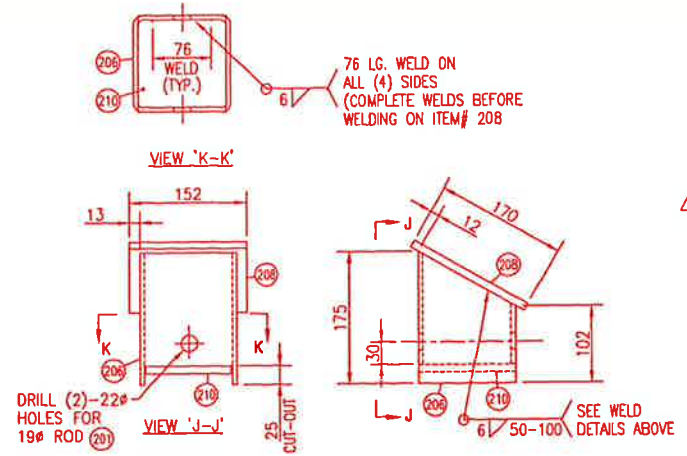


DETAIL #4
SCALE 1:5 (4 REQUIRED)

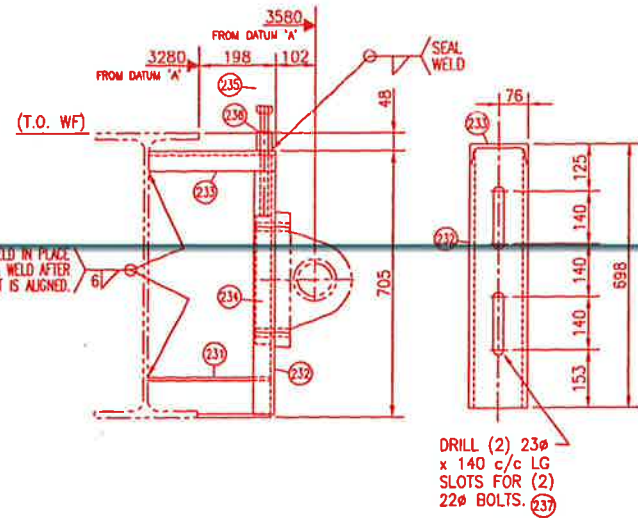
SHOP NOTE: ENSURE SLEEVES (ITEMS #204) ARE ALIGNED FOR EASY ROD TRAVEL.



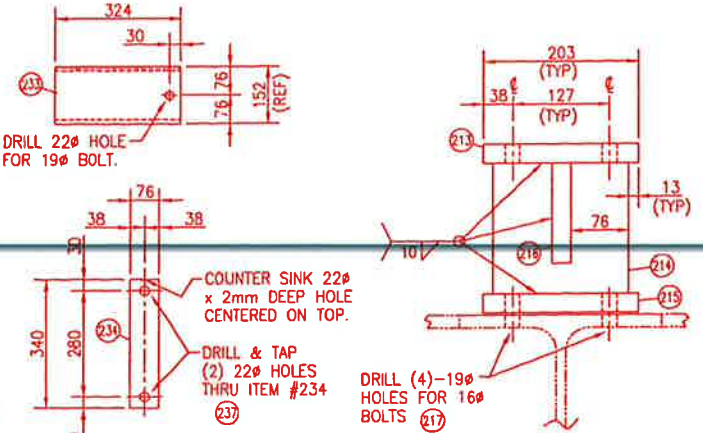
DETAIL #5
SCALE 1:5 (4-REQUIRED)



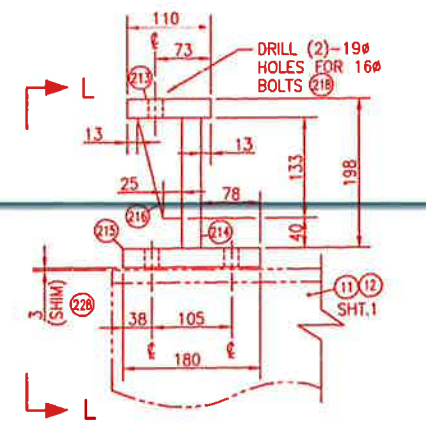
DETAIL #6
SCALE 1:5 (4-REQUIRED)



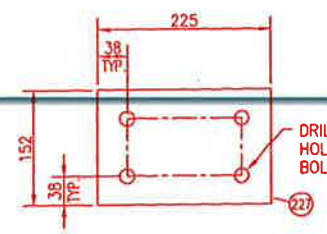
JACKSHAFT SUPPORT DETAILS
SCALE 1:10 (2 REQUIRED)



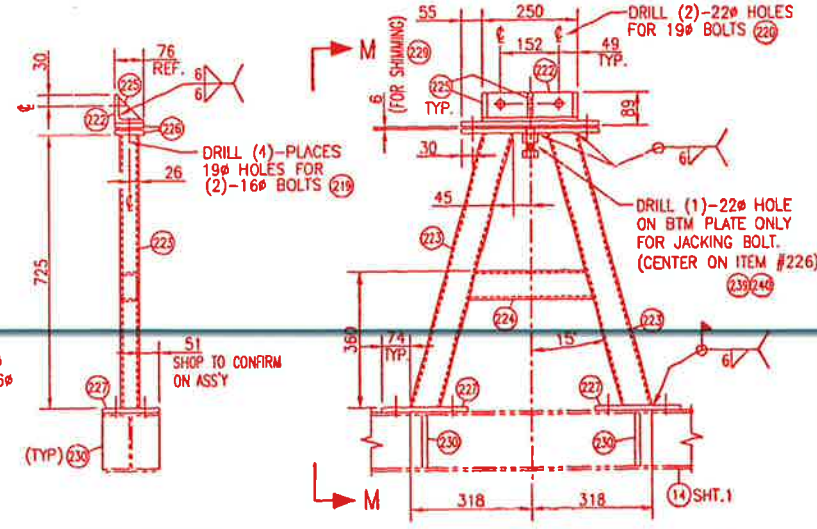
VIEW 'L-L'
SCALE 1:5



INBOARD CYL. SUPP'T DET'L
SCALE 1:5 (3-REQUIRED)



ITEM #227 DETAIL
SCALE 1:5



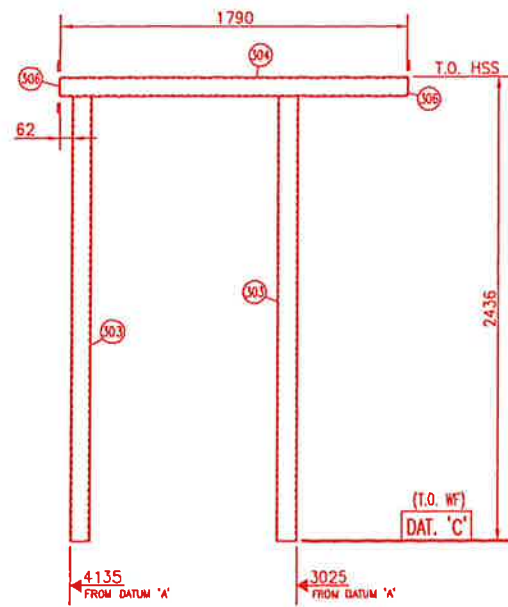
VIEW 'M-M'
SCALE 1:10

OUTBOARD CYL. SUPP'T DET'L
SCALE 1:10

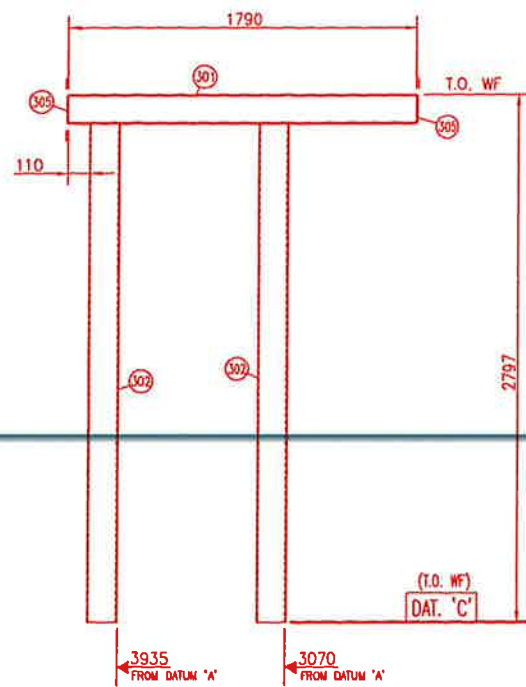
GENERAL NOTES		GENERAL NOTES		REVISION		APPROVED		DRAWN		PROPAK	
3	MODIFIED DESIGN OF LIFTING LUG	S.BRODIE	00/09/01	M.A.	S.W.	MECH./STRUCT.	BY	S.FARWELL	DATE	00/05/01	1478 HP STOCK COMPRESSOR SKID STEEL DETAILS
2	ADDED JACKING/LIFTING LUG DETAIL	S.FARWELL	00/05/17	S.L.	S.W.	DATE	BY	S.LESLIE	DATE	00/05/09	
1	ISSUED FOR CONSTRUCTION	S.FARWELL	00/05/08	S.L.	S.W.	PROJECT	S.WARD	DATE	00/05/09	SCALE	AS NOTED
DATE: 2000.09.01 3:21pm		FILE NAME: J:\jobs99\DWG\99404\Comp\SKD\SKD-99404-114A-03.dwg								Dwg. No.: D-SKD-99404-114A SHEET 3 OF 4 REV. 3	

PROPAK
440 East Lake Road,
Postal Bag #2
Airdrie, Alberta
Canada T4B 2C3

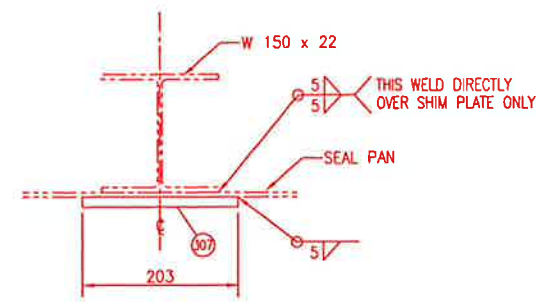
THIS DRAWING AND THE DESIGN IT COVERS ARE CONFIDENTIAL AND THE PROPERTY OF PROPAG SYSTEMS LTD., AND SHALL NOT BE DISCLOSED TO OTHERS OR REPRODUCED IN ANY MANNER OR USED FOR ANY PURPOSE WHATSOEVER EXCEPT BY WRITTEN CONSENT OF PROPAG.



DETAIL 'PS-01'
SCALE 1:20

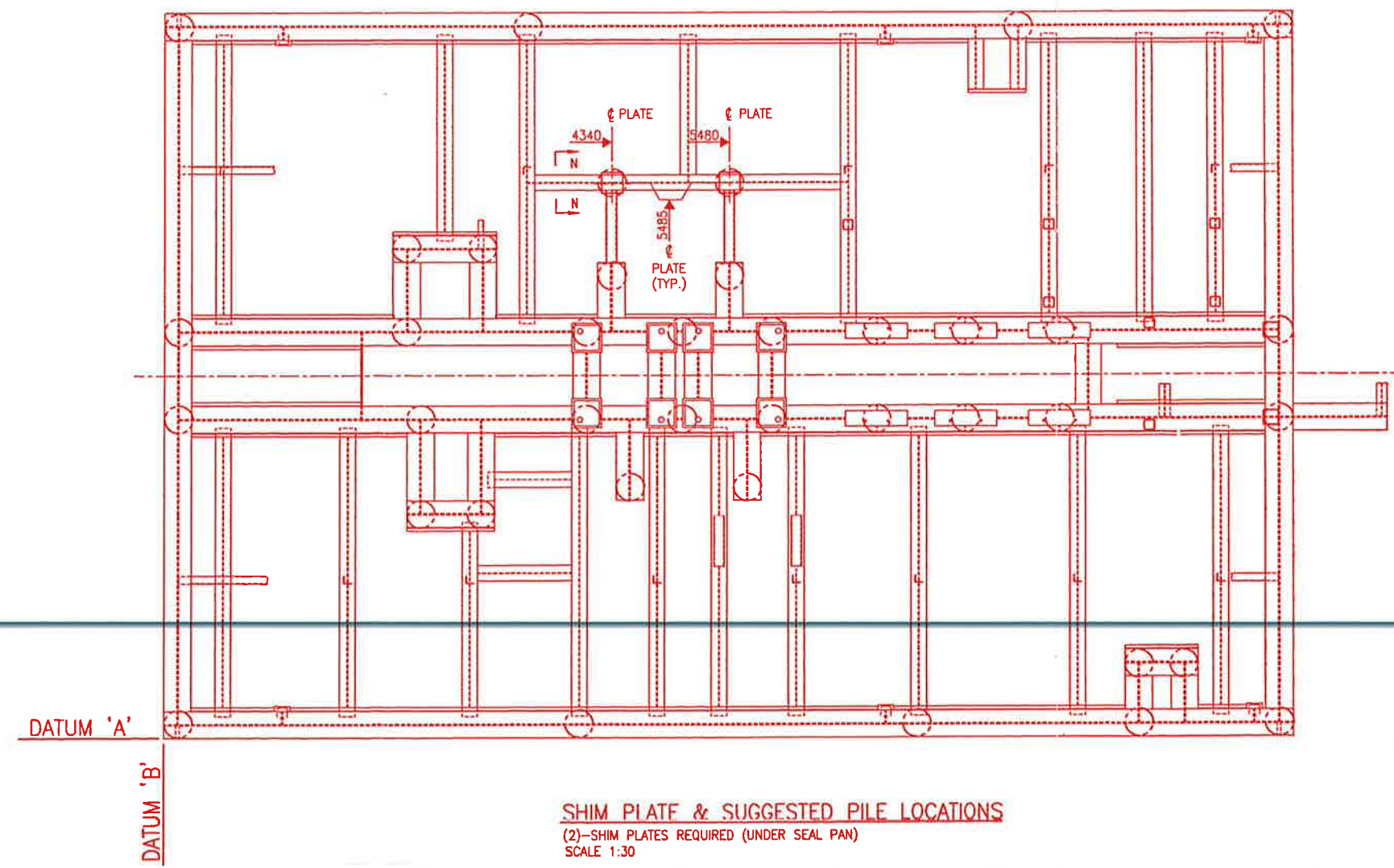


DETAIL 'PS-02'
SCALE 1:20



VIEW 'N-N'
SCALE 1:20
(TYP. OF 2)

BILL OF MATERIAL			
ITEM	QUA	DESCRIPTION	
301	1	W150 x 22 x 1790 LG.	G40.21M-300W
302	2	HSS: 152 x 152 x 6 THK x 2642 LG.	G40.21M-350W
303	2	HSS: 102 x 102 x 6 THK x 2534 LG.	G40.21M-350W
304	1	HSS: 102 x 102 x 6 THK x 1790 LG.	G40.21M-350W
305	2	F/BAR: 6 THK. x 152 x 143 LG.	G40.21M-300W
306	2	F/BAR: 6 THK. x 90 SQ.	G40.21M-300W
307	2	F/BAR: 13 THK. x 203 SQ.	G40.21M-300W



SHIM PLATE & SUGGESTED PILE LOCATIONS
(2)-SHIM PLATES REQUIRED (UNDER SEAL PAN)
SCALE 1:30

GENERAL NOTES DATE: 2000.05.17 11:42am FILE NAME: J:\jobs99\DWG\99404\Comp\SKD\SKD-99404-114A-04.dwg		GENERAL NOTES 1 ISSUED FOR CONSTRUCTION		S.FARWELL 00/05/17 S.L. S.W. BY DATE CKD ENG		APPROVED MECH./STRUCT. BY S.FARWELL DATE 00/05/03 ELECTRICAL CHECKED DATE BY S.LESLIE PROJECT S.WARD DATE 00/05/17 DATE 00/05/17 SCALE AS NOTED		PROPAG 1478 HP STOCK COMPRESSOR SKID STEEL DETAILS		PROPAG 440 East Lake Road, Postal Bag #2 Airdrie, Alberta Canada T4B 2G3	
DWG. No.: D-SKD-99404-114 A		SHEET 4 OF 4		REV. 1							