

WP13 Natural Gas Engine Operation & Maintenance Manual

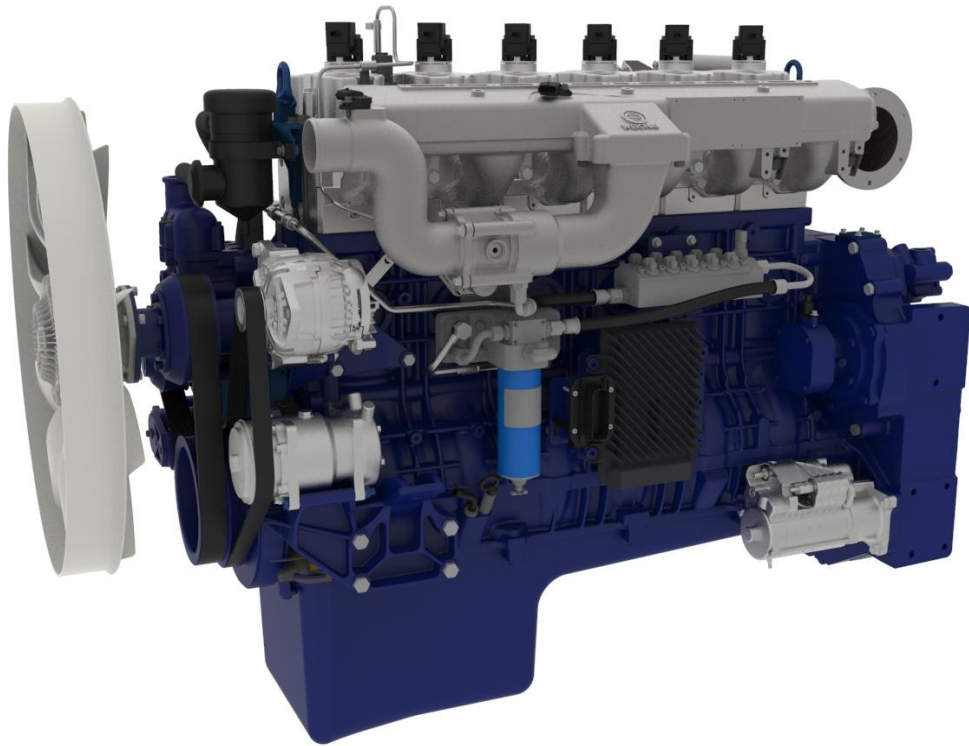

WEICHAI WESTPORT INC.



WP13 Natural Gas Engine

Foreword

The WP13 series natural gas engine is based on the Weichai Power WP13 blue engine series diesel engine and is improved by eliminating the fuel system of the diesel engine and increasing the ignition system of the gas supply system and the corresponding devices. The natural gas engine has the advantages of compact structure, reliable use, good power performance, economy, emission and other technical indexes, quick starting, simple operation and convenient maintenance. Ideal for heavy duty vehicles.

This manual briefly introduces WP13 series natural gas engine technical parameters, performance indicators, structural characteristics and maintenance precautions. Users in the use of natural gas engines if they can actually follow the instructions specified in the implementation of the requirements, will be able to greatly extend the life of the engine. This manual describes the WP13NG series of natural gas engine basic models.

As the product continues to evolve, its structure will be improved. The content contained in the instruction manual may lag behind. For the latest product information, please visit Weichai <http://www.weichai.com> website. Users are welcome to make suggestions for further improvement of the product. Let us cooperate sincerely, work together to jointly promote the cause of China's clean energy vehicles and hard work!

January 2018

Dear customers,

Welcome to use Weichai products! Thanks for your love to Weichai products!

Please read carefully the operation & maintenance manual of the natural gas engine and operate it in strict accordance with relevant specifications so that you can operate and maintain it properly.

Service commitment:

If the engine fails, please contact Weichai Call Center at 400-6183066 as soon as possible. Our company promises that the authorized service center will arrive at the site within 3 h (the city where you locate), within 24 h (general areas) and within 48 h (remote areas), and will provide fast, high-quality and considerate service according to Weichai service specifications.

Please read the followings carefully before your use for the purpose of running the engine effectively.

- The natural gas engine has been tested in strict accordance with the test specification before its delivery. Do not adjust ECU data or increase the engine power without permission. Otherwise, the company's warranty service will become invalid.
- Engine control module (ECU) and fuel metering valve (FMV) are precision components that shall not be disassembled by user; otherwise, the company's warranty service will become invalid.
- Turbocharger rotor shaft is a precision high-speed rotating component, which shall not be disassembled or collided; otherwise, the company's warranty service will become invalid.
- The engine's main bearing bolts and connecting rod bolts have strict torque and corner requirements, and shall not be loosened or disassembled by user. Connecting rod bolts for one-time use of bolts, shall not be reused; otherwise, the company's warranty service will become invalid.
- The engine shall always be filled with oil of grade specified in this Manual. It is recommended to use the special oil for Weichai gas engine and filter the oil with a special cleaning filter. Each time the engine is started, make sure to check whether the filling amount of coolant and oil is proper. Make sure that the engine uses the natural gas for automobiles as specified in the national standard.
- Never run the engine without an air filter.
- A new engine must be subject to running-in for 50 h before being put into service.
- Each time the spark plug is replaced, tighten them to the specified torque and ensure the ceramic body is clean;
- Before welding vehicle parts and components, the power supply and the grounding of the electronically controlled system of the engine shall be disconnected in prior.
- If the ambient temperature is likely to be below 0 °C and no coolant containing antifreeze additive is used in the engine after parking, the coolant shall be completely drained from the water tank and engine.
- The electrical system components must be inspected and maintained by electrical technicians only;
- The electronically controlled system components must be inspected and maintained by professionals from Weichai authorized service station only;
- After starting a cold engine, accelerate it slowly rather than abruptly, and never run it at an idle speed for a long time; do not stop the engine immediately after running under heavy load (except under special circumstances); instead, run it at a low speed for 5~10 min before parking;
- Before starting a new engine, check the gas pipe, gas supply device and electrical system. Pay special attention to checking whether the electrical connection is loosened and the high-voltage coil is connected incorrectly;
- If the engine cannot be started after three successive attempts, check the gas system and the circuit carefully again;
- Note the amount of natural gas, and fill if necessary. The vehicle shall be filled with natural gas by the staff of the gas station in accordance with the rules of the gas station. After filling natural gas,

check the sealing of the gas system;

- For a CNG engine, heat the pressure regulator with the engine coolant. Using ordinary water (hard water) as engine coolant may cause scale on the pressure regulator water chamber and frost immediately after starting.
- The engine has been sealed to prevent rust and corrosion before its delivery. Generally, the sealing period is one year. The engine beyond the sealing period should be checked and necessary remedies should be taken.
- For inspection and maintenance, please go to the service station designated by Weichai. Spare parts designated by Weichai must be used for maintenance. Weichai will not be responsible for any damage to the engine caused by using the undesignated spare parts.
- Replace emission-related key parts (such as turbocharger, FMV, ECU, exhaust gas after-treatment system, EGR system, regulator and pressure reducer) with those of the same make and model as original ones; otherwise, Weichai will not be responsible for any consequences.

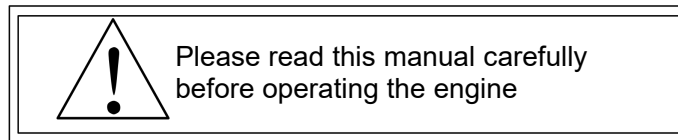



Safety warning

This is a "safety warning mark" in industry which emphasizes the importance of the following information.

Make sure you have understood the consequences of a hazardous situation and how to avoid it.

However, the warnings in this manual do not cover all possible situations!

If you decide to use the recommended procedures and methods, please make sure that the operation will not put you and others and equipment at risk.

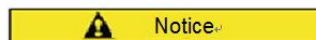

This mark indicates a potentially hazardous situation which, if not avoided, can result in serious injury or even death or substantial property damage.

This mark indicates a potentially hazardous situation which, if not avoided, can result in minor injury or property damage. It is also used for warnings of hazardous operations.

This mark provides information on how to properly operate and install our engine products. However, a simple reading of this manual does not eliminate all kinds of dangerous situations.

Only a deep understanding of the information contained in the safety warning can help you operate the engine properly.















Precautions before maintenance and repair

- Avoid long-time repeated exposure to the used oil.
- Wear the protective clothing and water-proof gloves, if available.
- Do not put the oil-immersed rag in your pocket.
- Avoid contaminating clothes with oil, and in particular, underwear.
- Wash operating clothes regularly. Discard clothes and shoes that are immersed with oil and can not be cleaned.
- In case of cut and injury, take first-aid measures as soon as possible.
- Before operating, always apply some protective cream which will make it easier to remove the oil when the skin is contaminated with mineral oil.
- Use soap and hot water, or liquid soap and nail brush to wash your hands for the purpose of removing all oil stains. If the grease secreted by skin is washed off, the product containing lanum can substitute the grease secreted by skin to moisturize the skin.
- Do not clean the skin with gasoline, kerosene, fuel, thinner or solvent.
- If the skin irritation is felt, seek for medical care immediately.
- Remove oil from the parts before handling, if possible.
- If the eyes are endangered, wear goggles or a protective mask. Eye washing fluids must be readily available.
- When repairing the engine, do not splash oil or other liquid on the floor. If hydrocarbon or other liquid leaks unexpectedly, take all essential measures to isolate the area so as to keep the environment clean and protect the persons from injury;
- The hydrocarbon, ethylene, glycol or petroleum should be handled, stored and recycled according to the safety and environment standard being effective in the country.
- Shut down the engine during the maintenance or repair.
- Periodic maintenance and repair of the fuel system should be carried out in a professional repair shop that has obtained a certificate from the relevant qualification department.
- The mechanics performing fuel system maintenance and repair should have received professional training and have obtained a certificate, and any other person may not repair the fuel system without permission.

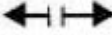
- No smoking is allowed during the maintenance, and fire prevention measures should be taken at the site. If the gas tank has been inflated, the maintenance shall not be done when the vehicle is close to the surrounding open flame.
- During the maintenance and repair, it is forbidden to knock or collide gas tanks, pressure reducing valves, pipes, steel cylinders and various valves.
- If the maintenance and troubleshooting is involved with removal/refitting, adjustment and other operations of pipe fittings, valves, instruments and pressure relief devices, the maintenance staff should first disconnect the battery power supply circuit and close the master valve and the cylinder valve to release the pressure inside before removing the failure points. If it is difficult to diagnose the leakage or failure points accurately, the master valve can be opened for pressure check under the premise that there is no fire within 10 m around the vehicle. After the leakage point is determined, the master valve and all cylinder valves should be closed immediately to release the pressure before removal and repair.
- During the troubleshooting of gas supply system failure, the master valve and all cylinders valves must be closed to release the pressure in the pipe. It is prohibited to carry out any repair task under pressure.
- Make sure to check whether the ferrule is not damaged. High-pressure pipes and ferrules connector cannot be used again and must be replaced with new ones. After the repair, the gas detector or soapy water should be used to carry out the leakage test.
- After disassembling the pipe and various connectors, it is necessary to purge the pipe to prevent dust from entering the gas pipe.
- When cleaning the vehicle, special care should be taken to avoid electrical control system components such as spark plugs, ignition coils, FMVs and so on.
- When the NG vehicle is stored for a long time, the pressure inside the gas tank should be no more than 2MPa but no less than 0.2MPa. The cylinder port valve should be closed and the whole circuit should be switched off. The confined space in which the vehicle is stored should be far away from fire source and inflammable substances, and should be provided with ventilation devices on the top for purpose of regular ventilation.
- When NG vehicle is transported on train, ship or flatbed, the pressure inside the gas tank should be no more than 5 MPa. During the transportation, the cylinder port valve should be closed and the whole circuit should be switched off, so that the vehicle is secured safely.

Contents

1	Structure and performance parameters of natural gas engine	1
1.1	Meaning of natural gas engine model	1
1.2	Outline drawings of WP13 natural gas engine	2
1.3	Technology and performance parameters of natural gas engine	3
1.4	Main structural features of natural gas engine	8
2	Introduction of structure and system of natural gas engine	9
2.1	Gas system	9
2.2	Electronic controldiagram	15
2.3	Operating principle and precautions of electronic control system components	16
3	Installation and operation of natural gas engine	26
3.1	Unpacking of natural gas engine	26
3.2	Lifting of natural gas engine	26
3.3	Technical requirements for installation of natural gas engine	26
3.4	Installation and precautions of natural gas engine	28
3.5	Technical requirements for the auxiliary system	28
3.6	Precautions	29
4	Maintenance of the natural gas engine	31
4.1	Fuel, lubricating oil, coolant and auxiliary material for the natural gas engine	31
4.2	Routine maintenance of the natural gas engine	33
4.3	Maintenance requirements of the engine systems	36
4.4	Regular maintenance of natural gas engine	39
4.5	Maintenance of natural gas engine in case of long-term storage	41
5	Analysis and troubleshooting of common faults	42
5.1	Diagnostic methods	42
5.2	Common faults and troubleshooting	42
6	Contact us	45
Appendix		46
(A) Q/WCQTG0011 "Specification of Replacement of Gas Filter Element of Weichai Natural Gas Engine" 错误! 未定义书签。		
(B) Q/WCQTG0070 "Specification of Fault Diagnosis and Maintenance of Wastegate control valve"		48
(C) Q/WCQTG0071 "Specification of fault diagnosis and maintenance of Weichai oxygen sensor"		52
(D) Maintenance and determination specification of electronic throttle		56
(E) Q/WCQTG0013 "Specification of Nozzle Cleaning of Weichai Natural Gas engine"		58
(F) Q/WCQTG0007 "Specification of Spark Plug Removal and Refitting of Weichai Natural Gas Engine"		63
(G) Operation Specification of Vehicle LNG System		68
(H) Explanation of Abbreviation Terms in English		77
(I) List of Fault Codes		78

Description of the illustration			
	Dismounting		Oil coating
	Fitting		Special tools, such as: S K....., KUKKO....., TS.....W
	Marking (do before disassemble, adjust when assemble)		Pay attention to assembly direction
	Filling-full charge(such as lubricating oil, cooling water etc.)		Deflating
	Draining off(lubricating oil or cooling water)		Unloosing (Such as unloose clamping equipment)
	(loose-proof –fixed) Coat fluid sealant		Clamping (Such as: reinforcing clamp equipment)
	Accident preventing (marks for dangerous occasion)		Inspecting-adjusting (such as: tighting torque, dimension, pressure and clearance)
	Replacemnt when re-assembly		Inspecting

1 Structure and performance parameters of natural gas engine

1.1 Meaning of natural gas engine model

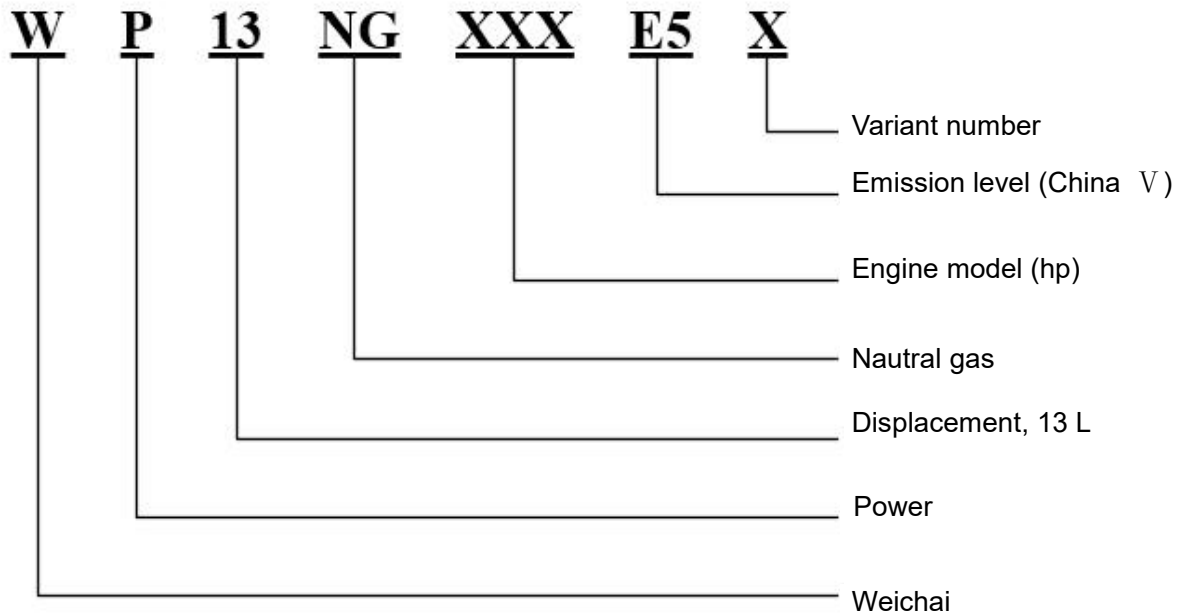

1.2 Outline drawings of WP13 natural gas engine

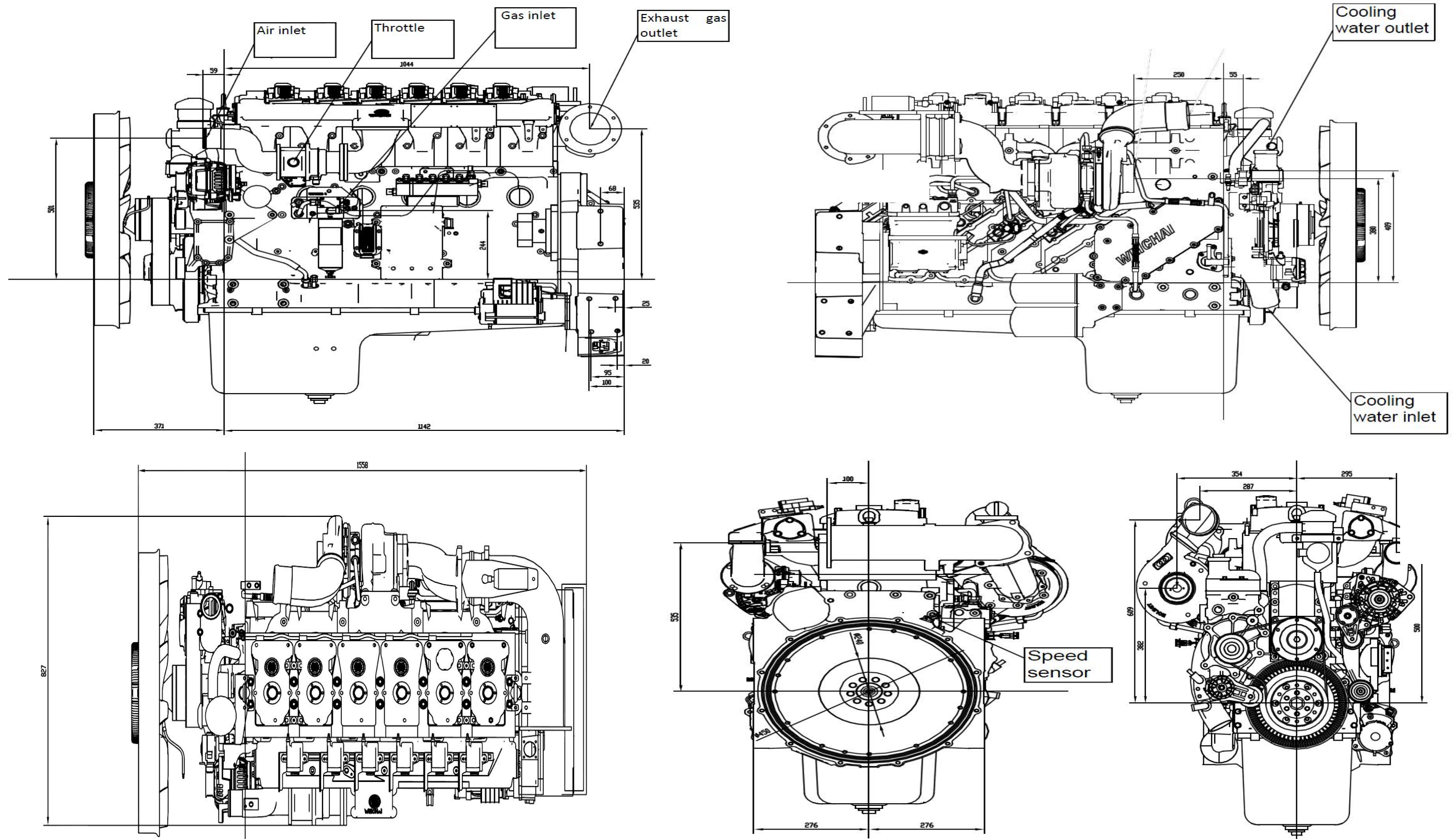

Fig. 1-1 Profile drawing of WP13 natural gas engine

1.3 Technology and performance parameters of natural gas engine

WP13 natural gas engine power range is 301-316kW, and rated speed is 1900r/min respectively.

Table 1-1 Main technical parameters of WP13 natural gas engine

Type	Inline 6 cylinder, 4-stroke, lean burn, turbocharged and intercooled, spark plug ignition		
Bore/stroke (mm)	127/165		
Displacement (L)	12.54		
Number of cylinders	6		
Valve number per cylinder	4		
Ignition sequence	1-5-3-6-2-4		
Gas system	Electronic single-point injection		
Exhaust gas purification device	Oxidation catalytic converter		
Cold valve clearance (mm)	Intake valve 0.4 ± 0.03 Exhaust valve 0.6 ± 0.03		
Thermostat opening temperature (°C)	Start to open under $79 \pm 2^\circ\text{C}$, fully open under 92°C		
With gas phase	Intake valve open: $34^\circ \sim 39^\circ$ before top dead center $61^\circ \sim 67^\circ$ after bottom dead center Exhaust valve open: $76^\circ \sim 81^\circ$ before bottom dead center $26^\circ \sim 31^\circ$ after top dead center		
Thermostat opening temperature (°C)	Start to open under $79 \pm 2^\circ\text{C}$, fully open under 90°C		
Start method	Electric start		
Lubrication method	Pressure lubrication		
Oil grade	Weichai gas engine oil		
Cooling method	Water-cooled forced circulation		
Oil pressure (kPa)	350-550 (absolute value)		
Idle oil pressure (kPa)	200-350 (absolute value)		
Allowable longitudinal inclination (°)	Front/back	Long-term 10/10	Short-term 30/30
Allowable horizontal inclination (°)	Exhaust pipe side/signal generator side	Long-term 45/15	Short-term 45/30
Crankshaft rotation direction (viewed from the free end)	Clockwise		

Table 1-2 Main performance parameters of WP13NG engine

	Unit	WP13NG engine	
Engine model		WP13NG 410E50	WP13NG 430E51
Rated power	kW	301	316
Rated speed	r/min	1900	



Idle speed	r/min	650	
Max. torque	Nm	1750	2000
Max. torque speed	r/min	1200-1500	
Emission level	-	China V/Euro V (with oxidation catalyst)	

Table 1-3 Main specifications of accessories

No.	Name	Item	Technical parameters
1	Gas/air mixer	Part number	612700910052
		Type	Nozzle/gas forced mixing
2	Solenoid valve (LNG)	Part number	1001040463
		Type	Normally closed
3	Pressure regulator (LNG)	Part number	610800190617
		Operating temperature	-40°C-105°C
4	Pressure regulator (CNG)	Part number	13050448
		Type	Two-stage integral type
5	Engine control module(ECM)	Part number	612600191584
		Operating voltage	18-32V
		Operating ambient temperature	-40°C-105°C
6	Spark plug	Part number	1000450457
		Clearance	0.35+0.05mm
7	Ignition coil	Part number	1000264408
		Operating ambient temperature	-40°C-125°C
8	Fuel metering valve(FMV)	Part number	612600191586
		Operating voltage	16V-32V
		Operating ambient temperature	-40° C-125° C
9	Electronic throttle	Electronic throttle	612600191590
		Type	ECM control
10	Low pressure gas filter	Part number	612600190338
		Max. operating pressure	35bar
		Operating ambient temperature	-40°C-107°C
	Integrated low-pressure filter	Part number	1000160472
		Max. operating pressure	10bar

No.	Name	Item	Technical parameters
		Operating ambient temperature	-40° C-120° C
11	High pressure gas filter (CNG)	Part number	13055650
		Max. operating pressure	248bar
		Operating temperature	-40° C-107° C
12	Exhaust relief valve	Part number	1000083008
		Operating ambient temperature	-40°C-125°C
13	Exhaust gas purification device	Type	Oxidation catalytic converter
14	Water pump	Type	Centrifugal (volute and timing gear chamber on the same body)
		Calibrated speed, r/min	2500
15	Oil pump	Type	Gear type
		Safety valve opening pressure	(1200±50)kPa
		Type	Rotor type
		Safety valve opening pressure	(1200±120)kPa@4362r/min
16	Crankshaft shock absorber	Type	Silicone oil type
		Outer diameter size(mm)	Φ280
17	Turbocharger	Features	Water-cooled intermediate shell
18	Oil filter	Type	Screw-inpaper filter element, double drum parallel
19	Thermostat	Type	Wax type, core combination type
		Opening temperature	Start to open under 79°C±2°C, fully open under 92°C
20	Oil cooler	Type	Plate-fin style
		Bypass valve opening pressure(kPa)	260±26kPa
		Proof test pressure (kPa)	1400
21	Starter	Output voltage (V)	24
22	Generator	Voltage(V)	28
23	Fan	Type	Ring fan
24	Air compressor	Type	Piston water cooling
		Cylinder bore(mm)	92
		Lubrication method	Pressure lubrication

No.	Name	Item	Technical parameters
		Operating method	Continuous operation
		Total piston displacement(cm ³)	360
25	Hydraulic pump (optional)	Min. speed(rpm/min)	500
		Max. speed(rpm/min)	3200
		Flow (direction of rotation) (L/min)	15.77
		Oil inlet thread	M26×1.5 internal thread
		Oil outlet thread	M18×1.5 internal thread

Torque and method for tightening main bolts & nuts of engine

Table 1-4

Bolt designation	Bolt specification	Tightening torque (N•m)+re-tightening angle (°)	Repeated times allowable
Main bearing bolt	M18-10.9	250 ⁺³⁰ ₀ , for tightening order requirements	
Connecting rod bolt	M14×1.5	120+(90°±5°) (reach to 170-250N•m simultaneously)	0
Cylinder head bolt	M16	200 ⁺¹⁰ ₀ +2× (90°±5°) (reach to 240-340N•m simultaneously)	3
Flywheel bolt	M14×1.5	60 ⁺²⁰ ₀ +2× (90°±5°) (reach to 230-280N•m simultaneously)	2
Flywheel housing bolt	M12	40 ⁺²⁰ ₀ +2× (120°±5°) (reach to 110-140N•m simultaneously)	2
Camshaft gear bolt	M8	32~36	
Crankshaft pulley compression bolt	M10	60 ⁺¹⁰ ₀	
Exhaust pipe bolt	M10	50~70	2
Rocker arm bolt	M12	100 ⁺¹⁰ ₀	
Exhaust manifold bolt	M10	15N•m+60°	
Tensioning wheel fastening bolt	M16	195 ⁺²⁰ ₀	
Spark plug	M14X1.25	(25~28) N•m	
Oxygen sensor	M18X1.5	50 N•m±5N•m	
water temperature sensor	M14X1.5	25 N•m±5N•m	
Filter gas fittings	22mm wrench	26-29 N•m	

FMV gas connector	22mm wrench	57-59 N•m	
-------------------	-------------	-----------	--

Note:

- ① indices value is allowable tolerance.
- ② Angle value shall be re-screwed angle after screwing to specified torque.
- ③ Value before angle value is the times for turn angle.
- ④ Strength grade of all bolts and nuts on the machine shall meet corresponding requirements. Bolts and nuts in same specification and different strength grade shall not be wrongly mounted and arbitrarily changed. Allowable times for repeated use shall not be exceeded, otherwise serious consequences may be caused.

Tightening order as follow:

Tightening order of main bearing bolt

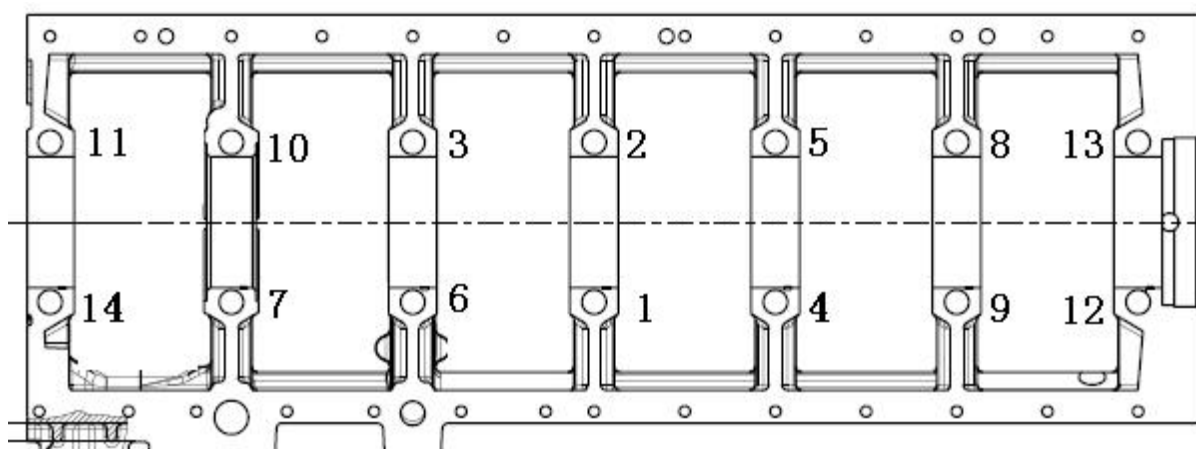

Fig 1-2 Tightening order of main bearing bolt

As Fig 1-2 shows, first tightening to 50N•m in order, then tightening to 250^{+30}_0 N•m in order.

Tightening order of cylinder head main bolt

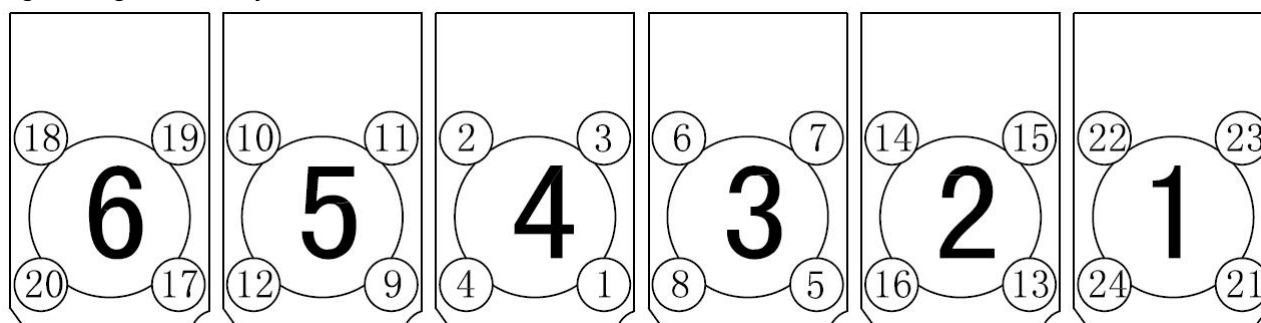

Fig1-3 Tightening order of cylinder head main bolt and auxiliary nuts

Tightening order as follow:

- a. Tightening to 30^{+20}_0 N•m after adding lubricant oil to thread of the main bolts and auxiliary nuts and pressure-bearing surface
- b. As fig 1-3 shows, tightening main bearing bolts to 200^{+10}_0 N•m in order, and make a mark on bolts.
- c. As fig 1-3 shows, tightening main bearing bolts to 90° angle in order, and make a mark an the new position

d. As fig 1-3 shows, tightening main bearing bolts to another 90° angle in order, reach to 240~340 N•m simultaneously.

1.4 Main structural features of natural gas engine

- One cylinders and one cover, reliable, easy to disassemble.
- Frame-type main bearing structure features high stiffness of the engine block, helpful for the reliability and service life of the engine.
- The use of electronic throttle technology to improve the driving performance of the engine.
- All series 6-cylinder in-line layout features high universality and is easy for vehicle matching.
- Fuel supply system is adopted with electronically controlled single-point injection technology, which ensures good power performance, economy and emission of the engine under any operating conditions.
- The engine is optionally equipped with the water-cooled intermediate volute turbocharger with applicable gas engine characteristics, and the circulating water cools down the lubrication oil of the turbocharger, which can effectively prevent oil caking at the pressure bearing and improves the turbocharger reliability; the turbocharged pressure electronically controlled technology should be adopted, which, through changing the boosting pressure at the turbocharger bleed valve, adjusts the turbocharged intake manifold absolute pressure and reaches the pressure value required for the engine operating conditions, so that the engine boosting pressure can be guaranteed and be controlled reasonably. In this way, the engine power can be controlled, and the functions such as low-speed high-torque, high-temperature boosting pressure compensation can be achieved.
- The engine is adopted with anti-surge technology. When the accelerator pedal is suddenly released with the engine under heavy load, ECM will, according to the deceleration trigger signal, shut off the fuel supply and maintain a certain opening with the electronic throttle, thus eliminating the possibility of turbocharger surging due to closing the throttle and improving the reliability and economy of the turbocharger.
- The engine adopts the electronically controlled high-energy ignition system, which provides the best ignition timing according to the engine speed, intake pressure, intake temperature and other signals, and ECM can also adjust the ignition advance angle in different operating conditions, ensuring the overall performance of the engine.
- The engine is designed with the gas mixing system in compliance with the characteristics of gas fuels, which can effectively organize the lean and stable combustion and improve the thermal efficiency.
- The acceleration and enrichment function allows the engine to obtain a relatively more fuel supply during the accelerated conditions, ensuring strong power at transient acceleration and good economy at steady-state conditions.
- The intake valve, exhaust valve and two friction pairs of valve seat are made of material suitable for the operating characteristics of natural gas engine, ensuring its wear resistance and good self-lubricating at high temperature.
- The control function of maximum rotational speed and maximum vehicle speed ensures the driving safety.
- The efficient oxidation catalytic converter is adopted, which greatly reduces the emission of harmful gases. The emission limit is far below the China IV III limit and can reach the China V level.
- The engine has strong support functions. For example, ECM can provide automatic transmission with the load signal in compliance with SAE standards and has the function of air-conditioning idle control.

2 Introduction of structure and system of natural gas engine

2.1 Gas system

2.1.1 Introduction of fuel supply system

1. Gas circuit

(CNG gas source) natural gas tank → high pressure filter → pressure regulator → (low pressure filter → heat exchanger → thermostat) \ Integrated low-pressure filter → FMV → mixer

(LNG gas source) natural gas tank → low pressure solenoid valve → pressure regulator → (low pressure filter → heat exchanger) \ Integrated low-pressure filter → thermostat → FMV → mixer

2. Water circuit

(1) LNG system

a. Engine water outlet → water bath vaporizer → water pump inlet

b. Engine outlet → (heat exchanger → thermostat) \ Integrated low-pressure filter → pump inlet

c. Turbocharger outlet → water pump inlet

(2) CNG system

a. Engine water outlet → (heat exchanger → thermostat) \ Integrated low-pressure filter → water pump inlet

b. Turbocharger outlet → water pump inlet

3. Precautions

The dust inside the pipes should be purged with high-pressure air before connecting them. The connecting pipes may not be scratched or crushed.

4. System power supply

The system uses 24V DC power supply. The current from the battery enters the system and the engine control module (ECM) in two ways: in one way, it enters the system via the ignition key switch, serving as the main power source of the system; in the other way, it enters the system directly via the fuse, providing the uninterrupted power supply for the system.

ECM also collects the system's operating voltage signals and controls the actuator based on the real-time correction of the operating voltage.

5. Gas injection system

The system's gas supply is achieved with the help of the gas injection system which features the closed-loop control and single-point injection.

"Closed-loop control" means that ECM, based on the actual air-fuel ratio signal from the oxygen sensor of the running engine, carries out the real-time correction and compensation of the engine gas supply, making the engine run in the best condition.

6. Ignition system

In the ignition system, ECM controls the ignition coil to ignite the corresponding spark plugs of the cylinder respectively according to the ignition sequence.

7. Fault diagnosis

After the system enters its operating state, ECM will control the operation of all components of the system and monitor them in real time. In the event of a system failure, the "engine fault indicator" will come on and prompt the driver in good time.

2.1.2 Functions and technical requirements of main components of the gas system

1. High-pressure filter (CNG)



Fig. 2-1 High-pressure filter

◆ Technical parameters

Max. operating pressure: 248bar

Flow rate: 425lpm @690kPa

Operating temperature: -40°C-107°C

Clean Pressure drop: 20.68kPa

Sumpcapacity: 22ml

Replacement filter element No.: 612600190763

Installation requirements:

- The filter installation location must be convenient for repair, cleaning and replacement;
- The filter should be more than 20cm away from the exhaust pipe and other high temperature components, and should be installed reliably;
- When installing, attention should be paid to the gas flow direction as indicated by the arrow;
- Repair and maintenance of high-pressure gas filter should be executed in accordance with Q/WCQTG0017 "Maintenance Specifications of Weichai Gas Engine".

2. Pressure regulator (CNG)

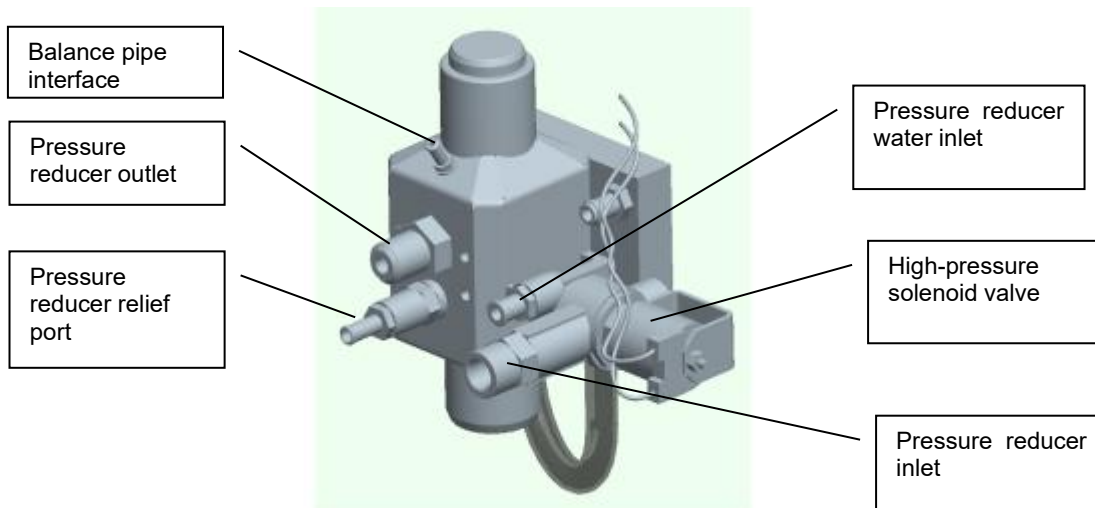

Fig. 2-2 Pressure regulator

The pressure range of the compressed natural gas is 5MPa-20MPa. After the pressure regulator, the natural gas pressure is basically maintained at 0.8MPa, and a constant pressure difference should always be maintained between the gas pressure supplied to the FMV and the intake manifold pressure. Since heat absorption is required when the compressed natural gas is depressurized, the engine coolant is used to heat the pressure regulator.

◆ Technical parameters:

Gas inlet operating pressure: (15-260)bar

Operating temperature: -40°C~120°C

Inlet gas temperature: -20°C~60°C

Coolant temperature: -20°C~100°C

Solenoid coil rated voltage: 24V

Rated gas flow: 40kg/h

The pressure regulator is equipped with $\Phi 8$ high-pressure pipe, ferrule and ferrule connector.

Installation requirements:

- The pressure regulator should be installed at a position with little vibration as close as possible to the engine, and should be connected to the engine via a flexible connection;
- The installation position of the pressure regulator should be accessible for routine adjustment, inspection and repair. The pressure regulator should be installed on the frame or firmly fixed on the structure, and may not be fixed on the inlet/outlet joints;
- The pressure regulator should be as far as possible from the exhaust system, and if the distance from the exhaust system is less than 150 mm, a reliably fixed heat insulation should be provided;
- The pressure regulator should be heated with the engine coolant, the installation height of the pressure regulator should be lower than the top of the radiator and below the thermostat, without any leakage of pipe fittings;
- The pipe connected to the pressure regulator should be arranged in a reasonable manner, without any interference;
- The balance pipe should be of sufficient length to prevent tempering, and the balance pipe joints should be fixed;
- The pressure relief outlet should be connected with a pipe outside of the engine compartment, so as to meet the relevant national regulations;
- The pressure regulator gas outlet cannot be positioned upwards, so is the bottom, so as to prevent oil stain from flowing back into the pressure regulator;
- The pressure regulator outlet pipe should be able to withstand the low temperature of -80°C. The pipe between the pressure regulator outlet and the heat exchanger should be bent sufficiently to withstand thermal expansion;
- The water pipe should be connected according to the markings on the inlet and outlet pipes of the pressure regulator, and the inlet pipe temperature should be higher than the outlet pipe temperature.

3. Low pressure solenoid valve (LNG)



Fig. 2-3 Low-pressure solenoid valve

The low-pressure solenoid valve is driven by the coil spool, controlled by the ECM opening and closed under engine's shut-off state. The low-pressure solenoid valve can shut off or resume fuel supply in time

Installation requirements:

- Low-pressure shut-off valve, which is installed between the vaporizer and the regulator, connects the engine pipe to the gas pipe.
- Tank, vaporizer, piping and the corresponding joints before the shut-off valve are procured and installed by the vehicle manufacturers from professional equipment manufacturers;
- The low-pressure shut-off valve must be fixed reliably. The pipe connected to the low-pressure shut-off valve should be as short as possible, and if it is long, pipe clamps should be provided to prevent jittering and even resonance in the pipe. The pipe connected to the low-pressure shut-off valve must be arranged in a reasonable manner, without interference;
- The low-pressure shut-off valve uses 24V DC power supply. When installing, make sure to connect the positive and negative power supply correctly;
- Make sure that the gas flow direction marked on the solenoid valve is the same as the actual gas flow direction;
- The shut-off valve connector thread is 3/4-16UNF, and the pipe fittings to which the shut-off valve is connected should be custom-made by OEM, ensuring solid connection without leakage.

4. Pressure stabilizer (LNG)



Fig. 2-4 Pressure stabilizer

◆ Technical parameters:

Max. inlet pressure: 25bar

Typical outlet pressure: 9bar@10.5bar pIN

Operating temperature: -40°C~105°C

Pay attention to the gas flow direction as indicated by the arrow

The injection pressure required by the WOODWARD control system is 8-10bar. The role of the pressure stabilizer is to adjust its outlet pressure to this range.

Installation requirements:

- The pressure stabilizer outlet pressure should be inspected with the professional equipment, and may not exceed 10bar, otherwise the system error may occur;
- OEM and user may not arbitrarily adjust the pressure stabilizer outlet pressure, and the hardware damage due to the pressure regulation without permission will not be undertaken by Weichai;

- OEM can decide whether to use the mounting bracket contained in Weichai engine according to the vehicle's requirements. If there are special requirements for the installation position and method, Weichai should be notified of that and a decision should be made by Weichai and OEM after consultation.

5. Gas control module

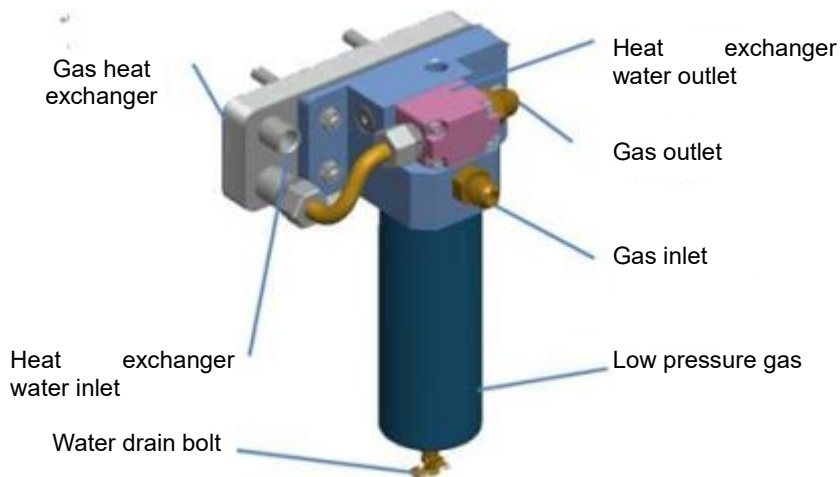

Fig.2-5 Gas control module

The gas control module is integrated with the functions of heat exchanger, thermostat and gas filter, which reduces the risk of gas leakage. The gas control module can be replaced separately for maintenance.

Technical parameters of the low-pressure gas filter are as follows:

◆ Technical parameters

Initial pressure drop: 100kPa

Initial flow rate: 85m³/h@7bar

Max. operating pressure of filter: 35bar

Dust capacity: 3.5g

0.3-0.6µm Filter element efficiency ≥95%

Operating temperature: -40°C-120°C

If it is not an integral gas control module, and the parameters of separate parts are as follows:

6. FMV



Fig. 2-6 FMV

The engine uses a WOODWARD FMV equipped with twelve BOSCH nozzles, two of which work on the basis of ECM signals.

◆ Technical parameters

Operating voltage 18V-32V;

Peak current per nozzle 3.0A, holding current 0.75A~1.0A;

Operating inlet pressure range: 5bar~10bar absolute;

Operating temperature: -40°C~130°C;

Gas temperature: -40°C~90°C;

Installation requirements:

- FMV should be installed at a reasonable and reliable position;
- The wiring harness and pipe connected to FMV should be free of interference;
- FMV is installed with the gas temperature and pressure sensor, which is used to detect the gas temperature and pressure.

7. Mixer

The natural gas enters the mixer from the FMV (FMV), and the mixed air that flows through the throttle and intercooler to enter the cylinder. The throttle used on the engine can be removed for cleaning. In the areas with high ambient dust, the mixer's throttle should be cleaned regularly.



Fig. 2-7 Mixer

2.2 Electronic controldiagram

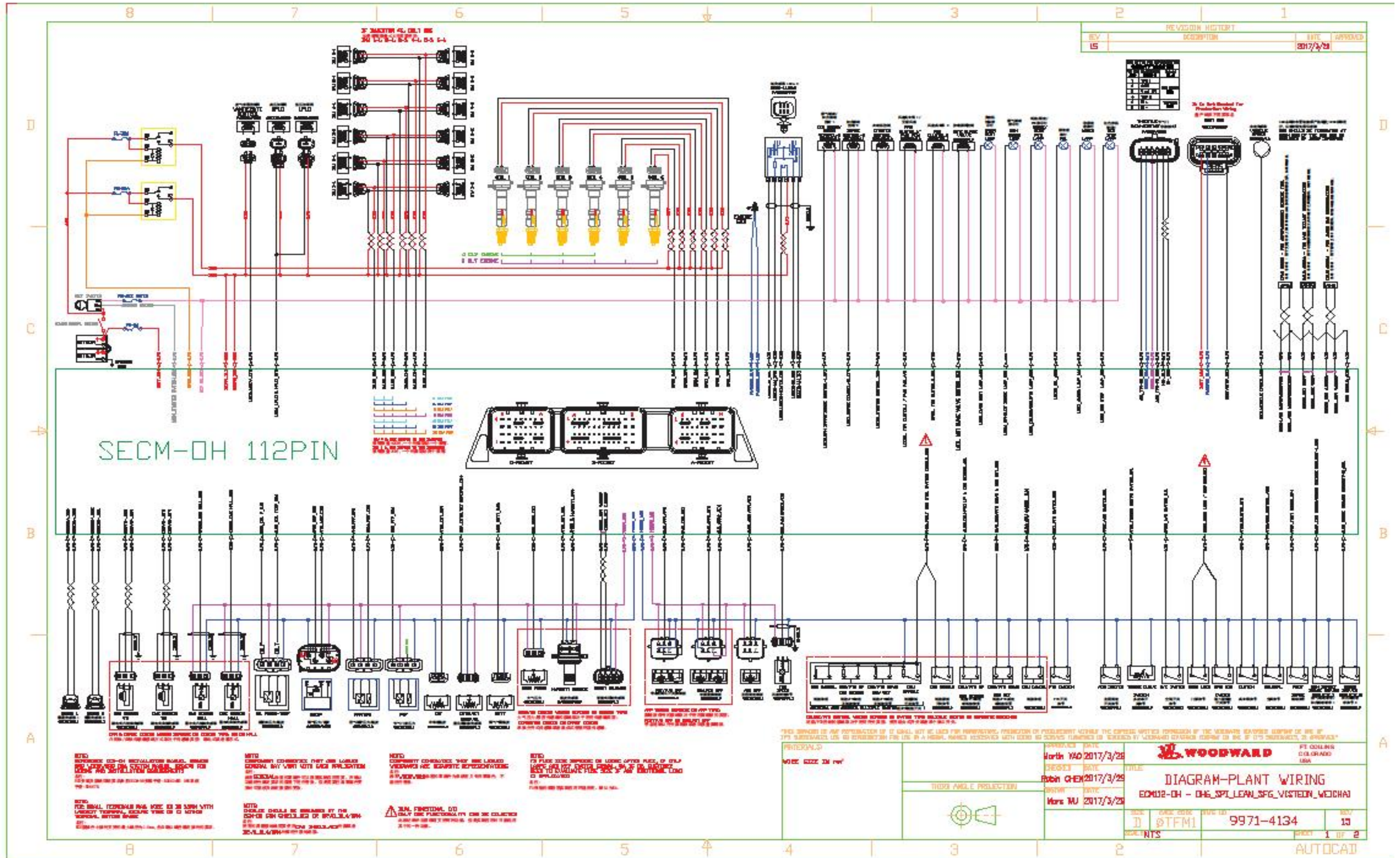

Fig. 2-8 Diagram of electric control system (6.0 system)

2.3 Operating principle and precautions of electronic control system components

The electronic control system consists of wire harness, ECM, ICM, water temperature sensor, oil pressure sensor, inlet temperature and pressure sensor, phase sensor, speed sensor, humidity sensor, oxygen sensor, electronic accelerator pedal, electronic throttle, Wastegate control valve, ignition coil, spark plug and so on.

2.3.1 Generator

When installing and connecting the generator, attention should be paid to the followings:

- The generator must be fully cooled;
- The generator must be dust-proof, splash-proof, oil-proof;
- The tension of the motor belt must be checked;
- The generator can only be connected with the voltage regulator and battery.

The generator's rated voltage is 28V, and the schematic diagram is shown in Fig. 2-9.

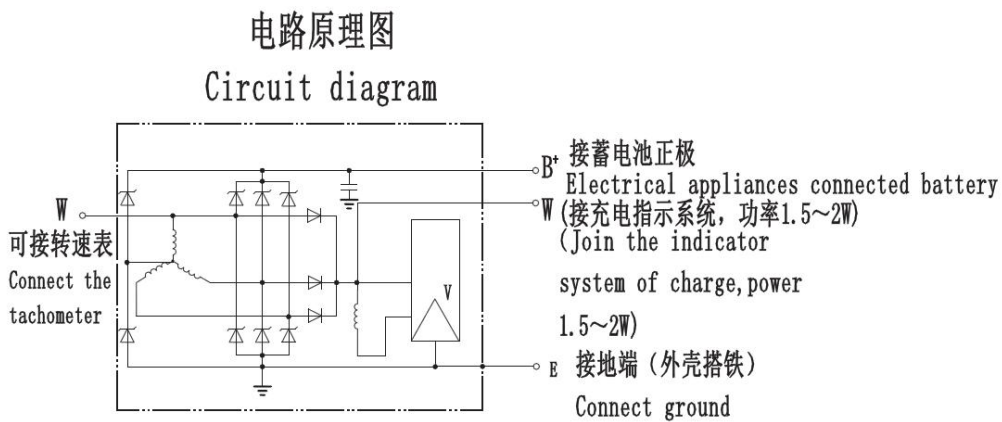

Fig. 2-9 Generator schematic diagram

2.3.2 Starter

The starter is a DC starter which features electromagnetic control, gear transmission and torque transmission with the friction plate isolator. The starter circuit is shown in Fig. 2-10.

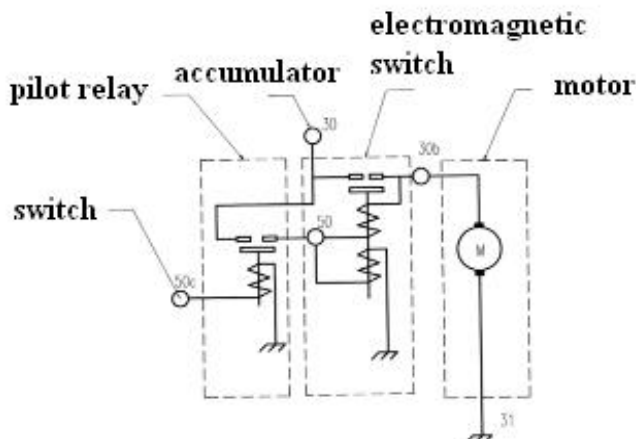

Fig. 2-10 Starter circuit

In order to ensure trouble-free starter operation, attention should be paid to the followings:

- The starter should be protected from splash water, road mud and oil, and should be equipped with guard plate when necessary;

- The starter should be protected from high temperature, and the allowable temperature on the housing should be no more than 100°C;
- If the driver fails to monitor the start-up process (for example, the commercial vehicle with rear engine mounted), a starter relay must be installed to protect the starter from tooth engagement. The current capacity of the starter relay should be greater than 80A and the starter circuit should be shutoff immediately after the engine starts to operate normally; the starter relay axis should be parallel with the ground and be perpendicular to the vehicle running direction, preventing the starter from accidental engagement due to vibration, shock or other reasons.

2.3.3 Wire Harness

The wire harness of the electric control system includes the engine wire harness only. The wire harness of the engine has been installed on the engine before delivery.



Fig. 2-11 Wire harness

Technical parameters and precautions of wire harness are as follows:

- In order to avoid high temperature, the wire harness may not be arranged on the side of the exhaust pipe. The distance between the exhaust pipe and the turbocharger should be greater than 150mm;
- The wire harness may not be fixed in the air compressor pipe, and the distance from the copper pipe should be greater than 50mm;
- The wire harness should be fixed reliably and may not have any interfere or friction with sharp objects, and if unavoidable, further protection should be provided;
- The wire harness may not be intertwined or arranged crosswire, but should be arranged in a reasonable direction, convenient for future maintenance.

2.3.4 Engine Control Module (ECM)



Fig. 2-12ECM

ECM collects the signals regarding manifold air pressure (MAP), manifold air temperature (MAT), pre-throttle pressure (PTP), gas pressure (NGP), gas temperature (NGT), engine phase, rotational speed, water temperature, oxygen content and pedal opening, and after calculation, controls the actions of ICM, electronic throttle, FMV, Wastegate control valve (WGCV), solenoid valve and other components,

achieving electronic control against the engine.

WOODWARD OH6.0ECM can support single-point injection, multi-point injection and support CAN communication. Technical parameters and precautions of ECM are as follows:

- Operating voltage: 8-32V;
- Max. operating current: 20A;
- Operating environment: -40°C-105°C;
- The ECM shell should be grounded;
- ECM should be installed in a well ventilated place;

2.3.5 Intake Temperature and Pressure Sensor (T/MAP) and Pre-throttle Pressure Sensor (PTP)



Fig. 2-13 T/MAP and PTP

PTP sensor of WOODWARD OH6.0 system is same with T/MAP sensor and is integrated with pressure and temperature. ECM calculates the amount of air intake in the engine based on signals from the sensors, determining the amount of fuel to be supplied.

◆ Technical parameters

Applicable pressure: 20-300KPa;

Applicable temperature: -40°C~130°C;

Voltage: 4.75V-5.5V.

2.3.6 Speed Sensor



Fig. 2-14 Speed Sensor

Measure the engine speed.

◆ Technical parameters

Normal operating temperature: measuring end -40°C-150°C, connecting end -40°C-120°C;

Allowable magnetic field $\leq 2\text{kA/m}$;

Max. allowable torque for assembly is 8N·m (with 8.8 M6×12 bolts).

2.3.7 Phase sensor



Fig. 2-15 Phase sensor

It is used to accurately measure the engine's camshaft position (if you want to know which cylinder fires)

◆ Technical parameters

Operating voltage: DC = 5V;

Normal operating temperature: measuring end -40°C-150°C, connecting end -40°C-120°C;

Operating frequency: ≤15kHz

Operating clearance: (0.2~2) mm

Max. allowable torque for assembly: (8±2N) N.m

2.3.8 Water temperature sensor



Fig. 2-16 Water temperature sensor

The water temperature sensor is mainly used to measure water temperature. ECU will, based on the data stored inside, correct idle speed, ignition advance angle, maximum boosting pressure limit and the concentration of the mixture under different water temperatures.

◆ Technical parameters

Rated operating voltage: 5±0.15V;

Temperature measurement range: -40°C-+140°C;

Normal operating temperature of connector parts: -40°C-+130°C.

2.3.9 Oxygen sensor (UEGO)



Fig. 2-17 Oxygen Sensor

The oxygen sensor is used to measure the oxygen content in the exhaust gas and convert the measured value into electrical signal and sent the signal to ECU. ECU adjusts the fuel supply amount by adjusting the injection pulse width according to the air-fuel ratio set in the pulse chart, achieving the closed-loop control against the engine.

The oxygen sensor is fixed behind the turbocharger, before catalyst. If there is exhaust braking device, the oxygen sensor must be fixed behind it, seen as fig

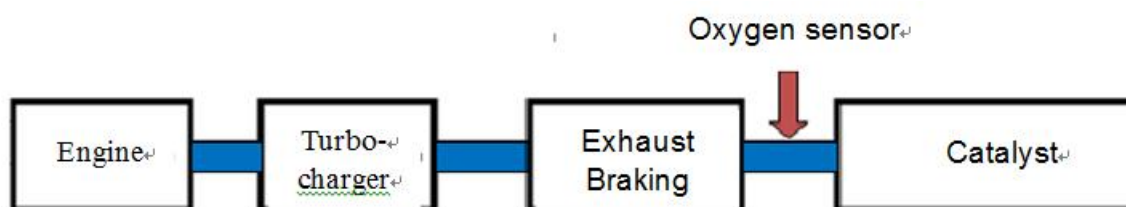

Fig. 2-18 Oxygen installation diagram

Precautions for oxygen sensor are as follows:

- The installation position of the oxygen sensor is very important for the correct operation of the system, so the oxygen sensor must be installed in strict accordance with the requirements;
- The oxygen sensor should be installed at a distance of 3 to 5 times the exhaust pipe diameter from the turbocharger outlet;
- The oxygen sensor may not be installed at or after the exhaust pipe bends;
- In order to prevent the oxygen sensor screw thread from being sintered on the exhaust pipe and causing the difficulty in disassembly, molybdenum disulfide should be applied evenly on the threads of the oxygen sensor;
- If the vehicle is equipped with an exhaust brake, the oxygen sensor should be installed at 15cm-25cm downstream of the exhaust brake and should be placed as close as possible to the turbocharger;
- The wire harness and connector of the oxygen sensor should be far away from the exhaust pipe, eliminating the possibility of sintering;
- The height of the oxygen sensor's screw base welded to the exhaust pipe should be less than 10mm, and the length of the oxygen sensor's probe into the exhaust pipe should be no less than 13mm;
- If the oxygen sensor is involved with failure or poor contact of wire harness and connector, high gas consumption and instable idling speed may be caused;
- The oxygen sensor should be installed on the side of the exhaust pipe (circumferentially) away from the engine;
- The oxygen sensor that meets the above conditions should be placed as close as possible to the turbocharger.

- The angle between axis of the sensor and the direction of gas flow is from $90^\circ + 15^\circ$ to $90^\circ - 30^\circ$ (avoid the direction of gas flow faced to measurement hole).

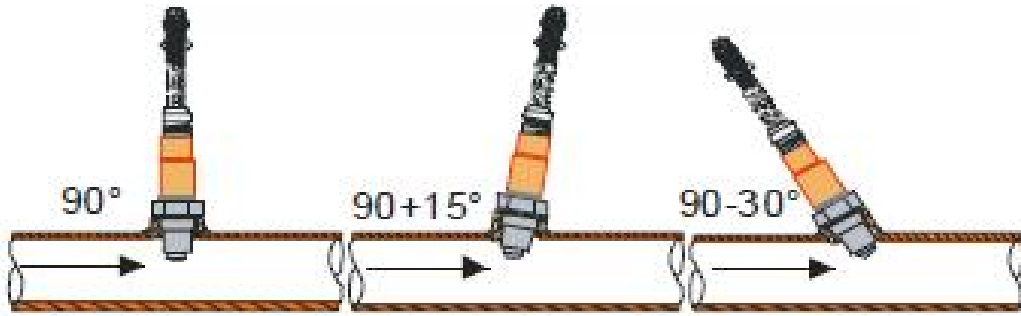

Fig. 2-19 Angle between axis of the sensor and the direction of gas flow

2.3.9 Electronic accelerator pedal

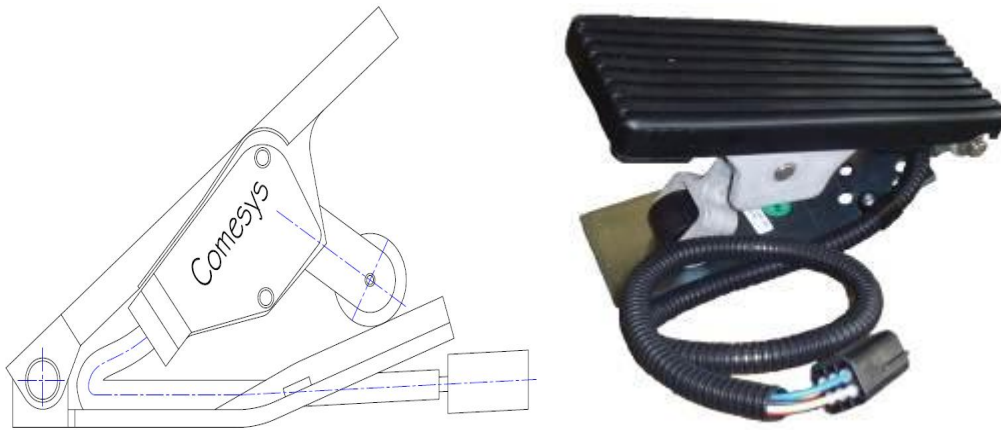

Fig. 2-20 Electronic accelerator pedal

Electronic accelerator pedal is adopted with non-contact sensor and outputs the signal of voltages 0-5V, based on which ECM controls the electronic throttle opening.

◆ Technical parameters

Operating temperature: -40°C - 50°C ;

Storage condition: -40°C - 120°C .

The OH6 system supports two types of single-mode and dual-mode pedals. The wiring methods are as follows:

◆ Single Modulus

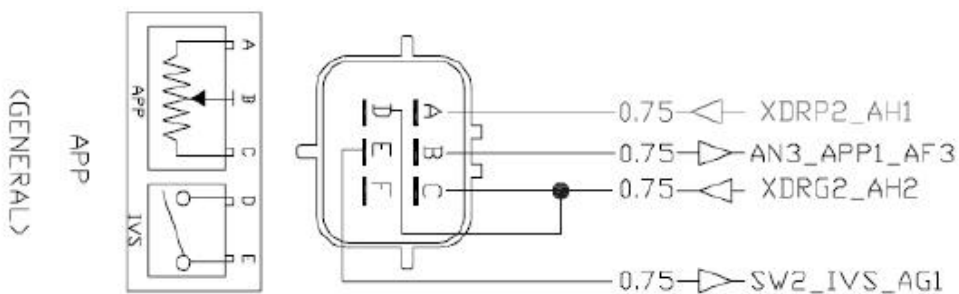

Fig. 2-21 Single modulus accelerator pedal connector

Foot pedal corresponds to ECM pin and definition:

- | | |
|--|--|
| A - AH1: ECM 5V power supply output | D - AH2: ECM 5V power supply analog ground |
| B - AF3: Pedal signal | E - AG1: Pedal idle confirmation signal |
| C - AH2: ECM 5V power supply analog ground | F - empty |

◆ Dual Modulus

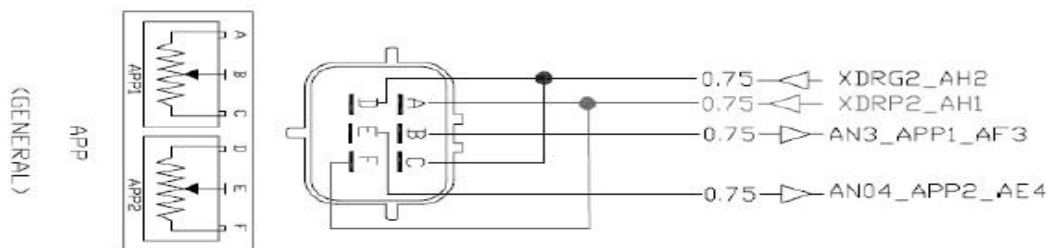

Fig. 2-22 Dual modulus accelerator pedal connector

Foot pedal corresponds to ECM pin and definition:

- | | |
|-------------------------------------|--|
| A - AH1: ECM5V power supply output | D - AH2: ECM 5V power supply analog ground |
| B - AF3: Pedal 1 signal | E - AE4: Pedal 2 signal |
| C - AH2: ECM 5V Power Analog Ground | F - AH2: ECM 5V Power Analog Ground |

2.3.10 Electronic throttle



Fig. 2-23 Electronic throttle

The electronic throttle is mainly used to control the mixed gas flow rate, the engine idle speed and the maximum engine speed. ECM controls the throttle operation according to PWM signal of 1600 Hz and keeps the throttle operating stroke within 10%-90% (butterfly valve opening). Usually, the error logic judgment of the system is to compare the position command signal with feedback signal, and check the intermediate position voltage signal (about 2.5V). If the difference between the command signal and the feedback signal is greater than 0.5V, the system will confirm the difference and a fault code in English will appear (see "Fault code comparison").

The failure of the electronic throttle or poor contact of the connector may cause: speed instability, failure to start, poor acceleration, failure to accelerate or others. First of all, you should test the contact of the connector, for which a multimeter can be used; if the connector and wire harness are in good condition but the feedback signal always jumps, you may replace it with a new one.

Technical parameters:

- The throttle is installed before and after the mixer.
- Max. axial inclined installation angle: $\pm 10^\circ$
- Operating ambient temperature: -40°C - 140°C
- Normal operating voltage: 10V-32V

2.3.11 Wastegate control valve (WGCV)

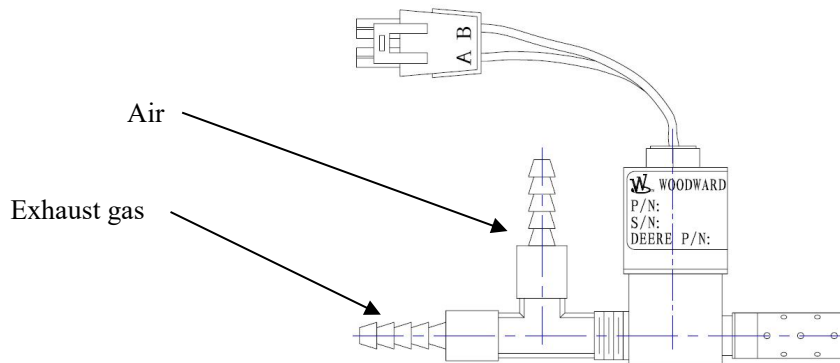

Fig. 2-24 Wastegate gas control valve

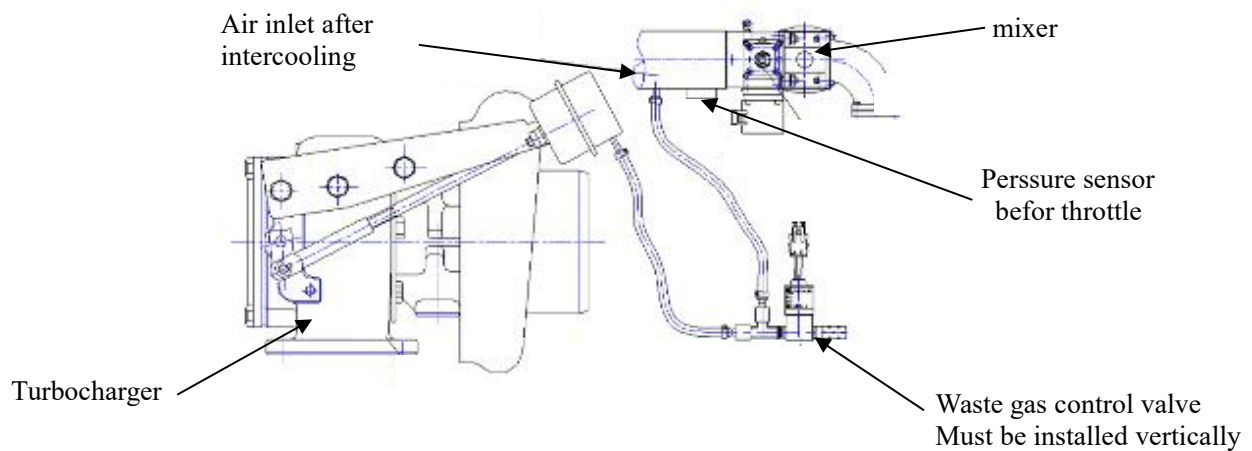

Fig. 2-25 Exhaust control valve installation pipeline

The Wastegate control valve is connected to the pressure regulator of the turbocharger. ECM controls the duty ratio of the Wastegate control valve switch and adjusts the pressure above the pressureregulator diaphragm based on PWM signal, which can, within a certain pressure range, control the opening of the turbocharger Wastegate valve, achieving the indirect control of the engine boosting pressure.

Technical parameters and precautions are as follows:

- The Wastegate control valve should be installed within 10 degrees in the vertical direction;
- The Wastegate control valve should be installed on the side with lower engine temperature, and the surrounding ambient temperature may not exceed 120°C;
- The pipe that is connected to the Wastegate control valve should be correct.

2.3.12 Ignition coil



Fig. 2-26 Ignition coil

The system herein is adopted with independent ignition coil in each cylinder. ECM controls the ignition coil's charging time, charging duration and discharge time, and make sure that the engine always maintains the charging current 6.5A in any conditions.

Technical parameters and precautions are as follows:

- The wire harness of the ignition coil should be free from stress;
- A multimeter can be used to test the contact between wire harness and connector;
- The ignition coil should be away from the engine's metal bracket to prevent spark breakdown.

2.3.13 High-voltage coil



Fig. 2-27 High-voltage coil

The high voltage coil is used to transmit the high voltage point generated by the ignition coil to the spark plug so that the spark plug can ignite the combustible mixedgas.

Technical parameters and precautions are as follows:

- The inserting force of high-voltage coil assembly should be no more than 70N, and the pulling force should be 40-70N;
- Resistance 1.7~2.7KΩ;
- The insulation and shock resistance should comply with GB/T14820-2009 and GB14023-2006.

2.3.14 Spark plug

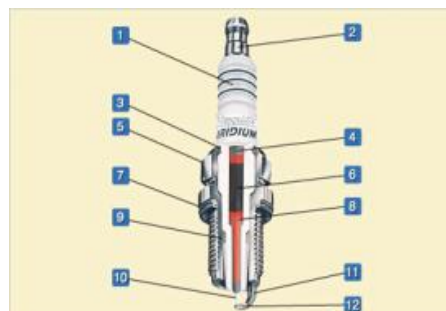

Fig. 2-28 Spark plug

1. Insulator 2. Spark plug head 3. Gasket 4. Intermediate cylinder 5. Spark plug body 6. Glass sealant
7. Washer 8. Electrode 9. Gasket 10. Center electrode 11. Ground electrode 12. Side electrode

The spark plug is used to receive the high voltage from high-voltage coil, and produce the sparks to ignite the combustible gas. The engine is adopted with dual platinum spark plug.

Technical parameters and precautions are as follows:

- Spark plug installation torque: 25-28 N•m;
- Spark plug clearance: 0.35±0.05 mm (adjusted strictly with a feeler gauge);

2.3.15 Humidity sensor

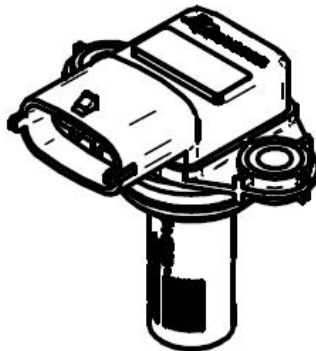

Fig. 2-29 Humidity Sensor

The humidity sensor is used to measure the intake pressure, temperature and humidity, and correct the air-fuel ratio according to the measured humidity and pressure, thus compensating the impact of the environment and keeping the engine running in the best condition.

Technical parameters and precautions are as follows:

- Operating temperature -40°C~125°C, measuring range 20~80%RH;
- The humidity sensor should be installed on the air pipe between the air filter and the turbocharger;
- The humidity sensor should be far away from the respirator and air compressor inlet;
- In order to ensure that the measured values are correct, the humidity sensor should be installed in parallel with the direction of the airflow, and the temperature and pressure probes must be placed inside the airflow.

3 Installation and operation of natural gas engine

3.1 Unpacking of natural gas engine

After the natural gas engine package box is opened, the user should first check the engine and its accessories according to the packing list, check whether the engine has any external damage and whether the connectors are loosened, and then perform the following tasks:

- ◆ The rust-proof layer and anticorrosive agent on the exposed parts should be wiped;
- ◆ According to the agreement between the manufacturer and the user, the empty oil pan should be filled with oil as required; the oil pan that has been filled with running-in accelerant oil should, after running for 3000km (or 50h), be drained and changed with new oil.

3.2 Lifting of natural gas engine

When lifting, the engine crankshaft centerline should remain horizontal, and no inclination or one-side lifting is allowed. Lifting and seating should be slow (see Fig. 3-1).

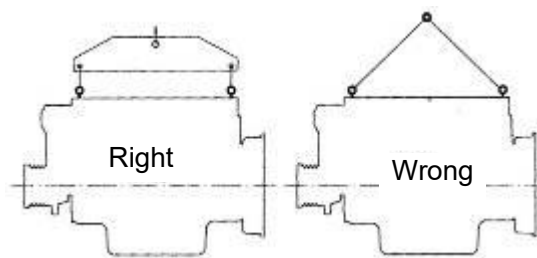

Fig. 3-1 Natural gas engine lifting diagram

3.3 Technical requirements for installation of natural gas engine

- ◆ Technical requirements, test methods, inspection rules, signs, transport and storage of the vehicle must comply with "QC/T 690-2002 Technical specifications of compressed natural gas vehicle".
- ◆ The design of the gas system should minimize the number of high-pressure pipe connection points, ensuring the construction convenience, good sealing, easy to check and high reliability of the pipe connection points.
- ◆ An over-current protection device should be provided at the position close to the cylinder unit on the upstream of high-pressure pipe of the gas system. Make sure that the gas pipe can be cut off reliably when the ignition switch is not switched on, the engine is not running, or the gas in the low-pressure pipe is leaked unexpectedly.
- ◆ The assemblies and pipes of the gas system may not be designed to stay in a passenger compartment or pass through it. (except manual shut-off valve handle).
- ◆ The component installation positions and connecting pipes of the gas system should be far away from high temperature heat sources and any place where there may be electrical arcs such as electric appliance and battery. And in particular, the components and connecting pipes of the gas system may not be designed to stay in the same airtight space. Reliable grounding should be provided at any place where there may be static electricity such as high-pressure pipes and components.
- ◆ When installing the gas tank units, attention should be paid to the effect of load distribution and height of center of gravity on the vehicle. And attention should be paid to the possible damage of the gas tank due to the application environment, and if necessary, the gas tank unit should be provided with a protective device.
- ◆ The natural gas fuel used should comply with the provisions of GB/T 18047.
- ◆ When the rated operating pressure of natural gas system is reached, every connecting point of the gas system should be tested with leak detection liquid and no bubbles should be produced within 1 min. Or a gas detector with a measurement accuracy of not less than 25×10^{-6} is used to detect

every connecting point of the gas system, and the detector may not alarm.

- ◆ The materials of the components at the air inlet should be compatible with the gas medium used, service life, ambient temperature and other requirements; the interface should be made of corrosion-resistant metal materials; it is recommended to use the copper material which does not produce spark in case of scratch, with copper content not more than 70% and hardness not less than HRB60.
- ◆ The gas tank installation position should be far away from the heat source, and the ambient temperature may not exceed 55°C. In any case, the distance between the gas tank and the exhaust pipe may not be less than 75 mm.
- ◆ When installing a gas tank under a vehicle frame, the gas tank and its accessories may not be arranged in front of the front axle. The minimum distance from the gas tank to the ground may not be less than the minimum ground clearance when the vehicle is fully loaded, and the departure angle and the longitudinal pass radius may not be changed.
- ◆ The gas tank should be installed firmly, and a rubber pad or an elastic water-free stop cushion with the thickness of no less than 2 mm should be provided between the cylinder and the holder.
- ◆ The gas tank should, after being installed and fastened, be able to withstand the static force 8 times the gravity of the gas tank full of rated operating pressure in the directions of up, down, left, right, front and back, and the maximum displacement between the cylinder and the holder may not exceed 13 mm.
- ◆ The multiple cylinders should be installed reasonably and arranged neatly. When the distance between the gas tank and exhaust pipe is 75-200 mm, a reliably fixed heat insulation device should be provided.
- ◆ The integrated valves and connectors on the gas tank must be protected adequately by some components on the vehicle, so as to reduce the potential damage due to collision, overturn or other accidents; the distance between the integrated valve and the edge of the vehicle contour should be not less than 200 mm.
- ◆ The gas tank must be installed in a position free of wind or be provided with effective ventilation, so as to prevent the leaked gas of the valve from entering the cab or passenger compartment. When the gas tank is installed inside the vehicle body, a metal or nonmetallic sealing capsule should be designed to enclose the cylinder block and the integrated valve or an auxiliary capsule is designed to enclose the integrated valve; the sealing capsule should be provided with the hatches for maintenance and inspection; the integrated valve can be closed freely at the installation position; the sealing capsule or auxiliary capsule should be provided with reliable sealing means to prevent any gas leakage.
- ◆ The high-pressure pipe should be installed along the shortest feasible route. High-pressure pipe fittings should be installed in the visible or operator-accessible position. All high-pressure pipes and high-pressure pipe joints should be effectively protected.
- ◆ The rigid high-pressure pipe should be arranged neatly and reasonably, and may not come into collision and friction with the adjacent parts; the rigid high-pressure pipes should be fixed with clips on the chassis or body, and the spacing between clips may not exceed 600 mm; if the pipe comes into contact with the adjacent components or passes through the orifice plate, a rubber pad should be used for protection. The pipe between two components should be taken with the measures that can eliminate the thermal expansion and seismic resistance, such as coil, U-shaped bend, etc. The radius of curvature of the pipe centerline may not be less than 5 times the pipe outer diameter.
- ◆ The flexible high-pressure pipe, specially designed for compressed natural gas, should be used at the hinge of the articulated vehicle, and the quality should be consistent with the relevant standards. Each high-pressure hose assembly should be clearly marked with the manufacturer's name, specifications, rated operating pressure and the words "CNG", and the high-pressure pipe fittings and the high-pressure hose should be provided as a whole.
- ◆ The flexible high-pressure hose should be fixed on the base parts of the vehicle with elastic clips

with the spacing of no more than 300 mm, and clips should be provided before and after each bend. The distance between the hose and the engine exhaust pipe may not be less than 100 mm. When the distance is 100~200 mm, a reliably fixed heat insulation device should be provided.

3.4 Installation and precautions of natural gas engine

When installing, the crankshaft centerline of the engine should be coaxial with the input shaft of the transmission gear (gearbox, transmission or generator, etc. and the crankshaft should be free of the additional axial force therefrom.

3.5 Technical requirements for the auxiliary system

3.5.1 Cooling system

1. Expansion tank

- All engine cooling systems must be equipped with an independent or semi-independent expansion tank;
- The pressure inside the expansion tank should be maintained below 50Kpa;
- The expansion tank should be at least 400mm above the engine and radiator, and should stay at the highest point in the water circuit of the entire cooling system;
- The capacity of the expansion tank may not be less than 15% of the total amount of liquid which is filled into the cooling system. When filled for the first time, the coolant can only be filled to 60% of the expansion tank's capacity, and the rest capacity is prepared for expansion of the coolant.
- A watering pipe (inner diameter $\Phi 20$ - $\Phi 30$ mm) must be installed in the lowest point of the expansion tank near the center of the low plane. The pipe should be connected to the pipe between the radiator outlet and the water pump inlet at the lowest point of the coolant circuit and should be as close as possible to the water pump end (so as to avoid the bubbles due to filling of coolant and prevent the formation of negative pressure at the water pump inlet).

2. Radiator

The water inlet and outlet should be arranged diagonally. The diameter of the water inlet and outlet pipe between the engine and the radiator should be greater than the diameter of the corresponding interface on the engine, so as to reduce water resistance.

3. Coolant

The engine must be filled with long-term coolant, which should have the functions of anti-corrosion, anti-rust, anti-scaling and anti-boiling. To prevent frosting at low-temperature start due to the pressure regulator's failure to heat timely, ensure that no coolant ice under -40°C .

4. Design of the cooling system when added with a hydraulic torque converter

If the vehicle is equipped with a hydraulic torque converter (automatic transmission) which needs to be cooled through the engine cooling system, it is recommended to use an independent cooling system, otherwise the coolant must be used to cool down the engine before cooling of the hydraulic torque converter.

3.5.2 Intake & exhaust system

1. Design requirements for the intake system:

- The hot air in the engine compartment may not be absorbed into the intake system;
- Raindrop and mist may not be absorbed directly into the intake system;
- The air intake pipe between the air filter and the turbocharger must be made of the corrosion-resistant material;
- The system resistance should be as low as possible, and the maximum on-way resistance before air is absorbed into the turbocharger should be less than 6Kpa;
- Maximum on-way resistance before the turbocharger of the intake system should be less than 40Mbar. The increase of air intake resistance will cause the decrease of the engine power.

2. Intercooler system

High temperature in the air intake system means that the density of air entering the engine is reduced, which may cause the engine power reduction, the rise of exhaust gas temperature and the decrease of the engine reliability. The temperature after intercooling should be guaranteed to be less than 55°C in any condition.

3. Air intake pipe

- Their intake pipes include the pipes between the turbocharger and the intercooler and the pipes between the intercooler and the engine intake pipe. In principle, the air intake pipe should be as short as possible and should be helpful for air flow. The pipe should be shaped as an obtuse angle at the turns, and an elbow should be used at right angles;
- If the air intake pipe passes by a hot component, an insulation device must be installed between the air intake pipe and the hot component.
- The rubber hose of the high-pressure pipe after the turbocharger must be oil-resistant and can withstand high pressure more than 5bar and high temperature more than 240°C. The pipe that transits from small diameter to large diameter should be designed into a cone;
- The air pipe before the turbocharger should be arranged coaxially with the air intake axis of the air compressor, and the length of the straight section should be at least 2-3 times of the air inlet diameter of the air compressor.

4. Exhaust system

- Under the rated engine power, the exhaust back pressure should be less than 15kpa;
- The inner diameter of the exhaust pipe should be no less than the inner diameter of the exhaust outlet of the turbocharger;
- The exhaust pipe should be made of the material with smooth inner surface, and the pipe should be free of sharp corners and right-angle bend;
- A flexible connection should be used between the turbocharger air outlet and external exhaust pipes;
- The catalyst should be installed in the direction of the arrow, and should be installed at least 1m on downstream of the exhaust outlet.

3.5.3 Engine compartment

1. The radiant heat of the gas engine is higher than that of the diesel engine. When designing the engine compartment, the ventilation equipment must be improved.
2. The space more than 280mm should be reserved on the upper part of the rocker arm cover, so as to facilitate the maintenance of spark plugs and adjustment of valve clearance.
3. A maintenance window as large as possible should be the floor above the engine.
4. The engine's gas system are generally installed on the side of the cowl, and the cowl should be reserved with a maintenance window as large as possible so as to facilitate the maintenance.

3.5.4 Power supply requirements

1. The electric control system of the engine requires maximum current 25A, and the electric devices of the engine requires the voltage 24V. Please select the appropriate battery according to vehicle requirements.
2. The engine must be stopped by means of positive shut-off.
3. The system power grounding and digital/analog grounding should be separately connected to the negative terminal of the battery.

3.6 Precautions

1. Precautions for LNG engine users

- (1) If the liquid level in LNG cylinder is less than half of its capacity after storage for more than 7 days,

LNG should be filled timely;

(2) If the LNG cylinder is stored for more than 15 days, drain the LNG in the cylinder as much as possible and refill LNG before the operation of the vehicle. If the estimated vehicle out-of-service time exceeds 15 days, the LNG in the cylinder should be run out.

(3) If the LNG cylinder is stored for more than 7 days, when driving the vehicle for rehydration, do not step on the accelerator pedal forcedly after starting the engine, warm up the engine at idle speed, and run the vehicle after the water temperature rises above 60°C. In the process of running, the engine speed should be lower than 1400 r/min, and the vehicle speed should be less than 20km/h.

2. Precautions for LNG vehicle users

(1) If the LNG vehicle is not used for a long time, the user should pay attention to the liquid level in the LNG cylinder. It is recommended to observe the liquid level every 24h;

(2) When filling LNG at a non-authorized station, user should request the gas composition table from the station, and if the gas composition is significantly different from that of the authorized station, LNG filling at the station should be refused.

4 Maintenance of the natural gas engine

4.1 Fuel, lubricating oil, coolant and auxiliary material for the natural gas engine

4.1.1 Fuel

CNG and LNG natural gas can be used as fuels of Weichai natural gas engine.

4.1.2 Lubricating oil

The natural gas engine should use the special oil. See Table 4-1 for specific standards.

Table 4-1 Weichai engine oil selection specification

Type	Package specifications	Main applicable models
Natural gas engine Special oil	4L, 18L, 170kg	Natural gas engine

Weichai engine oil viscosity should be selected according to the temperature. See Table 4-2.

Table 4-2 Viscosity and ambient temperature relationship

SAE viscosity level	Applicable ambient temperature (°C)
0W/20	-35-20
5W/30	-30-30
10W/30	-25-30
15w/40	-20-40
20w/50	-15-45

ATTENTION:

- (1) Before starting the natural gas engine, make sure to check the oil level in the oil pan.
- (2) Do not check the oil level when the natural gas engine is running.
- (3) Weichai engine special oil may not be mixed with oil of other brands.

See Table 4-3 for the oil filling amount and the number of filter elements of WP12NG natural gas engine.

Table 4-3 Oil filling amount and the number of filter elements

Model	Oil filling amount (L)	Number of filters	
		Oil filter	Gas filter
WP13	25-28	2	1
Remark:			
(1) The amount of oil filling is for reference only, and the actual filling amount is subject to the dipstick.			

4.1.3 Coolant

The cooling system of the natural gas engine must be filled with pure coolant, which has the antifreeze and anti-boiling properties, can avoid freezing in cold weather or "boiling" under high temperature and is applicable for vehicles under different temperature, which gives a special protection for the water tank and the engine cooling chamber.

The properly selected coolant can effectively protect the engine components and extend the service life of the engine. See Table 4-4 for more details.

Table 4-4 Natural gas engine coolant

Coolant grade	-#25	-#35	-#45	-#50	Remarks
Applicable min. temperature, °C	-15	-25	-35	-40	Since the coolant of LNG vehicle needs to provide the heat exchange for the vaporizer, the freezing point of antifreeze selected for CNG vehicle should be at least 10° C below the local minimum temperature.

- Before starting the engine, check the coolant level and check the engine cooling system for any leakage.
- When the engine is running, observe whether the coolant temperature falls within the specified range. The normal water temperature should be 80-95°C below 3000 m sea level.
- When filling or changing the antifreeze for LNG engine, make sure to bleed at the water outlet of the vaporizer, so as to prevent the gas blocking from affecting LNG vaporization.

4.1.4 Auxiliary materials

Table 4-5 Auxiliary materials for natural gas engine

No.	Name	Color	Application
1	Molykotte Pulver (Fine molybdenum powder)	Black	Apply it onto a smooth metal surface to prevent holding-on v, applied on the outer surface of the cylinder liner
2	Molykotte G.u.plus (Molybdenum disulfide oiling agent)	Dark gray	Lubricate before the pressure builds up v, applied on the intake valve stem

Table 4-6 Reference list of natural gas engine gluing

Grade	Main application	List of gluing parts	Supplementary instruction
Weichai dedicated 242	Applied on the thread surface with a moderate force to prevent looseness due to vibration	Camshaft thrust plate bolt Camshaft timing gear bolt Middle idler bolt Oil cooler assembly bolt Air compressor shaft end thread Main oil channel pressure limiting valve thread Oil strainer bolt Bolts for sensor and wire harness fixtures	As an option, Dri-Co204 thread pre-applied coating can be used
Weichai dedicated 277	Used for sealing between core and hole	Compressor outlet and connection elbow combined circumference Cylinder head blocking Pipe fittings are connected to the water pipe connectors	

Weichai dedicated 962	Cup plug special glue	Auxiliary oil channel cup plug Main oil channel cup plug Cylinder block water cavity cup plug Camshaft hole cup plug Cylinder head cup plug	
Weichai dedicated 510	Applied on a bright metal surface for sealing	Engine block rear end face (Gear type) oil pump and engine block front end combined face	
Weichai dedicated 620	Used to hold cylindrical mating parts	Crankshaft upper gear mounting part	
Weichai special silicone	Applied on a bright metal surface for sealing	(Rotor type) oil pump and engine block front end combined face	

4.2 Routine maintenance of the natural gas engine

4.2.1 Daily operation of the engine

1. Check before startup

(1) Check the coolant level: observe the coolant level from the sight hole, and open the filler cap to fill the coolant when necessary. If the engine is already installed on a vehicle or on a bench, the coolant level can be seen via the sight hole on the expansion tank at any time. If the coolant is insufficient, open the filler cap and add the coolant. When opening the filler cap with the pressure relief valve and the vent button, press the vent button before opening the cap when the engine is hot. Never fill a large amount of coolant to the engine when the engine is hot, which may damage the parts due to sharp change of temperature.

ATTENTION: When opening the filler cap, always press the vent button to prevent personal injury due to the hot coolant when the engine is hot.

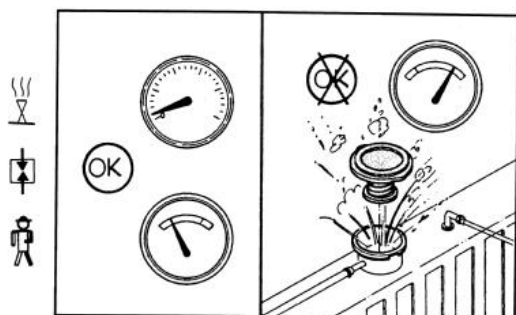

Fig. 4-1



Fig. 4-2

(2) Check the oil level: Never start the engine when the oil level is lower than min. scale or higher than max. scale of the dipstick.

Before checking the oil level, wait for at least 5 min. after the engine stops so that the oil can flow back to the oil pan.

The difference between min. scale and max. scale of the dipstick is 3L.

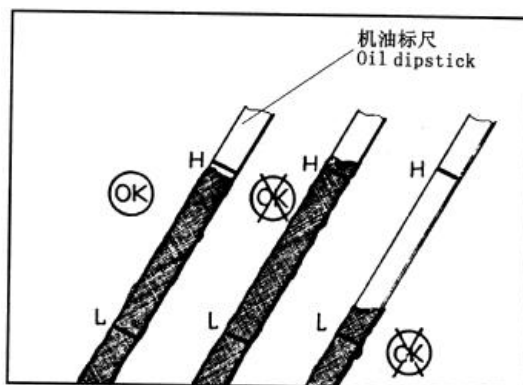

Fig. 4-3

- (3) Check for leakage: the engine should be free of water, gas or oil leakage.
- (4) Check the fan: visually check if the fan blades are damaged and the connecting bolts are tightened.
- (5) Check the belt: the belt is tensioned automatically by the belt tensioner, and user can press the belt with his hands to check if it is tightened.
- (6) Check if the gas tank and gas pipes are fixed firmly on their brackets, if the gas pipe fittings have leakage and if the gas pipes are involved with wearing, cracking or leakage.
- (7) Check if the gas pipe behind the vaporizer of LNG engine is involved with frosting or freezing, and if yes, the engine can be started only after the failure is eliminated completely.
- (8) Check the rubber hose for aging, cracking or crushing. In particular, check if the water circuit of the vaporizer of LNG engine waterway is smooth.
- (9) Check if the sensor connector is loosened, and if the wire harness falls off or is scratched or pulled at the position close to the exhaust pipe.
- (10) Check if the gas meter pressure is normal. And that is, the gas pressure should be higher than 3MPa for CNG vehicle and the gas pressure should be higher than 8 bar for LNG vehicle.
- (11) It is necessary to observe the liquid level display on LNG vehicle to determine the amount of liquid stored in the cylinder.

4.2.2 Start the engine

- (1) Before starting the engine, switch on the ignition key and pause for 3-5s so that the gas pipe can be filled with gas and ECM is powered on.
- (2) Do not step on the pedal when starting the engine. The throttle opening and gas injection amount are controlled by ECM.
- (3) Run the engine at idle state for 30s after startup so as to check the oil pressure and water temperature rather than depress the pedal. If failed to start for 3 consecutive times, re-check the gas and circuit parts carefully.
- (4) In order to protect the starter, the starting time may not exceed 15 s, and the starting interval should be greater than 30 s.
- (5) LNG vehicle must be idling for more than 3 min after startup. At the same time, check the gas pipe behind the vaporizer for frosting.
- (6) Check if the engine sound is normal.
- (7) Check if the engine speed and vibration are normal (in the process of checking, pay attention to your safety and avoid any personal injury due to the operating belt).

4.2.3 After the vehicle is started

- (1) After starting the natural gas engine, run it at idle for 3 min., and then raise the speed to 1000-1200 r/min with partial load. Only when the water temperature is higher than 60°C and the oil temperature is higher than 50°C can full load operation be enabled. The load and speed should be increased gradually, avoiding sudden speed increase and sudden unloading.
- (2) The natural gas engine should, within the 50h running-in period (the first running of 3000km), run below the medium load without a trailer.
- (3) It is necessary to slow down in time on the slope, and it is not preferred to run the engine for a long time under high torque or small load, because the engine is prone to oil pumping or other failures when

the speed is low.

(4) The natural gas engine is allowed to operate continuously at rated power and rated speed under normal operation, but maximum 20 min. if operated at 105% of rated speed and 110% of rated power. The natural gas engine should, after unloading, be idle for 1-2 min. before stopping.

(5) Depress the accelerator pedal slowly when driving. When passing a water-logging road, decelerate the vehicle to prevent water from being splashed on electric components. If the engine has a failure, stop the vehicle for inspection to prevent further failure. When the failure indicator comes on, drive the vehicle to an appropriate area for repair if the engine's mechanical parts work normally.

(6) After the vehicle is started, the engine will be under high temperature. At this moment, do not stop the engine and run it for 3-5 min. Stop the engine after the parts are normally cooled.

(7) It is recommended that the vehicle that is equipped with the natural gas engine should coast down according to road conditions, which can reduce the gas consumption. When the vehicle coasts down, the gas control system will stop the gas injection.

(8) The parameters and inspection positions to be noted during the operation of the engine:

- ① Main oil channel pressure of lubricating oil (350-550) kPa.
- ② Oil temperature in oil pan $\leq 110^{\circ}$ C.
- ③ Coolant outlet temperature $80 \pm 5^{\circ}$ C, not exceeding 95° C.
- ④ Post-turbocharger exhaust temperature $\leq 650^{\circ}$ C.
- ⑤ Post-intercooler intake temperature $50 \pm 5^{\circ}$ C.
- ⑥ Make sure to check if the natural gas engine has the leakage of water, gas or oil. If yes, stop the vehicle for troubleshooting.

(9) Operators should understand the following characteristics of the natural gas engine:

- ① When the torque is high, the gas consumption rate will be low, and the gas consumption rate will increase with the speed
- ② The torque will reach its maximum value within the medium engine speed range (1300r/min-1500r/min).
- ③ The engine power will increase with the speed, and reach the calibrated power at the calibrated speed.

(10) Precautions for the engine operation in cold conditions;

- ① Lubricating oil: The lubricating oils of different viscosity should be selected in different seasons.
- ② Coolant: Antifreeze additives should be added to the cooling system, and different grades and different proportions should be selected under different outdoor temperature.
- ③ Start: In winter, the auxiliary starter can be used when necessary. The natural gas engine should, after startup, come into high-speed operation after the oil pressure and water temperature are normal.
- ④ Battery: Before the cold season, make sure to check the electrolyte level, viscosity and unit voltage. If the natural gas engine is not used for a long time and is at a very low temperature, the battery should be removed and stored in a warm room.

4.2.4 Shutdown of the natural gas engine

◆ Before stopping the natural gas engine, unload the engine gradually and run it at the medium and low speed for a few minutes. After the coolant temperature drops below 70° C, turn off the key and stop the engine.

◆ If the natural gas engine must be stopped immediately in case of emergency, turn off the key directly and stop the engine.

◆ After stopping the engine in winter, the water drain switches on the engine block and the radiator must be opened to drain the coolant completely, so as not to damage the engine block, water pump and radiator. When draining water, the water filler cap on the radiator must be opened, so as to empty the coolant.

4.3 Maintenance requirements of the engine systems

Weichai natural gas engine is a high-performance electronically controlled engine with many sophisticated components, which require careful maintenance so as to give a full play to the engine dynamic property and economy and extend its service life. The user should take effective waterproof measures for the engine to avoid unnecessary failures. See Q/WCQTG0017 "Maintenance Specifications of Weichai Gas Engine" for routine engine maintenance and routine maintenance interval and related items.

◆ Lubrication system

Please check the oil level every day before starting the vehicle, park the vehicle on a flat road, and before starting the vehicle or after parking for 15 min. and the engine cools down, pull out the oil dipstick to check the oil level. Do not start the engine when the oil level stays below min. scale or above max. scale of the dipstick.

When changing the oil, unscrew the plug for draining oil at the bottom of the oil pan, and then screw it on after draining the used oil; open the oil filler cap and fill the dedicated oil for Weichai natural gas engine until it reaches the specified scale; and finally tighten the oil filler cap. Change engine oil.



Plug for draining

Oil filling port

Fig 4-4

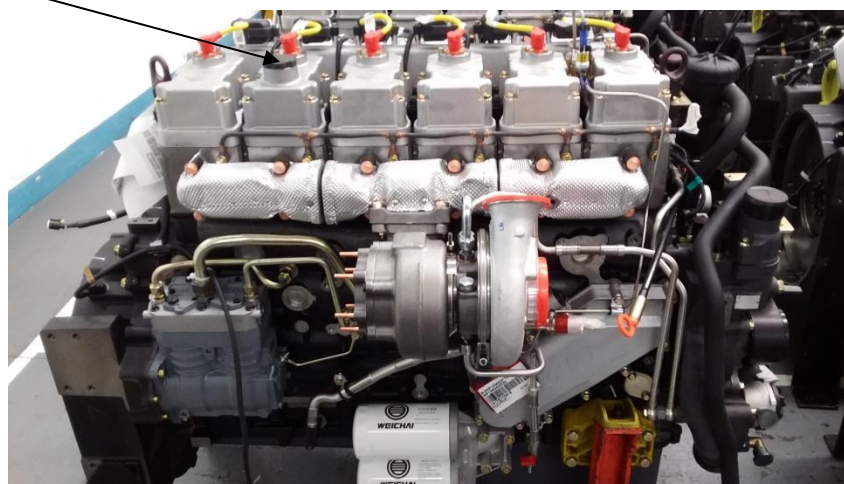

Fig 4-5

ATTENTION: Waste oil should be stored in the designated location and container.

Replace the oil filter or the filter element as shown in Fig. 4-6.

When replacing the oil filter, proceed as follows:

- ① Remove the used oil filter;
- ② Fill the clean oil in the new filter;
- ③ Apply oil on the pad before installing the new oil filter;
- ④ After the pad contacts the base, tighten it again for 3/4-1 circle for sealing;
- ⑤ Start the engine and check for oil leakage.

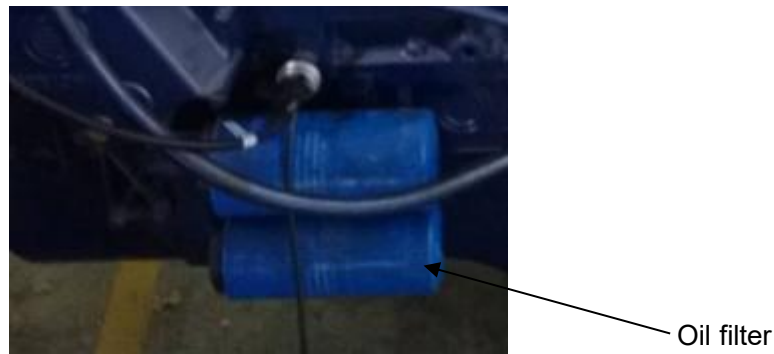

Fig. 4-6

It is recommended to use the dedicated oil for Weichai natural gas engine, and the oil change intervals should be executed in accordance with Q/WCQTG5.27-2010 "Weichai Natural Gas Engine Oil Specifications".

◆ Ignition system and other electrical systems

The Weichai natural gas engine is equipped with electronic control unit (ECM), sensor, ignition module and other electronic components, and high voltage or excessive current may cause a destructive damage to electrical systems. Therefore, power supply must be switched off before the welding operation. Deactivate the master battery switch, and disconnect the battery negative; remove the wiring harness connectors connected to ECM. Maintenance of the ignition system components should be executed according to the component maintenance requirements.

◆ Mechanical transmission system

Before the engine is started, the external mechanical transmission systems should be checked for the tension and wear of the belt. The belt is tensioned automatically through the tensioner and can be checked for tension through pressing it with your hands. The fan bracket should be filled with grease regularly.

◆ Engine water circuit

Compare with the diesel engine, the natural gas engine is additionally provided with three water circuits. Regularly check the connection of the water circuits to keep them in good conditions, check if the rubber hose is involved with aging, cracking or crushing, and if yes, solve them timely.

◆ Air system

The air filter should have good performance, and in particular, it is recommended to use oil bath air filter or desert air filter in the mining area. Never start the engine without an air filter. The intake air must be filtered to prevent dust from entering the engine and causing engine to wear earlier. Check if the intake pipe is involved with aging, cracking or perforating, check if the clamp is loosened, and if yes, tighten or replace it to ensure that the inlet pipe is sealed to prevent any air leakage.

◆ Valve clearance

After the first running of 20,000 km, the valve clearance must be checked and adjusted. Check the valve clearance in case of Level 1 maintenance after 20,000 km.

Check and adjust the exhaust/intake valve clearance. Steps:

① When the natural gas engine is cold, turn (according to engine running direction) to the compression TDC of 1st cylinder or 6th cylinder. At this time, the notch on the flywheel is aligned with the pointer on the cover of the sight hole. See Fig. 4-7.



Fig. 4-7

② Remove the valve rocker cover on the cylinder head to check if 1st cylinder or 6th cylinder is in the compression stroke (there is a clearance between the intake/exhaust valves and rocker arm in the compression stroke), see Fig. 4-8.

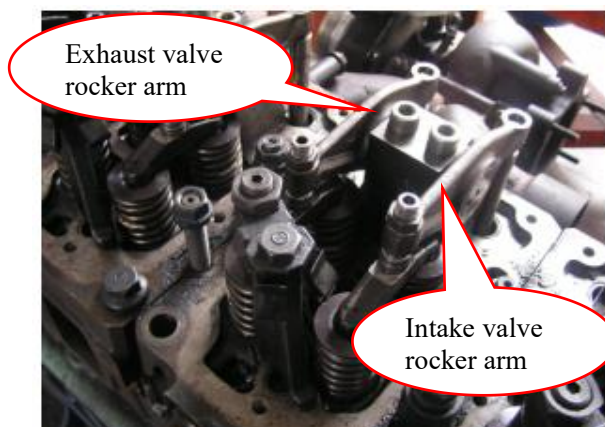
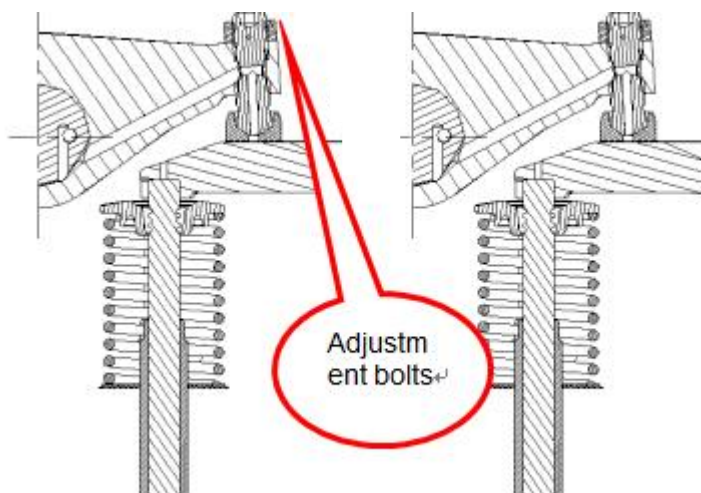

Fig. 4-8

③ Use a feeler gauge to check the clearance between the plane of the valve bridge and the rocker arm of the valve. WP13 4-valve natural gas engine requires the intake valve clearance of 0.4mm; the exhaust valve clearance of 0.6mm. If the clearance is wide or narrow, you can adjust the adjustment bolts on the rocker arm to achieve the clearance specified above. See Fig. 4-9.



The intake valve clearance is 0.4mm in cold state, and the exhaust valve clearance is 0.6mm in cold state

Fig. 4-9

④ After checking 1st cylinder or 6th cylinder, turn another 360 degrees to keep 6th cylinder or 1st cylinder in the operating stroke, check and adjust the rest valves.

Table 4-7

	1st cylinder	2nd cylinder	3th cylinder	4th cylinder	5th cylinder	6th cylinder
1st cylinder compression stroke	Intake/exhaust valve	Intake valve	Exhaust valve	Intake valve	Exhaust valve	Can not be adjusted
6th cylinder compression stroke	Cannot be adjusted	Exhaust valve	Intake valve	Exhaust valve	Intake valve	Intake/exhaust valve

4.4 Regular maintenance of natural gas engine

4.4.1 Maintenance Specification of Weichai Natural Gas Engine (Q/WCQTG0017)

Table 4-8 Application conditions for three categories of vehicle accessories

WGI category	WGII category	WGIII category
Severe application conditions (cold or hot weather, high dust content, short distance transport, vehicles used at construction sites, coal mines and mountains, construction machinery) or annual driving mileage less than 20,000km or annual operating hours less than 600h	Vehicles with annual driving mileage less than 60,000km, short- & medium-distance transport (for goods delivery)	Vehicles with annual driving mileage more than 60,000km, long-distance transport

Table 4-9 Intervals for routine inspection and maintenance

Application conditions / Item	WGI	WGII	WGIII
First maintenance	3000km or 50h	3000km	3000 km
Daily inspection	Daily	Daily	Daily
Routine inspection	Weekly	Weekly	Weekly
Level 1	Every 10,000 km or every	Every 20,000 km or every	Every 30,000 km or every

maintenance	200h	six months	six months
Level 2 maintenance	Every 20,000 km or every 400h	Every 40,000 km or every year	Every 60,000 km or every year
Level 3 maintenance	Every 40,000 km or every 800h	Every 80,000 km or every two years	Every 120,000 km or every two years

Table 4-10 Maintenance content of natural gas engine

Maintenance items	Maintenance content	Maintenance mileage
First maintenance	Change oil and oil filter element; check valve clearance; check and adjust the belt tension; check the clamp tightness on each pipe; check the bolt tightness; clean the fuel metering valve (FMV); drain the gas filter and check the filter element.	"Routine Inspection and Maintenance Intervals" should be followed. Level 2 & 3 maintenance should be performed with reference to level 1 maintenance. For level 1, 2 & 3 maintenance, the cumulative mileage or running time should be determined whichever comes first. Oil and oil filter element change interval should be executed in accordance with Q/WCQTG5.27-2010 "Weichai Natural Gas Engine Oil Specifications."
Daily inspection	Check oil level; check the coolant level; check the cylinder gas storage amount and pressure; check gas system pipe tightness; check the vaporizer (LNG) or pressure regulator (CNG) heating water circuit (wear, looseness, leakage, folding).	
Routine inspection	Check and clean air filter (daily cleaning is recommended in case of severe environmental condition); maintain the filter element for 5 times and replace the main filter element; drain the gas filter; check the intake system pipe (wear, looseness, leakage); check the turbocharger and heat exchanger water circuits (wear, looseness, leakage, folding); check the pressure regulator balance pipe and Wastegate control valve pipe (wear, looseness, leakage, folding); check electric circuit connection (wear, looseness, etc.).	
Level 1 maintenance	Replace the gas filter element; check and adjust the belt tension, check the various pipes (including water circuit, air circuit, gas circuit, oil channel, etc.); check the coolant capacity; fill the grease (such as water pump, fan bracket, signal generator, etc.).	
Level 2 maintenance	Check and adjust the valve clearance; check the spark plug; check the high voltage coil; check and adjust the ignition advance angle; clean the fuel metering valve; clean the mixer, and clean the electronic throttle; clean the Wastegate control valve; check the turbocharger bypass valve; replace small air filter; change the coolant; check the tensioner.	
Level 3 maintenance	It is recommended to replace the spark plug high voltage coil.	

4.4.2 Weichai Natural Gas Engine Oil Specifications (Q/WCQTG5.27-2010)

Table 4-11 Oil change interval

Natural gas engine series		WGI category	WGII category	WGIII category
Driving mileage				
First oil change	Drive 3,000km or 1 month	√	√	√
Routine oil change	Every 10,000km or 3 months	√	---	---
	Every 20000km or 3 months	---	√	√
ATTENTION: 1. When routine oil change interval is greater than 15,000km, it is recommended				

to use the dedicated oil of Weichai natural gas engine.

2. During the compulsory maintenance period, Weichai CN III dedicated CH-4 or above diesel engine oil can be used temporarily when the special engine oil for Weichai natural gas engine is not available

3. When the ambient temperature is below -15°C , it is required to use low temperature resistant natural gas engine oil.

4.4.3 Maintenance instructions

Weichai natural gas engine users must go to Weichai authorized service center for engine maintenance or repair.

1. First compulsory maintenance: Weichai offers the first compulsory maintenance free of charge. Please go to the nearest authorized Weichai service center to change oil and oil filter element;
2. Routine maintenance: according to vehicle conditions, vehicle applications and maintenance specifications go to Weichai authorized service center for routine maintenance. (Or ask the service center to offer door-to-door maintenance through consultation)
3. Vehicle maintenance: the vehicles equipped with natural gas engine must be sent to Weichai authorized service center for maintenance.
4. Weichai requires that users must purchase the dedicated accessories and oil for Weichai natural gas engine at Weichai authorized service center so as to ensure the good operation of your vehicle and extend its service life.

Tips:

1. Weichai requires that users must purchase the dedicated oil for Weichai natural gas engine at the authorized service center and receive the first compulsory maintenance, routine maintenance or engine oil change, so as to ensure the good operation of your vehicle and extend its service life.
2. Weichai will not bear any loss if user uses the non-dedicated accessories and oil of Weichai natural gas engine or receives maintenance at the unauthorized Weichai service center;
3. This manual is the supplementary of the previous maintenance specifications and operation instructions related to the natural gas engine, and the specifications herein shall prevail in case of any discrepancy.
4. The right of interpretation of this specification is reserved by Customer Service Center of Weichai Power Co., Ltd. Please consult on the customer service hotline at 400-6183066 or 800-8603066.

4.5 Maintenance of natural gas engine in case of long-term storage

◆ Cleaning of natural gas engine;

Before storage, all the rusty areas should be removed by proper methods, and all the parts treated with the protective agent (lubricant pipes, turbochargers, etc.) should be cleaned thoroughly.

◆ Protection work:

- ① After engine warm-up, drain oil, clean oil filter, and fill anti-rust oil;
- ② Fill the coolant with anti-rust agent;
- ③ Start the engine and run it at idle state for 15-25min;
- ④ Drain oil and coolant completely;
- ⑤ Protection for other parts;

◆ Protection during storage:

- ◆ In order to prevent moisture and impurities from entering the natural gas engine, the exposed areas of the natural gas engine such as intake, exhaust and coolant pipes should be covered and the engine hood should be covered with a plastic shield during the transportation and storage.
- ◆ External package should be provided in case of transportation.

5 Analysis and troubleshooting of common faults

Natural gas engine is designed and manufactured under a strict quality assurance system, and each engine has undergone the specified test before its delivery. At the same time, the natural gas engine is a kind of precision machinery, and normal maintenance are indispensable for its long-term efficiency. Generally, early engine failure may be caused by the following reasons:

- ◆ Unprofessional operation, management and improper use;
- ◆ Failure to carry out maintenance as required and even repair in place of maintenance;
- ◆ Poor quality of accessories, especially the use of cheap fake and shoddy products, which may significantly shorten the service life of the engine;
- ◆ Improper selection of lubricating oil grade or nonconformed lubricant oil.

5.1 Diagnostic methods

Generally, the fault diagnostic methods of natural gas engine include:

- ◆ Observing: determine the fault conditions by observing the engine exhaust and other characteristics.
- ◆ Listening: determine the nature and extent of the fault by hearing the abnormal noise of the engine.
- ◆ Cylinder stop: determine whether the failure occurs in a cylinder by stopping the cylinder. Generally, this method is to stop the gas supply to the cylinder suspected with a failure and compare the engine state before and after stopping the cylinder so as to narrow the scope of the fault location or cause.
- ◆ Comparison: For some assemblies or components, determine whether there is a fault by replacing them.

ATTENTION:

① The determination of the cause of the engine failure is a very careful work. Do not disassemble the engine before working out the cause, otherwise the failure cannot be eliminated, instead of a more serious fault due to improper assembly after disassembly.

② **For ECM, FMV, turbocharger and other key components, please go to Weichai authorized service station for inspection and repair.**

5.2 Common faults and troubleshooting

Table 5-1 Engine fault and analysis

Common faults	Possible cause	Troubleshooting and solution
1. Failure to start	1. There is no gas in the cylinder or the manual valve on the cylinder is not opened.	
	2. The high-pressure solenoid valve has no voltage or is burned out.	After switching on the ignition key, the solenoid valve will have a "click" sound. If the solenoid valve is damaged, replace it with a new one.
	3. The two relays on the engine control module are damaged. Check if the three power supply lines have voltage.	Switch on the ignition key, and use a multimeter to check if the relay and the fuse have 24V voltage according to the electrical schematic diagram.
	4. Gas pressure is low.	Check if the gas pipe leaks.

	5. The ignition module is damaged.	The ignition coil does not ignite when checking with the ignition timing light. Check the fault code, spark plug and high voltage coil.	
	6. The low pressure solenoid valve on FMV is not opened or is not opened to an appropriate position.	Use a laptop to check it, and switching on the ignition key, the gas pressure is lower than 850Kpa. Replace the solenoid valve or check the valve plug.	
	7. Air intake is not adequate	Check if the air filter and air intake system are involved with blocking or leakage.	
	8. Start speed is low (minimum start speed of 100r/m)	Check if the battery voltage can reach 24V.	
	9. Adjustment error of intake and exhaust valves	Check the valve clearance according to the operation instructions.	
	10. ECM is damaged.	Replace ECM.	
	11. Short circuit due to melting of the oxygen sensor connector.	Replace the oxygen sensor.	
	12. Electronic throttle is damaged.	Use the software to test the electronic throttle.	
	13. Some electric circuits on the vehicle are faulty, such as the neutral switch.	Check the electric circuits on the vehicle.	
	14. The speed sensor is faulty.	When testing with the software, there will be a fault code. Check the clearance between the toothed disc and sensor.	
	2. Unstable idling	1. Air inlet pipe leaks	Check the air intake pipe
		2. The spark plug or ignition system is faulty	Check the spark plug and use the monitoring software to troubleshoot the ignition system.
		3. Gas metering valve pressure is low	Check if the pressure regulator and gas pipe are blocked
		4. The electronic throttle is faulty	Use the monitoring software to troubleshoot the electronic throttle.
5. The electrical system is faulty		Use the monitoring software for troubleshooting.	
3. Exhaust pipe blasting	The blasting is mainly caused by the reburning of the unburned gas in the exhaust pipe.		
	1. One cylinder or several cylinders do not work (for example, the ignition module and ignition coil are damaged, cables of the ignition coil on some cylinders are exchanged, the spark plug fails to work normally, etc.)	Check the spark plug and use the monitoring software to troubleshoot the ignition system.	
	2. Gas supply is thick or thin (the pressure regulator fails to work normally).	Use the monitoring software to test the gas pressure for troubleshooting.	
	3. The difference in advance angle is high.	Check the ignition advance angle and check the phase sensor clearance.	

	4. The pores on the mixer core are blocked.	Clean the mixer core.
4. Poor acceleration	1. The manual valve on the gas tank is not fully opened.	Check the gas tank.
	2. Gas pressure is low.	Check if the pressure regulator, gas pipe and gas filter are blocked.
	3. Poor contact of electronic accelerator pedal connectors.	Use the monitoring software to test electronic pedal for troubleshooting.
	4. The ignition system is faulty.	Check the spark plug and use the monitoring software to troubleshoot the ignition system.
	5. The pores on the mixer core are blocked.	Clean the mixer core.
	6. The Pressure regulator is faulty.	Use the monitoring software to test the gas pressure for troubleshooting.
	7. Air intake is not adequate.	Check if the air filter and air intake system are involved with blocking or leakage.
	8. The difference in advance angle is high.	Check the ignition advance angle and check the phase sensor clearance.
	9. Clearance adjustment error of intake and exhaust valves	Check the valve clearance according to the diesel engine operation instructions.
	10. Low voltage in the system causes that the solenoid valve is not opened to an appropriate position or other electrical systems fail to work normally.	Check the battery voltage and check if the wire harness is connected falsely.
	11. ECM limits the throttle opening and Phi	Use the monitoring software for troubleshooting.
5. Under power, high vibration	1. The intercooler cracks or the intercooler connection pipe is loosened or cracked, or the connecting hose of the turbocharger exhaust control regulator falls off.	Check the air intake pipe and the turbocharger.
	2. The manual valve on the gas tank is not fully opened.	Check the gas tank.
	3. The ignition system is faulty.	Check the spark plug and use the monitoring software to troubleshoot the ignition system.
	4. Pressure regulator is faulty (oxygen content is high and no good combustion can be achieved).	Use the monitoring software to test the gas pressure for troubleshooting.
	Carry out a comprehensive inspection according to the troubleshooting methods 1, 2, 3, 4.	
6. High gas consumption	Carry out a comprehensive inspection according to the troubleshooting methods 1, 2, 3, 4, 5.	
	1. The oxygen sensor is faulty.	Use the monitoring software to check wire harness connection for troubleshooting.

6 Contact us

Weichai Power Co., Ltd.

Address: No. 197, Fushou East Road, High-tech Development Zone, Weifang City, Shandong Province

Postal code: 261061

Website: <http://www.Weichai.com>

Free service or complaint hotline: 400-6183066

800 free service or complaint hotline: 800-8603066 (only available on a fixed-line telephone)

Customer service center hotline: 0536-8235369 (Fax)

Appendix

(A) Q/WCQTG0011 "Specification of Replacement of Gas Filter Element of Weichai Natural Gas Engine"

I. Scope

This specification stipulates the technical requirements of replacement of gas filter elements of Weichai series engines such as WP5NG, WP6NG, WP6NG, WP10NG, WP12NG, WP13NG.

This specification applies to Weichai Power's CNG and LNG series engines which are equipped with WOODWARD OH2.0 system, OH5.0 system, OH6.0 system and BOSCH system.

II. Normative references

The following documents are indispensable for the application of this specification. For dated references, only those dated references apply. For undated references, the latest edition (including all amendments) applies.

GB/T20734-2006 Installation Requirements of Special Equipment of LNG Vehicle

QC/T755-2006 Technical Conditions of Special Equipment of LNG Vehicle

QWCQTG4.22-2010 Technical Specifications of Accessories of LNG Engine

III. Gas filter element replacement process

Drain during routine inspection. Check and replace the filter element during level 1 maintenance.

Note 1: Drainage of the gas filter should be carried out after the system pressure is released.

Note 2: The user should regularly replace the filter element according to the operation instructions. The user shall assume the repair responsibility if the failure to replace the filter element causes high intake resistance, engine weakness or FMV clogging.

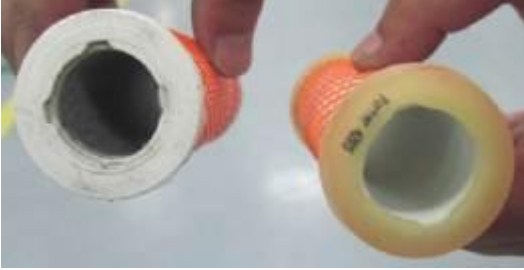
Diagram of the faulty filter element which is not replaced for a long time	Diagram of comparison between a faulty filter element and a new one
	 <p>The faulty filter element on the left: the inner wall has a serious stain, which is visible to the naked eye</p> <p>The new filter element on the right: the inner wall is clean without dirt</p>

Steps to remove, inspect and replace the low-pressure filter:

1. First of all, close the cylinder valve and release the pressure in the gas pipe. After the pressure in the system is released, unscrew the filter drain valve to drain until the liquid runs out and then close the drain valve.
2. Unscrew the filter housing using a suitable removal tool.
3. Unscrew the plastic cap under the filter element.
4. After replacing the filter element, screw on the gas filter components one after one, tighten them and restore their original states.

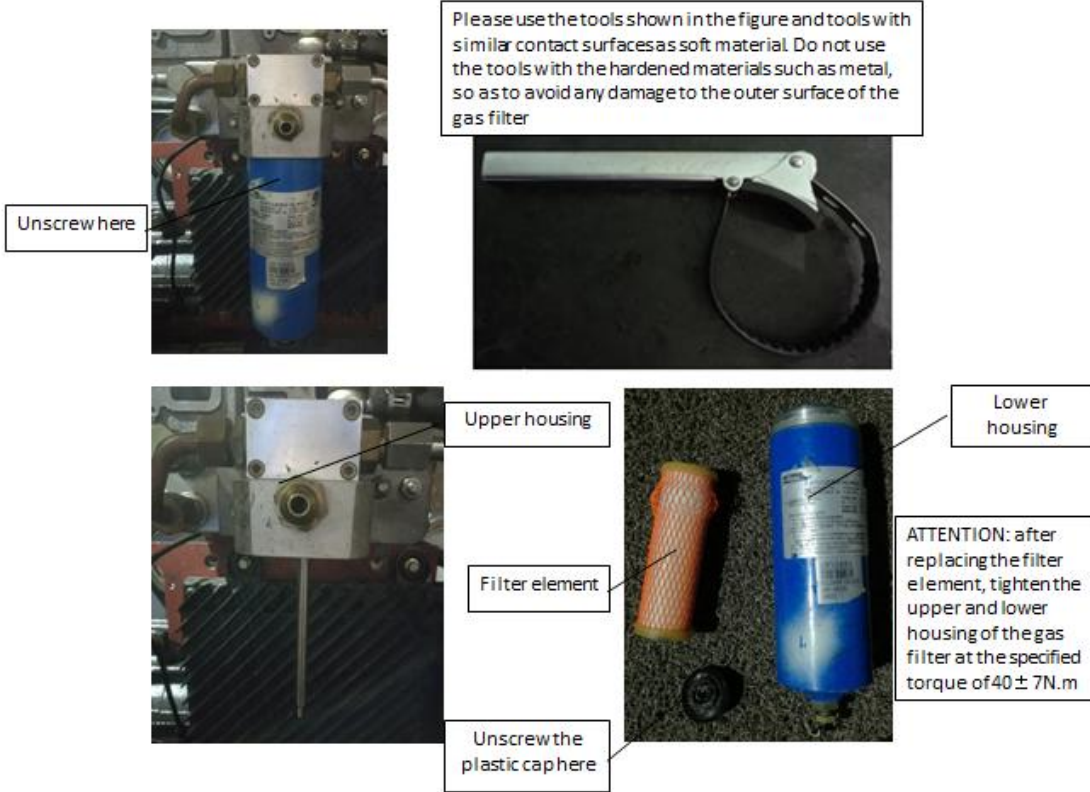

Schedule:

List of gas filters				
No.	Name	Part number	Qty. (pcs/set)	Remark
1	Temperature control module	612600191035	1	
2	Gas filter	612600190338	1	
3	Filter element	612600190646	1	

(B) Q/WCQTG0070 "Specification of Fault Diagnosis and Maintenance of Wastegate control valve"

I. Scope

This specification stipulates the technical requirements regarding repair of exhaust controls valves of Weichai series engines such as WP5NG, WP6NG, WP7NG, WP10NG, WP12NG, WP13NG.

This specification applies to Weichai Power's CNG and LNG series engines which are equipped with WOODWARD OH2.0 system, OH5.0 system, OH6.0 system and BOSCH system.

II. Normative references

The following documents are indispensable for the application of this specification. For dated references, only those dated references applies. For undated references, the latest edition (including all amendments) applies.

GB/T20734-2006 Installation Requirements of Special Equipment of LNG Vehicle

QC/T755-2006 Technical Conditions of Special Equipment of LNG Vehicle

QWCQTG4.22-2010 Technical Specifications of Accessories of LNG Engine

III. Wastegate control valve fault diagnosis process

Application environment: all English and Chinese Toolkit service interfaces of WOODWARD OH2.0, OH5.0 and OH6.0.

Application object: WOODWARD Wastegate control valve. All personnel must confirm according to this specification before replacing the Wastegate control valve.

IV. Wastegate control valve fault diagnosis process

The operating mode of the Wastegate control valve works is simple and is controlled by ECU signal. The Wastegate control valve should be deemed faulty in case of one of the followings. The diagnosis steps are detailed below:

Step 1: Observe whether the appearance is damaged seriously.

- Wastegate control valve should be deemed faulty when the wire breaks;
- Wastegate control valve should be deemed faulty when the valve body and joints are deformed or damaged seriously;
- Wastegate control valve should be deemed faulty when the connectors are deformed or damaged seriously;

Step 2: Use a multimeter to measure the resistance of the solenoid coil of the Wastegate control valve and make a judgment. First of all, disconnect the Wastegate control valve connectors and use a multimeter to measure the resistance between Pins 1 and 2 of the Wastegate control valve: the normal resistance (room temperature) is $77 \pm 2.5 \Omega$.

- Wastegate control valve should be deemed faulty when the measured resistance is 0;
- Wastegate control valve should be deemed faulty when the measured resistance is infinite;
- Wastegate control valve diagnostic test should be performed when the measured resistance is normal.

Step 3: Perform a diagnostic test on the Wastegate control valve. Under normal conditions, the value of "Boost PWM DC Output" falls within $X \pm 0.5$ (X is the target value).

- Wastegate control valve should be deemed faulty when the value of "Boost PWM DC Output" is 0.5 below the target value X.
- Wastegate control valve should be deemed faulty when the value of "Boost PWM DC Output" is 0.5 above the target value X.
- Wastegate control valve should be deemed faulty when SFC 691 error occurs during calibration.

Step 4: If no fault is found after the above steps, the Wastegate control valve should be deemed to work normally, and can be used again.



V. Wastegate control valve calibration process

Toolkit operation process

Step 1: Turn on the key switch, do not start the engine.



Step 2: Open toolkit and go to the "Diagnostic Modes - Wastegate Control Valve Test" page.

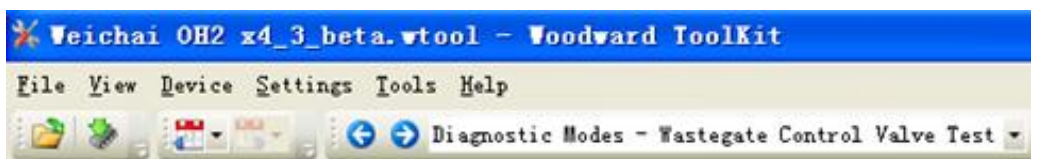

Step 3: Change the number in the red box to 7 and start the Wastegate control valve test. Manually enter the value X for five times in the green box (X is 0, 20, 50, 80, 100 respectively). Observe the value on the dial in the blue box to check if it falls within $X \pm 0.5$.

ATTENTION: The Wastegate control valve should be deemed faulty when one or more of the above target values and the entered values do not fall within the range during the five times of test.

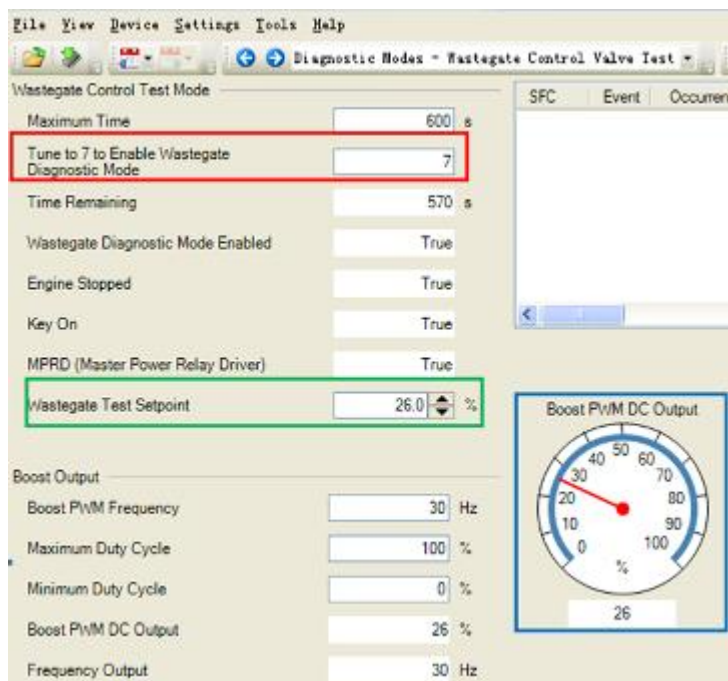

or

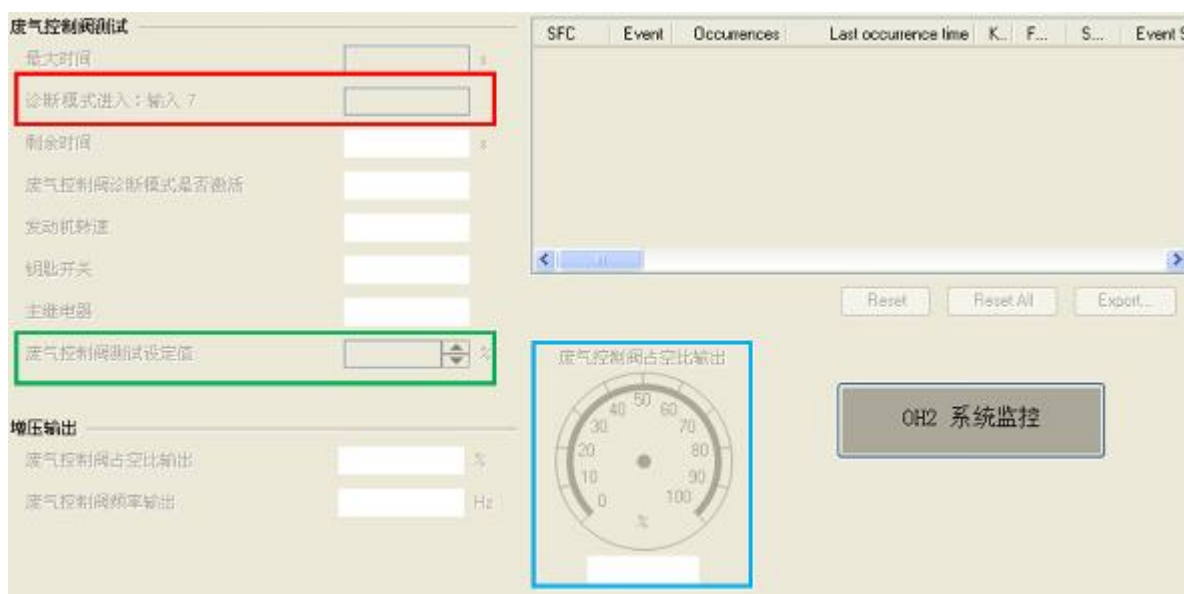

Step 4: After the test is completed, change 7 to 0, and end the diagnosis process of the Wastegate control valve.

VI. Maintenance specification of Wastegate control valve

The WOODWARD Wastegate control valve is involved with blockage of the air inlet and the muffler strainer after a period of use.

1. The WOODWARD Wastegate control valve must be cleaned whenever the engine runs 15,000 km or 3 months;
2. Steps to clean the air inlet of the Wastegate control valve:
 - A. The operator scraps the strainer at the air inlet of the Wastegate control valve with a fine wire;
 - B. The operator removes the tee on the valve body, and remove the dirt or sludge on the strainer surface with a cleaning agent (WD40 cleaning agent recommended);
 - C. The operator aims the air gun at the outlet of the tee, blocks the end leading to the muffler, blows out the gas from the strainer end, charges air from the strainer end, discharges air from the outlet end, and repeats the procedure until the filter is cleaned;

D. After cleaning, the operator installs the tee on the valve body and tighten it at the tightening torque of 14N.m.

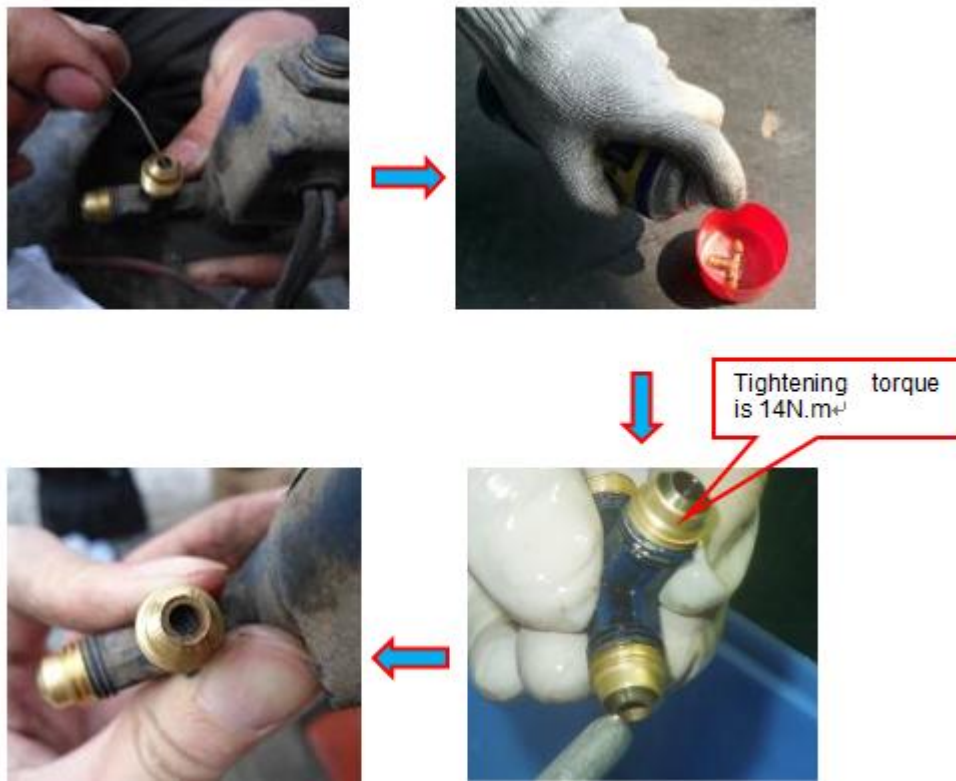

3. Steps to clean the muffler of the Wastegate control valve:

- A. The operator removes the dirt or sludge on the muffler surface with a cleaning agent (WD40 cleaning agent recommended);
- B. The operator removes the muffler, and clean the inner surface of the muffler with a cleaning agent (WD40 cleaning agent recommended)
- C. The operator blows the air from the outside to the inside with an air gun, then blows the air from the inside to the outside, and repeats the procedure until the inside and outside surfaces of the muffler are cleaned;
- D. After cleaning, the operator installs the muffler on the valve body and tighten it at the tightening torque of 8N.m.



(C) Q/WCQTG0071 "Specification of fault diagnosis and maintenance of Weichai oxygen sensor"

I. Scope

This specification stipulates the technical requirements regarding repair of oxygen sensors of Weichai series engines such as WP5NG, WP6NG, WP7NG, WP10NG, WP12NG, WP13NG.

This specification applies to Weichai Power's CNG and LNG series engines which are equipped with WOODWARD OH2.0 system, OH5.0 system and BOSCH system.

II. Normative references

The following documents are indispensable for the application of this specification. For dated references, only those dated references applies. For undated references, the latest edition (including all amendments) applies.

GB/T20734-2006 Installation Requirements of Special Equipment of LNG Vehicle

QC/T755-2006 Technical Conditions of Special Equipment of LNG Vehicle

QWCQTG4.22-2010 Technical Specifications of Accessories of LNG Engine

III. Installation requirements for oxygen sensor

The oxygen sensor is the key sensor to control the lean burn closed-loop air-fuel ratio. It sends oxygen content signal of exhaust to ECU, and ECU determines whether the actual air-fuel ratio of mixture is lean or rich with respect to the set value and controls the increase or decrease of the natural gas injection amount.

Installation requirements:

- The oxygen sensor should be installed at a place where the distance from the turbocharger outlet is 3-5 times exhaust pipe diameter.
- The oxygen sensor cannot be installed at the exhaust pipe bend.
- In order to prevent the oxygen sensor from being sintered onto the exhaust pipe, the anti-sintering adhesive should be evenly applied on the thread when installing the oxygen sensor.
- If the vehicle is equipped with an exhaust brake, the oxygen sensor must be installed at a position where the distance from the brake is 15-25cm.
- The oxygen sensor wire harness and connectors should be as far away from the exhaust pipe, not less than 20cm, so as to prevent sintering.
- The oxygen sensor (UEGO) and the wire harness connectors should be connected firmly without any loosening. If necessary, OEM should design a bracket to fix them.
- The oxygen sensor is attached with the Weichai engine, and OEM should install it according to technical requirements of Weichai Power.

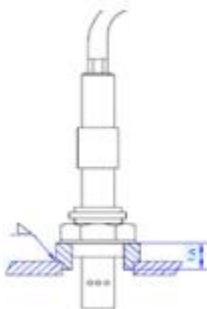

The height of the oxygen sensor bolt welded on the exhaust pipe should be less than 10mm.←



IV. Oxygen sensor air calibration process

Application environment: all Toolkit Service interfaces in English and Chinese of WOODWARD_OH2.0.

Application object: BOSCH oxygen sensor LSU 4.2. It is recommended that air calibration of the oxygen sensor

should be performed according to the procedure herein when the vehicle is replaced with a new oxygen sensor or when the vehicle runs in the area with low oxygen content or after major repair is made.

Toolkit operation process

Step 1: Turn on the key switch, do not start the engine, and place the oxygen sensor in the air.



Step 2: Open Toolkit and go to the "Diagnostic Modes - UEGO Test/Air Calibration" page.

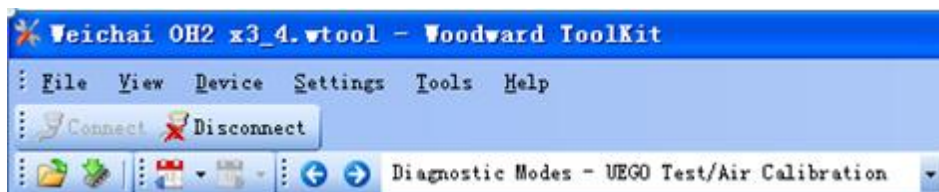

Step 3: Change the number in the red box to 7. Then the oxygen sensor starts to heat; at the same time, the countdown of 600 seconds in the blue box starts; the oxygen sensor heating temperature in the purple box starts to rise.

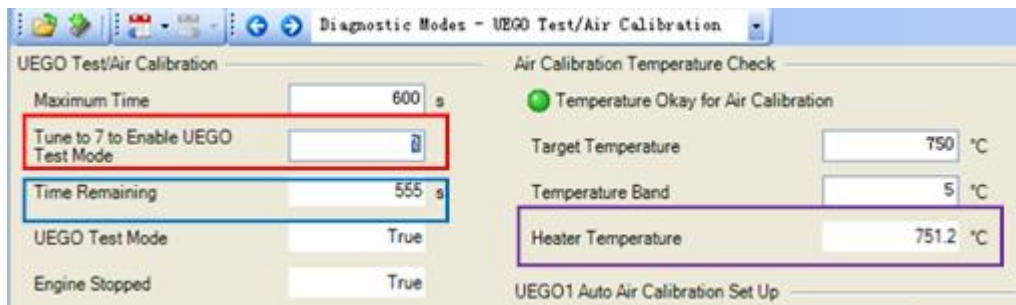

Step 4: When the "Heater Temperature" reaches about 750°C, the "Temperature Okey for Air Calibration" light will come on. After checking "Start UEGO1 Air Calibration", "UEGO1 Air Calibration" light will come on.

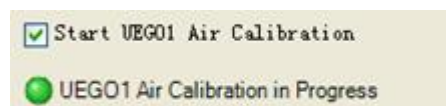

ATTENTION: Failure may occur during this step:

- If "Heater Temperature" always remains the default value (eg, 585.8°C), it indicates that the oxygen sensor heater circuit fails and also the oxygen sensor fails. The oxygen sensor should be replaced with a new one.
- If the "Heater Temperature" is always maintained at a high value (eg, above 900°C), it indicates that the oxygen sensor heater circuit fails and also the oxygen sensor fails. The oxygen sensor should be replaced with a new one.

Step 5: At this time, the oxygen sensor begins to measure the oxygen concentration in the air. Due to the intrinsic difference of the oxygen sensors itself, there is certain difference between individual values learned. If used for

the first time, a little longer learning time is available for the oxygen sensor d, and the data when the learned value is relatively stable should be selected as the final value.

ATTENTION: In general, after reaching the preset temperature and checking the indicator to light it up, the calibration can be ended when "Air Calibration Factor" shows a change for few seconds. The software of the previous version will end automatically.



Step 6: After learning, uncheck "Start UEGO1 Air Calibration" and change 7 to 0. At this time, calibration of the oxygen sensor will be ended.

V. Oxygen sensor failure determination process

The operating mode of the oxygen sensor is very complex, which requires an independent control chip. The oxygen sensor will be deemed faulty in case of one of the followings. A detailed determination can be made according to the following steps:

Step 1: Observe whether the appearance is damaged seriously

- The oxygen sensor will be deemed faulty when the wire is broken;
- The oxygen sensor will be deemed faulty when the body and probe are severely deformed so that they can not be assembled.
- The oxygen sensor will be deemed faulty when the connector is severely deformed or damaged so that it can not be assembled.

Step 2: Use a multimeter to measure the oxygen sensor heater circuit resistance and make a judgment. First of all, disconnect the oxygen sensor connectors and use a multimeter to measure the resistance between Pins 3 & 4. Normal heating resistance (room temperature): $3.2 \pm 0.8 \Omega$.

- The Wastegate control valve should be deemed faulty when the measured resistance is 0;
- The Wastegate control valve should be deemed faulty when the measured resistance is infinite;
- If the measured resistance is normal, air calibration of the oxygen sensor can be performed.

Step 3: Carry out air calibration of the oxygen sensor. Under normal conditions, "Air Calibration Factor" should fall within 1 ± 0.15 and the one-time calibration difference cannot exceed 5%.

- The oxygen sensor will be deemed faulty when "Air Calibration Factor" is below 0.85;
- The oxygen sensor will be deemed faulty when "Air Calibration Factor" is above 1.15;
- Wastegate control valve should be deemed faulty when SFC 139 error occurs during calibration.

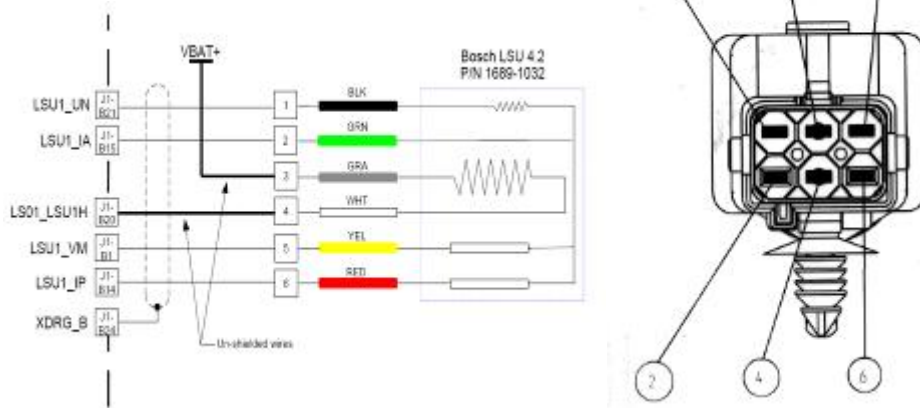

(D) Maintenance and determination specification of electronic throttle

I. Scope

This specification stipulates the technical requirements regarding electronic throttle repair of Weichai series engines such as WP5NG, WP6NG, WP7NG, WP10NG, WP12NG, WP13NG.

This specification applies to Weichai Power's CNG and LNG series engines which are equipped with WOODWARD OH2.0 system, OH5.0 system and BOSCH system.

II. Normative references

The following documents are indispensable for the application of this specification. For dated references, only those dated references applies. For undated references, the latest edition (including all amendments) applies.

GB/T20734-2006 Installation Requirements of Special Equipment of LNG Vehicle

QC/T755-2006 Technical Conditions of Special Equipment of LNG Vehicle

QWCQTG4.22-2010 Technical Specifications of Accessories of LNG Engine

III. Determination criteria of electronic throttle

Electronic throttle is a precision electronic control component which is used to precisely control the flow rate of the mixed gas, and is opened through the motor control against the butterfly valve. Therefore, attention should be paid to the operating voltage, operating temperature and other external environments of the electronic throttle. It is necessary to regularly check if the electronic throttle wire harness is reliable, the supply voltage is stable, or the butterfly valve is clean. The following steps should be followed if an electronic throttle failure occurs during the normal maintenance.

Part name	Item	Symptom	Inspection steps and methods	Cause	Solution
Electronic throttle	1	Engine cannot be started or the power is insufficient	When ECU reports an electronic throttle voltage fault (such as SFC541. etc.), check if the electronic throttle connector is in poor contact or the connector pins are intact, so as to ensure good contact.	Poor contact of electrical throttle	Repair
			When ECU reports an electronic throttle voltage fault (such as SFC541. etc.), check the wire harness according to the electric circuit diagram if the electronic throttle connector is in good condition.	Wire harness fault	Repair or replace the wire harness
			When ECU reports an electronic throttle voltage fault (such as SFC541. etc.), it indicates that the electronic throttle connector has an internal failure if the connector and wire harness are in good condition.	Electronic throttle internal failure	Replace the electronic throttle
			After the software enters the electronic throttle test mode, remove the electronic throttle if the electronic throttle feedback value is not consistent with the command value, visually check for pollution, and if yes, clean the electronic throttle butterfly valve with a cleaning agent. Replace the electronic throttle when the failure is not eliminated after cleaning.	Electronic throttle butterfly valve is stuck	Clean or replace the electronic valve
	2	The engine is powerless and the speed	If the software detects an abnormal fluctuation of the curve of the electronic throttle feedback value in the event of a fault, it indicates that the electronic	Electronic throttle signal interference	Remove any abnormal wire harness and suspicious sources

		<p>fluctuates sharply when the accelerator pedal is stable</p>	<p>throttle is involved with external electromagnetic interference, which affects the normal operation of the electronic throttle motor.</p>		<p>of interference near the electronic throttle; wrap the electronic throttle with foils.</p>
			<p>If the software detects an abnormal fluctuation of the curve of the electronic throttle feedback value in the event of a fault, it indicates that the electronic throttle has an internal failure if the failure is not eliminated after excluding the electromagnetic interference factors.</p>	<p>Electronic throttle internal failure</p>	<p>Replace the electronic throttle</p>

(E) Q/WCQTG0013 "Specification of Nozzle Cleaning of Weichai Natural Gas engine"

I. Scope

This specification stipulates the technical requirements regarding the BOSCHNGI-2 nozzle cleaning of Weichai series engines such as WP5NG, WP6NG, WP7NG, WP10NG, WP12NG, WP13NG.

This specification applies to Weichai Power's CNG and LNG series engines which are equipped with WOODWARD OH2.0 system, OH5.0 system and BOSCH system.

II. Normative references

The following documents are indispensable for the application of this specification. For dated references, only those dated references applies. For undated references, the latest edition (including all amendments) applies.

GB/T20734-2006 Installation Requirements of Special Equipment of LNG Vehicle

QC/T755-2006 Technical Conditions of Special Equipment of LNG Vehicle

QWCQTG4.22-2010 Technical Specifications of Accessories of LNG Engine

III. Nozzle cleaning equipment

1. Diagram of connection of cleaning tools of fuel metering valve is shown below. (Available from Weichai Power)

2. Laptop installed with WOODWARD diagnostic software. (The software to be installed will be provided by the natural gas engine service technician)

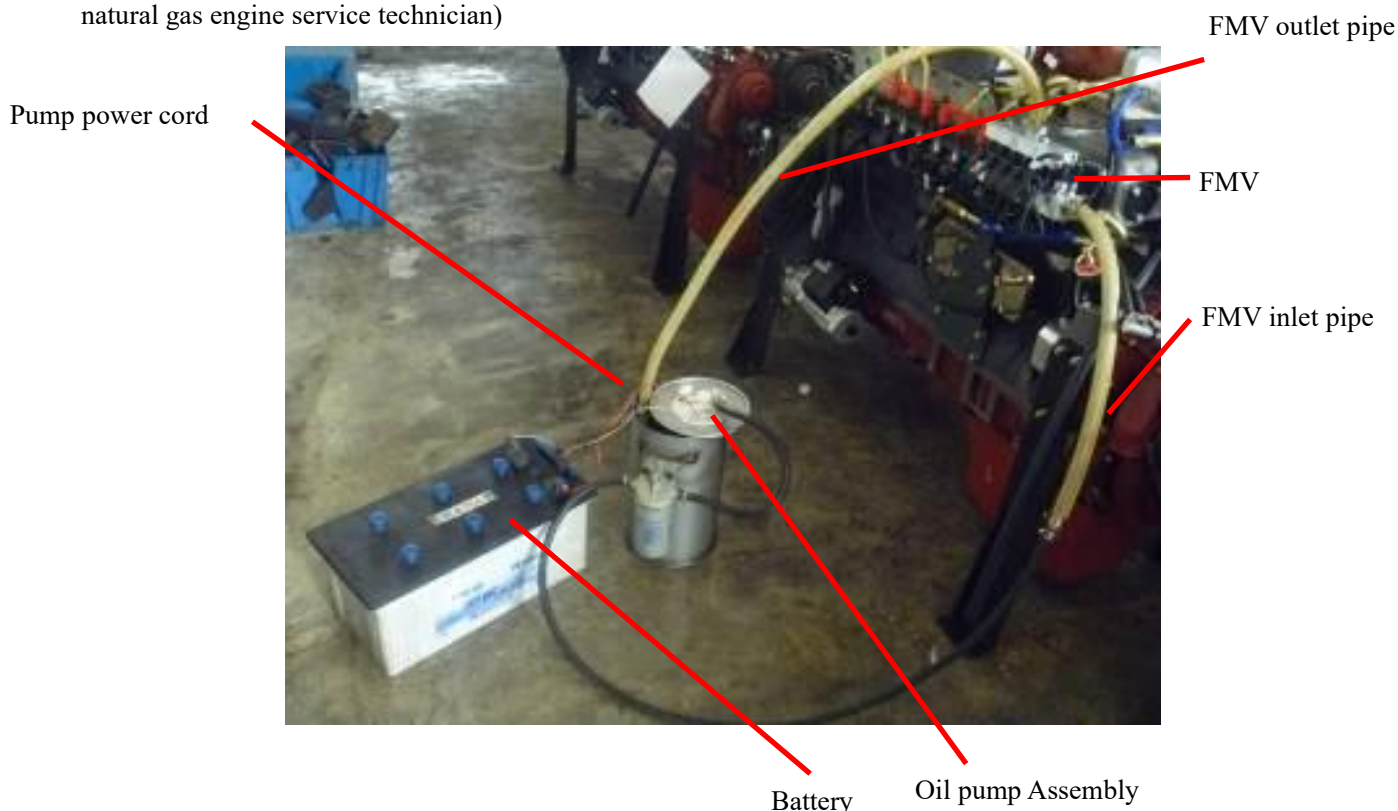

IV. OH2.0 system nozzle cleaning process

1. Oil channel connection.

Stop the engine and close the master cylinder valve. Open the fuel metering valve inlet/outlet pipes, connect the gas inlet of the fuel metering valve to the oil outlet of the diesel filter, and connect the gas outlet of the fuel metering valve to the barrel directly with a pipe.

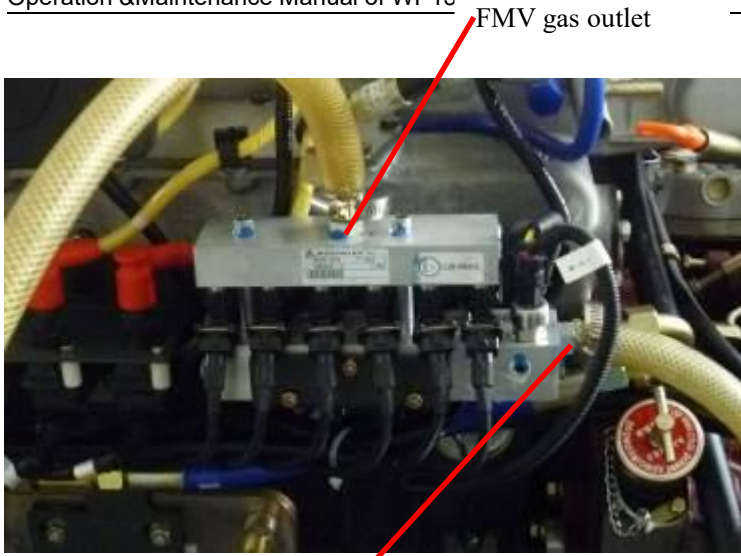

FMV gas outlet

FMV gas inlet

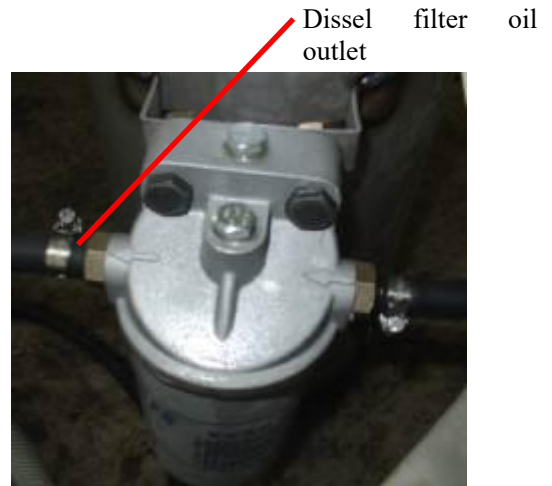

Dissel filter oil outlet

1. Electric circuit connection.

The cleaning tool of the fuel metering valve requires 12V direct-current main. Connect the positive and negative terminals of oil pump to the positive and negative terminals of the battery respectively, and install a switch in the circuit to control the pump start and stop.

ATTENTION: The pump has a total of four terminals. In the direction shown in the figure, the leftmost one is positive, the rightmost one is negative, and the middle two are void.

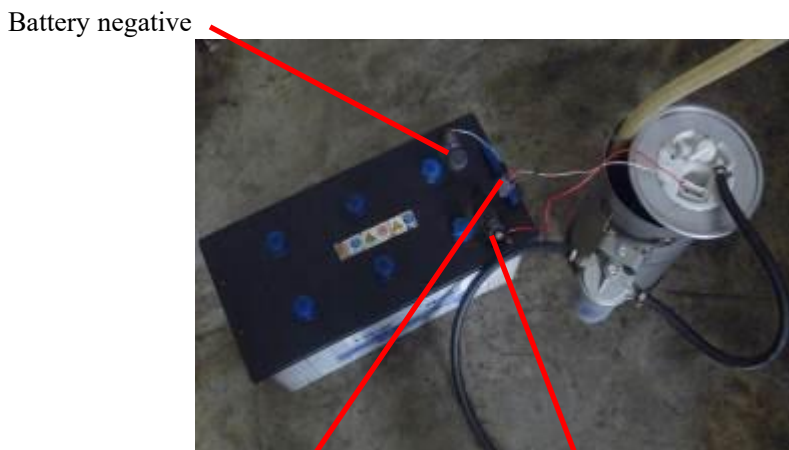

Battery negative

Pump switch

Battery positive

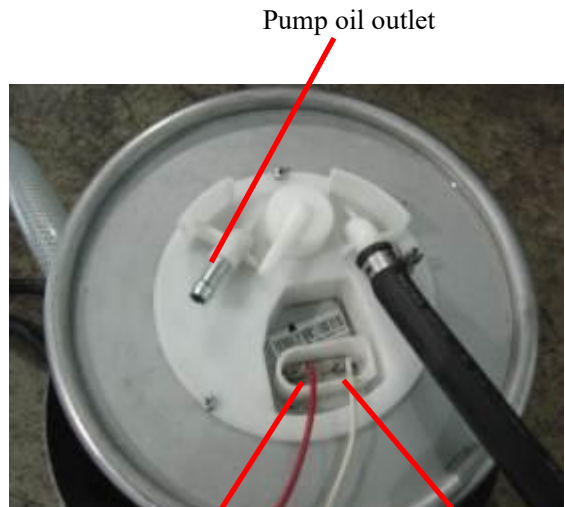

Pump oil outlet

Battery positive

Battery negative

3. Diesel filling.

Pour about 6L diesel into the pump barrel, with the top of the pump submerged by diesel.



Submerged Oil pump

4. Cleaning

1) First of all, switch the engine to the cleaning mode. The engine system is connected to the diagnostic software, and enters the “Diagnostic Modes-Injector Cleaning” interface, as shown below

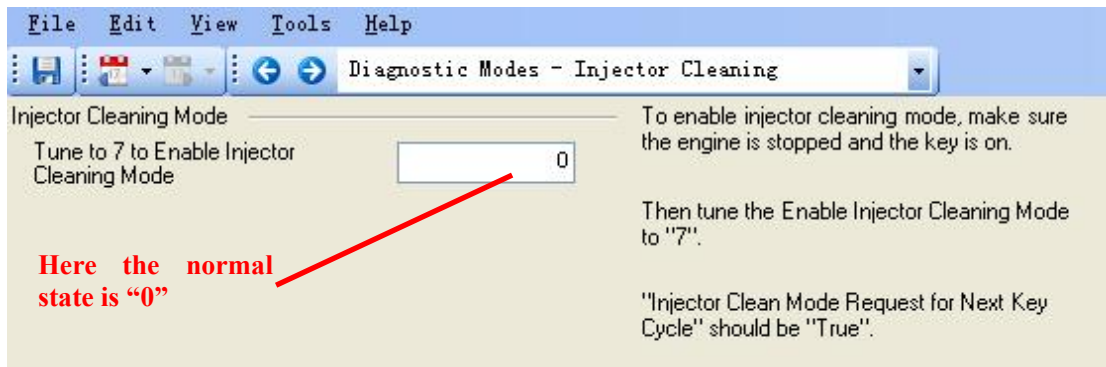

2) Chang “injector Cleaning Mode” from "0" to "7", and press the key “Enter”

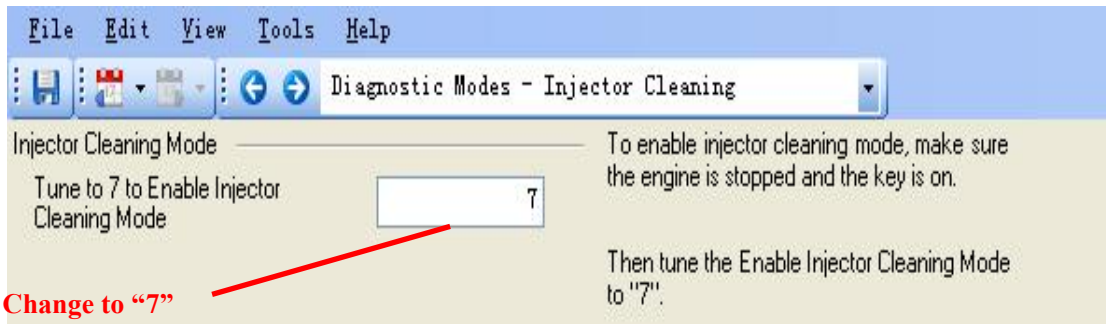

3) Turn off the ignition key, and power off the system for about 20 s until the diagnostic interface turns gray.

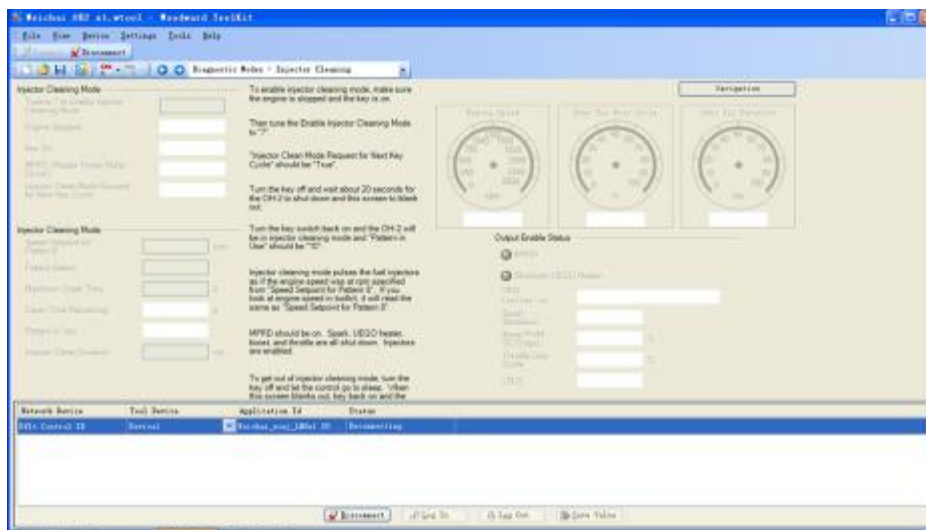

- 4) Then turn on the ignition key again (do not start the starter) to power on the system, and you will hear the sound from the fuel metering valve nozzle.
- 5) Next, quickly open the pump switch, so that the diesel can be pumped into the fuel metering valve and then flow back to the cleaning barrel.
- 6) If you want to repeat the cleaning, please repeat the above "cleaning" procedure.

5. Operation after cleaning

- 1) Disconnect the fuel metering valve inlet/outlet pipes, only connect the original inlet pipe, open the master cylinder valve and restore the gas supply.
- 2) Run the engine with the starter for 5 s and repeat the above operation. After five minutes, have natural gas flow through the fuel metering valve to purge the residual diesel therein.
- 3) Restore the normal state of the engine.

Schedule:

List of nozzle cleaning tools			Page 1 of 1	
No.	Name	Part number	Qty. (pcs/set)	Remarks
1	Nozzle cleaning tooling assembly	612600190678	1	
2	Santana 2000 pump assembly in barrel	612600190670	1	
3	Pump oil outlet pipe	Φ10 rubber hose	0.5 m	
4	FMV inlet pipe1	Φ10 rubber hose	1.5 m	
5	FMV inlet pipe2	Φ16 transparent hose	0.3 m	
6	FMV outlet pipe	Φ16 transparent hose	2 m	
7	Fuel coarse filter	61500080078B	1	Replace the coarse filter every 200 cycles of nozzle cleaning
8	Wire		8 m/pcs (2 pcs/set)	Red and white each
9	Rocker switch		1	
10	Connector	612600190311	1	
11	Connector	13050416	2	

12	Clamp (10-16)		6	
13	Clamp (22-32)		5	
14	Clean Diesel		6 L	
15	M10X35 bolt		2 sets	Include nut
16	12V direct-current main		1	

(F) Q/WCQTG0007 “Specification of Spark Plug Removal and Refitting of Weichai Natural Gas Engine”

I. Scope

This specification stipulates the technical requirements regarding spark plug removal and refitting of Weichai series engines such as WP5NG, WP6NG, WP7NG, WP10NG, WP12NG, WP13NG.

This specification applies to all series of CNG and LNG engines equipped with WOODWARD systems.

II. Normative references

The following documents are indispensable for the application of this specification. For dated references, only those dated references applies. For undated references, the latest edition (including all amendments) applies.

GB/T20734-2006 Installation Requirements of Special Equipment of LNG Vehicle

QC/T755-2006 Technical Conditions of Special Equipment of LNG Vehicle

QWCQTG4.22-2010 Technical Specifications of Accessories of LNG Engine

III. Requirements and steps for removal and refitting of spark plug

1. Before removing spark plug

Before removing the spark plug, purge the cylinder head surface with an air nozzle or high pressure air as far as possible

Then remove the high-voltage coil (when removing the high-voltage coil, make sure to pinch the head, do not pull the high-voltage coil body)

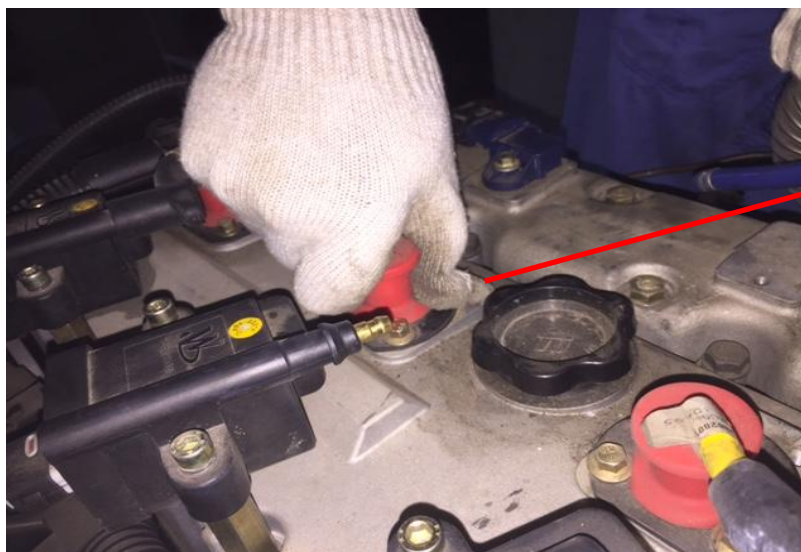

Please remove high-voltage coil as shown

And then use an air nozzle or high-pressure air to purge water, stain or dust inside spark plug sleeve.

2. Removal of spark plug

When removing the spark plug make sure the stem of spark plug wrench is perpendicular to cylinder head surface. If it is hard to remove spark plug, please using instrument to increase the length of arm of force.

Do not remove it forcedly when removing the spark plug, otherwise it may cause damage to the spark plug nut and the fixed parts or spark plug thread remaining in the cylinder head.



Correct removal method: After starting the engine, heat the cylinder head, fill the penetrating liquid into the threaded of the spark plug (CRC penetrating oil, etc.), five to ten minute later and then remove it.



ATTENTION: CRC penetrating dust-removal oil 3060 is an industrial lubricating rust inhibitor with low viscosity, which can remove the rust and loosen the rusty fasteners.

It is strictly forbidden to remove the ignition coil bushing and the pressing plate of ignition coil bushing to prevent the spark plug bushing from turning and moving.

If the spark plug bushing has occurred when removing spark plug bushing, the spark plug must be reset and rotate back to the initial state, and the ignition coil bushing clamp to verify whether meet the installation torque (20 ~ 25 N·m), complex tightly solid bolt after dismantled if did not meet the requirements of installation torque.

If none of the above methods can be successful, the liner or cylinder head shall be replaced.

It is necessary to check the tightening torque regularly and decide whether to tighten it according to the inspection result. The specific requirements are as follows:

For the newly launched vehicle, the first guarantee is check the tightening torque of the ignition coil liner, and it needs to meet the requirements of (20 ~ 25) N·m. If it is not satisfied, it needs the torque to be tightened. After the normal operation of the vehicle, the pressure plate bolts should be checked and tightened during the first grade maintenance, and the requirements need to be tightened.

The ignition system failure vehicle needs to check the ignition coil liner bolt tightening torque when replacing the spark plug.

All complex tight operation should be in accordance with the following requirements standardize operation: Firstly checking the spark plug twist moment whether meet the requirements (25 to 28) N·m, and the spark plug should be tightened to the required torque range if not meet, and try to ensure that the two bolt screwing in depth are equal, Checking whether lack of antifreeze, at the same time also need to remove the spark plug again. Checking whether impurity or liquid inside the cylinder, if not, installing the spark plugs accordance to specification.

As long as remove the clamp bolts to loosen bolts or other external forces of bolts should be removed and the thread end daub glue in all operations, according to the requirements of the torque range after screw down the bolt.

3. Cleaning of spark plug

Keep the spark plug dry and clean: Before installing, remove the stain or dirt on the ceramic body with a clean cloth or facial tissue.

For stubborn rust or stain, you can gently polish away it with sandpaper.



4. Cleaning of spark plug wrench

When installing the spark plug, make sure that the wrench sleeve is clean and dry.

Before installing, remove the stain or dirt in the spark plug wrench sleeve with a clean cloth or facial tissue! See the figure below.



5. Keep the cylinder head spark plug mounting hole dry and clean

Use a clean cloth to remove the oil/water stains and other dirt in the cylinder head spark plug mounting hole.



6. Spark plug clearance adjustment

Adjustment method: If the clearance is wide, insert the feeler gauge into the clearance, and tap the corner of the side electrode gently with a small wrench; if the clearance is narrow, widen the clearance slowly with a vise, insert the feeler gauge, and then gently tap the side electrode with the wrench!

Spark plug clearance: 0.35 ± 0.05 mm (must be adjusted with a feeler gauge);
ATTENTION: Make sure that the side and center electrode faces are parallel!

7、 Refitting of spark plug

After cleaning, pinch the spark plug thread, insert the spark plug wrench or high voltage coil, and then install it

Here to be parallel



with the spark plug wrench.

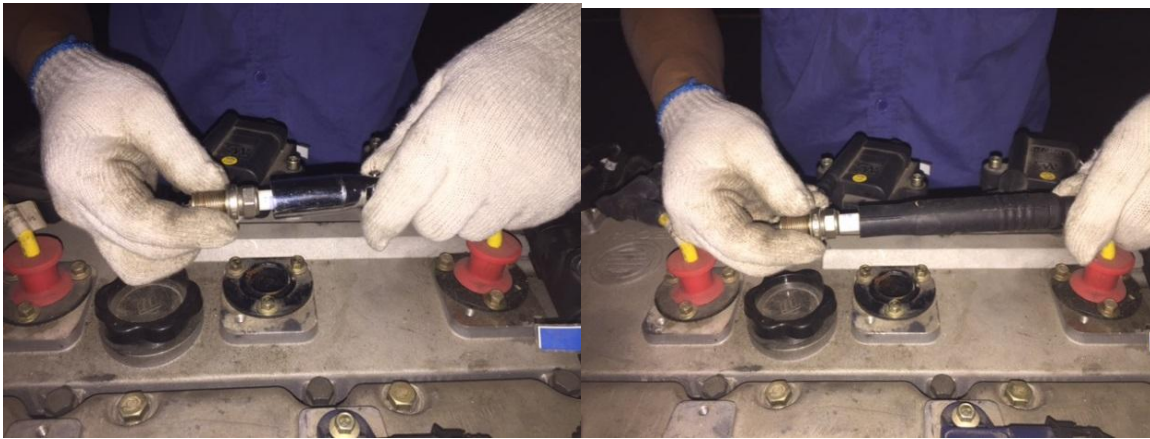

Do not throw the spark plug directly into the spark plug mounting hole.

Strictly prohibited



When installing, keep the instrument and other part of engine from touch with the outer electrode, so as not to

change the spark plug clearance!

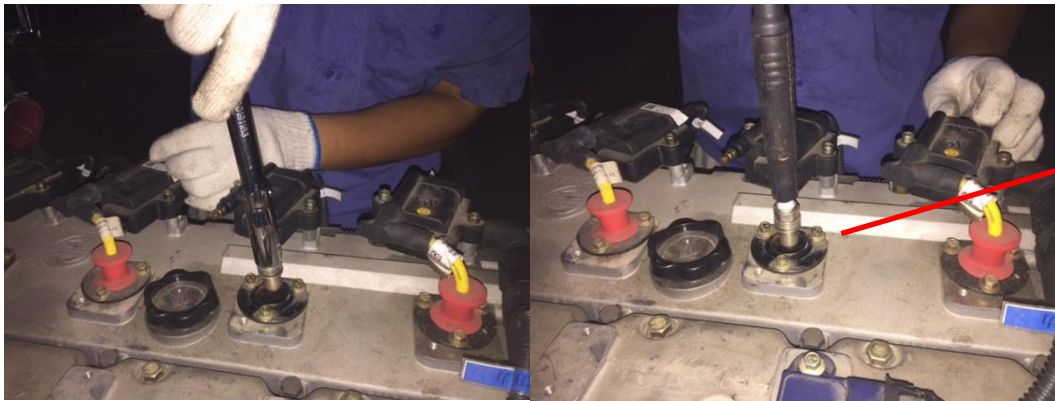

Insert the spark plug as shown here.

ATTENTION: Do not touch the spark plug ceramic body to prevent the production of flying arcs!

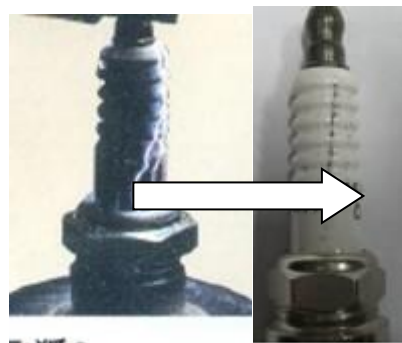

The flying arcs produced.

Tighten the spark plug: the spark plug installation torque: 25-28 Nm. When installing with a torque-free wrench, rotate the wrench for 90 degrees after the new spark plug thread is screwed to the end; for the spark plug installed for the second time, rotate the wrench for 15 degrees after the thread is screwed to the end.

- 8、 After tightening the spark plug, insert the high-voltage coil, and tighten the high-voltage coil anti-fouling cap onto the sleeve mounting hole.



Tighten the anti-fouling cap onto the sleeve

(G) Operation Specification of Vehicle LNG System

I. Daily inspection and maintenance

1. Daily maintenance requirements

Maintenance content	Maintenance intervals	Maintenance method
Cylinder and bracket connecting nut	15 days	Tightening nut
Connecting nut on the cylinder pipe	Each time before travel	Visually check for leakage
Vaporizer	6 months	Clean the scale on the coil
Valve	Often	Not closed tightly or leakage
Safety valve	12 months	Send to the local technical supervision department for verification
Pressure gauge	12 months	Send to the local technical supervision department for verification
Cylinder vacuum	12 months	Pressure test
Leakage detection	Often	Airtight test or leakage detection
Self-turbocharger	Often	Clean up the dirt on the fin
Tighten the cylinder strap	Often	Tightening nut

ATTENTION: the gas tank users should prepare a detailed maintenance plan, and follow the plan to ensure the safety of gas tank.

2. Leakage detection

The vehicle's gas system leakage points can be inspected with a portable methane detector (which should be used correctly according to the manufacturer's instructions). In order to ensure the normal operation of the vehicle, the system should be regularly checked for leakage, and in case of any leakage points, they should be repaired immediately. If it is difficult to determine the leakage points with the detector in some special conditions, you can check the leakage with soap liquid.

3. Parts replacement

Fuel leakages in any fitting or pipe must be repaired if found:

In the event of pipe thread leakage, clean the connecting surface of pipe thread and seal it with teflon tape.

In the event of pipe leakage, disassemble the pipe and check it carefully. If there is no damage on the appearance of the nut and sleeve, they can be used again. Reinstall the pipe and tighten the nut, and finally carry out the pressure leakage detection.

In the event of valve leakage, return the valve to the cylinder manufacturer for repair or replacement.

WARNING: the safety valve can only be returned to the manufacturer for repair, and cannot be repaired or adjusted without permission.

Safety valves should be inspected every year.

4. Vacuum failure

Usually, the gas tank will, along with the vacuum failure, be involved with frosting on the cylinder or the sharp rise of the pressure inside. However, for a new cylinder or a cylinder unused for a long time, it is normal that the pressure rises sharply when filling the liquid due to the high temperature inside.

Excessive pressure rise can be used as a basis to determine the vacuum failure of gas tanks. The cylinder housing is equipped with a vacuum plug that will loosen when the cylinder vacuum fails (under normal conditions, the vacuum plug is under atmospheric pressure). Usually, the vacuum plug is sleeved

with a plastic cap. Do not open the cap or vacuum plug. In the event of cylinder vacuum failure, please return the cylinder to the manufacturer for repair.

A vacuum-failed cylinder must be evacuated again using special equipment, either on the vehicle or after the cylinder is removed.

II. Acceptance and storage

1. Acceptance:

Please make sure that the purchased products are identical with the ordered ones, and carefully check if the factory information is complete, uniform, correct and valid.

Complete: whether the factory documents (including product certificate, quality certificate, user's manual) are complete.

Uniform: whether the product information reflected by the documents is consistent.

Correct: whether the product model, specifications, technical characteristics and quantity are consistent with the provisions of the contract.

Valid: whether the product certificate, quality certificate and other data are signed and sealed according to the relevant provisions.

Check if the cylinder pressure is 0.02-0.05MPa. Check if the safety accessories, instruments and valves are in their correct states. Check if the safety valve lead seal is intact.

Check if all outlets are sealed with waterproof tapes.

In the event of any inconsistency with the above requirements during the acceptance, you should promptly contact the gas tank manufacturer and fill in the "Low Temperature Gas Tank Warranty Card."

2. Parking for a long time more than 10 h):

All parts should be away from the corrosive environment, and cannot be stored in an open place.

The original sealing pressure of 0.02-0.05MPa of the dry nitrogen should be maintained, and it is forbidden to open any valve to release the pressure inside. Do not open the gas tank evacuation connector (also served as the explosion-proof port of the external container). Otherwise the vacuum of the gas tank will be lost, and the cylinder will lose the function of insulation.

A safety valve lead seal may not be destroyed unless the storage time of the cylinder exceeds the specified inspection period of the safety valve (within 12 months after the last inspection). In this case, the safety valve lead seal should be sent to the technical supervision department for inspection and should be destroyed there.

All dust-proof devices of the components (such as the filler cap, vent cap, etc.) may not be opened without permission. Otherwise the components may be blocked due to the ingress of air in the use process; there may occur the valve leakage or engine damage due to the ingress of dust particles in the use process.

The liquid-contained cylinders with the storage period of more than 5 days should be drained before storage, the pressure should be lowered to 0 MPa and all valves should be closed. They should be placed in an open area or a ventilated area where electrical appliances should be the explosion proof type.

LNG tanks are strictly prohibited from being stored in a confined space. If they must be stored in a confined space, a combustible gas alarm device should be provided. The alarm lower limit is that an alarm should be sent when the content of natural gas in the space reaches 1% by volume; the alarm signal should be able to emit sound and light so that the driver can see the alarm display.

WARNING: Failure to follow the above requirements may cause ice blocking, loss of vacuum, etc.

CAUTION: Do not open the evacuation connector of the gas tank (also served as the explosion-proof port of the external container). Otherwise the vacuum of the gas tank will be lost, and the cylinder will lose the function of insulation.

III. Precautions for liquid filling

1. Environmental requirements

When filling, there must be no fire source or flammable or combustible material within 50 m around the vehicle. The site should be open and well ventilated.

The site should be provided with two or more 5kg dry powder fire extinguishers.

There should be plenty of water around. The water source is used to cool down the tank instead of fire extinguishing.

Before entering a natural gas area, make sure to measure the concentrations of oxygen and natural gas in the area.

2. Vehicle state

When filling, the vehicle should be stopped, and all valves of the cylinder should be closed. The gas tank should be kept clean, the filler should be cleaned with a dry cloth, and there should be no water left inside the filler.

Before filling, make sure to observe whether the appearance of the gas tank is involved with condensation or frosting. If yes, do not fill the cylinder and send it back to the manufacturer for repair.

3. Preventive measures

When filling or using LNG liquid, make sure to prevent splashing or spilling. Antifreezing measures should be taken during the operation. In the process of filling or use, there may be difficulty in opening and closing the valve due to frosting. In this case, the user can no screw it in or out forcedly. Otherwise the valve may be damaged, causing personal injury. You can open or close the valve after heating it with warm water.

Always wear goggles, face mask, heat-insulating gloves and protective clothing in the work process. When operating, the operator should wear cotton-made protective clothing and long pants, and may not wear skirts or shorts. There should be no steel nail on the shoe sole; the legs of long pants can not be rolled up, and the upper opening of the shoe must be covered by long pants. Gloves should be made of cotton or leather and should be long and loose, easy to take off; gloves should be intact and dry.

Since the clothes are likely to be saturated with natural gas, it is strictly forbidden to smoke or stay nearby a place where there is fire immediately after natural gas work.

In the areas with LNG, do not use any unpermitted electric and communications equipment such as cell phones and radio transmitters.

4. Operating requirements

(1) Conventional filling

Conventional filling refers to the normal use of gas tanks. When filling, there should be low temperature and some liquid inside the cylinders.

- ① Confirm that the gas stations or the vehicles equipped with gas tanks are properly grounded;
- ② Open the protective cap of the low-temperature liquid inlet and return gas connector;
- ③ Visually check the valves, fittings and pipes of the gas tank, and confirm that there is no leakage and the parts are not missing;
- ④ Purge the low-temperature liquid inlet and return gas connector with dry nitrogen (or wipe them with a clean and dry cotton) so as to ensure there is no moisture or impurities inside;
- ⑤ If necessary, connect the return gas nozzle and return gas fitting, and rotate the return gas nozzle for 90 degrees;
- ⑥ Confirm that the gas nozzle matches the low temperature liquid inlet and connect the gas nozzle to the low temperature liquid inlet.
- ⑦ Start the pump for filling. Observe the cylinder pressure gauge. When the pressure in the vehicle LNG cylinder rises to a certain pressure (0.3-0.5Kg below that in the tank), the cylinder should be vented before filling. Open the cylinder vent valve to reduce the pressure below that required for

the gas dispenser, and maintain the pressure (it should be noted when venting: the venting gas should be returned to the big tank of the gas station or be discharged to a safe place);

- ⑧ Stop filling until the cylinder is filled fully (liquid is drained fully)
- ⑨ Close the vent valve, LNG tank or gas dispenser switch and filling nozzle in turns;
- ⑩ Cover the protective caps at the low temperature liquid inlet and return gas fitting.

(2) Filling for hot gas tanks

Usually the gas tanks that are filled for the first time, have been suspended for more than two weeks and have been maintained are called "hot gas tanks". When filling the hot cylinders, the temperature inside the cylinders must be cooled down to LNG temperature. The following procedure should be observed:

- ① Confirm that the gas stations or the vehicles equipped with gas tanks are properly grounded;
- ② Open the protective cap of the low-temperature liquid inlet and return gas connector;
- ③ Visually check the valves, fittings and pipes of the gas tank, and confirm that there is no leakage and the parts are not missing;
- ④ Purge the low-temperature liquid inlet and return gas connector with dry nitrogen (or wipe them with a clean and dry cotton) so as to ensure there is no moisture or impurities inside;
- ⑤ If necessary, connect the return gas gun and return gas fitting, and rotate the return gas nozzle for 90 degrees;
- ⑥ Confirm that the gas nozzle matches the low temperature liquid inlet and connect the gas gun to the low temperature liquid inlet.
- ⑦ Start the pump at the gas station, fill gas into the cylinder, and stop filling when about 30L is displayed on the gas dispenser;
- ⑧ Open the cylinder vent valve to lower the pressure down to 0.3MPa, and then close the vent valve;

WARNING: it should be noted when venting: the venting gas should be returned to the big tank of the gas station or be discharged to a safe place.

- ⑨ Have the cylinder cooled for about 10 min, during which the pressure of the cylinder will rise;
- ⑩ Observe the cylinder pressure gauge, and if the cylinder pressure is high, fill the gas after venting according to step 8;
- ⑪ Start the pump at the gas station again for filling, until the gas dispenser stops automatically;
- ⑫ Confirm that the vent valve is closed, and remove the gas nozzle and return gas nozzle;
- ⑬ Cover the protective caps at the low temperature liquid inlet and return gas fitting.

WARNING:

- 1) Confirm that the cylinder is well grounded before filling.
- 2) Check that the connector has no leakage before filling.
- 3) Check if there is water or impurities in the low-temperature liquid inlet before filling. Make sure that the water or impurities are completely removed before filling.
- 4) If there is moisture, it will quickly condense into ice when filling. Ice cubes may block the liquid inlet check valve and low temperature liquid inlet, and even enter the cylinder. The blocking may cause leakage due to the untightness of the low temperature liquid inlet and liquid inlet check valve, and even cause the sealing surface damage. If the ice cubes enter the cylinder, they may be blocked at the liquid outlet check valve in the process of liquid drainage, causing unsmooth liquid supply and the engine power insufficiency and even failure to start.
- 5) If there is impurity, it may cause the untightness of the liquid inlet check valve and the low temperature liquid inlet, and even the sealing surface damage. At the same time, if there is no filter in the front of the

engine, impurities may cause damage on the engine.

6) When venting to the atmosphere, the vented gas should be led to a safe place. Otherwise there may be the risk of fire or explosion.

ATTENTION:

- 1) Check if there is any condensation or frosting on the appearance of the cylinder before filling. If yes, it is recommended not to fill the cylinder, which should be sent back to the manufacturer for repair.
- 2) Check if there is pressure in the cylinder. If the pressure is 0, the cylinder should be purged, and air tightness test should be conducted. Filling of the cylinder should be conducted after passing the test.
- 3) When the liquid filling pipe is installed on the side of the vehicle, the liquid filling pipe should be bent into the "S" shape so as to prevent external impact from the side and the like.
- 4) For a fully filled cylinder, the pressure inside will rise rapidly, which may cause the safety valve to open; therefore, a fully filled cylinder should be used as soon as possible, and the storage for a long time is prohibited.

IV. Driving requirements

When the vehicle is to put into operation, turn the liquid shut-off valve slowly to 1/4 circle (too fast opening may cause the blocking of the flow valve, failing to drain the liquid), and view the pressure gauge on the gas circuit (buffer tank) after hearing the sound of liquid flow. After the pressure on the gas circuit is equal to the cylinder pressure, fully open the liquid outlet valve, and then turn back for 1 turn so that the valve can be rotated left and right freely.

When the ambient temperature is below 0°C, the engine must, after starting, be warmed up at the speed of no more than 1000rpm, and the vehicle can be driven only after the water temperature reaches 60°C. Otherwise, the vaporization capacity of the vehicle vaporizer may be insufficient and LNG vaporization is incomplete due to low water temperature, which may cause the engine stalling and even the gas filter leakage due to freezing, resulting in the gas leakage and being prone to safety risks.

CAUTION:

- 1) When the evaporator comes with frosting on its surface, it should be stopped immediately. This is probably because the water temperature is low and the vaporization capacity is not sufficient. Start the engine again after waiting for a period of time, warm up the vehicle at idle speed, and drive it after the water temperature reaches above 60°C.
- 2) Select the coolant type reasonably according to the local climate characteristics, and ensure the smooth heat exchange of the vehicle vaporizer.

1. When the level gauge displays an alarm, filling should be done in good time, otherwise it may cause the vehicle breakdown.

ATTENTION: The accuracy of the liquid level indicator is consistent with that of the vehicle fuel gauge. It is not a universal liquid level measuring device, nor is it a liquid level gauge for metering.

2. In the process of use, the residual LNG of 1-5L should be left in the cylinder, which functions to maintain a certain positive pressure in the cylinder so as to prevent the air entry when the vent valve is opened.

3. Applicable speed range (in km/h):

	Expressway	Class-1 highway	Class-2 highway	Class-3 highway	Mine, factory, country road
Freight vehicles	≤90	≤80	≤60	≤40	≤30

4. The self-turbocharger shut-off valve should be opened to turbocharge the cylinder in the following situations:

- (1) When the cylinder is first used and the pressure is below the engine requirement;

- (2) The cylinder has been calibrated with safety valve and pressure gauge;
- (3) The cylinder is repaired after venting.

V. Common faults and troubleshooting

Symptom	Cause analysis	Solution
Vaporizer surface frosting	Vaporizer inlet/outlet pipe crushed or leaked	Looping, plug leakage
	Gas pipe leakage	Plug leakage
	The engine has a cylinder that does not work	Maintenance at OEM
	Vaporizer option does not match	ReconFigd
	Water temperature is low	Stop the engine for preheating, heat the surface of the vaporizer with warm water, start the engine again and run it at the idle speed, and preheat water temperature above 60°C
The pressure inside the cylinder is low	The fuel-saving valve is improperly adjusted	Set the fuel-saving valve to the appropriate pressure
	Leakage of gas pipe and pipe fittings	Repair pipe and pipe fittings And carry out leakage detection again
	Liquid temperature is low or quality is poor	Check the liquid quality and temperature
The pressure gauge has no response before and after filling	The pressure gauge is faulty	Replace the pressure gauge
The pressure gauge has no response after the safety valve is opened	The pressure gauge is faulty	Replace the pressure gauge
frosting on cylinder head	There may be gas in use	Normal phenomenon
	There may be pipe leakage	Check and repair according to the operating procedure
Sweating or frosting on the cylinder block	The ambient temperature is low, and the air humidity is high	Normal phenomenon
	Vacuum failure	Send the gas tank back to the manufacturer for repair
Safety valve is opened	Liquid has been stored for a long time	Put the gas into use or vent it immediately
	Fast boosting	Check if the cylinder works normally
	Safety valve set pressure is low or faulty	Replace the safety valve according to the operating procedure
Safety valve is vented slowly for a long time	Safety valve is frozen in the course of pressure relief and fails to return to its position	Replace the safety valve according to the operating procedure Temporary measures: gently tap the safety valve with the screwdriver handle. The safety valve will return to its position after the venting speed decreases

The level display is 0	The cylinder liquid has run out	Fill the cylinder at the specified amount
	Converter is not set properly	Reset the converter capacitance
	Monitor or converter is damaged	Check each part for repair or replacement
The liquid level display is full after the liquid in the cylinder runs out	Converter is not set properly	Reset the converter capacitance.
	Monitor or converter is damaged	Check each part for repair or replacement
	Wire breakage or water seepage at the connection port	Check the wire, dry off the moisture and reset the connection
Gas supply temperature is high or low	Hot water supply problem	Adjust the hot water supply amount
Empty the cylinder when filling	The gas gun hose is not a vacuum tube	Gas station problem
Gas supply pressure is high or low	Fuel-saving valve, pipe pressure regulation valve	Check if the set pressure is accurate and works normally
No gas supply	The gas or liquid in the cylinder has run out	Fill the bottle with liquid
	The liquid supply valve is not opened	Open the liquid supply valve
	Solenoid valve is not opened or faulty	Check if the power supply is normal and the solenoid valve is intact
	When starting the vehicle, the valve is opened quickly, and the over-flow valve steel ball is frozen	Close the valve, gently tap the over-current valve with the screwdriver handle, and observe the vehicle vaporizer pressure gauge until the pressure rises
	The cylinder is inclined, and the over-flow valve steel ball blocks the gas circuit	Loosen the clamp, align the cylinder and then tighten the clamp
	Electrical appliances and wire harness connectors are loose with poor contact	Tighten the loose parts

VI. Description of gas supply system and the attached cylinder documents

1. Installation, maintenance, operation and repair instructions
2. Packing list
3. Product certificate
4. Product manufacture license:

(1) "LNG vehicle cylinders" special equipment manufacture license issued by the State Administration of Quality Supervision, Inspection and Quarantine must be provided.

(2) "Pressure pipes" manufacture license issued by the State Administration of Quality Supervision, Inspection and Quarantine regarding all low temperature valves on LNG vehicle cylinders and gas supply system equipment must be provided.

VII. Basic treatment against personal injury

1. Treatment of cold burn

In the event of skin contact with the low temperature surface, keep skin from freezing through heating

with hot water, move away the frostbite part and transfer the wounded personnel to a warm place (about 20°C).

Remove all clothing that hinders the blood circulation in the frostbite area.

The frostbite part should immediately be submerged in a water bath with the temperature of 40-45°C, and cannot be dried or heated directly; if the water temperature exceeds 45°C, the body tissue in the frostbite area will be further damaged.

Immediately sent the wounded personnel to the hospital for further treatment.

If the person suffers a large area of frostbite and his body temperature has dropped, he should be immersed in water with the temperature of 40-45°C, and then should be sent to the hospital as soon as possible.

The frostbite body parts will be involved with pain or swell after heating. If the injury is not severe, the frostbite area should be heated slowly and continuously until the skin turns from gray to pink or red.

The wounded person is not allowed to smoke or drink, which can reduce the amount of blood that flows to the frostbite area. The wounded person should receive tetanus jabs so as to prevent infection.

2. Treatment of leakage

The ventilation in the space suspected with a leakage should have the ventilation rate not less than 1/12 of the volume of the confined space per minute (equivalent to minimum 5 air changes per hour).

The confined space should be provided with a combustible gas alarm device. The alarm lower limit is that an alarm should be sent when the content of natural gas in the space reaches 1% by volume; the alarm signal should be able to emit sound and light so that the driver can see the alarm display.

LNG fire Fighting method and the grade

Fire Fighting method	Grade	Operation method	Description
Chemical dry powder fire extinguishing agent (potassium carbonate)	1	It is applied to the root cause of fire and cannot be sprayed directly onto the flame	Extinguish the fire with the help of chemical action. Skillful operation is required so as to avoid obstructions
Chemical dry powder fire extinguishing agent (sodium carbonate)	2	It is applied to the root cause of fire and cannot be sprayed directly onto the flame	Extinguish the fire with the help of chemical action. Skillful operation is required so as to avoid obstructions
Boiling foam of high expansion rate (Hi-Ex)	3	It is directly sprayed onto the flame and unburned LNG so as to reduce the possibility of burning LNG due to overflow	LNG is cut off from the flame, so as to reduce the size of the flame and reduce the amount of evaporation as well
Carbon dioxide (CO ₂)	3	It should be used above the flame and cannot be sprayed directly onto the flame	It can control but extinguish the fire and can directly be sprayed onto LNG, which will increase the height of vapor and flame, suitable for flame without gas
Water	3	It is only used to protect the surrounding properties. It cannot be sprayed on LNG, and can be sprayed into the vapor of natural gas in the form of water mist so as to reduce the vapor cloud	It can control the flame without gas and cool down the nearby equipment

Description: level 1 best, level 3 worst.

Tip: It can be conFigd by the user according to the fire extinguisher capacity. A 30L dry powder fire extinguisher can extinguish the flame in the range of 2m² and a 350L dry powder fire extinguisher can extinguish the flame in the range of 14m². **WARNING:** Do not spray water onto LNG liquid, which may cause the massive evaporation of LNG and increase the fire.

3. Treatment of asphyxia

Excessive accumulation of natural gas may dilute the concentration of oxygen in the air and can cause coma, injury and even asphyx of the people there. The physiological characteristics of asphyxia (also known as hypoxia effect) is given below

Stage	Oxygen (volume concentration)	Symptom
1	21 ~>14%	The increase of breathing and pulse frequency may cause the mild disorder of muscle movement coordination
2	14 ~>10%	Sensory, emotional irritability, very tired, difficulty in breathing, misjudgment, loss of consciousness to pain
3	10 ~>6%	Nausea, vomiting, lack of freedom of movement, prostration, loss of consciousness or perceived but inability to act and shout, permanent brain damage
4	<6%	Spasms, weak breath or breath stopping, died within few minutes

When the operator loses his consciousness due to lack of oxygen, he should be immediately evacuated from the scene and receive artificial respiration. If the operator stops his breathing, he should receive artificial respiration and be sent to the hospital for treatment immediately.

When the oxygen concentration in the air is <19%, purge the area with a high concentration of natural gas to maintain the concentration of oxygen >19%, but be careful to control the natural gas concentration <1%.

WARNING: Workers may not enter the LNG area when the concentration of oxygen in the air is <10% or the concentration of natural gas is > 50%.

(H) Explanation of Abbreviation Terms in English

CNG	compressed natural gas
ECT	engine coolant temperature
ECM	engine control module
FPP	footpedal position
FMV	fuel manipulation valve
ICM	ignition control module
IVS	idle verification system
LPG	liquefied petroleum gas
LNG	liquefied natural gas
MAT	manifold air temperature
MAP	manifold air pressure
MAT	manifold air temperature
MIL	malfunction indicator light
NG	natural gas
NGT	natural gas temperature
NGP	natural gas pressure
OEM	original equipment manufacturer
OH6.0	WOODWARD road-purpose gas engine control system
PD	linear derivative
Phi	standard air-fuel ratio
PID	linear derivative integral
PRD	pressure reduction device
PTO	idle speed increase
PTP	pre-throttle pressure
PWM	pulse width modulation
RPM	engine speed
SH	humidity
SAE	American Society of Automotive Engineers
SFC	system fault code
TDC	top dead center
TPS	throttle position sensor
UEGO	universal exhaust gas oxygen
VBAT	battery voltage
WGCV	Wastegate control valve
Z	compression ratio

(I) List of Fault Codes

List of WOODWARD OH6.0 faults:

SFC	Fault description
135	UEGO2 Htr Open or Short Grnd
136	UEGO2 Heater Temperature LTE
137	UEGO2 Heater Temperature HTE
139	UEGO2 Heater Temperature Control
141	NGT Voltage High
142	NGT Voltage Low
143	NGTdt - Least Severe Torque Derate
144	NGTdt - Moderately Severe Torq Derate
145	NGTdt - Most Severe Torque Derate
146	NGT Differs from Other Sensors
147	NGT Higher Than Expected
148	NGT Lower Than Expected
151	2.5 Reference Voltage HTE
152	2.5 Reference Voltage LTE
161	XDRP_A (+5V) Voltage THE
162	XDRP_A (+5V) Voltage LTE
163	XDRP_B (+5V) Voltage THE
164	XDRP_B (+5V) Voltage LTE
165	Battery Voltage Higher than Expected
166	Battery Voltage Lower than Expected
168	Keyswitch Voltage Lower than expected
191	Oil Pressure Voltage Low
192	Oil Pressure Voltage High
193	Oil Temperature Voltage Low
194	Oil Temperature Voltage High
195	Oil Pressure Low
196	Oil Pressure Fault
222	Oil Temperature High
223	Oil Temperature Severe
197	Oil Temperature IR High

198	Oil Temperature IR Low
199	Oil Temperature Differs from Other Sensors
211	APP1 Voltage High
212	APP1 Voltage Low
213	APP1 Adapt High Max
214	APP1 Adapt Low Min
219	APP IVS Conflict
231	MAT Voltage High
232	MAT Voltage Low
233	MAT Higher than Expected
234	MAT Data Insufficient Activity
236	Charge Air Cooling Failure
235	MAT Differs from Other Sensors
241	Tacho Short Open Fault
242	Over Heat Lamp Short Open fault
243	Engine Brake Short Open Fault
244	Fan 1 Short Open Fault
245	Fan 2 Short Open fault
249	Starter Control Short Open Fault
251	Lock Off Short Open Fault
252	MIL Short Open Fault
253	RSG/Cruise/PTO Lamp Short Open Fault
254	Check Engine Lamp Short Open Fault
255	Engine Stopping Lamp Short Open Fault
261	ECT Voltage High
262	ECT Voltage Low
263	ECT Higher than Expected
264	ECT Insufficient activity
265	ECT Differs from Other Sensors
266	ECT Warmup Slower than Expected
267	ThermoStat Stuck Open
271	APP Brake Mismatch
272	TSC1 and Brake Mismatch

341	MAP Voltage Low
342	MAP Voltage High
343	MAP Data Drift High
344	MAP Data Drift Low
345	MAP Sticking
346	MAP Fault
371	PTP Voltage High
372	PTP Voltage Low
373	PTP Data Drift High
374	PTP Data Drift Low
375	PTP/MAP Keyon Check
381	NGP Voltage High
382	NGP Voltage Low
383	NGP Higher than Expected
384	NGP Lower than Expected
385	System Overpressure Fault
386	NGP Leak
387	NGP Low
411	UEGO2 UN Fault
412	UEGO2 VM Fault
413	UEGO2 IA Fault
414	UEGO2 Air Cal Sensor Failed Fault
415	UEGO2 Air Cal at Lower Limit
416	UEGO2 Air Cal at Upper Limit
417	UEGO2 UA Voltage High
418	UEGO2 UA Voltage Low
441	UEGO2 UR Voltage High
442	UEGO2 UR Voltage Low
443	UEGO2 IP Fault
421	CAM Sensor Loss Fault
422	CRANK Sensor Loss Fault
423	CRANK Sensor Sync Fault
424	CAM Sensor Phase Fault

425	CRANK Sensor Other Fault
426	CAM Sensor Other Fault
427	Engine Soft OverSpeed
429	Engine Hard Overspeed
432	Vehicle Speed UnExpected Noise
471	Adaptive Learn Correction on Hi Limit
472	Adaptive Learn Correction on Low Limit
451	Clutch Switch Stuck on Fault
452	Neutral Switch Stuck on Fault
453	Brake No Switch
454	Clutch No Switch
455	Clutch Neutral Switch disconnected
456	Starter Switch Stuck On
457	Cruise Switch Stuck On
458	PTO Switch Stuck On
541	TPS1 Voltage High
542	TPS1 Voltage Low
543	TPS1 Higher than Expected
544	TPS1 Lower than Expected
545	TPS2 Voltage High
546	TPS2 Voltage low
547	TPS2 Higher than Expected
548	TPS2 Lower than Expected
549	TPSSensor Conflict
551	TPS Intermittent
552	Throttle Valve H bridge Fault
553	Throttle Valve Open Fault
554	Throttle Spring Test Fault
555	Throttle Valve Stuck
561	Transmission #1 Msg Timeout
562	Transmission #1 Data Invalid
563	Tachograph Msg Timeout
564	Tachograph Data Invalid

565	Brakes - System Controller Msg Timeout
566	Brakes -System Controller Data Invalid
567	ETC2RxTimeoutFault
568	TSC1_1RxTimeoutFault
569	TSC1_2RxTimeoutFault
577	Woodward PTO
578	Woodward Diagnostics Mode 2
579	Woodward Diagnostics Mode 1
582	CAN1 Line Circuit/Bus Error Passive
585	Brakes - System Controller message Timeout
587	High Resolution Wheel Speed Message
589	Gas Flap Switch Message
611	RH Sensor Voltage High
612	RH Sensor Voltage Low
613	RHT Sensor Voltage High
614	RHT Sensor Voltage Low
615	RHT Insufficient Activity
616	Specific Humidity Higher than Expected
617	RH Insufficient Activity
618	RHT Differs from Other Sensors
621	CPU Load Higher than Expected
622	Flash Memory Fault
623	SRAM Memory Fault
624	Invalid Calibration Fault
659	NGTT is too low
661	NGTP Voltage High
662	NGTP Voltage Low
663	NGTP Lower than Expected
666	NGTT Voltage High
667	NGTT Voltage Low
665	NGTP sensor inactive
691	Wastegate Cntrl Valve Open or Short
692	Boost pressure Higher than Expected

693	Boost pressure Lower than Expected
694	Overboost
771	High Engine Knock Level Cylinder 1
772	High Engine Knock Level Cylinder 2
773	High Engine Knock Level Cylinder 3
774	High Engine Knock Level Cylinder 4
775	High Engine Knock Level Cylinder 5
776	High Engine Knock Level Cylinder 6
781	Knock Sensor Open Circuit
782	Knock Sensor short Circuit
783	Knock Sensor 2 Open Circuit
784	Knock Sensor 2 short Circuit
841	Spark 1 Max Current
842	Spark 1 Open Primary
843	Spark 1 Open Secondary
844	Spark 2 Max Current
845	Spark 2 Open Primary
846	Spark 2 Open Secondary
847	Spark 3 Max Current
848	Spark 3 Open Primary
849	Spark 3 Open Secondary
851	Spark 4 Max Current
852	Spark 4 Open Primary
853	Spark 4 Open Secondary
854	Spark 5 Max Current
855	Spark 5 Open Primary
856	Spark 5 Open Secondary
857	Spark 6 Max Current
858	Spark 6 Open Primary
859	Spark 6 Open Secondary
861	Spark 1 Dwell Adapt at Max Limit
862	Spark 1 Dwell Adapt at Min Limit
863	Spark 2 Dwell Adapt at Max Limit

864	Spark 2 Dwell Adapt at Min Limit
865	Spark 3 Dwell Adapt at Max Limit
866	Spark 3 Dwell Adapt at Min Limit
867	Spark 4 Dwell Adapt at Max Limit
868	Spark 4 Dwell Adapt at Min Limit
869	Spark 5 Dwell Adapt at Max Limit
871	Spark 5 Dwell Adapt at Min Limit
872	Spark 6 Dwell Adapt at Max Limit
873	Spark 6 Dwell Adapt at Min Limit
941	Pre-cat UEGO/HEGO Fueling CL Controller
943	Idle Speed Governing CL Controller
961	Injector 1 Shorted to Voltage / Injector 1 Open or Shorted to Ground
962	Injector 2 Shorted to Voltage/ Injector 2 Open or Shorted to Ground
963	Injector 3 Shorted to Voltage/ Injector 3 Open or Shorted to Ground
964	Injector 4 Shorted to Voltage/ Injector 4 Open or Shorted to Ground
965	Injector 5 Shorted to Voltage/ Injector 5 Open or Shorted to Ground
966	Injector 6 Shorted to Voltage/ Injector 6 Open or Shorted to Ground
967	Injector Duty Cycle Too High

Company name: Weichai Westport Inc.

Address: No. 197, Fushou East Road, High-tech Development Zone, WeifangCity, Shandong Province

Postal code: 261001

Website: <http://www.weichai.com>

Engine sales: 0536-8232488 8233371

Accessories sales: 0536-2297290

Service hotline:

400 Free service hotline: 400-6183066

800 Free service hotline: 800-8603066

Customer Service Center: 0536-8235369 (Fax)

Customer service center complaint: 0536-2297322

Publication date: January 2018