

# NGV Fuel Gas Dryer Regeneration Skid

# NGR

**PSB MODEL: NGR-21U**  
**S/N: 420365**

## INSTRUCTION MANUAL

<u>Section</u>	<u>Page</u>
I. INSTALLATION AND INSPECTION .....	2
II. SAFETY .....	4
III. REGEN SKID CONTROLS.....	4
IV. OPERATOR DISPLAY TERMINAL.....	7
V. OPERATOR TERMINAL MESSAGES .....	23
VI. CONNECT/DISCONNECT INSTRUCTIONS.....	25
VII. FLOW DIAGRAM .....	26
VIII. COMPONENT DESCRIPTIONS .....	26
IX. REGENERATION .....	27
X. ALARMS.....	29
XI. MAINTENANCE PROGRAM .....	30
XII. TROUBLESHOOTING.....	32
XIII. SPECIFICATIONS & DATA.....	34
XIV. PLC DATA ACCESS .....	34
XV. REGENERATION SETUP & FINISH CHECKLIST .....	35
XVI. PARTS LIST & PRODUCT REGISTRATION.....	37



**PSB INDUSTRIES INC.**  
1202 West 12th Street  
Erie, PA 16501 USA  
Phone: (814) 453-3651  
Fax: (814) 454-3492  
[www.PSBINDUSTRIES.com](http://www.PSBINDUSTRIES.com)

## ! WARNING!

- READ ALL INFORMATION IN THIS MANUAL BEFORE BEGINNING INSTALLATION OR OPERATION OF THE REGENERATION SKID.
- BEFORE STARTING INSTALLATION AND/OR MAINTENANCE PROCEDURES; DISCONNECT POWER TO THE SKID AND COMPLETELY DEPRESSURIZE THE UNIT TO PREVENT PERSONAL INJURY.
- DO NOT REMOVE, REPAIR, OR REPLACE ANY ITEM ON THIS UNIT WHILE IT IS UNDER PRESSURE.
- NEVER OPERATE THIS REGENERATION SKID ABOVE THE RATED OPERATING CONDITIONS. OPERATION ABOVE SPECIFIED CONDITIONS WILL RESULT IN DECREASED PERFORMANCE, POSSIBLE DAMAGE TO THE UNIT AND/OR PERSONAL INJURY.
- SUBSTITUTION OF COMPONENTS MAY IMPAIR SUITABILITY FOR CLASS I, DIVISION 2.
- WARRANTY IS VOIDED IF MODIFICATIONS ARE MADE WITHOUT THE APPROVAL OF THE MANUFACTURER.
- EXPLOSION HAZARD. DO NOT REMOVE OR REPLACE FUSES OR OTHER COMPONENTS UNLESS POWER HAS BEEN DISCONNECTED OR THE AREA IS KNOWN TO BE FREE OF IGNITIBLE CONCENTRATIONS OF FLAMMABLE GASES OR VAPORS.
- **REGENERATION SKID POWER SWITCH MUST BE IN OFF POSITION WHEN CONNECTED TO MAIN POWER SOURCE AND NOT IN USE.**



**\*\*THIS APPARATUS IS SUITABLE FOR USE IN CLASS I, DIVISION 2, GROUP D or UNCLASSIFIED LOCATIONS\*\***

### I. INSTALLATION AND INSPECTION

#### A. Inspection

**Note:** All piping and electrical connections should be checked to insure they have maintained their integrity during shipping and installation.

All skids are tested and inspected at the factory prior to shipping. Inspect the regeneration skid carefully upon arrival and note any damage on the freight bill. Uncrate and inspect for concealed damage. File claims with the carrier immediately and notify PSB service department.

#### B. Regeneration skid location

Unit is intended to be transportable. Anchor unit to trailer securely using DOT approved methods. Trailer must be rated for weight of skid and as level as possible. Regeneration skid may be stored and operated outdoors or in a well ventilated area. For maintenance accessibility, the skid should have minimum 36" clearance on all sides. For standard applications, ambient temperatures should range between 35°F and 100°F unless equipped with cold weather package. Consult the factory concerning applications outside this temperature range.

#### C. Regeneration Hoses

Flexible connections are required to dryer to be regenerated. Regeneration skid piping is self-supporting and supports only hose connections. Hoses must be covered with insulation to provide maximum regeneration gas temperature to dryer and for personnel protection. Optional connection hose kit contains necessary hoses, insulation, and connection fittings to connect to dryer vessel. These hoses may remain connected to skid during transportation if trailer width allows.

**D. Electrical**

This unit is considered transportable equipment and rated for Class 1, Div 2 hazardous location. Electrical cord shall be sized to handle FLA, be rated for “extra-hard usage”, and connected per Electrical Schematic. A plug rated for hazardous location shall be attached to cord end. Receptacle must receive plug and be rated for above hazardous location. All Wiring shall be in accordance with local, national and other governing electrical codes. Optional connection kit will have cord and plug attached to high voltage enclosure.



**WARNING:**

**Explosion Hazard, DO NOT Connect or Disconnect when energized.**

After the appropriate electrical connections have been made, check to ensure proper rotation. DO NOT turn ON blower circuit breaker (CB2) until rotation of the cooler fan has been verified. Proper air flow through cooler is towards motor. If incorrect, then change incoming power wires. DO NOT change factory wiring. (See Item M: Electrical Phase Check on Page 21.)



**CAUTION: Unit must be phased to provide proper blower rotation.**

**E. Electrical Heater**

The unit is equipped with an electric heater. Before applying power, the heater must be checked with an insulation resistance tester. All circuits must indicate a minimum resistance reading of 50,000 ohms between each circuit phase and ground. If any circuit does not meet this requirement, connect 120VAC to circuit for several hours, and then recheck. Repeat this procedure if necessary.

**F. Drainage**

Condensate is considered hazardous. Sump tank requires draining after each regeneration. Follow proper procedures in disposal.

**G. Relief Valve**

Relief valve should be piped upward to a safe location (supplied by user).

**H. Enclosure Heater (optional)**

For applications that are installed in ambient temperatures lower than 32°F, the low voltage enclosure contains a heater to keep PLC and components above minimum operating temperatures. A temperature sensor is mounted to back panel that keeps panel between 40-60°F.

**I. ESD/Alarm contacts**

Regeneration skid has ESD pushbutton and alarm contacts that may be wired to station for indication and control. Cord rated for Class 1, Div 2 hazardous location must be used with listed plugs having same rating. Failure to provide hazardous location plugs may cause explosion potential.

## II. SAFETY

- A. Skid power switch to be in off position when not in regeneration cycle.
- B. Use **EXTREME CAUTION** when working in the vicinity of the skid as gas contained in piping is flammable.
- C. Relieve pressure before servicing skid or regeneration hoses.
- D. Make sure that the relief valve is locked open before operation.
- E. Disconnect power before servicing regeneration skid.
- F. Manual drain valves will eject water, oil, particulates and gas under partial pressure when operated. Proper precautions must be taken.
- G. Condensate may contain oil or other contaminants. Follow all applicable regulations for safe handling and disposal.
- H. Purge the system to remove oxygen (contained in air) prior to startup.
- I. Keep electrical enclosures closed and bolts tightened securely.
- J. Make sure that all cords and plugs are removed when voltage supply is OFF.

## III. REGEN SKID CONTROLS

- A. **Regen Power Selector switch (SS1)**  
This selector switch, when moved to OFF position, removes all control power from skid except for enclosure heater (optional), heat trace (optional), and moisture analyzer. All skid action stops immediately. Rotating switch to ON position restores control power but does not start skid. Wait momentarily to allow PLC to power to ready state.
- B. **Emergency Shutdown pushbutton (ESD1)**  
Push-pull operation should be wired in series with other plant ESD buttons. Plant master control relay contacts should be wired in with skid control system to remove power from skid in an ESD condition. Refer to electrical schematic for details.
- C. **Regen Alarm Light (1LT)**  
Should an alarm occur, this light will illuminate or flash depending on severity of alarm. Steady ON is an alarm that needs immediate attention. Flashing ON is an alert that maintenance is needed, or condition has occurred where operator action is needed to improve quality of skid operation. Refer to alarms (section XI) for details. Skid alarms listed include: Heater sheath over-temperature, Heater outlet temperature high, Cooler outlet temperature high, Cooler/Blower overload, Thermocouple failure, and communication failures. These are shown on operator terminal display under alarm page.
- D. **Operator Control Station**  
A display is present on control panel face that enables operator to gain valuable information about status of skid, enables operator to change setpoints, and aids troubleshooting should an alarm occur. Changing setpoints is protected by password to prevent tampering. Refer to operator terminal (section IV) for details.

**E. Function Key Controls**

At the bottom of operator control station, there are four (4) function keys that give operator control of unit. These keys are directly connected to PLC. Key functions are as follows. Refer to operator terminal (section IV) for details.

F1 key – Skid regeneration control.

F2 key – Regeneration cycle control.

F3 key – Alarm reset.

F4 key – Message control.

**F. Operator Display Messages**

The display has messages to prompt operator action or add feedback to operator on action taken. These automatically are triggered based on preset conditions. F4 key can be used to review these messages. Maintenance messages popup to prompt operator/maintenance staff action. Additionally, troubleshooting aids can be accessed to enable operator to problem solve.

**G. Regeneration Code**

In order to prevent unauthorized regeneration activities, a 4 digit code must be entered during the regeneration start process. This 4 digit code is received when registration of unit is complete. Code is required for each regeneration. To start regeneration, press F1 key. Next, enter regeneration code. Then press and hold F1 key for 2 seconds.

**H. Heater Control & Protection**

Heater control is accomplished from TE-4 that turns heater ON and OFF based on whether outlet temperature is above or below setpoint (below = heater ON). Protection of heater is monitored by TE-5 which is connected to heater element. These type “J” thermocouples provide inputs to the PLC control system for alarms and heater control. When a thermocouple burns out (opens), the PLC up scales the input and triggers a shutdown to prevent thermal runaway.

**I. Heat Termination Control**

This control minimizes heat time based on bed outlet temperature (TE-2). When desiccant moisture is low, the heat front moves through desiccant rapidly. Therefore, the bed outlet temperature rises quicker than normal. The control stops heating when bed outlet gets to approx. 250°F. This temperature setpoint is preset at factory but can be adjusted if needed (see Section IV).

**J. Cooler Ambient Control**

To minimize freeze up conditions, cooler motor shuts off when process temperature drops to 40°F. When process temperature rises to 55°F, then cooler motor resumes operation. Cooler outlet thermocouple (TE-3) provides input to control. Control monitors temperature and will temporarily reset control to 50°F OFF temperature to keep from freezing condensate in low ambient conditions.

**K. Cooler /Blower Motor Overload**

Both the blower and cooler motors are protected from overload. These devices are set to NOT require opening high voltage panel to reset. Should the blower or cooler overload trip, the regeneration sequence stops and heater contactor is de-energized. After approx. 2 minutes, the overload resets and alarm can be cleared. Then the dryer sequence can be restarted.

- L. Heater /Blower Interlock**  
The heater is electrically interlocked with blower and blower circuit breaker. Should the blower overload trip, the heater contactor is de-energized with blower contactor. If circuit breaker is turned OFF, then blower and heater will not operate.
- M. Heater Chamber (TE-6)**  
The heater is equipped with a control that monitors heater chamber temperature. This control is considered a safety that is external to the PLC and interrupts heater contactor should temperature exceed 500°F. For more detailed information see section XI
- N. Enclosure Heater**  
For applications that are installed in ambient temperatures lower than 32°F, the low voltage enclosure contains a heater to keep PLC and components above minimum operating temperatures. A temperature sensor is mounted to back panel that keeps panel between 40-60°F.
- O. Heat Trace (Sump tank)**  
For ambient temperatures below 35°F, the sump tank is electrically heat traced and covered by insulation. Heat trace cable automatically adjusts heat output to keep un-drained water from freezing. A light located on connection box mounted on tank indicates that power is applied to heat trace cable. A temperature switch monitoring ambient temperature prevents power consumption during periods of warm weather. For safety concerns, a ground-fault protection device prevents equipment damage should a fault occur
- P. Multiple Circuit Heater**  
The heater is equipped with two circuits. This enables regeneration skid to have capacity for all sizes of desiccant beds. For large desiccant beds, select "FULL" capacity. Otherwise, "HALF" capacity should be sufficient.
- Q. Electrical Phasing Check**  
To facilitate connection of electrical source to skid, a control to run cooler fan provides operator with a method to verify electrical hook-up. Turn dryer power switch to "ON" position and press button to ensure rotation matches arrow on cooler.

## IV. OPERATOR DISPLAY TERMINAL

### A. Function Keys

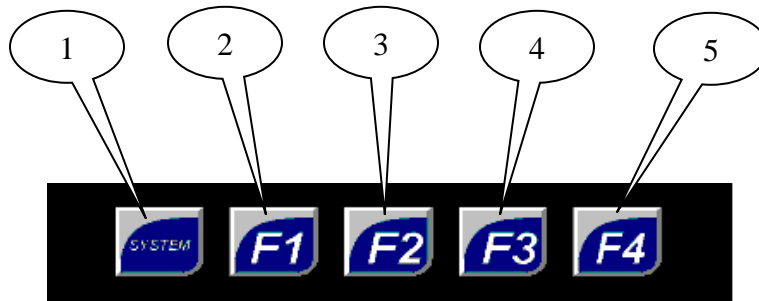

Much of the control of dryer requires use of function keys located on operator display near bottom. These provide direct input to PLC.

Item	Object	Description
1	System key	This key allows access to system parameters of PLC and display. This button overrides any other screens and is not password protected.
2	F1 key (Regen control)	Pressing this key will start and pause regeneration cycle. Pause feature is active for 10 minutes. When time expires, then regeneration code needs to be re-entered. Final key press to start unit requires 2 second press. A delay in this process will require redo of sequence.
3	F2 key (Sequence advance)	Pressing and holding this key for 5 seconds will change sequence from heating to cooling and reset sequence to beginning. Sequence change from heat to cool is done when sequence is running. Reset of sequence is done with sequence stopped and Dryer Power switch ON.
4	F3 key (Alarm reset)	Pressing this key resets any active alarms.
5	F4 key (Message review)	Pressing this key allows operator to review messages and alarm displays that have been triggered. Up to 15 screens/alarms are saved in the order they were triggered. After selecting message type, each press of key will view previous message.

## B. Main screen (startup)

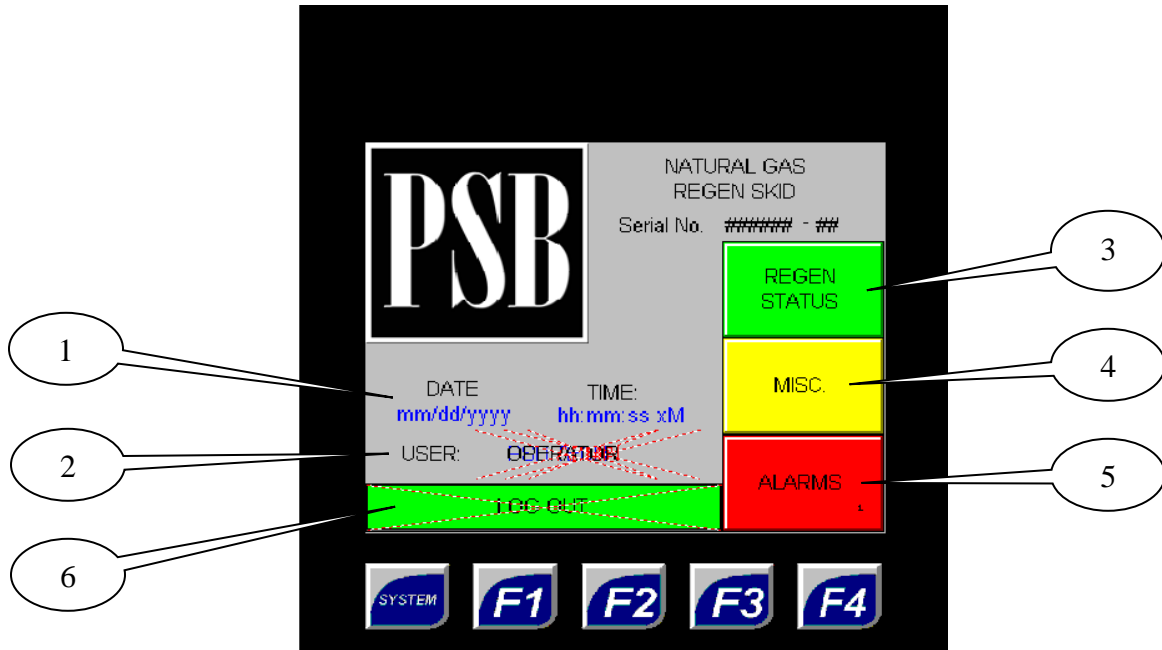

This screen is shown at startup and is considered the main screen from which all others are called from. Serial number of dryer is shown in upper right along with model number.

Item	Object	Description
1	Time/Date indicator	This shows the current PLC time and date. Is used for Alarm reporting purposes.
2	User/Password entry	Two user levels exist; Operator – has ability to view all screens except setpoints. Admin – has capabilities of Operator and can change setpoints, password, and date & time. Password: is “1234”
3	Regen Status pushbutton	When pressed, screen appears to view operation status of regeneration that includes cycle time, blower/cooler status.
4	Misc. pushbutton	When pressed, screen appears to select Setpoint, Communication, Alarm History, Event History screens.
5	Alarm pushbutton	When pressed, main alarm screen shows current status. If flashing, then an alarm is active.
6	Log Out pushbutton	This button is visible when “ADMIN” user level is active. When pressed, “OPERATOR” user level is activated.



### C. Regen Status screen

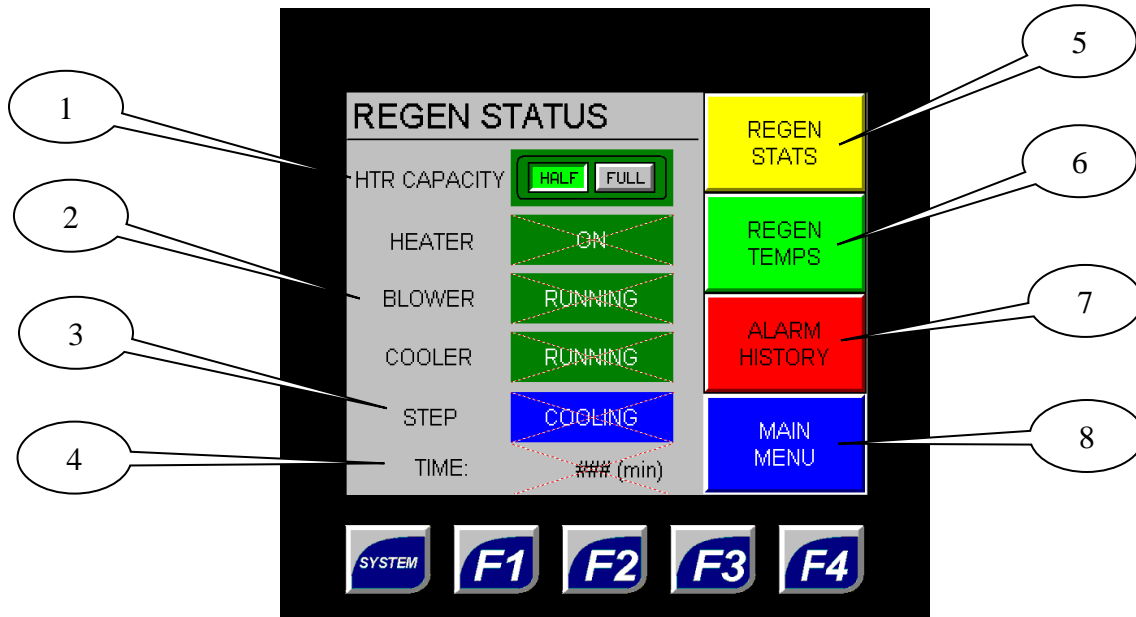

This screen provides overall general information on regeneration skid operation. During regeneration process, accumulated time and current step are shown. This screen is useful in reviewing current status for troubleshooting.

Item	Object	Description
1	Heater Capacity selector	Allows operator to select between "HALF" or "FULL" capacity. Pressing one button will de-select opposite mode.
2	Heater/Blower/Cooler Status indicator	Shows whether "RUNNING" or "STOPPED". Heater status is "ON" or "OFF".
3	Regeneration Step indicator	When unit is regenerating, "HEATING" or "COOLING" is shown. If not regenerating, then blank.
4	Cycle time indicator	During regeneration cycle, accumulated time is shown in minutes.
5	Regen Stats pushbutton	When pressed, regeneration statics screen appears.
6	Regen Temps pushbutton	When pressed, T/C Temp screen appears to show temperatures of regen skid.
7	Alarm pushbutton	When pressed, main alarm history screen shows current status. If flashing, then an alarm is active.
8	Main Menu pushbutton	Returns to main menu screen.

## D. Skid Temperature Screen

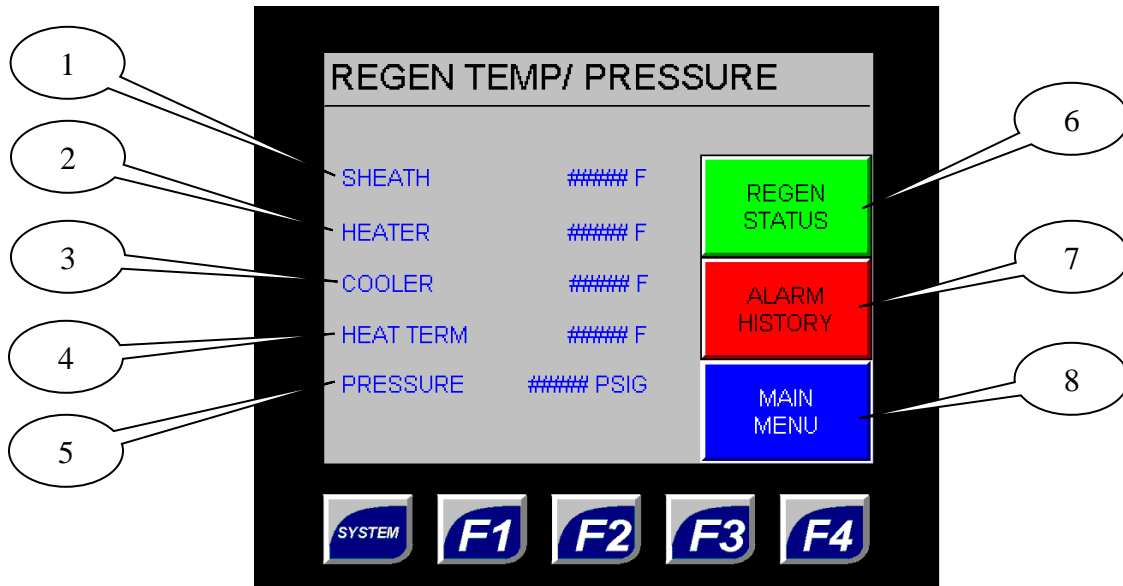

This screen shows the actual pressure and temperatures of dryer. These enable operator to determine potential problems that could occur prior to actual alarm conditions.

Item	Object	Description
1	Heater sheath temperature indicator	Heater elements are monitored by TE-5 and actual temperature is shown. If thermocouple fails, then "FAILED" is shown.
2	Heater outlet temperature indicator	To control heater output, TE-4 monitors and turns heater ON and OFF. Actual output temperature downstream of heater is shown. If thermocouple fails, then "FAILED" is shown.
3	Cooler outlet temperature indicator	Gas temperature downstream of cooler is monitored by TE-3. Actual temperature shown indicates operation of cooler. If thermocouple fails, then "FAILED" is shown.
4	Heater term. temperature indicator	Gas temperature exiting desiccant bed is monitored by TE-2. Actual temperature shown provides operator quality of regeneration – higher the temperature, the more moisture that is removed from descant bed. If thermocouple fails, then "FAILED" is shown.
5	Regen pressure indicator	Regeneration pressure at blower inlet is monitored by PT-1.
6	Regen Status pushbutton	When pressed, screen appears to view operation status of regeneration that includes cycle time, blower/cooler status
7	Alarm pushbutton	When pressed, main alarm screen shows current status. If flashing, then an alarm is active.
8	Main Menu pushbutton	Returns to main menu screen.

## E. Regeneration Statistics Screen

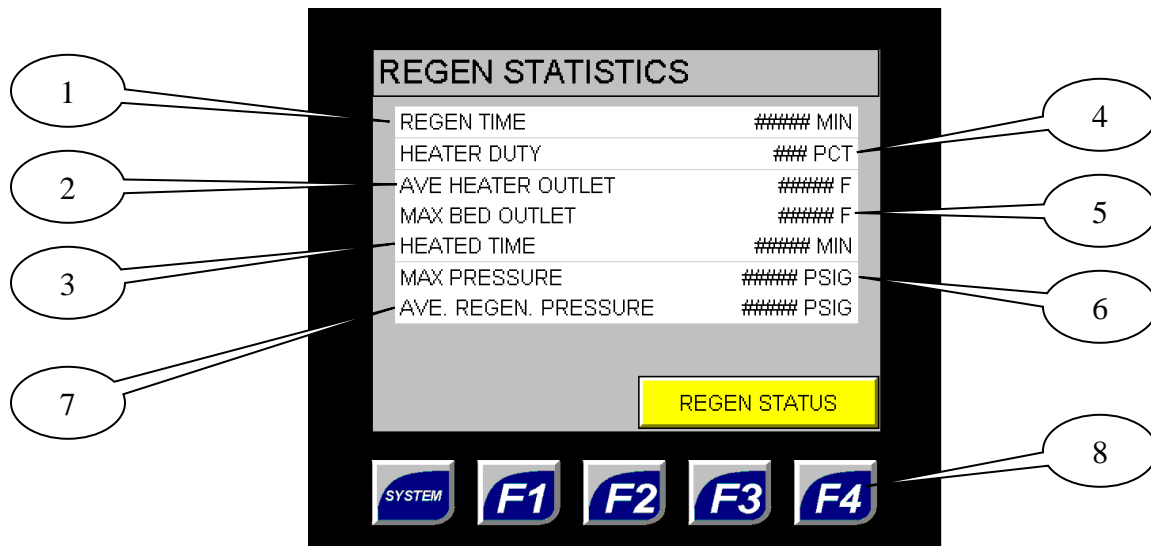

This screen shows statistics of current regeneration. These provide operator with information on quality of regeneration of dryer vessel.

Item	Object	Description
1	Regen time readout	Total regeneration time in minutes is shown. This includes time lost due to alarm or stoppage. A regeneration time longer than stated cycle time gives indication of lost time
2	Ave heater outlet readout	This provides indicator of average outlet temperature of heater. A low value may indicate a potential heater problem or flow issue during regeneration cycle.
3	Heated time	This shows heat portion of regeneration cycle that was used to heat dryer vessel. A short period of time may indicate excessive flow rate and adjustment of V3 may be needed.
4	Heater duty readout	This is an indicator of how much heat was used to regenerate dryer vessel. A 100% reading indicates that maximum heater KW was consumed during regeneration cycle.
5	Max bed outlet readout	This shows operator how much vessel desiccant was heated during cycle. A value around 250°F indicates regeneration was successful in removing moisture from desiccant.
6	Max regen pressure readout	This indicator shows maximum pressure regeneration circuit reached during regeneration process. Pressure rise affects regeneration quality.
7	Ave regen pressure readout	This indicator shows average pressure during regeneration process. This provides a better representation of pressure rise. A high value (above 50 psig) will not provide the best regeneration.
8	Regen Status pushbutton (F4)	When pressed, screen appears to view operation status of regeneration that includes cycle time, blower/cooler status

**F. Alarm indication screens**

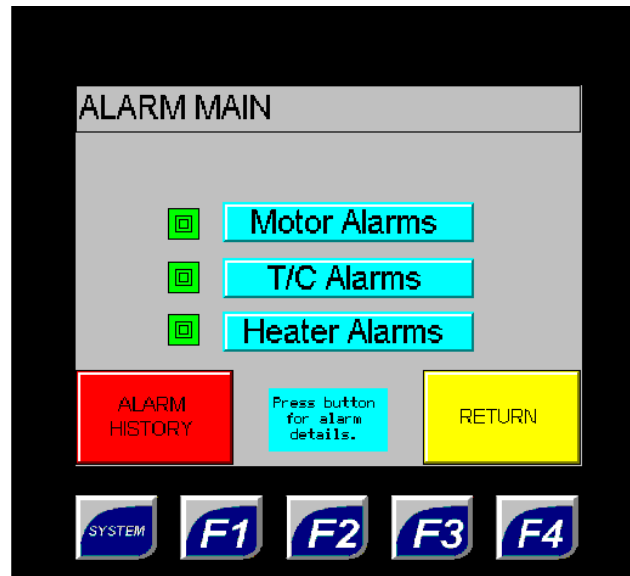

This screen is the main alarm screen that becomes visible when “ALARMS” button is pressed. The alarms are split up into 3 additional screens for ease of organization. The indicator to left of legend will flash and pressing legend button will make visible the screen. A troubleshooting screen for each alarm is accessed by pressing legend except for buttons to select additional screens. “ALARM HISTORY” button will show alarms that have occurred since power cycle.

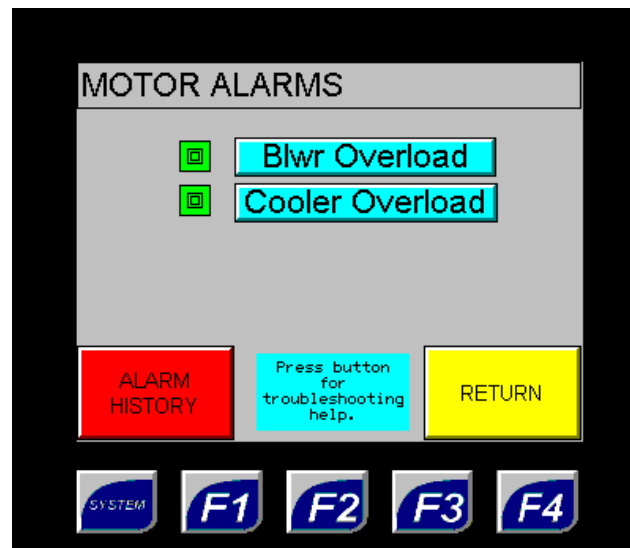

This screen shows motor overload status. A flashing red indicator shows operator which alarm has occurred. Motor overloads will reset automatically after 2 min. Pressing F3 then, will clear alarm. “RETURN” button will close screen and previous screen will become visible. A troubleshooting screen for each alarm is accessed by pressing legend. “ALARM HISTORY” button will show alarms that have occurred since power cycle.

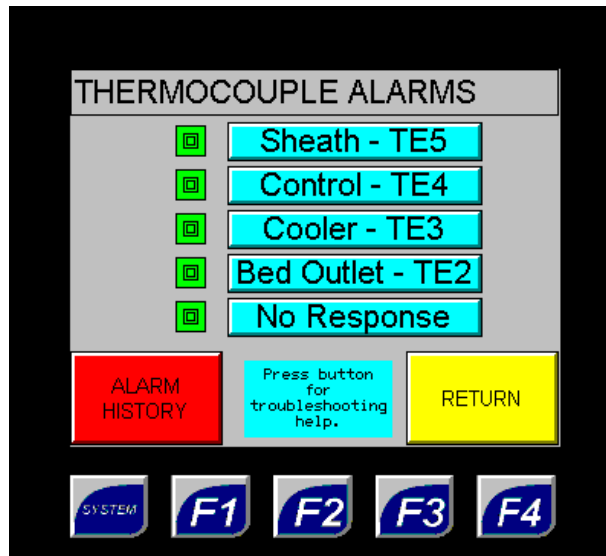

This screen shows thermocouple status and whether thermocouple is responding appropriately. A flashing red indicator shows operator which thermocouple has failed. Pressing F3 will clear alarm. "RETURN" button will close screen and previous screen will become visible. A troubleshooting screen for each alarm is accessed by pressing legend. "ALARM HISTORY" button will show alarms that have occurred since power cycle.

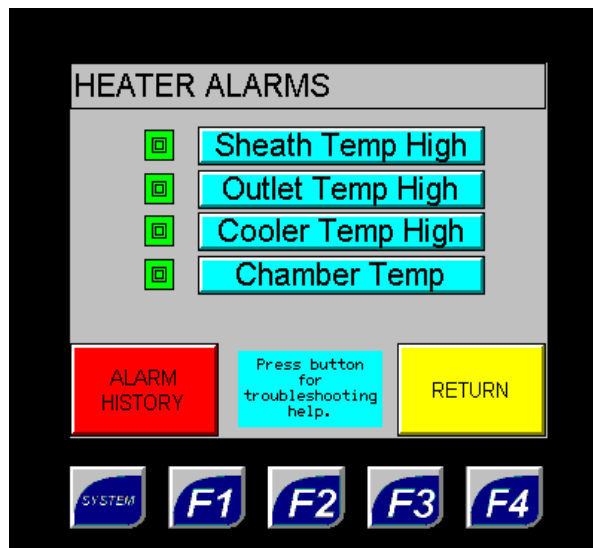

This screen shows heater/cooler temperature alarms. A flashing red indicator shows operator which alarm has occurred. Pressing F3 will clear alarm except for "Chamber Temp" alarm which requires cycling Dryer Power switch. "RETURN" button will close screen and previous screen will become visible. A troubleshooting screen for each alarm is accessed by pressing legend. "ALARM HISTORY" button will show alarms that have occurred since power cycle.

## G. Alarm History screen

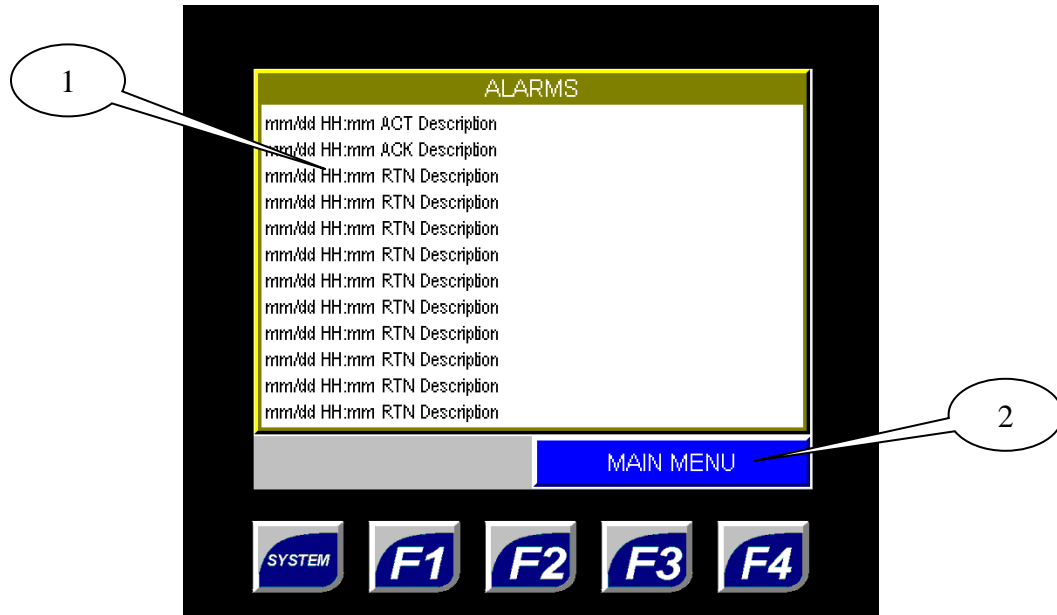

This screen shows the alarms that are past and current alarms. Touching screen brings up a screen that allows clearing and acknowledging of alarms. When power is cycled to screen, alarm history is cleared.

Item	Object	Description
1	Alarm Summary indicator	Alarms are shown with date and time and current status with description. Status of alarm can be "ALM", "ACK", "RTN". "ACK" status occurs when acknowledgement has occurred from touching screen and pressing "ACK button". "RTN" occurs when the I/O point has returned to normal and ALARM RESET pushbutton has been pressed.
2	Main Menu pushbutton	Returns to main menu screen.

## H. Miscellaneous screen

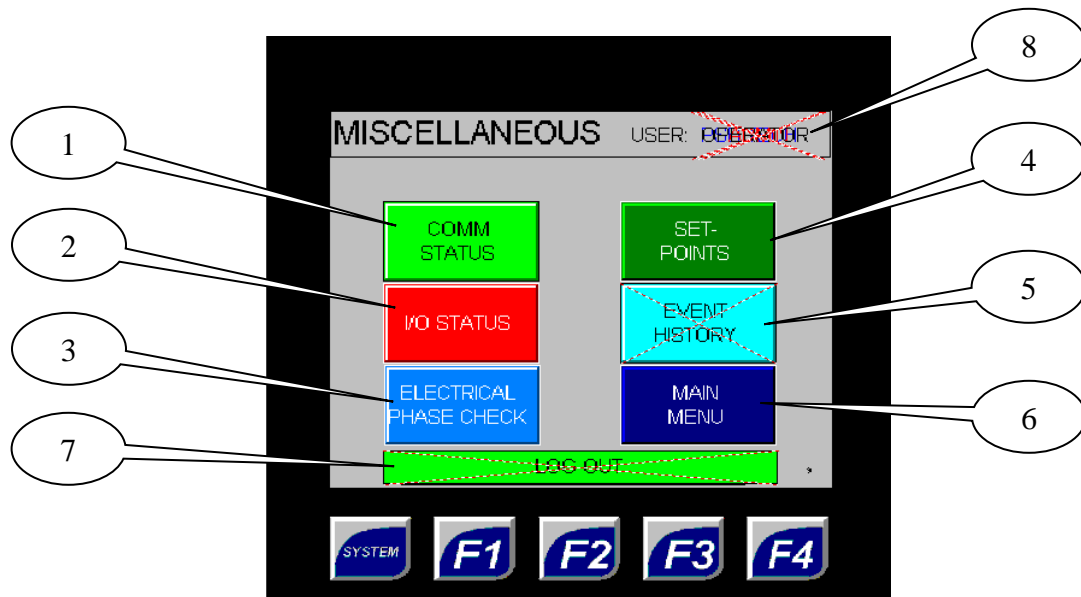

This screen enables changes to regeneration cycle and regeneration temperature. Screen is password protected and requires login as “admin” before values become visible. Login is done at Main screen.

Item	Object	Description
1	Comm status pushbutton	When pressed, the communication status screen becomes visible.
2	I/O Status pushbutton	When pressed, PLC inputs, outputs, and analog values are shown.
3	Electrical Phase Check pushbutton	When pressed, the electrical phase check screen becomes visible.
4	Setpoint pushbutton	When pressed, the setpoint screen becomes visible and if “ADMIN” user level is active changes are permitted.
5	Event History pushbutton	When pressed, the event history screen becomes visible. This is accessed when “ADMIN” user level is activated.
6	Main Menu pushbutton	Returns to main menu screen.
7	Log Out pushbutton	This button is visible when “ADMIN” user level is active. When pressed, “OPERATOR” user level is activated.
8	User/Password entry	Two user levels exist; Operator – has ability to view all screens except setpoints. Admin – has capabilities of Operator and can change setpoints, password, and date & time. Password: is “1234”

## I. Setpoints screen

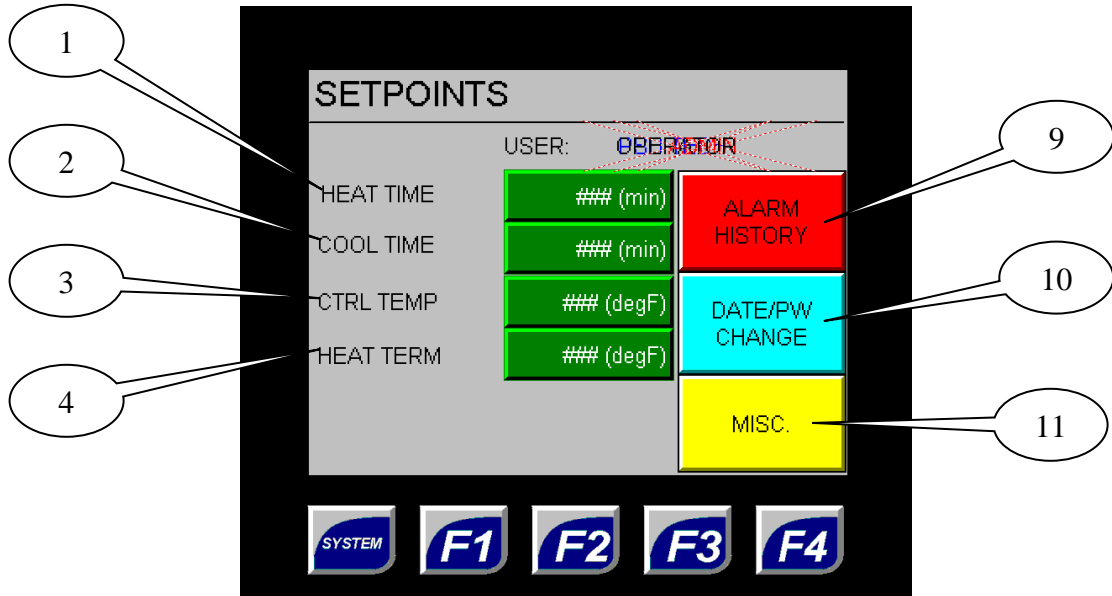

This screen enables changes to regeneration cycle and regeneration temperature. Screen is password protected and requires login as “admin” before values become visible. Login is done at Main screen.

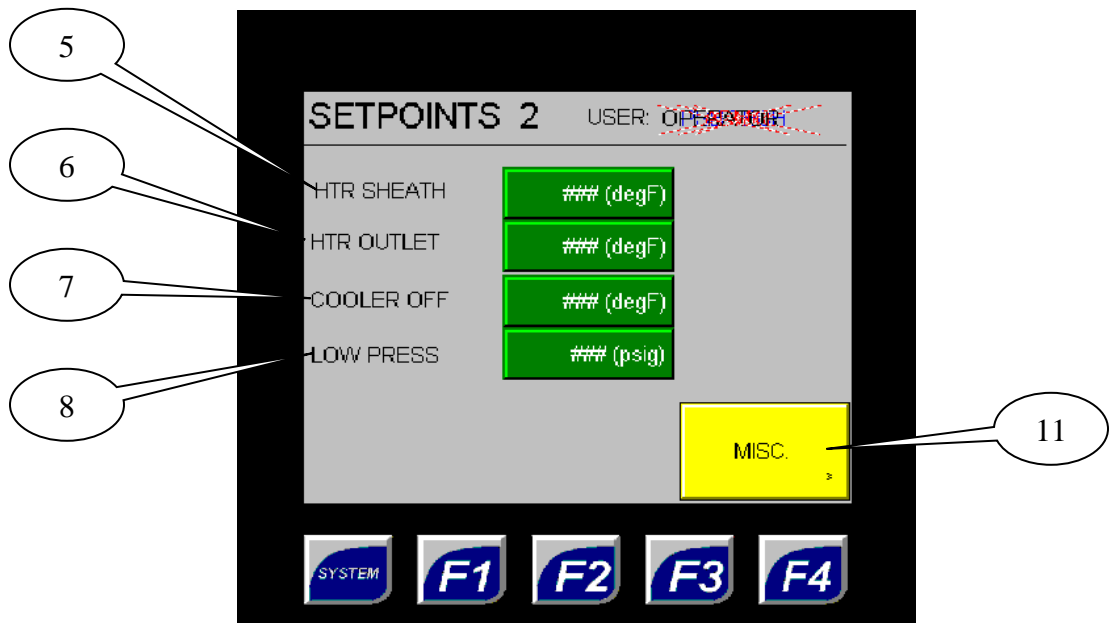

This screen enables changes to regeneration cycle and regeneration temperature. Screen is password protected and requires login as “admin” before values become visible. Login is done at Main screen.



Item	Object	Description
1	Heat time numeric entry	Regeneration heat time can be adjusted to handle performance issues. Touching screen where value is shown opens keypad to enable setpoint change. Entry is limited to maximum of 600 minutes
2	Cool time numeric entry	Regeneration cool time can be adjusted to handle temperature issues that may occur at cooldown. Touching screen where value is shown opens keypad to enable setpoint change. Entry is limited to maximum of 600 minutes
3	Heater control temperature numeric entry	Regeneration heater output can be changed using this parameter. Touching screen where value is shown opens keypad to enable setpoint change. Entry is limited to maximum of 450°F and a minimum of 0°F.
4	Heat termination temperature numeric entry	Regeneration heat termination temperature can be changed using this parameter. Touching screen where value is shown opens keypad to enable setpoint change. Entry is limited to maximum of 350°F and a minimum of 100°F.
5	Heater sheath temperature numeric entry	Regeneration heater protection limit can be adjusted to simulate alarm. Touching screen where value is shown opens keypad to enable setpoint change. Entry is limited to maximum of 800°F.
6	Heater outlet temperature numeric entry	Regeneration heater max. output can be adjusted to simulate alarm. Touching screen where value is shown opens keypad to enable setpoint change. Entry is limited to maximum of 500°F.
7	Cooler OFF temperature numeric entry	Regeneration cooler OFF can be changed to prevent freeze up in low ambient temperatures. Touching screen where value is shown opens keypad to enable setpoint change. Entry is limited to maximum of 75°F and a minimum of 40°F.
8	Low pressure numeric entry	Regeneration pressure can be adjusted to simulate alarm. Touching screen where value is shown opens keypad to enable setpoint change. Entry is limited to minimum of 0 psig and a maximum of 25 psig.
9	Alarm pushbutton	When pressed, main alarm screen showing current status becomes visible. If flashing, then an alarm is active.
10	Date/Time and Password chg pushbutton	Changes screen to enable administrator to change PLC date and time. Password change is also done thru this screen.
11	Misc pushbutton	Return to Miscellaneous screen menu.

**J. Date/Time/Password screen**

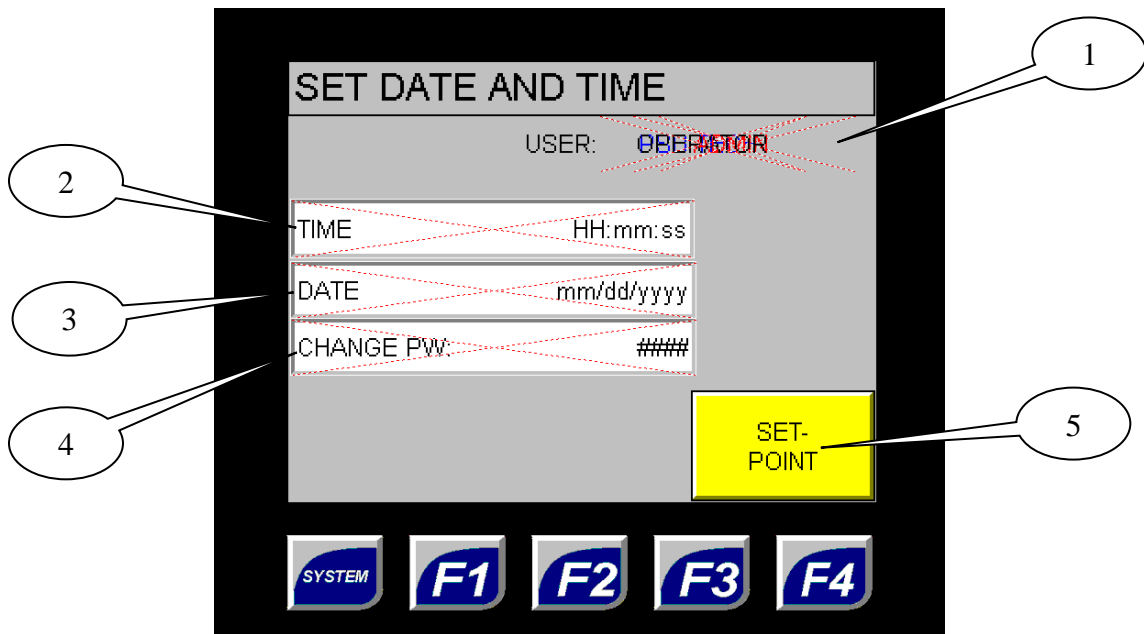

This screen allows administrator to change date, time, and password. Screen is accessed only when user is “ADMIN”.

Item	Object	Description
1	User login indicator	This shows current user that is logged in.
2	Time adjust numeric entry	Touching screen in area of time opens numeric keypad with arrow keys to change hour, minutes, and seconds.
3	Date adjust numeric entry	Touching screen in area of date opens numeric keypad with arrow keys to change month, day, and year.
4	Password change numeric entry	Touching screen in this area opens numeric keypad with “ENT” and “ESC” keys.
5	Setpoint pushbutton	Returns to setpoint change screen.

## K. Event History screen

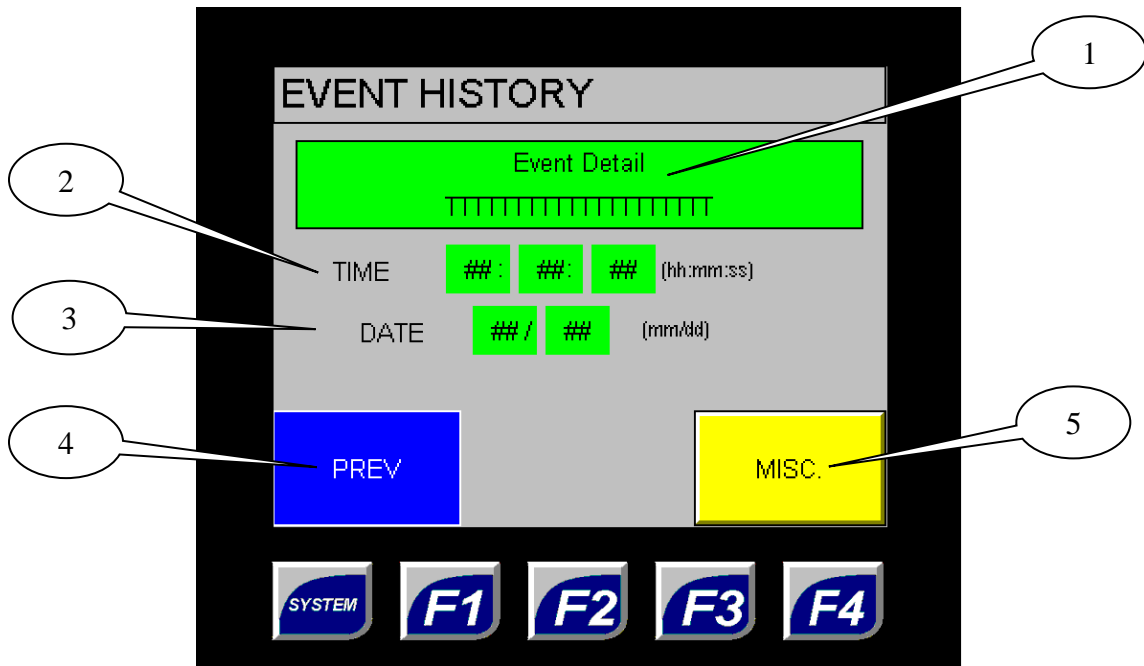

This screen enables administrator to view history of operator actions, system alarms, and any setpoint changes. Up to 100 Event codes are stored with the oldest code being removed. PREV button steps through codes from latest to oldest. When screen becomes visible, the latest code is shown. Screen is accessed only when user is "ADMIN". Contact customer service for list of applicable codes for this unit.

Item	Object	Description
1	Event code numeric	This shows code that represents operator action, system alarm, and any setpoint change.
2	Time numeric	Actual time is recorded when code was generated. Display is in hours: minutes:seconds.
3	Date numeric	Actual date is recorded when code was generated. Display is in month/day.
4	Previous pushbutton	When button is pressed, the next earlier code is shown.
5	Misc. pushbutton	Returns to miscellaneous screen menu.

## L. Communication Status screen

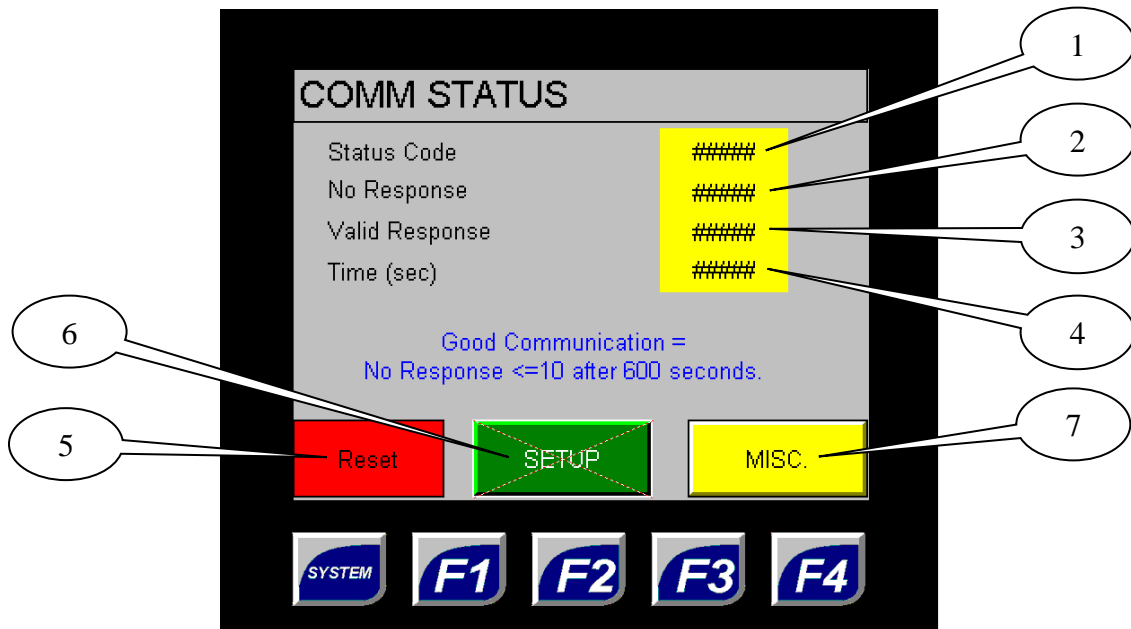

This screen enables administrator to view communication between PLC and thermocouple module. Should a communication error occur, this screen provides some troubleshooting aids to determine problem. A timer quantifies how well communication is occurring.

Item	Object	Description
1	Status code numeric	This shows code that represents error that is generated. A code of zero signifies good communication.
2	No response numeric	This shows number of times that module did not respond to PLC communication. Status code will change when count increments.
3	Valid response numeric	This shows the number of times that the module responded correctly.
4	Time numeric	This increments each second after "RESET" button is pressed. Used for monitoring communication for period of time.
5	Reset pushbutton	This button resets above objects 2 through 4 so quality of communication can established.
6	Setup pushbutton	Sets up communication between PLC and thermocouple module. Unauthorized changes will impact communications and render unit inoperable.
7	Misc. pushbutton	Returns to miscellaneous screen menu.

**M. Electrical Phase Check screen**

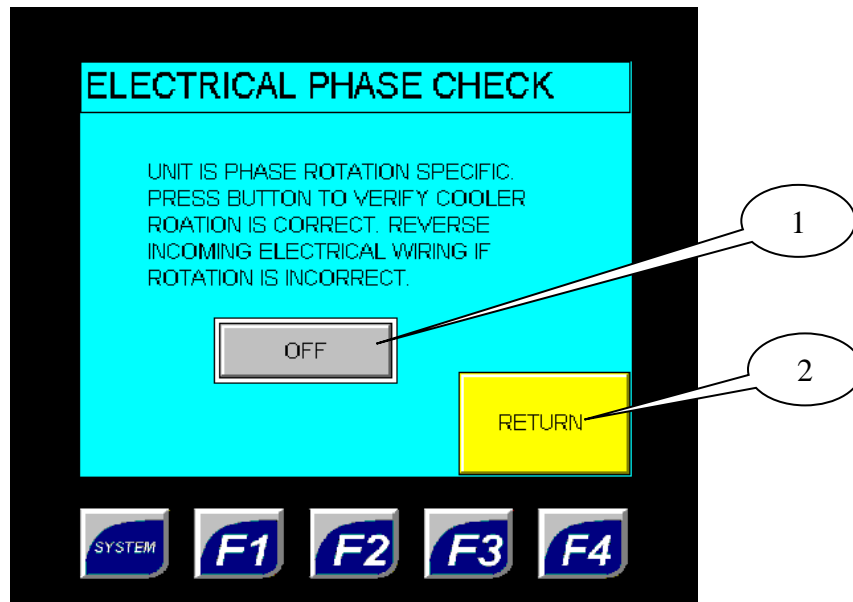

Since skid is portable, a method to check phase rotation is given. This screen enables rotation to be verified before skid is used for regeneration.

Item	Object	Description
1	Phase Check acknowledge pushbutton	When button is pressed, cooler motor starts. If rotation of fan matches rotation arrow on cooler then no further action is needed. Incorrect rotation will require electrical supply wires to skid to be reversed.
2	Return pushbutton	Returns to miscellaneous screen menu.

## N. Input/Output Maintenance screen

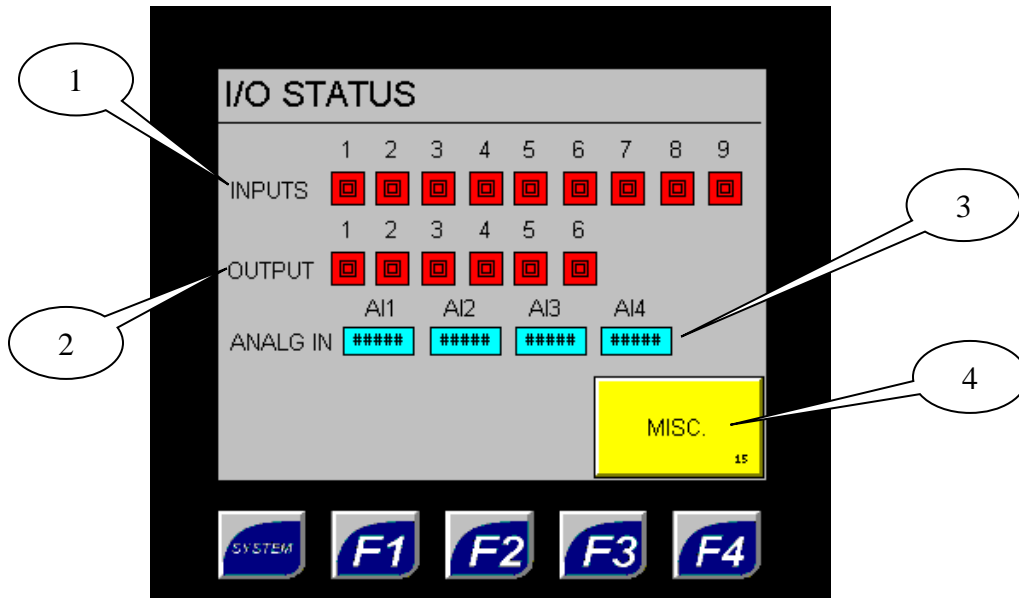





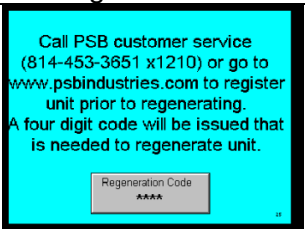
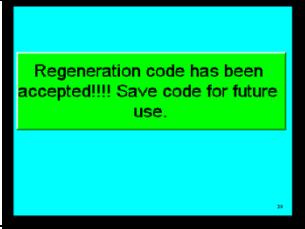
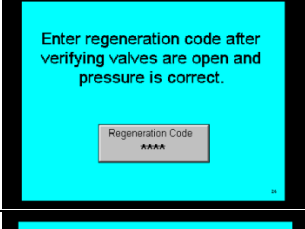
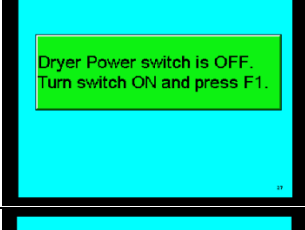
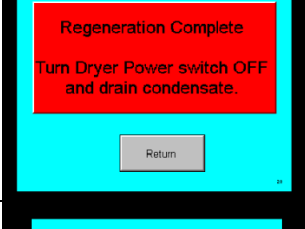
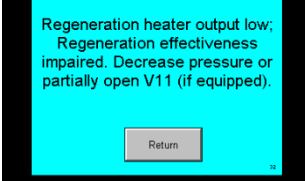

This screen is used for troubleshooting inputs and outputs. Unless technician is familiar with wiring, it is strongly recommended to refer to electrical schematic for which I/O point is connected to field device. Analog values generally should be fluctuating and not at limits.

Item	Object	Description
1	Input indicators	When indicator is GREEN, then voltage is applied to PLC input. A RED indicator means voltage is absent.
2	Output indicators	When indicator is GREEN, then output is turned ON and connected load is energized. A RED indicator means output is OFF and connected load is de-energized.
3	Analog input numeric	Numerical value between 0 and 65,535 will be present. Scaling of voltage/current level will place value between defined limits. This value is raw and lacks scaling to engineering units.
4	Misc pushbutton	Returns to Miscellaneous screen menu.

## V. OPERATOR TERMINAL MESSAGES

The following messages will be displayed under circumstances. Three types of messages are used. 1) alarm messages, 2) troubleshooting messages, and 3) notification messages.

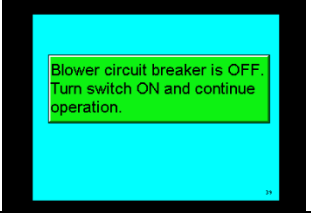
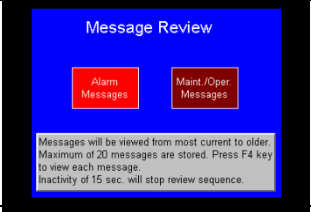
Message	Purpose	Visibility Trigger	Clear condition
	Remind operator or owner to register regeneration skid. 4-digit code will be given at that time.	First Power-up	After code has been entered.
	Notification that correct regen code has been entered.	Correct regen code	5 second time delay
	Notification to operator to enter regeneration code as first step in regeneration start process.	Regen Power switch ON and F1 button pressed.	After Code has been entered, or 5 seconds of inactivity.
	Notification to operator that Regen Power switch is in OFF position.	Regen Power switch OFF and F1 button pressed.	5 second time delay.
	Remind operator to turn off Regen Power switch and drain condensate.	Regeneration cycle completed.	"Return" button pressed.
	Prompt operator to lower pressure so that heater outlet temperature will rise.	Heater outlet temp reached setpoint but has fallen below 370°F.	"Return" button pressed.

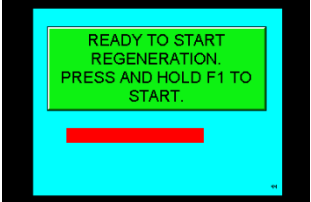
Message	Purpose	Visibility Trigger	Clear condition
	Notification that regeneration cycle has been advanced to cooling.	F2 button pressed and held for 5 seconds when regen is running.	5 second time delay or other action.
	Notification that cycle has been reset to beginning.	F2 button pressed and held for 5 seconds when regen is stopped.	5 second time delay or other action.
	Notification of dryer regeneration cycle has been stopped (paused). Remaining amount of 600 second limit is displayed.	Pressing F1 to Pause regen sequence or each minute of ten minute limit or F1 button to restart.	Remains until restarted or "Return" button pressed.
	Prompt to operator that cooler OFF temperature setpoint was temporarily raised to 50°F.	TE3 temperature at or below 34°F at regeneration start.	F3 button pressed or "Return" button pressed.
	Prompt to operator that blower circuit breaker is OFF.	Pressing F1 to start regeneration	5 second time delay or other action.
	Enabled operator to select which type of message to review.	Pressing F4 key	15 second time delay or message type button pressed.
	Indicates to operator that end of message history has been reached.	Pressing F4 key when last message in history is reached.	5 second time delay or other action.
	Provides operator feedback on F1 key press to start regeneration cycle.	Regen code has been entered.	Regeneration cycle started or 5 second time delay.



## VI. CONNECT/DISCONNECT INSTRUCTIONS



**IMPORTANT!** Sudden or rapid changes of pressure may damage skid blower. Use care in operating valves. Changes in pressure should not exceed 30 PSIG per minute.

### CONNECT INSTRUCTIONS:

#### A. Connect Hoses

Connect hoses between regeneration supply, vessel to be regenerated, and regeneration return. Make sure that fittings are tightened securely.

#### B. Leak Check

Slowly open valves V3 and V4 (regeneration inlet and outlet on dryer vessel) to leak check hoses – keep all other skid valves closed. Leak check hoses with soap and water mixture checking for bubbles and repair any leaks found.

#### C. Purge System

This procedure should be used at all times to ensure that hoses and skid piping has been purged to remove air (that contains oxygen). Natural gas tends to be lighter than air and will accumulate towards the top of closed volumes. Purge procedure removes trapped air from various sections the regeneration loop.

1. Slowly open V3 then open valves V12, and V13 to purge the heater, blower housing, sump and separator. When complete open valve V4 and immediately close V3. This allows the cooler and the remaining piping to be purged of air. When complete, close valves V12 and V13. Once valves V12 and V13 have been closed, fully open valve V3.
2. Close valve V4 to isolate the regeneration system.

#### D. Registration (first time only)

Registration is of paramount importance. PSB Industries desires to communicate with its customers/end users throughout the life of this product. A requirement to operate this unit is a 4 digit code that will be issued when registration process is complete. The information listed in Product Registration form located in section XVI will be asked for. Preferred information is end user/owner with contact person being maintenance or facility manager. Once information is obtained, then regen code will be issued. Code entry will be necessary for each regeneration. Store in accessible location with the intent to prevent unauthorized use of skid.

#### E. Start Regeneration

Follow section VIII to regenerate dryer vessel.

### DISCONNECT INSTRUCTIONS:

1. Turn regeneration skid **POWER SWITCH OFF**.
2. Close V3 and V4 on regen skid. Close V3 & V4 on dryer vessel. Open vent valves to depressurize hoses.
3. Disconnect hoses from dryer and remove hoses from regeneration skid.
4. Disconnect power cord from 460 volt supply receptacle.

5. Prepare unit for transport by covering connection outlets, depressurizing to near zero (keep slight positive pressure), securing cables and package to trailer.
6. Drain condensate tank through V12

## VII. FLOW DIAGRAM

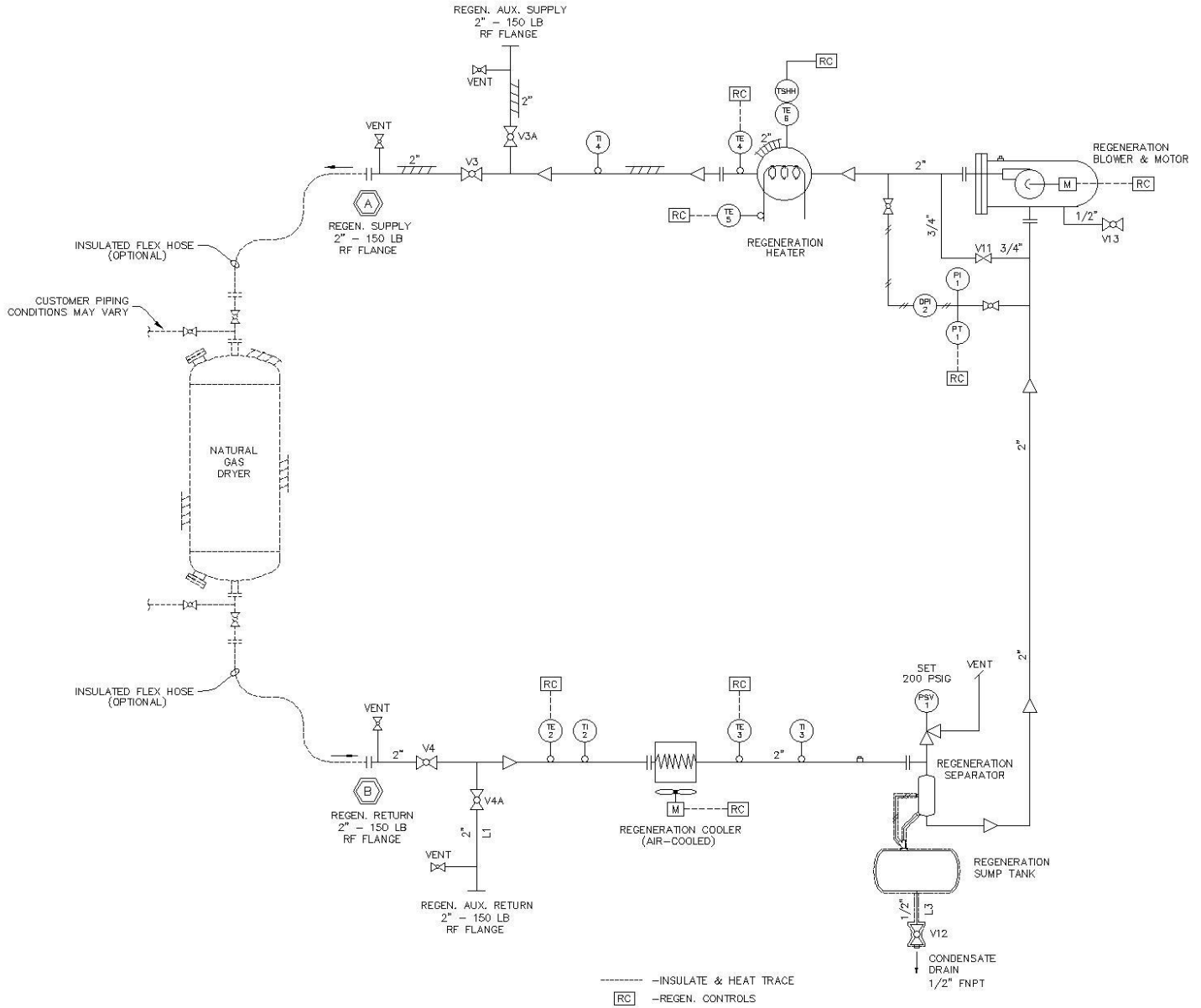

**Note:** Refer to P&ID for a more details.

## VIII. COMPONENT DESCRIPTIONS

1. Blower  
 The regeneration blower circulates the gas through the vessel and entire regeneration circuit. Mounted inside of pressure housing, the explosion-proof motor is direct coupled to the blower.
2. Heater

The flanged immersion heater is designed to raise the regeneration gas temperature to 425°F prior to flowing into the saturated dryer bed. Heater outlet temperature is monitored by thermocouple at the outlet of the heater. The PLC controls the heater output through ON-OFF cycling of contactors.

3. Cooler

Hot regeneration gas leaving the dryer bed must be cooled prior to entering the separator. The hot gas passes through the air-cooled heat exchanger. A motor driven fan draws air across the fins removing heat and condensing moisture.

4. Separator & Sump Tank

The separator separates moisture condensate from the gas stream. Condensate drains to the sump tank which **MUST** be drained after each regeneration.

5. Blower Bypass Valve

This valve is used to maximize the regeneration efficiency. System pressure changes may cause heater temperatures to fall below ideal setpoint. Opening valve increases temperature of heater. Conversely, closing valve during cooling will maximize cooling effectiveness. The valve allows operator to maximize regeneration temperature balance.

## IX. REGENERATION

Regeneration must be performed when the dryer is no longer able to produce the dew point specified. Regeneration pressure **MUST** be at 10 PSIG. For best results, regeneration should be performed during the coolest part of the day. Condensate sump tank must be drained prior to start.



### **WARNING:**

- **Failure to reduce pressure to 10 PSIG may result in blower damage or poor performance. For dryer vessels operating below 10 psig, a small (tubing) pressurization line from a higher pressure source will be needed to raise pressure. Regeneration skid can be pressurized through blower housing valve V13.**
- **Sudden or rapid changes of pressure may damage blower. Use care in operating valves. Changes in pressure should not exceed 30 PSIG per minute.**
- **Regeneration skid requires attended operation. Operator must be present during regeneration to minimize possible tampering by unauthorized persons. Allow for 6 hours minimum time to complete regeneration cycle.**

## Procedure - Refer to Flow Diagram in section VI.

1. Close dryer inlet & outlet isolation valves (located on dryer vessel).
2. Open regeneration loop isolation valves V3 & V4. Verify valve V11 is open.
3. Reduce pressure to 10 PSIG by slowly opening valve V12 (located on the separator sump tank). Shut valve V12 when it reaches 10 PSIG. If operating pressure is lower than required regeneration pressure, open valve (supplied by others) from high pressure source to regeneration loop.



**CAUTION: Ensure the drain is vented to a safe location.**

4. Turn “**DRYER POWER**” switch **ON**.
5. To start regeneration, press F3 key to clear alarms. Press F1 key and enter 4 digit regen code. Then press and hold F1 key on the operator display terminal. When dryer starts, verify that the blower is operating; cooler fan motor is in operation, i.e. drawing air across the cooling fins; and regeneration heater is energized by observing a gradual temperature rise on thermometer TI-4.
6. The approximate regeneration heating time is 6 hours. The correct regeneration supply temperature to the desiccant chamber is between 375°F to 425°F. The desired regeneration return temperature is approx. 200°F to 300°F. The heating time may require extension based on water load and ambient conditions to achieve these desired temperatures. To minimize energy usage and thermal aging of desiccant, a thermocouple (TE-2) located on regeneration return is used to sense when desiccant moisture adsorption is below design. Setpoint can be optimized based on actual operating conditions but is recommended @ 175°F.
7. The approximate cooling time is 4 hours. At the end of cooling, TI-2 temperatures in the range of 100°F to 120°F are acceptable.
8. When regeneration is complete close valves V3 and V4. Drain liquid from the sump tank by opening valve V12. Close valve V12 when all liquid has been drained.

### **IMPORTANT:**



**During the heating cycle and approximately one-hour into the cooling cycle liquid condensate will form in the separator and be stored in the separator sump tank. Be sure that flexible drain hose “free drains” (no traps) to sump tank from separator.**

9. Turn “**DRYER POWER**” switch **OFF**.
10. Perform Disconnect procedure in section VI to prepare unit for transport.

## X. ALARMS

### A. Regeneration Heater Sheath Overtemperature

This alarm protects the heater from damaging high element temperatures due to low or blocked flow.

Input: Temperature from TE-5

Setpoint: 800°F;

Action: Turn OFF Heater; alarm light (1LT) ON; Stop Regeneration operation; Operator reset required.

### B. Regeneration Heater Outlet Temperature High

This detects a failure of heater control devices that may cause heater to produce excessive regeneration gas temperatures.

Input: Temperature from TE-4

Setpoint: 500°F;

Action: Turn OFF Blower/Heater; alarm light (1LT) ON; Stop Regeneration operation; Operator reset required.

### C. Cooler Outlet Temperature High

This alarm prevents damage to blower due to high inlet blower temperature.

Input: Temperature from TE-3

Setpoint: 120°F;

Action: Turn OFF Heater; alarm light (1LT) ON; Stop Regeneration operation; Operator reset required.

### D. Blower Overload

This detects excessive blower motor amperage. Amperage is converted to heat that starter overload relay can sense and open control circuit to blower starter.

Input: Contact opening from M2-OL

Setpoint: Fixed;

Action: Turn Off Blower/Heater; alarm light (1LT) ON; Stop Regeneration operation; Operator reset required.

### E. Cooler Overload

This detects excessive cooler fan motor amperage. Amperage is converted to heat that starter overload relay can sense and open control circuit to cooler fan motor starter.

Input: Contact opening from M3-OL

Setpoint: Fixed;

Action: Turn OFF Blower/Heater; alarm light (1LT) ON; Stop Regeneration operation; Operator reset required.

**F. Thermocouple Failure**

The PLC thermocouple module detects when thermocouple has opened. Alarm stops operation until condition is corrected. A “No Response” alarm is activated when TE4 or TE5 does not show an increase in temperature from ambient.

Input: Thermocouple module Open status bits

Setpoint: Fixed;

Action: Turn OFF Blower/Heater; alarm light (1LT) ON; Stop Regeneration operation; Operator reset required.

**G. RS-485 Communication Problem**

Communication to thermocouple module is via RS-485. Failure of link will result in dryer operating without current temperature data and loss of control.

Input: PLC communication port status bits

Setpoint: Fixed;

Action: Turn OFF Blower/Heater; alarm light (1LT) ON; Stop Regeneration operation; Operator reset required.

**H. Heater Chamber Shutdown**

A thermocouple (TE-6) is physically attached to heater housing. When housing temperature rises above a fixed setpoint, the heater contactor opens. Blower continues to run to cool housing down. This is a hard wired safety and PLC monitors operation.

Input: TSHH temperature switch

Setpoint: 500°F

Action: Alarm light (1LT) ON; Heater turns OFF. Dryer operation continues; Turning off Dryer Power switch resets alarm.

**XI. MAINTENANCE PROGRAM**

Before Use - Drain blower housing of residual condensate.

Before Use - Check for any transport damage to unit.

Before Use - Check hoses for any damage.

During Use - Monitor regeneration temperature on TI-4, TI-3, and TI-2 for proper readings. Clear any alarms that occur.

After Use - Drain Sump tank.

After Use - Roll up power cord and check for any cuts, cord abrasions. Correct as necessary.

Six Months - Leak check piping with soap bubbles and correct as needed.

1 yr/250 hrs - Check oil level using blower maintenance procedure shown below.

5 yr/1000 hrs - Change oil in blower.

## **Blower Maintenance Procedure**

If unit is mounted on trailer or transportable, make sure that housing is level to check oil level.

1. Remove power from unit; Isolate regeneration loop from process and depressurize.
2. Remove studs and nuts from flange assembly on blower housing
3. Remove blower housing hold-down bolt and pull housing until blower is accessible.
4. Oil level in the oil sumps at each end of the blower should be at the middle of the sight gauges. Initial factory fill of oil is with Roots synthetic lubricating oil ISO-VG-220. Ambient temperature 32° to 90°F.
5. Reinstall blower assembly in reverse order. Use new spiral wound type gasket (PSB P/N 71046-847) when bolting flange up to housing to prevent leaks.
6. Perform leak check and purge procedures before placing into service.

## **Cold Weather Package Option (Heat Tracing and PLC Panel Heater) or Heat Tracing Option**

Dryer may be equipped with options to keep sump tank condensate and PLC components from damage by ambient temperatures below +32°F. It is imperative that control power be applied at all times when cold conditions are present.

Sump tank has an indicator light that should be illuminated when power is present. Electrical heat tracing is protected by a ground fault equipment protector (mounted in High voltage panel) to minimize electrical shock and equipment damage. An ambient temperature sensor prevents operation above 55°F degree operation.

A low voltage panel heater is mounted vertically along the left side interior of panel and contains a hermetic thermostatic controlled switch to keep internal components warm. A guard prevents accidental contact with heater surface. Care should be used when working in proximity of heater.

## XII. TROUBLESHOOTING

Symptom	Probable Cause	Remedy
No heater outlet temperature	Fuses blown	Test and replace
	Contactors not energized	Check voltage on coil. Replace as required
	Regeneration Cycle in cooling	Reset control by pressing and hold for 5 seconds "ALARM RESET" pushbutton. Then press "REGEN START".
	Heater failure	Check resistance and replace if open.
Blower Overload alarm	Overloads tripped	Reset
	Contactors not energized	Check voltage on coil. Replace as required
	Blower mechanical problem	Depressurize and remove blower housing. Check blower freely rotates
Heater outlet temperature high alarm	Regeneration pressure low	Raise to 10-15 PSIG
	Contactors malfunction	Check for welded together contacts
	Thermocouple problem	Test and replace as needed.
	Blower failure	Refer to symptom "Blower overload alarm"
Cooler Overload alarm	Overloads tripped	Reset
	Contactors not energized	Check voltage on coil. Replace as required
	Motor failure	Check windings and replace as needed.
Cooler Outlet Temperature High Alarm	Cooler fan not running	Refer to symptom "Cooler overload alarm"
	Ambient temperature high	Regenerate when air temperature is < 100 F
	After-cooler dirty	Clean dirt and debris from fins.
	Thermocouple failure	Test and replace as needed.
Heater Sheath Over Temperature Alarm	Blower failure	Refer to symptom "Blower overload alarm"
	Flow blocked	Open valve "V3" to increase flow.
	Heater thermocouple failure	Test and replace as needed.
Heater Chamber Alarm	Heater contactor mechanical problem	Verify contactor operation and replace as needed.
	Valve closed	Verify that V3 and V4 valves are open during regeneration.
	Blower problem	Blower mechanical issue (coupling or blower internal binding)
	Blower fuse blown	Check and replace as necessary



## XII. TROUBLESHOOTING – cont'd

Symptom	Probable Cause	Remedy
Thermocouple Failure Alarm	Wiring problem	Check for loose connections
	Thermocouple bad	Remove and replace
	PLC problem	Check power to thermocouple
Check thermocouple module		
TE4 or TE5 No response Alarm	T/C wiring problem	Check for shorted wiring
	Heater not producing heat	Determine if other alarms are active
		Verify that power is applied to heater
		Verify heater amperage is correct
False positive detection	Reset alarm and monitor temperature for increase above 150°F in 5 minutes.	
RS-485 Communication problem Alarm	Cable unplugged	Reconnect and verify
	Termination resistor problem	Verify resistance is 120 ohms and connected between RX/TX at thermocouple module.
		Verify middle DIP switch on PLC is ON.
Baud rate problem	Verify that baud rate between PLC and thermocouple module is same.	

**XIII. SPECIFICATIONS & DATA**

**A. GENERAL**

REGENERATION PRESSURE	10 PSIG
REGENERATION TIME (approx.)	10 HOURS
HEAT/COOL TIME (approx.)	6 HOURS/4 HOURS
ELECTRICAL LOAD	44.4 amps @ 460V 3ph 60 Hz
AREA CLASSIFICATION	CL 1 DIV 2 GR D

**B. HEATER**

KW	24
MATERIAL	INCOLOY
WATT DENSITY	<15 W/IN <sup>2</sup>
CLASSIFICATION	CL 1 DIV 2 GR D

**XIV. PLC DATA ACCESS**

The following list identifies the data points inside PLC that can be monitored by SCADA system. An Ethernet connection is configured with factory default IP address of 192.168.0.10. Follow PLC user manual to adjust IP address to suit installation. Configuration of SCADA should not allow access to any other PLC address than those listed below.

PLC Address	Data type	Description	Value Range
%R1100	Integer	Cooler Outlet Temperature	-346 to 1400 F
%R1101	Integer	Heater Outlet Temperature	-346 to 1400 F
%R1102	Integer	Heater Sheath Temperature	-346 to 1400 F
%R1103	Integer	Heat Termination Temp.	-346 to 1400 F
%R1104	Integer	Heating Time	0-600 minutes
%R1105	Integer	Cooling Time	0-600 minutes
%R1106	Integer	Spare	
%R1107	Integer	Spare	
%R1108.1	Binary	Blower Mtr. Overload Alarm	ON=Alarm
%R1108.2	Binary	Heater Sheath Overtemp Alarm	ON=Alarm
%R1108.3	Binary	Cooler Mtr. Overload Alarm	ON=Alarm
%R1108.4	Binary	Cooler Outlet Temp High Alarm	ON=Alarm
%R1108.5	Binary	Heater Outlet Temp High Alarm	ON=Alarm
%R1108.6	Binary	Thermocouple Open Alarm	ON=Alarm
%R1108.7	Binary	Spare	
%R1108.8	Binary	Heater Chamber Alarm	ON=Alarm
%R1108.9	Binary	Spare	
%R1108.10	Binary	Spare	
%R1108.11	Binary	Spare	
%R1108.12	Binary	Spare	
%R1108.13	Binary	Regeneration Running	ON=Running
%R1108.14	Binary	Heating Done	ON=Heating Done
%R1108.15	Binary	Regeneration Done	ON=Regen Done
%R1108.16	Binary	Power On	ON=Power On

## XV. REGENERATION SETUP & FINISH CHECKLIST

<b>SETUP CHECKLIST</b>			
<b>Item Number</b>	<b>Action</b>	<b>Done</b>	<b>Notes</b>
1	Position skid near dryer to be regenerated so hoses are long enough to connect to dryer regeneration connection points.	<input type="checkbox"/>	
2	Check for transportation damage to skid. Correct or repair as necessary.	<input type="checkbox"/>	
3	Remove all shipping braces and connection plugs/flange covers.	<input type="checkbox"/>	
4	Loosen bolts on heater support to allow thermal movement during operation. Bolts identified with tag that reads "CAUTION - LOOSEN SUPPORT BOLTS TO PREVENT EXCESSIVE THERMAL STRESS TO PIPING DURING NORMAL OPERATION".	<input type="checkbox"/>	
5	Connect hoses to tagged connection "REGEN SUPPLY" and "REGEN RETURN" on skid and dryer.	<input type="checkbox"/>	
6	Close dryer process inlet and outlet valves to isolate vessel to be regenerated	<input type="checkbox"/>	
7	Open dryer regeneration valves to pressurize regeneration lines.	<input type="checkbox"/>	
8	Verify that no leaks are present on hose connections to skid and dryer vessel. Use soap bubbles if necessary to ensure tightness.	<input type="checkbox"/>	
9	Open vent valves on regen skid to bleed out trapped air.	<input type="checkbox"/>	
10	Depressurize dryer vessel and regeneration hoses to regen skid.	<input type="checkbox"/>	
11	When dryer vessel pressure nears 20 PSIG, open regen skid V3 and V4 to equalize pressure.	<input type="checkbox"/>	
12	Check for loose electrical components & fuses. Check all plug-in relays are securely seated in the relay sockets	<input type="checkbox"/>	
13	Drain sump tank using V12 and verify no condensate is in blower housing using V13	<input type="checkbox"/>	
14	Connect power cord to 460V supply receptacle and energize.	<input type="checkbox"/>	
14A	Verify electrical phasing is correct using "Electrical Phase Check"	<input type="checkbox"/>	
15	Review regeneration skid instruction manual Section VII for regeneration procedure.	<input type="checkbox"/>	
16	Turn "Dryer Power" switch ON	<input type="checkbox"/>	
17	Clear any alarms and Press "Regen Start" pushbutton. Allow regeneration to complete cycle.	<input type="checkbox"/>	

<b>FINISH/ TRANSPORT CHECKLIST</b>			
<b>Item Number</b>	<b>Action</b>	<b>Done</b>	<b>Notes</b>
1	Turn "Dryer Power" switch OFF.	<input type="checkbox"/>	
2	Disconnect 460V power cord from supply and reinstall plug cover.	<input type="checkbox"/>	
3	Close dryer vessel regeneration valves	<input type="checkbox"/>	
4	Close regeneration skid valves V3 & V4	<input type="checkbox"/>	
5	Depressurize hoses through vents	<input type="checkbox"/>	
6	Remove hoses and store studs, nuts and gaskets for next use of hoses. Reinstall flange covers and plugs.	<input type="checkbox"/>	
7	Tighten heater support bolts and reinstall transport braces and anchors.	<input type="checkbox"/>	
8	Drain sump tank of collected condensate into container for disposal	<input type="checkbox"/>	
9	Make sure all valves are closed.	<input type="checkbox"/>	

**Installation Comments/ Notes:**

---



---



---



---



---

**Customer Representative:** \_\_\_\_\_ **Date:** \_\_\_\_\_

**XVI. PARTS LIST & PRODUCT REGISTRATION**

Refer to Process & Instrument diagram for complete parts list. For replacement filter element, refer to housing tag for part number.

**Factory Service/Parts**

When corresponding with the manufacturer regarding the dryer, always refer to model and serial number stamped on the nameplate located on the low voltage control panel. Call PSB customer service at (814) 453-3651.

## PRODUCT REGISTRATION

PSB requests all OWNERS to register the skid with the factory. Your information and feedback is essential in providing the highest quality product and to continuously improve our equipment. Additionally, PSB can recommend spare parts to allow the dryer to be maintained and provide years of trouble free operation.

Please provide the following information:

COMPANY / ORGANIZATION: \_\_\_\_\_

CONTACT NAME: \_\_\_\_\_

CONTACT TITLE: \_\_\_\_\_

EMAIL: \_\_\_\_\_

PHONE: \_\_\_\_\_

MODEL NUMBER: \_\_\_\_\_

SERIAL NUMBER: \_\_\_\_\_

DATE SKID WAS INITIALLY COMMISSIONED: \_\_\_\_\_

PLEASE RETURN INFORMATION TO PSB

- VIA FAX: 814-454-3492
- VIA EMAIL: [PSB@GENAIR.NET](mailto:PSB@GENAIR.NET)
- VIA PHONE: 814-453-3651 X 1210



**PSB INDUSTRIES INC.**  
*1202 West 12th Street*  
*Erie, PA 16501 USA*  
*Phone: (814) 453-3651*  
*Fax: (814) 454-3492*  
*[www.PSBINDUSTRIES.com](http://www.PSBINDUSTRIES.com)*