

100T-4 Triplex Plunger Pump

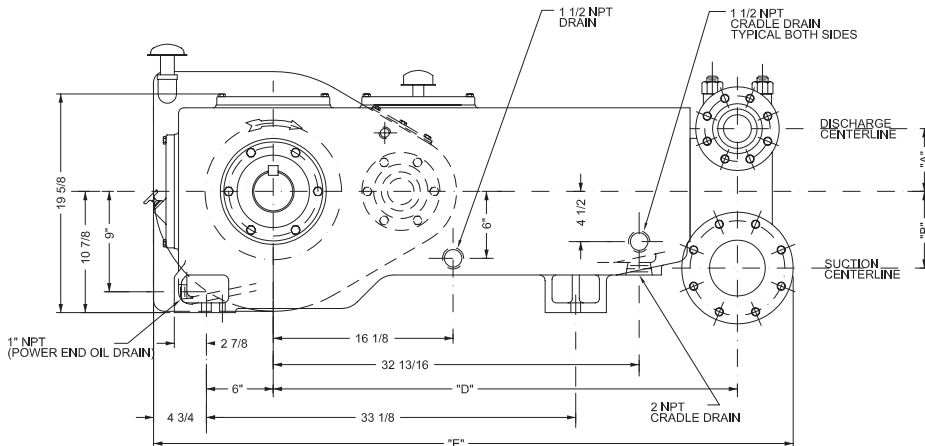
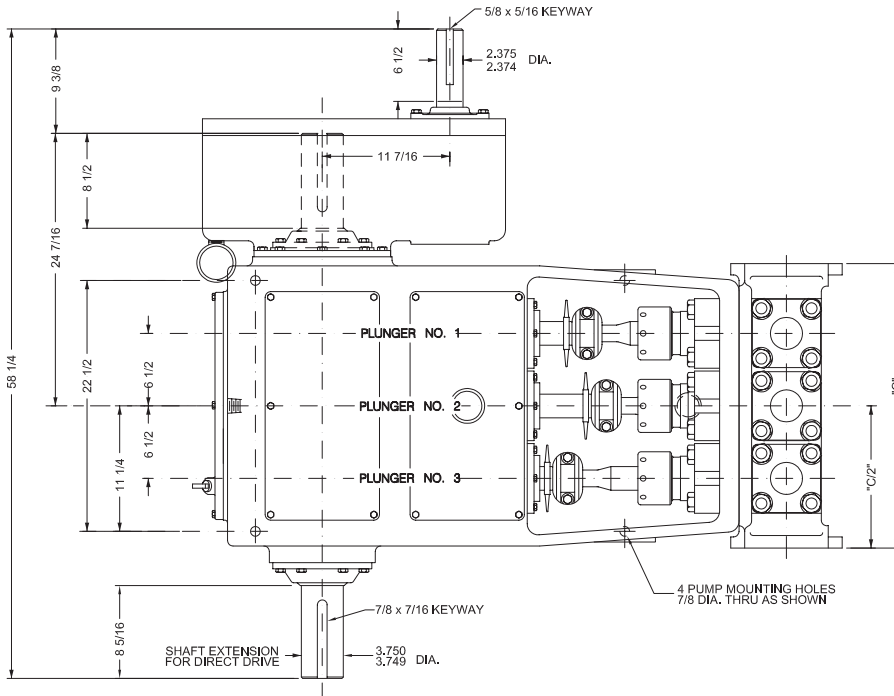

Specifications

Pump Size

maximum plunger size x stroke length in.(mm):
3 3/8 x 4 (85.7 x 101.6)

Rated bhp at 450 rpm (kw): 100 (75)

Rated plunger load pounds(Kg): 6595 (2991.4)

Maximum discharge pressure: psi(kPa)

"L" model: 1659 (11,436)

"M" model: 3180 (21,925)

"H" model: 5000 (34,474)

Crankshaft extension: in.(mm)

Diameter: 3 3/4 (95.25)

Length long side: 8 1/2 (215.9)

Length short side: 8 5/16 (211.38)

Keyway (width x depth):

7/8 x 7/16 (22.2 x 11.1)

Maximum recommended sheave

in.(mm): 44 (1118)

Minimum recommended sheave

in.(mm): 24 (610)

For larger sizes: **Contact Factory**

Pinion shaft extension,

if gear reducer is supplied in.(mm)

For belt or chain drive: **Contact Factory**

For direct drive: Diameter: 2 3/8 (60.33)

Length: 6 1/2 (165.10)

Keyway (width x depth):

5/8 x 5/16 (15.9 x 7.9)

Accessory gear reduction unit ratios:

2.60:1, 3.15:1, 3.42:1, 3.89:1, 4.27:1

Oil Capacity gallons (L)

Crankcase: 5.5 (20.8)

Gear Reducer: 3 (11.40)

Weight, pump only on

wood shipping skids pounds (Kg):

2300 (1043.3)

Gear reducer, approximate pounds (Kg):

500 (226.8)

Pump Model	Flange Connection		Dimensions in inches (mm)				
	Discharge Connection Sizes	Suction Connection Sizes	A	B	C	D	E
100T-4L	2 1/2 (63.5) API-2000 RJ	5 (127) ANSI-150 FF	5 5/8	6 7/8	25 1/2	41 5/8	57 3/8
100T-4M	1 1/2 (38.1) API-5000 RJ	3 (76.2) ANSI-150 FF	4 3/4	5 1/4	23 3/4	40 7/8	54 3/8
100T-4H	1 1/2 (38.1) ANSI-2500 RJ	3 (76.2) ANSI-300 FF	4 3/4	5 1/4	25 1/2	40 1/2	55 3/8

100T-4 Triplex Plunger Pump

Performance Data

PUMP	English Units					200 RPM		250 RPM		300 RPM		350 RPM		400 RPM		450 RPM	
	Plunger Dia. In.	Plunger Area Sq. In.	BPD per RPM	GPM per RPM	Max. Press. PSI	BPD	GPM	BPD	GPM	BPD	GPM	BPD	GPM	BPD	GPM	BPD	GPM
100T-4L	3.375	8.9462	15.9338	0.4647	737	3187	92.9	3984	116.2	4781	139.4	5577	162.7	6374	185.9	7171	209.1
	3.250	8.2958	14.7754	0.4309	795	2956	86.2	3694	107.7	4433	129.3	5172	150.8	5911	172.4	6649	193.9
	3.000	7.0686	12.5897	0.3672	933	2518	73.4	3148	91.8	3777	110.2	4407	128.5	5036	146.9	5666	165.2
	2.750	5.9396	10.5788	0.3085	1110	2116	61.7	2645	77.1	3174	92.6	3703	108.0	4232	123.4	4761	138.8
	2.500	4.9087	8.7428	0.2550	1500	1749	51.0	2186	63.7	2623	76.5	3060	89.2	3498	102.0	3935	114.7
	2.250	3.9761	7.0817	0.2065	1659	1417	41.3	1771	51.6	2125	62.0	2479	72.3	2833	82.6	3187	92.9
100T-4M	2.125	3.5466	6.3167	0.1842	1860	1264	36.8	1580	46.1	1896	55.3	2211	64.5	2527	73.7	2843	82.9
	2.000	3.1416	5.5954	0.1632	2099	1120	32.6	1399	40.8	1679	49.0	1959	57.1	2239	65.3	2518	73.4
	1.875	2.7612	4.9178	0.1434	2388	984	28.7	1230	35.9	1476	43.0	1722	50.2	1968	57.4	2214	64.5
	1.750	2.4053	4.2840	0.1249	2742	857	25.0	1071	31.2	1286	37.5	1500	43.7	1714	50.0	1928	56.2
	1.625	2.0739	3.6938	0.1077	3180	739	21.5	924	26.9	1109	32.3	1293	37.7	1478	43.1	1663	48.5
100T-4H	1.750	2.4053	4.2840	0.1249	2742	857	25.0	1071	31.2	1286	37.5	1500	43.7	1714	50.0	1928	56.2
	1.625	2.0739	3.6938	0.1077	3180	739	21.5	924	26.9	1109	32.3	1293	37.7	1478	43.1	1663	48.5
	1.500	1.7671	3.1474	0.0918	3732	630	18.4	787	22.9	945	27.5	1102	32.1	1259	36.7	1417	41.3
	1.375	1.4849	2.6447	0.0771	4441	529	15.4	662	19.3	794	23.1	926	27.0	1058	30.9	1191	34.7
	1.250	1.2272	2.1857	0.0637	5000	438	12.7	547	15.9	656	19.1	765	22.3	875	25.5	984	28.7
Brake Horsepower Required						45.0		56.0		67.0		78		89		100	

PUMP	Metric Units					200 RPM		250 RPM		300 RPM		350 RPM		400 RPM		450 RPM	
	Plunger Dia. mm	Plunger Area cm ²	M ³ /Hr per RPM	L/Sec. per RPM	Max. Press. kPa	M ³ /Hr	L/Sec.	M ³ /Hr	L/Sec.	M ³ /Hr	L/Sec.	M ³ /Hr	L/Sec.	M ³ /Hr	L/Sec.	M ³ /Hr	L/Sec.
100T-4L	86	57.717	0.1055	0.0293	5083	21.11	5.86	26.39	7.33	31.66	8.80	36.94	10.26	42.22	11.73	47.49	13.19
	83	53.521	0.0979	0.0272	5481	19.57	5.44	24.47	6.80	29.36	8.16	34.25	9.52	39.15	10.88	44.04	12.23
	76	45.604	0.0834	0.0232	6433	16.68	4.63	20.85	5.79	25.02	6.95	29.19	8.11	33.36	9.27	37.53	10.42
	70	38.320	0.0701	0.0195	7656	14.01	3.89	17.52	4.87	21.02	5.84	24.53	6.81	28.03	7.79	31.53	8.76
	64	31.669	0.0579	0.0161	10342	11.58	3.22	14.48	4.02	17.37	4.83	20.27	5.63	23.16	6.44	26.06	7.24
	57	25.652	0.0469	0.0130	11436	9.38	2.61	11.73	3.26	14.07	3.91	16.42	4.56	18.76	5.21	21.11	5.86
100T-4M	54	22.881	0.0418	0.0116	12821	8.37	2.32	10.46	2.91	12.55	3.49	14.64	4.07	16.74	4.65	18.83	5.23
	51	20.268	0.0371	0.0103	14474	7.41	2.06	9.27	2.57	11.12	3.09	12.97	3.60	14.83	4.12	16.68	4.63
	48	17.814	0.0326	0.0090	16468	6.51	1.81	8.14	2.26	9.77	2.71	11.40	3.17	13.03	3.62	14.66	4.07
	44	15.518	0.0284	0.0079	18905	5.68	1.58	7.09	1.97	8.51	2.36	9.93	2.76	11.35	3.15	12.77	3.55
	41	13.380	0.0245	0.0068	21925	4.89	1.36	6.12	1.70	7.34	2.04	8.56	2.38	9.79	2.72	11.01	3.06
100T-4H	44	15.518	0.0284	0.0079	18905	5.68	1.58	7.09	1.97	8.51	2.36	9.93	2.76	11.35	3.15	12.77	3.55
	41	13.380	0.0245	0.0068	21925	4.89	1.36	6.12	1.70	7.34	2.04	8.56	2.38	9.79	2.72	11.01	3.06
	38	11.401	0.0208	0.0058	25731	4.17	1.16	5.21	1.45	6.25	1.74	7.30	2.03	8.34	2.32	9.38	2.61
	35	9.580	0.0175	0.0049	30623	3.50	1.00	4.38	1.25	5.26	1.52	6.13	1.71	7.01	2.00	8.88	2.50
	32	7.917	0.0145	0.0040	34474	2.91	0.84	3.59	1.00	4.38	1.25	5.26	1.52	6.13	1.71	7.01	2.00
Kilowatts Required						33.6		41.8		50.0		58.0		66		75	

Volumetric Rate is based on 100% Volumetric Efficiency. Brake Horsepower/Kilowatts Required is based on 90% Mechanical Efficiency. For operation below 200 RPM, auxiliary lubrication system required. Not all plunger sizes are shown. Contact National-Oilwell for additional information.

The information and data on this sheet is accurate to the best of our knowledge and belief, but are intended for general information only. Applications suggested for the materials are described only to help readers make their own evaluations and decisions, and are neither guarantees nor to be construed as express or implied warranties of suitability for these or other applications. National Oilwell makes no warranty either express or implied beyond that stipulated in National Oilwell Standard Terms and Conditions of Sale.

Authorized Distributor:



www.nov.com • mission.sales@nov.com
 10000 Richmond, Houston, Texas 77042
 (713)346-7500 (phone) • (713)346-7366 (fax)