

WPS NUMBER 104 (Rev. 1)

PQR NUMBER 104A

104B

QUALIFIED FOR

MATERIAL (TYPICAL): P1 to P1 (SA 516, SA 105, SA 106, etc.)

PROCESS: SMAW JOINT DESIGN: Groove & Fillet

POSITION: All DIAMETER: All

AWS CLASSIFICATION: E6010, E6011, E7018, E7018-1, E7018-A1

BASE METAL THICKNESS RANGE QUALIFIED:

P.W.H.T.: 1.6 to 50.8mm (1/16 to 2.0 in.)

**ALBERTA
LABOUR
BOILERS & PRESSURE VESSELS ACT
WELDING PROCEDURE**

Reg. No. WP 13122
Spec No. #104 (REV 1)
Weld Process SMAW
Matl. Gr. P.No. 1 to P No. 1
Elec. Gr. F No. 3+4 A No. 1
Th. Qual. For 50.8mm Position .. All
..... P.W.H.T

Yr. 88 Mo. 3 Day 3 Signed .. R. Roseberg ..
R. ROSEBERG, P. ENG.
WELDING SPECIALIST

Boilers Branch Registration

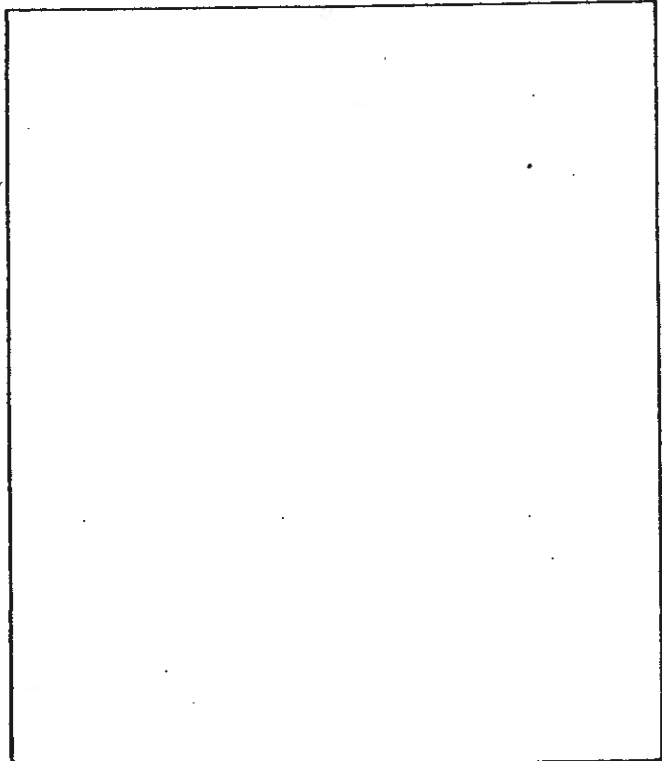

WELDING PROCEDURE SPECIFICATION

R.J.V. Gasfield Service Ltd., 4901 - Bruce Rd., Box 295, Vegreville, Alberta T0B 4L0

WELDING PROCEDURE SPECIFICATION NUMBER 104 (Rev. 1) DATE September 8, 1987

REVISIONS add PQR 104B

SUPPORTING PQR NUMBERS(S) 104A, 104B

WELDING PROCESS(ES) SMAW TYPES Manual

JOINTS (QW-402)

Joint Design See attached sheet, figures 1 to 15

Backing Other

BASE METALS (QW-403)

P-Number 1 to P-Number 1

Thickness Range: Groove 1.6 to 50.8mm (1/16 to 2.0 in.)

Fillet All

Pipe Diameter Ranges: Groove All

Fillet All

Other

FILLER METALS (QW-404)

Specification No. (SFA) 5.1, 5.5

AWS No. (Class) E6010, E6011, E7018, E7018-1, E7018-A1

F-No. F3, F4

A-No. 1, 2

Size 2.4 to 6mm (3/32 to 1/4 in.)

Deposited Weld Metal Thickness Range: No single pass with over $\frac{1}{2}$ " (12.7mm) of deposited metal

Groove F3 "t" = 4mm (5/32 in.); F4 "t" = 46mm (1.81 in.)

Fillet All

Electrode - Flux (Class)

Other

POSITION (QW-405)

Position of Groove All Weld Progression Uphill when applicable

PREHEAT (QW-406)

Preheat Temp. Min. See attached section Interpass Temp. Max. Weld build up

Preheat Maintenance

POSTWELD HEAT TREATMENT (QW-407)

Temperature _____ See attached section _____ Time Range _____ See attached page _____

GAS (QW-408)Shielding Gas(es) N/A

Flow Rate _____

Other _____

ELECTRICAL CHARACTERISTICS (QW-409)Current Direct Polarity ReverseAmps See table below Volts _____Tungsten Electrode Size and Type N/AMode of Metal Transfer N/A

Electrode Wire Feed Speed Range _____

Other _____

TECHNIQUE (QW-410)String or Weave Both Travel Speed (Range) _____Initial and Interpass Cleaning Brushing, chipping, gouging, grindingMethod of Back Gouging Air carbon arc when requiredMultiple or Single Pass (per side) MultipleMultiple or Single Electrodes single

Other _____

WELD LAYER	PROCESS	FILLER METAL		CURRENT		VOLTAGE RANGE	T/S RANGE mm/min. (ipm)	OTHER
		CLASS.	DIAMETER mm. (in.)	TYPE POLAR.	AMP RANGE			
	SMAW	E6010	2.4	DCRP	40-80	18-24	38-300	Size of electrode, number of passes, amperage, voltage and travel speed will differ with position, thickness and joint configuration.
	SMAW	E6011	(3/32)	DCRP	70-140	19-26	(1.5-12)	
	SMAW	as above	3.2	DCRP	100-160	20-28	38-350	
	SMAW	as above	(1/8)	DCRP	60-110	18-24	(1.5-14)	
	SMAW	E7018	4.0	DCRP	90-150	19-26	50-400	
	SMAW	E7018-1	(5/32)	DCRP	110-220	21-28	(2-16)	
	SMAW	as above	2.4	DCRP	160-320	22-30	38-300	
	SMAW	as above	(3/32)	DCRP	260-350	23-32	(1.5-14)	
	SMAW	as above	(1/8)	DCRP	300-400	23-32	38-350	
	SMAW	as above	3.2	DCRP			(1.5-14)	
	SMAW	as above	(1/8)	DCRP			(1.5-14)	
	SMAW	as above	4.0	DCRP			50-400	
	SMAW	as above	(5/32)	DCRP			(2-16)	
	SMAW	as above	5.0	DCRP			75-500	
	SMAW	as above	(3/16)	DCRP			(3-20)	
	SMAW	as above	5.5	DCRP			125-500	
	SMAW	as above	(7/32)	DCRP			(5-20)	
	SMAW	as above	6.35	DCRP			125-550	
	SMAW	as above	(1/4)	DCRP			(5-22)	

GROOVE DESIGN

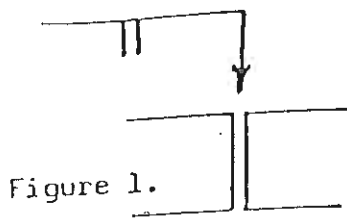

Figure 1.

Single Square Butt

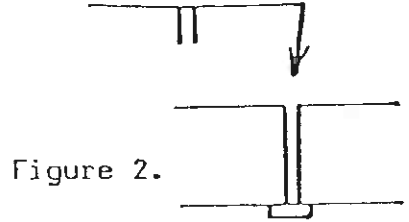

Figure 2.

Single Square Butt with Backing Strip

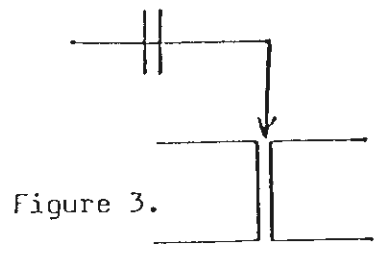

Figure 3.

Double Square Butt

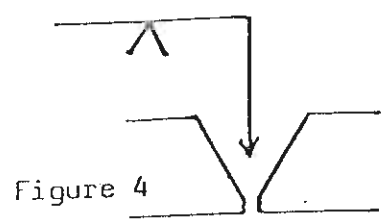

Figure 4

Single Vee Butt

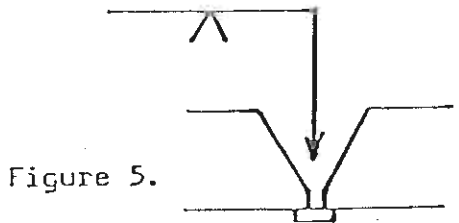

Figure 5.

Single Vee Butt With Backing Strip

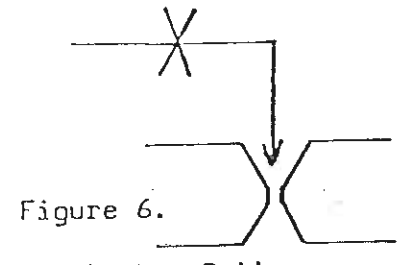

Figure 6.

Double Vee Butt

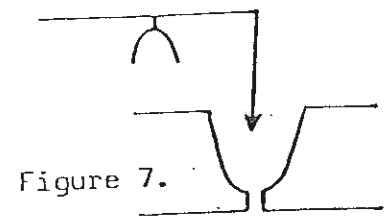

Figure 7.

Single U Butt

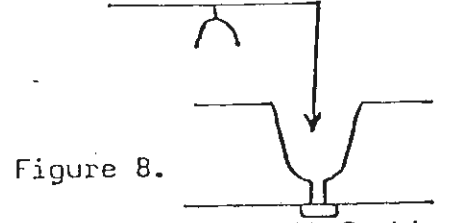

Figure 8.

Single U Butt With Backing Strip

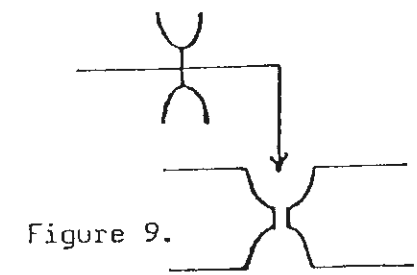

Figure 9.

Double U Butt

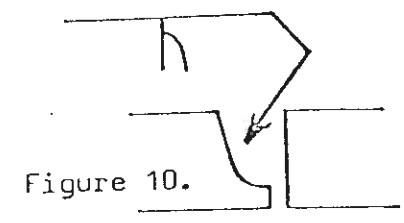

Figure 10.

Single J Butt

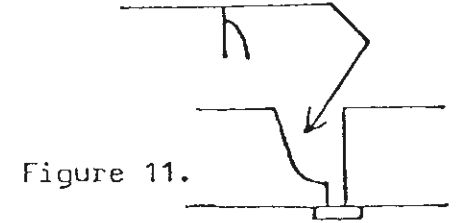

Figure 11.

Single J Butt With Backing Strip

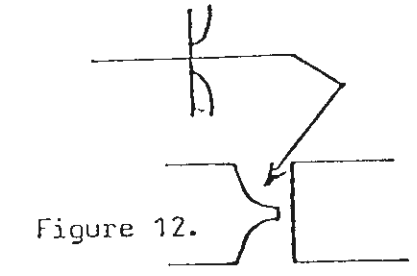

Figure 12.

Double J Butt

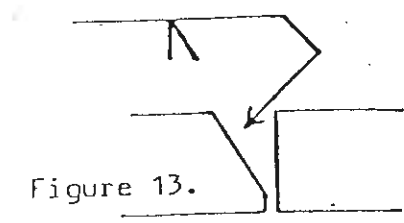

Figure 13.

Single Bevel Butt

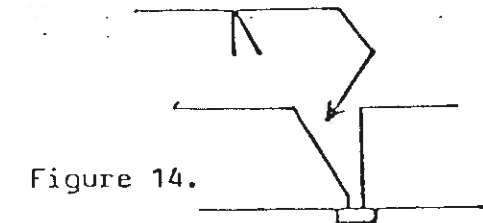

Figure 14.

Single Bevel Butt With Backing Strip

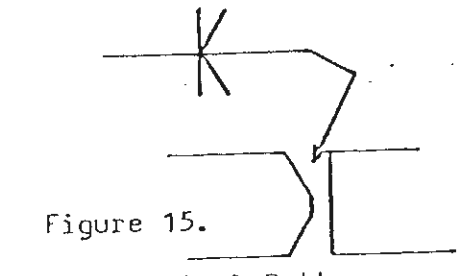

Figure 15.

Double Bevel Butt

PREHEAT

1. Welds joining pressure parts or attachments shall be preheated to not less than the minimum preheat temperature stated in 6.
2. The preheat temperature shall be maintained until welding is completed.
3. If welding is interrupted, the weld joint and adjacent areas shall be re-heated to the minimum preheat temperature specified in 6.
4. The preheated area shall not be less than 50.8mm (2.0 in.) wide on each side of the weld.
5. Preheat temperatures shall be checked by the welder or inspector, using temperature indicating crayons or other reputable methods.
6. Minimum preheating temperatures:

PRESSURE VESSELS

<u>THICKNESS</u>	<u>MINIMUM PREHEATING TEMPERATURES</u>
0 to 31.75mm (0 to 1 1/4 in.)	24°C (75°F)
Over 31.75 to 203mm (1 1/4 to 8 in.)	80°C (175°F)

PRESSURE PIPING

<u>THICKNESS</u>	<u>MINIMUM SPECIFIED TENSILE STRENGTH, BASE METAL MPa (Ksi)</u>	<u>MINIMUM PREHEATING TEMPERATURE</u>
Less than 25.4mm (1.0 in.)	≤490 (71)	24°C (75°F)
Greater than 25.4mm (1.0 in.)	All	80°C (175°F)
All	>490 (71)	80°C (175°F)

POSTWELD HEAT TREATMENT

P-No.1 Groups 1, 2 & 3

Pressure Vessels in accordance with ASME BPVC Section VIII, Division I

1. All postweld heat treatment shall be done in accordance with ASME Boiler and Pressure Vessel Code, Section VIII, Division I, UW-40 & UCS-56, 1986 edition.
2. Postweld heat treatment temperatures and minimum holding times are as follows:

NOMINAL THICKNESS	HEAT TREATMENT TEMPERATURE		HOLDING TIME
	°C	(°F)	
Up to 50.8 mm (2.0 in.)	595	(1100) minimum	1 hr./25.4 mm (inch), 15 minutes minimum
Over 50.8 mm (2.0 in.)	595	(1100) minimum	2 hours plus 15 minutes for each additional 25.4 mm (inch) over 50.8 mm (2.0 in.)

Chemical Plant and Petroleum Refinery Piping in accordance with ANSI B31.3

1. All postweld heat treatment shall be done in accordance with Table 331.1.1 of ANSI B31.3-1984.
2. Postweld heat treatment temperatures and minimum holding times as follows:

NOMINAL THICKNESS	HEAT TREATMENT TEMPERATURE		HOLDING TIME
	°C	(°F)	
All	595 - 650	(1100 - 1200)	1 hour/25.4 mm (inch), 1 hour minimum

Power Piping in accordance with ANSI B31.1

1. All postweld heat treatments shall be done in accordance with Table 132 of ANSI B31.1-1983 edition.
2. Postweld heat treatment temperatures and minimum holding times are as follows:

NOMINAL THICKNESS	HEAT TREATMENT TEMPERATURE		HOLDING TIME
	°C	(°F)	
Up to 50.8 mm (2.0 in.)	595 - 650	(1100 - 1200)	1 hr./25 mm (inch), 15 minutes minimum
Over 50.8 mm (2.0 in.)	595 - 650	(1100 - 1200)	2 hr. plus 15 min. for each additional 25 mm (inch) over 50.8 mm (2.0 in.)

PROCEDURE QUALIFICATION RECORD

R.J.V. Gasfield Service Ltd., 4901 Bruce Rd., Box 295, Vegreville, Alberta T0B 4L0

PROCEDURE QUALIFICATION RECORD NUMBER 104A DATE June 1, 1984

WELDING PROCEDURE SPECIFICATION NUMBER 104 (Rev. 1)

WELDING PROCESS(ES) SMAW TYPES Manual

JOINTS (QW-402)

Type _____

BASE METALS (QW-403)

Material Spec. SA 516 Type or Grade Grade 70

P-No. 1 to P-No. 1 Thickness 25.4mm (1.0 in.)

Diameter _____ Other _____

FILLER METALS (QW-404)

SFA Specification 5.1

AWS Classification E6010, E7018

Filler Metal F-No. 3, 4

Weld Metal Analysis A-No. 1

Size of Filler Metal _____

Deposited Weld Metal Thickness No single pass with over 1/2" (12.7mm) of deposited metal

Other _____

SITUATION (QW-405)

Position of Groove 1G (Flat) Weld Progression _____

PREHEAT (QW-406)

Preheat Temp. 10°C (50°F) Interpass Temp. 260°C (500°F)

POSTWELD HEAT TREATMENT (QW-407)

Temperature 1150°F Time 1 hour

GAS (QW-408)

Type of Gas(es) N/A Composition of Mixtures _____

Other _____

ELECTRICAL CHARACTERISTICS (QW-409)

Current Direct Polarity Reverse

Amps 90-150 Volts 18-28

Other _____

TECHNIQUE (QW-410)

Travel Speed _____

Multipass or Single Pass (per side) Multipass

Single or Multiple Electrodes Single

String or Weave Bead Both

Other _____

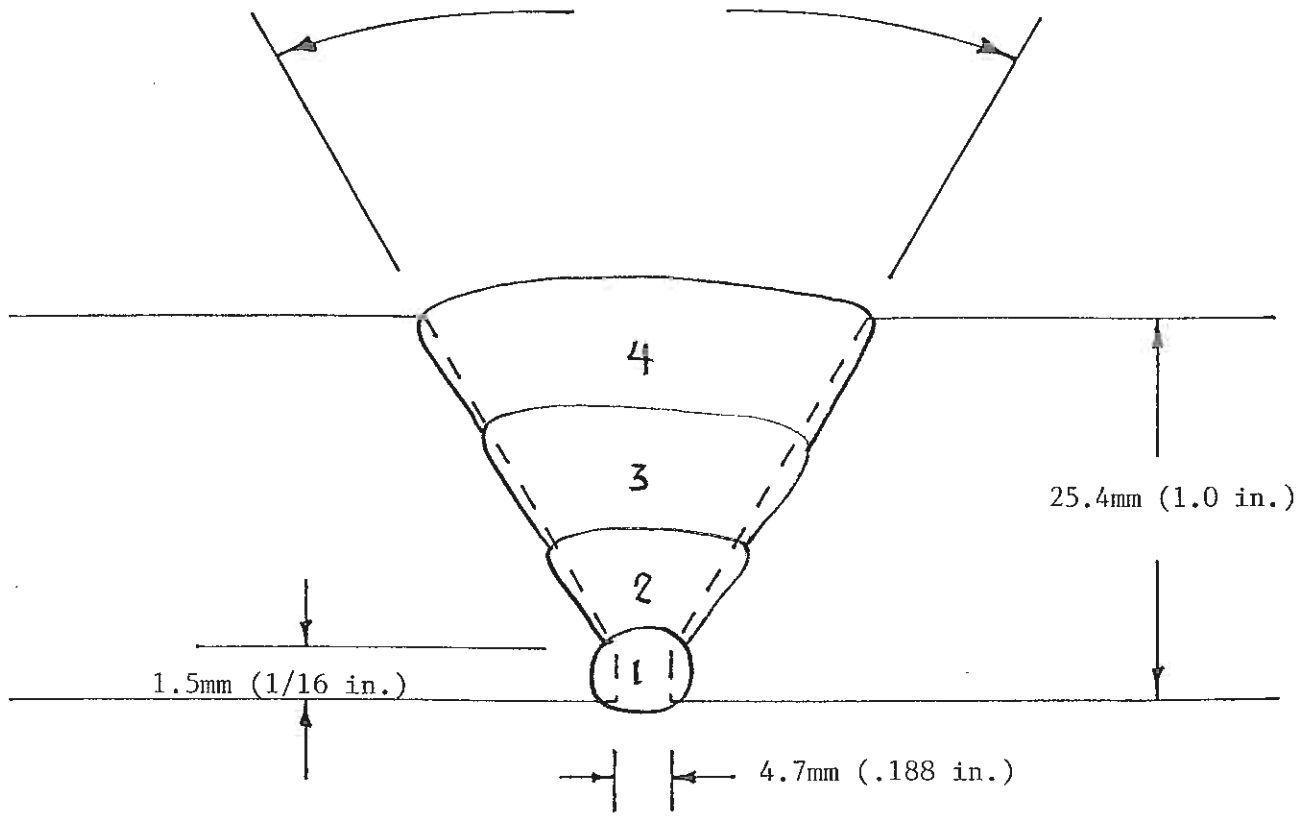

TENSILE TEST

Specimen Number	Width in.	Dia-meter in.	Area sq.in.	Ultimate Load lbs.	Ultimate Stress psi	Character & Location of Failure
2		0.502	0.198	14,000	70,700	Weld
5		0.505	0.200	14,100	70,400	Weld

GUIDED BEND TEST

Type and Figure Number	Result	Type and Figure Number	Result
Side bend as per QW 462.2a	All 4 passed		

Welder's Name Dale LaniukCertificate Number W-6537Tests Conducted by Hanson Materials Engineering (Western) Ltd.Per: Gilles Perreault, C.E.T.Laboratory Test Number E83-7-717

We certify that the statements in this record are correct and that the test welds were prepared, welded and tested in accordance with the requirements of Section IX of the ASME Boiler and Pressure Vessel Code.

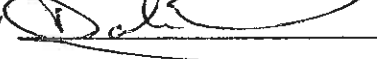
Signed R.J.V. Gasfield Service Ltd.Date June 14, 1983By 

PROCEDURE QUALIFICATION RECORD

B. J. V. Gasfield Service Ltd., 4901 - Bruce Rd., Box 295, Vegreville, Alberta T0B 4H0

PROCEDURE QUALIFICATION RECORD NUMBER 104-B DATE August 3, 1987

WELDING PROCEDURE SPECIFICATION NUMBER 104-(Rev. 1)

WELDING PROCESS(ES) SMAW TYPES Manual

JOINTS (QW-402)

Type Butt: single vee

BASE METALS (QW-403)

Material Spec. SA 516 Type or Grade Grade 70N

P-No. 1 Grp. 2 to P-No. 1 Grp. 2 Thickness 9.53mm (0.375 in.)

Diameter _____ Other _____

FILLER METALS (QW-404)

SFA Specification 5.1 5.1

AWS Classification E6010 E7018

Filler Metal F-No. 3 4

Weld Metal Analysis A-No. 1 1

Size of Filler Metal See attached sketch next page

Deposited Weld Metal Thickness F3: 2mm F4: 7.53mm

Other No single pass with over 1/2" (12.7mm) of deposited metal

POSITION (QW-405)

Position of Groove 1G Weld Progression _____

PREHEAT (QW-406)

Preheat Temp. 20°C (70°F) Interpass Temp. Weld build up

POSTWELD HEAT TREATMENT (QW-407)

Temperature 607°C (1125°F) Time 90 minutes

GAS (QW-408)

Type of Gas(es) N/A Composition of Mixtures _____

Other _____

ELECTRICAL CHARACTERISTICS(QW-409)

Current Direct Polarity Reverse

Amps See attached sketch Volts _____

Other _____

TECHNIQUE (QW-410)

Travel Speed _____

Multipass or Single Pass (per side) F3: Single; F4: Multiple

Single or Multiple Electrodes Single

String or Weave Bead Both

Other _____

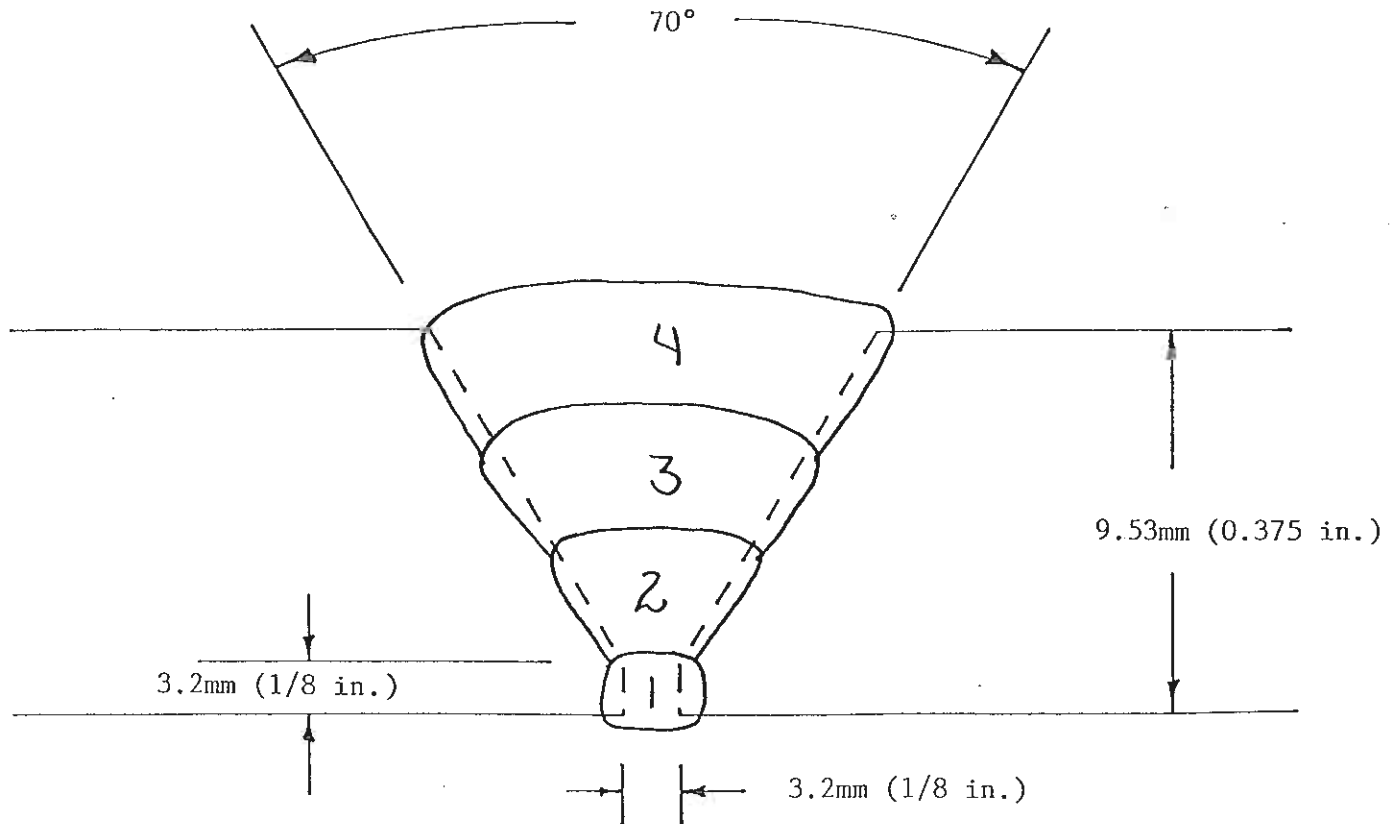

- Pass #1: 3.2mm (1/8 in.), E6010, DCRP, 90-120 amps, 24-28 volts.
Pass #2: 4.0mm (5/32 in.), E7018, DCRP, 180-210 amps, 24-26 volts.
Pass #3: 5.0mm (3/16 in.), E7018, DCRP, 240-280 amps, 24-28 volts.
Pass #4: 6.0mm (1/4 in.), E7018, DCRP, 340-380 amps,

TENSILE TEST

Specimen Number	Width mm (in.)	Thick. mm (in.)	Area sq.mm (sq.in.)	Ultimate Load N (lbs.)	Ultimate Stress MPa (psi)	Character & Location of Failure
T-1	38.55	8.80	339	179,600	530	Partial cup & cone
	(1.52)	(.346)	(.526)	(40,400)	(76,800)	Weld metal
T-2	38.4	9.00	346	182,100	527	Partial cup & cone
	(1.51)	(.354)	(.536)	(41,000)	(76,400)	Weld metal

GUIDED BEND TEST

Type and Figure Number	Result	Type and Figure Number	Result
Side S-1	Pass	Side S-3	Pass
Side S-2	Pass	Side S-4	Pass

Welder's Name Ernie BullockCertificate Number W-9101Tests Conducted by Ludwig's Welding Consulting Ltd.Per: V. Lukey, C.E.T.Laboratory Test Number LWC-9702-816E

We certify that the statements in this record are correct and that the test welds were prepared, welded and tested in accordance with the requirements of Section IX of the ASME Boiler and Pressure Vessel Code.

Signed R.J.V. Gasfield Service Ltd.Date September 24, 1987By 